

专注真空镀膜机械&UV涂装流水线制造  
FOCUS ON VACUUM MACHINE & UV SPRAY LINE

## 江苏驰诚真空科技有限公司 JIANGSU CICEL VACUUM TECHNOLOGY CO., LTD.

江苏省南通市通州湾示范区江新路16号  
No.16, Jiangxin Road, Tongzhou Bay Demonstration Area, Nantong City, Jiangsu Province, China.  
0086-513-81907983 001@ccvacuum.com  
0086-513-81907983 Skype : cicel.1

国内销售部Domestic sales Dept:  
TEL:0513-81907983  
FAX: 0513-81907983  
Skype: ccvacuum  
Email: 001@ccvacuum.com

国际销售部International sales Dept:  
TEL:0086-513-81907283  
FAX: 0086-513-81907283  
Skype: cicel.1  
Email: export-a1@ccvacuum.com

售后服务部 After-sale Dept:  
免费24H热线: 400-882-5225  
TEL:0513-81907713  
FAX:0513-81907713  
Email: aftersale@ccvacuum.com

本图册数据、图片资料所有权归驰诚真空设备有限公司所有，如有翻录必将追究法律责任  
The album data, image data ownership of CICEL VACUUM MACHINE CO.,LTD, such as ripping will pursue legal responsibility

# CICEL 驰诚真空

新一代PVD真空涂层设备全球供应商  
Global supplier of new generation PVD vacuum coating solution

## 企业产品手册 PRODUCTS BROCHURE

站的更高/看的更远 Stand tall/see farther

驰诚有足够的信心、实力和执行力，走得更高！飞得更高！  
We have enough confidence, strength and execution, go farther! Fly high!



专业生产制造 真空镀膜设备

不断拓展的企业格局，不断壮大的商业伙伴，让发展蓝图步步成真  
Unceasingly expanded enterprise layout and continuously growing business partners make the development blueprint become true step by step.

22年  
见证驰诚公司22年  
2003-2025  
www.ccvacuum.com

## COMPANY HISTORY

我们的历程

驰诚公司创立于2003年，至今我们的团队已经走过22个年华。

22年中我们不遗余力，

22年中我们一丝不苟，

22年中我们风雨兼程，

22年中我们不敢一丝懈怠，

今天我们用创新的技术，规范流程，先进的理念，始终为客户提供优秀的真空镀膜设备与UV涂装生产线。

CICEL company was founded in 2003, we have passed 22 years.

We try our best effort all the time for our customer,

We are meticulous at our jobs all the time,

We focus on Research and development of our machine,

Today we adopt our Innovative technology and advanced ideas to make the best vacuum machine for our clients.

**cicel**  
驰诚真空



## 关于驰诚

### 新一代PVD真空涂层设备全球化供应商

驰诚创立于2003年，是一家致力于PVD真空镀膜设备和UV涂装设备研发制造的机械工程技术供应商，为客户提供全面的涂层解决方案。长久以来，驰诚凭借出色的产品创新能力和完善的售后服务体系，已为全球超过50个国家的客户提供了高度可靠的真空涂层技术解决方案。

真空涂层技术应用无处不在，驰诚集中服务于各类装饰性镀膜行业客户和功能性涂层行业客户。驰诚坚持认为用最合适的定制化的涂层方案匹配客户的明确需求，方能为客户创造巨大的价值。

技术的研发和创新是公司的核心竞争力，驰诚公司应用本身先进的技术力量与国内知名院校专业进行联合研发，共同建立了多个研发实验室，同时在核心技术领域获得了多项国家发明专利。

作为一家行业领先的公司，驰诚将持续致力于真空涂层专业，致力于为客户提供高可靠性的镀膜解决方案，让真空涂层技术绽放更加璀璨的创新之光，效益之光！

专注真空镀膜机械  
UV涂装流水线制造 03  
[www.ccvacuum.com](http://www.ccvacuum.com)

## ABOUT CICEL

### Global supplier of new generation PVD vacuum coating solution

Founded in 2003, CICEL is a mechanical engineering technology supplier dedicated to the R&D and manufacturing of PVD vacuum coating equipment and UV coating equipment, providing customers with comprehensive and reasonable coating solutions. For a long time, CICEL has provided highly reliable vacuum coating technology solutions to customers in more than 50 countries around the world with its excellent product innovation capabilities and complete after-sales service system.

Vacuum coating technology is used everywhere, and CICEL focuses on serving customers in various decorative coating industries and functional coating industries. CICEL insists that only by matching customers' clear needs with the most suitable customized coating solutions can create huge value for customers.

Technology R&D and innovation are the company's core competitiveness. CICEL uses its advanced technical strength to conduct joint research and development with well-known domestic universities, jointly established multiple R&D laboratories, and has obtained multiple national Patents in core technology fields.

As a PVD-leading company, CICEL will continue to be committed to the vacuum coating profession, and is committed to providing customers with high-reliability coating solutions.

FOCUS ON VACUUM COATER  
& UV SPRAY LINE 04  
[www.ccvacuum.com](http://www.ccvacuum.com)

## 专注做好每件事，创新未来发展。

落后就要被淘汰，不优秀就要被出局，生活就是这么残酷的，竞争就是这么激烈的，让员工懂得珍惜时间，才能让企业立足于不败之地。

驰诚公司汇聚了业内优秀精英，重视高技术人才的引进和内部员工的培养，在人才选拔方面，坚持以先进的人力资源管理理念为指导，努力创造优秀人才脱颖而出的环境。在人才的激励方面，坚持以成长激励为主，努力为各类人才创造自己才华优势的良好环境。

Cicel company brings together the industry elite, pay attention to the introduction of high-tech talent and internal staff training, In selecting talents, adhere to the advanced human resources management concept as a guide, try our best to create an environment of talents to stand out.

In terms of talent incentive, adhere to growth incentive, for all kinds of talents to create a sound environment for showing their talents.

[www.ccvacuum.com](http://www.ccvacuum.com)

## OUR TEAM 我们的团队

驰诚拥有一批具有资深真空设备研发经验的工程技术精英，研发部门4位伙伴，国内销售部门6位伙伴，国际销售部门4位伙伴，设备生产部门45位伙伴，售后服务团队8位伙伴，行政事业部门4位伙伴。

Our company has a group of research staffs who have many years research and development experience of vacuum industry, R & D department four partners, domestic sales department six partners, international sales department four partners, equipment production sector 45 partners, service team eight partners, the administrative department of four partners.



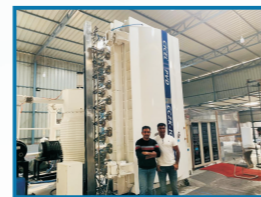

## HIGH QUALITY 驰诚品质

## GLOBAL CUSTOMERS 服务全球

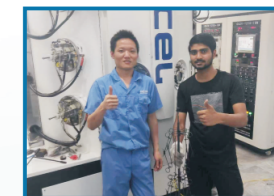

# ORGANIZATION

## 组织架构

企业会拥有一个什么样的未来，取决于我们拥有一个什么样的团队，也就会拥有什么样的天下！

“责任为重、诚信为本、稳健经营、科学管理、高效协调”成为驰诚人的执着追求，  
驰诚人开放前瞻的广阔胸怀，势必预示着一一种非凡天下的收揽！

The enterprise's future depends on the team we have. A unity and efficient team means great power!

Cicelnese pursue the Responsible, honest, scientific management, and efficient coordination idea all the time .

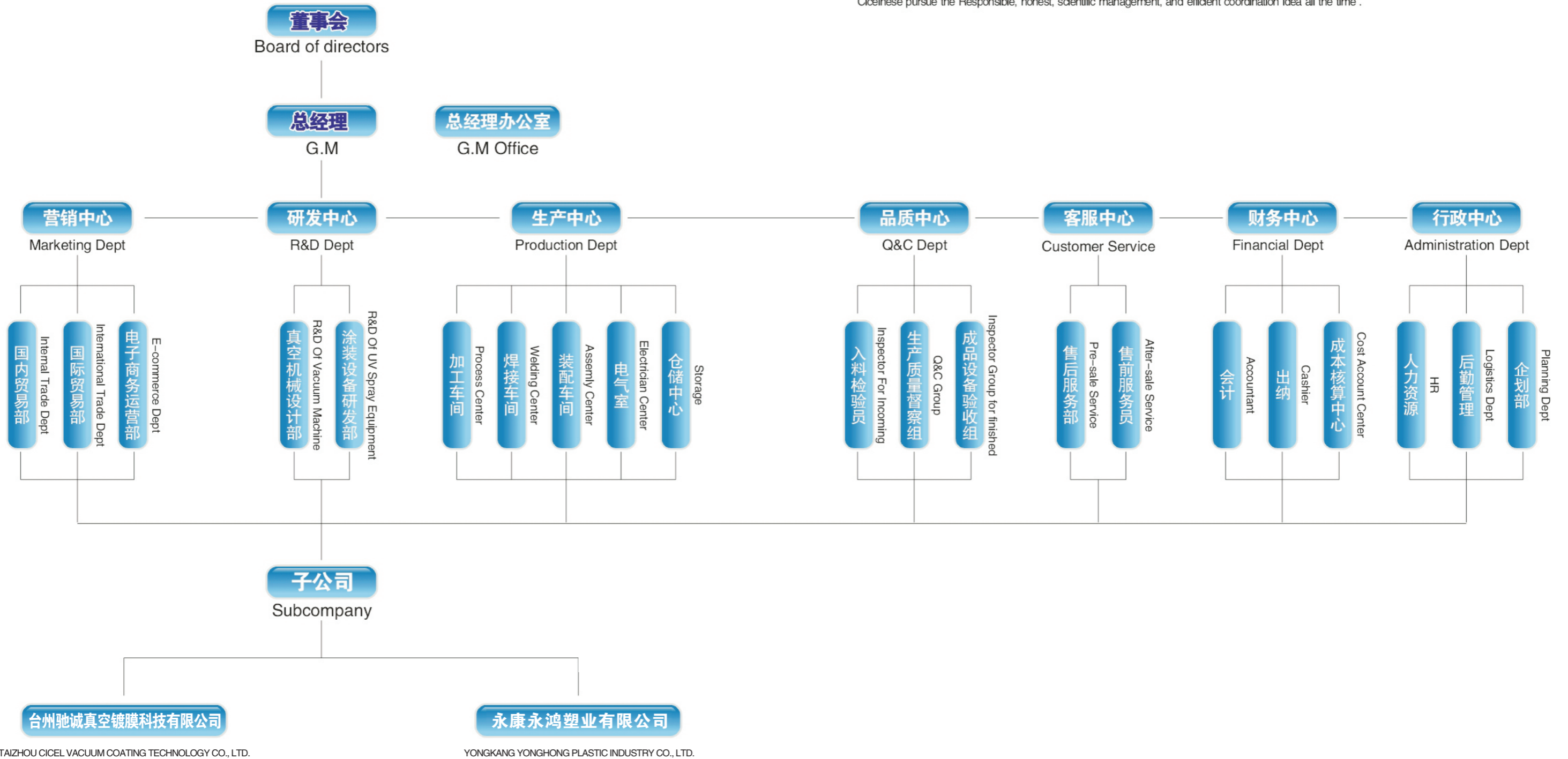



# CCZK-EL蒸发镀膜设备

CCZK-EL EVAPORATION VACUUM COATING MACHINE



>驰诚立式双开门真空蒸发镀膜设备<  
CICEL Vertical double doors evaporation vacuum coating machine



>驰诚箱式玻璃真空镀膜机<  
CICEL Box-type glass vacuum coating machine



## FEATURE DESCRIPTION

特点叙述

- 使用驰诚创新研发的CCZK-EL自动蒸发镀膜设备意味着低操作成本，可靠的稳定性能，以及拥有一台高度人性化的镀膜设备。
- 采用立式双开门设计，大幅提高生产效率，镀膜膜层拥有优秀的致密性和附着力。
- 合理配备的真空泵抽系统，保障设备的长效使用周期以及稳定的抽速。
- 实现PLC智能全自动控制，配合HMI人机触控界面，让不懂设备的你同样无忧于操作。
- 采用驰诚创新工艺制造，精益求精，全面通过欧盟CE和ISO国际质量管理体系认证。
- CICEL CCZK-EL series automatic evaporation coating machine with stable and reliable performance ,can lower operating cost, and customer also owned one highly humanization coating machine.
- CICEL CCZK-EL serial vertical vacuum evaporation coating machine is especially design for coating aluminum/chrome on the surface of plastic & glass substrate.It is the vaporization of a material by heating to a temperature such that the vapor pressure becomes appreciable and atoms or molecules are lost from the surface in a vacuum,and deposited on the surface of products surface.
- Fast deposition speed and high production efficiency ,coated film with excellent brightness and well adhesion.
- Every cycle time can be finish within 7 minutes even using for long time.
- Intelligent automatic control, easy to operate the machine without any experience.
- Environment friendly,no waste water and gas.
- Manufacturing by Cical latest technology, also approved CE and ISO international quality management system certification.

## APPLICATION

应用范围

- 驰诚CCZK-EL蒸发设备主要用于塑料金属等制品表面的蒸镀金属或化合物膜层（如铝、铬、镍等）可适用于反光碗、ABS塑料、亚克力钻、树脂钻、镀底、工艺品、灯具、鞋材、手机壳、化妆外壳瓶盖、玩具、圣诞礼品等行业。
- CICEL CCZK-EL series evaporation vacuum coating machine is especially design for coating aluminum/chrome on the surface of plastic substrate. Widely used in automotive headlight, audio and various small appliances, computers, clocks , watches, toys cell phones, reflective cup, cosmetics caps, nylon, metal, glass, ceramics ,Christmas gifts, etc.



# CCZK-EW卧式蒸发镀膜设备

CCZK-EW HORIZONTAL EVAPORATION COATING MACHINE

## TECHNICAL CONFIGURATION

技术配置

- 腔体结构：采用立式双开门，后置真空获得系统。
- 电源类型：配置电阻蒸发电源、离子轰击电源、可控硅电源。
- 材质用料：严选采用优质碳钢或不锈钢材质。
- 泵抽系统：装备扩散泵或分子泵+罗茨泵+机械泵+维持泵（配置可选深冷泵）。
- 冷却系统：水循环冷却方式，另需配冷却水塔或工业冷水机。
- 转动系统：公自转结合，变频调节。
- 智能控制：PLC智能控制+HMI全彩人机触控界面，实现全自动控制。
- 报警及保护：异常情况报警，并执行相应保护措施。
- 其他技术参数：  
 极限真空：5.0X10<sup>-4</sup>Pa  
 抽气速率：5.0\*10<sup>2</sup> ≤ 5min  
 水压流速 ≥ 0.2Mpa 3m<sup>3</sup>/h；水温 ≤ 25℃；气压：0.4-0.8Mpa

- Vacuum chamber: All of our vacuum coating machine can be customized according to customer requirements, we also offer OEM service.
- Vacuum chamber structure: adopts vertical double door, postpositional vacuum acquisition system.
- Power type: equipped with resistance evaporation power, ion bombardment power, SCR power.
- Vacuum chamber material: adopts high quality carbon steel or stainless steel.
- Vacuum system: Diffusion pump or molecular pump+Roots pump +Mechanical pump + Rotary vane pump(Cryogenic pump can be optional).
- Cooling system: water circulation cooling mode, need to equip cooling water tower or industrial water cooler.
- Rotating system: 6 axis/8 axis planetary rotation and revolution ,frequency control (controllable adjustable).
- Intelligent Control: we adopt reliable Mitsubishi PLC control system, automatic / semi-automatic / manual colorful touch screen control.
- Alarm and protection: alarm for lack of water, over voltage, circuit breakers and other abnormalities situation, with the function of electric interlock.  
 Ultimate vacuum: 5\*10<sup>-4</sup>pa  
 Pump time: 5\*10<sup>2</sup>pa ≤ 5mins  
 Water pressure ≥ 0.2Mpa 3m<sup>3</sup>/h; water temperature ≤ 25℃; gas pressure: 0.4-0.8Mpa

### 驰诚CCZK-EL蒸发镀膜设备常用规格表

CICEL CCZK-EL evaporation vacuum coater

D1000mm*	D1400mm*	D1200mm*	D1800mm*	D2000mm*
H1200mm	H1600mm	H1500mm	H2000mm	H2200mm
规格均可定制 Specifications can be customized				

#### 备注REMARKS:

- 真空室尺寸或设备配置可按客户产品及特殊工艺要求订做  
 Vacuum chamber size and configuration can be customized in accordance with customer's special requirements for products and processes
- 更多应用请咨询工程技术人员：More application details please consult CICEL engineer



>驰诚卧式真空蒸发镀膜设备<  
CICEL Horizontal evaporation vacuum coating machine



>驰诚卧式真空蒸发镀膜设备<  
CICEL Horizontal vacuum coater

# FEATURE DESCRIPTION

特点叙述

- 驰诚CCZK-EW卧式蒸发真空镀膜设备采用单腔体或多腔体设计，满足客户不同产量需求。
- 创新设计的滚镀系统，提供贴心人性化的夹具系统设计。
- AB镀膜完整工艺设计，实现蒸发镀铝，蒸发镀彩腔体内一次性完成。
- 实现智能逻辑自动控制，让不懂设备的你同样无忧于操作。
- 采用驰诚创新工艺制造，精益求精，全面通过欧盟CE和ISO国际质量管理体系认证。
- CICEL CCZK-EW series horizontal resistance evaporation coating machine is especially design for plating metal film on the surface of plastic, ceramic and other substrate materials, can improve product's quality and looks more beautiful. Mainly use to coat rainbow film, decorative film etc.
- Barrel plating is available, high output and excellent qualified product.
- Fast deposition speed and high production efficiency, coating film with excellent brightness and well adhesion.
- Intelligent automatic control, workers can easy to operate the machine without any experience.
- Environment friendly, no waste water and gas.
- Manufacturing by Cicel latest technology, also approved CE and ISO international quality management system certification.

# APPLICATION

应用范围

- 驰诚专业CCZK-EW卧式蒸发设备可用于滚镀镀膜，AB彩色，七彩，同时可以蒸镀各种金属丝或化合物膜层铝。广泛运用于头盔、烫钻、工艺品、首饰、玩具、圣诞礼品等行业。
- CICEL CCZK-EL series horizontal evaporation vacuum coating machine is especially design for barrel plating coating rainbow color, AB color on the surface of plastic substrate, also can evaporate aluminum, chrome filament, SiO<sub>2</sub> and so on. Widely used in automotive headlight, computers parts, clocks and watches, toys, cell phones, reflective cup, cosmetics caps, ABS, PS, PC, PVC, TPU, nylon, metal, glass, ceramics, Christmas gifts, etc.



# TECHNICAL CONFIGURATION

技术配置

- 腔体结构：采用卧式前开门，侧置真空获得系统。
- 电源类型：配置电阻蒸发电源、离子轰击电源、可控硅电源。
- 材质用料：严选采用优质碳钢或不锈钢材质。
- 泵抽系统：装备扩散泵或分子泵+罗茨泵+机械泵+维持泵（配置可选深冷泵）。
- 冷却系统：水循环冷却方式，另需配冷却塔或工业冷水机。
- 转动系统：可依据需求选配选滚镀系统夹具，公自转结合，变频调节。
- 智能控制：PLC智能控制+HMI全彩人机触控界面，实现逻辑全自动控制。
- 报警及保护：异常情况进行报警，并执行相应保护措施。
- 其他技术参数：
  - 极限真空：5.0X10<sup>-4</sup>Pa
  - 抽气速率：5.0\*10<sup>2</sup> ≤ 5min
  - 水压流速 ≥ 0.2Mpa 3m<sup>3</sup>/h；水温 ≤ 25℃；气压：0.4-0.8Mpa
- Vacuum chamber: All of our vacuum coating machine can be customized according to customer requirements, we also offer OEM service.
- Vacuum chamber structure: adopts horizontal front door, postpositional vacuum acquisition system.
- Vacuum chamber material: adopts high quality carbon steel or stainless steel.
- Vacuum system: Diffusion pump or molecular pump +Roots pump +Mechanical pump + Rotary vane pump(Cryogenic pump is optional).
- Cooling system: water circulation cooling mode, cooling water tower .
- Rotating system: 6 axis/8 axis planetary rotation and revolution, horizontal barrel plating, frequency control (controllable adjustable).
- Intelligent Control: we adopt PLC control system, automatic / semi-automatic / manual colorful touch screen control.
- Alarm and protection: alarm for lack of water, over voltage, circuit breakers and other abnormalities situation, with the function of electric interlock.
  - Ultimate vacuum: 5X10<sup>-4</sup>pa
  - Pump time: 5\*10<sup>2</sup>pa ≤ 5mins
  - Water pressure ≥ 0.2Mpa 3m<sup>3</sup>/h; water temperature ≤ 25℃; gas pressure: 0.4-0.8Mpa

## 驰诚CCZK-EW卧式蒸发镀膜设备常用规格表 CICEL CCZK-EW horizontal evaporation vacuum coater

D1000mm*	D1400mm*	D1200mm*	D1800mm*	D2000mm*
H1200mm	H1600mm	H1500mm	H2000mm	H2200mm
规格均可定制 Specifications can be customized				

### 备注REMARKS:

- 真空室尺寸或设备配置可按客户产品及特殊工艺要求订做  
Vacuum chamber size and configuration can be customized in accordance with customer's special requirements for products and processes
- 更多应用请咨询工程技术人员：More application details please consult CICEL engineer

# CCZK-ION-L大型多弧离子镀膜设备

CCZK-ION MULTI-ARC ION COATING MACHINE

## TECHNICAL CONFIGURATION

技术配置



>驰诚大型多弧离子真空镀膜设备（不锈钢镀钛设备）<  
CICEL Multi-arc ion vacuum coating equipment (for coating big size)



## FEATURE DESCRIPTION

特点叙述

- 驰诚大型多弧离子镀钛设备创新采用立式前开门的设计，优秀的机械门轴设计和转架定制为您大型工件的离子镀膜提供极为便利的操作。同时可以获得优异性能的膜层。
- 全SUS304优质不锈钢机身，隐藏式双层冷却水套设计。
- 合理配备多套最新研制的离子弧源，有效保障弧源溅射的稳定性与均匀性。
- 采用先进的多路进气系统，精准控制气体流量，满足您多种化合物膜层需求。
- 装载大功率脉冲偏压电源，极大提高电粒子能量，从而获得优秀的膜层结合力和光洁度。
- 采用驰诚创新工艺制造，精益求精，全面通过欧盟CE和ISO国际质量管理体系认证。
- CCZK-ION Multi-arc ion coater adopts the design of vertical front door, the best door spindle and rotation system can give the most convenient operating experience and beautiful layer such as TIN,TIO2
- Adopts SUS304 stainless steel material,hidden cooling water jacket,well grinding and beautiful appearance
- Equipped with multiple sets of newly developed multi-arc ion source,make sure ion sputtering are more uniform, pure and solid every time.
- Adopts advanced multi-way air intake system,precise control of gas flow,meet the needs of compounds film coating
- Loading unipolar pulsed bias power supply,greatly improve the charged particles energy and achieve excellent film adhesion and finish.
- Newly developed intelligent PLC program and HMI,to make coating operations becomes more quickly and easily

- 腔体结构：立式前开门，卧式前开门，后置真空获得系统。
- 材质用料：腔体采用优质SUS304不锈钢材质。
- 离子弧源：依据设备大小不同配备多套弧源系统。
- 偏压电源：配备大功率单级脉冲偏压电源。
- 多弧靶材：标配多套钛靶或不锈钢靶材。
- 转动系统：变频调速，公自转结合，可采用上传动或下传动方式。
- 真空系统：扩散泵（可选分子泵）+罗茨泵+机械泵+维持泵+深冷系统（可选）。
- 气体控制：多路气体质量流量控制系统。
- 加热系统：全新铠装加热装置，350℃PID可调温控。
- 智能控制：PLC智能控制+HMI全彩人机触控界面，实现逻辑全自动控制。
- 报警及保护：异常情况进行报警，并执行相应保护措施。
- 其他技术参数：

极限真空： $5.0 \times 10^{-4}$  Pa

抽气速率： $5.0 \times 10^{-2} \leq 5$  min

水压流速： $\geq 0.2$  Mpa  $3\text{m}^3/\text{h}$ ；水温： $\leq 25^\circ\text{C}$ ；气压：0.4-0.8 Mpa

- Chamber structure: vertical front door structure, rear vacuum system, material for vacuum chamber adopts high quality SUS304 stainless steel
- Arc source: equipped with multiple sets multi-arc power according to the size of machine
- Multi-Arc target: equipped with multiple sets of titanium or stainless steel target as standard configuration
- Rotating system: Planetary rotation and revolution ,frequency control
- Vacuum system: Diffusion pump (molecular pump is optional)+Roots pump +Mechanical pump + Rotary vane pump (cryogenic pump is optional)
- Gas control: multi way sevenstar mass flow controller
- Bias Power Supply: Single-stage pulse bias power supply
- Heating system: Controllable and adjustable from room temperature to  $350^\circ\text{C}$  (PID temperature control)
- Control mode: manual operation +semiautomatic + automatic integration / touch screen HMI + PLC
- Ultimate vacuum: $5 \times 10^{-4}$  pa
- Pump time: $5 \times 10^{-2}$  pa $\leq 5$  mins
- Water pressure  $\geq 0.2$  Mpa  $3\text{m}^3/\text{h}$ ; water temperature  $\leq 25^\circ\text{C}$ ; gas pressure: 0.4-0.8 Mpa

# APPLICATION

应用范围

- 驰诚CCZK-ION大型多弧离子镀膜设备可以在金属, 玻璃, 陶瓷等材料表面进行镀膜。驰诚大型离子镀膜设备广泛适用于不锈钢展架, 不锈钢散件, 不锈钢门窗, 水暖五金, 玻璃水晶装饰品、玻璃管等装饰性镀膜, 可获得高附着力和亮度的钛金, 玫瑰金, 香槟金, IP黑, 离子银等各种颜色效果。常用膜系包括TiN、ZrN、TiAlN、TiC、TiCN、CrN、Al<sub>2</sub>O<sub>3</sub>等。
- CICEL CCZK-ION vacuum multi-arc ion coating machine can coat film on the surface of metal, ceramic and other material substrate. It is widely use in coating stainless steel display rack, handles, plumbing hardware etc, the best choice to replace traditional electro plating. The main coated film such as: ions of gold, silver, titanium nitride, titanium carbide, zirconium nitride, titanium aluminum, chromium nitride and other functional metal film, the products coated by ion coating machine can improve hardness, wear resistance, anti-corrosion and looks more beautiful.



## 驰诚CCZK-ION-L大型多弧离子镀膜设备常用规格表

CICEL CCZK-ION multi-arc ion vacuum coater

D2000mm*	D2200mm*
H4000mm	H4500mm
规格均可定制 Specifications can be customized	

### 备注REMARKS:

- 真空室尺寸或设备配置可按客户产品及特殊工艺要求订做  
Vacuum chamber size and configuration can be customized in accordance with customer's special requirements for products and processes
- 更多应用请咨询驰诚销售工程师: More application details please consult CICEL sales engineer

# CCZK-ION多弧离子磁控溅射复合镀膜设备

CCZK-ION Multi arc ion magnetron sputtering composite coating equipment

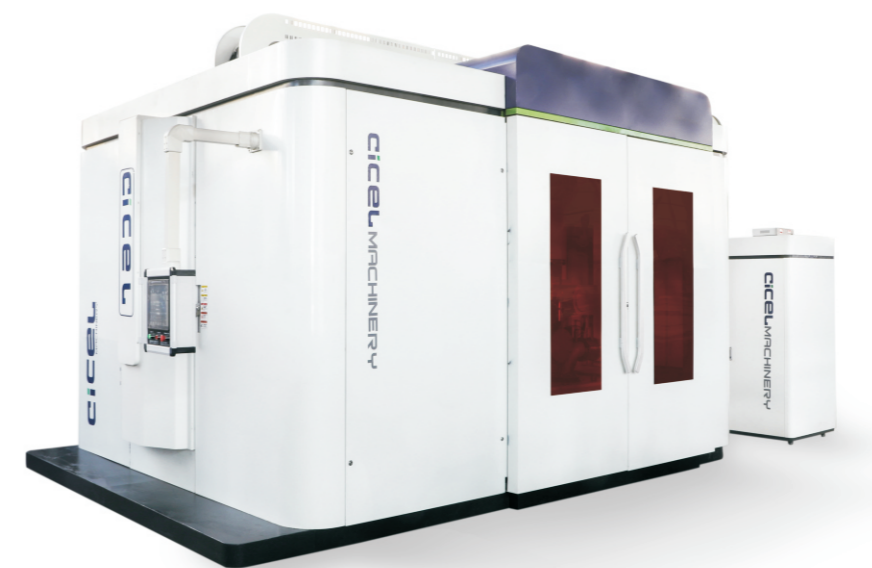

> 驰诚多弧离子磁控溅射复合镀膜设备 <  
CICEL Multi arc ion magnetron sputtering composite coating equipment



> 驰诚多弧离子镀膜 <  
CICEL multi-arc ion coating

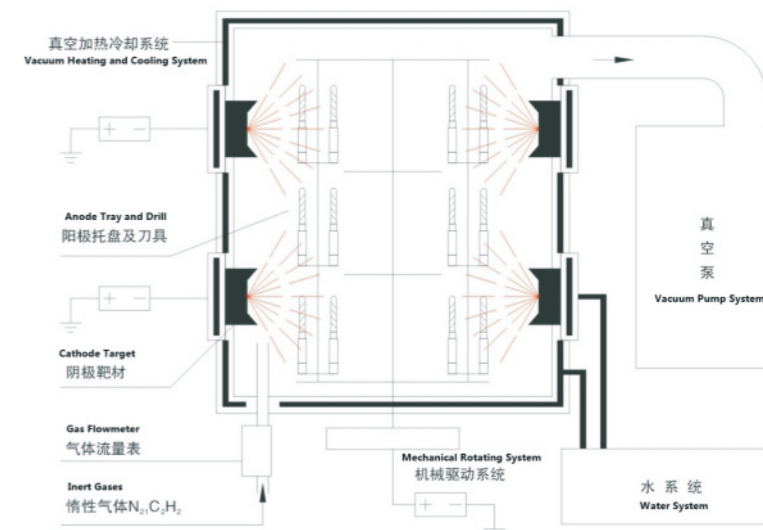

> 驰诚多弧离子工具镀膜系统 <  
CICEL multi-arc ion coating system (for tools coating)

# FEATURE DESCRIPTION

特点叙述

- 驰诚CCZK-ION多弧离子镀是在真空蒸发镀和溅射镀膜的基础上发展起来的一种镀膜技术，将各种气体放电方式引入到气相沉积领域，整个气相沉积过程都是在等离子体中进行的。
- 全SUS304优质不锈钢机身，隐藏式双层冷却水套设计。
- 合理配备多套最新研制的离子弧源，有效保障弧源溅射的稳定性与均匀性。
- 采用先进的多路进气系统，精准控制气体流量，满足您多种化合物膜层需求。
- 装载大功率脉冲偏压电源，极大提高电粒子能量，从而获得优秀的膜层结合力和光洁度。
- 采用驰诚创新工艺制造，精益求精，全面通过欧盟CE和ISO国际质量管理体系认证。
- Adopts SUS304 stainless steel material, hidden cooling water jacket, well grinding and beautiful appearance
- Equipped with multiple sets of newly developed multi-arc ion source, make sure ion sputtering are more uniform, pure and solid every time.
- Adopts advanced multi-way air intake system, precise control of gas flow, meet the needs of compounds film coating
- Loading unipolar pulsed bias power supply, greatly improve the charged particles energy and achieve excellent film adhesion and finish.
- Newly developed intelligent PLC program and HMI, to make coating operations becomes more quickly and easily

# APPLICATION

应用范围

利用驰诚CCZK-ION离子镀设备可以在金属，玻璃，陶瓷等材料表面进行镀膜。

1. 普通装饰镀膜设备广泛适用于不锈钢展架，不锈钢散件，门花，花洒，把手，水暖五金、钟表、洁具、餐具、水龙头、金属饮水机、手机金属壳、玻璃水晶装饰品、玻璃管等镀膜。
  2. 超硬质工具镀膜设备可应用于钻头，丝锥，高速刀片，耐磨轴承等功能镀膜，可以大大提高产品使用寿命和使用效率。
  3. 常用膜系包括TiN、ZrN、TiAlN、TiC、TiCN、CrN、Al2O3等。
1. Common decorative coating equipment is widely used in stainless steel frames, stainless steel parts, handles, plumbing hardware, watches and clocks, sanitary ware, tableware, taps, metal, depending on her mobile phone metal shell, glass, crystal ornaments, glass coating, etc.
  2. Superhard tools coating equipment can be applied to drill, tap, high speed blade, product service life and efficiency will be improved greatly after coating
  3. general film: TiN, ZrN, TiAlN, TiC, TiCN, CrN, Al2O3 etc.



# TECHNICAL CONFIGURATION

技术配置

- 腔体结构: 立式前开门, 卧式前开门, 后置真空获得系统。
- 材质用料: 腔体采用优质SUS304不锈钢材质。
- 离子弧源: 依据设备大小不同配备多套弧源系统。
- 偏压电源: 配备大功率单级脉冲偏压电源。
- 多弧靶材: 标配多套钛靶或不锈钢靶材。
- 转动系统: 变频调速, 公自转结合, 可采用上传动或下传动方式。
- 真空系统 (装饰镀膜设备Decorative coating): 扩散泵 (可选分子泵) + 罗茨泵+机械泵+维持泵+深冷系统 (可选)。
- 真空系统 (超硬质工具镀膜Tooling coating): 分子泵+罗茨泵+直联泵 (进口) +维持泵+可选深冷泵。
- 气体控制: 多路气体质量流量控制系统。
- 加热系统: 装饰镀膜350℃温控PID可调可控制, 超硬质工具镀膜550℃温控PID可调可控制。
- 智能控制: PLC智能控制+HMI全彩人机触控界面, 实现逻辑全自动控制。
- 报警及保护: 异常情况进行报警, 并执行相应保护措施。
- 其他技术参数:
  - 极限真空:  $5.0 \times 10^{-4}$  Pa
  - 抽气速率:  $5.0 \times 10^{-2} \leq 5$  min
  - 水压流速  $\geq 0.2$  Mpa  $3 \text{ m}^3/\text{h}$ ; 水温  $\leq 25^\circ\text{C}$ ; 气压: 0.4-0.8 Mpa
- Chamber structure: vertical front door structure, rear vacuum system, material for vacuum chamber adopts high quality SUS304 stainless steel
- Arc source: equipped with multiple sets multi-arc power according to the size of machine
- Multi-Arc target: equipped with multiple sets of titanium or stainless steel target as standard configuration
- Rotating system: Planetary rotation and revolution, frequency control
- Vacuum system: Diffusion pump (molecular pump is optional) + Roots pump + Mechanical pump + Rotary vane pump (cryogenic pump is optional)
- Vacuum system: molecular pump + Roots pump + monoblock pump (korea) + Rotary vane pump + cryogenic pump is optional
- Gas control: multi way sevenstar mass flow controller
- Bias Power Supply: Single-stage pulse bias power supply
- Heating system: Controllable and adjustable from room temperature to  $600^\circ\text{C}$  (PID temperature control)
- Control mode: manual operation + semiautomatic + automatic integration / touch screen HMI + PLC
- Ultimate vacuum:  $5 \times 10^{-4}$  pa
- Pump time:  $5 \times 10^{-2}$  pa  $\leq 5$  mins
- Water pressure  $\geq 0.2$  Mpa  $3 \text{ m}^3/\text{h}$ ; water temperature  $\leq 25^\circ\text{C}$ ; gas pressure: 0.4-0.8 Mpa

## 驰诚CCZK-ION多弧离子镀膜设备常用规格表 CICEL CCZK-ION multi-arc ion vacuum coater

多弧离子镀膜设备 (装饰镀膜用) Multi arc ion coater (for Decorative coating)			多弧离子镀膜设备 (超硬质工具镀膜用) Multi arc ion coater (for Tooling coating)	
D1300mm*	D1600mm*	D2000mm	D1000mm*	D900mm*
H1500mm	H2000mm		H1000mm	H1200mm
规格均可定制 Specifications can be customized				

### 备注REMARKS:

- 真空室尺寸或设备配置可按客户产品及特殊工艺要求订做  
Vacuum chamber size and configuration can be customized in accordance with customer's special requirements for products and processes
- 更多应用请咨询驰诚销售工程师: More application details please consult CICEL sales engineer

# CCZK-OGS光学电子枪镀膜设备

## CCZK-OGS ELECTRON BEAM OPTICAL COATING MACHINE



> 驰诚光学电子枪镀膜设备 <  
CICEL Optical vacuum coating machine(electron gun)

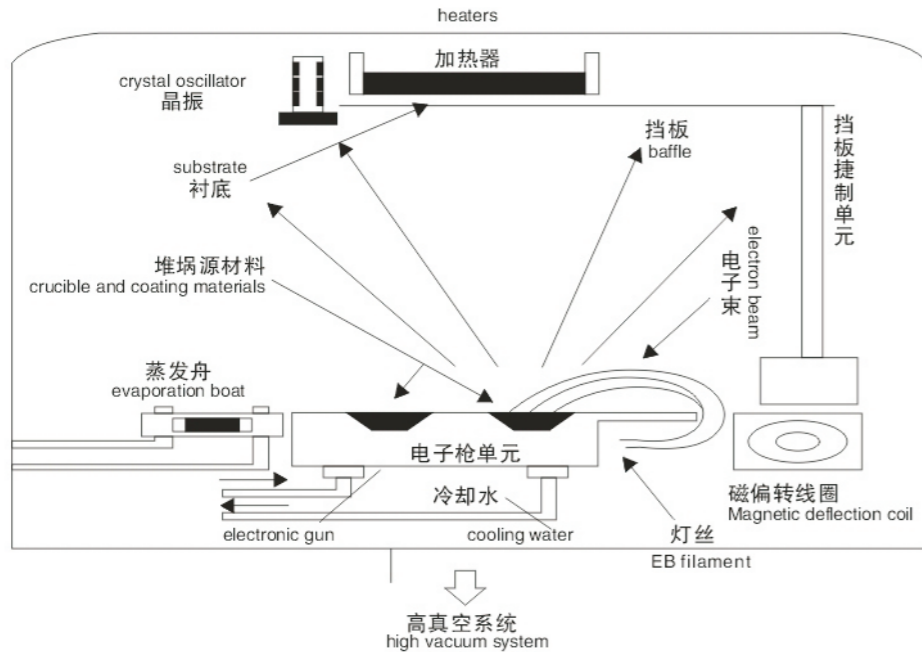

> 驰诚电子束蒸发原理图 <  
electron beam evaporation

## FEATURE DESCRIPTION

特点叙述

- 驰诚真空光学（电子枪）镀膜机通过电子源（电子枪）产生的高能电子束并在磁场的作用下轰击坩埚中的镀膜材料，通过动能对热能的转换产生高温使得材料溶化并蒸发以获得优秀附着力和光学性能的膜层。
- 设计装载超大坩埚电子枪，整个蒸发过程中膜料表面平整，蒸发分布均匀。
- 悉心选用国际著名品牌INFICON石英晶振膜厚监测系统，可实现成膜速度和镀膜过程的自动化控制。
- 创新设计多功能工件转动方式，可搭载多套穹顶式光学镀膜伞或行星式转架。
- 采用驰诚创新工艺制造，精益求精，全面通过欧盟CE和ISO国际质量管理体系认证。
- Vacuum optical(electric gun) coating machine application of thermal anode emits electrons into high energy density electron beam bombardment to plating material,the kinetic energy of the electron beam is converted into thermal energy ,heating the material and vaporization .Widely used as a variety of glass lenses, optical resin lenses, binoculars, glasses, optical lens etc.
- Equipped with large crucible electron gun,deposition film are smooth and uniform throughout the evaporation process.
- Adopts internationally famous brands INFICON quartz diaphragm thickness monitoring system,can realize automatic control of the coating speed and process.
- To acquire better quality of film,ion source is optional.
- We require stringent design specifications,with friendly human-machine interface touch screen , easy to operate also can be handled by your fingertips.
- Perfect combination of intelligent programming and Mitsubishi PLC , experience the smart of Cicel device.
- Innovative design multifunctional workpiece rotation mode,can carry multiple sets of arc-shaped fixtures, single arc-shaped plate r evolution or planetary rotation.
- Unique surface designs,double layer cooling water jacket, greatly increase the cooling effect,also make the appearance looking more beautiful.

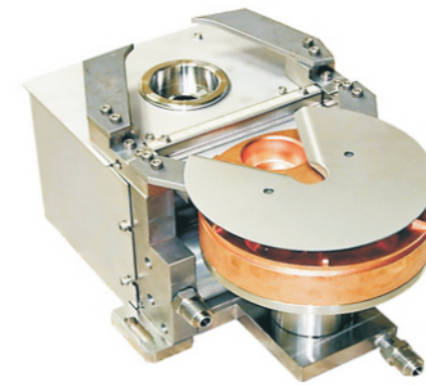

> 电子束蒸发源 <  
Electron beam evaporation source



> 霍尔离子源 <  
Haul ion source

# TECHNICAL CONFIGURATION

技术配置

- 腔体结构：立式前开门，卧式前开门，后置真空获得系统。
- 材质用料：腔体均采用优质不锈钢锻造。
- 制膜种类：光学多层膜，光学增透膜、减反射膜（AR）、单点增透、截止滤光片、七彩装饰功能膜等。
- 转动系统：变频调速，配备光学镀膜伞和行星式工件转架。
- 电子束蒸发器：配备大功率E型电子枪。
- 辅助镀膜：可配备霍尔离子源或 高压离子轰击电源以提高附着力、膜层密度、稳定折射率。
- 加热系统：铠装加热管加热方式，350℃温控PID控制。
- 真空系统：扩散泵（可选分子泵）+罗茨泵+机械泵+维持泵+深冷系统（可选）。
- 气体控制：采用多路气体流量控制仪。
- 膜层监测：配置采用美国INFICON产石英晶振膜厚仪，可实现膜层参数的储存与自动调用。
- 智能控制：PLC智能控制+HMI全彩人机触控界面，实现逻辑全自动控制。
- 报警及保护：异常情况进行报警，并执行相应保护措施。
- 其他技术参数：
  - 极限真空：5.0X10<sup>-4</sup>Pa
  - 抽气速率：5.0\*10<sup>-2</sup> ≤ 5min
  - 水压流速 ≥ 0.2Mpa 3m<sup>3</sup>/h；水温 ≤ 25℃；气压：0.4-0.8Mpa
- Chamber structure: vertical front door structure, horizontal front door, rear vacuum system, material for vacuum chamber adopts high quality SUS 304 stainless steel.
- Type of film: optical multilayer film, optical antireflection film, antireflection film (AR), filter film, rainbow color decorative film etc.
- Electron gun: adopts E-shape electron gun, equipped with latest technology of smart handheld devices, the device can control by automatic.
- Rotation system: frequency control.
- Heating system: heating by tube (PID temperature control).
- Vacuum system: Diffusion pump (molecular pump is optional) + Roots pump + Mechanical pump + Rotary vane pump (Cryogenic pump is optional).
- Gas control: mass flow controller + magnetic valve.
- Bombardment cleaning: hall ion source or high-voltage power ion bombardment.
- Evaporation source: multiple resistance evaporation source.
- Ion source: equipped with Hall ion source (optional) in order to improve adhesion, film density, stable refractive index of the film after coating.
- Layer monitoring: optical monitoring instruments as standard, also can choose SQC-310 crystal thickness meter produced by United States INFICON company.
- Control mode: manual operation + semiautomatic + automatic integration / touch screen + PLC
  - Ultimate vacuum: 5X10<sup>-4</sup>pa
  - Pump time: 5\*10<sup>-2</sup>pa ≤ 5mins
  - Water pressure ≥ 0.2Mpa 3m<sup>3</sup>/h; water temperature ≤ 25℃; gas pressure: 0.4-0.8Mpa

# APPLICATION

应用范围

- 驰诚CZ-OGS光学镀膜机可应用于如各种玻璃镜片，玻璃片，光学树脂镜片、望远镜、眼镜片、光学镜头、冷光杯、舞台灯光、电子产品、手机视窗、手机面板壳等产品的镀膜，该驰诚光学镀膜设备可镀制层数较多的短波通、长波通、增透膜、反射膜、滤光膜、分光膜、带通膜、介质膜、高反膜、彩色反射膜等多种膜系，能够实现0-99层膜的膜系镀膜。
- CICEL CZ-OGS series optical coating machine are widely use in coating lots of glass lenses, glass, optical resin lenses, binoculars, eye glasses, optical lens, cold cups, stage lighting, electronic products, mobile Shell panel and other products. This optical coating machine can coat antireflection film, reflective film, filter film, dielectric film, high anti-film, multicolor reflective film, can achieve 0-99 layer film.



驰诚CCZK-OGS光学电子枪镀膜设备常用规格表  
CICEL CCZK-OGS electron beam optical vacuum coater

D1350mm* H1350mm	D1600mm* H1500mm	D2050mm* H1500mm
规格均可定制 Specifications can be customized		

### 备注REMARKS:

- 真空室尺寸或设备配置可按客户产品及特殊工艺要求订做  
Vacuum chamber size and configuration can be customized in accordance with customer's special requirements for products and processes
- 更多应用请咨询工程技术人员：More application details please consult CICEL engineer

# CCZK-PL车灯硅油保护膜重合镀膜设备

CCZK-PL AUTO LAMP PROTECTIVE FILM VACUUM COATING MACHINE

## FEATURE DESCRIPTION

特点叙述



>驰诚车灯保护镀膜设备<  
CICEL protective film vacuum coating machine

- 驰诚CCZK-PL系列车灯硅油保护膜重合镀膜设备是在CCZK-EL蒸发镀膜系统上进行二次研发，是一款创新设计的全新一代车灯专用保护膜重合镀膜设备。
- 创新的蒸发电极设计，给予膜层优秀的致密性，均匀性，附着力和反射率。
- 先进的蒸发镀膜与硅油等离子重合技术完美相融，有效避免产品的二次污染。
- 采用国际顶级流量阀门供应商美国MKS产品，精准微控硅油流量，获得优秀的保护膜涂层。
- 采用驰诚创新工艺制造，精益求精，全面通过欧盟CE和ISO国际质量管理体系认证。
- CICEL ZP-PL series automotive lamp dedicated vacuum coating machine is secondary research on the CCZK-EL evaporation coating system, is a new generation of innovative design coating equipment for automotive headlight.
- Professional used in high demanding automotive headlamps coating, its advanced coating process solve the problem of pollution automotive headlights secondary coating.
- Stainless steel chamber with double-door design, greatly improve the purity inside the chamber and production efficiency.
- The innovative design of the evaporate electrode to give the coating film with excellent density, uniformity and adhesion.
- Perfect combination of aluminum evaporation and silicone oil plasma, avoid secondary pollution of the product effectively.
- Adopt international top brand MKS flow valve, can control the flow of silicone oil precisely.
- Touch-screen operator interface, fully automatic intelligent operating system, experience advanced human-machine interaction.

## APPLICATION

应用范围

- 驰诚CCZK-PL车灯保护膜重合镀膜机广泛应用汽车灯具镀膜，高档灯具，高档反光碗镀膜等。
- CICEL CCZK-PL automotive lamp protective film coater is the most advanced car lamp coating equipment at present, with a professional application in high-grade lamp coating, car headlight coating, high-grade reflect light coating etc. The newly-developed silicon oil superposition system is adopted to achieve excellent surface processing performance. It's the ideal coating equipment for coating plastic, metal, BMC, glass lamp protective film.

备注：普通灯具，反光碗等镀膜可采用驰诚CCZK-EL系列普通蒸发镀膜机。

Remarks :Cicel CCZK-EL series evaporation coating machine can also suit for common lamp ,reflect cup etc.



>HMDSO硅油喷射系统<  
Hmdso Silicone Oil Protective System



>高效镀透式设计蒸发源<  
High efficient Cross-coating source design

# TECHNICAL CONFIGURATION

技术配置

- 腔体结构: 立式前开门, 卧式前开门, 后置真空获得系统。
- 材质用料: 腔体均采用优质不锈钢。
- 制膜种类: 蒸发镀膜+硅油保护膜。
- 硅油重合: 采用美国MKS硅油流量阀, 全不锈钢硅油存储与输出装置。
- 转动系统: 变频调速, 可6轴或8轴转动系统(可定制)。
- 电源系统: 蒸发电源+轰击电源。
- 真空系统: 扩散泵(可选分子泵)+罗茨泵+机械泵+维持泵+深冷系统(可选)。
- 气体控制: 质量流量控制仪+电磁阀。
- 离子清洗: 配备高压离子轰击清洗系统。
- 蒸发源: 搭配多组转为车灯镀膜最新研发电阻蒸发源。
- 智能控制: PLC智能控制+HMI全彩人机触控界面, 实现全自动控制。
- 报警及保护: 异常情况进行报警, 并执行相应保护措施。
- 其他技术参数:
  - 极限真空:  $5.0 \times 10^{-4} \text{Pa}$
  - 抽气速率:  $5.0 \times 10^2 \leq 5 \text{min}$
  - 水压流速  $\geq 0.2 \text{Mpa } 3 \text{m}^3/\text{h}$ ; 水温  $\leq 25^\circ\text{C}$ ; 气压:  $0.4-0.8 \text{Mpa}$
- Chamber structure: vertical front door structure, horizontal front door, postpositional vacuum acquisition system, adopt high-quality #304 stainless steel for vacuum chamber.
- Type of film: evaporation aluminum coating + silicon oil protective film.
- Silicon oil superposition: adopt American MKS silicon oil flux valve, all stainless steel silicon pipe and silicon oil storage tank.
- Rotating system: frequency control, 6 or 8-axis rotating system is optional.
- Vacuum system: Diffusion pump (molecular pump is optional)+Roots pump +Mechanical pump + Rotary vane pump (Cryogenic system is optional).
- Gas control: quality flux controller + magnetic valve.
- Bombardment cleaning: high-voltage ion bombard power and aluminum stick can be equipped.
- Evaporation source: multi-group newly-developed resistance evaporation source.
- Control mode: manual operation +semiautomatic + automatic integration / touch screen + PLC
- Ultimate vacuum:  $5 \times 10^{-4} \text{pa}$
- Pump time:  $5 \times 10^2 \text{pa} \leq 5 \text{mins}$
- Water pressure  $\geq 0.2 \text{Mpa } 3 \text{m}^3/\text{h}$ ; water temperature  $\leq 25^\circ\text{C}$ ; gas pressure:  $0.4-0.8 \text{Mpa}$

## 驰诚CCZK-PL车灯硅油保护膜重合镀膜设备常用规格表 CICEL CCZK-PL auto lamp protective film vacuum coater

D1600mm*	D1800mm*	D2000mm*
H2000mm	H2000mm	H2200mm
规格均可定制 Specifications can be customized		

### 备注REMARKS:

- 真空室尺寸或设备配置可按客户产品及特殊工艺要求订做  
Vacuum chamber size and configuration can be customized in accordance with customer's special requirements for products and processes
- 更多应用请咨询工程技术人员: More application details please consult CICEL engineer

## CCZK-RC卷绕式镀膜设备

CCZK-RC ROLL VACUUM COATING MACHINE



>驰诚卷绕镀膜设备<  
CICEL roll vacuum coating equipment



>卷绕辊特写<  
The feature of roller



>平面磁控溅射靶<  
Planar sputtering target

# FEATURE DESCRIPTION

特点叙述

- 驰诚CCZK-RC系列卷绕镀膜设备具有运行平稳、收放镀膜平齐、膜层均匀、生产周期短、能耗低、操作维护方便、性能稳定等特点。
- 卷绕系统采用高精度直流或交流变频调速，具有运行平稳、速度高、对原卷材不划伤、不折皱，收卷端面整齐等特点。
- 张力控制采用进口数字张力控制系统，具有张力、线速度恒定，运作快速的特点。
- 各组送丝由微机电机独立控制，可总调或单独调速，并有速度显示。
- 强劲高效的抽真空系统，配备节能维持泵。
- 采用驰诚创新工艺制造，精益求精，全面通过欧盟CE和ISO国际质量管理体系认证。
- Cicel CZ-RC series roll coating equipment with the characteristics of stable operation, film uniformity, short production cycle, low energy consumption, easy operation and maintenance, stable performance etc.
- Roll system adopt high-precision DC or AC variable speed, with the features of stable operation, high speed, no scratches and wrinkles on the original material.
- Equipped with high-quality transformer system, comprehensive cooling system effectively ensure evaporation uniformity and film quality.
- Tension controlling adopts imported digital control system, having tension, line speed constancy, fast action speed character.
- Each group wire controlled by micro computer magnet independently, support master or separate speed regulation, with speed display.
- Vacuum system well-equipped, fast air evacuation, controlled by PLC.
- Equipped with high capacity power supply, high film coating efficiency, film uniformity.
- Optional online film thickness detection system can display real-time relative thickness of the coating film on the human-machine interface.

# TECHNICAL CONFIGURATION

技术配置

- 真空腔室：卧式。
- 材质用料：腔体均采用优质不锈钢。
- 真空系统：扩散泵（分子泵）+罗茨泵+机械泵+维持泵+深冷水汽捕集泵。
- 卷绕系统：采用6至10组辊子，收卷辊、放卷辊、水冷辊各由一台电动机驱动。
- 镀膜系统：根据产品可选择蒸发镀膜系统或磁控溅射镀膜系统。送丝机构含有坩埚、电极、水冷、送丝机、电源等。
- 溅射靶材：磁控溅射可配1-4只平面铝靶或圆柱铝靶材。
- 电源系统：配备大功率蒸发电源以及磁控溅射电源。
- 智能控制：PLC智能控制+HMI全彩人机触控界面，实现全自动控制。
- 报警及保护：异常情况进行报警，并执行相应保护措施。
- 其他技术参数：
  - 极限真空： $5.0 \times 10^{-4}$  Pa
  - 抽气速率： $5.0 \times 10^2 \leq 5$  min
  - 水压流速  $\geq 0.2$  Mpa  $3\text{m}^3/\text{h}$ ；水温  $\leq 25^\circ\text{C}$ ；气压：0.4-0.8 Mpa
- Vacuum chamber: horizontal cylindrical, made by SUS304 stainless steel material.
- Vacuum system: diffusion pump, roots pump, mechanical pump, adopt pneumatic and magnetron valve and so on; cryogenic pump system is optional.
- Rolling system: adopt 6 to 10 suites rollers, each wind-up roller, unwinding roller, water cooling roller are driven by one motor.
- Coating system: optional evaporating system or magnetron sputtering coating system depend on the coated products. Wire feeding structure contains crucible, electrode, water cooling, wire feeding machine, power etc.
- Sputtering target: magnet sputtering can be equipped with 1-4 pieces flat aluminum target or cylindrical aluminum target and sputtering power.
- Control system: full color touch screen, PLC intelligent control.
- Ultimate vacuum:  $5 \times 10^{-4}$  pa
- Pump time:  $5 \times 10^2$  pa  $\leq 5$  mins
- Water pressure  $\geq 0.2$  Mpa  $3\text{m}^3/\text{h}$ ; water temperature  $\leq 25^\circ\text{C}$ ; gas pressure: 0.4-0.8 Mpa

# APPLICATION

应用范围

- 驰诚CZ-RC卷绕系列镀膜设备主要用于在塑料薄膜（PET, PVC, CPP等）、布、纸、金属箔等带状材料表面镀制金属膜。可在柔性基体表面镀制各种功能膜层以及装饰膜层，产品广泛用于包装、印刷、防伪、纺织、电子工业等领域。
- CICEL CZ-RC rolling series coating equipment are mainly applying to coat metal film on plastic films (PET, PVC, CPP etc), cloth, paper, metal foils, and belt material. Flexibility bases products can be coat all kinds of function and decoration films, widely used in packing, painting, anti-counterfeiting, spinning, waving, electricity field etc.

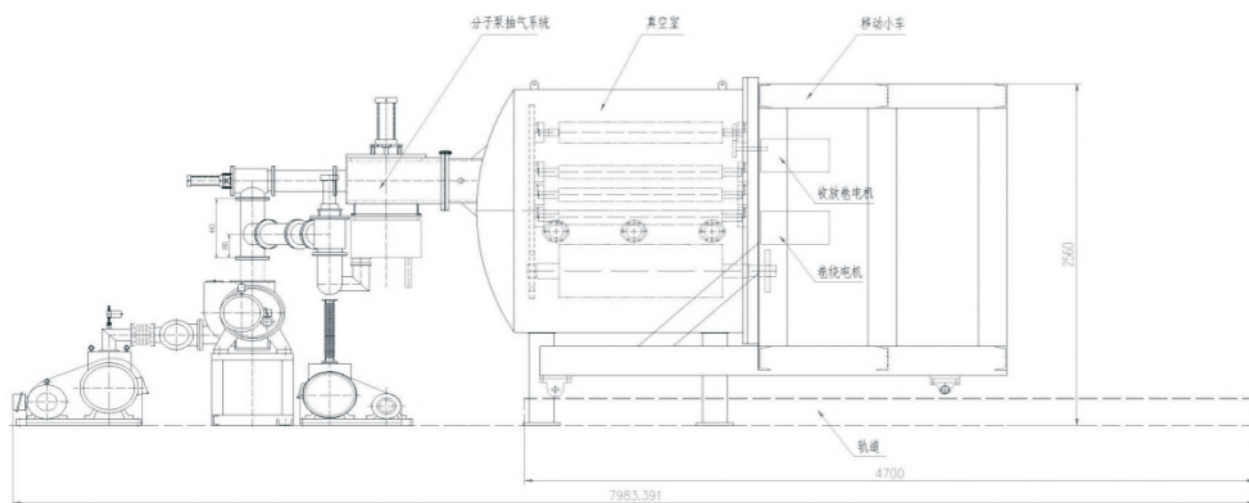
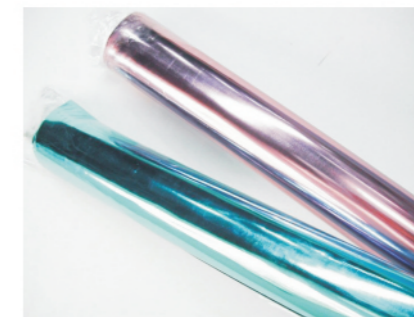
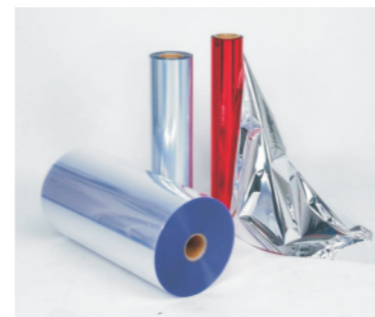

>卷绕镀膜设备侧视图<  
Roll coating system

# CCZK-SFL连续式磁控镀膜流水线

CCZK-SFL CONTINUOUS MAGNETRON SPUTTERING COATING ASSEMBLY LINE



>驰诚连续式磁控镀膜流水线<  
CICEL Continuous magnetron sputtering coating line

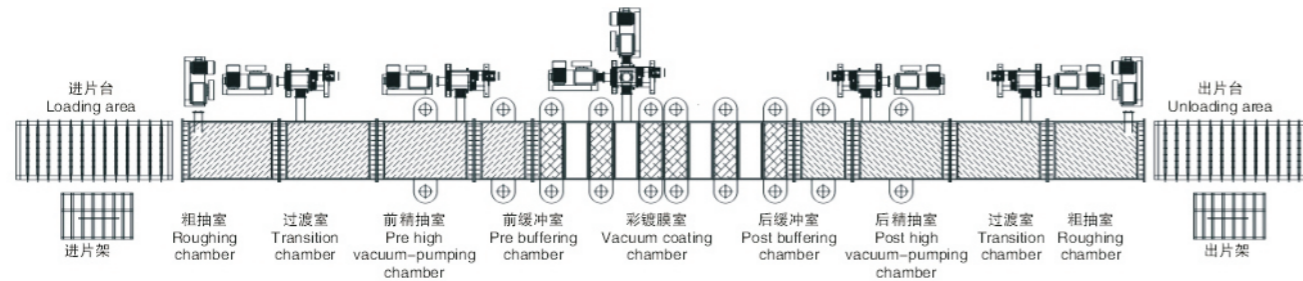

生产线

## FEATURE DESCRIPTION

特点叙述

- 驰诚公司CCZK-SFL系列磁控溅射镀膜流水线可适用于幕墙玻璃, 铝镜, 反光镜生产, 配备旋转阴极, 平面阴极磁控溅射靶。可以在大平板玻璃上镀制一至多层特殊的金属或金属氧化物, 金属氮化物薄膜, 金属单质膜, 复合膜, Low-E辐射膜也可在小弯的弧形玻璃上镀膜。镀膜线产量高, 每年可镀膜200万平方米以上, 多室传动, 充分保证膜层的均匀性, 物理性。
- CICEL CCZK-SFL series magnetron sputtering coating assembly line can apply to coating glass curtain wall ,aluminum mirror ,reflection mirror, equipped with rotation cathode, flat cathode magnetron sputtering target. It can also coat multilayer special films such as metal or metal oxid, metal nitride film, metal elementary substance film, complex film , low-e radiation film ,and small lesser curvature arc-shaped glass .The output of the coating line is high,more than 200 million squares meters can coat per year , multicellular transmission , fully guaranty the film homogeneity, physical property.

## TECHNICAL CONFIGURATION

技术配置

- 腔体结构: 采用高效的卧式连续磁控镀膜流水线, 配备前后粗抽室, 前后过渡室, 前后精抽室, 前后缓冲室, 彩镀室。
- 靶材设计: 采用新型旋转阴极靶材以及平面阴极靶材。
- 电源配置: 配备大功率中频磁控溅射电源。
- 传动系统: 滚轴传动, 变频可调, 感应式室门开启系统。
- 真空系统: 扩散泵(分子泵)+罗茨泵+机械泵+深冷泵。
- 可镀膜玻璃或平板, 尺寸可定制。
- 生产线采用了先进的插板阀进行腔室隔断, 可以实现有效隔断, 稳定工艺气体。
- 生产线采用了均匀进气管结构设计, 气流注入均匀平缓。
- 电气控制: 生产线采用PLC全过程控制, 快速的生产节拍, 配备工业计算机显示系统。
- 人机对话: 控制系统能实现人、机对话, 及时对生产过程进行必要干预。
- 运行过程有报警提示和故障显示, 故障显示能提示操作人员正确的操作和排故。
- 其他技术参数:
  - 极限真空:  $3.0 \times 10^{-2} \text{Pa}$
  - 抽气速率:  $5.0 \times 10^{-2} \leq 5 \text{min}$
  - 水压流速  $\geq 0.2 \text{Mpa } 3 \text{m}^3/\text{h}$ ; 水温  $\leq 25^\circ\text{C}$ ; 气压:  $0.4-0.8 \text{Mpa}$
- Chamber structure: adopt high efficiency horizontal continuous magnetron coating assembly line , front and back roughing pumping chamber, transition chamber , refining pumping chamber, buffer chamber, color plating chamber are equipped with this machine.
- Target design : adopt new design rotation cathode target and flat cathode target.
- Power configuration : equipped with high power medium frequency magnetron sputtering power.
- Electrical control : production line use PLC control ,equipped with industrial computer display system.
- Human machine conversation: control system can achieve conversation between human and machine, in order to take action to producing process in time. There are alarm remind and malfunction display , reminding operator undertake the problem correctly.
- Transmission system : roller transmitting ,support frequency converse.
- Glass and flat board are available for coating, size can be customized.
- Our production line adopt advanced slide damper to separate the chamber, which can achieve efficiency separation, stabilize the gas of process.
- The production line adopt well distributed input pipe structure design , gas flow transfusing more uniform and gentle .
  - Ultimate vacuum: $3 \times 10^{-2} \text{pa}$
  - Pump time: $5 \times 10^{-2} \text{pa} \leq 5 \text{mins}$
  - Water pressure  $\geq 0.2 \text{Mpa } 3 \text{m}^3/\text{h}$ ;water temperature  $\leq 25^\circ\text{C}$ ;gas pressure: $0.4-0.8 \text{Mpa}$



镀膜流水线  
Continuous line



玻璃出片  
low-e coating



泵抽系统  
pumping system

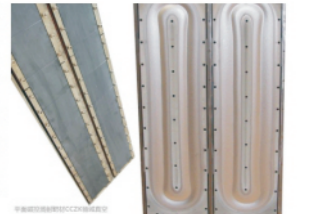

溅射靶材  
sputtering target

# APPLICATION

应用范围

- 驰诚CCZK-SFL系列连续镀膜流水线主要应用于大平板玻璃，幕墙玻璃，低辐射玻璃（LOW-E玻璃）等大面产品的连续式镀膜，可镀制金属单层膜，合金膜或金属化合物膜。可进行大面积铝镜片镀膜，反光镜镀膜以及大面积溅射镀膜需求。
- CICEL CCZK-SFL series continuous coating assembly line mainly apply to flat glass, acrylic board and coating single-layer film on metal material, alloy film or metal compound film. It can achieve large area glass coating, reflector glass coating and sputtering coating requirement.



## 驰诚CCZK-SFL连续式磁控镀膜流水线常用规格表

CICEL CCZK-SFL continuous magnetron sputtering coating assembly line vacuum coater

最大可镀膜玻璃尺寸：2500 × 1400

规格均可定制 Specifications can be customized

### 备注REMARKS:

- 真空室尺寸或设备配置可按客户产品及特殊工艺要求订做  
Vacuum chamber size and configuration can be customized in accordance with customer's special requirements for products and processes
- 更多应用请咨询工程技术人员：More application details please consult CICEL engineer

# CCZK-SF磁控溅射镀膜设备

CCZK-SF MAGNETRON SPUTTERING COATING MACHINE



>驰诚立式磁控溅射镀膜机<  
CICEL vertical magnetron sputtering coating machine



>驰诚立式磁控溅射镀膜机<  
CICEL vertical magnetron sputtering coating machine

# FEATURE DESCRIPTION

特点叙述

- 驰诚CCZK-SF磁控溅射镀膜机，具备成膜速率高，基片温度低，膜的粘附性好，可实现大面积镀膜。
- 相对于传统蒸发镀膜设备，驰诚磁控溅射镀膜可获得更为优秀的膜层致密性，均匀性和结合力。
- 采用最为先进的直流或中频磁控溅射电源，满足不同层次客户需求。
- 先进的高速低温溅射技术，极大的扩展了驰诚CCZK-SF磁控设备的应用范围，对无法受热或耐热力产品提供优质的溅射镀膜解决方案。
- 采用驰诚创新工艺制造，精益求精，全面通过欧盟CE和ISO国际质量管理体系认证。
- CICEL CCZK-SF Magnetron sputtering coating Machine with high deposition rate, low temperature of substrate, well adhesion, and can achieve large area coating.
- The principle is electron crashed with argon atom when quickly flying to substrate under the function of electric field, as a result a large amount of argon ion and electron are ionized, and electron flies to substrate. Argon ion bombards target with higher speed under the function of electric field, sputtered abundant target atom, and neutral target atom (or molecule) is deposited on substrate to form film.
- Compared with traditional evaporation coating equipment, Cicel magnetron sputtering coating can obtain more excellent density, uniformity and adhesion for the coating film.
- Adopted the most advanced direct current or frequency magnetron sputtering power, the machine could satisfy the customer's requirements of different levels.
- Equipped with latest developed planar magnetron target, centre rotation cylindrical target, twins targets, etc.
- Advanced high speed and low temperature sputtering technology, infinitely expand the application range of Cicel CCZK-SF magnetron sputtering equipment and provide good quality coating solution for incapable heating products.
- Perfect combination of intelligence industry PLC controller and touch system HMI makes operation become simple and in order.

# APPLICATION

应用范围

适合镀制高级装饰膜，合金膜层等。先进的高速反应低温溅射技术，成就了其高速的薄膜生长能力和优秀的膜层均匀度致密性，广泛应用于塑料餐具，手机外壳、卫浴洁具、汽车轮毂，五金饰品及标牌等镀膜。亦可溅射塑料制品、陶瓷、马赛克、树脂、水晶玻璃制品等。

Suitable for coating high grade decoration film, alloy film etc. Advanced high action speed and low temperature sputtering technology, achieved its high speed film growth ability and excellent film uniformity and compactness, which is widely used in plastic, cell phone shell, sanitary ware, car wheel, metal jewelry and label etc. It also can be used for sputtering plastic products, ceramics, mosaic, resin and crystal glass products.

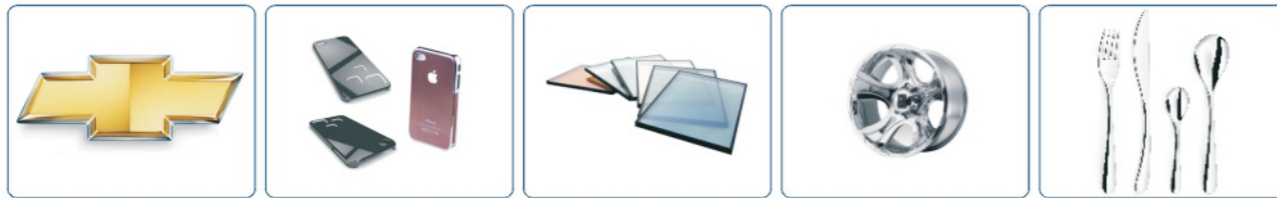

## 驰诚CCZK-SF磁控溅射镀膜设备常用规格表

CICEL CCZK-SF magnetron sputtering vacuum coater

D1300mm* H1500mm	D1800mm* H2000mm	D500mm* H500mm	D2000mm* H2200mm
---------------------	---------------------	-------------------	---------------------

规格均可定制 Specifications can be customized

# TECHNICAL CONFIGURATION

技术配置

- 腔体结构: 立式前开门, 卧式前开门。
- 材质用料: 腔体材质为SUS304不锈钢或碳钢。
- 真空系统: 扩散泵(可选分子泵)+罗茨泵+机械泵+维持泵(另有深冷泵系统可供选择)。
- 溅射靶材: 中心圆柱靶, 平面靶, 孪生靶等。
- 磁控电源: 可配备直流或中频磁控溅射电源。
- 转动系统: 变频调速, 公自转结合, 可根据客户产品和要求设计。
- 膜层结构: 单层膜、多层膜。
- 气体控制: 气体流量控制仪集成触控操作控制。
- 人机界面: PLC智能控制+全彩HMI触摸屏。
- 操作方式: 逻辑全自动方式、半自动方式、手动方式。
- 智能控制: PLC智能控制+HMI全彩人机触控界面, 实现全自动控制。
- 报警及保护: 异常情况进行报警, 并执行相应保护措施。
- 其他技术参数:
  - 极限真空:  $5.0 \times 10^{-4}$  Pa
  - 抽气速率:  $5.0 \times 10^{-2} \leq 5$  min
  - 水流速  $\geq 0.2$  Mpa 3m<sup>3</sup>/h; 水温  $\leq 25$  °C; 气压: 0.4-0.8 Mpa
- Chamber structure: vertical front opening, chamber material adopts SUS304 stainless steel or carbon steel.
- Vacuum system: Diffusion pump or molecular pump + Roots pump + Mechanical pump + Rotary vane pump (Cryogenic pump can be optional).
- Sputtering target: central cylindrical target, flat target, twins target (optional depend on the detail products).
- Magnetron power: direct current or intermediate frequency magnetron sputtering power can be selected.
- Rotation system: frequency control, combined with revolution and rotation, it can be designed according to customer and products requirement.
- Type of film: single film, multi films.
- Gas control: adopt SEVENSTAR gas flux controller.
- Sputtering inhomogeneity:  $\pm 5\% \sim \pm 7\%$
- Human-machine interface: PLC intelligence control + full color 10 inches touch screen.
- Operating mode: logic automatic, semi-automatic and manual operation.
- Ultimate vacuum:  $5 \times 10^{-4}$  pa
- Pump time:  $5 \times 10^{-4}$  pa  $\leq 5$  mins
- Water pressure  $\geq 0.2$  Mpa 3m<sup>3</sup>/h; water temperature  $\leq 25$  °C; gas pressure: 0.4-0.8 Mpa

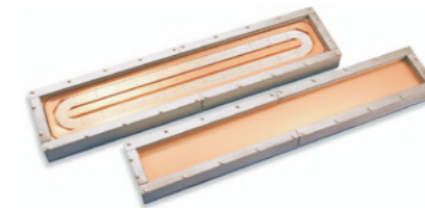

>平面磁控溅射靶<  
Planar sputtering target



>圆柱磁控溅射靶<  
Cylindrical magnetron sputtering target

### 备注REMARKS:

- 真空室尺寸或设备配置可按客户产品及特殊工艺要求订做  
Vacuum chamber size and configuration can be customized in accordance with customer's special requirements for products and processes
- 更多应用请咨询工程技术人员: More application details please consult CICEL engineer

# CCZK-UVA自动UV涂装流水线

CCZK-UVA AUTOMATIC UV SPRAYING CURING LINE



>驰诚自动UV涂装生产线<  
CICEL Automatic UV spray line

## FEATURE DESCRIPTION

特点叙述

- 驰诚全新一代CCZK-UV系列自动涂装流水线拥有先进完整的喷涂系统，主要是为真空镀膜的产品提供自动人性化的底漆，面漆喷涂。
- 可广泛适用于塑料，金属，玻璃，陶瓷等材质的UV喷涂，UV喷涂技术具有优秀的表面形成能力，赋予产品高密度的附着力和均匀的涂层。
- 完整的流水线涂装系统，火焰处理室，静电除尘室，UV自动喷房，红外预热流平，UV光固化，冷却风室。
- 全自动喷涂技术，配备日本IWATA自动喷枪，客户亦可选配ABB全自动喷涂机器人。
- 水帘式喷房设计，漆雾回收处理系统，极大降低漆雾扩散污染。
- 自动链条式设计，可灵活的进行线体规划，安装规划。
- 全新设计的人机界面，PLC自动化控制系统，简易操作，尽在指尖。
- 合理的红外加热布置，全角度UV固化布局，快速完成无死角的预热固化流程。
- Equipped with advanced and complete painting system, CCZK-UV series automatic painting line, which is complete new generation of CICEL, mainly provides automatic base coat and top coat for products coated by vacuum coating.
- It can be widely applied to UV painting of materials such as plastic, metal, glass, ceramic and other substrate. Features with the excellent surface forming ability, UV painting technology provides high-density adhesive force and uniform coating for products.
- Complete assembly line painting system, flame treatment room, electrostatic dust room, UV automatic painting room, Infrared preheating leveling, UV curable, cooling air chamber.
- Automatic painting technology, equipped with Japanese IWATA automatic spray gun, customer can also match ABB full-automatic painting robot.
- Water curtain spray design and paint mist recycle system which could greatly reduce the proliferation of paint mist pollution.
- Auto chain type design can flexibly carry out the line body planning and installation.
- Entirely new human-machine interface design, PLC automatic control system and simple operation which can be handled by your fingertips.
- Reasonable arrangement of infrared heating, the hole point of UV curing layout. Warm curing process without dead angle is completed quickly.

## TECHNICAL CONFIGURATION

技术配置

- 线体长度：可定制长度，单喷单烤，双喷双烤，一般自动线体长为50米，90米，120米，200米等。
- 转子链条：可变频调节传动链条。
- 静电除尘：独立自动静电除尘室，配置6头静电除尘枪。
- 火焰处理：多支火焰处理枪，提高特定产品的涂装附着力。
- 自动喷涂：独立自动喷房，配备多支SWATA日本岩田自动喷枪，可选配全自动ABB喷涂机器人。
- 红外流平：精确核算的红外烘烤长度，采用多支最新研发的红外加热系统，温度可控可调。
- UV固化：配备多支大功率UV灯，全角度UV灯光系统。
- 空气净化：采用高效过滤器，提高空气净化速率与洁净度。
- 电气控制：采用PLC全自动控制系统，工艺参数可控可调。
- Length: Customized length, single painting with single baking, double spray painting with double baking, usually the length of automatic line is 50m, 90m, 120m and 200m etc.
- Rotor chain: frequency adjustable transmission chain.
- Electrostatic dust precipitation: independent automatic electrostatic precipitation chamber and equipped with 6 electrostatic precipitation gun.
- Flame treatment: multiple flame treatment gun, improve the adhesion of specific product.
- Automatic painting: independent automatic spray chamber, equipped with multiple SWATA IWATA automatic spray gun, customer can also select ABB full-automatic painting robot.
- Infrared leveling: infrared pre-heat-flux bake length with accurate calculation, adopt multiple latest R&D infrared pre-heat-flux system with adjustable temperature.
- UV curing: equipped with multiple high power UV light, whole point of UV curing device.
- Air purge: adopt high-efficiency filter, which could improve the purification rate and cleanliness.
- Electrical control: adopt PLC fully automatic control system, process parameters are controllable and adjustable.

## APPLICATION

应用范围

- 广泛应用于塑料，金属，玻璃等产品的涂装，流水线生产模式可承载大批量产品的高效喷涂。
- 配备双喷双烤系统可实现产品的UV喷涂和普通热固化喷涂；一般应用有车灯，杯盖，高端化妆品瓶盖，工艺装饰品，鞋跟等。
- 配套驰诚CCZK-EL系列蒸发镀膜设备使用，可涂装更具亮度和附着力的表面处理效果。
- Equipment application: Widely applied to coating of plastic, metal and glass products, assembly line production model can support efficiency coating for large scale products.
- Equipped with double spray and double bake system, UV painting and general thermal curing painting of products can be realize; General applications including auto lamp, bowl cover, high-end cosmetic cap, arts & crafts and heels etc.
- Assorted with Cicel CCZK-EL series evaporation coating machines, can realize the surface treatment effect with better brightness and adhesion.



### 备注REMARKS:

- 驰诚CCZK-EL系列普通蒸发镀膜机可咨询驰诚销售人员  
Consult sales person for more information about CCZK-EL series evaporation coater
- 更多应用请咨询驰诚工程师：Consult Cicel engineers for more application information

# CCZK-UVM手动UV涂装流水线

CCZK-UVM MANUAL UV SPRAYING CURING LINE

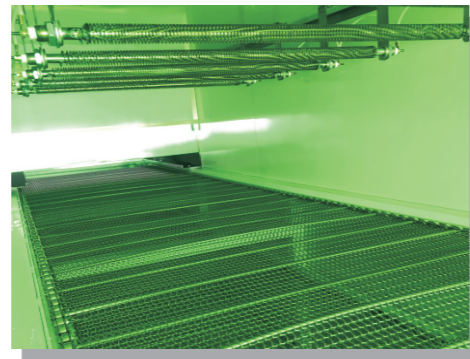

## FEATURE DESCRIPTION

特点叙述

- 驰诚CCZK-UVM系列手动喷涂线可为客户提供简便优秀的UV表面涂装能力，设备提供完整的UV涂装流程系统，配合驰诚CCZK-EL系列蒸发镀膜设备使用，可实现产品UV底漆喷涂，真空镀膜，UV面漆喷涂。
- 完整的UV流程系统，红外流平，UV固化，自动冷却流水线式操作。
- 配备手动水帘式喷台，减少漆雾污染，可定制多工位操作台。
- 隧道式流水线设计，大大提高线体内部保温防污染能力。
- 采用简便易懂的控制系统，提高设备运行效率。
- Cicel CCZK-UVM series manual spray line to provide customers with excellent UV surface coating capability, also provides a complete UV process system, with the use of our CCZK-EL series evaporation coating machine, products can be achieved UV base coat painting, vacuum coating, UV top coat painting.
- Complete UV process system, infrared leveling, UV curing, automatic cooling pipelined operation.
- Equipped with manual curtain-style spray booth, reduce mist pollution, multi-station console can be customized.
- Tunnel pipeline design, greatly improve the ability to keep temperature inside and prevent pollution.
- Adopt easy-to-understand control system to improve the efficiency of equipment.

## TECHNICAL CONFIGURATION

技术配置

- 线体材质：采用不锈钢网带式传输。
- 喷台配置：配备水帘喷台，防爆电机，防爆荧光灯。
- 风机系统：配置排风风机，送风风机，离心式风机系统。
- 红外系统：合理配置红外加热长度，采用多组最新研发的红外加热管。
- UV固化：全角度UV固化装置，多组UV灯光系统。
- 传送系统：大功率传动马达，网带式输送系统。
- Body material: high quality stainless steel mesh belt transmission.
- Spray booth configuration: with curtain spray booth, explosion-proof motor, explosion-proof fluorescent.
- Fan System: configuration exhaust fans, air blower, centrifugal blower system.
- Infrared Systems: rational allocation of infrared heating length, using multiple sets of newly developed infrared heating tube.
- UV curing: the whole point of UV curing device, multiple UV light system.
- Transfer system: high power drive motor, mesh belt conveyor system.

## APPLICATION

应用范围

UV镀膜工艺应用广泛，膜层具有优秀的硬度，光洁度，颜色鲜艳。主要应用于高端化妆品瓶盖，杯盖，开关面板，女士鞋跟，金属杯，车灯等各种塑料件，金属件的喷涂。

UV coating process is widely used, the film has excellent hardness, finish, bright colors. Mainly used in a variety of plastic parts, metal parts, such as high-end cosmetics caps, switch panel, shoes heels, metal cups, car lights etc.

配备CCZK-EL系列蒸发镀膜机可咨询驰诚销售工程师

With CCZK-EL series evaporation coating machine please kindly consult Cicel sales engineer

## 驰诚CCZK-UVM手动UV涂装流水线常用规格表

CICEL CCZK-UVM UV manual spraying line vacuum coater

12m	18m	25m	35m
规格均可定制 Specifications can be customized			

### 备注REMARKS:

- 流水线长度可按客户产品及场地要求订做  
The length of UV line can be customized in accordance with customer's special requirements for products
- 更多应用请咨询工程技术人员：More application details please consult CICEL engineer

## 驰诚PVD超硬质涂层设备工艺特点

- 可在多种基材的工具、模具和刀具上沉积TiN、TiAlN、TiC、TiCN、TiCrAlN和DLC（类金刚石）等单层及多层优质硬质膜层。
- 膜层硬度高（HV 2000 ~ 4000），结合强度高（最高可达100N）、耐磨减摩（摩擦系数可低到0.11）、表面粗糙度低（最高达镜面），能使工模具、刀具的使用寿命大幅度提高，如微型钻头的寿命可以提高到4倍左右；膜层厚度1.0 ~ 3.0微米。

### Characteristics of CCZK-PVD Tools coating machine

- High Quality superhard tool coatings such as TiN, TiAlN, TiC, TiCN, TiCrAlN and DLC can be deposited on various substrate.
- High microhardness (Hv2000 ~ 4000), high adhesion(up to 100N), excellent wear-resistance and antifriction (friction efficient low to 0.11), greatly increases the life of dies and tools(the lift of micro drills can be increased to 3 times). Coating thickness ranges in 1.0 ~ 3.0 $\mu$ m.

## 常用PVD硬质涂层膜层系数表

The hardness and friction coefficient about pvd coating

薄膜类型 Coating	色泽 Colour	硬度 (Hv) Hardness	厚度(um) Thickness	摩擦系数 Friction coefficient	耐热温度 (°C) Temperature
TiN	金黄Gold	2200	1 ~ 4	0.5	550
CrN	银灰Silver gray	2200	1 ~ 4	0.4	650
TiCN	红~褐 Red to brownness	2500	1 ~ 4	0.4	500
TiAlN	紫色	2800	1 ~ 4	0.4	600
AlTiN	黑色black	3000	1 ~ 4	0.4	650
CrTiAlN	银灰Silver gray	3200	1 ~ 4	0.5	850
一般DLC	黑 Black	2200	1 ~ 4	<0.15	400
纳米黑金刚膜	黑Black	2500 ~ 4000	1 ~ 4	<0.1	600

## 磁控溅射薄膜沉积原理

The principle of the deposition by magnetron sputtering

磁控溅射原理如图所示：

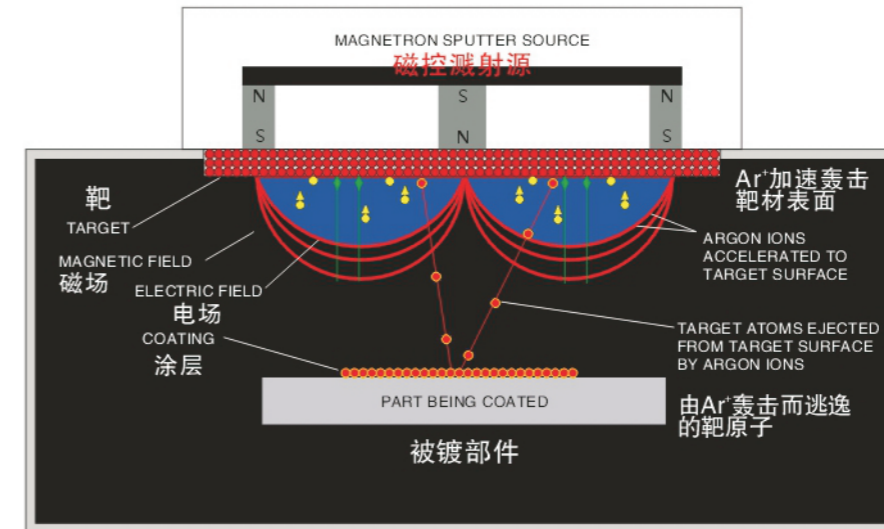

磁控溅射薄膜沉积：当阴极靶面存在拱形磁场，在靶面附近的电子由于磁场和电场的共同作用，使电子约束在一个环形区域内并得到加速获得能量，高能电子撞击气体原子（如氩气原子）使之电离，进而在拱形区域内形成稳定的等离子体。氩离子在电场作用下加速轰击阴极靶面，使靶面原子获得足够的能量飞离靶面，溅射原子沉积在基片上形成涂层。

若采用较强的磁场，更多电子将约束在等离子体区内，电子密度的提高使其与原子的碰撞几率上升，使氩原子的电离率得到提升，从而导致溅射作用的增强，最终达到沉积速率提高。

The electrons near the cathode are confined with the annular trajectory by electric field and arch magnetic field on the surface of target. High energy electrons impact the atoms (like Ar), resulting in the ionization. So there would be stable plasma in the arch region, which generates ion cascade bombarding the target. As a result, numerous atoms get the energy enough to escape from the target material, deposited on the substrate and form the coatings.

By adopting stronger magnetic field, more electrons will be confined to the dense plasma area. With the increase of density of electron, which enhances the probability of impact between electronic and atom. The rate of ionization of argon is improved, as a consequence enhancing the sputtering effect and finally achieve the deposition accelerating.

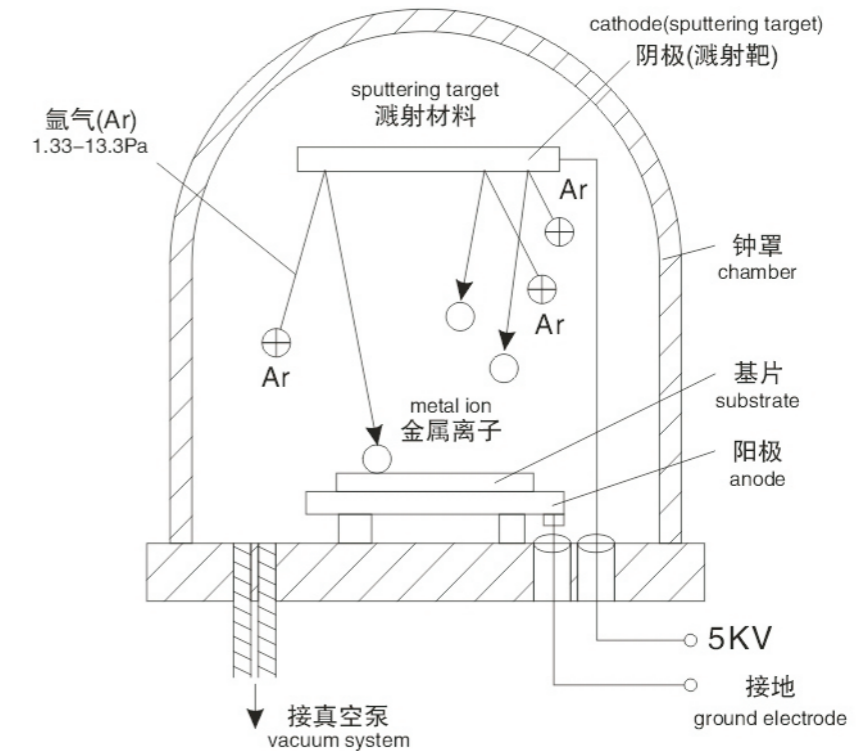

## 多弧离子镀膜 Multi-arc ion Deposition

在真空环境下通过引弧形成弧光放电，在阴极靶面出现阴极弧斑。高温弧斑使靶材蒸发，由于弧斑区域存在非常稠密的等离子体，这将导致蒸发物质高度离化，其离化率达到60%~90%（这是多弧离子镀的最大优点）。靶材离子在工件偏压的作用下，沉积在工件表面上形成涂层。

The cathode spots make the appearance by the arc discharge in high vacuum, with extreme high temperature of which, the target material is evaporated, forming dense plasma around the spots. The ionization degree may reach to 60%~90%. Ions from target is deposited on the surface of work piece via imposed bias voltage.

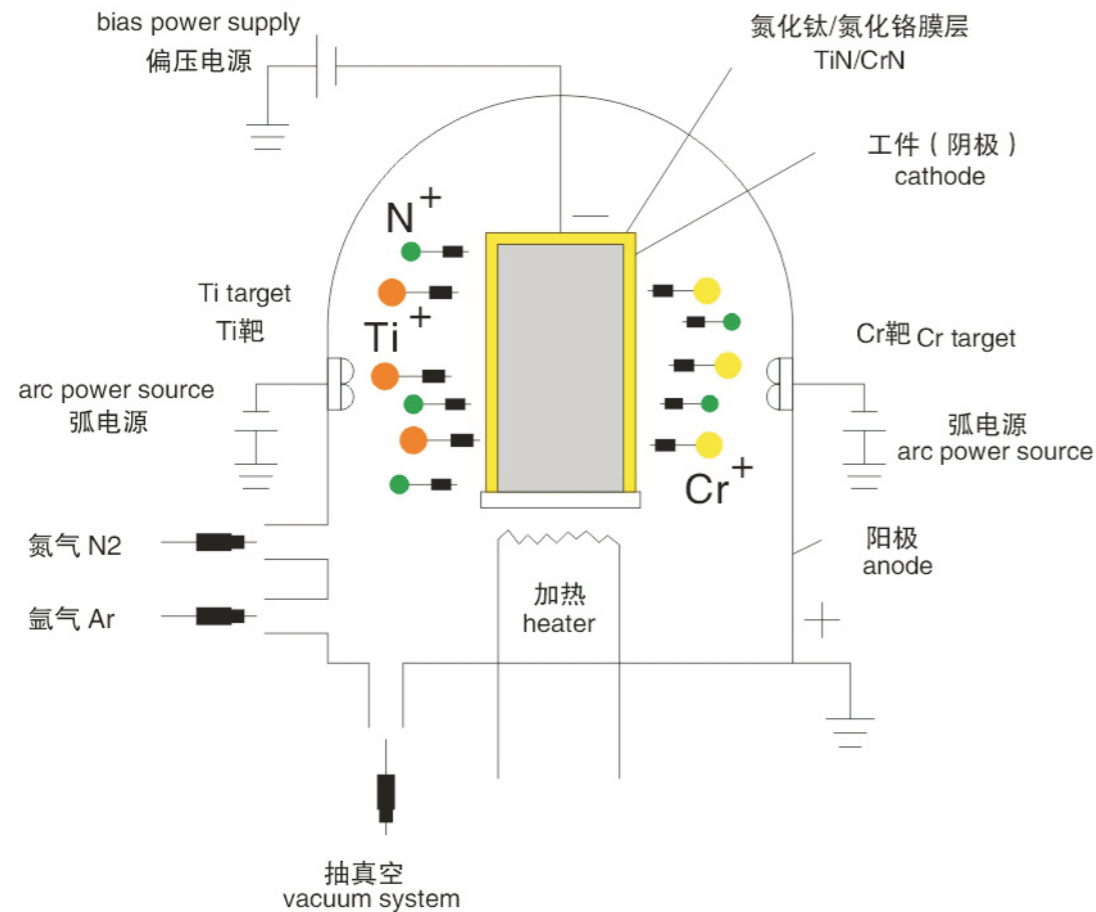
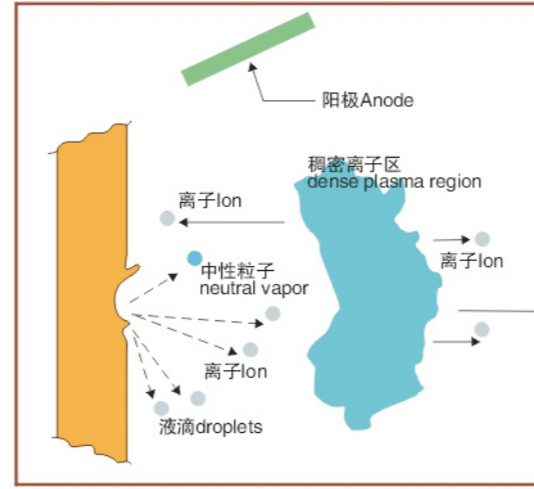

## 真空镀膜技术通用术语

### 一、一般术语

- 真空镀膜 vacuum coating: 在处于真空下的基片上制取膜层的一种方法。
- 基片 substrate: 膜层承受体。
- 试验基片 testing substrate: 在镀膜开始、镀膜过程中或镀膜结束后用作测量和（或）试验的基片。
- 镀膜材料 coating material: 用来制取膜层的原材料。
- 蒸发材料 evaporation material: 在真空蒸发中用来蒸发的镀膜材料。
- 溅射材料 sputtering material: 有真空溅射中用来溅射的镀膜材料。
- 膜层材料(膜层材质) film material: 组成膜层的材料。
- 蒸发速率 evaporation rate: 在给定时间间隔内,蒸发出来的材料量,除以该时间间隔。
- 溅射速率 sputtering rate: 在给定时间间隔内,溅射出来的材料量,除以该时间间隔。
- 沉积速率 deposition rate: 在给定时间间隔内,沉积在基片上的材料量,除以该时间间隔和基片表面积。
- 镀膜角度 coating angle: 入射到基片上的粒子方向与被镀表面法线之间的夹角。

### 二、专用部件

- 镀膜室 coating chamber: 真空镀膜设备中实施实际镀膜过程的部件
- 蒸发器装置 evaporator device: 真空镀膜设备中包括蒸发器和全部为其工作所需要的装置(例如电能供给、送料和冷却装置等)在内的部件。
- 蒸发器 evaporator: 蒸发直接在其内进行蒸发的装置,例如小舟形蒸发器,坩埚,灯丝,加热板,加热棒,螺旋线圈等等,必要时还包括蒸发材料本身。
- 直接加热式蒸发器 evaporator by direct heat: 蒸发材料本身被加热的蒸发器。
- 间接加热式蒸发器 evaporator by indirect heat: 蒸发材料通过热传导或热辐射被加热的蒸发器。
- 蒸发场 evaporation field: 由数个排列的蒸发器加热相同蒸发材料形成的场。
- 溅射装置 sputtering device: 包括靶和溅射所必要的辅助装置(例如供电装置,气体导入装置等)在内的真空溅射设备的部件。
- 靶 target: 用粒子轰击的面。本标准中靶的意义就是溅射装置中由溅射材料所组成的电极。
- 挡板 shutter: 用来在时间和(或)空间上限制镀膜并借此能达到一定膜厚分布的装置。挡板可以是固定的也可以是活动的。
- 时控挡板 timing shutter: 在时间上能用来限制镀膜,因此从镀膜的开始、中断到结束都能按规定时刻进行的装置。
- 掩膜 mask: 用来遮盖部分基片,在空间上能限制镀膜的装置。
- 基片支架 substrate holder: 可直接夹持基片的装置,例如夹持装置,框架和类似的夹持器具。
- 夹紧装置 clamp: 在镀膜设备中用或不用基片支架支撑一个基片或几个基片的装置,例如夹盘,夹鼓,球形夹罩,夹篮等。夹紧装置可以是固定的或活动的(旋转架,行星齿轮系等)。
- 换向装置 reversing device: 在真空镀膜设备中,不打开设备能将基片、试验玻璃或掩膜放到理想位置上的装置(基片换向器,试验玻璃换向器,掩膜换向器)。
- 基片加热装置 substrate heating device: 在真空镀膜设备中,通过加热能使一个基片或几个基片达到理想温度的装置。
- 基片冷却装置 substrate cooling device: 在真空镀膜设备中,通过冷却能使一个基片或几个基片达到理想温度的装置。

### 三、真空镀膜设备

- 真空镀膜设备 vacuum coating plant: 在真空状态下制取膜层的设备。
- 真空蒸发镀膜设备 vacuum evaporation coating plant: 借助于蒸发进行真空镀膜的装置。
- 真空溅射镀膜设备 vacuum sputtering coating plant: 借助于真空溅射进行真空镀膜的装置。
- 连续镀膜设备 continuous coating plant: 被镀膜物件(单件或带材)连续地从大气压经过压力梯段进入到一个或数个镀膜室,再经过相应的压力梯段,继续离开设备的连续式镀膜设备。
- 半连续镀膜设备 semi-continuous coating plant: 被镀膜物件通过闸门送进镀膜室并从镀膜室取出的真空镀膜设备。

**CICEL**  
驰诚真空



专注真空镀膜机械  
UV涂装流水线制造 49  
[www.ccvacuum.com](http://www.ccvacuum.com)

FOCUS ON VACUUM COATER  
& UV SPRAY LINE 50  
[www.ccvacuum.com](http://www.ccvacuum.com)