



MAKING YOUR JOB MORE ENJOYABLE

Global Link

ONE COUNTRY ONE AGENT

A SUPPLIER FOR FORTUNE 500 COMPANY



DAJ
TAIZHOU DAJIANG IND.CO.,LTD.
Add: Machinery & Electronics Zone of Ind. City, Wenling, Zhejiang Prov., 317500,P.R.China
Tel: 400-672-7388
Email: daj@chinaairtool.com
Web: www.chinaairtool.com

GLOBAL LINK NEW ENERGY TECHNOLOGY (THAILAND) CO., LTD.

Add: located at No. 18/81, Village 8, Khao Klang Song Sub-district, Banglamung District, Rayong Province, Thailand (Postal Code: 20110)



PRIME GLOBAL PRODUCTS,INC.

Add: 2220 Airport Industrial Drive, Suite 100 Ball Ground, GA 30107
Tel: 1-888-669-5672
Web: www.freemantool.com

Global Link
GLOBAL LINK (SHANGHAI) CO.,LTD.

Add: Unit 1003, 5 Building, No.968 Jinzhong Road, Changning District, Shanghai 200335

Tel: 021-60318821
Email: info@globallinktool.com

2025-V1





A SUPPLIER FOR FORTUNE 500 COMPANY

国家知识产权优势企业
全球500强合作企业/国家行业协会团体标准主起草单位
国家高新技术企业/央视CCTV报道企业

在亚马逊网站十大用户好评产品评比中，FREEMAN和NUMAX多款产品名列前十！

美国专业的钉枪网站nailgun钉枪排名评选中，FREEMAN和NUMAX有3款地板枪上榜,1款掌中锤上榜,65卷钉枪上榜。

The 10 Best Framing Nailer Nails 亚马逊前十钉枪排行榜

Rank	Manufacturer	Product Name	Score
1	Freeman	Freeman FR2190 21-Degree Full-Head Framing Nailer Ergonomic & S/Nailer	9.7
2	NUMAX	NUMAX SP2190 21 Degree Framing Nailer S/Nailer	9.6

FREEMAN Floor Nailers gets good reviews from users. FREEMAN地板枪深受用户好评

The 10 Best Freeman Floor Nailers

Rank	Manufacturer	Product Name	Score
1	Freeman	Freeman P28MTCX Flooring Nailer Kit with Oscillating Tool S/Nailer	9.9
2	Freeman	Freeman P2PR14 Professional Pneumatic Flooring Kit S/Nailer	9.4
3	Freeman	Freeman PD300C 3-in-1 Flooring Nail Gun and Stapler S/Nailer	9.2
4	Freeman	Freeman P2PR12 2-Piece Professional Flooring Combo Kit S/Nailer	9.0
5	Freeman	Freeman PD1888 3-in-1 Pneumatic Flooring Nailer S/Nailer	8.6



Best Flooring Nailer Comparison Chart

Model	Weight	Stroke	Stroke Rate	Stroke Length	Stroke Angle
Freeman FR2190	10.5 lbs	1.1 in	1000	1.1 in	21°
Freeman FR2190	10.5 lbs	1.1 in	1000	1.1 in	21°
Freeman FR2190	10.5 lbs	1.1 in	1000	1.1 in	21°
Freeman FR2190	10.5 lbs	1.1 in	1000	1.1 in	21°



Best Palm Nailer Comparison Chart

Model	Weight	Stroke	Stroke Rate	Stroke Length	Stroke Angle
Freeman P2PR14	3.5 lbs	0.7 in	1000	0.7 in	14°
Freeman P2PR14	3.5 lbs	0.7 in	1000	0.7 in	14°
Freeman P2PR14	3.5 lbs	0.7 in	1000	0.7 in	14°
Freeman P2PR14	3.5 lbs	0.7 in	1000	0.7 in	14°

与全球知名品牌(牧田、日立、得伟等)共列亚马逊钉枪排行榜前十
被评为Youtube排名前十钉枪之一



Founded In North America, A Supplier For Fortune 500 Company

深耕北美市场，是世界五百强企业的直接供应商



Products are certified with UL,ETL in America, have passed GS, CE safety certification

通过UL、ETL、GS、CE等多项国际安全认证



ITS

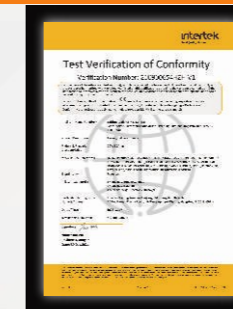

CE



ETL



TUV



浙江制造认证

Granted 20 international invention patents, 70 invention patents and 100 utility patents with China National Intelligent Properties

拥有20余项国际发明专利、申请及获证国内发明专利70余项及100余项实用新型专利

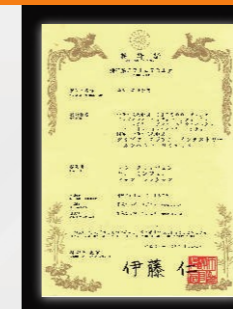
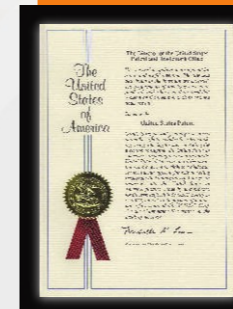

FREEMAN are popular in the US, Australia, Canada, New Zealand, Spain, Portugal, Japan, South Korea, and regions like Hong Kong and Taiwan.

FREEMAN 产品畅销于美国、澳大利亚、加拿大、新西兰、西班牙、葡萄牙、日本、韩国等国家以及香港、台湾等地区



DAJ'S SUBSIDIARY

大江旗下公司



USA/美国: PRIME GLOBAL PRODUCTS, INC.



SHANGHAI/上海: 世链国际贸易(上海)有限公司
GLOBAL LINK (SHANGHAI) CO., LTD.



ZHEJIANG/浙江: 台州市大江实业有限公司
TAIZHOU DAJIANG IND. CO., LTD.



WINLING/温岭: 世链(温岭)新能源科技有限公司



泰国/TH

澳洲/AUS



国家高新技术企业、国家知识产权优势企业

TEST EQUIPMENT



Battery Pack Comprehensive Testing Platform
电池包综合测试
(全方位检测电池包综合性能)



Battery Pack Lifecycle Testing Machine
电池包寿命循环测试
(针对电池包寿命进行测试)



Temp and Humidity Testing Chamber
高低温交变温湿测试

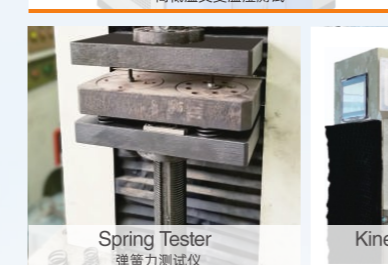

Spring Tester
弹簧力测试仪
(研发中测试弹簧性能)



3-Axial Tester
三坐标测试仪



Optical Spectrum Analyzer
光谱分析仪

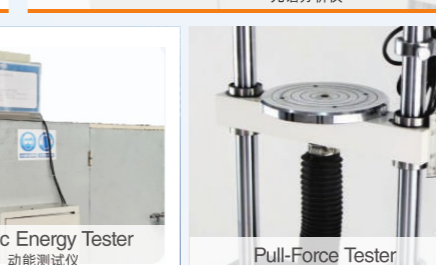

Kinetic Energy Tester
动能测试仪
(研发中测试产品动能)

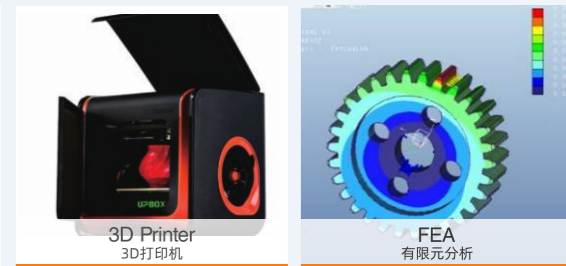

3D Printer
3D打印机

FEA
有限元分析



Auto Dry Firing Testing Platform
全自动智能打钉测试台
(每一款产品都需要经过严格的寿命、品质、性能等测试)

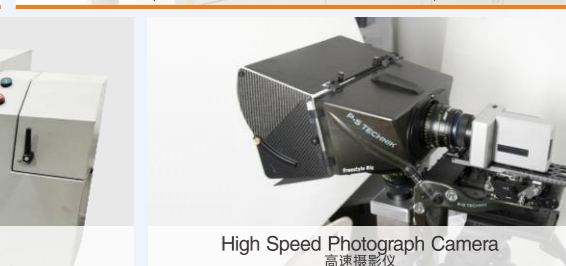

High Speed Photograph Camera
高速摄影仪

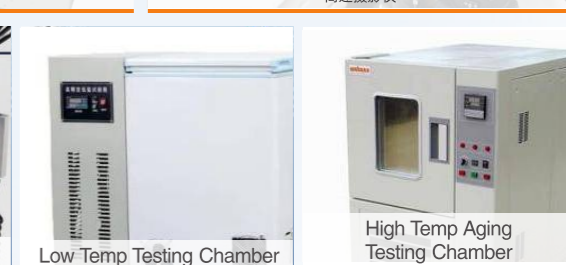

Low Temp Testing Chamber
低温测试仪

High Temp Aging Testing Chamber
高温老化测试仪



ONE BATTERY, MULTIPLE TOOLS

一块电池 多机共享

FREEMAN F20 Platform consists of multiple power tools, lithium-ion battery pack and quick charger for maximum versatility and efficiency.

20V 锂电平台是由锂电工具、电池和充电器构成。快充锂电芯搭配高性能锂电工具，为用户提供高效稳定的解决方案。

INTELLIGENT POWER SUPPLY

智能供电系统

FREEMAN Tools and battery integrated control chips for dual communication and maximum efficiency during operation.

锂电池和工具分别搭载内置芯片，用户使用时电池和工具之间双向通信，达到低能耗高效率的工作状态。

INTELLIGENT CHARGING SYSTEM

智能充电系统

FREEMAN Quick charger equipped with controlling chip for dual communication during charging process. Maintain the longevity of battery life as well as fast charging speed.

充电器同样搭载内置芯片，充电时充电器和电池之间双向通信，主动控制温度、电压和电流，在快速充电的同时，延长电池使用寿命。

Quick Charge High Efficiency
快充电池 效率更高

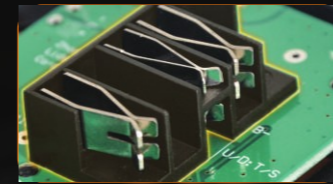

Anti-short Terminals
端子防短路结构
Insulation between each terminal for maximum protection
端子之间设有防尘防短路保护墙



Battery Level Indicator
电池电量指示灯



USB Port
USB接口



TYPE-C Port
Type-c 接口
Fast Charging
快速充电

长续航 安全耐用 多重智能保护系统

LONG BATTERY DURATION SAFETY INSURANCE

INTELLIGENT CONTROL

智能控制



Overcurrent Protection
过流保护

Overvoltage Protection
欠压保护

Overheating Protection
过热保护

Overcharge Protection
过充保护



Rubber Mat
减震防滑橡胶垫
Rubber grip comfortable for use
兼具跌落缓冲和防滑功能



F211A1CC
1A插孔充电器
1A Wall Charger

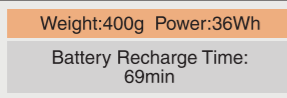

F2123A1CZ
2.3A快充充电器
2.3A Quick Charger



F213A1CZK
3A快充充电器
3A Quick Charger



F2020BK
20V 2.0Ah Battery
Weight:400g Power:36Wh
Battery Recharge Time: 140min

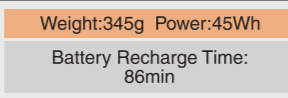

F2025BK
20V 2.5Ah Battery
Weight:345g Power:45Wh
Battery Recharge Time: 86min

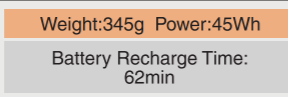

F2040BK
20V 4.0Ah Battery
Weight:600g Power:72Wh
Battery Recharge Time: 62min



F2040BK
20V 4.0Ah Battery
Weight:600g Power:72Wh
Battery Recharge Time: 173min

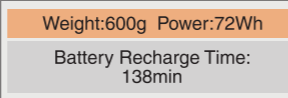

F2050BK
20V 5.0Ah Battery
Weight:666g Power:90Wh
Battery Recharge Time: 86min

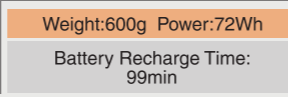

F2060B
20V 6.0Ah Battery
Weight:865g Power:108Wh
Battery Recharge Time: 138min



F2060B
20V 6.0Ah Battery
Weight:865g Power:108Wh
Battery Recharge Time: 172min

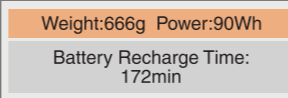

F2075B
20V 7.5Ah Battery
Weight:865g Power:135Wh
Battery Recharge Time: 172min



F2075B
20V 7.5Ah Battery
Weight:865g Power:135Wh
Battery Recharge Time: 185min



F2060B
20V 6.0Ah Battery
Weight:865g Power:108Wh
Battery Recharge Time: 207min

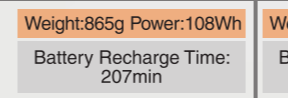

F2075B
20V 7.5Ah Battery
Weight:865g Power:135Wh
Battery Recharge Time: 259min

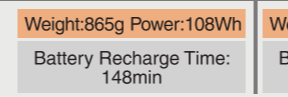

F2060B
20V 6.0Ah Battery
Weight:865g Power:108Wh
Battery Recharge Time: 148min



F2075B
20V 7.5Ah Battery
Weight:865g Power:135Wh
Battery Recharge Time: 185min

BATTERY PLATFORM ADAPTER

电池平台转换器系列



dewalt



Makita



DEVON



AC/DC POWER CONVERTER

Input Voltage	110~220V
Output Voltage	20V

CORDLESS TOOLS





HAND TOOLS AIR TOOLS

Air Nailer
气动钉枪



Framing Nailer
斜钉枪



Air Nailer
气动钉枪



Tire Inflator With Gauge
胎压枪



Air Hammer
气锤

Air Impact Wrench
气动扳手



HAND TOOLS



Hand Tools
手动工具



Air Angle Die Grinder
角向磨光机

Air Die Grinder
气磨



Air Ratchet Wrench
棘轮扳手

Air Angle Grinder
角向磨光机



Fittings
配件

Flooring Nailer
地板枪



Nailer
钉枪



CONTENTS 目录

STEEL NAIL SERIES

CONCRETE NAILER SERIES

钢钉枪系列 **01~09**

LA65 / LD40 / FM40 / LDST64 / FMST64 / LDST18 / LDFST50 / LDPW75 / FMPW75 / XIPW38

INSULATION NAILER SERIES

保温枪系列 **10~14**

LABW120 / LABW150 / LABW200 / LDBW120 / LDBW150 / LDBW200 / FMBW120

FENCING STAPLER SERIES

篱笆枪系列 **15~20**

LA400 / LD400 / FM400 / LA315 / LD315 / FM315 / LDFS16G / FS16G / FS18G

CARPENTRY SERIES

FRAMING NAILER SERIES

斜钉枪系列 **31~40**

La34100 / LD3490 / LA3490 / LD3490 / FM3490 / FM3483 / LA2190 / LD2190 / FM2190 / FM2183 / LA2190D / LD2190D / LA64MCN / XR250S

NAILER & STAPLER SERIES

直钉枪 & 码钉枪系列 **41~63**

LA1564 / FM1564 / LAT64 / LDT64 / T64 / LAT50 / LDT50 / LD504050 / XAGD509040T50 / FM504050 / YF504050P / LDAF30 / AF30 / LAF50 / LDF50 / FMF50 / F50 / LD3232 / LD32425J / LD3838 / LD509040 / XAGD509040 / LD635 / P635 / P625 / P650 / LD1013J / 1013J / LD1022J / LD8016 / 8016 / LDT15 / LD9040 / 7116 / FM9040 / 9040 / 9032 / FMN851

AIR COMPRESSOR SERIES

空压机系列 **21~25**

LK10L / LK6L / FCCZKTIO1 / LK4L / PSC15G / TA3GCOMP / PC6G

FITTINGS

配件 **26~28**

LITHIUM-ION TOOLS SERIES

锂电工具系列 **29~30**

COIL NAILER SERIES

卷钉枪系列 **64~68**

FMCN90 / FMCN75 / FMCN65 / FMCN45 / CN65 / CN50 / CN45

SPECIALTY NAILER SERIES

特种钉枪系列 **69~73**

LDC24 / LDC24E / LDC17 / C20 / PF20LM / FW / FM45L / PDX50Q / DPN350S / DPN50LT / PWC200 / CS16 / KBD50



CONCRETE NAILER SERIES

钢钉枪系列

LA65 / LD40 / FM40 / LDST64 / FMST64 / LDST18 / LDFST50 / LDPW75 / FMPW75 / XIPW38

NEW

BL LA65
AI智能锂电钢钉枪
AI CORDLESS
CONCRETE NAILER

[Battery Concrete Nailer]

PATENT
专利技术

仅 **3.6KG**

Compared with
Leading Competitor **4.2KG**
对标国际品牌约 **4.2KG**
重量接近瓦斯枪，比瓦斯枪更省钱



Applications / 应用

- Plumbing Work
水暖、管道安装
- Fastening Sheet Iron To Concrete Or Brick Wall
铁板和混凝土或砖墙固定
- For Installation of Doors, Windows, and Partitions
门窗、隔断制作安装

- Extended Nozzle
长枪嘴
- Adjustable Depth
可调深设计
- Quick-change Nozzle
快速更换功能头

Standard 射钉头	Universal 万用头	Pipe Strap Clamp 骑马卡头	Magnet Pipe Clamp Holder 磁吸吊卡头	Cable Wire Clip 钉卡头
Concrete Nail 特钢钉头	M6 Concrete Nail w/ Threads M6螺纹钉头	M8 Concrete Nail w/ Threads M8螺纹钉头	Threaded Stud 螺纹铆钉头	

Product Specification / 产品参数		LA65
Nail Range/Shank Range/ 钉子规格	16~40mm, φ2.7~3.0mm	
Motor/电机	Brushless	
Magazine Capacity/ 装钉数量	30pcs	
Strike Rate/ 打钉速率	60~90 nails/min (钉/分钟)	
Battery Duration/ 续航能力	Nails per charge up to 750 pcs(4.0Ah)(115PSI) Nails per charge up to 950 pcs(4.0Ah)(100PSI) 满电打钉数约750枚(4.0Ah)(8公斤) 满电打钉数约950枚(4.0Ah)(7公斤)	
Dimension (w/o battery)/ 产品尺寸(不含电池)	394x386x116mm	
Weight (w/o battery)/ 产品重量(不含电池)	3.6kg	



Artificial Intelligence

AI人机交互



OPTION 选配



IoT Monitoring
物联网监控



Error Code Display
故障代码显示



Pressure Monitoring
压力检测



Overheating / Overcurrent /
Over Discharge Protection
过热过流过放保护 ...



Soft Touch Mechanism

软撞击专利技术



PATENT
专利技术

- Professional "Soft Touch" Mechanism,
Doubles Blade Life
- Upgraded S7 Steel Blade
- 软撞击专利技术，撞针寿命提升约2倍
- 全新升级，撞针采用进口S7材料



Convenient Maintenance, Easy Replacement
维护方便，易损件轻松更换/清洗



Powerful, With Strength Adjustable
力量大，打钉力度可调节



PATENT
专利技术

- Remove 4 Screws, Replace Blade Easily
Unlike Competitors, No Factory Repair Needed
- 仅需拆卸4颗螺丝，轻松更换撞针
对比竞品，无需返厂维修



- Factory-Preset Power, Exceeds 40mm Gas Nailer
- Adjust to 1.1 Mpa: Matches 65mm Gas Nailer
- 120J Power, Outperforms Competitors' 95J
- 出厂能量即远高于40瓦斯枪
- 气压调至11公斤，相当于65瓦斯枪能量
- 能量高达120J，对比竞品约95J

BL 无刷电机
MOTOR

LD40
CORDLESS
CONCRETE NAILER
锂电40钢钉枪

PATENT
专利技术

Power Adjustable
力度可调节系统

Convenient Maintenance
撞针快换

Large Capacity
Die-cast Air Cylinder
大容量压铸回气室

Soft Touch Mechanism
软撞击专利技术

Ergonomic Handle
人机工程学柄

Intelligent Control
AI智能控制

Anodized Magazine
硬质氧化枪夹

Applications / 应用

- Plumbing Work
水暖、管道安装
- Fastening Sheet Iron To Concrete Or Brick Wall
铁板和混凝土或砖墙固定
- For Installation of Doors, Windows, and Partitions
门窗、隔断制作安装

Standard	Universal	Pipe Strap Clamp	Magnet Pipe Clamp Holder	Cable Wire Clip	Concrete Nail	M6 Concrete Nail w/ Threads	M8 Concrete Nail w/ Threads	Threaded Stud
射钉头	万用头	骑马卡头	磁吸吊卡头	钉卡头	特钢钉头	M6螺纹钉头	M8螺纹钉头	螺纹铆钉头



Adjustable Depth
可调深设计

Quick-change Nozzle
快速更换功能头

Product Specification / 产品参数		LD40
Nail Range/Shank Range/钉子规格		16~40mm, ϕ 2.7~3.0mm
Magazine Capacity/装钉数量		30pcs
Strike Rate/打钉速率		60~90 nails/min (钉/分钟)
Battery Duration/续航能力		Nails per charge up to 750 pcs(4.0Ah)(100Psi) Nails per charge up to 950 pcs(4.0Ah)(85Psi) 满电打钉数约750枚(4.0Ah)(7公斤) 满电打钉数约950枚(4.0Ah)(6公斤)
Dimension (w/o battery)/产品尺寸(不含电池)		394x386x116mm
Weight (w/o battery)/产品重量(不含电池)		4.1kg

FM40
CONCRETE NAILER
气动40钢钉枪

NEW

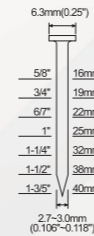

Product Specification / 产品参数		FM40
Dimension/产品尺寸		432X375X113mm
Weight/产品重量		3.55Kg

STRIP CONCRETE PIN

For Doors, Windows And
Compartments Installation
门窗、隔断制作安装

Fastening Sheet Iron To
Concrete Or Brick Wall
铁板和混凝土或砖墙固定



PIPE CLAMP



U型迫码卡:16/20/25/32/40/50 拼装迫码卡:16/20/25/32/40/50 连排迫码卡:16/20/25/32/40/50

PIPE STRAP CLAMP

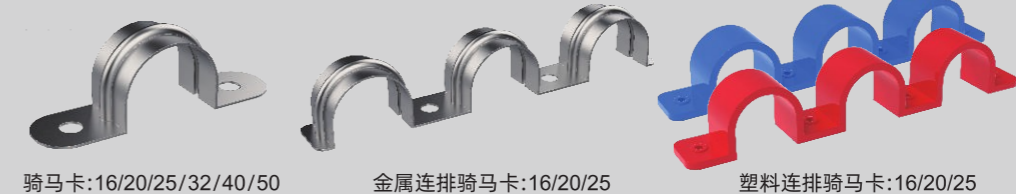

骑马卡:16/20/25/32/40/50 金属连排骑马卡:16/20/25 塑料连排骑马卡:16/20/25

CABLE WIRE CLIP



单钉卡:16/20/25/32 单钉卡:32/40 单钉卡:16/20/25/32

MAGNET PIPE CLAMP



LDST64 **BL** CORDLESS HEAVY DUTY CONCRETE NAILER 锂电ST64钢钉枪

- ▶ **PENETRATES UP TO 24MM CEMENT SHEET.**
轻松入水泥墙24mm以上



Soft Touch Mechanism
软撞击结构



Quick Repair
维修便携



Strength Adjustable
力度可调

Applications / 应用

- ▶ **Joining Wood Strips**
横梁连接
- ▶ **Wood To Concrete**
木板与混凝土连接

Product Specification / 产品参数		LDST64
Nail Range/Shank Range/钉子规格		18-64mm, ϕ 2.2mm
Magazine Capacity/装钉数量		80pcs
Strike Rate/打钉速率		60-90 nails/min (钉/分钟)
Power/动能		80J
Dimension (w/o battery)/产品尺寸(不含电池)		386x115x395mm
Weight (w/o battery)/产品重量(不含电池)		4.4kg



专利技术

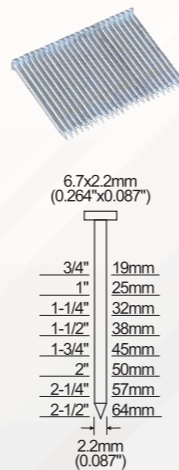

LDST18 **BL** CORDLESS CONCRETE NAILER 锂电ST18钢钉枪

- ▶ **PENETRATES UP TO 10MM CEMENT SHEET**
轻松入水泥墙10mm以上



Applications / 应用

- ▶ **Foot Line**
踢脚线
- ▶ **Aluminum Window**
铝合金窗
- ▶ **Aluminum Alloy Trunking**
铝合金线槽

Product Specification / 产品参数		LDST18
Nail Range/Shank Range/钉子规格		18mm, ϕ 2.2mm
Magazine Capacity/装钉数量		50pcs
Strike Rate/打钉速率		90-120 nails/min (钉/分钟)
Dimension (w/o battery)/产品尺寸(不含电池)		308x279x113mm
Weight (w/o battery)/产品重量(不含电池)		3.12kg



专利技术

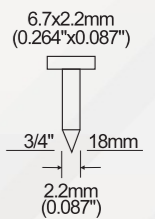

FMST64 14 GA. 2-1/2" HEAVY DUTY CONCRETE NAILER 气动ST64钢钉枪

- ▶ **PENETRATES UP TO 25MM CEMENT SHEET**
轻松入水泥墙25mm以上



Applications / 应用

- ▶ **Joining Wood Strips**
横梁连接
- ▶ **Wood To Cement**
木板与水泥连接

Product Specification / 产品参数		FMST64
Nail Range/Shank Range/钉子规格		18-64mm, ϕ 2.5mm
Operating Pressure/工作气压		70-115psi(5-8Bar)
Magazine Capacity/装钉量		100pcs
Air Consumption/耗气量		5.4L/S
Strike Rate/打钉速率		2 nails/sec
Dimension/产品尺寸		344x108x311mm
Weight/产品重量		2.8kg



专利技术

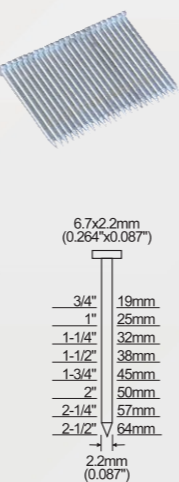

LDFST50 **BL** CORDLESS CONCRETE T NAILER 锂电黑钢钉枪

- ▶ **SPECIAL FOR ϕ 1.8MM BLACK CONCRETE NAIL**
1.8mm黑钢钉专用



Applications / 应用

- ▶ **Baseboard Installation & Fastening Iron**
踢脚线安装薄铁片与水泥、木头连接
- ▶ **Aluminium Sheet to Concrete/Wood**
薄铝皮与水泥、木头连接

Product Specification / 产品参数		LDFST50
Nail Range/Shank Range/钉子规格		18-50mm, ϕ 1.8mm
Magazine Capacity/装钉数量		120pcs
Strike Rate/打钉速率		90-120 nails/min (钉/分钟)
Dimension (w/o battery)/产品尺寸(不含电池)		329x325x113mm
Weight (w/o battery)/产品重量(不含电池)		3.1kg



专利技术

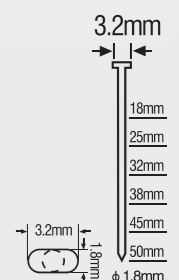

LDPW75 **BL** CORDLESS SINGLE PIN CONCRETE NAILER

锂电单颗钢钉枪

› **NAIL SIZE UP TO 75MM**

可打75mm单颗钢钉



Soft Touch Mechanism
软撞击结构



Quick Repair
维修便携



Strength Adjustable
力度可调

Applications / 应用

- › For Doors, Windows And Compartments Installation
门窗、隔断制作安装
- › Wood To Concrete
木板与混凝土连接

Product Specification / 产品参数	LDPW75
Nail Range/Shank Range/钉子规格	19-75mm, φ 3.7mm
Magazine Capacity/装钉数量	1pcs
Power/动能	100-120J
Dimension (w/o battery)/产品尺寸(不含电池)	394x311x116mm
Weight (w/o battery)/产品重量(不含电池)	3.74kg



XIPW38 SINGLE PIN CONCRETE NAILER

气动单颗钢钉枪

Applications / 应用

- › For Doors, Windows And Compartments Installation
门窗、隔断制作安装
- › Wood To Concrete
木板与混凝土连接

Product Specification / 产品参数	XIPW38
Nail Range/Shank Range/钉子规格	16-38mm(5/8"-1-1/2")
Magazine Capacity/装钉数量	1pcs
Operating Pressure/工作气压	5-8bar(70-115psi)
Dimension/产品尺寸	382x113x366mm
Weight/产品重量	2.82Kg



FMPW75 SINGLE PIN CONCRETE NAILER

气动单颗钢钉枪



ONLY
2.46KG

Product Specification / 产品参数	FMPW75
Nail Range/Shank Range/钉子规格	19-75mm, φ 3.7mm
Magazine Capacity/装钉数量	1pcs
Operating Pressure/工作气压	70-115psi(5-8Bar)
Dimension/产品尺寸	345X110X351mm
Weight/产品重量	2.46kg

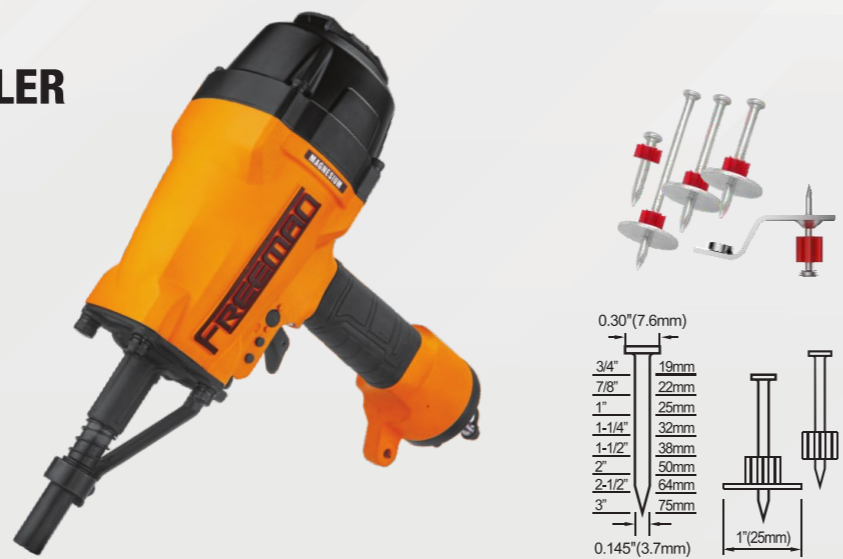

CONCRETE T NAIL

- › Baseboard Installation & Fastening Iron
踢脚线安装薄铁片与水泥、木头连接
- › Aluminium Sheet to Concrete/Wood
薄铝皮与水泥、木头连接



SINGLE PIN CONCRETE NAIL

- › For Doors, Windows And Compartments Installation
门窗、隔断制作安装
- › Wood To Concrete
木板与混凝土连接



CONCRETE NAIL

- › Joining Wood Strips
横梁连接
- › Wood To Concrete
木板与混凝土连接

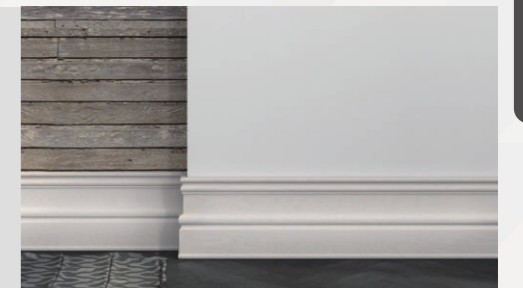



LABW150 BL
AI CORDLESS
150 INSULATION NAILER
 AI智能锂电150保温枪

NEW

PATENT
 专利技术

仅 **3.4KG**



Artificial Intelligence
 AI人机交互



Soft Touch Mechanism
 软撞击结构



Quick Repair
 维修便捷



Strength Adjustable
 力度可调



Applications / 应用

For Fastening Insulation Materials Like Stone Wool, Foam To Concrete, Brick, Steel, Etc.
 用于将保温材料(如石棉、泡沫)固定在混凝土、砖、钢等材料上。

Product Specification / 产品参数	LABW150
Nail Range/Shank Range/钉子规格	20-150mm, Ø49mm
Magazine Capacity/装钉数量	1 pcs
Kinetic Energy/动能	MAX. 120J
Battery Duration/续航能力	up to 650 pcs(4.0Ah)
Dimension (w/o battery)/产品尺寸(不含电池)	475X110X267mm
Weight (w/o battery)/产品重量(不含电池)	3.37kg

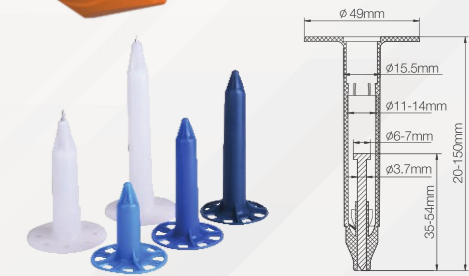

STEEL NAIL SERIES



ARTIFICIAL INTELLIGENCE
 AI人机交互

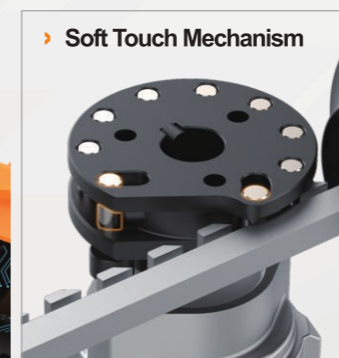

EXTENDED TOOL LIFE
 双活齿专业技术

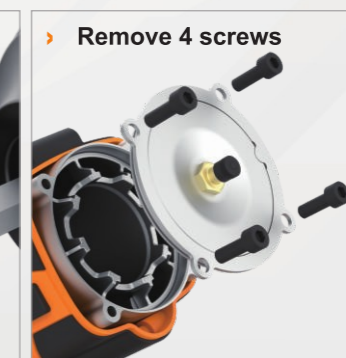

EASY REPLACEMENT
 维修方便

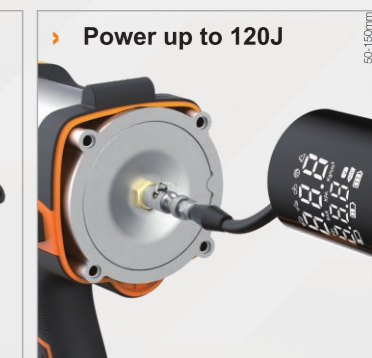

STRENGTH ADJUSTABLE
 力度可调

INSULATION NAILER SERIES

保温枪系列

LABW120 / LABW150 / LABW200 / LDBW120 / LDBW150 / LDBW200 / FMBW120



LABW120 **BL** AI CORDLESS 120 INSULATION NAILER AI智能锂电120保温枪

- Artificial Intelligence
AI人机交互
- Soft Touch Mechanism
软撞击结构
- Quick Repair
维修便携
- Strength Adjustable
力度可调

Applications / 应用

For Fastening Insulation Materials Like Stone Wool, Foam To Concrete, Brick, Steel, Etc.
用于将保温材料(如石棉、泡沫)固定在混凝土、砖、钢等材料上。

Product Specification / 产品参数		LABW120
Nail Range/Shank Range/钉子规格		20-120mm, Ø49mm
Magazine Capacity/装钉数量		1 pcs
Kinetic Energy/动能		MAX. 120J
Battery Duration/续航能力		up to 650 pcs(4.0Ah)
Dimension (w/o battery)/产品尺寸(不含电池)		445X110X267mm
Weight (w/o battery)/产品重量(不含电池)		3.37kg



NEW

PATENT
专利技术

仅 **3.37KG**

LABW200 **BL** AI CORDLESS 200 INSULATION NAILER AI智能锂电200保温枪

- Artificial Intelligence
AI人机交互
- Soft Touch Mechanism
软撞击结构
- Quick Repair
维修便携
- Strength Adjustable
力度可调

Applications / 应用

For Fastening Insulation Materials Like Stone Wool, Foam To Concrete, Brick, Steel, Etc.
用于将保温材料(如石棉、泡沫)固定在混凝土、砖、钢等材料上。

Product Specification / 产品参数		LABW200
Nail Range/Shank Range/钉子规格		20-200mm, Ø49mm
Magazine Capacity/装钉数量		1 pcs
Kinetic Energy/动能		MAX. 120J
Battery Duration/续航能力		Up to 650 pcs(4.0Ah)
Dimension (w/o battery)/产品尺寸(不含电池)		525X110X267mm
Weight (w/o battery)/产品重量(不含电池)		3.45kg



NEW

PATENT
专利技术

仅 **3.45KG**

LDBW120 **BL** CORDLESS 120 INSULATION NAILER 锂电120保温枪

- Soft Touch Mechanism
软撞击结构
- Quick Repair
维修便携
- Strength Adjustable
力度可调

Product Specification / 产品参数		LDBW120
Nail Range/Shank Range/钉子规格		20-120mm, Ø49mm
Magazine Capacity/装钉数量		1 pcs
Kinetic Energy/动能		110-120J
Battery Duration/续航能力		Up to 600 pcs(4.0Ah)
Dimension (w/o battery)/产品尺寸(不含电池)		465x115x298mm
Weight (w/o battery)/产品重量(不含电池)		4.0kg



NEW

PATENT
专利技术

LDBW150 **BL** CORDLESS 150 INSULATION NAILER 锂电150保温枪

- Soft Touch Mechanism
软撞击结构
- Quick Repair
维修便携
- Strength Adjustable
力度可调

Product Specification / 产品参数		LDBW150
Nail Range/Shank Range/钉子规格		20-150mm, Ø49mm
Magazine Capacity/装钉数量		1 pcs
Kinetic Energy/动能		110-120J
Battery Duration/续航能力		Up to 600 pcs(4.0Ah)
Dimension (w/o battery)/产品尺寸(不含电池)		495x115x298mm
Weight (w/o battery)/产品重量(不含电池)		4.03kg



NEW

PATENT
专利技术

LDBW200 **BL** CORDLESS 200 INSULATION NAILER 锂电200保温枪

- Soft Touch Mechanism
软撞击结构
- Quick Repair
维修便携
- Strength Adjustable
力度可调

Product Specification / 产品参数		LDBW200
Nail Range/Shank Range/钉子规格		20-200mm, Ø49mm
Magazine Capacity/装钉数量		1 pcs
Kinetic Energy/动能		110-120J
Battery Duration/续航能力		Up to 600 pcs(4.0Ah)
Dimension (w/o battery)/产品尺寸(不含电池)		545x115x298mm
Weight (w/o battery)/产品重量(不含电池)		4.08kg



NEW

PATENT
专利技术

FMBW120 INSULATION NAILER 气动保温枪

► **PENETRATES UP TO 20MM
CEMENT SHEET**
轻松入水泥墙20mm以上



Applications / 应用

► For Fastening Insulation Materials Like Stone Wool, Foam To Concrete, Brick, Steel, Etc.
用于将保温材料(如石棉、泡沫)固定在混凝土、砖、钢等材料上。

Product Specification / 产品参数	FMBW120
Nail Range/Shank Range/钉子规格	50-120mm, Ø49mm
Operating Pressure/工作气压	90-115psi(6-8Bar)
Magazine Capacity/装钉量	1pcs
Dimension/产品尺寸	390x109x356mm
Weight/产品重量	2.4kg

20-120mm

Suitable For Thinner Insulation Materials

Commonly used for fixing the insulation layer in interior decoration or lightweight walls

适用于较薄的保温材料，通常用于室内装修或轻质墙体的保温层固定。

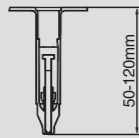

20-150mm

Suitable For Medium-thickness Insulation Materials

Widely used in exterior wall insulation projects of buildings

适用于中等厚度的保温材料，广泛用于建筑外墙保温工程。

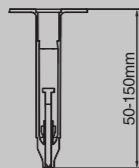

20-200mm

Suitable For Thicker Insulation Materials

Typically used in large-scale construction projects or scenarios requiring high-strength fixation

适用于较厚的保温材料，通常用于大型建筑项目或需要高强度固定的场景。

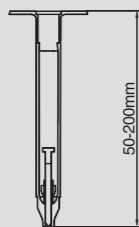

FENCING STAPLER SERIES

篱笆枪系列

LA400 / LD400 / FM400 / LA315 / LD315 / FM315 / LDFS16G / FS16G / FS18G

LA400 **BL** 9 GA. AI CORDLESS FENCING STAPLER

AI智能锂电400篱笆枪

NEW

PATENT
专利技术

仅 **4.2KG**

Applications / 应用

- Wire Fencing, Livestock Fencing
铁丝围栏, 牲畜围栏
- Barbed Wire Installation
带刺铁丝安装

Product Specification / 产品参数		LA400
Nail Range/Shank Range/钉子规格		38-50mm, 4.2x3.8mm
Magazine Capacity/装钉数量		25pcs
Strike Rate/打钉速率		60-90 nails/min (钉/分钟)
Kinetic Energy/动能		100J
Dimension (w/o battery)/产品尺寸(不含电池)		381X117X395mm
Weight (w/o battery)/产品重量(不含电池)		4.2kg



ARTIFICIAL INTELLIGENCE AI人机交互 | **EXTENDED TOOL LIFE** 双活齿专业技术 | **EASY REPLACEMENT** 维修方便 | **STRENGTH ADJUSTABLE** 力度可调

SIMILAR PRODUCT COMPARED WITH PREMIUM BRANDS

篱笆枪同枪型对比国际品牌

	FREEMAN LA400	D Brand(D品牌) 400 FENCING STAPLER(400篱笆枪)
Battery Duration(20V 4.0Ah) 满电打钉数	≈950pcs(100psi/7kg) ≈750pcs(115psi/8kg)	≈472pcs
Strength Adjustable 力度是否可调	Yes/是	No/否
Strike Power 打钉力度	Powerful/大	Powerless/小
Maintenance 维护便捷性	Easy/便捷	Difficult/繁琐

LD400 **BL** 9 GA. CORDLESS FENCING STAPLER 锂电400篱笆枪

NEW

PATENT
专利技术

- Soft Touch Mechanism**
软撞击结构
- Quick Repair**
维修便携
- Strength Adjustable**
力度可调

Applications / 应用

- Wire Fencing, Livestock Fencing
铁丝围栏, 牲畜围栏
- Barbed Wire Installation
带刺铁丝安装

Product Specification / 产品参数		LD400
Nail Range/Shank Range/钉子规格		38-50mm, 4.2x3.8mm
Magazine Capacity/装钉数量		54pcs
Strike Rate/打钉速率		60-90 nails/min (钉/分钟)
Kinetic Energy/动能		100-120J
Dimension (w/o battery)/产品尺寸(不含电池)		381x117x395mm
Weight (w/o battery)/产品重量(不含电池)		4.7kg



FM400 9 GA. FENCING STAPLER 气动400篱笆枪

PATENT
专利技术

ONLY 3.65KG

Applications / 应用

- Wire Fencing, Livestock Fencing
铁丝围栏, 牲畜围栏
- Barbed Wire Installation
带刺铁丝安装

Product Specification / 产品参数		FM400
Fastener Size/钉子长度		38-50mm, 4.2x3.8mm
Fastener Type/钉子种类		9 GA. Fencing Staples
Operating Pressure/工作气压		70-115psi(5-8Bar)
Magazine Capacity/装钉量		50pcs
Weight/产品重量		3.65kg



STEEL NAIL SERIES

LA315 **BL** 10.5 GA. AI CORDLESS FENCING STAPLER 锂电315篱笆枪

- Artificial Intelligence
AI人机交互
- Soft Touch Mechanism
软撞击结构
- Quick Repair
维修便携
- Strength Adjustable
力度可调

Applications / 应用

- Wire Fencing, Livestock Fencing
铁丝围栏, 牲畜围栏
- Barbed Wire Installation
带刺铁丝安装

Product Specification / 产品参数		LA315
Nail Range/Shank Range/钉子规格		22~40mm, 2.7x3.25mm
Magazine Capacity/装钉数量		50pcs
Strike Rate/打钉速率		60~90 nails/min (钉/分钟)
Kinetic Energy/动能		100J
Dimension (w/o battery)/产品尺寸(不含电池)		367X116X346mm
Weight (w/o battery)/产品重量(不含电池)		3.8kg



NEW

PATENT
专利技术

FM315 10.5 GA. FENCING STAPLER 锂电FM315篱笆枪

G2 ONLY **2.3KG**

PATENT
专利技术

Applications / 应用

- Wire Fencing, Livestock Fencing
铁丝围栏, 牲畜围栏
- Barbed Wire Installation
带刺铁丝安装

Product Specification / 产品参数		FM315
Fastener Size/钉子长度		22~40mm, 2.7x3.25mm
Fastener Type/钉子种类		10.5 GA. Fencing Staples
Operating Pressure/工作气压		70~115psi(5~8Bar)
Magazine Capacity/装钉量		50pcs
Weight/产品重量		2.3kg



LD315 **BL** 10.5 GA. CORDLESS FENCING STAPLER 锂电315篱笆枪

- Soft Touch Mechanism
软撞击结构
- Quick Repair
维修便携
- Strength Adjustable
力度可调

Applications / 应用

- Wire Fencing, Livestock Fencing
铁丝围栏, 牲畜围栏
- Barbed Wire Installation
带刺铁丝安装

Product Specification / 产品参数		LD315
Nail Range/Shank Range/钉子规格		22~40mm, 2.7x3.25mm
Magazine Capacity/装钉数量		54pcs
Strike Rate/打钉速率		60~90 nails/min (钉/分钟)
Kinetic Energy/动能		95~120J
Dimension (w/o battery)/产品尺寸(不含电池)		367x117x395mm
Weight (w/o battery)/产品重量(不含电池)		4.3kg



PATENT
专利技术

LDFS16G **BL** 16 GA. CORDLESS FENCING STAPLER 锂电FS16G篱笆枪

2600 PCS
4.0Ah满电打钉2600枚

ANTI-REBOUND
抗反弹技术

PATENT
专利技术

Features / 功能

- Adjustable Depth
打钉深度可调节
- LED Light Function
LED辅助照明灯
- Quick Jam Release
快拆枪嘴设计
- Comfortable Handle
包胶手柄抗疲劳

Applications / 应用

- Animal Husbandry Fence
动物围栏
- Railway fence
铁路围墙
- Gardening Fence
花园栅栏

Product Specification / 产品参数		LDFS16G
Nail Range/Shank Range/钉子规格		18mm, φ2.2mm
Magazine Capacity/装钉数量		50pcs
Strike Rate/打钉速率		90~120 nails/min (钉/分钟)
Dimension (w/o battery)/产品尺寸(不含电池)		326x115x329mm
Weight (w/o battery)/产品重量(不含电池)		2.95kg



STEEL NAIL SERIES

FS16G 16 GA. FENCING STAPLER 气动FS16篱笆枪

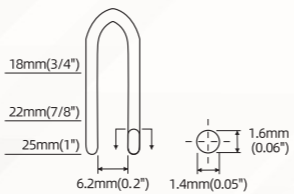

Product Specification / 产品参数 FS16G

Fastener Size/钉子长度	19-25mm / 3/4"-1"
Fastener Type/钉子种类	16 GA. Fencing Staples
Operating Pressure/工作气压	60-100psi(4-7Bar)
Magazine Capacity/装钉量	100pcs
Weight/产品重量	1.95kg

FS18G 18 GA. FENCING STAPLER 气动FS18篱笆枪

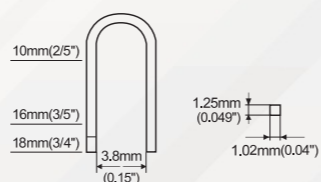
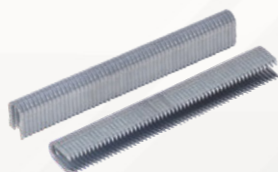

Product Specification / 产品参数 FS18G

Fastener Size/钉子长度	10-22mm / 3/8"-7/8"
Fastener Type/钉子种类	18 GA. Fencing Staples
Operating Pressure/工作气压	60-100psi(4-7Bar)
Magazine Capacity/装钉量	100pcs
Weight/产品重量	1.16kg

9 Gauge

Heavy duty staples are designed for large livestock, field, and security fencing along with other heavy mesh and construction applications.

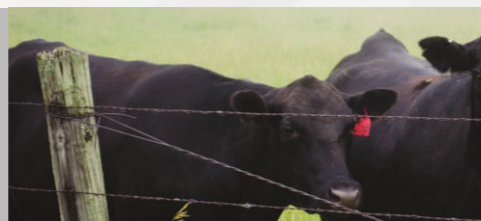
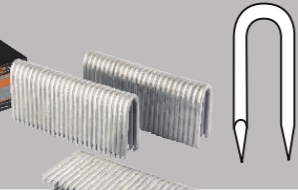

10.5 Gauge

Provides a solid grip for most fencing applications including medium-sized livestock, vineyard trellising, and deer prevention.



16 Gauge

Used for pet enclosures, small garden trellising, and anti-predator barriers for chicken and rabbit pens.

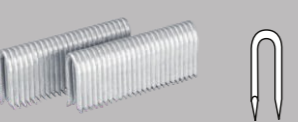

18 Gauge

Fine wire fencing is ideal for small animal pens and other lightweight fencing.



AIR COMPRESSOR SERIES 空压机系列

LK10L / LK6L / FCCZKTIO1 / LK4L / PSC15G / TA3GCOMP / PC6G

LK10L **BL** 10L CORDLESS AIR COMPRESSOR 锂电空压机10L

- › **CORDLESS**
无绳便携
- › **QUIET**
静音
- › **BRUSHLESS**
无刷
- › **OIL FREE**
无油

Applications / 应用

- › For Pneumatic Tools, Balls And Tyres Inflation And Paint Sprayers, Etc
气动工具、球类打气、轮胎充气、气动喷笔等

Product Specification / 产品参数	LK10L
Power/功率	500W
Max. Pressure/最大压力	120psi(8.3bar)
Cut-in/cut-off/重启/饱和压力	90psi/120psi(6.2bar/8.3bar)
Working Speed/工作转速	1500rpm
Continuous Air Delivery Time/持续输出时间(90psi)	20min(4.0Ahx2)
Continuous Fill-up Time/持续上气时间(90-120psi)	22min(4.0Ahx2)
Fully Filled Up Times/满罐次数	12 times/次(4.0Ahx2)
Dimension (w/o Battery)/产品尺寸(不含电池)	420x390x368mm
Weight (w/o Battery)/产品重量(不含电池)	11.8kg



45.3

AIR DELIVERY
排气量
L/min



QUIET, NOISE <70DB(A)
静音 噪音<70DB(A)

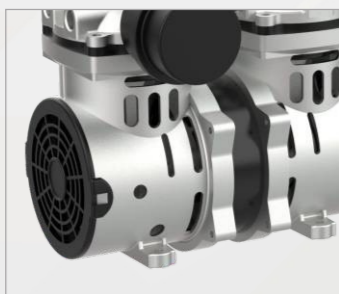

BRUSHLESS MOTOR
无刷电机 高效耐用



LONG BATTERY LIFE / DUAL BATTERY
续航强劲 双电池插口



INTELLIGENT CONTROL
智能控制 过热过流保护

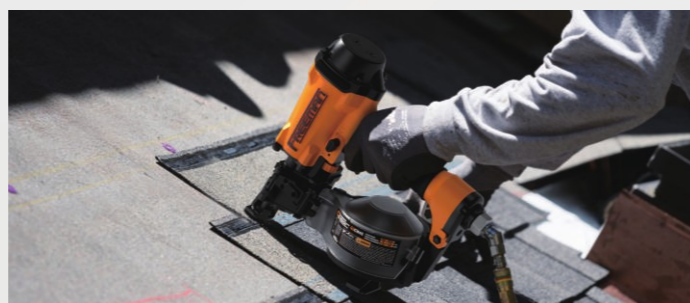

Tank/气罐	10L
Motor/电机	Brushless/无刷
Weight/重量	11.8kg
Air Delivery/排气量	45.3L / min
Fill-up Time/上气时间	8.3Bar
Max. Pressure/最大压力	≈90s
Battery Runtime/持续使用时间	Air supply for over 1900 F30 nail shots /可打F30钉1900枚以上
Cut-in/Cut-off重启/饱和压力	6.2Bar/8.3Bar



8L
Brushless/无刷
14.2kg
34L/min
≈100s
9.3Bar
Air supply for over 1200 F30 nail shots /可打F30钉1200枚以上
6.2Bar/8.3Bar



LK6L **BL** 6L CORDLESS AIR COMPRESSOR 锂电空压机6L

- › **CORDLESS**
无绳便携
- › **BRUSHLESS**
无刷
- › **QUIET**
静音
- › **OIL FREE**
无油

Product Specification / 产品参数	LK6L
Power/功率	400W
Max. Pressure/最大压力	120PSI(8.3Bar)
Working Speed/工作转速	2100rpm
Continuous air delivery time/持续输出时间(90PSI)	26min(4.0Ahx2)
Continuous fill-up time/持续上气时间(90-120PSI)	48min(4.0Ahx2)
Fully Filled Up Times/满罐次数	28 times/次(4.0Ahx2)
Dimension (w/o battery)/产品尺寸(不含电池)	323x352x420mm
Weight (w/o battery)/产品重量(不含电池)	10.8kg



STEEL NAIL SERIES

FCCZKT101 PORTAB TIRE INFLATOR 智能打气机

- › **SMART DIGITAL DISPLAY**
双屏智能数显
- › **3 LED LIGHT**
3种照明方式
- › **5X FAST INFLATION**
5倍快速充气
- › **5 MODES**
5种充气模式

Product Specification / 产品参数	FCCZKT101
Voltage/电压	11.1V
Cylinder/缸径	21mm
Pressure Range/压力范围	3-150psi/0.2-10.3bar
Battery Capacity/电池容量	2000mAh*3/1500mAh*3
Inflation Time/充气时间	6 min(car tire 195/65/R15)
Product Size/产品尺寸	53*53*240mm
Product Net Weight/产品净重	0.54kg

NEW



REVERSE CHARGING
反向充电



TYPE-C
USB接口

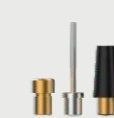

Tire Inflation 轮胎打气



Ball Inflation 球类打气



Nailer Air Charging 钢钉枪充气

LK4L 4L CORDLESS AIR COMPRESSOR 锂电空压机4L

- › **CORDLESS**
无绳便携
- › **SMALL AND PORTABLE**
轻巧
- › **OIL FREE**
无油



Applications / 应用

- › For Pneumatic Tools, Balls And Tyres Inflation And Paint Sprayers, Etc
气动工具、球类打气、轮胎充气、气动喷笔等

Product Specification / 产品参数

Model/产品型号	LK4L
Power/功率	240W
Max. Pressure/最大压力	120PSI(8.3Bar)
Working Speed/工作转速	4200~4500rpm
Continuous air delivery time/持续输出时间(90PSI)	21min(4.0Ah)
Continuous fill-up time/持续上气时间(90-120PSI)	30min(4.0Ah)
Fully Filled Up Times/满罐次数	13 times/次(4.0Ah)
Dimension (w/o battery)/产品尺寸(不含电池)	375x288x268mm
Weight (w/o battery)/产品重量(不含电池)	6.4kg

Tank/气罐	4L
Motor/电机	Brushed/有刷
Weight/重量	6.4kg
Air Delivery/排气量	14.2L/min
Battery/电池	20V 4.0Ah
Fill-up Time/上气时间	≈85s
Max. Pressure/最大压力	8.3Bar
Battery Runtime/持续使用时间	19min
Cut-in/Cut-off重启/饱和压力	6.2Bar/8.3Bar
Noise/噪音	80dB(A)



Tank/气罐	4L
Motor/电机	Brushed/有刷
Weight/重量	6.4kg
Air Delivery/排气量	14.2L/min
Battery/电池	18V 4.0Ah
Fill-up Time/上气时间	≈85s
Max. Pressure/最大压力	8.3Bar
Battery Runtime/持续使用时间	19min
Cut-in/Cut-off重启/饱和压力	6.2Bar/8.3Bar
Noise/噪音	82dB(A)



PSC15G 6L SILENT OIL-FREE ELECTRIC AIR COMPRESSOR 6L交流空压机

Product Specification / 产品参数

Capacity/气罐容量	6L
Input/输入	120V / 60Hz
Noise Level/噪音	58 dbA
Max HP/最大马力	0.8 HP
SCFM @ 90 PSI	1.4 SCFM
Max PSI/最大气压	125 PSI
Weight/产品重量	13.2kg



TA3GCOMP 12L OIL-FREE ELECTRIC AIR COMPRESSOR 12L交流空压机

Product Specification / 产品参数

Capacity/气罐容量	12L
Input/输入	120V / 60Hz
Noise Level/噪音	85 dbA
Max HP/最大马力	1.25 HP
SCFM @ 90 PSI	2 SCFM
Max PSI/最大气压	125 PSI
Weight/产品重量	13.8kg



PC6G 24L OIL-FREE ELECTRIC AIR COMPRESSOR 24L交流空压机

Product Specification / 产品参数

Capacity/气罐容量	24L
Input/输入	120V / 60Hz
Noise Level/噪音	80 dbA
Max HP/最大马力	1.5 HP
SCFM @ 90 PSI	2.6 SCFM
Max PSI/最大气压	150 PSI
Weight/产品重量	16.8kg



PVC AIR HOSE COUPLER

塑钢气管接头

PLASTIC-STEEL MATERIAL

Anti-aging, Corrosion Resistance, Rust-free
塑钢材质, 抗老化 耐腐蚀 不生锈

PRECISE THREAD STRUCTURE

High hardness, clear and durable thread, not easy to crack
精密螺纹结构, 硬度高 螺纹清晰耐磨 不易开裂

BUILD-IN HARD STEEL BALLS

Close and smooth, easy to operate
内置高硬度钢珠, 紧密顺畅 操作方便



FABBC01
BRITISH EXTERNAL THREADED COUPLER
(英式塑钢外螺纹接头)



FABAC03
AMERICAN EXTERNAL THREADED PVC COUPLER
(美式塑钢外螺纹接头)



FABBC05
BRITISH THREE-WAY INTERNAL THREADED COUPLER
(英式3通接头)



FABBC02
BRITISH EXTERNAL THREADED COUPLER
(英式塑钢外螺纹接头)



FABAC04
AMERICAN ZINC-PLATED EXTERNAL THREADED COUPLER
(美式镀锌外螺纹接头)



FABAC06
AMERICAN THREE-WAY INTERNAL THREADED COUPLER
(美式3通接头)

FANR01-20 1/4" X 65' COMPACT RETRACTABLE AIR HOSE REEL

1/4"小型可伸缩式气管卷管器

Production Assembly / Auto Repair / Maintenance Workshop
生产装配/维修车间/汽车维修



Product Specification / 产品参数

Dimension/产品尺寸	380x180x345mm
Hose Size/气管尺寸	1/4"
Hose Length/气管长度	20m(outlet)+2m(inlet)
Max. PSI/最大工作压力	300 PSI
Temperature/温度	-30~50°C
Weight/产品重量	5.2 kg

- Auto Hose Layering Guide for Less Tangles and Twisted Hose
自动软管导向装置减少软管缠结和缠绕
- Automatically Rewind Hose into Unit
全自动软管自回收装置
- Unique Locking Mechanism Stops The Hose at Any Position
特殊的锁定机制在任何位置可以锁定软管

FANR02-20 3/8" X 65' COMPACT RETRACTABLE AIR HOSE REEL

3/8"小型可伸缩式气管卷管器

Production Assembly / Auto Repair / Maintenance Workshop
生产装配/维修车间/汽车维修



Product Specification / 产品参数

Dimension/产品尺寸	375x200x350mm
Hose Size/气管尺寸	3/8"
Hose Length/气管长度	20m(outlet)+2m(inlet)
Max. PSI/最大工作压力	300 PSI
Temperature/温度	-30~50°C
Weight/产品重量	6.58 kg

- Heat Treated for Hardness More Than HRC52
热处理硬度大于HRC52
- High Quality Chrome Vanadium Steel
铬钒合金钢制造
- Surface: Satin Finish
表面抛光处理

3/8" X 65' HIGH FLOW PREMIUM POLYMER HYBRID AIR HOSE WITH FITTING KIT

20米3/8"气管

Production Assembly / Auto Repair / Maintenance Workshop
生产装配/维修车间/汽车维修



Product Specification / 产品参数

Hose Size/气管尺寸	3/8"
Hose Length/气管长度	20m
Max. PSI/最大工作压力	300 PSI
Weight/产品重量	3.28 kg

- Brass Fittings
黄铜接头
- Non-marring Finish
管壁厚实耐磨
- Cold Weather Flexibility
耐寒抗热
- Bend Restrictors
高回弹性能

1/4" X 50' POLYMER HYBRID AIR HOSE WITH FITTINGS

15米1/4" PU气管

Production Assembly / Auto Repair / Maintenance Workshop
生产装配/维修车间/汽车维修



Product Specification / 产品参数

Hose Size/气管尺寸	1/4"
Hose Length/气管长度	15m
Max. PSI/最大工作压力	300 PSI
Bursting Pressure/爆破压力	900 PSI
Temperature/温度	-58~121°C
Weight/产品重量	1.3 kg

- High Quality Chrome Vanadium Steel
铬钒合金钢制造
- Heat Treated For Hardness More Than HRC52
热处理硬度大于HRC52
- Surface: Satin Finish
表面抛光处理

1/4" X 100' POLYMER HYBRID AIR HOSE WITH FITTINGS

30米1/4" PU气管

Production Assembly / Auto Repair / Maintenance Workshop
生产装配/维修车间/汽车维修



Product Specification / 产品参数

Hose Size/气管尺寸	1/4"
Hose Length/气管长度	30m
Max. PSI/最大工作压力	300 PSI
Bursting Pressure/爆破压力	900 PSI
Temperature/温度	-58~121°C
Weight/产品重量	2.6 kg

- Brass Fittings
黄铜接头
- Non-marring Finish
管壁厚实耐磨
- Bend Restrictors
高回弹性能
- Cold Weather Flexibility
耐寒抗热

1/4" X 50' BRAIDED POLYURETHANE AIR HOSE

15米编织聚氨酯气管

Production Assembly / Auto Repair / Maintenance Workshop
生产装配/维修车间/汽车维修



Product Specification / 产品参数

Hose Size/气管尺寸	1/4"
Hose Length/气管长度	15m
Max. PSI/最大工作压力	300 PSI
Bursting Pressure/爆破压力	900 PSI
Temperature/温度	-30~50°C
Weight/产品重量	1 kg

- Cold Weather Flexibility
耐寒抗热
- Bend Restrictors
高回弹性能
- Non-marring Finish
管壁厚实耐磨

1/4" X 100' BRAIDED POLYURETHANE AIR HOSE

30米编织聚氨酯气管

› Production Assembly / Auto Repair / Maintenance Workshop
生产装配/维修车间/汽车维修



Product Specification / 产品参数

Hose Size/气管尺寸	1/4"
Hose Length/气管长度	30m
Max. PSI/最大工作压力	300 PSI
Bursting Pressure/爆破压力	900 PSI
Temperature/温度	-30~50°C
Weight / 产品重量	1.7 kg

- Cold Weather Flexibility
- 耐寒抗热
- Non-marring Finish
- 管壁厚实耐磨
- Bend Restrictors
- 高回弹性能

1/4" X 100' BRAIDED POLYURETHANE AIR HOSE WITH FITTINGS

30米编织聚氨酯气管

› Production Assembly / Auto Repair / Maintenance Workshop
生产装配/维修车间/汽车维修



Product Specification / 产品参数

Hose Size/气管尺寸	1/4"
Hose Length/气管长度	30m
Max. PSI/最大工作压力	300 PSI
Bursting Pressure/爆破压力	900 PSI
Temperature/温度	-30~50°C
Weight / 产品重量	2.6 kg

- Cold Weather Flexibility
- 耐寒抗热
- Non-marring Finish
- 管壁厚实耐磨
- Bend Restrictors
- 高回弹性能

1" BELT HOOK WITH 1/4"NPT SWIVEL FITTING

挂钩

Hang Tool On Belt Or Pocket For Safety While Climbing Or Moving On Site

工具挂于腰带或口袋，攀爬移动更安全



Product Specification / 产品参数

Hook Length/挂钩横向尺寸	1-3/4"
Arm Length/长柄尺寸	6"
Fitting/配件	1/4" NPT Swivel Fitting Brass Bushing
Weight/产品重量	0.12 kg

1/4" X 50' BRAIDED POLYURETHANE AIR HOSE WITH FITTINGS

15米编织聚氨酯气管

› Production Assembly / Auto Repair / Maintenance Workshop
生产装配/维修车间/汽车维修



Product Specification / 产品参数

Hose Size/气管尺寸	1/4"
Hose Length/气管长度	15m
Max. PSI/最大工作压力	300 PSI
Bursting Pressure/爆破压力	900 PSI
Temperature/温度	-30~50°C
Weight / 产品重量	1.7 kg

- Cold Weather Flexibility
- 耐寒抗热
- Non-marring Finish
- 管壁厚实耐磨
- Bend Restrictors
- 高回弹性能

1-3/4" RAFTER HOOK WITH 1/4" NPT FITTING AND BRASS BUSHING

挂钩

Hang Tool On Belt Or Pocket For Safety While Climbing Or Moving On Site

适用于市面上所有气动打钉枪



Product Specification / 产品参数

Hook Length/挂钩横向尺寸	1-3/4"
Arm Length/长柄尺寸	5-1/2"
Fitting/配件	1/4" NPT Straight Fitting Brass Bushing
Weight/产品重量	0.11 kg

1-3/4" RAFTER HOOK WITH 1/4" NPT SWIVEL FITTING AND BRASS BUSHING

挂钩

Hang Tool On Belt Or Pocket For Safety While Climbing Or Moving On Site

工具挂于腰带或口袋，攀爬移动更安全



Product Specification / 产品参数

Hook Length/挂钩横向尺寸	1-3/4"
Arm Length/长柄尺寸	6"
Fitting/配件	1/4" NPT Swivel Fitting Brass Bushing
Weight/产品重量	0.14 kg

FCML01

2-IN-1 CAMP LIGHT & FLASHLIGHT

Change To Different Shape According To Different Work Environment

野营灯/手电筒 二合一

根据不同工作环境,切换合适的形态

4.0h Run Time

4.0Ah运行时间



Product Specification / 产品参数

Operating Voltage/工作电压	DC20V
Power/功率	5W
LED Number/LED数量	4pcs SMD3535
Lumens /光通量	300/150Lm
Light Adjustment/亮度调节	2 Settings/2档
Direction Adjustment/角度调节	175°(12 directions)/(12档)
Recharge Time/充电时间	45min(2.0Ah)
Run Time/续航时间	20h(4.0Ah)
Dimension (w/o battery)/产品尺寸(不含电池)	120x72x49mm
Weight (w/o battery)/产品重量(不含电池)	0.2kg

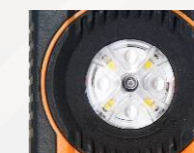

- Floodlight/Spotlight Suitable for different environment
- 泛光灯/聚光灯 适合不同使用环境



- 12-Position/175° Adjustable Suitable for different environment
- 12档/175°可调 适合不同使用环境



- Storage Hook More convenient to use
- 可收纳挂钩 使用更方便

FCML02

LITHIUM-ION LED LIGHT

Professional For Camping / Engineering Work / Family Emergency Lighting

锂电LED照明灯

户外露营/工程作业/家庭应急

最高2000Lm光通量

UP TO 2,000 LUMENS

Large area floodlight / High-intensity/ Long distance/ Long life
大泛光/高亮度/远距离/长寿命

Product Specification / 产品参数

Operating Voltage/工作电压	DC20V
Power/功率	20W
LED Number/LED数量	36pcs SMD2835
Lumens /光通量	2000/900Lm
Light Adjustment/亮度调节	2 Settings/2档
Direction Adjustment/角度调节	320°
Recharge Time/充电时间	45min(2.0Ah)
Run Time/续航时间	6h(4.0Ah)
Dimension (w/o battery)/产品尺寸(不含电池)	205x170x135mm
Weight (w/o battery)/产品重量(不含电池)	0.93kg



- 36 High-intensity Led Beads 2 brightness settings
- 36颗高亮LED灯珠 2档亮度可调



- Comfortable Handle Easy to carry
- 舒适把手 方便携带



- 320° Adjustable Suitable for different environment
- 320°可调 适合不同使用环境

FCTS01

LITHIUM-ION PIVOTING SCREWDRIVER

In-Line / Gun Mode

旋转式锂电螺丝刀

日常维修/门窗安装/电路维修/家具拆装

No-Load Run Time



空载运行时间

Product Specification / 产品参数

Operating Voltage/工作电压	DC3.6V
No-Load Speed/空载转速	200rpm
Max.Torque/最大扭矩	4N.m
Chuck Type/夹头规格	6.35mm(1/4")inner hex/内六角
Torque Mode/扭矩调节	6+1 Mode Adjustable/6+1档可调
LED Light/LED辅助照明	Yes/是
Battery Capacity/电池容量	1300mAh
Charger Port/充电接口	Micro USB
No-Load Operating Time/空载运行时间	60min
Dimension (w/o battery)/产品尺寸(不含电池)	175x45x145mm
Weight (w/o battery)/产品重量(不含电池)	0.43kg



• **Hand Guard Panel**
Safer in work
• 正反转一键切换
快速切换, 居中即停



• **Rear Flashlight Design**
Multipurpose tool
• 尾部手电照明
一机多用更方便



• **LED Light**
Suitable for low light environment
• LED辅助照明
无惧暗光环境

FCTS02

LITHIUM-ION SCREWDRIVER KIT

Professional Home Decoration / Maintenance

多功能头锂电螺丝刀套装

家具拆装/日常维修/布料裁切/墙纸裁切/特殊位置打螺丝

No-Load Run Time



空载运行时间

Product Specification / 产品参数

Operating Voltage/工作电压	DC3.6V
No-Load Speed/空载转速	200rpm
Max.Torque/最大扭矩	4N.m
Battery Capacity/电池容量	1500mAh
LED Light/LED辅助照明	Dual LED/双LED
Charger Port/充电接口	Type-C
No-Load Operating Time/空载运行时间	60min
Dimension (w/o battery)/产品尺寸(不含电池)	140x110x44mm
Weight (w/o battery)/产品重量(不含电池)	0.38kg



• **Quick Bits Replacement**
Press the switch and replace

• 正反转一键切换
快速切换, 居中即停

• **One-Button Change Of 4 Kinds Of Functional Bits**

四种功能转换头一键更换

• **Torx Bits**

扭矩调节头

• **Cutting Bits**

切割替换头

• **Square Bits**

直角转换头

• **Variable Bits**

变角转换头

▶ For screwing and adjusting torque according to the tightness
用于起拧螺丝, 并根据紧固程度调节扭矩

▶ For cutting cardboard, wallpaper, cloth and carpet etc.
用于裁剪纸板、墙纸、布料、地毯等

▶ For changing operating angles
用于转换操作角度

▶ For avoiding blind corners
用于避开操作死角

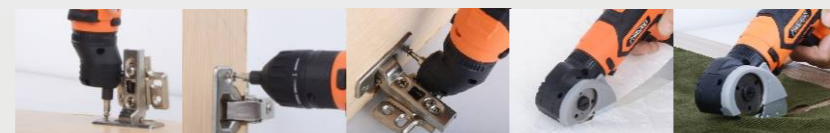

Variable Bits/变角转换头 Torx Bits/扭矩调节头 Square Bits/直角转换头 Cutting Bits/切割替换头



FRAMING NAILER SERIES

斜钉枪系列

LA34100 / LD3490 / LA3490 / LD3490 / FM3490 / FM3483 / LA2190 / LD2190 / FM2190 / FM2183 / LA2190D / LD2190D / LA64MCN / XR250S

LA34100 BL

AI智能锂电34100斜钉枪

AI CORDLESS CLIPPED HEAD FRAMING NAILER

Applications / 应用

- HOUSE FRAMING 房屋框架搭建
- DECK BUILDING 露台建造
- SUBFLOOR INSTALLATION 底层地板安装

NEW

PATENT 专利技术

仅 **3.7KG**

Compared with Leading Competitor **4.2~4.4KG**
对标国际品牌约 **4.2~4.4KG**

3 NAILS/S

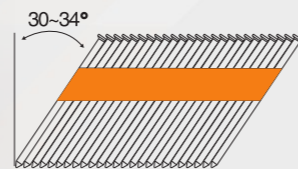
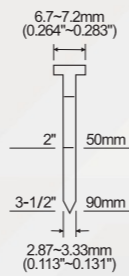

Product Specification / 产品参数

Model/产品型号	LA34100
Nail Range/Shank Range/钉子规格	Paper Collation(50-100mm/34°)
Magazine Capacity/装钉数量	56pcs
Strike Rate/打钉速率	120~180 nails/min (钉/分钟)
Kinetic Energy/动能	100~120J
Dimension (w/o battery)/产品尺寸(不含电池)	330X158X377mm
Weight (w/o battery)/产品重量(不含电池)	3.7kg

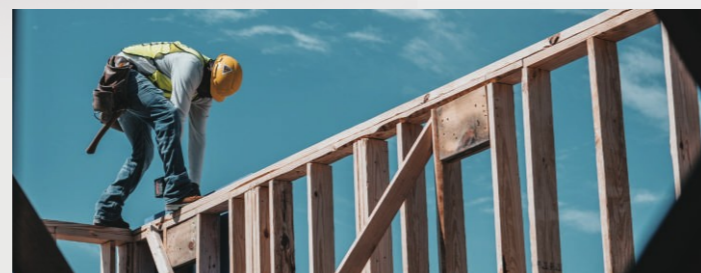

Artificial Intelligence
AI人机交互



IoT Monitoring
物联网监控

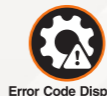

Error Code Display
故障显示

OPTION
选配



Pressure Monitoring
压力检测

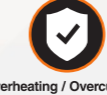

Overheating / Overcurrent /
Over Discharge Protection
过热/过流/过放保护



Soft Touch Mechanism
软撞击专利技术



Professional "soft touch" mechanism
Doubles the life time of the driver blade

软撞击专利技术，
撞针寿命提升约2倍



Convenient Maintenance, Easy Replacement
维护方便，易损件轻松更换/清洗



Remove 4 screws and replace the driver blade easily
Unlike Competitors,
No Factory Repair Needed

仅需拆卸4颗螺丝，轻松更换撞针
对比竞品，无需返厂维修



Powerful, With Strength Adjustable
力量大，打钉力度可调节



The factory-set kinetic power is 100J
Power up to 120J, compared with 100J of competing products
出厂标准能量为100J
能量高达120J，对标国际品牌约100J

SIMILAR PRODUCT COMPARED WITH PREMIUM BRANDS

3490同枪型对比国际品牌

	FREEMAN	FREEMAN	D Brand(M品牌)	R Brand(R品牌)	T Brand(T品牌)	M Brand(M品牌)
Weight (w/o battery) 产品重量 (不含电池)	3.7kg	4.2kg	3.9kg	4.04kg	4.02kg	4.4kg
Kinetic Energy 动能	100~120J	100~120J	80J	100J	100J	100J
Battery Duration 续航能力(5.0Ah)	850PCS	850PCS	800PCS	800PCS	800PCS	800PCS
Maintenance 维修便捷性	Just remove 4 screws 只需拆卸4颗螺丝	Just remove 5 screws 只需拆卸5颗螺丝	Difficult/繁琐	Difficult/繁琐	Difficult/繁琐	Difficult/繁琐
Strike Power 打钉力度 红榉木测试3490斜钉	Fully sink nails into wood 完全钉入	Fully sink nails into wood 完全钉入	Not fully sink nails into wood 未完全钉入	Fully sink nails into wood 完全钉入	Not fully sink nails into wood 未完全钉入	Fully sink nails into wood 完全钉入
Strength Adjustable 补气功能	Yes/是	Yes/是	No/否	Yes/是	Yes/是	No/否
Contact mode of drive blade and drive shaft 传动轴与撞针接触方式	Soft Touch/软接触	Soft Touch/软接触	Hard Touch/硬接触	Hard Touch/硬接触	Hard Touch/硬接触	Hard Touch/硬接触

LD34100 **BL** 34° CORDLESS CLIPPED HEAD FRAMING NAILER 锂电34100斜钉枪



Soft Touch Mechanism
软撞击结构



Quick Repair
维修便携



Strength Adjustable
力度可调

Applications / 应用

- House Framing
房屋框架搭建
- Deck Building
露台建造
- Subfloor Installation
底层地板安装

Product Specification / 产品参数		LD34100
Nail Range/Shank Range/钉子规格	Paper Collation(50-100mm/34°)	
Magazine Capacity/装钉数量	50pcs	
Strike Rate/打钉速率	60-90 nails/min (钉/分钟)	
Kinetic Energy/动能	100-120J	
Dimension (w/o battery)/产品尺寸(不含电池)	370x340x131mm	
Weight (w/o battery)/产品重量(不含电池)	4.08kg	



LA3490 **BL** 34° AI CORDLESS CLIPPED HEAD FRAMING NAILER AI智能锂电3490斜钉枪



ONLY 3.7KG **3 NAILS/S**
仅重3.7kg 打钉快 1秒3下



Artificial Intelligence
AI人机交互



Soft Touch Mechanism
软撞击结构



Quick Repair
维修便携



Strength Adjustable
力度可调

Applications / 应用

- House Framing
房屋框架搭建
- Deck Building
露台建造
- Subfloor Installation
底层地板安装

Product Specification / 产品参数		LA3490
Nail Range/Shank Range/钉子规格	Paper Collation(50-90mm/34°)	
Magazine Capacity/装钉数量	56pcs	
Strike Rate/打钉速率	120-180 nails/min (钉/分钟)	
Kinetic Energy/动能	100-120J	
Dimension (w/o battery)/产品尺寸(不含电池)	330X158X377mm	
Weight (w/o battery)/产品重量(不含电池)	3.7kg	



LD3490 **BL** 34° CORDLESS CLIPPED HEAD FRAMING NAILER 锂电3490斜钉枪



Soft Touch Mechanism
软撞击结构



Quick Repair
维修便携



Strength Adjustable
力度可调

Product Specification / 产品参数		LD3490
Nail Range/Shank Range/钉子规格	Paper Collation(50-90mm/34°)	
Magazine Capacity/装钉数量	50pcs	
Strike Rate/打钉速率	60-90 nails/min (钉/分钟)	
Kinetic Energy/动能	100-120J	
Dimension (w/o battery)/产品尺寸(不含电池)	370x340x131mm	
Weight (w/o battery)/产品重量(不含电池)	4.08kg	



FM3490 34° CLIPPED HEAD FRAMING NAILER 气动3490斜钉枪



Product Specification / 产品参数		FM3490
Fastener Size/钉子长度	50-90mm	
Shank Diameter/钉杆直径	Ø2.87-3.75mm	
Shank Range/钉头直径	Ø6.8-7.2mm	
Operating Pressure/工作气压	70-115psi(5-8Bar)	
Dimension/产品尺寸	502x150x375mm	
Weight/产品重量	3.5kg	



FM3483 34° CLIPPED HEAD FRAMING NAILER 气动3483斜钉枪



ONLY 2.9KG

Product Specification / 产品参数		FM3483
Fastener Size/钉子长度	50-83mm	
Fastener Type/钉子种类	34° Paper Collated Framing Nail	
Operating Pressure/工作气压	70-120psi(5-8.3Bar)	
Magazine Capacity/装钉量	95pcs	
Weight/产品重量	2.9kg	



LA2190D **BL** 21° AI CORDLESS DUPLEX NAILER AI智能锂电双头斜钉枪

ONLY 3.7KG 仅重3.7kg
3 NAILS/S 打钉快 1秒3下

- Artificial Intelligence AI人机交互
- Soft Touch Mechanism 软撞击结构
- Quick Repair 维修便携
- Strength Adjustable 力度可调

- Applications / 应用**
- Building Concrete Forms 建筑混凝土模板
 - Temporary Wood Structures 临时木结构

Product Specification / 产品参数		LA2190D
Nail Range/Shank Range/钉子规格	Duplex Nails(6D, 8D, 16D)	
Magazine Capacity/装钉数量	35pcs	
Strike Rate/打钉速率	120-180 nails/min (钉/分钟)	
Kinetic Energy/动能	100-120J	
Dimension (w/o battery)/产品尺寸(不含电池)	361X136X338mm	
Weight (w/o battery)/产品重量(不含电池)	3.7kg	



NEW

PATENT
专利技术

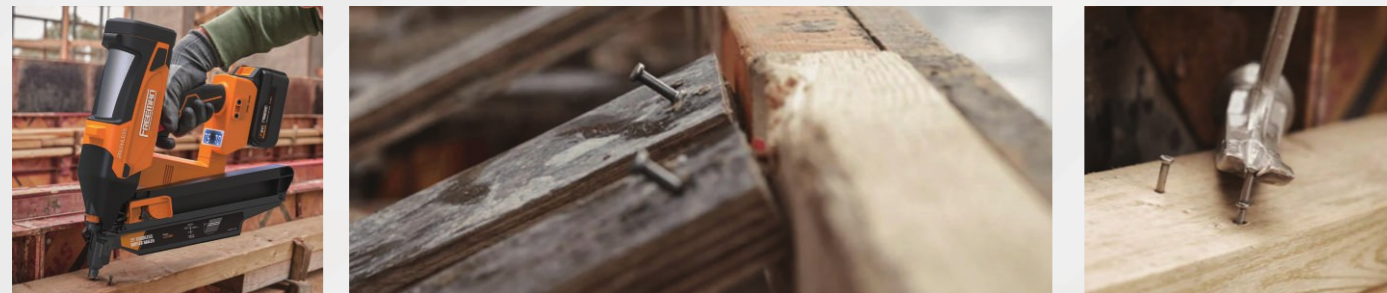

LD2190D **BL** 21° CORDLESS DUPLEX NAILER 锂电双头斜钉枪

- Soft Touch Mechanism 软撞击结构
- Quick Repair 维修便携
- Strength Adjustable 力度可调

Product Specification / 产品参数		LD2190D
Nail Range/Shank Range/钉子规格	Duplex Nails(6D, 8D, 16D)	
Magazine Capacity/装钉数量	35pcs	
Strike Rate/打钉速率	90-120 nails/min (钉/分钟)	
Dimension (w/o battery)/产品尺寸(不含电池)	329x325x113mm	
Weight (w/o battery)/产品重量(不含电池)	3.1kg	



NEW

PATENT
专利技术



LA64MCN **BL** 35° AI CORDLESS METAL CONNECTOR NAILER 锂电35°对孔钉枪

ONLY 3.9KG 仅重3.9kg
3 NAILS/S 打钉快 1秒3下

- Artificial Intelligence AI人机交互
- Soft Touch Mechanism 软撞击结构
- Quick Repair 维修便携
- Strength Adjustable 力度可调

- Applications / 应用**
- For Fastening Pre-punched Metal Connectors to Wood 用于预制孔金属连接件固定到木材上

Product Specification / 产品参数		LA64MCN
Nail Range/Shank Range/钉子规格	15-30mm	
Magazine Capacity/装钉数量	35pcs	
Strike Rate/打钉速率	120-180 nails/min (钉/分钟)	
Dimension (w/o battery)/产品尺寸(不含电池)	332X151X340mm	
Weight (w/o battery)/产品重量(不含电池)	3.9kg	



NEW

PATENT
专利技术

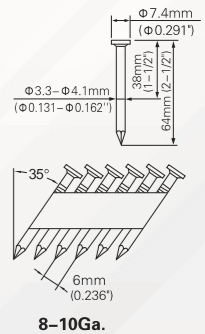

XR250S 35° METAL CONNECTOR NAILER 对孔钉枪



Product Specification / 产品参数		XR250S
Fastener Size/钉子长度	38-63.5mm / 1-1/2"-2-1/2"	
Fastener Type/钉子种类	8 GA-10 GA 35° Metal Connector Nails	
Operating Pressure/工作气压	70-115PSI(5-8Bar)	
Magazine Capacity/装钉量	55pcs	
Weight/产品重量	2.58kg / 5.68lbs	



PATENT
专利技术

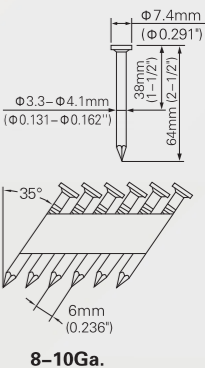

34° PAPER COLLATED FRAMING NAIL

- House Framing
房屋框架搭建
- Deck Building
露台建造
- Subfloor Installation
底层地板安装

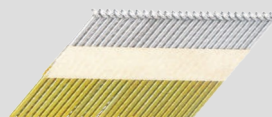

21° PLASTIC COLLATED ROUND HEAD FRAMING NAIL

- House Framing
房屋框架搭建
- Deck Building
露台建造
- Subfloor Installation
底层地板安装

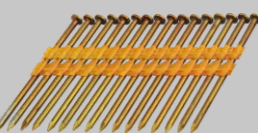

DUPLEX NAIL

Suitable For Temporarily Fixing Components

applied to temporary wooden structures and concrete formwork in construction
适用于临时固定部件的场景，应用于临时木结构，建筑混凝土模板。

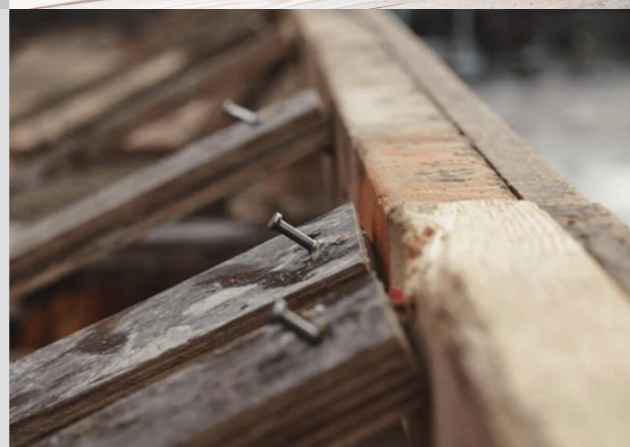

35° Metal Connector Nails

Suitable For Fastening Pre-punched Metal Connectors to Wood

应用于预制孔金属连接件固定到木材上



NAILER & STAPLER SERIES

直钉枪 & 码钉枪系列

LA1564 / FM1564 / LAT64 / LDT64 / T64 / LAT50 / LDT50 / LD504050 / XAGD509040T50 / FM504050 / YF504050P / LDAF30 / AF30 / LAF50 / LDF50 / FMF50 / F50 / LD3232 / LD32425J / LD3838 / LD509040 / XAGD509040 / LD635 / P635 / P625 / P650 / LD1013J / 1013J / LD1022J / LD8016 / 8016 / LDT15 / LD9040 / 7116 / FM9040 / 9040 / 9032 / FMN851

LA1564 **BL** 15 GA 2-1/2" CORDLESS ANGLE FINISH NAILER 锂电34°直钉枪

2 NAILS/S
打钉快 1秒2下

ONLY 2.8KG
仅重2.8kg

Applications / 应用

- Finish and Trim 装饰和收边
- Staircases 楼梯制作
- Furniture 家具制作
- Cabinet Work 橱柜制作

Product Specification / 产品参数	LA1564
Nail Range/Shank Range/钉子规格	15-30mm
Magazine Capacity/装钉数量	100pcs
Strike Rate/打钉速率	90-120 nails/min (钉/分钟)
Dimension (w/o battery)/产品尺寸(不含电池)	322X131X330mm
Weight (w/o battery)/产品重量(不含电池)	2.8kg



Soft Touch Mechanism

EXTENDED TOOL LIFE
提升枪针寿命



Remove The Aluminum Cap

EASY REPLACEMENT
维修方便



Strength Adjustable

STRENGTH ADJUSTABLE
力度可调

FM1564 34° 15 GA. 2-1/2" ANGLE FINISH NAILER 气动34°直钉枪

Product Specification / 产品参数	FM1564
Fastener Size/钉子长度	15-30mm
Operating Pressure/工作气压	60-115psi(4-8Bar)
Magazine Capacity/装钉量	100pcs
Dimension/产品尺寸	235x55x191mm
Weight/产品重量	1.08kg



LAT64 **BL** 16 GA 2-1/2" CORDLESS FINISH NAILER 锂电T64直钉枪

2 NAILS/S
打钉快 1秒2下

ONLY 2.8KG
仅重2.8kg

- Soft Touch Mechanism 软撞击结构
- Quick Repair 维修便携
- Strength Adjustable 力度可调

Applications / 应用

- Finish and Trim 装饰和收边
- Staircases 楼梯制作
- Furniture 家具制作
- Cabinet Work 橱柜制作

Product Specification / 产品参数	LAT64
Nail Range/Shank Range/钉子规格	25-64mm, 1.6x1.4mm
Magazine Capacity/装钉数量	100pcs
Strike Rate/打钉速率	90-120 nails/min (钉/分钟)
Dimension (w/o battery)/产品尺寸(不含电池)	322X98X330mm
Weight (w/o battery)/产品重量(不含电池)	2.8kg



LDT64 16 GA. 2-1/2" CORDLESS FINISH NAILER 锂电T64直钉枪

2600 pcs
4.0Ah满电打钉2600枚

2 1秒2钉
NAILS/S

ANTI-REBOUND
抗反弹技术

Applications / 应用

- Finish and Trim 装饰和收边
- Staircases 楼梯制作
- Furniture 家具制作
- Cabinet Work 橱柜制作

Product Specification / 产品参数	LDT64
Nail Range/Shank Range/钉子规格	25-64mm, 1.6x1.4mm
Magazine Capacity/装钉数量	100pcs
Strike Rate/打钉速率	90-120 nails/min (钉/分钟)
Battery Duration/续航能力	Up to 2600 pcs(4.0Ah) 满电打钉数约2600枚(4.0Ah)
Dimension (w/o battery)/产品尺寸(不含电池)	330x330x113mm
Weight (w/o battery)/产品重量(不含电池)	3.08kg



T64
16 GA. 2-1/2"
FINISH NAILER
气动T64直钉枪

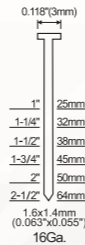

Product Specification / 产品参数		T64
Fastener Size/钉子长度	25-64mm, 1.6x1.4mm	
Operating Pressure/工作气压	70-110psi(5-7.5Bar)	
Magazine Capacity/装钉量	100pcs	
Weight/产品重量	1.84kg	

LAT50 **BL**
16 GA. 2" CORDLESS
FINISH NAILER
锂电T50直钉枪



NEW

PATENT
专利技术

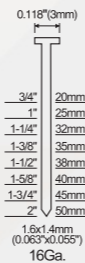

3 NAILS/S
打钉快 1秒2下

Product Specification / 产品参数		LAT50
Nail Range/Shank Range/钉子规格	25-50mm, 1.6x1.4mm	
Magazine Capacity/装钉数量	100pcs	
Strike Rate/打钉速率	120-180 nails/min (钉/分钟)	
Dimension (w/o battery)/产品尺寸(不含电池)	266X98X307mm	
Weight (w/o battery)/产品重量(不含电池)	2.7kg	

LDT50
16 GA. 2" CORDLESS
FINISH NAILER
锂电T50直钉枪



PATENT
专利技术

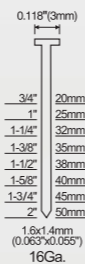

2600 PCS
4.0Ah 锂电打钉2600枚

2 1秒2钉
NAILS/S

ANTI-REBOUND
抗反弹技术

Product Specification / 产品参数		LDT50
Nail Range/Shank Range/钉子规格	19-50mm, 1.6x1.4mm	
Magazine Capacity/装钉数量	100pcs	
Strike Rate/打钉速率	90-120 nails/min (钉/分钟)	
Dimension (w/o battery)/产品尺寸(不含电池)	329x298x113mm	
Weight (w/o battery)/产品重量(不含电池)	3.08kg	

LD504050
16 & 18 GA. 3-IN-1 CORDLESS NAILER/STAPLER
锂电三合一钉枪

PATENT
专利技术

2600 PCS
4.0Ah

POWERFUL
EASILY DRIVES NAILS
INTO DENSE ENGINEERED WOOD
力度大 轻松应对各种硬木

3-IN-1
T50/440K/F30F50

Applications / 应用
Ceiling, Baseboard, Crate Nailing
天花板装钉(非水泥顶)、跟脚线打钉(非水泥立面)
Crate Nailing And Wood-to-wood Fastening.
木箱柜装钉修复等木材间紧固应用



Product Specification / 产品参数		LD504050
Nail Range/Shank Range/钉子规格	F nails (F直钉): 15-50mm T nails (T50直钉): 19-50mm Staple (440K码钉): 16-40mm	
Magazine Capacity/装钉数量	F nails/Staple (F钉/K钉): 100pcs T nails (T钉): 80pcs	
Strike Rate/打钉速率	90-120 nails/min (钉/分钟)	
Battery Duration/续航能力	Up to 2600 pcs(4.0Ah) 满电打钉数约2600枚(4.0Ah)	
Dimension (w/o battery)/产品尺寸(不含电池)	336x278x113mm	
Weight (w/o battery)/产品重量(不含电池)	3.16kg	

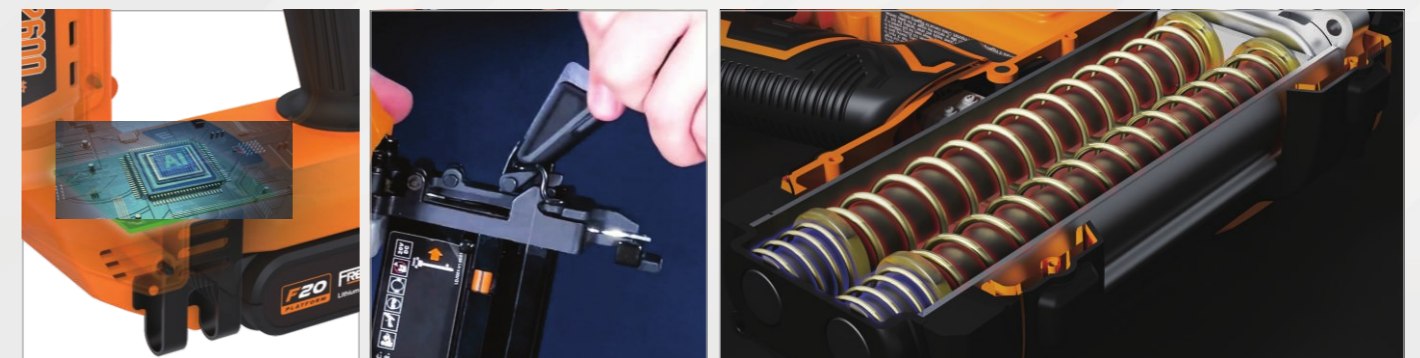
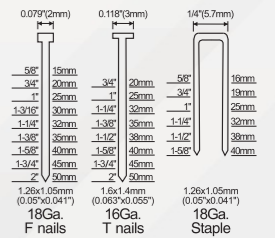

INTELLIGENT CONTROL
智能保护(过热/过流/过压)

TOOL-FREE QUICK JAM RELEASE
快拆盖板, 秒去卡钉

MULTI-SPRING SHOCK ABSORPTION
多弹簧、抗反弹多项发明专利, 有效减震



XAGD509040T50
16 & 18 GA. 3-IN-1 AIR NAILER/STAPLER
 轻便型三合一气动钉枪

> **8 PCS/SEC**
 1秒可达8下

3-IN-1
T50/440K/F30F50

Applications / 应用

- > Ceiling, Baseboard, Crate Nailing
 天花板装钉(非水泥顶)、跟脚线打钉(非水泥立面)
- > Crate Nailing And Wood-to-wood Fastening.
 木箱柜装钉修复等木材间紧固应用

Product Specification / 产品参数		XAGD509040T50
Fastener Size/钉子规格	T nails/F nails/Staple	440K
Operating Pressure/工作气压		60~110psi(4~7.5Bar)
Magazine Capacity/装钉量	T nails: 80pcs; F nails/Staple	440K: 100pcs
Strike Rate/打钉频率		8 pcs/sec
Dimension/产品尺寸		247x57x236mm
Weight/产品重量		1.33kg

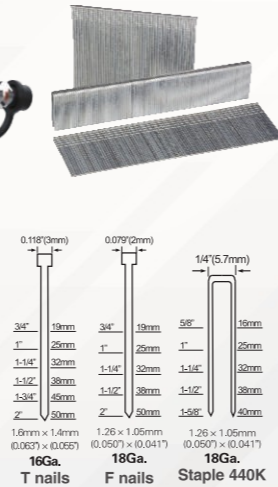

360° ADJUSTABLE EXHAUST 360°旋转排气 **ONE-PIECE BLADE, MAX HARDNESS** 整体枪针 硬度高 **O-RING, HIGHWEAR RESISTANCE** 超耐磨O型圈

FM504050
16 & 18 GA. 3-IN-1 AIR NAILER/STAPLER
 三合一气动钉枪

3-IN-1
T50/440K/F30F50



Product Specification / 产品参数		FM504050P
Fastener Type/钉子种类	T nails / F nails / Staple	440K
Operating Pressure/工作气压		70~110psi(5~7.5Bar)
Magazine Capacity/装钉量	T nails: 80pcs; F nails/Staple	440K: 100pcs
Weight/产品重量		1.52kg

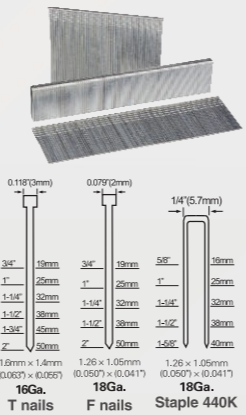

YF504050P
16 & 18 GA. 3-IN-1 AIR NAILER/STAPLER
 加力型三合一气动钉枪

> **8 PCS/SEC**
 1秒可达8下

3-IN-1
T50/440K/F30F50

Applications / 应用

- > Ceiling, Baseboard, Crate Nailing
 天花板装钉(非水泥顶)、跟脚线打钉(非水泥立面)
- > Crate Nailing And Wood-to-wood Fastening.
 木箱柜装钉修复等木材间紧固应用

Product Specification / 产品参数		YF504050P
Fastener Size/钉子规格	T nails/F nails/Staple	440K
Operating Pressure/工作气压		60~110psi(4~7.5Bar)
Magazine Capacity/装钉量	T nails: 80pcs; F nails/Staple	440K: 100pcs
Strike Rate/打钉频率		8 pcs/sec
Dimension/产品尺寸		250x63x243mm
Weight/产品重量		1.6kg

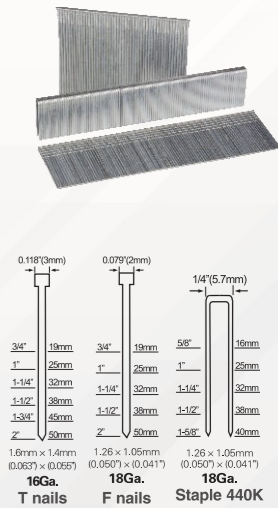

360° ADJUSTABLE EXHAUST 360°旋转排气 **SINGLE FIRING / BUMP FIRING** 单连发切换 **MAKES FURNITURE EASILY** 轻松制作各种家具

Drives Up To 50mm Into Solid Wood 深入实木地板可达50mm



18 GA. NARROW CROWN STAPLES 440K码钉 **18 GA. BRAD NAILS** F30F50直钉 **16 GA. STRAIGHT FINISH NAILS** T50直钉

LDAF30
18 GA. 1-3/16" CORDLESS BRAD NAILER
锂电F30钉枪

POWERFUL,
EASILY DRIVES NAILS INTO
DENSE ENGINEERED WOOD
力度大 轻松应对颗粒板



8400 PCS
5.0Ah

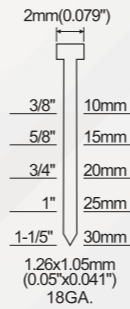

Applications / 应用

- Finish and Trim 装饰和收边
- Paneling 护墙板、墙板装饰
- Furniture 家具制作
- Cabinet Work 橱柜制作
- Crafts 工艺品

Product Specification / 产品参数	LDAF30
Nail Range/Shank Range/钉子规格	15~30mm, 1.26x1.05mm
Magazine Capacity/装钉数量	100pcs
Strike Rate/打钉速率	120~180 nails/min (钉/分钟)
Battery Duration/续航能力	Up to 8400 pcs(5.0Ah) 满电打钉数约8400枚(5.0Ah)
Dimension (w/o battery)/产品尺寸(不含电池)	238x230x68mm
Weight (w/o battery)/产品重量(不含电池)	1.9kg



QUICK DRIVE BLADE SWAP 枪针快换
MULTI-SPRING SHOCK ABSORPTION 多弹簧、抗反弹多项发明专利，有效减震
INTELLIGENT CONTROL 智能保护（过热/过流/过压）



SIMILAR PRODUCT COMPARED
WITH PREMIUM BRANDS
LDAF30/LD3838对标其他品牌

- Powerful • Efficient • Monthly Cost For Working With A Gas
- Nailer Equals To The Cost Of 2PCS LDAF30 Nailer
- 打钉力度大 • 打钉效率高，一个月节约的人工费用可以买2把LDAF30

	FREEMAN	FREEMAN	NUMAX	M Brand(M品牌)	M Brand(M品牌)	R Brand(R品牌)
Nails Per Charge 满电打钉数(20V 2.0Ah)	≈ 3000 pcs	≈ 3000 pcs	≈ 1300 pcs	≈ 1000 pcs	≈ 1300 pcs	≈ 450 pcs
Weight (w/o battery) 产品重量(不含电池)	1.88kg	1.9kg	2.3kg	3.0kg	1.74kg	2.7kg
Lifetime 寿命	More than 100,000 times 10万次以上	More than 100,000 times 10万次以上	More than 100,000 times 10万次以上	100,000 times 10万次	100,000 times 10万次	30,000 times 3万次
Maintenance 维修便捷性	Easy/便捷	Easy/便捷	Difficult/繁琐	Difficult/繁琐	Easy/便捷	Difficult/繁琐
Strike Power Fire 30mm Brad Nails 打钉力度 硬松木0.7g/cm ³ 测试F30钉	Fully sink nails into wood 完全钉入	Fully sink nails into wood 完全钉入	Fully sink nails into wood完全钉入	Fully sink nails into wood 完全钉入	Fully sink nails into wood 完全钉入	Fully sink nails into wood 完全钉入
Strike Rate 打钉速率	≈ 3 nails/sec (钉/秒)	≈ 3 nails/sec (钉/秒)	≈ 2 nails/sec (钉/秒)	≈ 2 nails/sec (钉/秒)	≈ 2 nails/sec (钉/秒)	≈ 1 nails/sec (钉/秒)
Nail Range 钉子规格	F30	F38 / 9038	T50 / F30 / 9040	F50	F35	F50
Motor 电机	Brushless / Brush Optional 无刷/有刷选配	Brushless / Brush Optional 无刷/有刷选配	Brushless / Brush Optional 无刷/有刷选配	Brushless	Brushless	Brush

CARPENTRY SERIES

AF30
18 GA. 1-3/16" BRAD NAILER
气动AF30直钉枪



Applications / 应用

- Finish and Trim 装饰和收边
- Paneling 护墙板、墙板装饰
- Furniture 家具制作
- Cabinet Work 橱柜制作
- Crafts 工艺品

Product Specification / 产品参数	AF30
Fastener Size/钉子长度	15~30mm
Operating Pressure/工作气压	60~115psi(4~8Bar)
Magazine Capacity/装钉量	100pcs
Dimension/产品尺寸	235x55x191mm
Weight/产品重量	1.08kg

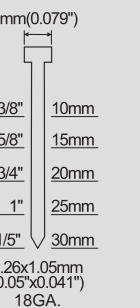

LAF55 **BL**
18 GA 2-1/8" CORDLESS BRAD NAILER
 锂电F55直钉枪

3 NAILS/S
 打钉快 1秒2下

ONLY 2.6KG
 仅重2.6kg

Applications / 应用

- Finish and Trim 装饰和收边
- Paneling 护墙板、墙板装饰
- Furniture 家具制作
- Cabinet Work 橱柜制作
- Crafts 工艺品

Product Specification / 产品参数	LAF55
Nail Range/Shank Range/钉子规格	15-55mm, 1.26x1.05mm
Magazine Capacity/装钉数量	100pcs
Strike Rate/打钉速率	120-180 nails/min (钉/分钟)
Battery Duration/续航能力	Up to 2400 pcs(4.0Ah) 满电打钉数约2400枚(4.0Ah)
Dimension (w/o battery)/产品尺寸(不含电池)	266X98X307mm
Weight (w/o battery)/产品重量(不含电池)	2.6kg

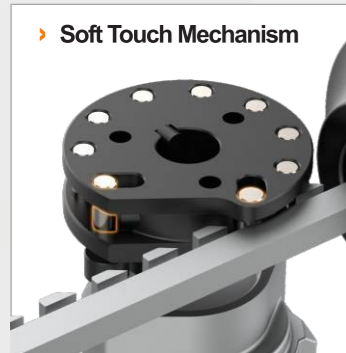
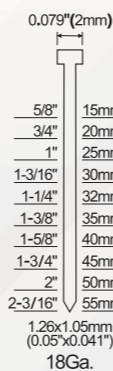

Soft Touch Mechanism

EXTENDED TOOL LIFE
 双活齿专利技术

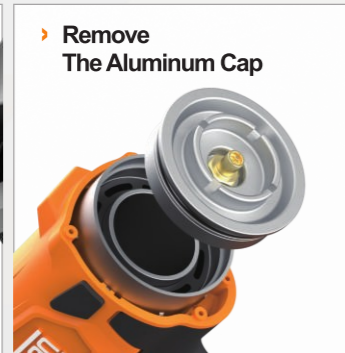

Remove The Aluminum Cap

EASY REPLACEMENT
 维修方便



STRENGTH ADJUSTABLE
 力度可调

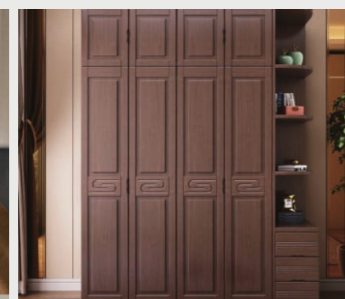

NEW

PATENT
 专利技术

F50
18 GA. 2" BRAD NAILER
 气动F50直钉枪

- REAR EXHAUST, QUIETER, SAFER
 尾排气功能, 低噪音, 更安全
- SMALL NOSE FOR PRECISE POSITIONING
 小嘴结构 精准定位

Applications / 应用

- Finish and Trim 装饰和收边
- Paneling 护墙板、墙板装饰
- Furniture 家具制作
- Cabinet Work 橱柜制作
- Crafts 工艺品

Product Specification / 产品参数	F50
Fastener Size/钉子规格	15-50mm
Operating Pressure/工作气压	60-110psi(4-7.5Bar)
Magazine Capacity/装钉量	100pcs
Dimension/产品尺寸	278x64x245mm
Weight/产品重量	1.46kg



REAR EXHAUST, QUIETER, SAFER
 尾排气功能, 低噪音, 更安全



ADJUSTABLE DEPTH
 打钉深度可调

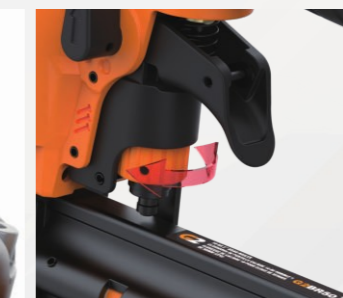

QUICK RELEASE, EASY JAM CLEARING
 快拆枪嘴, 轻松去卡钉



F50
18 GA. 2" BRAD NAILER
 气动F50直钉枪

Product Specification / 产品参数	F50
Fastener Size/钉子长度	16-50mm / 5/8"-2"
Fastener Type/钉子种类	18 GA. Brad Nails
Operating Pressure/工作气压	60-100psi(4-7Bar)
Magazine Capacity/装钉量	100pcs
Weight/产品重量	1.3kg



CARPENTRY SERIES

LD3232
18 GA. CORDLESS BRAD NAILER/STAPLER
锂电F32/432K两用钉枪

POWERFUL,
EASILY DRIVES NAILS
INTO DENSE ENGINEERED WOOD
力度大 轻松应对各种硬木

2-IN-1
F32/432K

Applications / 应用

Finish And Trim, Indoor Decoration, Sofa And Cabinet Making, Etc
家具制作, 室内装修, 沙发、橱柜制作等

Product Specification / 产品参数		LD3232
Nail Range/Shank Range/钉子规格	F nails: 15~32mm; Staples: 16~32mm	
Magazine Capacity/装钉数量	100pcs	
Strike Rate/打钉速率	120~180 nails/min (钉/分钟)	
Battery Duration/续航能力	Up to 8400 pcs(5.0Ah) 满电打钉数约8400枚(5.0Ah)	
Dimension (w/o battery)/产品尺寸(不含电池)	241x238x68mm	
Weight (w/o battery)/产品重量(不含电池)	1.9kg	



LD32425J
18 GA. & 20 GA.
CORDLESS BRAD NAILER/STAPLER
锂电F32/425J两用钉枪

2-IN-1
F32/425J



Applications / 应用

Finish And Trim, Indoor Decoration, Sofa And Cabinet Making, Etc
家具制作, 室内装修, 沙发、橱柜制作等

Product Specification / 产品参数		LD32425J
Nail Range/Shank Range/钉子规格	F nails: 15~32mm; Staples: 16~25mm	
Magazine Capacity/装钉数量	100pcs	
Strike Rate/打钉速率	120~180 nails/min (钉/分钟)	
Battery Duration/续航能力	Up to 8400 pcs(5.0Ah) 满电打钉数约8400枚(5.0Ah)	
Dimension (w/o battery)/产品尺寸(不含电池)	241x238x68mm	
Weight (w/o battery)/产品重量(不含电池)	1.9kg	

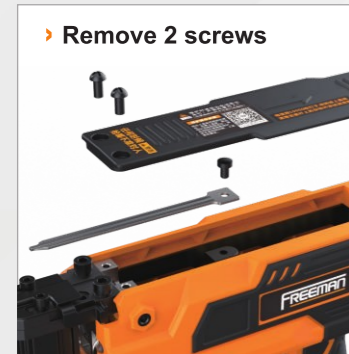

QUICK DRIVE BLADE SWAP
枪钉快换



MULTI-SPRING SHOCK ABSORPTION
多弹簧、抗反弹多项发明专利, 有效减震



智能保护 (过热/过流/过压)



LD3838
18 GA. CORDLESS BRAD NAILER/STAPLER
锂电F38/438K两用钉枪

2-IN-1
F38/438K



Applications / 应用

Finish And Trim, Indoor Decoration, Sofa And Cabinet Making, Etc
家具制作, 室内装修, 沙发、橱柜制作等

Product Specification / 产品参数		LD3838
Nail Range/Shank Range/钉子规格	F nails: 15~38mm; Staples: 16~38mm	
Magazine Capacity/装钉数量	100pcs	
Strike Rate/打钉速率	120~180 nails/min (钉/分钟)	
Battery Duration/续航能力	Up to 8400 pcs(5.0Ah) 满电打钉数约8400枚(5.0Ah)	
Dimension (w/o battery)/产品尺寸(不含电池)	230x68x245mm	
Weight (w/o battery)/产品重量(不含电池)	1.9kg	



XAGD509040 18 GA. 2-IN-1 AIR NAILER/STAPLER 二合一气动钉枪

2-IN-1 F30F50/440K

Product Specification / 产品参数		XAGD509040
Fastener Type/钉子种类	18 GA. 1/4" Narrow Crown Staples: 13-40mm / 1/2"-1-5/8" 18 GA. Brad Nails: 16-50mm / 5/8"-2"	
Operating Pressure/工作气压	60-110psi(4-7.5Bar)	
Magazine Capacity/装钉量	100pcs	
Weight/产品重量	1.34kg	

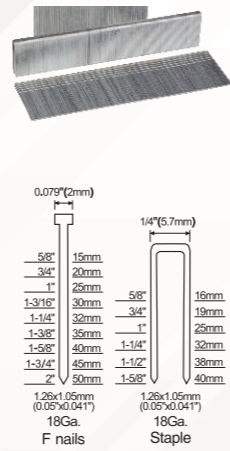

P635 23 GA. 1-3/8" Pin Nailer 气动635蚊钉枪

Product Specification / 产品参数		P635
Fastener Size/钉子长度	16-35mm / 5/8"-1-3/8"	
Fastener Type/钉子种类	23 GA. Headless Micro Pins	
Operating Pressure/工作气压	70-100psi(5-7Bar)	
Magazine Capacity/装钉量	100pcs	
Weight/产品重量	0.97kg	



LD635 23 GA. 1-1/2" CORDLESS HEADLESS PIN NAILER 锂电635蚊钉枪

► **POWERFUL**
EASILY DRIVES NAILS INTO
DENSE ENGINEERED WOOD
力度大 轻松应对颗粒板

Applications / 应用

- Home Renovation
家居装修
- Wood Working, Glazing Strips
木材、玻璃窗条
- Craft Work, Window Beading Making
工艺品、窗饰制作

Product Specification / 产品参数		LD635
Nail Range/Shank Range/钉子规格	15-35mm, ϕ 0.63mm	
Magazine Capacity/装钉数量	100pcs	
Strike Rate/打钉速率	120-180 nails/min (钉/分钟)	
Battery Duration/续航能力	Up to 8400 pcs(5.0Ah) 满电打钉数约8400枚(5.0Ah)	
Dimension (w/o battery)/产品尺寸(不含电池)	240x230x68mm	
Weight (w/o battery)/产品重量(不含电池)	1.9kg	



PATENT
专利技术

8400 PCS
5.0Ah

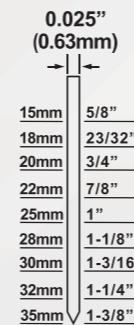

P625 23 GA. 1" Pin Nailer 气动625蚊钉枪

Product Specification / 产品参数		P625
Fastener Size/钉子长度	13-25mm / 1/2"-1"	
Fastener Type/钉子种类	23 GA. Headless Micro Pins	
Operating Pressure/工作气压	60-100psi(4-7Bar)	
Magazine Capacity/装钉量	100pcs	
Weight/产品重量	0.95kg	



P650 23 GA. 2" Pin Nailer 气动650蚊钉枪

Product Specification / 产品参数		P650
Fastener Size/钉子长度	16-50mm / 5/8"-2"	
Fastener Type/钉子种类	23 GA. Headless Micro Pins	
Operating Pressure/工作气压	70-110psi(5-7Bar)	
Magazine Capacity/装钉量	100pcs	
Weight/产品重量	1.0kg	

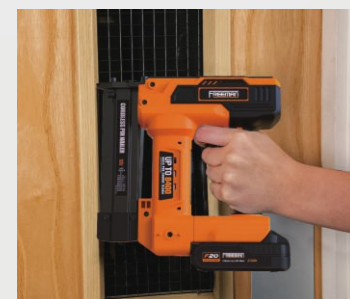
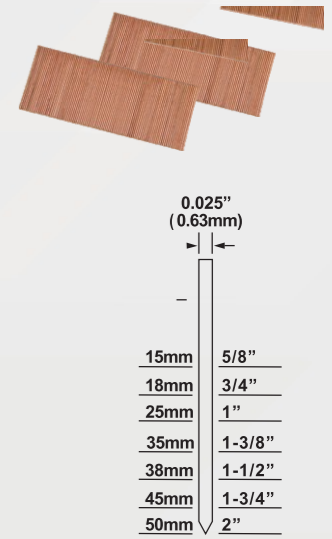

► Remove 2 screws



► Anti-rebound Quick Response



QUICK DRIVE BLADE SWAP
枪钉快换

MULTI-SPRING SHOCK ABSORPTION
多弹簧、抗反弹多项发明专利，有效减震

INTELLIGENT CONTROL
智能保护（过热/过流/过压）

34° 15 GA. Angle Finish Nail

- Finish and Trim 装饰和收边
- Furniture 家具制作
- Staircases 楼梯制作
- Cabinet Work 橱柜制作



16 GA. Finish Nail

- Finish and Trim 装饰和收边
- Furniture 家具制作
- Staircases 楼梯制作
- Cabinet Work 橱柜制作

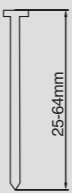

18 GA. Brad Nail

- Finish and Trim 装饰和收边
- Furniture 家具制作
- Crafts 工艺品
- Paneling 护墙板、墙板装饰
- Cabinet Work 橱柜制作

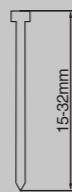
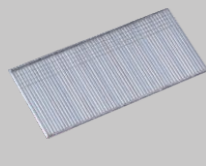

23 GA. HEADLESS PIN NAIL

- Home Renovation 家居装修
- Wood Working, Glazing Strips 木材、玻璃窗条
- Craft Work, Window Beading Making 工艺品、窗饰制作

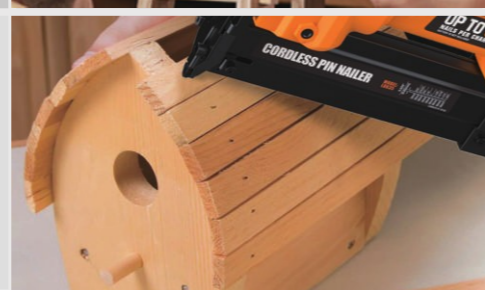

AIR COMPRESSOR SERIES

空压机系列

LK10L / LK6L / FCCZKT101 / LK4L / PSC15G / TA3GCOMP / PC6G

P21-P25



LD1013J
20 GA. 1/2" CORDLESS UPHOLSTERY STAPLER
锂电1013J码钉枪

8400 pcs
5.0Ah 锂电打钉8400枚

3 1秒3钉
NAILS/S

POWERFUL

Product Specification / 产品参数		LD1013F/LD1013J
Model/产品型号	LD1013F	LD1013J
Nail Range/Shank Range/钉子规格	6-13mm, 0.7x0.5mm	6-13mm, 1.2x0.6mm
Magazine Capacity/装钉数量	120pcs	
Strike Rate/打钉速率	120-180 nails/min (钉/分钟)	
Dimension (w/o battery)/产品尺寸(不含电池)	228x230x68mm	
Weight (w/o battery)/产品重量(不含电池)	1.9kg	



PATENT 专利技术

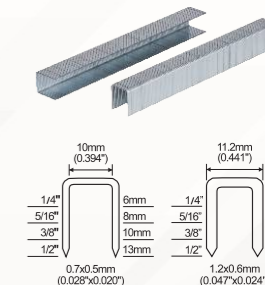

LD1022J
20 GA. 7/8" CORDLESS UPHOLSTERY STAPLER
锂电1022J码钉枪

8400 pcs
5.0Ah 锂电打钉8400枚

3 1秒3钉
NAILS/S

POWERFUL

Product Specification / 产品参数		LD1022J
Model/产品型号	LD1022J	
Nail Range/Shank Range/钉子规格	6-22mm, 1.2x0.6mm	
Magazine Capacity/装钉数量	120pcs	
Strike Rate/打钉速率	120-180 nails/min (钉/分钟)	
Dimension (w/o battery)/产品尺寸(不含电池)	228x230x68mm	
Weight (w/o battery)/产品重量(不含电池)	1.9kg	



PATENT 专利技术

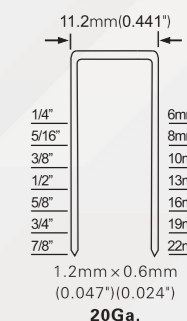

1013J
20 GA. 1/2" UPHOLSTERY STAPLER
气动1013J码钉枪

Product Specification / 产品参数		1013J
Fastener Size/钉子长度	6-13mm, 1.2x0.6mm	
Operating Pressure/工作气压	60-100psi(4-7Bar)	
Magazine Capacity/装钉量	100pcs	
Dimension/产品尺寸	208x46x160mm	
Weight/产品重量	0.82kg	

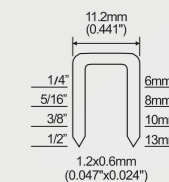

CARPENTRY SERIES

LD8016
21 GA. 5/8"
CORDLESS UPHOLSTERY STAPLER
锂电8016码钉枪



8400 pcs
5.0Ah 锂电打钉8400枚

3 1秒3钉
NAILS/S

POWERFUL

Applications / 应用

For Insulation, Wall Sheathing, Roofing Felt, Upholstery, Etc
隔热、房屋包装、屋面毛毯、室内装修等

Product Specification / 产品参数		LD8016
Nail Range/Shank Range/钉子规格	6-16mm, 0.95x0.66mm	
Magazine Capacity/装钉数量	120pcs	
Strike Rate/打钉速率	120-180 nails/min (钉/分钟)	
Battery Duration/续航能力	Up to 8400 pcs(5.0Ah) 满电打钉数约8400枚(5.0Ah)	
Dimension (w/o battery)/产品尺寸(不含电池)	241x238x68mm	
Weight (w/o battery)/产品重量(不含电池)	1.9kg	



8016
21 GA. 5/8"
UPHOLSTERY STAPLER
气动8016码钉枪

Product Specification / 产品参数	
Fastener Size/钉子长度	6-16mm, 0.95x0.66mm
Fastener Type/钉子种类	23 GA. Headless Micro Pins
Operating Pressure/工作气压	70-100psi(5-7Bar)
Magazine Capacity/装钉量	100pcs
Weight/产品重量	0.82kg



LDT15
20 GA. 5/8"
CORDLESS T50 STAPLER
锂电T15码钉枪



8400 pcs
5.0Ah 锂电打钉8400枚

3 1秒3钉
NAILS/S

POWERFUL

Product Specification / 产品参数		LDT15
Nail Range/Shank Range/钉子规格	6-15mm, 1.26x0.55mm	
Magazine Capacity/装钉数量	120pcs	
Strike Rate/打钉速率	120-180 nails/min (钉/分钟)	
Dimension (w/o battery)/产品尺寸(不含电池)	228x233x68mm	
Weight (w/o battery)/产品重量(不含电池)	1.9kg	



LD9040
18 GA. CORDLESS STAPLER
锂电440K码钉枪



2600 pcs
4.0Ah 锂电打钉2600枚

2 1秒2钉
NAILS/S

ANTI-REBOUND
抗反弹技术

Product Specification / 产品参数		LD9040
Nail Range/Shank Range/钉子规格	Staple: 16-40mm	
Magazine Capacity/装钉数量	100pcs	
Strike Rate/打钉速率	90-120 nails/min (钉/分钟)	
Dimension (w/o battery)/产品尺寸(不含电池)	310x278x113mm	
Weight (w/o battery)/产品重量(不含电池)	3.09kg	



7116
22 GA. 5/8"
UPHOLSTERY STAPLER
气动7116码钉枪

Product Specification / 产品参数		7116
Fastener Size/钉子长度	6-16mm / 1/4"-5/8"	
Fastener Type/钉子种类	22 GA. 3/8" Crown Staples	
Operating Pressure/工作气压	60-100psi(4-7Bar)	
Magazine Capacity/装钉量	140pcs	
Weight/产品重量	0.8kg	



FM9040
18 GA. 1-5/8"
NARROW CROWN STAPLER
 气动440K码钉枪 440K



Product Specification / 产品参数		FM9040
Fastener Size/ 钉子长度	16-40mm, 1.26x1.05mm	
Fastener Type/ 钉子种类	18 GA. Narrow Crown Staples	
Operating Pressure/ 工作气压	60-110psi(4-7.5Bar)	
Magazine Capacity/ 装钉量	100pcs	
Weight/ 产品重量	1.52kg	

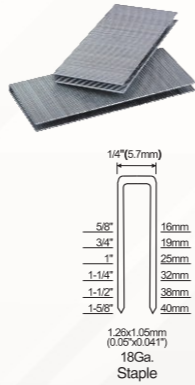

9040
18 GA. 1-5/8"
NARROW CROWN STAPLER
 气动440K码钉枪 440K

Product Specification / 产品参数		9040
Fastener Size/ 钉子长度	13-40mm / 1/2"-1-5/8"	
Fastener Type/ 钉子种类	18 GA. 1/4" Narrow Crown Staples	
Operating Pressure/ 工作气压	60-110psi(4-7.5Bar)	
Magazine Capacity/ 装钉量	100pcs	
Weight/ 产品重量	1.27kg	



9032
18 GA. 1-1/4"
NARROW CROWN STAPLER
 气动432K码钉枪 432K

Product Specification / 产品参数		9032
Fastener Size/ 钉子长度	13-32mm / 1/2"-1-1/4"	
Fastener Type/ 钉子种类	18 GA. 1/4" Narrow Crown Staples	
Operating Pressure/ 工作气压	60-100psi(4-7Bar)	
Magazine Capacity/ 装钉量	100pcs	
Weight/ 产品重量	1.17kg	

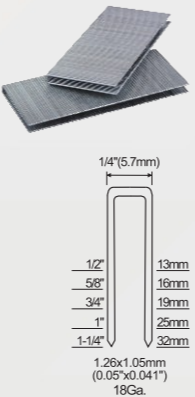

FMN851
16 GA. 2" MEDIUM CROWN STAPLER
 气动N851码钉枪

ONLY 2.4KG

- > **10 NAILS/SEC**
射速可达10钉/秒
- > **POWERFUL UP TO 65J**
动能可达65焦耳



Applications / 应用
 > Finish And Trim, Indoor Decoration, Sofa And Cabinet Making, Etc
 家具制作, 室内装修, 沙发、橱柜制作等

Product Specification / 产品参数		FMN851
Nail Range/Shank Range/ 钉子规格	19-50mm, 1.6x1.4mm	
Operating Pressure/ 工作气压	70-110psi(5-7.5Bar)	
Magazine Capacity/ 装钉量	140pcs	
Air Consumption/ 耗气量	6.6L/S	
Strike Rate/ 打钉速率	10 nails/sec	
Dimension/ 产品尺寸	358x108x310mm	
Weight/ 产品重量	2.4kg	

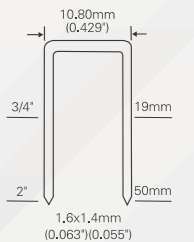

SINGLE FIRING / BUMP FIRING
单连发切换



ADJUSTABLE DEPTH
打钉深度可调



QUICK RELEASE, EASY JAM CLEARING
快拆枪嘴, 轻松去卡钉

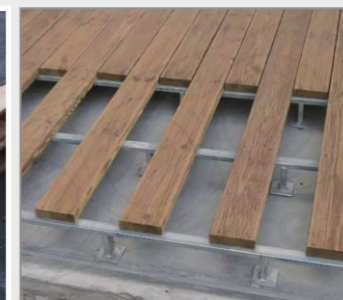

FPYHT01 HEAVY DUTY HAMMER TACKER 重型手敲枪

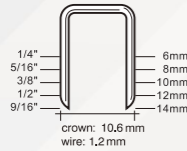

Applications / 应用

- Roofing And Insulation / Upholstery / Carpet Installation / Poly Sheeting
- 屋顶隔热层安装 / 室内装修 / 地毯安装 / 薄膜安装

Product Specification / 产品参数		FPYHT01
Fastener Type / 钉子种类		3/8" Crown Staples
Nail Range / 钉子长度		6-14mm
Weight / 产品重量		0.54 kg
Magazine Capacity / 容钉量		80pcs

- Durable Steel Construction**
Durability
- Comfort Grip Handle**
One hand operation
- Load And Unload Nails Quickly**
Easy jam release
- 耐用钢结构**
耐用
- 橡胶手柄**
单手操作使用舒适
- 底部装钉**
轻松装钉 / 卸钉

FPYHT02 LIGHT DUTY HAMMER TACKER 轻型手敲枪

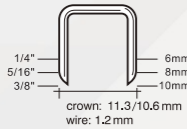

Applications / 应用

- Roofing And Insulation / Upholstery / Carpet Installation / Poly Sheeting
- 屋顶隔热层安装 / 室内装修 / 地毯安装 / 薄膜安装

Product Specification / 产品参数		FPYHT02
Fastener Type / 钉子种类		3/8" Crown Staples
Nail Range / 钉子长度		6-14mm
Weight / 产品重量		0.54 kg
Magazine Capacity / 容钉量		80pcs

- All steel construction**
Durability
- Comfort Grip Handle**
One hand operation
- Load And Unload Nails Quickly**
Easy jam release
- 全钢结构**
耐用
- 橡胶手柄**
单手操作使用舒适
- 底部装钉**
轻松装钉 / 卸钉

FPYSG01 MDEIUM DUTY STAPLE GUN 中型手动门钉枪

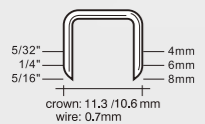

Applications / 应用

- Textiles / Leather / Netting / Molding / Framing
- 纺织面料 / 皮革 / 网 / 木框架装订

Product Specification / 产品参数	
Fastener Type / 钉子种类	Crown Staples
Fastener Range / 钉子长度	4-8mm
Magazine Capacity / 装钉量	80pcs
Weight / 产品重量	0.4 kg

- All Metal Construction**
全金属结构
- Light Duty, Compact And High Efficiency**
重量轻、结构紧凑、效率高
- Safety Lock**
手柄安全锁扣
- Surface: Paint Coating**
表面涂层

FPYSG01/FPYSG02 LIGHT / HEAVY DUTY 3 WAY STAPLE GUN 重型 / 轻型三合一打钉枪



Product Specification / 产品参数	
Fastener Type / 钉子种类	Crown Staples
Fastener Range / 钉子长度	4-14mm
Magazine Capacity / 装钉量	100pcs
Weight / 产品重量	0.54 kg

Product Specification / 产品参数	
Fastener Type / 钉子种类	Crown Staples
Fastener Range / 钉子长度	6-14mm
Magazine Capacity / 装钉量	80pcs
Weight / 产品重量	0.5 kg

20 GA. Upholstery Staple 1006J-1013J 码钉

- Upholstering
软装、软垫制作
- Furniture
家具制作
- Staircases
楼梯制作
- Cabinet Work
橱柜制作

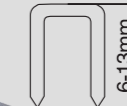

21 GA. Upholstery Staple 8006-8016 码钉

- Upholstery
软装、软垫制作
- Furniture
家具制作
- Staircases
楼梯制作
- Cabinet Work
橱柜制作

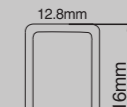

20 GA. Fine Wire Staple 1006A-1015A 码钉

- Insulation
隔热材料
- Roofing Felt
屋面油毡
- Upholstery
软装、软垫制作
- House Wrap
房屋包覆材料

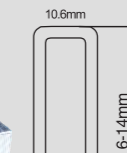

20 GA. Narrow Crown Staple 410J-425J 码钉

- Upholstering
软装、软垫制作
- Furniture
家具制作
- Cabinet Work
橱柜制作

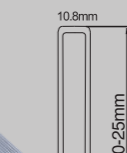

18GA. Narrow Crown Stapler K416-K440 码钉

- Finish and Trim
装饰和收边
- Furniture
家具制作
- Crafts
工艺品
- Staircases
楼梯制作
- Cabinet Work
橱柜制作
- Paneling
护墙板、墙板装饰

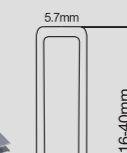

16GA. Medium Crown Staple N819-N851 码钉

- Medium Duty Structural Assembly
中等强度结构组装
- Plywood Frame Assembly
胶合板框架组装
- Sheathing
护板、覆层、外壳
- Truss Assembly
桁架组装





FMCN90
15° 3-1/2" COIL FRAMING NAILER
 气动90卷钉枪

ONLY **3.4KG**

- › **10 NAILS/SEC**
射速可达10钉/秒
- › **MAGNESIUM BODY, LIGHT WEIGHT**
镁合金枪体 重量更轻
- › **POWERFUL WITH LESS RECOIL**
力度大 反弹力小

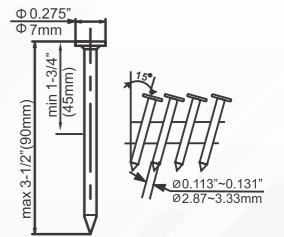

Applications / 应用

- › **Wooden pallet, crate, container box making, large furniture assembling and wood roof installation**
木托盘、板条箱、出口包装箱
框架等制作、大型家具组合以及木屋屋顶等

Product Specification / 产品参数		FMCN90
Fastener Size/钉子长度	Plastic collation/塑排: 32-90mm Wire collation/线排: 45-90mm	
Operating Pressure/工作气压	70-115psi(5-8Bar)	
Air Consumption/耗气量	5.3L/S	
Magazine Capacity/装钉量	300pcs	
Dimension/产品尺寸	357x130x368mm	
Weight/产品重量	3.4kg	



CARPENTRY SERIES



SINGLE FIRING / BUMP FIRING
单连发切换



ADJUSTABLE DEPTH
打钉深度可调



SAFETY MECHANISM
安全保险



360 DEGREE ROTATING BELT HOOK
360°旋转挂钩

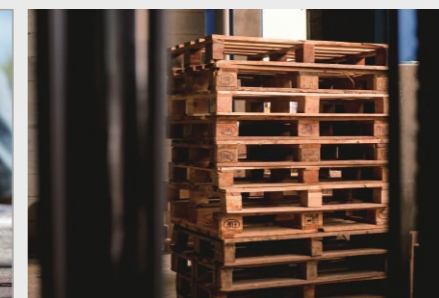

COIL NAILER SERIES

卷钉枪系列

FMCN90 / FMCN75 / FMCN65 / FMCN45 / CN65 / CN50 / CN45

FMCN75
15° 3" COIL SIDING & FRAMING NAILER

气动75卷钉枪

ONLY
3.0KG

Product Specification / 产品参数		FMCN75
Fastener Size/钉子长度	Plastic collation/塑排: 32-75mm Wire collation/线排: 45-75mm	
Operating Pressure/工作气压	70-115psi(5-8Bar)	
Air Consumption/耗气量	5.3L/S	
Magazine Capacity/装钉量	300pcs	
Dimension/产品尺寸	348x130x315mm	
Weight/产品重量	3.0kg	



FMCN65
15° 2-1/2" COIL SIDING NAILER

气动65卷钉枪

ONLY
2.5KG

Product Specification / 产品参数		FMCN65
Fastener Size/钉子长度	Plastic collation/塑排: 32-65mm Wire collation/线排: 45-65mm	
Operating Pressure/工作气压	70-115psi(5-8Bar)	
Air Consumption/耗气量	5.3L/S	
Magazine Capacity/装钉量	300pcs	
Dimension/产品尺寸	333x130x308mm	
Weight/产品重量	2.5kg	



FMCN45
15° 1-3/4" COIL ROOFING NAILER

气动45卷钉枪

ONLY
2.5KG

Product Specification / 产品参数		FMCN45
Fastener Size/钉子长度	19-45mm	
Operating Pressure/工作气压	70-115psi(5-8Bar)	
Air Consumption/耗气量	5.3L/S	
Magazine Capacity/装钉量	300pcs	
Dimension/产品尺寸	327x115x263mm	
Weight/产品重量	2.5kg	



Plastic Collated Siding Nails
塑排卷钉

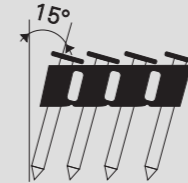
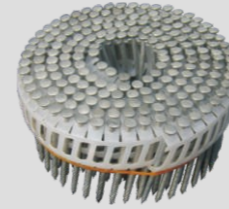

Wire Collated Siding Nails
铁排卷钉

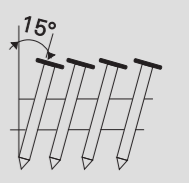
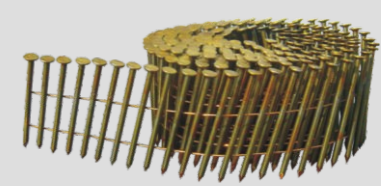

Coil Roofing Nails
大幅卷钉

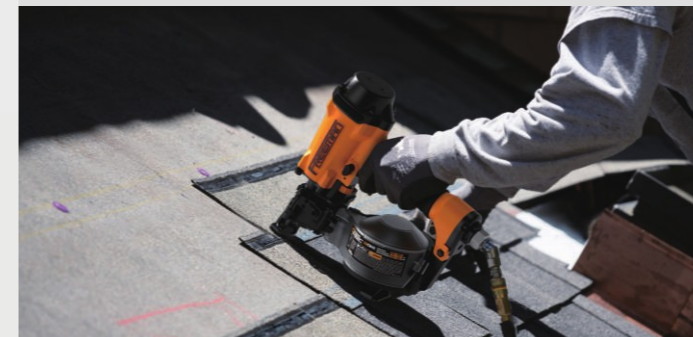
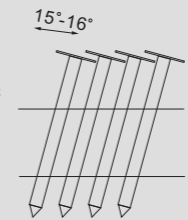
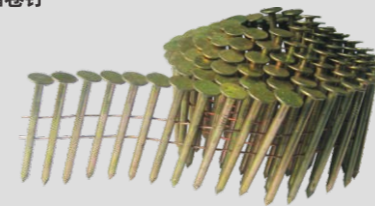

CN65
15° 2-1/2" COIL SIDING NAILER
气动65卷钉枪

ONLY
2.7KG

Product Specification / 产品参数		CN65
Fastener Size/钉子长度	15° Plastic Collated Coil Siding Nails: 32-65mm / 1-1/4"-2-1/2"	
	15° Wire Collated Siding Nails: 45-65mm / 1-3/4"-2-1/2"	
Operating Pressure/工作气压	70-110psi(5-7.5Bar)	
Magazine Capacity/装钉量	400pcs	
Weight/产品重量	2.74kg	



CN50
15° 2" COIL SIDING NAILER
气动50卷钉枪

ONLY
2.6KG

Product Specification / 产品参数		CN50
Fastener Size/钉子长度	27-50mm / 1-1/16"-2"	
Fastener Type/钉子种类	15° Coil Siding Nails	
Operating Pressure/工作气压	70-115psi(5-8Bar)	
Magazine Capacity/装钉量	400pcs	
Weight/产品重量	2.59kg	



CN45
15° 1-3/4" COIL ROOFING NAILER
气动45卷钉枪

ONLY
2.7KG

Product Specification / 产品参数		CN45
Fastener Size/钉子长度	19-45mm / 3/4"-1-3/4"	
Fastener Type/钉子种类	15° Coil Roofing Nails	
Operating Pressure/工作气压	70-115psi(5-8Bar)	
Magazine Capacity/装钉量	120pcs	
Weight/产品重量	2.73kg	



CORDLESS HOG RING TOOL
锂电C型封口钳

LDC24
LDC24E (长嘴)
LDC17

3 NAIL/S
打钉快 1秒3钉

6500 PCS
5.0Ah

Applications / 应用

Wire Cages, Chain Link Fencing,
Spring Mattress, Bag Closure
铁丝笼制作, 链式围栏, 弹簧床垫制作, 包装封口等

Product Specification / 产品参数		LDC24
Nail Range/Shank Range/钉子规格	16 GA. C-Rings	
Magazine Capacity/装钉数量	100pcs	
Strike Rate/打钉速率	120-180 nails/min (钉/分钟)	
Battery Duration/续航能力	Up to 6500 pcs(5.0Ah) 满电打钉数约6500枚(5.0Ah)	
Dimension (w/o battery)/产品尺寸(不含电池)	340x260x100mm	
Weight (w/o battery)/产品重量(不含电池)	2.75kg	



NEW

PATENT
专利技术



INTELLIGENT CONTROL
智能保护 (过热/过流/过压)

C20
16 GA. HOG RING PLIERS
C型封口钳

Applications / 应用

Wire Mesh Binding, Cage Fixing,
Packaging And Sealing
丝网捆扎/笼子固定/包装封口

Product Specification / 产品参数	
Fastener Type/钉子种类	16 GA. C-Rings
Nail Range/钉子长度	6-10mm
Dimension/产品尺寸	190x110x22mm
Weight/产品重量	0.4 kg
Magazine Capacity/容量	50pcs



- Metal Construction 硬质合金组件
- One-hand Operation Design 单手操作设计
- Automatic Feed System 自动送料
- Ergonomic Grip 人机工程学手柄

PF20LM
20 GA. L-Cleat Flooring Nailer
双塑柄气动地板枪

› **ENGINEERING COMPOSITE PLASTIC,**
PROTECTS FLOORING SURFACE
复合材料垫板, 保护地板表面

› **INSTALLS FLOORING:**
1M² IN 3 MINS
安装1m²地板仅需3分钟

Applications / 应用

› Solid Wood Flooring Installation
实木地板安装

Product Specification / 产品参数

Nail Range/Shank Range/钉子规格	L Cleats: 32-45mm, Ø6mm
Operating Pressure/工作气压	70-115psi(4-8Bar)
Magazine Capacity/装钉量	120pcs
Dimension/产品尺寸	430x100x550mm
Weight/产品重量	4.15kg



FM45L
HARDWOOD FLOORING NAILER
竹地板枪

› **ENGINEERING COMPOSITE PLASTIC,**
PROTECTS FLOORING SURFACE
复合材料垫板, 保护地板表面

› **INSTALLS FLOORING:**
1M² IN 3 MINS
安装1m²地板仅需3分钟

Applications / 应用

› Solid Wood Flooring Installation
实木地板安装

Product Specification / 产品参数

Nail Range/Shank Range/钉子规格	L Cleats: 32-45mm, Ø6mm	FM45L
Operating Pressure/工作气压	70-115psi(4-8Bar)	
Magazine Capacity/装钉量	120pcs	
Dimension/产品尺寸	430x100x550mm	
Weight/产品重量	4.15kg	

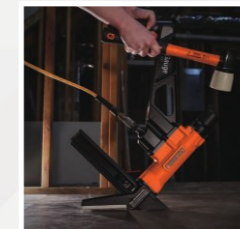

FW
ROLLING PLATE
地板枪滚轮

› **5 TIMES FASTER**
效率提升5倍

› **ACCURATE, FAST PLACEMENT**
精准、快速定位

› **WIDE COMPATIBILITY**
Suitable for 10-20mm Flooring Thickness
适用10~20mm范围内地板



Applications / 应用

› Solid Wood Flooring Installation
实木地板安装

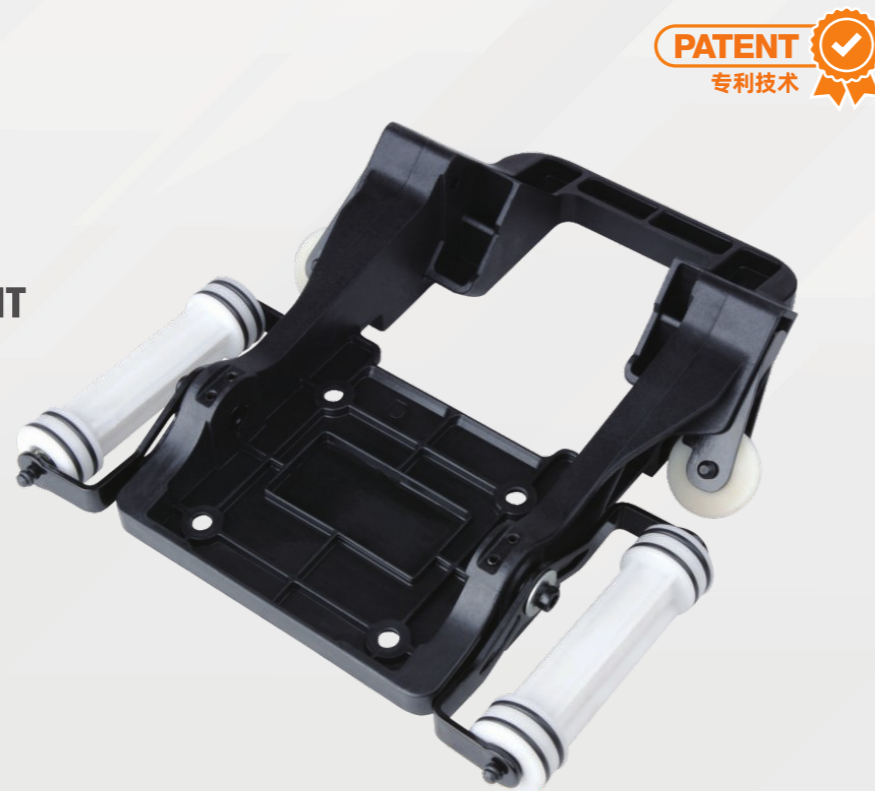

PDX50Q
3-IN-1 15.5 GA. & 16 GA.
FLOORING NAILER & STAPLER
三合一气动地板枪

3-IN-1

› **ENGINEERING COMPOSITE PL**
PROTECTS FLOORING SURFACE
复合材料垫板, 保护地板表面



Applications / 应用

› Solid Wood Flooring Installation
实木地板安装



DPN350S
MINI PALM NAILER

气动掌中锤(气动榔头)

▶ EASY ONE-HAND NAIL SHOOTING

单手操作 抓着就能打

▶ MAGNETIC NAIL HOLDER

强磁枪嘴 防钉脱落

▶ 360° ROTATING NOSE

狭小空间 灵活作业

Applications / 应用

▶ Apply to wood frame and hard to reach work space
木结构打钉、散钉、补丁及位置狭小处打钉等

Product Specification / 产品参数	DPN350S
Nail Range/Shank Range/钉子规格	50-100mm
Operating Pressure/工作气压	80-110psi(5.5-7Bar)
Magazine Capacity/装钉量	1pcs
Dimension/产品尺寸	80x110x70mm
Weight/产品重量	0.63kg

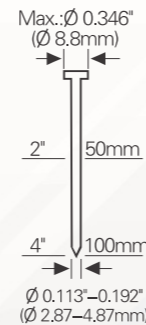

DPN50LT
PALM FLOORING NAILER

边角气动锤

▶ WORK AT ANY TIGHT AREAS

狭小空间 灵活作业

▶ MAGNETIC NAIL HOLDER

强磁枪嘴 防钉脱落

▶ 360° ROTATING NOSE

360°旋转枪嘴



360°

Product Specification / 产品参数	DPN50LT
Fastener Size/钉子规格	T Cleats / L Cleats
Operating Pressure/工作气压	80-115psi(5.5-8Bar)
Magazine Capacity/装钉量	1pcs
Dimension/产品尺寸	100x70x130mm
Weight/产品重量	0.72kg

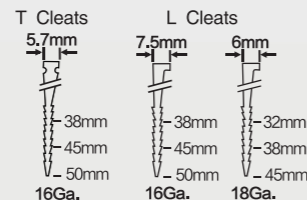

PWC200
16 GA. P-STYLE
WIDE CROWN STAPLER

气动P钉码钉枪

Product Specification / 产品参数	PWC50
Fastener Size/钉子长度	16-50mm / 5/8"-2"
Fastener Type/钉子种类	16 GA. P Style 1" Wide Crown Staples
Operating Pressure/工作气压	70-115psi(5-8Bar)
Magazine Capacity/装钉量	140pcs
Weight/产品重量	2.64kg

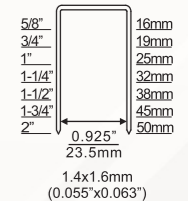

CS16
CORRUGATED STAPLER

气动CS16浪钉枪

Product Specification / 产品参数	CS16
Fastener Size/钉子长度	6-16mm / 1/4"-5/8"
Fastener Type/钉子种类	W Type Corrugated Staples
Operating Pressure/工作气压	70-115psi(5-8Bar)
Magazine Capacity/装钉量	80pcs
Weight/产品重量	2.66kg

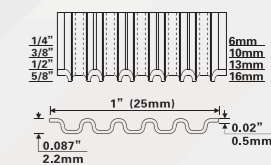

KBD50
HEAVY DUTY PUNCH NAILER

气动KBD50拔钉枪

Product Specification / 产品参数	KBD50
Fastener Type/钉子种类	7-14GA.(0.083"-0.18")
Operating Pressure/工作气压	70-115psi(5-8Bar)
Magazine Capacity/装钉量	1pcs
Weight/产品重量	1.27kg





21° Plastic Collated Round Head Framing Nail 2150-2190 塑排斜钉

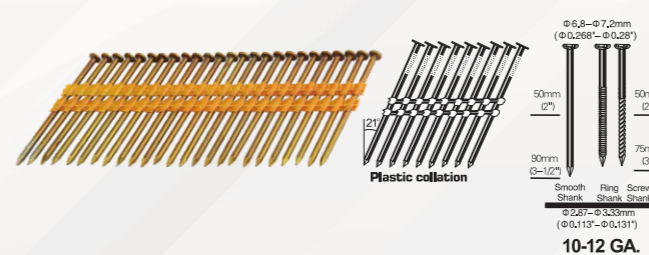

Product Specification / 产品参数	
Model/产品型号	21° Framing Nails/21° 塑排斜钉
Nail Range/Shank Range/钉子规格	50-90mm, ϕ 2.87-3.33mm
Applicable nailer model/适用钉枪型号	LD2190 / L2183 / FM2190 / XI2190 / DP2190

34° Paper Collated Framing Nail 3450-34100 纸排斜钉

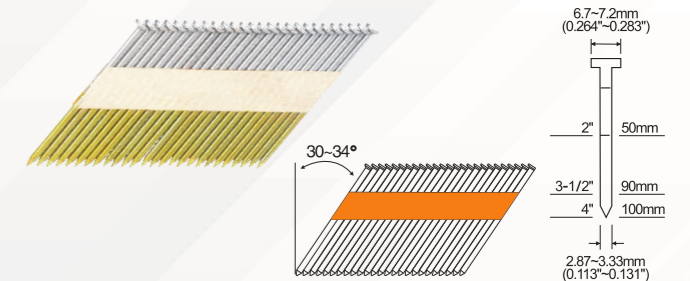

Product Specification / 产品参数	
Model/产品型号	Paper Collation(50-100mm/34°) / 34° 纸排斜钉
Nail Range/Shank Range/钉子规格	50-100mm, 2.87-3.33mm
Applicable nailer model/适用钉枪型号	LD3490 / LD34100 / L3483 / FM3483 / X13490

Strip Concrete Pin 塑排钢钉

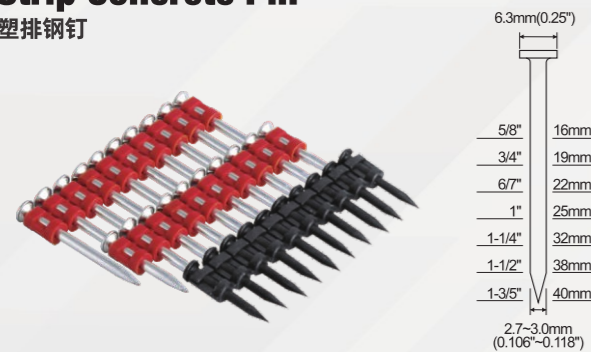

Product Specification / 产品参数	
Model/产品型号	Strip Concrete Pin/塑排钢钉
Nail Range/Shank Range/钉子规格	16-40mm, ϕ 2.7-3.0mm
Applicable nailer model/适用钉枪型号	LD40 / XI38

Medium Crown Staples N819-N851 码钉

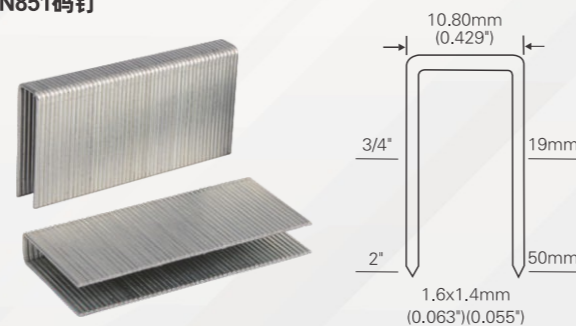

Product Specification / 产品参数	
Model/产品型号	Medium Crown Staples/N819-N851 码钉
Nail Range/Shank Range/钉子规格	19-50mm, 1.6x1.4mm
Applicable nailer model/适用钉枪型号	FMN851 / XJK851

15 GA. Angle Finish Nails 1532-1564 斜钉

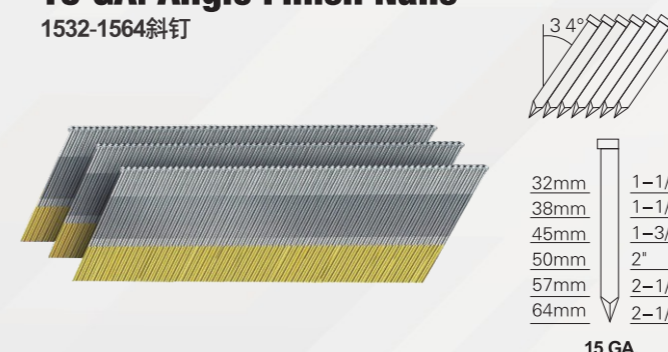

Product Specification / 产品参数	
Model/产品型号	15 GA. Angle Finish Nails/15GA. 斜钉
Nail Range/Shank Range/钉子规格	32-64mm
Applicable nailer model/适用钉枪型号	XOKC1564 / PFN1564

9 GA. Fencing Staples 9GA. 篱笆钉

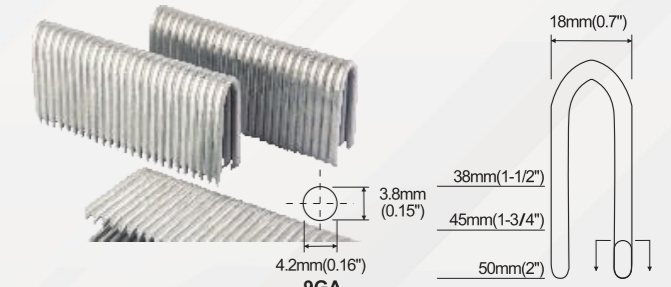

Product Specification / 产品参数	
Model/产品型号	9 GA. Fencing Staples / 9GA. 篱笆钉
Nail Range/Shank Range/钉子规格	38-50mm, 38x4.2mm
Applicable nailer model/适用钉枪型号	LD400 / XI400

Coil Roofing Nails 大帽卷钉

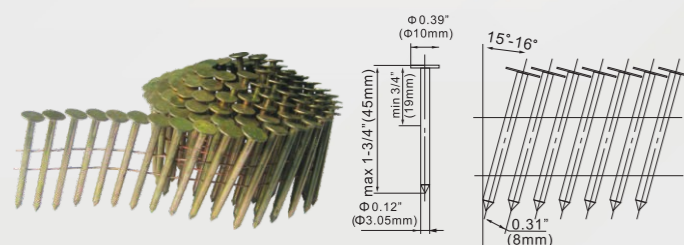

Product Specification / 产品参数	
Model/产品型号	Collated Coil Nails/大帽卷钉
Nail Range/Shank Range/钉子规格	19-45mm, ϕ 3.05mm
Applicable nailer model/适用钉枪型号	FMCN45 / RN45 / XRKC45

Plastic or Wire Collated Siding Nails 铁排/塑排卷钉

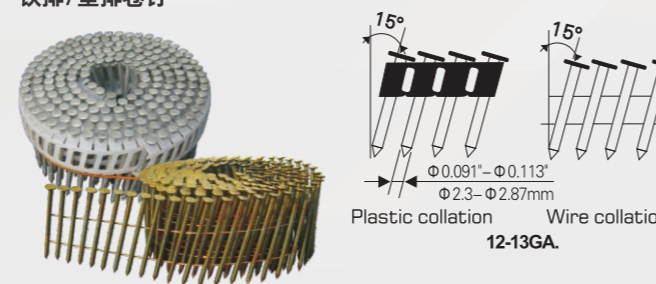

Product Specification / 产品参数	
Model/产品型号	Plastic or Wire Collated Siding / 铁排/塑排卷钉
Nail Range/Shank Range/钉子规格	Plastic collation/塑排: 32-65mm (1-1/4"-2-1/2") Wire collation/线排: 45-65mm (1-3/4"-2-1/2")
Applicable nailer model/适用钉枪型号	FMCN65 / FMCN75 / FMCN90 / XRKC65

18 GA. Narrow Crown Staples K416-K440 码钉

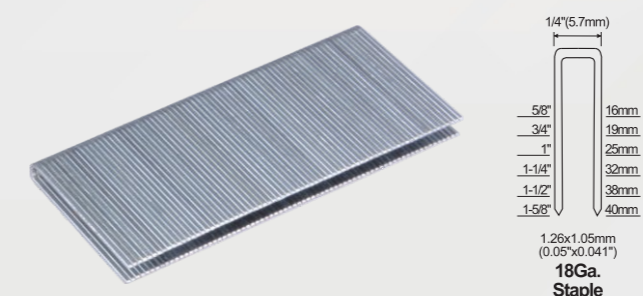

Product Specification / 产品参数	
Model/产品型号	18 GA. Narrow Crown Staples/K416-K440 码钉
Nail Range/Shank Range/钉子规格	16-40mm, 1.26x1.05mm
Applicable nailer model/适用钉枪型号	LD509040T50 / FM509040 / LD509040 / RN440K / XAGD509040T50 / YF504050P

20 GA. Narrow Crown Staples 410J-425J 码钉

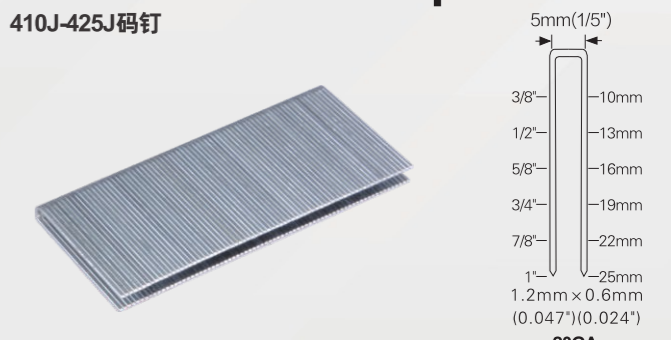

Product Specification / 产品参数	
Model/产品型号	20 GA. Narrow Crown Staples/410J-425J 码钉
Nail Range/Shank Range/钉子规格	10-25mm, 1.2x0.6mm
Applicable nailer model/适用钉枪型号	LD32/425J / XAGD32/425J / XAGD422J.

20 GA. Fine Wire Staples

1006A-1015A码钉

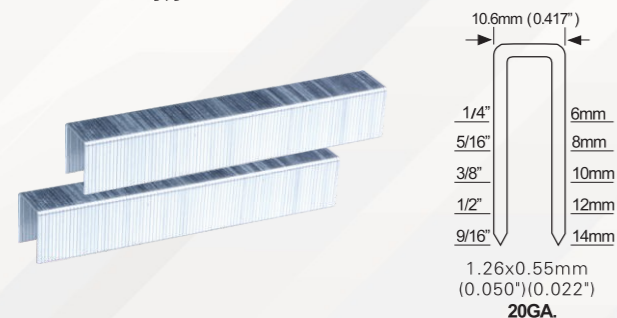

Product Specification / 产品参数

Model/产品型号	20 GA. Fine Wire Staples/1006A-1015A码钉
Nail Range/Shank Range/钉子规格	6-15mm, 1.26x0.55mm
Applicable nailer model/适用钉枪型号	LDT15 / PET15 / FMT15 / DPT15 / XMT15

20 GA. Upholstery Staples

1006J-1013J码钉

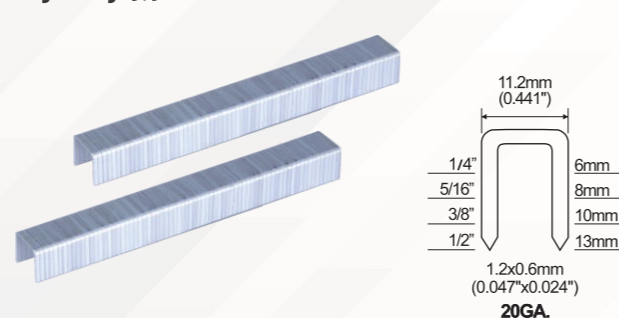

Product Specification / 产品参数

Model/产品型号	20 GA. Upholstery Staples/1006J-1013J码钉
Nail Range/Shank Range/钉子规格	6-13mm, 1.2x0.6mm
Applicable nailer model/适用钉枪型号	PEGD1013J / LD1013J

16 GA. Fencing Staples

16GA. 篱笆钉

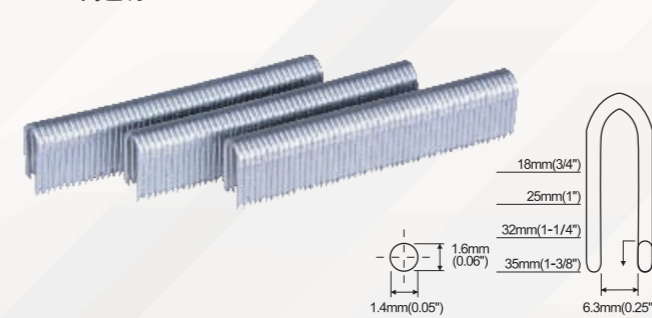

Product Specification / 产品参数

Model/产品型号	16 GA. Fencing Staples/16GA. 篱笆钉
Nail Range/Shank Range/钉子规格	18-35mm, 1.6x1.4mm
Applicable nailer model/适用钉枪型号	FS16G

10.5 GA. Fencing Staples

10.5GA. 篱笆钉

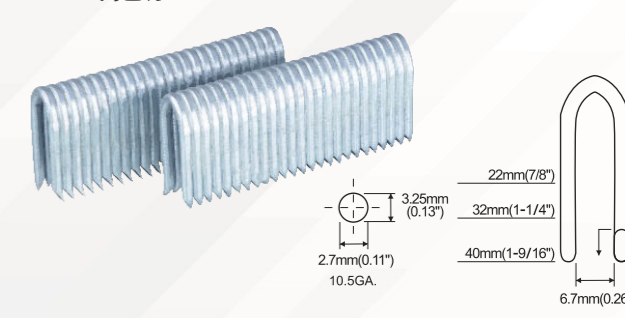

Product Specification / 产品参数

Model/产品型号	9 GA. Fencing Staples / 10.5GA. 篱笆钉
Nail Range/Shank Range/钉子规格	22-40mm, 2.7x3.25mm
Applicable nailer model/适用钉枪型号	LD315 / XJKC315

21 GA. Upholstery Staples

8006-8016码钉

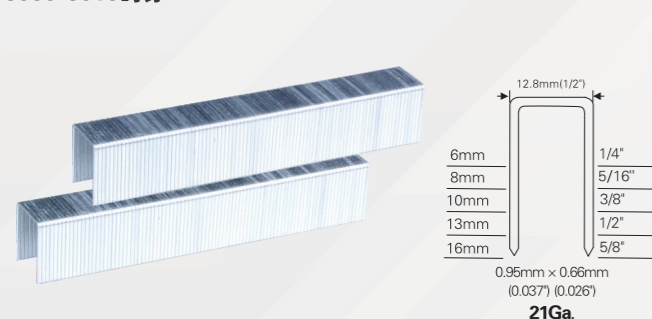

Product Specification / 产品参数

Model/产品型号	21 GA. Upholstery Staples / 8006-8016码钉
Nail Range/Shank Range/钉子规格	6-16mm, 0.95x0.66mm
Applicable nailer model/适用钉枪型号	LD8016P / PEGD8016 / FM8016 / XMGD8016

16 GA. Straight Finish Nails

T20-T64直钉

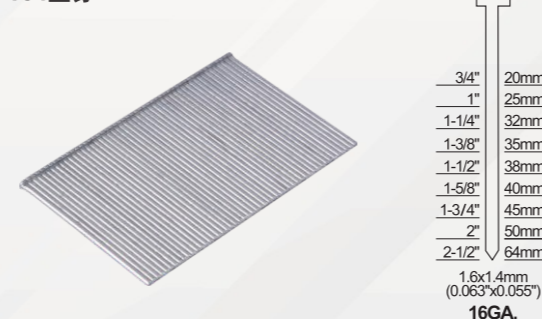

Product Specification / 产品参数

Model/产品型号	16 GA. Straight Finish Nails/F直钉
Nail Range/Shank Range/钉子规格	20-64mm, 1.6x1.4mm
Applicable nailer model/适用钉枪型号	LDT64 / LDT50 / LD509040T50 / FMT64 / XAGD509040T50 / PGGD50 / XKKC64.

18-64mm Concrete Nails

ST18-ST64钢钉

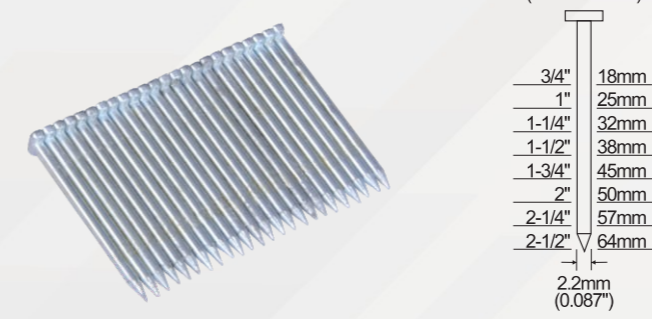

Product Specification / 产品参数

Model/产品型号	18-64mm Concrete Nails/ST18-ST64钢钉
Nail Range/Shank Range/钉子规格	18-64mm, φ2.2mm
Applicable nailer model/适用钉枪型号	LDST18 / LDST64 / XJGD64 / FMST64 / XJGD64T64.

Concrete T Nails

FST18-FST50黑钢钉



Product Specification / 产品参数

Model/产品型号	Concrete T Nails / FST18-FST50黑钢钉
Nail Range/Shank Range/钉子规格	18-50mm, φ1.8mm
Applicable nailer model/适用钉枪型号	PFGD50 / LDFST18 / FST50

18 GA. Brad Nails

F10-F50直钉

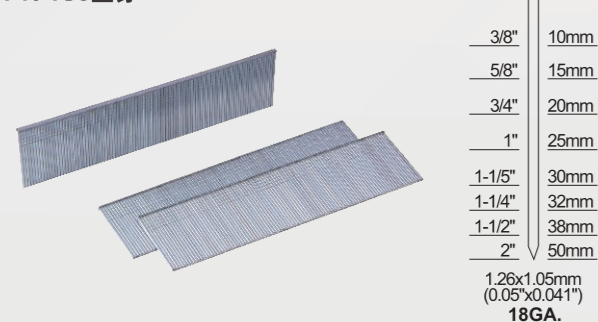

Product Specification / 产品参数

Model/产品型号	18 GA. Brad Nails/F直钉
Nail Range/Shank Range/钉子规格	10-50mm, 1.26x1.05mm
Applicable nailer model/适用钉枪型号	LDF30 / LDF50 / LD509040T50 / XAGD50 / AF30 / XAGD509040 / XAGD509040T50

23 GA. Pin Nails

P615-P650蚊钉

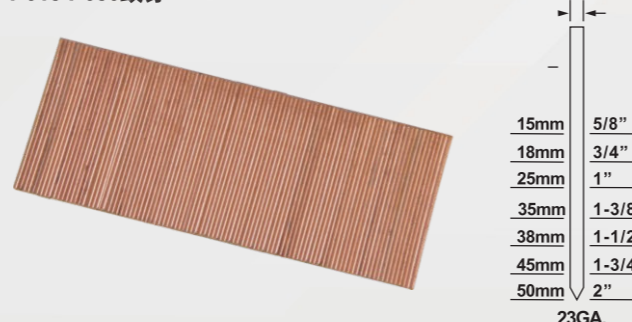

Product Specification / 产品参数

Model/产品型号	23 GA. Pin Nails/P615-P650蚊钉
Nail Range/Shank Range/钉子规格	15-50mm / 5/8"-2"
Applicable nailer model/适用钉枪型号	LD635 / PEGD625 / PEGD635

16 GA. L Cleats

L型地板钉



Product Specification / 产品参数

Model/产品型号	16GA. L Cleats / L型地板钉
Nail Range/Shank Range/钉子规格	16GA. L Cleats:38-50mm, 7.2mm
Applicable nailer model/适用钉枪型号	PB50ULT / DFQ50A / 618BRG / HDFL50Q

15-1/2 GA. Flooring Staples

地板码钉

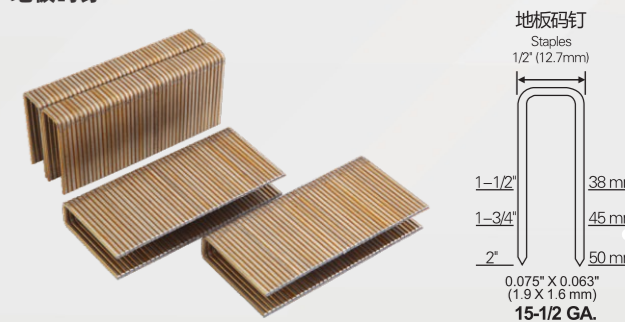

Product Specification / 产品参数

Model/产品型号	15-1/2 GA. Staples/地板码钉
Nail Range/Shank Range/钉子规格	38-50mm, 1.9x1.6mm
Applicable nailer model/适用钉枪型号	PB50ULT / DFQ50A / 618BRG / HDFL50Q