

MaxiSys MS908CV II

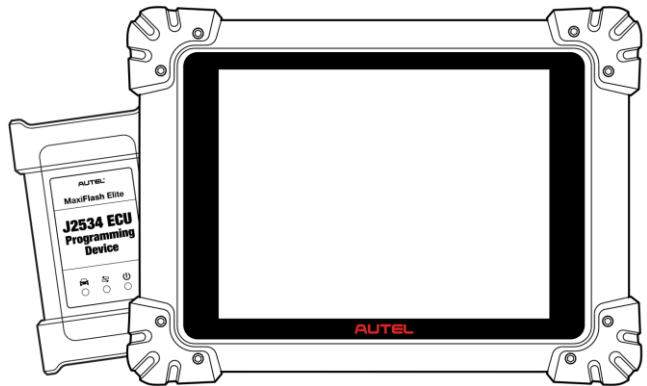

Trademarks

Autel®, MaxiSys®, MaxiDAS®, MaxiScan®, MaxiTPMS®, MaxiRecorder®, and MaxiCheck® are trademarks of Autel Intelligent Technology Corp., Ltd., registered in China, the United States, and other countries. All other marks are trademarks or registered trademarks of their respective holders.

Copyright Information

No part of this manual may be reproduced, stored in a retrieval system or transmitted in any form or by any means electronic, mechanical, photocopying, recording, or otherwise without the prior written permission of Autel.

Disclaimer of Warranties and Limitation of Liabilities

All information, specifications and illustrations in this manual are based on the latest information available at the time of printing.

Autel reserves the right to make changes at any time without notice. While information of this manual has been carefully checked for accuracy, no guarantee is given for the completeness and correctness of the contents, including but not limited to the product specifications, functions, and illustrations.

Autel will not be liable for any direct, special, incidental, or indirect damages, or for any economic consequential damages (including the loss of profits) as a result of using this product.

IMPORTANT

Before operating or maintaining this unit, please read this manual carefully, paying extra attention to the safety warnings and precautions.

For Services and Support



pro.autel.com

www.autel.com



1-855-288-3587 (North America)

+86 (0755) 8614-7779 (China)



support@autel.com

For technical assistance in all other markets, please refer to *Technical Support* in this manual.

Safety Information

For your own safety and the safety of others, and to prevent damage to the device and vehicles upon which it is used, it is important that the safety instructions presented throughout this manual be read and understood by all persons operating or coming into contact with the device.

There are numerous procedures, techniques, tools, and parts required for servicing vehicles, as well as the skills of the person doing the work. Because of the vast number of test applications and variations in the products that can be tested with this equipment, we cannot possibly anticipate or provide advice or safety messages to cover every circumstance. It is the automotive technician's responsibility to be knowledgeable of the system being tested. It is crucial to use proper service methods and test procedures. It is essential to perform tests in an appropriate and acceptable manner that does not endanger your safety, the safety of others in the work area, the device being used, or the vehicle being tested.

Before using the device, always refer to and follow the safety messages and applicable test procedures provided by the manufacturer of the vehicle or equipment being tested. Use the device only as described in this manual. Be sure to read, understand, and follow all safety messages and instructions in this manual.

Safety Messages

Safety messages are provided to help prevent personal injury and equipment damage. All safety messages are introduced by a signal word indicating the hazard level.

DANGER

Indicates an imminently hazardous situation which, if not avoided, could result in death or serious injury to the operator or to bystanders.

WARNING

Indicates a potentially hazardous situation which, if not avoided, could result in death or serious injury to the operator or to bystanders.

Safety Instructions

The safety messages herein cover situations Autel is aware of at the time of publication. Autel cannot know, evaluate or advise you as to all of the possible hazards. You must be certain that any condition or service procedure encountered does not jeopardize your personal safety.

 **DANGER**

When an engine is operating, keep the service area WELL VENTILATED or attach a building exhaust removal system to the engine exhaust system. Engines produce carbon monoxide, an odorless, poisonous gas that causes slower reaction time and can lead to serious personal injury or loss of life.

 **It is not advised to use headphones at a high volume**

Listening at high volumes for long periods of time may result in loss of hearing.

 **Safety Warnings**

- Always perform automotive testing in a safe environment.
- Wear safety eye protection that meets ANSI standards.
- Keep clothing, hair, hands, tools, test equipment, etc. away from all moving or hot engine parts.
- Operate the vehicle in a well-ventilated work area, for exhaust gases are poisonous.
- Put the transmission in PARK (for automatic transmission) or NEUTRAL (for manual transmission) and make sure the parking brake is engaged.
- Put blocks in front of the drive wheels and never leave the vehicle unattended while testing.
- Be extra cautious when working around the ignition coil, distributor cap, ignition wires and spark plugs. These components create hazardous voltages when the engine is running.
- Keep a fire extinguisher suitable for gasoline, chemical, and electrical fires nearby.
- Do not connect or disconnect any test equipment while the ignition is on or the engine is running.
- Keep the test equipment dry, clean, free from oil, water or grease. Use a mild detergent on a clean cloth to clean the outside of the equipment as necessary.
- Do not drive the vehicle and operate the test equipment at the same time. Any distraction may cause an accident.
- Refer to the service manual for the vehicle being serviced and adhere to all diagnostic procedures and precautions. Failure to do so may result in personal injury or damage to the test equipment.
- To avoid damaging the test equipment or generating false data, make sure the vehicle battery is fully charged and the connection to the vehicle DLC is clean and secure.
- Do not place the test equipment on the distributor of the vehicle. Strong electro-magnetic interference can damage the equipment.

CONTENTS

1 USING THIS MANUAL	1
1.1 CONVENTIONS	1
1.1.1 Bold Text	1
1.1.2 Notes and Important Messages.....	1
1.1.3 Hyperlinks.....	1
1.1.4 Illustrations	1
1.1.5 Procedures	2
2 GENERAL INTRODUCTION	3
2.1 MAXISYS MS908CV II TABLET.....	3
2.1.1 Function Description.....	3
2.1.2 Power Sources	5
2.1.3 Technical Specifications	5
2.2 MAXIFLASH ELITE – J2534 ECU PROGRAMMING DEVICE	7
2.2.1 Function Description.....	7
2.2.2 Power Sources	8
2.2.3 Technical Specifications	8
2.3 ACCESSORIES KIT	9
2.3.1 Main Cable	9
2.3.2 OBDI-Type Adapters	10
2.3.3 Other Accessories	10
3 GETTING STARTED	12
3.1 POWER UP.....	12
3.1.1 Application Buttons.....	13
3.1.2 Locator and Navigation Buttons.....	14

3.1.3	System Status Icons	16
3.2	POWER DOWN	16
3.2.1	Reboot System	16
4	DIAGNOSTICS	17
4.1	ESTABLISH VEHICLE COMMUNICATION AND SELECTION	17
4.1.1	Establish Vehicle Communication	17
4.2	GETTING STARTED	21
4.2.1	Vehicle Menu Layout	21
4.3	VEHICLE IDENTIFICATION.....	23
4.4	NAVIGATION	28
4.4.1	Diagnostics Screen Layout	28
4.4.2	Screen Messages	31
4.5	DIAGNOSTICS MENU.....	32
4.6	DIAGNOSTICS FUNCTIONS.....	32
4.6.1	ECU Information	35
4.6.2	Trouble Codes	36
4.6.3	Live Data	37
4.6.4	Active Test	45
4.6.5	Special Functions	46
4.7	PROGRAMMING AND CODING	46
4.7.1	Coding	47
4.7.2	Reprogramming.....	47
4.7.3	Re-flash Errors	48
4.8	GENERIC OBDII OPERATIONS	48
4.8.1	General Procedure	49
4.8.2	Function Descriptions	50

4.9	DIAGNOSTIC REPORT	52
4.9.1	Pre-Scan and Post-Scan Functions.....	52
4.9.2	Diagnostics Report Saving, Viewing, and Sharing.....	53
4.10	EXIT DIAGNOSTICS	57
5	SERVICE	59
5.1	OIL RESET SERVICE	59
5.2	ELECTRIC PARKING BRAKE (EPB) SERVICE	60
5.2.1	EPB Safety	60
5.3	TIRE PRESSURE MONITORING SYSTEM (TPMS) SERVICE	60
5.4	BATTERY MANAGEMENT SYSTEM (BMS) SERVICE.....	61
5.5	DIESEL PARTICLE FILTER (DPF) SERVICE	61
5.6	IMMOBILIZER (IMMO) SERVICE.....	62
5.7	STEERING ANGLE SENSOR (SAS) SERVICE.....	63
6	DATA MANAGER	64
6.1	VEHICLE HISTORY.....	65
6.1.1	Historical Test Record	66
6.2	WORKSHOP INFORMATION	67
6.3	CUSTOMER	68
6.4	IMAGE.....	69
6.5	CLOUD REPORT.....	70
6.6	PDF FILES	70
6.7	REVIEW DATA	70
6.8	DATA LOGGING	71
6.9	UNINSTALL APPS	71
7	SETTINGS.....	72
7.1	UNIT	72

7.2	LANGUAGE	72
7.3	PRINT SETTINGS	73
7.3.1	Printing Operations	73
7.4	SCAN REPORT	74
7.5	PUSH NOTIFICATIONS	74
7.6	AUTO UPDATE	75
7.7	VEHICLE LIST	75
7.8	SYSTEM SETTINGS	76
7.9	ABOUT	76
8	VCI MANAGER	77
8.1	VCI BLUETOOTH PAIRING	78
8.2	BAS BLUETOOTH PAIRING	78
8.3	VCI UPDATE	79
8.3.1	Update via Tablet	79
8.3.2	Update via PC	79
8.4	BAS UPDATE	80
9	SUPPORT	81
9.1	SUPPORT SCREEN LAYOUT	81
9.2	MY ACCOUNT	81
9.2.1	Personal Information	81
9.2.2	Update Information	82
9.2.3	Service Information	82
9.3	TRAINING	82
9.4	OPERATION MANUAL	82
9.5	DATA LOGGING	82
9.6	FAQ	83

10 REMOTE DESKTOP	84
10.1 OPERATIONS.....	84
11 UPDATE	86
12 QUICK LINK.....	87
13 USER FEEDBACK.....	88
14 MAXVIEWER.....	89
15 MAXIVIDEO.....	90
16 MAXISCOPE	91
17 BATTERY TEST	92
17.1 MAXIBAS BT506 BATTERY TESTER	93
17.1.1 Function Description.....	93
17.1.2 Power Sources	94
17.2 TECHNICAL SPECIFICATIONS.....	94
17.3 TEST PREPARATION	95
17.3.1 Inspect the Battery.....	95
17.3.2 Connect the Battery Tester.....	95
17.4 IN-VEHICLE TEST	96
17.4.1 Battery Test	98
17.4.2 Starter Test.....	99
17.4.3 Generator Test	100
17.5 OUT-VEHICLE TEST.....	102
17.5.1 Test Procedure	102
17.5.2 Test Results.....	103
18 AUTEL USER CENTER	104
19 MAINTENANCE AND SERVICE	106
19.1 MAINTENANCE INSTRUCTIONS.....	106
19.2 TROUBLESHOOTING CHECKLIST.....	107

19.3	ABOUT BATTERY USAGE	107
19.4	SERVICE PROCEDURES.....	108
19.4.1	Technical Support.....	108
19.4.2	Repair Service	110
19.4.3	Other Services	110
20	COMPLIANCE INFORMATION.....	112
21	WARRANTY	114

1 Using This Manual

This manual contains device usage instructions.

Some illustrations shown in this manual may contain modules and optional equipment that are not included in your system.

1.1 Conventions

The following conventions are used:

1.1.1 Bold Text

Bold text is used to highlight selectable items such as buttons and menu options.

Example:

- Tap **OK**.

1.1.2 Notes and Important Messages

1.1.1.1 *Notes*

A **NOTE** provides helpful information such as additional explanations, tips, and comments.

1.1.1.2 *Important*

IMPORTANT indicates a situation that if not avoided may result in damage to the tablet or vehicle.

1.1.3 Hyperlinks

Hyperlinks are available in electronic documents. Blue italic text indicates a selectable hyperlink; blue underlined text indicates a website link or an email address link.

1.1.4 Illustrations

Illustrations used in this manual are samples, the actual testing screen may vary for each vehicle being tested. Observe the menu titles and on-screen instructions to make correct

option selection.

1.1.5 Procedures

An arrow icon indicates a procedure. Example:

- **To power down the MaxiSys tablet**
 1. Long press (press and hold) the **Power/Lock** button.
 2. Tap the **Power Off** option.
 3. Tap **OK**.

2 General Introduction

There are two main components of the MaxiSys system:

- MS908CV II Tablet — the central processor and monitor for the system.
- MaxiFlash Elite — a vehicle communication interface. Used for accessing vehicle data.

This manual describes the construction and operation of both devices and how they work together to deliver diagnostic solutions.

2.1 MaxiSys MS908CV II Tablet

2.1.1 Function Description

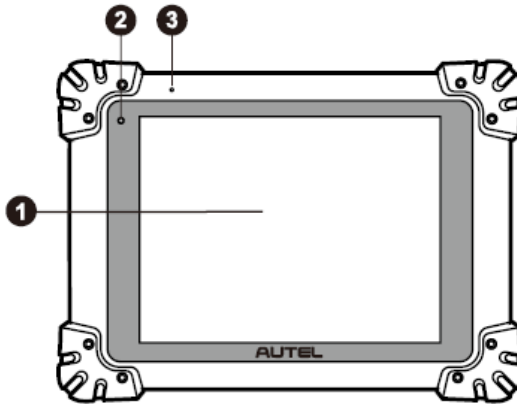

Figure 2-1 Tablet Front View

1. 9.7" LED Capacitive Touchscreen
2. Ambient Light Sensor — detects ambient light brightness.
3. Microphone

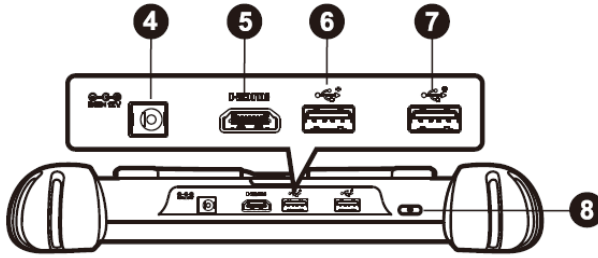

Figure 2-2 Tablet Top View

- 4. DC Power Supply Input Port
- 5. HDMI (High-Definition Multimedia Interface) Port
- 6. USB Port
- 7. USB Port
- 8. Power/Lock Button — turns the device on/off with long press, or locks the screen with short press.

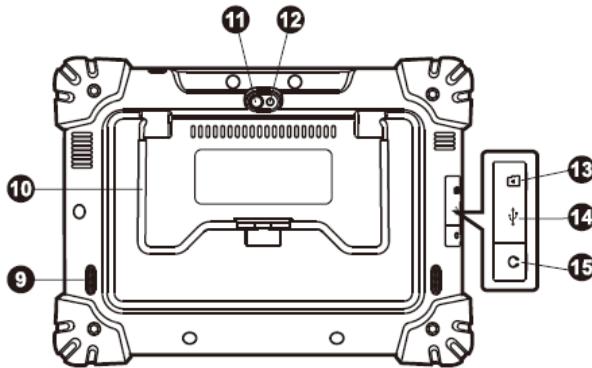

Figure 2-3 Tablet Back View

- 9. Audio Speaker
- 10. Collapsible Stand — extends from the back to allow hands-free viewing of the tablet.
- 11. Rear Camera
- 12. Camera Flash
- 13. Mini SD Card Slot
- 14. Mini USB Port

15. Headphone Jack

2.1.2 Power Sources

The tablet can receive power from any of the following sources:

- Internal Battery Pack
- AC/DC Power Supply
- Vehicle Power

! IMPORTANT

Do not charge the battery when the temperature is lower than 0 °C (32 °F) or higher than 45 °C (113 °F).

2.1.2.1 *Internal Battery Pack*

The tablet can be powered with the internal rechargeable battery, which if fully charged can provide sufficient power for about 8 hours of continuous operation.

2.1.2.2 *AC/DC Power Supply – using power adapter*

The tablet can be powered from an electrical outlet using the AC/DC power adapter. The AC/DC power supply also charges the internal battery pack.

2.1.2.3 *Vehicle Power*

The tablet can be powered from the auxiliary power outlet adapter or other DC power port on the test vehicle through a direct cable connection. The vehicle power cable connects to the DC power supply port on the top side of the tablet.

2.1.3 Technical Specifications

Table 2-1 Tablet Specifications

Item	Description
Operating System	Android 10
Processor	Octa-core Processor (4 x 2.2 GHz + 4 x 1.8 GHz)
Memory	4 GB RAM & 128 GB on-board memory
Display	9.7-inch LED capacitive touchscreen with 2048 x 1536 resolution

Item	Description
Connectivity	<ul style="list-style-type: none"> ● Wi-Fi (802.11 a/b/g/n/ac) ● USB 2.0 ● Bluetooth v5.0 + EDR ● SD card (support up to 64 GB) ● HDMI
Camera (Rear)	16.0 megapixels; auto focus with flashlight
Sensors	<ul style="list-style-type: none"> ● Gravity accelerometer ● Ambient light sensor (ALS)
Audio Input/Output	<ul style="list-style-type: none"> ● Microphone ● Dual speakers ● 3-band 3.5 mm stereo/standard headset jack
Power and Battery	<ul style="list-style-type: none"> ● 11000 mAh 3.7 V Lithium-polymer battery ● Charging via 12 V AC/DC power supply with a temperature between 0 °C and 45 °C
Input Voltage	12 V (9–24 V)
Power Consumption	6.5 W
Operating Temp.	0 °C to 50 °C (32 °F to 122 °F)
Storage Temp.	-20 °C to 60 °C (-4 °F to 140 °F)
Dimensions (W x H x D)	300 mm (11.81") x 220 mm (8.66") x 50 mm (1.97")
Weight	<ul style="list-style-type: none"> ● NW: 1.42 kg (3.13 lbs.) ● GW: 8.655 kg (19.08 lbs.)
Protocols	ISO 9142-2, ISO 14230-2, ISO 15765-4, K/L-Line, Flashing Code, SAE-J1850 VPW, SAE-J1850 PWM, CAN ISO 11898, High-speed, Middle-speed, Low-speed and Singlewire CAN, GM UART, UART Echo Byte Protocol, Honda Diag-H Protocol, TP 2.0, TP 1.6, SAE J1939, SAE J1708, Fault-Tolerant CAN

2.2 MaxiFlash Elite – J2534 ECU Programming Device

2.2.1 Function Description

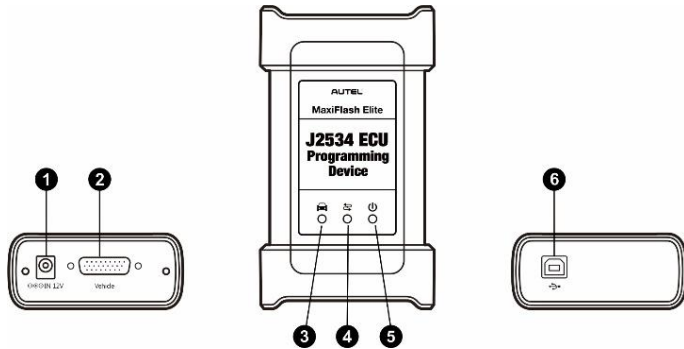

Figure 2-4 MaxiFlash Elite Views

1. DC Power Supply Input Port
2. Vehicle Data Connector (DB26-Pin)
3. Vehicle LED — flashes green when the device is communicating with the vehicle's system.

! IMPORTANT

Do not disconnect the programming device while this vehicle LED status light is on! If the flash programming procedure is interrupted while the vehicle's ECU is blank or only partially programmed, the module may be unrecoverable.

4. Connection LED
 - Illuminates solid green when the device is properly connected with the tablet via the USB cable.
 - Illuminates solid blue when the device is properly connected with the tablet via Bluetooth connection.
5. Power LED
 - Illuminates solid green when the device is powered on.
 - Flashes red when a system failure occurs.
 - Illuminates amber automatically at power-up when the device is performing a self-test procedure.
6. USB Port

2.2.1.1 Programming Capability

The MaxiFlash Elite is a SAE J2534-1 & -2 compliant PassThru programming interface device. Using the updated OEM software, it is capable of replacing the existing software/firmware in the Electronic Control Units (ECUs), programming new ECUs and fixing software-controlled drivability and emission issues.

2.2.1.2 Communication Capability

The MaxiFlash Elite device supports two communication methods, Bluetooth (BT) and USB cable. It can transmit vehicle data to the tablet with or without a cable connection. In open areas, the working range of the transmitter through BT communication is up to 210 feet (about 70 m). If the signal is lost due to being taken out of range, communication will be restored once the tablet is within range.

2.2.2 Power Sources

The MaxiFlash Elite device can receive power from the following sources:

- Vehicle Power
- AC/DC Power Supply

2.2.2.1 Vehicle Power

The MaxiFlash Elite device operates on 12/24 V vehicle power, which receives power via the vehicle data connection port. The device powers on whenever it is connected to an OBD II/E/OBD compliant Data Link Connector (DLC). For non-OBDII/E/OBD compliant vehicles, the device can be powered from an auxiliary power outlet adapter or other suitable power port on the test vehicle using the auxiliary power cable.

2.2.2.2 AC/DC Power Supply

The MaxiFlash Elite device can be powered from a wall socket using the AC/DC power adapter.

2.2.3 Technical Specifications

Table 2-2 MaxiSys Elite Specifications

Item	Description
Communications	<ul style="list-style-type: none">● Wireless BT V2.1 + EDR● USB 2.0
Wireless Frequency	Wireless BT V2.1 +EDR, 2.4 GHz

Item	Description
Input Voltage Range	12 V DC to 24 V DC
Supply Current	170 mA @ 12 V DC 100 mA @ 24 V DC
Operating Temp.	0 °C to 60 °C (32 °F to 140 °F) (ambient)
Storage Temp.	-20 °C to 70 °C (-4 °F to 158 °F) (ambient)
Dimensions (L x W x H)	149 mm (5.87") x 86 mm (3.38") x 35 mm (1.28")
Weight	0.29 kg (0.64 lbs.)

2.3 Accessories Kit

2.3.1 Main Cable

The MaxiFlash Elite device can be powered through the Autel main cable when connected to an OBDII/EOBD compliant vehicle. The main cable connects the MaxiFlash Elite device to the vehicle's DLC, through which the MaxiFlash Elite device can transmit vehicle data to the tablet.

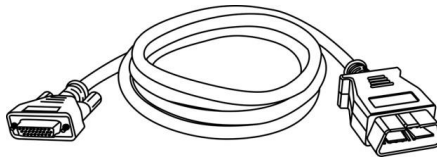

Figure 2-5 Main Cable (1.5 m in Length)

NOTE

The MaxiFlash Elite device can be connected by the Autel main cable only. Do NOT use other cables to connect the MaxiFlash Elite device.

2.3.2 OBDI-Type Adapters

The OBDI-type adapters are for non-OBDII vehicles. The adapter used depends on the type of vehicle being tested. The most common adapters are shown below (Adapters may be sold separately. Please contact your distributor for details.)



JW1_{x2}



JW2_{x2}



JW3_{x2}



JW4_{x2}



JW5_{x2}



JW6_{x2}



JW7_{x2}



JW8_{x2}



JW9_{x2}



JW10_{x2}



UNI-4









Deutsch-6

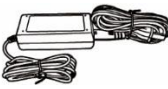

Deutsch-9

2.3.3 Other Accessories

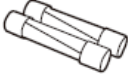
	USB Cable Connects the tablet to the MaxiSys Elite device.
	Mini USB Cable Connects the tablet to a PC.
	AC/DC External Power Adapter Connects the tablet to the external DC power port for power supply.

	<p>Auxiliary Power Outlet Adapter Provides power to the tablet or the MaxiSys Elite device through connection to the vehicle's auxiliary power outlet adapter receptacle, as some non-OBDII vehicles cannot provide power via the DLC connection.</p>
	<p>Clamp Cable Provides power to the tablet or the MaxiSys Elite device through connection to the vehicle's battery.</p>
	<p>Light Fuse x 2 A safety device for the auxiliary power outlet adapter.</p>
	<p>USB to Ethernet Adapter Network connection function can be realized through this device.</p>
	<p>OBDII Extension Cable Extends the OBDII port in order to better power the MaxiSys Elite device through the main cable.</p>

3 Getting Started

Make sure that the tablet has sufficient power or is connected to the external power supply. (See [Power Sources](#).)

3.1 Power Up

Long press (press and hold) the **Power/Lock** button on the top-right side of the tablet to switch the unit on. Slide up from the bottom of the Lock screen to enter the MaxiSys Job Menu screen.



Figure 3-1 MaxiSys Job Menu

1. Application Buttons
2. Locator and Navigation Buttons
3. Status Icons

NOTE









It is recommended that you lock the screen when not in use to protect information in the system and conserve the power.









Almost all operations on the tablet are controlled through the touchscreen. The touchscreen navigation is menu-driven, allowing for quick access to the test procedure or the data that you need, through a series of questions and options. Detailed descriptions of the menu structures are found in the chapters for each application.

3.1.1 Application Buttons

The table below briefly describes each of the applications in the MaxiSys system.

Table 3-1 Applications

Button	Name	Description
	Diagnostics	Configures the unit to operate as a diagnostic tool. See Diagnostics .
	Service	Accesses special functions menu. See Service .
	Data Manager	Accesses the saved repair shop, customer and vehicle data including detailed vehicle diagnostics and test records. See Data Manager .
	Settings	Accesses the system settings menu and general tablet menu. See Settings .
	VCI Manager	Accesses VCI connection menu. See VCI Manager .
	Support	Synchronizes Autel's online service database with the MaxiSys tablet. See Support .
	Remote Desktop	Configures your tablet to receive remote support using the TeamViewer application. See Remote Desktop .
	Update	Accesses system software update menu. See Update .
	Quick Link	Provides associated website bookmarks to allow quick access to product update, service, support, and other information. See Quick Link .











Button	Name	Description
	Demonstration	Provides step-by-step operation demonstration for diagnostics.
	User Feedback	You can submit feedback through this application when you encounter problems during the use of the tablet. See User Feedback .
	MaxiViewer	Provides a quick search for supported functions and/or vehicles. See MaxiViewer .
	MaxiTools	Includes Log Collection and Factory Data Reset two parts.
	MaxiVideo	Configures the unit to operate as a video scope device by connecting to an imager head cable for close vehicle inspections. See MaxiVideo .
	MaxiScope	Configures the unit to operate as an automotive oscilloscope to perform electrical and electronic circuit tests and monitor signal activities. See MaxiScope .
	Battery Test	Accesses the Battery Test menu with two functions, including in-vehicle test and out-vehicle test. See Battery Test .
	Autel User Center	Allows users to register Autel tool for downloading the latest released software. See Autel User Center .

3.1.2 Locator and Navigation Buttons

Operations of the navigation buttons at the bottom of the screen are described in the table below.

Table 3-2 Locator and Navigation Buttons

Icon	Name	Description
	Locator	Indicates the location of the screen. Swipe the screen left or right to view the previous or next screen.

Icon	Name	Description
	Back	Returns to the previous screen.
	MaxiSys Home	Returns to MaxiSys Job Menu.
	Android Home	Returns to Android system home screen.
	Recent Apps	Displays a list of applications that are currently running. Tap an application icon to launch the application. Remove an app by swiping it to the right or left. Tap the Delete icon to remove all running applications.
	Browser	Launches the Chrome Internet browser.
	Camera	Tap the Camera icon to open camera viewfinder. Press and hold the icon to take a screenshot of the current screen. The saved files are auto-stored in the Data Manager application for later review. See Data Manager .
	Display & Sound	Adjusts the brightness of the screen and the volume of the audio output.
	VCI Shortcut	Opens the VCI Manager application. The BT or the cable badge at the bottom-right corner indicates the tablet is communicating with the VCI device. An "X" badge will display at the bottom-right corner if the tablet is not connected to the VCI device.
	Diagnostics Shortcut	Returns to the Diagnostics screen.
	Service Shortcut	Returns to the Service screen.

➤ **To use the camera**

1. Tap the **Camera** icon. The camera screen opens.
2. Focus the image to be captured in the viewfinder.
3. Tap the **Camera** icon on the right side of the screen. The viewfinder now shows the captured picture and auto-saves the taken photo.
4. Tap the thumbnail image on the top-right corner of the screen to view the stored images.
5. Tap the **Back** or **Home** button to exit the camera function.

 **NOTE**

After swiping the camera screen from left to right, the camera mode and video mode can be switched by tapping the **Camera** icon or **Video** icon.

3.1.3 System Status Icons

Your MaxiSys tablet is a fully functional Android tablet with the standard Android operating system status icons. Refer to Android documentation for additional information.

3.2 Power Down

All vehicle communications should be terminated before shutting down the tablet. A warning message displays if a shutdown is attempted while the tablet is communicating with the vehicle. Forcing a shutdown while the tablet is communicating with the vehicle may lead to ECU errors on some vehicles. Please exit the Diagnostics application before shutting off the tablet.

➤ **To power down the MaxiSys tablet**

1. Long press (press and hold) the **Power/Lock** button.
2. Tap the **Power Off** option.
3. Tap **OK**.

3.2.1 Reboot System

In case of a system crash, long press the **Power/Lock** button and tap **Restart** to reboot the system.

4 Diagnostics

By establishing a data link to the electronic control systems of the vehicle being serviced through the VCI (MaxiFlash Elite) device, the Diagnostics application allows you to retrieve diagnostic information, view live data parameters, and perform active tests. The Diagnostics application can access the electronic control module (ECM) for various vehicle control systems, such as engine, transmission, antilock brake system (ABS), airbag system (SRS).

4.1 Establish Vehicle Communication and Selection

4.1.1 Establish Vehicle Communication

The Diagnostics operations require connecting the MaxiSys tablet to the test vehicle through the VCI device using the main cable. (Use the applicable OBDI-type adapter if needed.) To establish a proper vehicle communication to the tablet, you need to perform the following steps:

1. Connect the VCI device to the vehicle's DLC for both communication and power source.
2. Connect the VCI device to the tablet via Bluetooth pairing or USB connection.
3. When the above steps are completed, check the VCI navigation button at the bottom bar on the screen. If a green BT or USB icon displays at the lower-right corner, the MaxiSys tablet is ready to start vehicle diagnosis.

4.1.1.1 *Vehicle Connection*

The method used to connect the VCI device to a vehicle's DLC depends on the vehicle's configuration as follows:

- A vehicle equipped with an On-board Diagnostics Two (OBDII) management system supplies both communication and 12-volt power through a standardized J-1962 DLC.
- A vehicle not equipped with an OBDII management system supplies communication through a DLC connection, and in some cases supplies 12-volt power through the cigarette lighter receptacle or a connection to the vehicle battery.

OBDDII Vehicle Connection

This type of connection only requires the main cable without any additional adapter.

➤ To connect to an OBDDII vehicle

1. Connect the main cable's female adapter to the Vehicle Data Connector on the VCI device, and tighten the captive screws.
2. Connect the cable's 16-pin male adapter to the vehicle's DLC, which is generally located under the vehicle dashboard.

🔧 NOTE

The vehicle's DLC is not always located under the dashboard. Refer to the user manual of the test vehicle for additional connection information.

Non-OBDDII Vehicle Connection

This type of connection requires both the main cable and a required OBDI adapter for the specific vehicle being serviced.

There are three possible conditions for non-OBDDII vehicle connection:

- DLC connection supplies both communication and power.
- DLC connection supplies communication and power are to be supplied via the auxiliary power outlet adapter connection.
- DLC connection supplies communication and power are to be supplied via connection to the vehicle battery.

➤ To connect to a non-OBDDII vehicle

1. Connect the main cable's female adapter to the Vehicle Data Connector on the VCI device, and tighten the captive screws.
2. Locate the required OBDI adapter and connect its 8-pin jack to the main cable's male adapter.
3. Connect the attached OBDI adapter to the vehicle's DLC.

🔧 NOTE

Some vehicles may have more than one adapter or may have test leads instead of an adapter. Make the proper connection to the vehicle's DLC as required.

➤ To connect the auxiliary power outlet adapter

1. Plug the DC power connector of the auxiliary power outlet adapter into the DC power supply input port on the device.
2. Connect the male connector of the auxiliary power outlet adapter into the vehicle's auxiliary power outlet adapter receptacle.

➤ **To connect the clipper cable**

1. Connect the tubular plug of the clipper cable to the male connector of the auxiliary power outlet adapter.

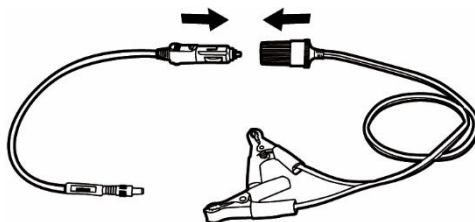

Figure 4-1 Connection between Auxiliary Power Outlet Adapter and Clamp Cable

2. Plug the DC power connector of the auxiliary power outlet adapter into the DC power supply input port of the VCI device.
3. Connect the clipper cable to the vehicle's battery.

NOTE

After the VCI device is successfully connected to the vehicle, the Power LED on the device lights, and a beeping sound will be heard.

4.1.1.2 VCI Connection

After the VCI device is properly connected to the vehicle, the Power LED on the VCI device lights solid green, and is ready to establish communication with the tablet.

Coming with the MaxiSys tool kit, the VCI device supports two communication methods with the tablet, Bluetooth and USB cable.

Pairing Up via Bluetooth

In open areas, the working range for Bluetooth communication is about 328 feet (100 m), giving technicians greater mobility to perform vehicle diagnosis from anywhere in the repair shop.

To expedite multi-vehicle diagnostics, more than one VCI device can be used in busy repair shops, enabling technicians to quickly pair their MaxiSys tablet to each VCI device via Bluetooth separately and therefore eliminating the need to unplug the VCI device from one vehicle and then connect it to another each time a new vehicle comes in for repairs.

➤ **To pair the tablet with the VCI device via Bluetooth**

1. Power up the tablet.
2. Select the **VCI Manager** application from the MaxiSys Job Menu.
3. When the **VCI Manager** application is opened, select **VCI BT** from the connection mode list and swipe the Bluetooth toggle button to **ON**. The device will automatically scan for available VCI devices for Bluetooth pairing. The found devices are listed in the Settings section on the right side of the screen.

 **NOTE**

If no VCI device is found, this may indicate that the signal strength is too weak to be detected. Reposition the VCI device, and remove all possible objects that may cause signal interference. Tap the **Scan** button at the top-right corner to rescan for VCI.

4. Typically, the VCI device name displays as “Maxi” suffixed with a serial number. Select the VCI device for pairing. (If more than one VCI is used in the shop, ensure the correct VCI is selected to pair.)
5. When the pairing is successful, the connection status displayed as “Connected.”
6. The VCI icon on the tablet navigation bar at the bottom of the screen displays a green circle BT icon when the tablet and the VCI are connected.

Refer to [VCI Bluetooth Pairing](#) for additional information.

USB Cable Connection

The USB cable connection is a simple and quick way to establish communication between the tablet and the VCI device. After properly connecting the USB cable from the tablet to the VCI device, the VCI navigation button at the bottom bar of the screen displays a green USB cable badge and the Connection LED on the VCI device lights solid green, indicating the connection between the devices is successful.

The MaxiSys diagnostic platform is now ready to perform vehicle diagnosis.

 **NOTE**

The USB connection provides the most stable communication and is therefore the recommended communication mode between the tablet and VCI when operating ECU programming or coding. The USB communication method will take priority over other connected communication modes.

4.1.1.3 No Communication Message

- A. If the tablet is unable to connect to the VCI, an “Error” message displays. An “Error” message indicates the tablet is not communicating with the VCI device, Troubleshoot the error by performing the following steps:
- Ensure the VCI device is powered on.
 - When using the wireless connection, ensure the network is configured correctly and the proper device has been connected.
 - If the tablet loses communication abruptly during diagnostics, ensure no objects are causing signal interference.
 - Ensure the VCI device is properly positioned with the VCI front side up.
 - Move the tablet closer to the VCI device. If using the wired connection, ensure the cable is securely attached to the VCI.
 - Ensure the communication LED is lit for the selected communication type, Bluetooth or USB cable.
- B. If the VCI device is unable to establish a communication link, a message will display. Possible causes for the communication error include:
- The VCI device is unable to establish a communication link with the vehicle.
 - A vehicle system has been selected for diagnoses that is not supported by the vehicle.
 - There is a loose connection.
 - There is a blown vehicle fuse.
 - The vehicle or the data case has a wiring fault.
 - There is a circuit fault in the data cable or adapter.
 - The vehicle identification is incorrectly entered.

4.2 Getting Started

Prior to first use of the Diagnostics application, ensure the VCI device is properly connected to and is communicating with the tablet. See [Establish Vehicle Communication](#).

4.2.1 Vehicle Menu Layout

When the VCI device is properly connected to the vehicle, and paired to the tablet, the platform is ready to start vehicle diagnosis. Tap on the **Diagnostics** application button on the MaxiSys Job Menu, and the Vehicle Menu displays on the screen.

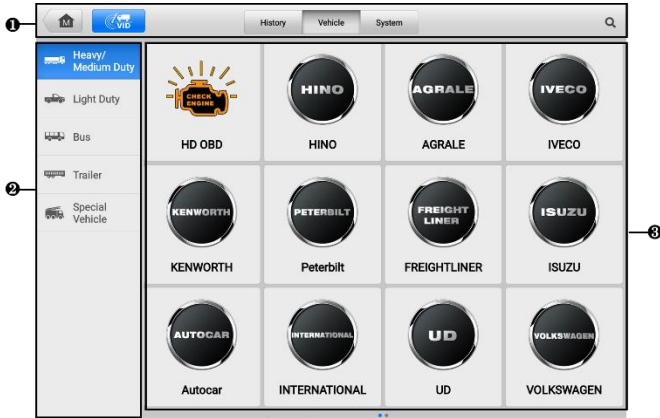

Figure 4-2 Vehicle Menu Screen



1. Top Toolbar Buttons
2. Navigation Bar
3. Manufacturer Buttons

4.2.1.1 Top Toolbar Buttons

The operations of the toolbar buttons at the top of the screen are listed and described in the table below.

Table 4-1 Top Toolbar Buttons

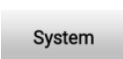
Button	Name	Description
	Home	Returns to the MaxiSys Job Menu.
	VID	Tap this button to open a dropdown list; tap Auto Detect for auto VIN detection; tap Manual Input to enter VIN code or license number manually. Tap Scan VIN/License to scan the VIN code/license number by camera.
	History	Displays the stored test vehicle history records. This option provides direct access to the previously tested vehicle records. See Vehicle History .

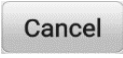
Button	Name	Description
	Vehicle	Displays the vehicle menu based on the selection of the commercial vehicle type.
	System	Displays the vehicle menu based on the selection of the vehicle system.
	Search	Tap inside the search field to display a virtual keyboard and input the vehicle manufacturer to test.
	Cancel	Tap this button to exit the search screen or to cancel an operation.

4.2.1.2 Navigation Bar

The navigation bar is to aid users in accessing desired vehicle quickly. When tapping the **Vehicle** tab on the top toolbar, the vehicle menu will be displayed based on the selection of the commercial vehicle type listed on the navigation bar. When tapping the **System** tab on the top toolbar, the vehicle menu will be displayed on the selection of the vehicle system listed on the navigation bar.

4.2.1.3 Manufacturer Buttons

The Manufacturer buttons display the various vehicle brand names. Select the manufacturer button after the VCI device is properly connected to the test vehicle to start a diagnostic session.

4.3 Vehicle Identification

The MaxiSys diagnostic system supports five methods of vehicle identification.

1. Auto VIN Scan
2. Manual Input
3. Scan VIN/License
4. Manual Vehicle Selection
5. OBDII Direct Entry

4.3.1.1 Auto VIN Scan

The MaxiSys diagnostic system features the latest VIN-based Auto VIN scan function to identify CAN vehicles with just one tap, enabling the technician to quickly identify the exact vehicle and scan its available systems for fault codes.

➤ To perform Auto VIN Scan

1. Tap the **Diagnostics** application button from the MaxiSys Job Menu. The Vehicle Menu displays.
2. Tap the **VID** button on the top toolbar.



Figure 4-3 VID Screen

3. Select **Auto Detect**. The tablet starts VIN scanning on the vehicle's ECU. Once the test vehicle is successfully identified, the system will guide you to the Vehicle Diagnostics screen.

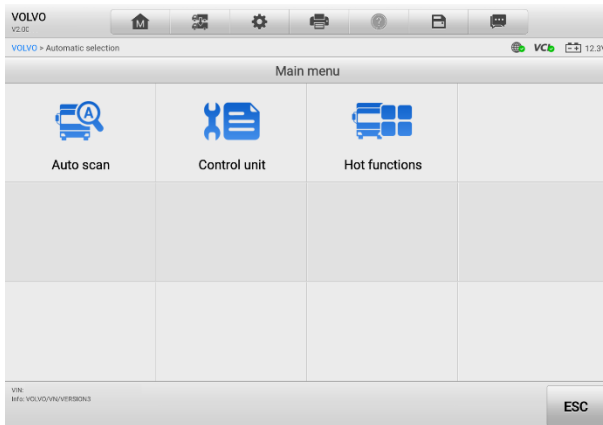

Figure 4-4 Diagnostics Main Menu Screen

4.3.1.2 Manual Input

For vehicles that do not support the Auto VIN Scan function, the MaxiSys diagnostic system allows you to enter the vehicle VIN or license number manually, or simply take a photo of the VIN sticker or license plate for quick vehicle identification.

➤ **To perform Manual Input**

1. Tap the **Diagnostics** application button from the MaxiSys Job Menu. The Vehicle Menu displays.
2. Tap the **VID** button on the top toolbar.
3. Select **Manual Input**.
4. Tap the input box and enter the correct VIN code or license number.



Figure 4-5 Manual VIN Input

5. Tap **OK**. The vehicle will be identified and matched to the vehicle database, and the system will guide you to the Vehicle Diagnostics screen.

4.3.1.3 Scan VIN/License

Tap **Scan VIN/License** in the dropdown list (see [Figure 4-3 VID Screen](#)). The camera will be opened. On the right side of the screen, from top to bottom, three options are available: **Scan QR/Bar Code**, **Scan VIN**, and **Scan License**.

NOTE

The method of Scan License is supported in some countries and areas. Please manually input the license number if it is not available.

Select one of three options and position the tablet to align the VIN or license number within the scanning window, the result displays in the Recognition result dialog box after scanned. Tap **OK** to confirm the result, and then the vehicle information confirmation screen will display on the tablet. If all the vehicle information is correct, tap the icon in the middle of the screen to confirm the VIN of the vehicle being tested. Tap **OK** to continue.

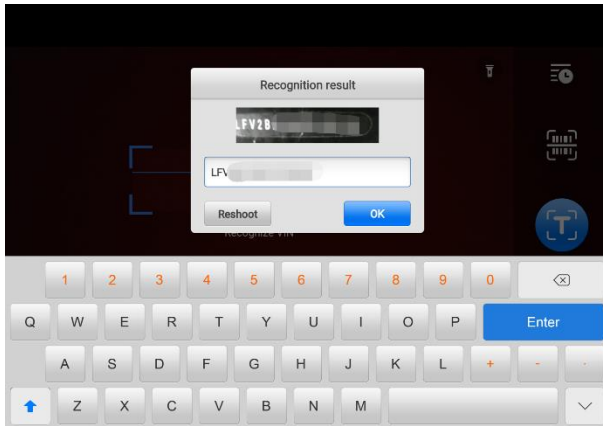

Figure 4-6 Scan VIN Code 1

If the VIN/License number cannot be scanned, please manually input the VIN/License number. Tap **OK** to continue.

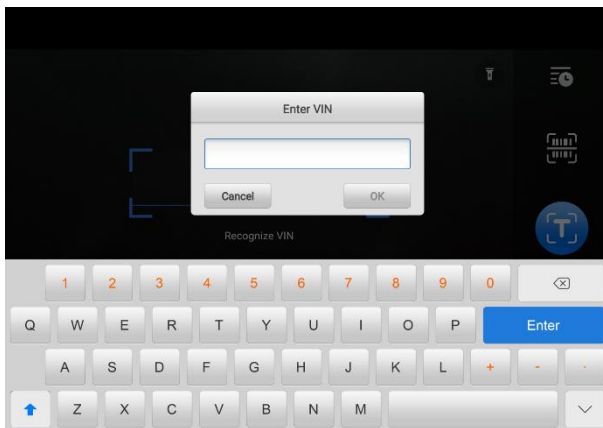

Figure 4-7 Scan VIN Code 2

4.3.1.4 Manual Vehicle Selection

When the vehicle's VIN is not automatically retrievable through the vehicle's ECU, or the specific VIN is unknown, you can select the vehicle manually.

Step-by-step Vehicle Selection

This mode of vehicle selection is menu-driven. Select a vehicle manufacturer on the Vehicle Menu screen and the Select Diagnostic Type screen displays, then tap the **Manual Selection** button. Select the vehicle information like the Brand, Model, Capacity, Engine type, and Model year on the same screen. The ESC button at the lower-right corner of the screen will bring you back to the previous screen. Tap the **Reset** button to reselect the vehicle information if needed.

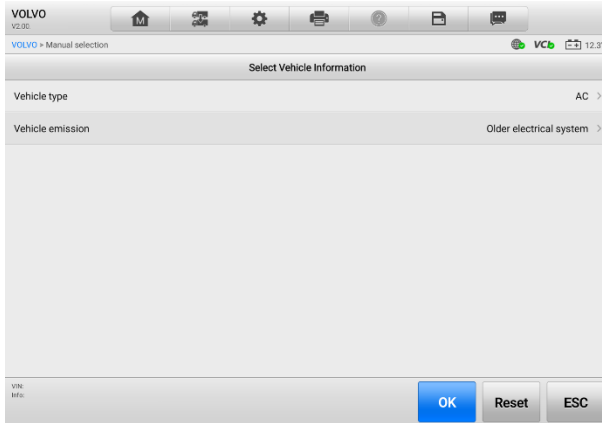

Figure 4-8 Manual Vehicle Selection Screen

4.3.1.5 OBDII Direct Entry

Occasionally, the tablet may not be able to identify a vehicle. For these vehicles, the user may perform a generic OBDII or EOBD diagnostic. See [Generic OBDII Operations](#) for additional information.

4.4 Navigation

4.4.1 Diagnostics Screen Layout

After the vehicle information is selected, tap the **OK** button at the bottom-right corner of the screen to open the Main Menu screen. This section consists of various functions commonly used, including Auto Scan and Control Unit. The available functions displayed vary by vehicle.

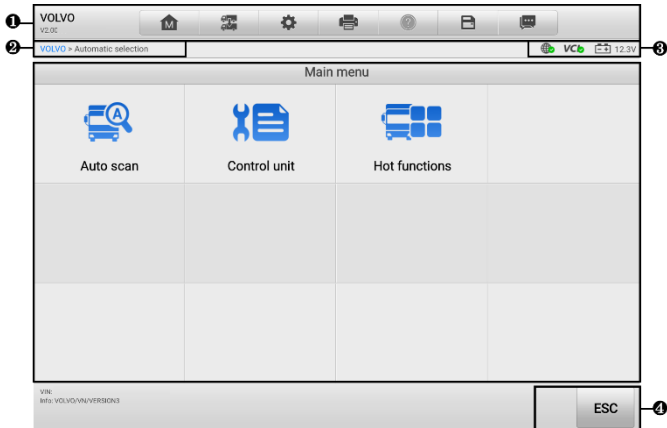





Figure 4-9 Main Menu Screen



1. Diagnostics Toolbar
2. Current Directory Path
3. Status Information Bar
4. Main Section
5. Function Buttons

4.4.1.1 Diagnostics Toolbar

The Diagnostics Toolbar contains buttons that allow you to print or save the displayed data and perform other operations. The table below provides a brief description for the operations of the Diagnostics Toolbar buttons.

Table 4-2 Diagnostics Toolbar Buttons

Button	Name	Description
	Home	Tap to return to MaxiSys Job Menu.
	Vehicle Swap	Exits the diagnostic session and returns to the Vehicle Menu screen to select another vehicle for testing.
	Settings	Opens the Settings screen. See Settings .
	Print	Saves and prints a copy of the displayed data. See Print Settings .

Button	Name	Description
	Help	Provides instructions or tips for operations of various diagnostic functions.
	Save	Opens a submenu which provides options for data storage.
	Data Logging	Use this function when encountering an error while testing or diagnosing a vehicle. This function will record the communication data and ECU information of the test vehicle and send it to Autel's technical staff to review and provide solution. Go to the Support application to follow up the processing progress. See Data Logging .

➤ **To print data in Diagnostics**

1. Tap the **Diagnostics** application button from the MaxiSys Job Menu. The Print button on the Diagnostics Toolbar is available throughout the whole Diagnostics operations.
2. Tap **Print** and a drop-down menu will display.
 - a) **Print this page** — prints a screenshot copy of the current screen.
 - b) **Print all data** — prints a PDF copy of all displayed data.
3. A temporary file will be created and sent via the computer to the printer.
4. When the file is sent, a confirmation message displays.

 **NOTE**

Make sure the tablet and the printer are connected either by Wi-Fi or LAN before printing. For more instructions on printing, see [Print Settings](#) for details.

➤ **To submit Data Logging reports in Diagnostics**

1. Tap the **Diagnostics** application button from the MaxiSys Job Menu. The Data Logging button on the Diagnostic Toolbar is available throughout the whole Diagnostics operations.
2. Tap the **Data Logging** button to display the error options. Select a specific error, and a submission form will display to let you fill in the report information.
3. Tap the **Send** button on the upper-right corner of the screen to submit the report form via the Internet. A confirmation message displays when sent successfully.

4.4.1.2 *Current Directory Path*

The Current Directory Path shows all directory names to access the current page.

4.4.1.3 *Status Information Bar*

The Status Information Bar at the top-right of the Main Section displays the following items:

1. **Network Status Icon** — indicates whether a network is connected.
2. **VCI Icon** — indicates the communication status between the tablet and the VCI device.
3. **Battery Icon** — indicates the battery status of the vehicle.

4.4.1.4 *Main Section*

The Main Section varies depending on the stage of operations which shows vehicle identification selections, the main menu, test data, messages, instructions, and other diagnostic information.

4.4.1.5 *Function Buttons*

The Function Buttons displayed at the bottom of the screen vary by operation. Function includes navigation, reporting, code clearing, and so on. The functions of these buttons will be described in the following sections when relevant.

NOTE

The Diagnostic Toolbar (located on the top of the screen) will be active throughout the diagnostic session for tasks such as printing and saving the displayed data, obtaining help information, or performing data logging.

4.4.2 **Screen Messages**

Messages display when additional input is needed before proceeding. There are mainly three main types of on-screen messages: Confirmation, Warning, and Error.

4.4.2.1 *Confirmation Messages*

This type of messages usually displays as an “Information” screen, when you are about to perform an action that cannot be reversed or when an action has been initiated and your confirmation is needed to continue.

When a user-response is not required, the message displays briefly.

4.4.2.2 *Warning Messages*

This type of messages displays when completing the selected action may result in an irreversible change or loss of data. An example of this message is the “Erase Codes” message.

4.4.2.3 *Error Messages*

Error messages display when a systemic or procedural error has occurred. Possible errors include cable disconnection and communication interruption.

4.5 **Diagnostics Menu**

The Diagnostics application enables you to establish a data connection with the vehicle’s ECU through the VCI device for vehicle diagnosis and maintenance.

The Main Menu screen (see [Figure 4-9 Main Menu Screen](#)) navigates users to perform read codes, clear codes, or perform comprehensive automotive diagnostic functions, and so on. After the function is selected, the tablet will establish a communication with the vehicle through the VCI device, and enter the corresponding function menu or selection menu based on your selection.

4.6 **Diagnostics Functions**

Auto Scan

The Auto Scan function performs a comprehensive scanning over the test vehicle’s ECUs in order to locate fault systems and retrieve DTCs. The sample operation interface of Auto Scan displays as below.

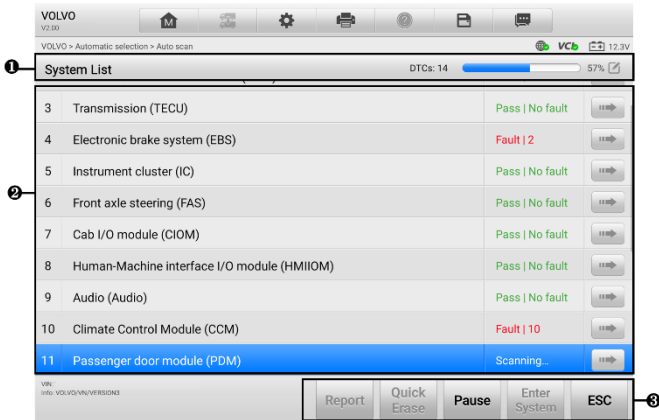



Figure 4-10 Auto Scan Operation Screen

1. Navigation Bar

- List Tab – displays the scanned data in list format
- Progress Bar – indicates the test progress

2. Main Section

- Column 1 — displays the system numbers
- Column 2 — displays the scanned systems
- Column 3 — displays the scan results
 - ❖ **Fault | #:** Indicates there is/are detected fault code(s) present; "#" indicates the quantity of detected faults.
 - ❖ **Pass | No Fault:** Indicates the system was scanned and no fault has been detected.
 - ❖ **Not Scanned:** Indicates the system has not been scanned.
 - ❖ **No Response:** Indicates the system has not received a response.
- Column 4 — tap the  button to enter a system for performing further diagnostics.

3. Function Buttons

The table below provides a brief description of the Function Buttons.

Table 4-3 Function Buttons in Auto Scan Screen

Name	Description
Report	Displays the diagnostic data in report form.
Quick Erase	Erases all fault information after scanning.
Fault Scan	Scans vehicle system modules.
Pause	Pauses the scanning process.
Enter System	Enters the ECU system.
ESC	Returns to the previous screen or exits Diagnostics screen.

Control Unit

The Control unit function allows you to manually locate a required control system for testing through a series of choices. Simply follow the menu-driven procedures, and make proper selection each time; the program will guide you to the diagnostic function menu after a few choices you've made.

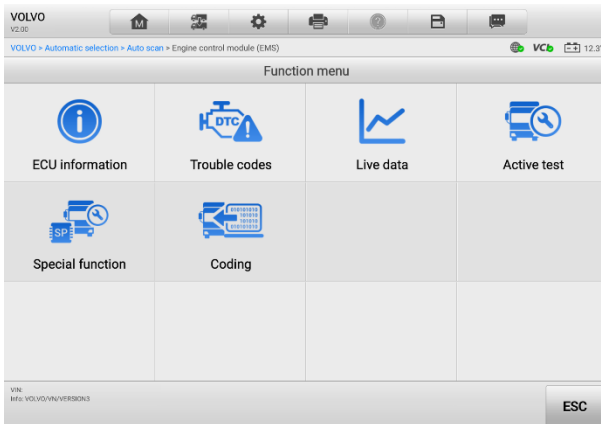

Figure 4-11 Diagnostics Function Screen

Available functions may vary by vehicle. The function menu may include:

- **ECU Information** — displays detailed ECU information. Select to display information screen.

- **Trouble Codes** — contains Read Codes and Erase Codes. The former displays detailed DTC information retrieved from the vehicle control module. The latter facilitates you to erase DTCs and other data from the ECU.
 - **Live Data** — retrieves and displays live data and parameters from the vehicle's ECU.
 - **Active Test** — provides specific subsystem and component tests. This selection may display as *Actuators*, *Actuator Test*, or *Function Tests*. Available tests vary by vehicle.
 - **Special Functions** — provides component adaptation or variant coding functions for custom configurations, and allows entry of adaptive values for certain components after repairs. Depending on the test vehicle, this selection may sometimes appear as Control Unit Adaptations, Variant Coding, Configuration, or something similar.
- **To perform Diagnostics function**
1. Connect the MaxiSys tablet to the VCI device.
 2. Identify the vehicle through any of the vehicle identification methods supported by the MaxiSys tablet.
 3. Tap **Auto Scan** or **Control Unit** to locate the needed test system.
 4. Select the function you need to perform from the Diagnostics Function screen.

4.6.1 ECU Information

This function retrieves and displays the specific information for the tested control unit, including unit type, version numbers, and other information.

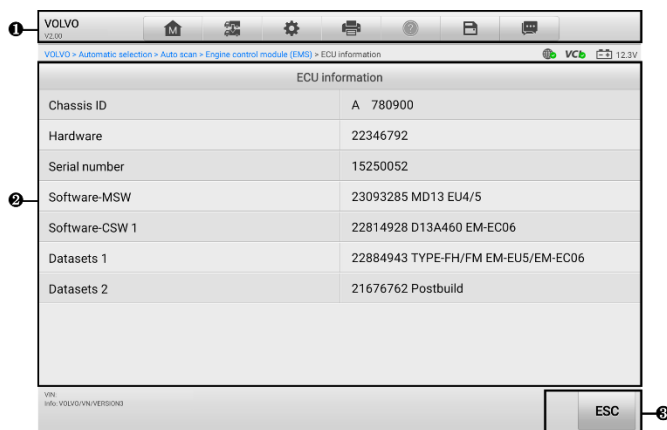

Figure 4-12 ECU Information Screen

1. Diagnostics Toolbar Buttons — see [Table 4-2 Diagnostics Toolbar Buttons](#) for detailed descriptions of the operations of each button.
2. Main Section — the left column displays the item names; the right column displays the specifications or descriptions.
3. Function Button — in this case, only an **ESC** button is available. Tap it to exit after viewing.

4.6.2 Trouble Codes

The DTC Guide, Freeze Frame, Search, Read Codes, and Erase Codes function buttons are contained in the Trouble Codes screen. The Freeze Frame button will be activated if there are freeze frame data for viewing. Tap the **Erase Codes** button to erase DTCs and other data from the ECU, while tapping the **Read Codes** button to display the detailed DTC information retrieved from the vehicle control module. When tapping **Trouble Codes** from the Diagnostics Function screen, the tablet will automatically read the DTC information in ECU.

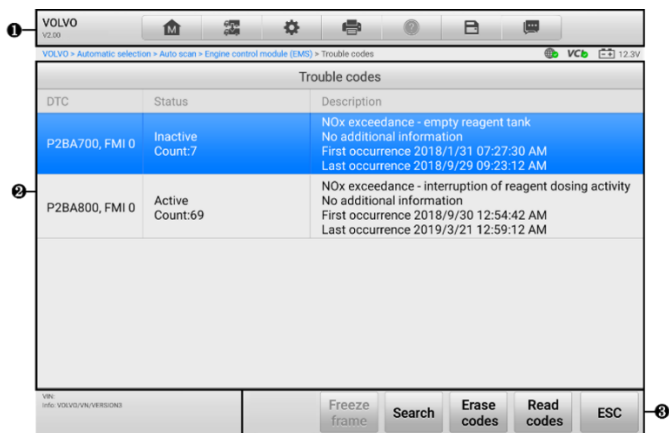

Figure 4-13 Trouble Codes Screen

1. Diagnostics Toolbar — see [Table 4-2 Diagnostics Toolbar Buttons](#) for detailed descriptions of the operations of each button.
2. Main Section
 - Column 1 — displays the retrieved codes from the vehicle
 - Column 2 — indicates the status of the retrieved codes
 - Column 3 — displays detailed descriptions for the retrieved codes

3. Function Buttons

- **Freeze Frame** — a snowflake icon appears when freeze frame data is available for viewing. Tap the button to display data screen. The Freeze frame screen is similar to that of the Read codes screen and share similar operations.
- **Search** — tap to search the selected DTC for additional information on the Internet.
- **Erase Codes** — tap to erase codes from the ECU. It is recommended to read DTCs and make necessary repairs before erasing the codes.

After reading the retrieved codes from the vehicle and certain repairs have been made, you can erase the codes from the vehicle using this function. Before performing this function, make sure the vehicle's ignition key is in the ON (RUN) position with the engine off.

➤ **To erase codes**

1. Tap **Erase Codes** in the Function Buttons.
 2. A warning message displays to inform you of data loss when this function is applied.
 - ✧ Tap **Yes** to continue. A confirming screen displays when the operation is successfully done.
 - ✧ Tap **No** to exit.
 3. Tap **ESC** on the confirming screen to exit Erase Codes screen.
 4. Check the Read Codes function again to ensure the operation is successful.
- **Read Codes** — retrieves and displays the DTCs from the vehicle control system. The Read Codes screen varies for each vehicle being tested.
 - **ESC** — tap it to return to the previous screen or exit the function.

4.6.3 Live Data

When this function is selected, the screen displays the data list for the selected module. The parameters display in the order that they are transmitted by the ECU, so expect variation among vehicles.

Gesture scrolling allows you to quickly move through the data list. Touch the screen and drag your finger up or down to reposition the parameters being displayed if the data occupies more than one screen. The figure below displays a typical Live data screen:

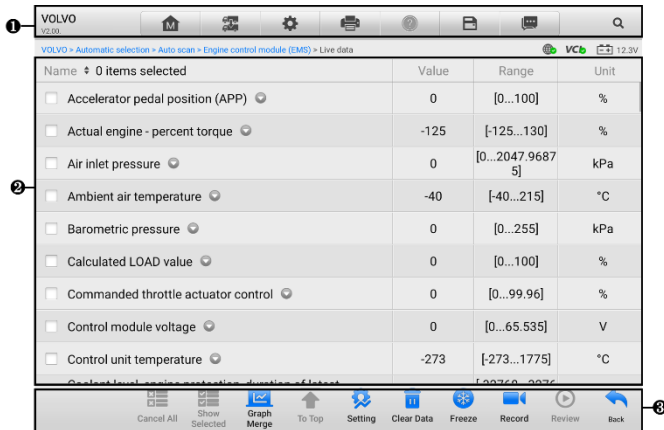

Figure 4-14 Live Data Screen

1. Diagnostics Toolbar Buttons – see [Table 4-2 Diagnostics Toolbar Buttons](#) for detailed descriptions of the operations of each button.
2. Main Section
 - Name Column — displays the parameter names.
 - ✧ Check Box — tap the check box to the left of a parameter to select the item. Tap the check box again to deselect it.
 - ✧ Drop-down Button — tap the drop-down button on the right side of a parameter to open a submenu that provides optional modes in which to display the data.
 - Value Column — displays the values of the parameters.
 - Range Column — displays the ranges of the parameters.
 - Unit Column — displays the unit for the parameter values. When you need to change the unit mode, tap the **Settings** button on the top Diagnostics Toolbar and select a required mode. See [Unit](#).
3. Function Buttons — there are many function buttons on the Live Data screen, the operations of the available Function Buttons on the Live Data screen will be described later.
 - a) Display Mode

There are four types of display modes available for data viewing, allowing you to view various types of parameters in the mode best suited to represent the data.

Tap the drop-down button on the right side of a parameter to open a submenu. A total of 7 buttons will be displayed: the 4 buttons on the left represent different data display modes, plus one Information button, active when additional information is available, and

one Unit Change button, for switching the unit of displayed data, and one Trigger button, tap to open the Trigger Settings window.



Figure 4-15 Display Mode Screen

Each parameter item displays the selected mode independently.

- ✧ **Analog Gauge Mode** — displays the parameters in gauge charts.
- ✧ **Text Mode** — the default mode that displays the parameters as a text list.

NOTE

Status parameters, such as a switch reading like ON, OFF, ACTIVE, and ABORT can only be displayed in Text Mode. Value parameters, such as a sensor reading, can be displayed in both text and graph modes.

- ✧ **Waveform Graph Mode** — displays the parameters in waveform graphs.

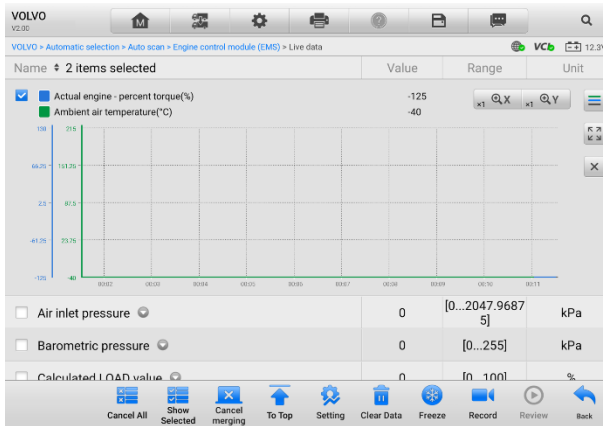

Figure 4-16 Waveform Graph Mode Screen

In this mode, five control buttons will display on the right side of the parameter, allowing you to manipulate the display status.

- 1) **Settings Button (SetY)** — sets the minimum and maximum value of the Y-axis.
- 2) **Scale Button** — changes the scale values.

There are two scale buttons, displayed above the waveform graph to the right side, which can be used to change the scale values of the X-axis and Y-axis of the graph. There are four scales available for the X-axis: x1, x2, x4 and x8. There are three scales available for the Y-axis: x1, x2, and x4.

- 3) **Edit Button** — edit the waveform color and the line thickness.
- 4) **Zoom-in Button** – tap once to display the selected data graph in full screen.
- 5) **Exit Button** — tap to exit the waveform graph mode.

Full Screen Display — this option is only available in the waveform graph mode, and mostly used in Graph Merge status for data comparison. There are four control buttons available on the top right side of the screen under this mode.

- **Scale Button** — tap to change the scale values below the waveform graph. There are four scales available for the X axis: x1, x2, x4 and x8. There are three scales available for the Y axis: x1, x2, and x4.
- **Edit Button** — tap to open an edit window, in which you can set the waveform color and the line thickness displayed for the selected parameter item.
- **Zoom-out Button** — tap to exit full screen display.
- **Exit Button** — tap to exit the waveform graph mode.

- **To edit the waveform color and line thickness in a data graph**
 1. Select a parameter to display in Waveform Graph mode.
 2. Tap the **Edit** button, and an edit window displays.

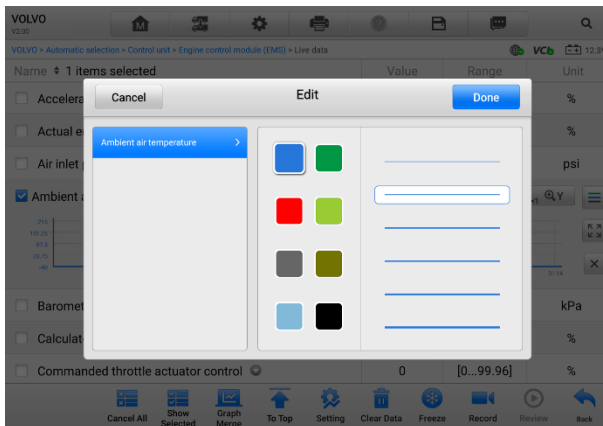

Figure 4-17 Waveform Edit Screen

3. The parameter item is selected automatically in the left column.
4. Select a color from the second column.
5. Select a line thickness from the right column.
6. Tap **Done** to save the setting and exit, or tap **Cancel** to exit without saving.

NOTE

In full screen display, please edit the waveform color and line thickness by tapping the **Edit** button on the top right side of the screen.

❖ **Digital Gauge Mode** — displays the parameters in the form of a digital gauge graph.

b) **Trigger Settings**

On the Trigger Settings screen, you can set a standard range by filling in a Minimum value and a Maximum value. When exceeding this range, the trigger function will be executed and the device will automatically record and save the generated data. You can check the saved live data by tapping the **Review** button at the bottom of the screen.

Tap the drop-down button on the right side of a parameter to open a submenu. The **Trigger** button is the last one in the submenu. Tap to display the “Trigger Settings” window.

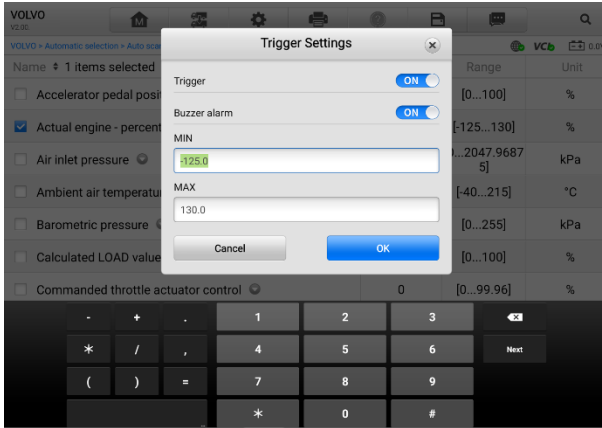

Figure 4-18 Trigger Setting Screen

Two buttons and two input boxes are available in the Trigger Settings window.

- a) **Trigger** — switches the trigger on and off. The trigger is ON by default.
- b) **Buzzer alarm** — switches the alarm on and off. The alarm function makes a beep sound as an alert when the data reading reaches the preset minimum or maximum point. The buzzer alarm will only sound at the first trigger.
- c) **MIN** — tap this input box to display a virtual keyboard to enter the required lower limit value.
- d) **MAX** — tap this input box to display a virtual keyboard to enter the required upper limit value.

➤ **To set a trigger**

1. Tap the drop-down button on the right side of the parameter name to open a submenu.
2. Tap the **Trigger** button on the right side of the submenu to open the Trigger Settings window.
3. Tap the MIN value input box to display a virtual keyboard to enter the required minimum value.
4. Tap the MAX value input box to display a virtual keyboard to enter the required maximum value.
5. Tap **OK** to save the setting and return to the Live Data screen; or tap **Cancel** to exit without saving.

 **NOTE**

When the trigger is successfully set, a trigger mark displays in front of the parameter name. The mark is gray when it is not triggered, and displays orange when triggered. Moreover, two horizontal lines display on each of the data graphs (when Waveform Graph Mode is applied) to indicate the alarm point. The limit lines are shown in different colors to differentiate them from the parameter waveforms.

c) **Function Buttons**

The operations of the available Function Buttons on the Live Data screen are described below:

- ✧ **Cancel All** — tap this button to cancel all selected parameter items. Up to 50 parameters can be selected at one time.
- ✧ **Show Selected/Show All** — tap this button to switch between the two options. One displays the selected parameters, the other displays all the available items.
- ✧ **Graph Merge** — tap this button to merge selected data graphs (for Waveform Graph Mode only). This function is very useful when comparing different parameters.

 **NOTE**

This mode supports Graph Merge of 2 to 5 parameters that can be represented digitally. Non-digital parameters are not supported.

➤ **To merge selected data graphs**

1. Select parameter items to be merged.
 2. Tap the **Graph Merge** button at the bottom of the Live Data screen.
 - a) This mode only supports parameters that can be represented digitally. If non-digital parameters are selected, a message will display advising the user that the selected parameters are not supported in this mode and to select 2 to 5 digital parameters. Tap the **Got It** button to return to the previous screen and select supported parameters.
 - b) If the selected parameters are not supported in this mode, a message will display advising the user only to select the parameters that are supported. A message will also display if more than 5 parameters have been selected. Please select 2 to 5 of the supported parameters and tap the **OK** button to merge.
 3. Tap the **Cancel Merging** button at the bottom of the Live Data screen to cancel merge.
- ✧ **To Top** — moves a selected data item to the top of the list.
 - ✧ **Setting** — tap this button to set recording duration.

➤ **To set live data record duration**

1. Tap the **Setting** button at the bottom of the Live Data screen.
2. Tap the > button to the right of **Recording time after trigger** bar and select a time length.
3. Tap **OK** to save the setting and return to the Live Data Setting screen; or tap the “**X**” button at the upper right corner to exit without saving.
4. Tap **Done** at the upper-right corner of the Live Data Setting screen to confirm and save the setting, and return to the Live Data screen; or tap **Cancel** to exit without saving.

◇ **Clear Data** — tap this button to clear all cached live data.

◇ **Freeze** — displays the retrieved data in freeze mode.

- Previous Frame — moves to the previous frame of frozen data.
- Next Frame — moves to the next frame of frozen data.
- Play/Pause — tap to play/pause the frozen data.
- Resume — tap to exit the freeze data mode and return to normal data display.

◇ **Record** — starts recording the live data of the selected data items. Tap the **Record** button at the bottom of the Live Data screen. A message will display prompting user to select parameters to record. Tap the **Got It** button to confirm. Scroll down and select data to record. Tap the **Record** button to start recording. Tap the **Resume** button to stop recording. The recorded live data can be viewed in the **Review** section at the bottom of the Live Data screen. The recorded data can also be reviewed in the Data Manager application.

● Resume — tap this button to stop data recording and to return to normal data display.

● Flag — this button displays when the Record function is applied. Tap this button to set flags to note points of interest when recording data. Notes can be added during playback in Review or Data Manager. Select the preset flag to open a popup window and display virtual keyboard to input notes.

◇ **Review** — reviews the recorded data. Tap the **Review** button to display a recording list and select one item to review.

 **NOTE**

Only the data recorded during the current operation can be reviewed on the Live Data screen. All the historical recorded data can be reviewed from Review Data in the Data Manager application.

- Previous Frame — switches to the previous frame of recorded data.
- Next Frame — switches to the next frame of recorded data.
- Play/Pause — tap to play/pause the recorded data.

- Show Selected — displays the selected parameters.
- Graph Merge — merges selected data graphs.
- Back — exits the review and returns to the Live Data screen.

✧ **Back** — returns to the previous screen or exits the function.

4.6.4 Active Test

The Active Test function is used to access vehicle-specific subsystem and component tests. Available tests vary by vehicle.

During an active test, the tablet sends commands to the ECU to activate the actuators. This test determines the integrity of the system or part by reading ECU data, or by monitoring the operation of the actuators. Such tests may include switching a solenoid, relay, or switch, between two operating states.

Selecting Active Test displays a menu of test options. Available tests vary by vehicle.

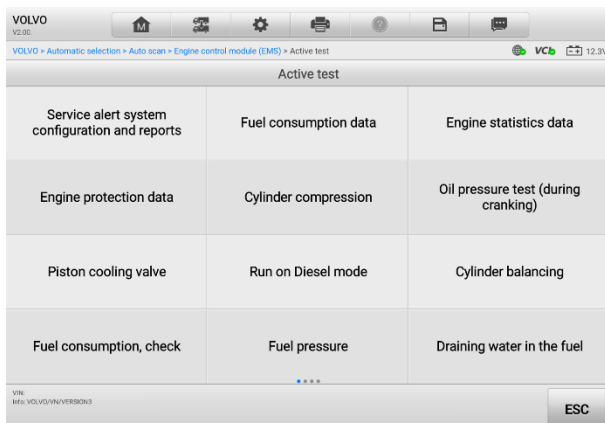

Figure 4-19 Active Test Screen

Select a test from menu options. Follow the instructions displayed on the screen to complete test. Procedures and instructions vary by vehicle.

The function buttons in the lower-right corner of the Active Test screen manipulate the test signals. The operational instructions are displayed in the main section of the test screen. Follow the on-screen instructions and make appropriate selections to complete the tests. Tap the **ESC** button to exit the test when finished.

4.6.5 Special Functions

Depending on the test vehicle, this selection may sometimes appear as Learning process, Correction programming, Emissions inspection (Not valid for USA), OBD I/M Check (Not valid for USA), or something similar. You can select one to proceed according to your demands.

4.7 Programming and Coding

Since the introduction of OBDII and leading up to modern hybrids and EVs, hardware and software technologies in cars have been advancing at an exponential rate. Updating software may be the only way to fix the following issues:

- Drivability
- Fuel Efficiency
- Power Loss
- Fault Codes
- Durability of Mechanical Parts

The Programming and Coding function is used to re-flash the vehicle control modules, which allows you to update the computer software of the vehicle to the latest version, as well as to reprogram adaptive data of certain components after making repairs or replacements.

NOTE

The programming function applies only when the vehicle is connected with a VCI device, which serves as a PassThru interface to establish communication with and transfer data to the vehicle's ECU.

Available programming or coding operations vary by test vehicle. Only the available operations display in the tablet menu.

There are two general types of programming operations:

- A. Coding — also known as Teach-in Program, or Component Adaptation, is used to reprogram adaptive data for vehicle control modules after repairs or replacements of vehicle parts.
- B. Reprogramming — downloads the latest version of software from the online server database through Internet access (this procedure is done automatically when the tablet is connected to the Internet, so there is no need to check for software updates yourself), and reprograms the newest version into the vehicle's ECU.

 **NOTE**

Ensure that the tablet is connected to a stable internet access before applying the ECU programming function, so that the tablet is able to obtain access to the vehicle manufacturer's server for update service.

Selecting the Programming opens a menu of operation options that vary by vehicle make and model. Selecting a menu option either displays a programming screen or opens another menu of additional choices. Follow the on-screen instructions to operate. How and what information is presented on the screen vary by the type of operation being performed.

4.7.1 Coding

The main section of the Coding screen displays a list of vehicle components and the coding information that mainly consists of two parts:

1. All available systems for coding are displayed on the left side, and the coding data or value on the right side.
2. The bottom of the main section displays the functional buttons that enable you to manipulate the operation.

Check the vehicle condition and the coding information carefully. Use the functional button to edit Codes for the corresponding components. Tap **Send** when you finish editing all items. When the operation is completed, an execution status message such as Completed, Finished or Successful, may display.

Tap the **ESC** button to exit the function.

4.7.2 Reprogramming

Before reprogramming begins:

- It is mandatory that the tablet is connected to stable Wi-Fi network.
- Tablet must be connected to VCI by USB.
- Tablet battery must be fully charged during module programming. Connect tablet to charger if needed.
- Attach battery maintainer to vehicle battery to ensure a steady voltage is maintained throughout programming. Voltage requirements differ by vehicle manufacturer. Consult vehicle manufacturer recommendations prior to programming a module.
- Do not quit the application during a module reprogramming as the process may fail and may also result in permanent damage to the module.

Typical reprogramming operations require you to input and validate VIN number first. Tap the input box and enter the correct number. The programming interface then displays.

The main section of the reprogramming interface offers information of the hardware, the current software version and the newest software versions to be programmed into the control units.

A series of on-screen operational instructions will display to guide you through the programming procedure.

Carefully read the on-screen information and follow the instruction to execute the programming procedure.

4.7.3 Re-flash Errors

IMPORATANT

When reprogramming onboard, always make sure the vehicle battery is fully charged and in good working condition. During reprogramming, the operation may fail if voltage falls below the proper operation voltage. Sometimes a failed operation can be recovered, but the failed reprogramming can also ruin the control module. We recommend connecting an external battery maintainer to the vehicle to ensure a steady voltage is maintained throughout programming. The required voltage differs by vehicle manufacturer. Consult vehicle manufacturer for correct voltage to be maintained.

Occasionally a flash update procedure may not complete properly. Common causes of flash errors include poor cable connections between the tablet, VCI, and vehicle, the vehicle ignition being switched off before the flash procedure is complete, or low vehicle battery voltage.

If the process quits, recheck all the cable connections to assure good communications and initialize the flash procedure. The programming procedure will automatically repeat if the previous operation does not succeed.

4.8 Generic OBDII Operations

The OBDII/EOBD vehicle diagnosis option offers a quick way to check for DTCs, isolate the cause of an illuminated malfunction indicator lamp (MIL), check monitor status prior to emissions certification testing, verify repairs, and perform other emissions-related services. The OBDII direct access option is also used for testing OBDII/EOBD compliant vehicles that are not included in the Diagnostics database. Diagnostics Toolbar Buttons at the top of the screen are available for specific vehicle diagnostics. See [Table 4-2 Diagnostics Toolbar Buttons](#) for details.

4.8.1 General Procedure

➤ To access the OBDII/EOBD diagnostics functions

1. Tap the **Diagnostics** button from the MaxiSys Job Menu. The Vehicle Menu displays.
2. Tap the **EOBD** button. There are three options to establish communication with the vehicle.
 - Auto Scan General — select it to establish communication using each protocol in order to determine which one the vehicle is using.
 - Auto Scan Enhance — if the protocol is incomplete or not scanned, tap **Auto Scan Enhance** to establish communication using the supported protocol.
 - Protocols — select it to open a submenu of various protocols. A communication protocol is a standardized way of data communication between an ECM and a diagnostic tool. Global OBD may use several different communication protocols.

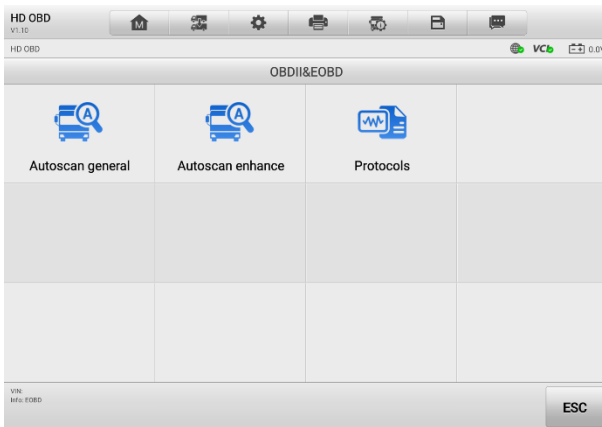



Figure 4-20 EOBD Diagnostic Menu

3. Select a specific protocol if the **Protocols** option is selected. Wait for the OBDII/EOBD Diagnostic Menu to appear.
4. Select a function option to continue.
 - DTC & FFD
 - I/M Readiness
 - Live Data
 - O2 Sensor Monitor
 - On-Board Monitor

- Component Test
- Vehicle Information
- Vehicle Status

 **NOTE**

The supported functions may vary by vehicles.

4.8.2 Function Descriptions

This section describes the various functions of each diagnostic option:

4.8.2.1 DTC & FFD

When this function is selected, the screen displays a list of Stored Codes and Pending Codes. When the Freeze Frame data of certain DTCs are available for viewing, a snowflake button will display on the right side of the DTC item. The Erase Codes and Read codes functions can be applied by tapping the Function Buttons at the bottom of the screen.

- **Current Codes**

Current codes are emission-related DTCs from the ECM of the vehicle. OBD II/EODB Codes have a priority according to their emission severity, with higher-priority codes overwriting lower-priority ones. The priority of the code determines the illumination of the Malfunction Indicator Lamp (MIL) and the codes erase procedure. Manufacturers rank codes differently, so DTCs may vary by vehicle.

- **Pending Codes**

These are codes whose storing conditions have been met during the last drive cycle, but need to be met on two or more consecutive drive cycles before the DTC stored. The purpose of displaying pending codes is to assist the service technician after a vehicle repair when diagnostic information is cleared, by reporting test results after a single driving cycle.

- a) If a test fails during the driving cycle, the DTC associated is reported. If the pending fault does not occur again within 40 to 80 warm-up cycles, the fault is automatically cleared from memory.
- b) Test results reported do not necessarily indicate a faulty component or system. If test results indicate another failure after additional driving, a DTC is stored to indicate a faulty component or system.

- **Freeze Frame**

In most cases the stored frame is the last DTC reported. Certain DTCs, those that have a greater impact on vehicle emission, have a higher priority. In these cases, DTC of the highest priority is the one for which the freeze frame records are retained. Freeze frame data includes a "snapshot" of critical parameter values at the time the DTC is stored.

- **Erase Codes**

This option is used to clear all emission-related diagnostic data including DTCs, freeze frame data and specific manufacturer-enhanced data from the vehicle ECM. This option resets the I/M Readiness Monitor Status for all vehicle monitors to Not Ready or Not Complete status.

A confirmation screen displays when the clear codes option is selected to prevent accidental loss of data. Select **Yes** on the confirmation screen to continue, or select **No** to exit.

4.8.2.2 *I/M Readiness*

This function is used to check the readiness of the monitoring system. It is an excellent function to use prior to having a vehicle inspected for state emissions compliance. Selecting I/M Readiness opens a submenu with two choices:

- Since DTCs Cleared — displays the status of monitors since the last time the DTCs are erased.
- This Driving Cycle — displays the status of monitors since the beginning of the current drive cycle.

4.8.2.3 *Live Data*

This function enables the display of real-time PID data from the ECU. Displayed data includes analog and digital input and output, and system status information broadcast in the vehicle data stream.

Live data can be displayed in various modes, see [Live Data](#) for detailed information.

4.8.2.4 *O2 Sensor Monitor*

This function allows retrieval and review of recent O2 sensor monitor test results stored on the vehicle's on-board computer.

The O2 Sensor Monitor test function is not supported by vehicles that communicate using a controller area network (CAN). For O2 Sensor Monitor tests results of CAN-equipped vehicles, refer to [On-Board Monitor](#).

4.8.2.5 On-Board Monitor

This function allows you to view the results of On-Board Monitor tests. The tests are useful after the service when a vehicle's control module memory is already erased.

4.8.2.6 Component Test

This function enables dual-directional control of the ECM so that the diagnostic tool can transmit control commands to operate the vehicle systems. This function is useful in determining how well the ECM responds to a command.

4.8.2.7 Vehicle Information

This function enables the display of the vehicle identification number (VIN), calibration identification number, calibration verification number (CVN), and other information of the test vehicle.

4.8.2.8 Vehicle Status

This function checks the current condition of the vehicle, such as the communication protocols of OBDII modules, number of fault codes, and status of the Malfunction Indicator Light (MIL).

4.9 Diagnostic Report

4.9.1 Pre-Scan and Post-Scan Functions

After performing pre-scan and post-scan functions by entering the same maintenance order number, tap **Data Manager > Vehicle History** to select the historical test record named with the maintenance order number. Both the pre-scan results and post-scan results will be displayed in the same historical test record, which can be generated as a PDF report for easily comparing the changes between pre-scan and post-scan.

- **Pre-Scan Function**

Select and tap a vehicle button from the Vehicle Menu screen. Enter the maintenance order number in the pop-up box to scan and detect the whole vehicle. You can also add pictures to record the current condition of the vehicle. Once the pre-scan is completed, you are not allowed to perform pre-scan again, and the scan result cannot be modified.

- **Post-Scan Function**

After the pre-scan is complete, exit the current test vehicle and tap the vehicle button from the Vehicle Menu screen to reconnect again. Enter the same maintenance

order number in the pop-up box. The screen for post-scan will display. The post-scan record will be generated when the scan is completed. The pre-scan results and post-scan results will be displayed in the same historical test record.

 **NOTE**

The post-scan function can be performed repeatedly. After exiting the vehicle, you only need to tap the vehicle button from the Vehicle Menu screen to reconnect again, then enter the same maintenance order number in the pop-up box and follow the steps to rescan. The last one is the final post-scan result.

4.9.2 Diagnostics Report Saving, Viewing, and Sharing

The diagnostic report can be reviewed, saved, and shared with others through many ways.

4.9.2.1 Diagnostics Report Saving

- Via the **History** function
 1. Enter the main screen of the Diagnostics application, and tap **History** on the top toolbar.

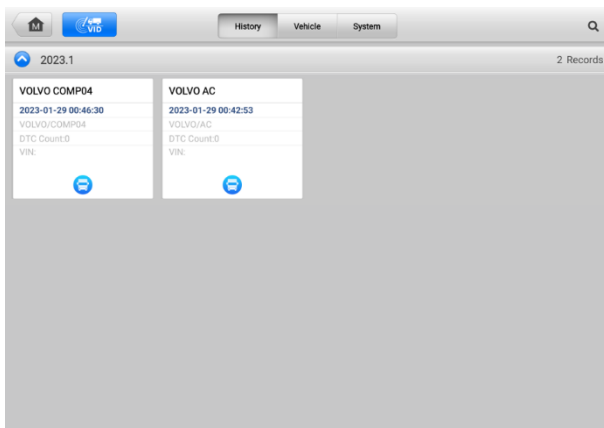



Figure 4-21 History Screen

2. Select a history record, and tap the  button on the upper-right corner.

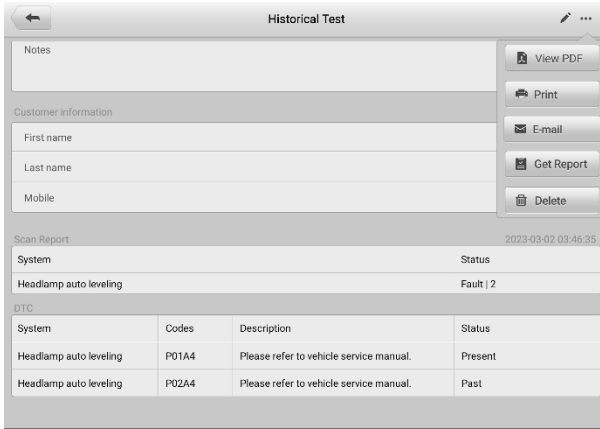

Figure 4-22 Historical Test Screen

3. Tap **Get Report**. Enter the license plate and current mileage. Tap **Save**.
- Via the **Auto Scan** function
 1. Enter the Auto Scan page and tap **Fault Scan** from the function buttons at the bottom of the screen.

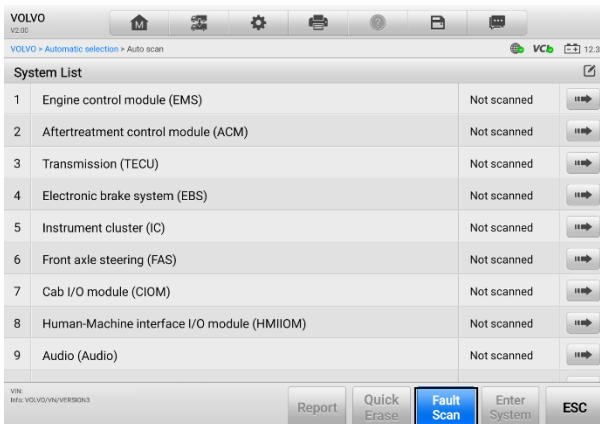

Figure 4-23 Auto Scan Screen 1

- When the system scan is completed, tap **Report** from the function buttons at the bottom of the screen.

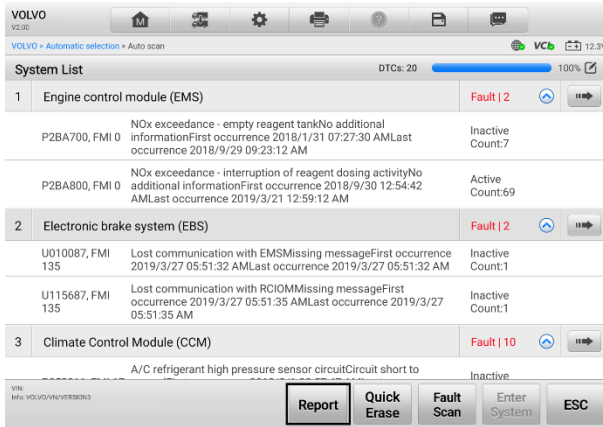





Figure 4-24 Auto Scan Screen 2

- Via the functions on the Diagnostics Toolbar

The diagnostic report can also be viewed from such diagnostics functions screen including Auto scan, Trouble codes, Live data, and Active test. There are two ways to view the saved reports:

- ✧ Tap the  button in the Diagnostics Toolbar and select **Save as PDF**. Enter the license number and tap **Save**. Tap the  button on the upper-right of the screen to view the report.
- ✧ Tap the  button in the Diagnostics Toolbar and select **Report to Cloud**. Enter the license plate and current mileage. Tap **Save > View Report** and then select a saved report to view.

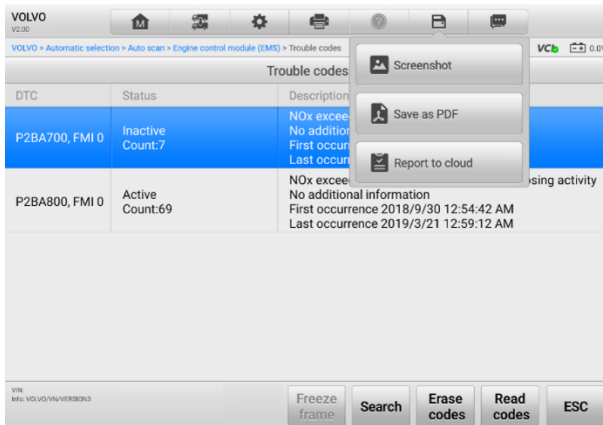

Figure 4-25 Trouble Codes Screen

4.9.2.2 Diagnostics Report Viewing

All the saved reports can be viewed in the Data Manger application.

- ✧ Tap **Data Manager > Vehicle History**. Select a specific vehicle history record and then tap **View PDF** in the upper-right corner to view the report.
- ✧ Once you save the reports by tapping the **Save as PDF** button, tap **Data Manager > PDF** to view these local reports.
- ✧ Once you save the reports by tapping the **View Report** or **Save Report** button, tap **Data Manager > Cloud Report** to view these reports saved to the Autel cloud platform.

4.9.2.3 Diagnostics Report Cloud Sharing

1. Tap **Data Manager > Cloud Report** to enter the Report List screen.

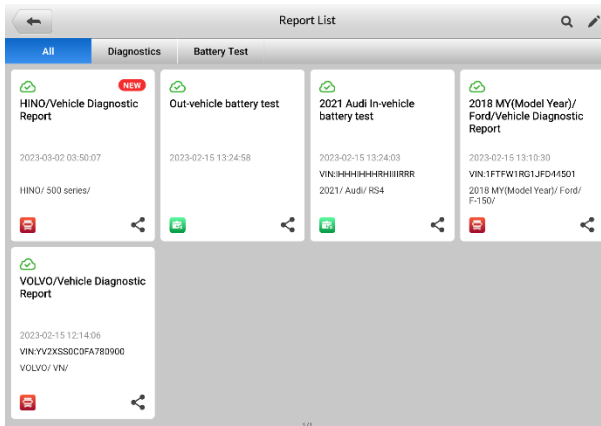





Figure 4-26 Report List Screen

NOTE

Note that if the report displays , it means the report has been uploaded to the cloud successfully, and you can share the report with others; if the report displays , it means the report has failed to upload to the cloud, but will try to automatically upload to the cloud when entering the Report again.

2. Tap the  on the lower-right corner of the report.
3. There are three ways for report cloud sharing: scan the QR code, send by email, send by SMS (via phone number).

4.10 Exit Diagnostics

The Diagnostics application operates while communication with the vehicle is still active. It is important to properly exit from the diagnostics operation screen to stop all communications with the vehicle before closing the Diagnostics application.

NOTE

Damage to the vehicle Electronic Control Module (ECM) may occur if communication is disrupted. Ensure all forms of communication link such as data cable, USB cable, and wireless or wired network, are properly connected throughout the test. Exit all screens before disconnecting the test cable and power supply.

➤ **To exit the Diagnostics application**

- On an active diagnostic screen:
 1. Tap the **Back** or **ESC** button to exit a diagnostic session.
 2. Tap the **Vehicle Swap** button in the Diagnostics Toolbar to return to the Vehicle Menu screen.
- On the vehicle menu screen:
 1. Tap the **Home** button on the top toolbar.
 2. Tap the **Back** button on the Navigation Bar at the bottom of the screen.
 3. Tap the **Home** button on the Diagnostics Toolbar to exit the application directly and return to the MaxiSys Job Menu.

 **NOTE**

After exiting the Diagnostics application, the tablet is no longer communicating with the vehicle and it is safe to open other MaxiSys applications.

5 Service

The Service section is specially designed to provide quick access to the vehicle systems for various scheduled service and maintenance tasks. The typical service operation screen is a series of menu driven executive commands. Follow on-screen instructions to select appropriate execution options, enter correct values or data, and perform necessary actions. The application will display detailed instructions to complete selected service operations.

After entering each special function, the screen will display two application choices: Diagnosis and Hot Functions. The Diagnosis enables the reading and clearing of codes which is sometimes necessary after completing certain special functions. Hot Functions consists of sub functions of the selected special function.

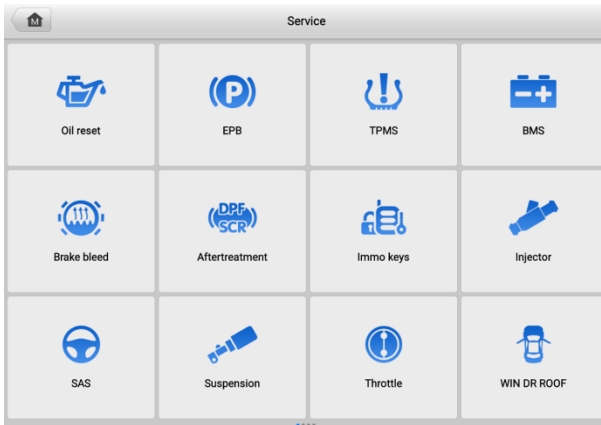

Figure 5-1 Service Menu

Several most commonly used services are described in this chapter.

5.1 Oil Reset Service

Perform reset for the Engine Oil Life system, which calculates an optimal oil life change interval depending on the vehicle driving conditions and climate. The Oil Life Reminder must be reset each time the oil is changed, so the system can calculate when the next oil change is required.

NOTE

1. Always reset the engine oil life to 100% after every oil change.
 2. All required work must be carried out before the service indicators are reset. Failure to do so may result in incorrect service values and cause DTCs to be stored by the relevant control module.
 3. For some vehicles, the scan tool can reset additional service lights such as maintenance cycle and service interval. On BMW vehicles for example, service resets include engine oil, spark plugs, front/rear brakes, coolant, particle filter, brake fluid, micro filter, vehicle inspection, exhaust emission inspection and vehicle checks.
-

5.2 Electric Parking Brake (EPB) Service

This function has a multitude of usages to maintain the electronic braking system safely and effectively. The applications include deactivating and activating the brake control system, assisting with brake fluid control, opening and closing brake pads, and setting brakes after disc or pad replacement.

5.2.1 EPB Safety

It can be dangerous to perform Electric Parking Brake (EPB) system maintenance, so before you begin the service work, please keep these rules in mind.

- ✓ Ensure that you are fully familiar with the braking system and its operation before commencing any work.
- ✓ The EPB control system may be required to be deactivated before carrying out any maintenance/diagnostic work on the brake system. This can be done from the tool menu.
- ✓ Only perform maintenance work when the vehicle is stationary and on level ground.
- ✓ Ensure that the EPB control system is reactivated after the maintenance work has been completed.

NOTE

Autel accepts no responsibility for any accident or injury arising from the maintenance of the Electric Parking Brake system.

5.3 Tire Pressure Monitoring System (TPMS) Service

This function allows you to quickly look up the tire sensor IDs from the vehicle ECU, as well as to perform TPMS replacement and reset procedures after tire sensors are replaced.

5.4 Battery Management System (BMS) Service

The Battery Management System (BMS) allows the tool to evaluate the battery charge state, monitor the close-circuit current, register the battery replacement, activate the rest state of the vehicle, and charge the battery via the diagnostic socket.

NOTE

1. This function is not supported by all vehicles.
 2. The sub functions and actual test screens of the BMS may vary by vehicle, please follow the on-screen instructions to make correct option selection.
-

The vehicle may use either a sealed lead-acid battery or an Absorbed Glass Mat (AGM) battery. Lead acid battery contains liquid sulphuric acid and can spill when overturned. AGM battery (known as VRLA battery, valve regulated lead acid) also contains sulphuric acid, but the acid is contained in glass mats between terminal plates.

It is recommended that the replacement aftermarket battery has the same specifications, such as capacity and type, as the exiting battery. If the original battery is replaced with a different type of battery (e.g. a lead-acid battery is replaced with an AGM battery) or a battery with a different capacity (mAh), the vehicle may require reprogramming of the new battery type, in addition to, performing the battery reset. Consult the vehicle manual for additional vehicle-specific information.

5.5 Diesel Particle Filter (DPF) Service

The Diesel Particle Filter (DPF) function manages DPF regeneration, DPF component replacement teach-in and DPF teach-in after replacing the engine control unit.

The ECM monitors driving style and selects a suitable time to employ regeneration. Cars driven a lot at idling speed and low load will attempt to regenerate earlier than cars driven more with higher load and speed. For regeneration to take place, a prolonged high exhaust temperature must be obtained.

In the event of the car being driven in such a way that regeneration is not possible, i.e., frequent short journeys, a diagnostic trouble code will eventually be registered in addition to the DPF light and “Check Engine” indicators displaying. A service regeneration can be requested in the workshop using the diagnostic tool.

Before performing a forced DPF regeneration using the tool, check the following items:

- The fuel light is not on.
- No DPF-relevant faults are stored in system.
- The vehicle has the specified engine oil.

- The oil for diesel is not contaminated.

1 IMPORTANT

Before diagnosing the problematic vehicle and attempting to perform an emergency regeneration, it is important to obtain a full diagnostic log and read out relevant measured value blocks.

NOTE

1. The DPF will not regenerate if the engine management light is on, or there is a faulty EGR valve.
 2. The ECU must be re-adapted when replacing the DPF and when topping up the fuel additive Eolys.
 3. If the vehicle needs to be driven in order to perform a DPF service, a second person is needed for the function. One person should drive the vehicle while the other person observes the screen on the Tool. Do not attempt to drive and observe the scan tool at the same time. This is dangerous and puts your life and the lives of other motorists and pedestrians at risk.
-

5.6 Immobilizer (IMMO) Service

An immobilizer is an anti-theft mechanism that prevents an automobile's engine from starting unless the correct ignition key or other device is present. This device prevents thieves from starting the car by a method known as hot wiring. Most new vehicles have an immobilizer as standard equipment. An important advantage of this system is that it doesn't require the car owner to activate it; it operates automatically. An immobilizer is considered as providing much more effective anti-theft protection than an audible alarm alone; many auto insurance companies offer lower rates for vehicles that are equipped with an immobilizer.

As an anti-theft device, an immobilizer disables one of the systems needed to start a car's engine, usually the fuel supply or the ignition. This is accomplished by radio frequency identification between a transponder in the ignition key and a device called a radio frequency reader in the steering column. When the key is placed in the ignition, the transponder sends a signal with a unique identification code to the reader, which relays it to a receiver in the vehicle computer control module. If the code is correct, the computer allows the fuel supply and ignition systems to operate and start the car. If the code is incorrect or absent, the computer disables the system, and the car will be unable to start until the correct key is placed in the ignition.

The IMMO service can disable a lost vehicle key and program the replacement key fob. One or more replacement key fobs can be programmed.

5.7 Steering Angle Sensor (SAS) Service

SAS Calibration permanently stores the current steering wheel position as the straight-ahead position in the SAS EEPROM. Therefore, the front wheels and the steering wheel must be set exactly to the straight-ahead position before calibration. In addition, the VIN is also read from the instrument cluster and stored permanently in the SAS EEPROM. On successful completion of calibration, the SAS fault memory is automatically cleared.

Calibration must always be carried out after the following operations:

- Steering wheel replacement
- SAS replacement
- Any maintenance that involves opening the connector hub from the SAS to the column
- Any maintenance or repair work on the steering linkage, steering gear or other related mechanism
- Wheel alignment or wheel track adjustment
- Accident repairs where damage to the SAS or assembly, or any part of the steering system may have occurred.

NOTE

1. Autel accepts no responsibility for any accident or injury arising from servicing the SAS system. When interpreting DTCs retrieved from the vehicle, always follow the manufacturer's recommendation for repair.
 2. All software screens shown in this manual are examples, and actual test screens may vary by test vehicle. Pay attention to the menu titles and onscreen instructions to make correct option selections.
 3. Before starting procedure, make sure the vehicle has an ESC button. Look for button on dash.
-

6 Data Manager

The Data Manager application allows you to store, print, and review the saved files, manage the workshop information, and customer information records, and keep test vehicle history records.





Selecting the Data Manager application opens the file system menu. There are nine main functions available.







Figure 6-1 Data Manager Main Screen

The table below briefly describes each of the function buttons in the Data Manager application.

Table 6-1 Buttons in Data Manager

Button	Name	Description
	Vehicle History	Tap to review the diagnostics history record.
	Workshop Information	Tap to edit the information of workshops.
	Customer	Tap to create new customer information.
	Image	Tap to review the screenshots.

Button	Name	Description
	Cloud Report	Tap to review the saved reports and share cloud reports.
	PDF	Tap to review the reports stored as PDF files.
	Review Data	Tap to review the recorded data.
	Data Logging	Tap to review the communication data and ECU information of the vehicle. The saved data can be reported and sent to the technical center via the Internet.
	Uninstall Apps	Tap to uninstall applications.

6.1 Vehicle History

This function stores records of test vehicle history, including vehicle information and the retrieved DTCs from previous diagnostic sessions. Test information is summarized and displayed in an easy-to-read table listing. The Vehicle History also provides direct access to the previously tested vehicle and allows you to directly restart a diagnostic session without needing to perform auto or manual vehicle selection.

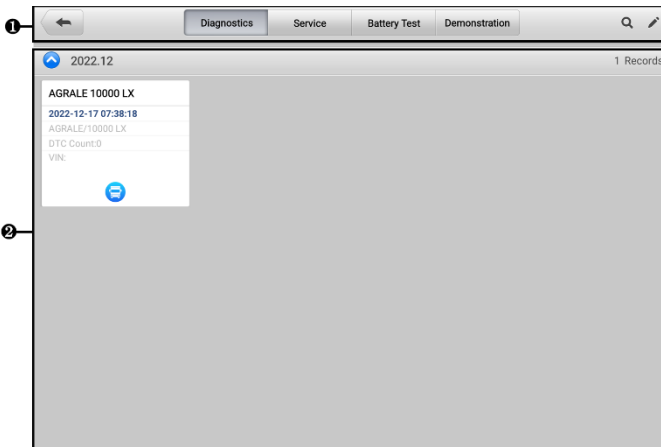

Figure 6-2 Vehicle History Screen

1. Top Toolbar Buttons — navigation and application controls.
2. Main Section — displays all the vehicle history records.
- **To activate a test session for the recorded vehicle**
 1. Tap **Data Manager** on the MaxiSys Job Menu.
 2. Select **Vehicle History** to open the screen. Tap the relevant application tab to select the test record. For example, tap **Diagnostics** to select diagnostic test records.
 3. Tap the **Diagnostics** icon at the bottom of the thumbnail of a vehicle record item.
 4. The Diagnostics screen of the vehicle displays and a new diagnostic session is activated. See [Diagnostics](#) to continue the diagnostics. Or,
 5. Select a vehicle thumbnail to open a record. A Historical Test record sheet displays. Review the recorded information of the test vehicle, and tap the **Diagnostics** button on the upper-right corner.

NOTE

The MaxiSys tablet must establish a stable connection to the VCI device to restart test sessions on the previously tested vehicles.

6.1.1 Historical Test Record

The Historical Test Record is a detailed data form of the vehicle, which includes general vehicle information, service record, customer information, and the diagnostic trouble codes retrieved from the previous test sessions. Technician Notes will also appear if present.

System	Status
Headlamp auto leveling	Fault 2

System	Codes	Description	Status
Headlamp auto leveling	P01A4	Please refer to vehicle service manual.	Present
Headlamp auto leveling	P02A4	Please refer to vehicle service manual.	Past

Figure 6-3 Historical Test Record Sheet

➤ **To edit the Historical Test record**

1. Tap **Data Manager** on the MaxiSys Job Menu.
2. Select **Vehicle History**.
3. Select the specific vehicle history record thumbnail from the main section. The Historical Test record will display.
4. Tap **Edit** (a pen icon) to start editing.
5. Tap each item to input information or attach files or images.

 **NOTE**

The vehicle VIN, license number, and customer account information are correlated by default. Vehicle records will automatically be correlated using this vehicle and customer identification.

6. Tap **Add to Customer** to correlate the Historical Test record sheet to an existing customer account, or add a new associated account to be correlated with the test vehicle record. See [Customer](#) for more information.
7. Tap **Done** to save the updated record, or tap **Cancel** to exit without saving.

6.2 Workshop Information

The Workshop Information form allows you to edit, input, and save the detailed workshop information, such as shop name, address, phone number, and other remarks, which, when printing vehicle diagnostic reports and other associated test file, will display as the header of the printed documents.

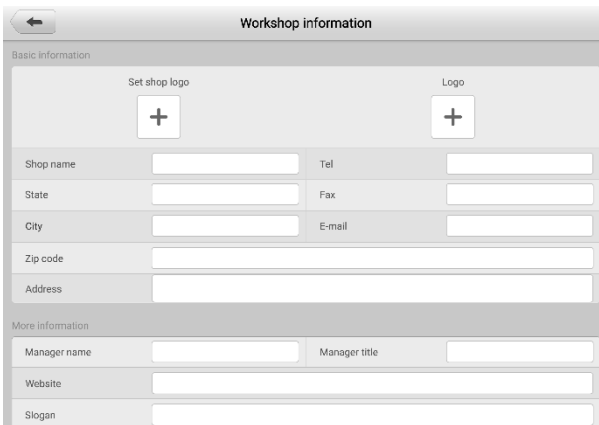

Workshop information			
Basic information			
Set shop logo		Logo	
	<input type="text"/>		<input type="text"/>
Shop name	<input type="text"/>	Tel	<input type="text"/>
State	<input type="text"/>	Fax	<input type="text"/>
City	<input type="text"/>	E-mail	<input type="text"/>
Zip code	<input type="text"/>		
Address	<input type="text"/>		
More information			
Manager name	<input type="text"/>	Manager title	<input type="text"/>
Website	<input type="text"/>		
Slogan	<input type="text"/>		

Figure 6-4 Workshop Information Sheet

➤ **To edit the Workshop Information sheet**

1. Tap the **Data Manager** application on the MaxiSys Job Menu.
2. Select **Workshop Information**.
3. Tap on each field to input the appropriate information.
4. Tap **Done** to save the updated workshop information record, or tap **Cancel** to exit without saving.

6.3 Customer

The Customer function allows you to create and edit customer accounts. It helps you to save and organize all customer information accounts that are correlated with the associated test vehicle history records.

➤ **To create a customer account**

1. Tap the **Data Manager** application on the MaxiSys Job Menu.
2. Select **Customer**.
3. Tap the **Add a Customer** button. An empty information form displays; tap each field to input the appropriate information.

 **NOTE**

The items that must be filled are indicated as required fields.

4. Some customers may have more than one vehicle for service; you can always add new vehicle information to the account. Tap **Add New Vehicle Information**, and then fill in the vehicle information. Tap the  button to cancel.
5. Tap **OK** to save the account, or tap **Cancel** to exit without saving.

➤ **To edit a customer account**

1. Tap **Data Manager** on the MaxiSys Job Menu.
2. Select **Customer**.
3. Select a customer account by tapping the corresponding name card. A Customer Information record displays.
4. Tap **Edit** on the top toolbar to start editing.
5. Tap on the input field to edit or amend information, and enter updated information.
6. Tap **Complete** to save the updated information, or tap **Cancel** to exit without saving.

➤ **To delete a customer account**

1. Tap **Data Manager** on the MaxiSys Job Menu.
2. Select **Customer**.

3. Tap the **Delete** icon on the right of a customer account. A message displays.
4. Tap **OK** to confirm the command, and the account is deleted, or tap **Cancel** to cancel the request.

6.4 Image

The Image section is a PNG database containing all captured screenshots.

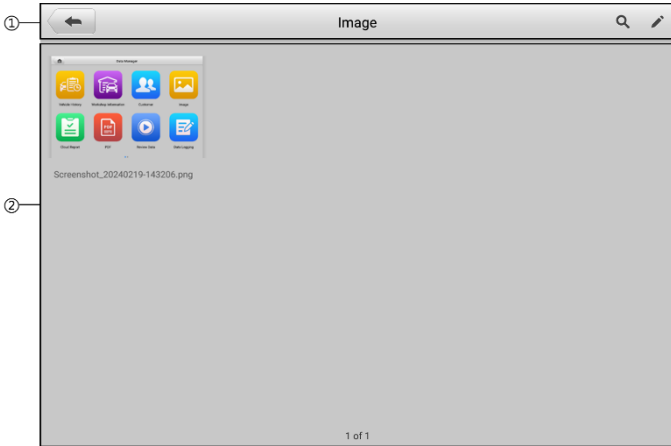



Figure 6-5 Image Database Screen

1. Toolbar Buttons — used to edit, print, or delete the image files. See [Table 6-2 Toolbar Buttons in PNG Database](#) for detailed information.
2. Main Section — displays the stored images.

Table 6-2 Toolbar Buttons in PNG Database

Button	Name	Description
	Back	Returns to the previous screen.
	Search	Tap to search the image by entering its stored time.
	Edit	Tap to display the editing toolbar to select, delete, print, or email the image(s).
	Cancel	Tap to close the editing toolbar or cancel file search.
	Print	Tap to print the selected image.

Button	Name	Description
	Delete	Tap to delete the selected image.
	Email	Tap to send the selected image to an email.

➤ **To edit/delete image(s)**

1. Select **Data Manager** from the MaxiSys Job Menu.
2. Select **Image** to access the PNG database.
3. Tap **Edit** on the top-right corner of the window. The editing screen displays.
4. Select the image(s) you want to edit by tapping the check box at the bottom-right corner of the image.
5. Tap the **Delete** icon to delete the selected images or delete all images. Tap the **Print** icon to print the selected image(s). Tap the **Email** icon to send the selected image(s) to an email.

6.5 Cloud Report

This section displays the saved reports, which can be transferred to the Autel cloud platform once a stable network connection is established. These reports can then be viewed or shared with others. See [Scan Report](#) and [Diagnostics Report Saving, Viewing, and Sharing](#) for further details.

6.6 PDF Files

The PDF files designated for local viewing are displayed in this section. Enter the PDF database and select a file to access the saved information.

This section uses the standard Adobe Reader application for file viewing and editing. Please refer to the associated Adobe Reader manual for more detailed instructions.

6.7 Review Data

The Review Data section allows you to play back the recorded data frames of live data streams.

On the Review Data main screen, select a record file to play back.

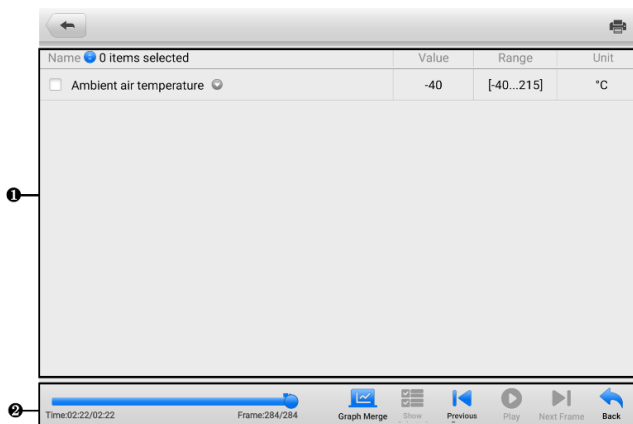

Figure 6-6 Data Playback Screen

1. Main Section — displays the recorded data frames.
2. Navigation Toolbar — allows you to manipulate data playback.

Use the Navigation Toolbar buttons to play back the record data from frame to frame.

Tap **Back** to exit data playback.

6.8 Data Logging

The Data Logging section allows you to launch Support platform directly to view all records of all feedback or no feedback data loggings on the diagnostic system. For more details, see [Data Logging](#).

6.9 Uninstall Apps

This section allows you to manage the software applications installed on the MaxiSys diagnostics system. Selecting this section opens a managing screen, on which you can check all available vehicle diagnostic applications.

Select the vehicle software you want to delete by tapping on the vehicle manufacturer icon. The selected item will display a blue mark at the upper-right corner. Tap the **Delete** button on the top toolbar to delete the software from the system database.

7 Settings

Access the Settings menu to adjust default setting and view information about the MaxiSys system. The following options are available for the MaxiSys system settings:

- Unit
- Language
- Printing Settings
- Scan Report
- Push Notifications
- Auto Update
- Vehicle List
- System Settings
- About

7.1 Unit

This option allows you to change the measurement unit for the diagnostic system.

➤ **To adjust the unit setting**

1. Tap the **Settings** application on the MaxiSys Job Menu.
2. Tap the **Unit** option on the left column.
3. Select the appropriate measurement unit, Metric, Imperial, or American unit. A check mark will display to the right of the selected unit.
4. Tap the **Home** button on the top-left corner to return to the MaxiSys Job Menu, or select another settings option for system setup.

7.2 Language

This option allows you to adjust the display language for the MaxiSys system.

➤ **To adjust the language setting**

1. Tap the **Settings** application on the MaxiSys Job Menu.
2. Tap the **Language** option on the left column.
3. Select the appropriate language. A check mark will display to the right of the selected language.
4. Tap the **Home** button on the top-left corner to return to the MaxiSys Job Menu, or select another settings option for system setup.

7.3 Print Settings

This option allows you to print from the tablet to a network printer via a computer.

➤ **To setup the printer connection**

1. Tap **Settings** on the MaxiSys Job Menu.
2. Tap **Printing Settings** on the left column.
3. Tap **Print via PC-Link** or **Print via Wi-Fi** to activate the printing function, which enables the device to send files to the printer through the PC via Wi-Fi or Ethernet connection.
4. Tap the **Home** button on the top-left corner to return to the MaxiSys Job Menu, or select another settings option for system setup.

7.3.1 Printing Operations

➤ **To install the MaxiSys Printer driver**

1. Download **Maxi PC Suite** from www.autel.com > Support > Downloads > Autel Update Tools, and install it to a Windows-based PC.
2. Double click on **Setup.exe**.
3. Select the installation language and the wizard will load.
4. Follow the instructions on the screen and Click on **Next** to continue.
5. Click **Install** and the printer driver program will be installed onto the PC.
6. Click **Finish** to complete the installation.

 **NOTE**

The MaxiSys printer runs automatically after the installation. The PC, printer and the tablet must be connected to the same network.

This section describes how to receive file from the MaxiSys tablet and perform printing through the PC.

 **NOTE**

- Make sure the tablet is connected to the same network with your PC, either via Wi-Fi or LAN, before printing.
 - Make sure the PC installed with the Printing Services program is connected to a printer.
-

➤ **To perform printing through the PC**

1. Ensure the tablet is connected to the PC network, either via Wi-Fi or LAN, before printing.
2. Run the **PC Link** program on the computer.
3. Select the **MaxiSys Printer** tab.

4. Tap the **Print** button in the tablet top toolbar. A document will be sent to the computer.
 - If the **Auto Print** option in the MaxiSys Printer is selected, the MaxiSys Printer will print the received document automatically.
 - If the **Auto Print** option is not selected, click **Open PDF File** button to view files. Select the file(s) to print and click **Print**.
-

 **NOTE**

To confirm that the printer is functioning normally, you can click **Test Print** in the PC Link program to test.

7.4 Scan Report

Two options are available in this section: Scan Report and Report Upload to Cloud.

- Scan Report

Toggle the **ON/OFF** button to enable/disable Pre-Scan and Post-Scan functions, which enable the user to compare the changes between pre-scan and post-scan. For more information about the pre-scan and post-scan functions, see [Pre-Scan and Post-Scan Functions](#) for details.

- Report Upload to Cloud

This option automatically synchronizes the diagnostics information of the vehicle to the vehicle history and forms a diagnostic report for the user to upload. Tap the **ON/OFF** button the Report Upload to Cloud function. The button appears blue if the function is enabled and displays gray if the function is disabled. For more information about the Report Upload to Cloud function, see [Diagnostics Report Saving, Viewing, and Sharing](#) for details.

 **NOTE**

Make sure the tablet is connected to the Internet while uploading reports.

7.5 Push Notifications

This option allows you to manage notifications. The Notification Preferences option is turned on by default and cannot be turned off by users so that certain system notifications such as system security warnings won't be blocked. Internet access is required for receiving on-line messages.

➤ **To manage other notifications**

1. Tap **Settings** on the MaxiSys Job Menu.
2. Tap **Push Notifications** on the left column.
3. Tap the  button on the right of the Other Notifications option to open a drop-

down list.

4. There are four options: Enable all notifications, Limit to 3 notifications or less per week, Limit to 1 notification per week, and Disable all notifications. Select whichever you want.
5. Tap **Home** on the top-left corner to return to the MaxiSys Job Menu, or select another settings option for the system setup.

NOTE

- Notifications will display on the screen. Slide the screen from top to check the received messages. If the message list covers more than one screen, slide the list up or down to view them.
 - Tapping a specific message launches the corresponding application. For example, if you tap on an Update notification, the Update application will be launched.
-

7.6 Auto Update

The Auto Update allows the tool to automatically update the OS, the MaxiSys system, and the vehicle coverage software. Each can be configured to update automatically at a specified time. Tap the **ON/OFF** button to enable/disable the desired automatic update time.

➤ **To set auto system or vehicle update**

1. Tap the **Settings** application on the MaxiSys Job Menu.
2. Tap the **Auto Update** option on the left column. The three auto update items will display on the right of the screen.
3. Select the update type to schedule. Toggle the button to **ON**.
4. Tap on the time to set the time of the day for updating. If the update time is set and the device is connected to the Internet, the selected software will be automatically updated at the configured time.

7.7 Vehicle List

This option allows you to sort the vehicles either by alphabetic order or by frequency of use.

➤ **To adjust the vehicle list setting**

1. Tap the **Settings** application on the MaxiSys Job Menu.
2. Tap **Vehicle List** on the left column.
3. Select the required sort type. A check mark will display to the right of the selected item.
4. Tap the **Home** button in the top-left corner to return to the MaxiSys Job Menu, or select another settings option for system setup.

7.8 System Settings

This function provides you with direct access to the Android system setting interface, where you can adjust various system settings for the Android system platform. Regarding wireless and networks settings, various device settings such as sound and display, as well as system security settings, and check related information about the Android system. Refer to Android documentation for additional information.

7.9 About

The About function provides information of the MaxiSys diagnostic device including the product name, version, hardware, and serial number.

➤ **To check the MaxiSys product information in About**

1. Tap the **Settings** application on the MaxiSys Job Menu.
2. Tap the **About** option on the left column. The product information screen displays on the right.
3. Tap the **Home** button on the top-left corner to return to the MaxiSys Job Menu, or select another settings option for system setup.

8 VCI Manager

This application pairs the tablet with the VCI device, checks the communication status and updates the VCI firmware.

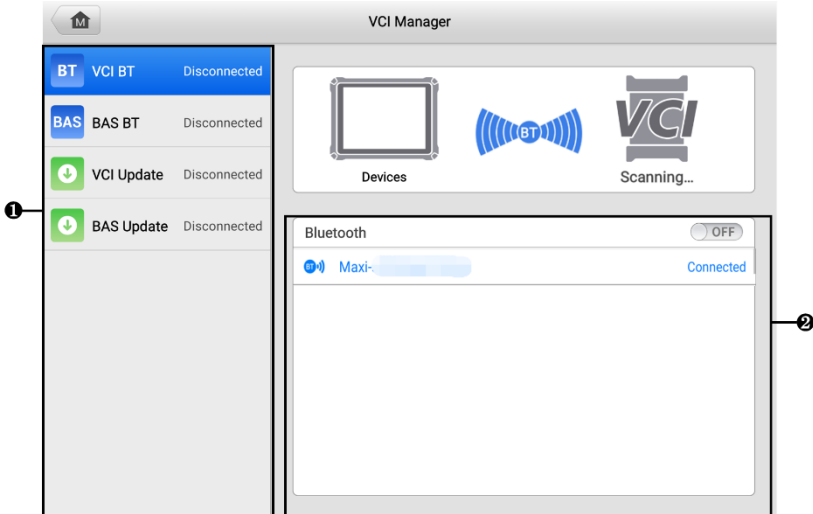

Figure 8-1 VCI Manager Screen

1. Connection Mode — there are four connection modes available for selection. The connection status is displayed alongside.
 - VCI BT — when the VCI is paired to a device via Bluetooth, the connection status displays as “Connected.” Otherwise, it displays as “Disconnected.”
 - BAS BT — when paired to a battery tester via Bluetooth, the connection status displays as “Connected.” Otherwise, it displays as “Disconnected.”
 - VCI Update — connects the VCI to the diagnostic tablet via Bluetooth first, then updates the VCI firmware through the tablet.
 - BAS Update — updates the BT506 battery tester’s firmware via the Internet through the tablet.

2. Bluetooth Settings

Toggle the Bluetooth ON/OFF button to **ON**. The Bluetooth Settings screen displays the device name for all the devices available for pairing. You can tap the needed one to start pairing. The BT status icon displayed to the left of the device name indicates the received signal strength.

8.1 VCI Bluetooth Pairing

The VCI device needs to be connected to a vehicle, so that it is powered during the synchronization procedure. Ensure the tablet has sufficient battery power or is connected to an external power supply.

➤ **To pair the VCI device with the tablet**

1. Power on the tablet.
2. Connect the 26-pin end of the main cable to the VCI device's Vehicle Data Connector.
3. Connect the 16-pin end of the main cable to the vehicle's Data Link Connector (DLC).
4. Tap the **VCI Manager** application on the MaxiSys Job Menu of the tablet.
5. Select **VCI BT** from the Connection Mode list on the left column.
6. Toggle the Bluetooth ON/OFF button to **ON**. Tap the **Scan** button at the top-right corner. Now the device starts searching for available pairing units.
7. The device name may display as "Maxi-" suffixed with a serial number. Select the appropriate device for pairing.
8. When the pairing is successfully done, the connection status displayed to the right of the device name is shown as "Connected."
9. Once connected, the BT badge displays at the bottom-right corner of the VCI Manager shortcut, and the Connection LED on the VCI device illuminates solid blue, which signifies that the tablet is connected to the VCI device, and is ready to perform vehicle diagnosis. If you need to disconnect the connected device, tap it again.
10. Tap the **Home** button on the top-left to return to the MaxiSys Job Menu.

 **NOTE**

A VCI device can only be connected to one tablet at a time, and once it's connected, the device will not be discoverable to other devices.

8.2 BAS Bluetooth Pairing

The BT506 battery tester device can be connected with the tablet via Bluetooth. Ensure that the BT506 battery tester is sufficiently charged or is connected to an external power supply before use.

➤ **To pair the Battery Tester with the tablet**

1. Power on the diagnostic tablet and the battery tester.
2. Connect the red clamp to the positive (+) battery terminal and the black clamp to the negative (-) battery terminal.

3. Tap **VCI Manager** on the MaxiSys Job Menu of the tablet.
4. Select **BAS BT** from the Connection Mode list on the left column.
5. Toggle the Bluetooth ON/OFF button to **ON**. Tap **Scan** at the top-right corner of the screen. The device will start to search for available units to pair with.
6. Depending on the type of battery tester, the device name may appear as “Maxi-” suffixed with the battery tester’s serial number. Select the appropriate device for pairing.
7. When paired successfully, the connection status reads “Connected.”

8.3 VCI Update

8.3.1 Update via Tablet

Before updating the VCI firmware, ensure the tablet’s connection to the Internet is stable.

➤ **To update the VCI firmware via tablet**

1. Power on the tablet.
2. Connect the VCI device to the tablet via Bluetooth.
3. Tap the **VCI Manager** application on the MaxiSys Job Menu of the tablet.
4. Select **VCI Update** from the Connection Mode list on the left column.
5. The current version and the latest version of the VCI firmware will be displayed after a few seconds. Tap **Update Now** to update the VCI firmware if available.

8.3.2 Update via PC

➤ **To update the VCI firmware via PC**

1. Download the **Maxi PC Suite** software from www.autel.com > **Support** > **Downloads** > **Autel Update Tools**, and install it onto your PC.
2. Connect the VCI device to the PC via Bluetooth.
3. Launch the **Maxi PC Suite** after installation and click the VCI device icon in the Device Selection window.
4. The PC will automatically recognize the VCI device.
5. Click **Update** to complete the update if an update is available.

8.4 BAS Update

Before updating the battery tester firmware, please make sure the network connection is stable.

➤ **To update the battery tester's firmware**

1. Power on the diagnostic tablet and the battery tester.
2. Connect the battery tester to the tablet via Bluetooth.
3. Tap the **VCI Manager** application on the MaxiSys Job Menu of the tablet.
4. Select **BAS Update** from the Connection Mode list on the left column.
5. The current version and the latest version of the battery tester's firmware will be displayed after a few seconds. Tap **Update Now** to update the battery tester's firmware if available.

 **NOTE**

Do not leave the BAS Update page during upgrade.

9 Support

This application launches the Support platform which synchronizes Autel's online service base station with the MaxiSys tablet. Connected to Autel's service channel and online communities, the Support application provides the quickest way for problem solutions, allowing you to send help requests to obtain direct service and support.

9.1 Support Screen Layout

The Support application interface is navigated by the Home button on the top toolbar. And the main section of the Support screen is divided into two sections. The narrow column on the left is the main menu; select one subject from the main menu to display the corresponding function screen on the right.

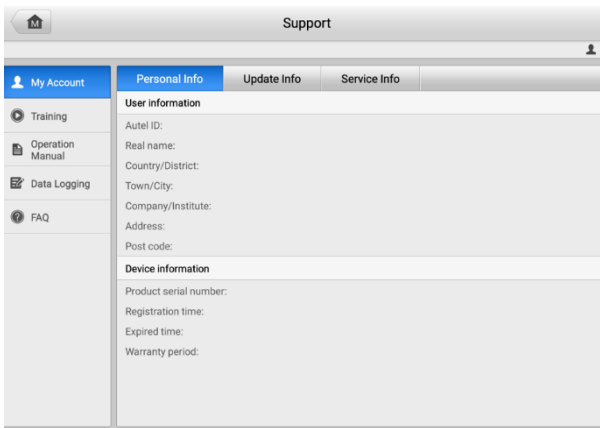

Figure 9-1 Support Application Screen

9.2 My Account

The My Account screen displays the comprehensive information of the user and the product, which is synchronized with the online registered account, including Personal Information, Update Information, and Service Information.

9.2.1 Personal Information

The User Information and Device Information are both included under the Personal Information section.

- User Information — displays detailed information of your registered online Autel account, such as your Autel ID, name, address, and other contact information.
- Device Information — displays the registered product information, including the product serial number, registration time, expired time, and warranty period.

9.2.2 Update Information

The Update Information section displays a detailed list of the product's software update history, including the product serial number, software version or name, and the update time.

9.2.3 Service Information

The Service Information section displays a detailed record list of the device's service history information. Every time the device has been sent back to Autel for repair, the device's serial number and other information, such as the fault type, changed components, or system reinstallation will be recorded and updated to the associated online product account that will be synchronized to the Service Information section.

9.3 Training

The Training section provides quick links to Autel's online video accounts. Select a video channel by language to see all available Autel online tutorial videos on such topics as product usage techniques and vehicle diagnostics practices.

9.4 Operation Manual

The Operation Manual section illustrates the Uni-4 cable and various forms of WABCO ECUs in schematic form, providing users with necessary basic information.

9.5 Data Logging

The Data Logging section keeps records of all **Feedback** (submitted), **No feedback** (not submitted but saved) or **History** (up to the latest 20 test records) data loggings on the diagnostic system. The support personnel will receive and process the submitted reports through the Support platform. The solution will be sent back as soon as possible. You may continue to correspond with the Support platform until the issue is resolved.

➤ To make a reply in a Data Logging session

1. Tap on the **Feedback** tag to view the list of submitted data loggings.
2. Select a specific item to view the latest update of the processing progress.

3. Tap on the input field on the bottom of the screen and enter your reply, or tap the **Audio** button to record a voice message, or tap the **Camera** button to take a screenshot.
4. Tap **Send** to deliver your message to Autel Support.

9.6 FAQ

The FAQ section provides comprehensive references for all questions frequently asked and answered about the use of Autel's online member account and shopping and payment procedures.

- Account — displays questions and answers about the use of Autel's online user account.
- Shopping — displays questions and answers about online product purchase methods or procedures.
- Payment — displays questions and answers about online product payment methods or procedures.

10 Remote Desktop

The Remote Desktop application launches the TeamViewer Quick Support program, which is a simple, fast and secure remote-control interface. You can use the application to receive ad-hoc remote support from Autel's support center, colleagues, or friends, by allowing them to control your MaxiSys tablet on their PC via the TeamViewer software.

10.1 Operations

If you think of a TeamViewer connection as a phone call, the TeamViewer ID would be the phone number under which all TeamViewer Clients can be reached separately. Computers and mobile devices that run TeamViewer are identified by a globally unique ID. The first time the Remote Desktop application is started, this ID is generated automatically based on the hardware characteristics and will not change.

Make sure the tablet is connected to the Internet before launching the Remote Desktop application, so that the tablet is able to receive remote support from the third party.

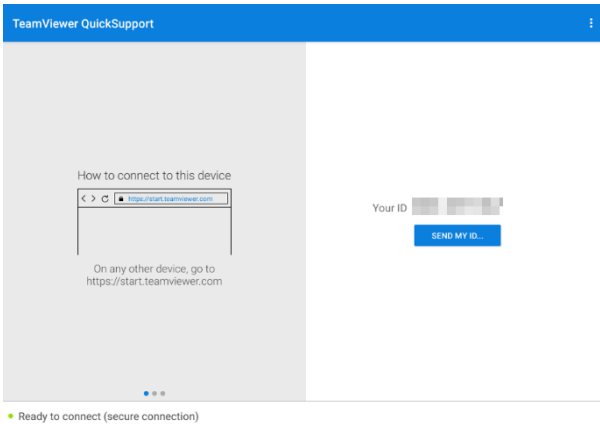

Figure 10-1 Remote Desktop Screen

- **To receive remote support from a partner**
 1. Power on the tablet.
 2. Tap the **Remote Desktop** application on the MaxiSys Job Menu. The TeamViewer interface displays and the device ID is generated and shown.
 3. Your partner must install the Remote Control software to his/her computer by downloading the TeamViewer full version program online (<http://www.teamviewer.com>), and then launch the software.

4. Provide your ID to the partner, and wait for him/her to send you a remote-control request.
5. A message will appear asking for your confirmation to allow remote-control on your device.
6. Tap **Allow** to accept, or tap **Deny** to reject.

Refer to the associated TeamViewer documents for additional information.

11 Update



The Update application on the tablet downloads the latest version of the software. The updates improve the MaxiSys applications' capabilities, typically by adding new tests, new model coverage or by adding new or enhanced applications.

The tablet automatically searches for available updates for all of the MaxiSys software when it is connected to the Internet. Any updates that are found can be downloaded and installed on the device. This section describes update procedures in the MaxiSys system.

NOTE

Ensure the tablet is registered before utilizing the Update application. See [Autel User Center](#) for a comprehensive registration guide.

➤ To update the software

1. Power up the tablet, and ensure that it is connected to a power source and has a steady Internet connection.
2. Tap the **Update** application button from the MaxiSys Job Menu. The Update application screen displays.
3. On the Update screen, tap the **Get** button to update the specific item(s) or tap the **Update All** button to update all available items.
4. Tap **More** to view the details of all the available updates. You can also tap the **Get** or **Update All** button for update.
5. During the update, tap the  icon to suspend the updating process. Tap the  icon to resume the update and the process will continue from the pause point.
6. When the updating process is completed, the software will be installed automatically. The new version will replace the older version.

NOTE

For the account management, proceed to the Member Center tab.

12 Quick Link

The Quick Link application provides you with convenient access to Autel's official website and many other well-known sites in automotive service industry to provide technical help, knowledge bases, forums, and training and expertise consultations.

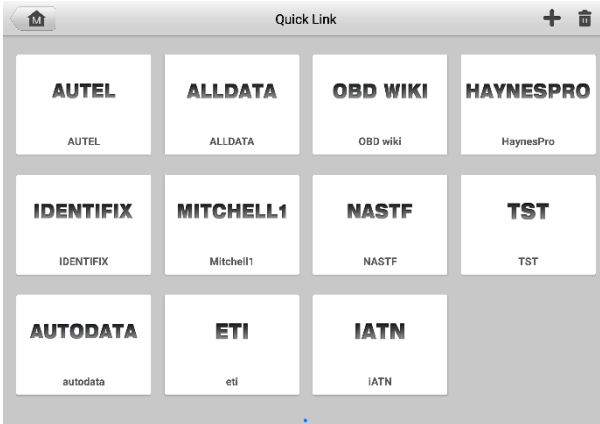

Figure 12-1 Quick Link Screen

- **To open a quick link**
 1. Tap **Quick Link** on the MaxiSys Job Menu. The Quick Link application screen displays.
 2. Select a website thumbnail from the main section. The Chrome browser is launched and the selected website is opened.
- **To manage the quick links**
 1. Tap **Quick Link** on the MaxiSys Job Menu. The Quick Link application screen displays.
 2. Tap the **+** icon on the upper-right corner to add websites. Tap the **🗑** icon to delete websites.

13 User Feedback

The User Feedback application allows you to submit questions related to this product.

➤ **To send user feedback**

1. Tap **User Feedback** on the MaxiSys Job Menu. The device information is automatically synchronized.

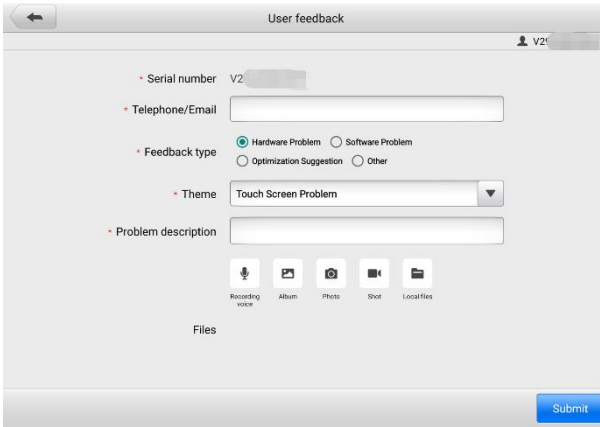

Figure 13-1 User Feedback Screen

2. Set **Telephone/Email**, **Feedback type**, **Theme**, and **Problem description**. You can also attach voice recordings, photos, screenshots, images or PDF files. To resolve your issue more efficiently, we recommend you to complete the information as many details as possible.
3. Tap **Submit** to send the completed information to Autel's online service center. The submitted feedback will be carefully read and handled by our service personnel.

14 MaxiViewer

The MaxiViewer application allows you to search the functions supported by our tools and the version information. There are two ways for searching, either by searching the tool and the vehicle or searching the functions.

➤ **To search by the vehicle**

1. Tap the **MaxiViewer** application on the MaxiSys Job Menu. The MaxiViewer application screen displays.
2. Tap the tool name on the top-left corner to drop down the tool list. Tap the one you want to search.
3. Tap the vehicle brand, model, and year you want to search.
4. All the functions supported by the selected tool for the selected vehicle display as several columns.

➤ **To search by the functions**

1. Tap the **MaxiViewer** application on the MaxiSys Job Menu. The MaxiViewer application screen displays.
2. Tap the tool name on the top-left corner to drop down the tool list. Tap the one you want to search.
3. Enter the function you want to search in the top-right search box. The screen will display all vehicles that support this function, along with information such as the vehicles' year, system, function, sub-function, and version.

 **NOTE**

Fuzzy search is supported. Type in some part of the function-related keywords to find all the available information.

15 MaxiVideo

The MaxiVideo application configures the MaxiSys tablet to operate as a digital video scope by simply connecting the tablet to a MaxiVideo Digital Inspection Camera. This function allows you to examine difficult-to-reach areas normally hidden from sight, with the ability to record digital still images and videos, which offers you an economical solution to inspect machinery, facilities, and infrastructure in a safe and quick way.

 **NOTE**

1. The MaxiVideo Digital Inspection Camera and its fittings are additional accessories, and need to be purchased separately. Both sizes (8.5 mm and 5.5 mm) of the imager head are optional and available for purchase.
 2. This function is compatible with the MaxiVideo Digital Inspection Camera in models MV105S, MV108S, MV105, and MV108.
 3. Connect the tablet with MaxiVideo Digital Inspection Camera using the USB cable. For detailed operation instructions, please refer to the Quick Reference Guide for the MaxiVideo Digital Inspection Camera.
-

16 MaxiScope

The MaxiScope application configures the MaxiSys tablet to operate as an automotive oscilloscope when working in combination with the MaxiScope module. This function provides all the features needed for performing electrical and electronic circuit tests as well as monitoring signal activities on any modern vehicles, which shows you what is really going on with a vehicle's electrical system.

For details about the MaxiScope function, see www.autel.com > **Products** > **Specialty Tools** > **MaxiScope MP408** > Downloads.

17 Battery Test

The Battery Test application allows the user to perform in-vehicle battery test and out-vehicle battery test functions when the BT506 battery tester is connected to the MaxiSys tablet and a battery. The BT506 battery tester enables technicians to view the health status of the vehicle's battery and electrical system.

NOTE

The BT506 battery tester needs to be purchased separately.

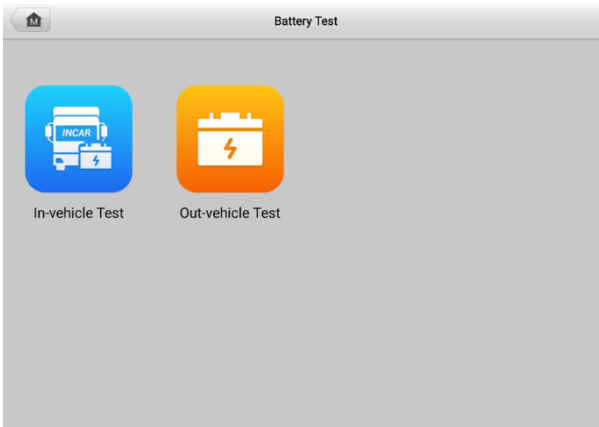

Figure 17-1 Battery Test Screen

17.1 MaxiBAS BT506 Battery Tester

17.1.1 Function Description

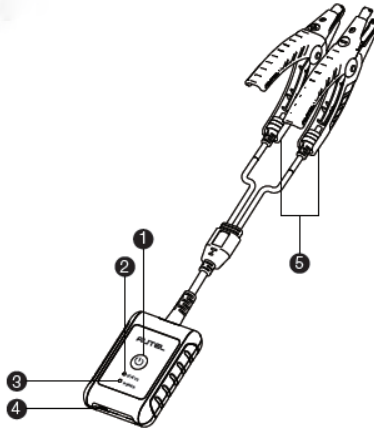

Figure 17-2 MaxiBAS BT506 Tester

1. Power Button
2. Status LED
3. Power LED
4. USB Port
5. Battery Clamp Cable

Table 17-1 LED Description

LED	Color	Description
Status LED	Flashing Green	The tester is communicating via USB cable.
	Flashing Blue	The tester is communicating via Bluetooth.
	Flashing Red	Battery clamps are connected to the wrong battery terminals.

LED	Color	Description
Power LED	Solid Green	The tester is powered on and the battery is sufficiently charged.
	Flashing Green	The tester is charging. (Turns solid green when battery is fully charged.)
	Solid Red	The device is in boot mode.
	Flashing Red	The battery level is low. Please charge.

17.1.2 Power Sources

The MaxiBAS BT506 tester can receive power from the following sources:

- Internal Battery Pack
- AC/DC Power Supply

ⓘ IMPORTANT

Do not charge the tester when the temperature is below 0 °C (32 °F) or above 45 °C (113 °F).

17.1.2.1 Internal Battery Pack

The MaxiBAS BT506 battery tester can be powered with the internal rechargeable battery.

17.1.2.2 AC/DC Power Supply — Using Power Adapter

The MaxiBAS BT506 battery tester can be powered from an electrical outlet using the AC/DC power adapter. The AC/DC power supply also charges the internal battery pack.

17.2 Technical Specifications

Table 17-2 Technical specifications

Item	Description
Connectivity	<ul style="list-style-type: none"> ● USB 2.0, Type C ● Bluetooth 4.2
Input Voltage	5 V DC
Working Current	< 150 mA at 12 V DC
Internal Battery	3.7 V/800 mAh Lithium-ion Polymer battery

Item	Description
CCA Range	100 to 2000 A
Voltage Range	1.5 to 16 V
Working Temp.	- 10 °C to 50 °C (14 °F to 122 °F)
Storage Temp.	- 20 °C to 60 °C (- 4 °F to 140 °F)
Dimension (L x W x H)	107 mm (4.21") x 75 mm (2.95") x 26 mm (1.02") (clamp cable not included)
Weight	320 g (0.7 lbs.)

17.3 Test Preparation

17.3.1 Inspect the Battery

Before starting a test, inspect the battery for:

- Cracking, buckling or leaking. If you see any of these defects, replace the battery.
- Corroded, loosen or damaged cables and connections. Repair or replace as needed.
- Corrosion on the battery terminals, and dirt or acid on the case top. Clean the case and terminals using a wire brush and a mixture of water and baking soda.

17.3.2 Connect the Battery Tester

➤ **To pair with the MaxiSys tablet**

1. Turn on both the MaxiSys tablet and the BT506 battery tester. Ensure that the units are sufficiently charged before you begin.
2. Enable Bluetooth on the tablet by tapping **VCI Manager > BAS BT**. Tap **Scan** at the top-right corner. The device will start to search for available pairing units.
3. Depending on the type of battery tester, the device name may display as "Maxi" suffixed with a serial number. Select the appropriate device for pairing.
4. When paired successfully, the connection status will read "Connected."

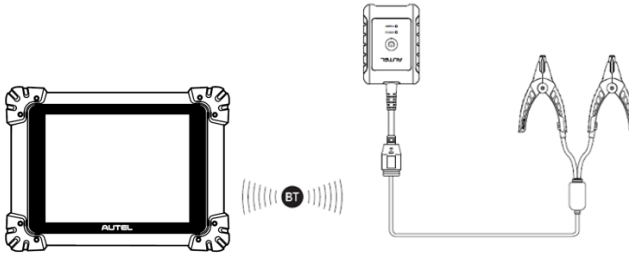

Figure 17-3 Battery Tester Connection Example 1

➤ **To connect to a battery**

1. Connect the red clamp to the positive (+) terminal of the battery.
2. Connect the black clamp to the negative (-) terminal of the battery.

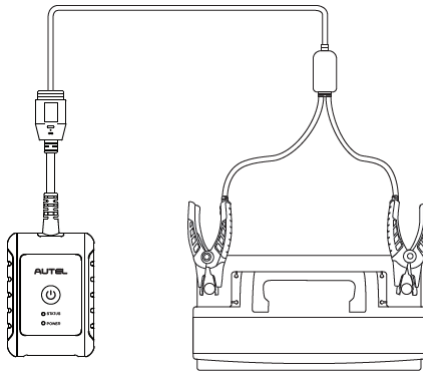

Figure 17-4 Battery Tester Connection Example 2

17.4 In-vehicle Test

The In-vehicle Test is used for testing batteries that are installed in a vehicle. An in-vehicle test includes the Battery Test, Starter Test, and Generator Test. These tests help determine the health of the battery, the starter, and the generator.

! IMPORTANT

A disclaimer will appear when first accessing any function on the Home screen. Please read the end-user agreement and tap **Accept** to continue. If you tap **Decline**, you will not be able to use the features properly.

Prior to testing any battery, ensure that the battery tester is paired with the tablet via Bluetooth and connected properly to a battery.

➤ **To start the in-vehicle test**

1. Tap **Battery Test** on the MaxiSys Job Menu. Select **In-vehicle Test**.
2. Confirm the vehicle information on the left side of the screen. Make sure the VIN is entered.
3. Confirm your battery information, including voltage, type, standard, and capacity. Tap **Next** to continue in-vehicle test functions.

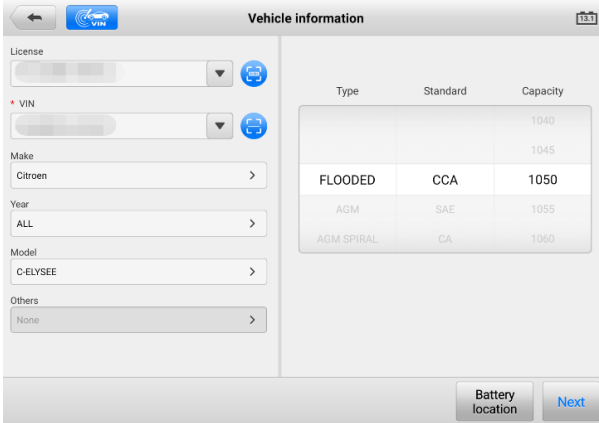



Figure 17-5 Battery information Screen



NOTE

In the Settings application, the Battery Test option allows you to change the requirement for entering the VIN information. If the setting is enabled, supplying the VIN is no longer mandatory.

Please refer to the table below for a list of buttons that may appear when accessing the functions:

Table 17-3 Top Toolbar Buttons

Button	Name	Description
	Battery Connection	The value on the icon indicates the real-time voltage of the tested battery. In the battery test, the button will turn green if the battery is good; otherwise, it will turn red.
	Next	Tap to proceed.

Button	Name	Description
	Home	Returns to the battery test main screen.
	Back	Returns to the previous screen.
	Exit	Returns to the Job Menu.

17.4.1 Battery Test

1. Follow the on-screen instructions. Check the boxes once all required tasks are completed, and tap **Start Testing**.

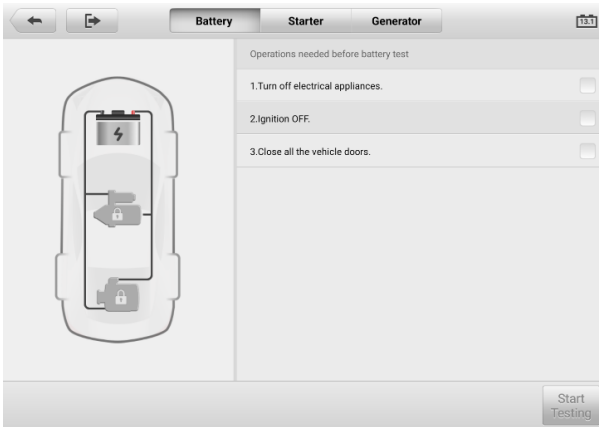

Figure 17-6 Battery Screen

2. Wait until the test is completed. The test results will be displayed on the tool.

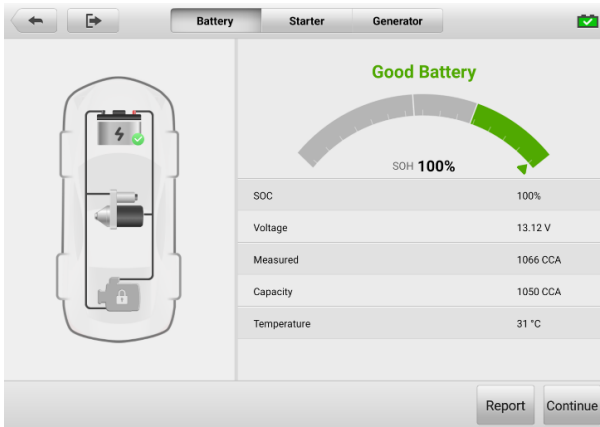

Figure 17-7 Battery Test Results Screen

Table 17-4 Test Results

Result	Description
Good Battery	Battery is good.
Good & Recharge	Battery is good but insufficiently charged. Recharge the battery.
Charge & Retest	Battery requires charge to determine its condition.
Bad Cell	Replace the battery.
Replace Battery	Replace the battery.

NOTE

Please always complete the battery test before you proceed to the starter and generator tests.

17.4.2 Starter Test

Follow the on-screen instructions to complete the test. Start the engine and let it idle. The test results will appear as follows:

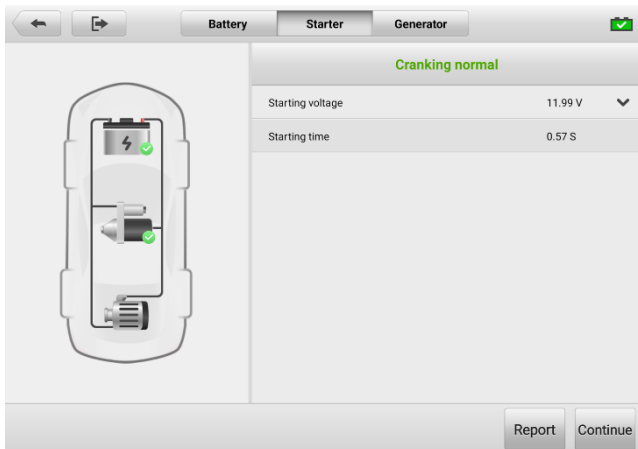

Figure 17-8 Starter Test Result Screen

Table 17-5 Starter Test Results

Result	Description
Cranking Normal	The starter is good.
Current Too Low	Low momentary discharge capacity.
Voltage Too Low	Low battery storage capacity.
Not Started	The starter is not detected for starting.

17.4.3 Generator Test

Follow the on-screen instructions to complete the test. The test results will appear as follows:

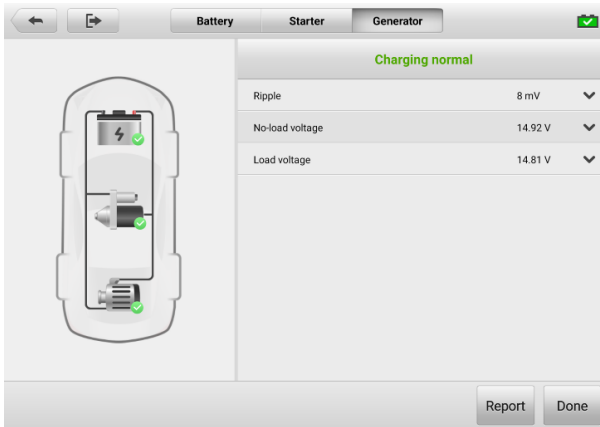

Figure 17-9 Generator Test Results Screen

Table 17-6 Generator Test Results

Result	Description
Charging Normal	The generator is functioning normally.
Output Too Low	<ul style="list-style-type: none"> • The belt linking the starter and the generator is loose; • The cable linking the starter and battery is loose or corroded.
Output Too High	<ul style="list-style-type: none"> • The generator is not properly connected to the ground; • The voltage adjuster is broken and needs replacement.
Ripple Too Large	The commutation diode is broken.
No Output	<ul style="list-style-type: none"> • The cable is loose; • Some vehicles with power management systems do not provide path for charging due to the sufficient load capacity of the battery; • The generator or the voltage adjuster is broken and needs replacement.

17.5 Out-vehicle Test

Out-vehicle Test is used to test the condition of batteries that are not connected to a vehicle. This function aims to check the health status of the battery only.

17.5.1 Test Procedure

➤ **To start the out-vehicle test**

1. Connect the tester clamps to the battery terminals.
2. Tap **Battery Test** on the MaxiSys Job Menu. Select **Out-vehicle Test**.
3. Select the appropriate battery type, rating standard, and CCA value. Tap **Start Testing** to start the test.

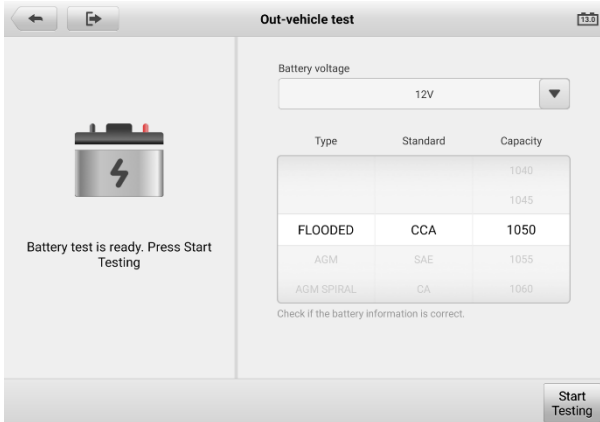

Figure 17-10 Out-vehicle Test Screen

4. The test results will display in a few seconds.

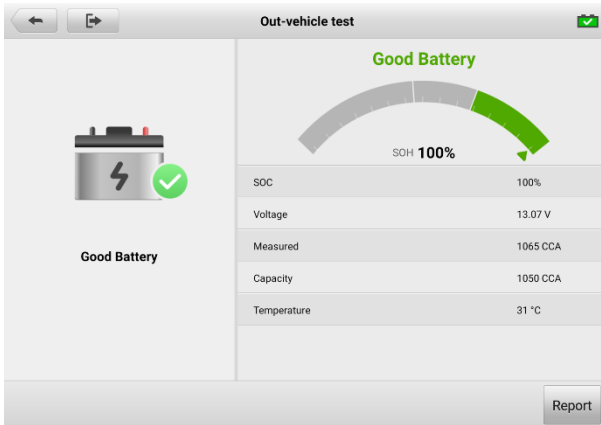

Figure 17-11 Out-vehicle Test Results Screen

17.5.2 Test Results

Table 17-7 Out-Vehicle Test Results

Result	Description
Good Battery	Battery meets required standards.
Good & Recharge	Battery is good, but low on charge. Fully charge the battery. Check for causes of low charge.
Charge & Retest	Battery requires charge to determine its condition.
Replace Battery	Battery fails to meet industry-accepted standards.
Bad Cell	Battery fails to meet industry-accepted standards.

18 Autel User Center

Software updates are available for free for the first year from the date of purchase. The Autel User Center application allows you to register your tool to download the latest released software, thereby enhancing the functionality of the MaxiSys application by adding new vehicle models or enhanced applications to the database.

There are two ways for product registration:

A. Via the MaxiSys tablet

➤ To log in with your account and register your Autel tool

1. Tap **Autel User Center** from the MaxiSys Job Menu. The following screen displays.

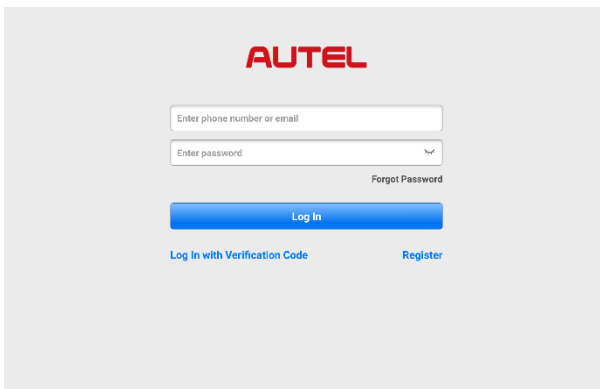

Figure 18-1 Autel User Center Screen

2. If you already have an Autel ID, you can log in with your phone number and verification code, or tap **Log In with Password** to log in with your Autel ID and password. If you don't have an Autel ID yet, tap **Register** to create an Autel ID.
3. Once your account is successfully registered, you will enter the main menu of the Autel User Center.
4. Select **Device Management** on the main menu.

5. Tap the **Link Device** button on the upper-right corner of the Device Management screen. The serial number and password of the device will automatically appear on the Link Device screen.
6. Tap the **Link** button to complete the product registration.

B. Via the Autel website

➤ **To register your Autel tool**

1. Visit the website: pro.autel.com.
2. If you have an Autel account, sign in with your account ID and password and skip to step 7.
3. If you are a new member to Autel, click the **Register** button to create your Autel ID.
4. Enter the required personal information in the input fields.
5. Enter your email address, then click **Request**. You will receive an email from Autel with your verification code. Open the email and copy the code into the proper input box.
6. Set a password for your account, and enter the password again to confirm. Read the **Autel User Service Agreement** and **Autel Privacy Policy**, then check the box to accept the terms. After all the information is entered, click **Register**. A Product Registration screen will appear.
7. Your product serial number and password are required to complete your registration. To find your serial number and password on the tool: go to **Settings > About**.
8. Enter your tool's serial number and password on the Product Registration screen. Enter the CAPTCHA code and click **Submit** to complete your registration procedure.

19 Maintenance and Service

To ensure that the tablet and the combined VCI unit perform at their optimum level, we advise that the product maintenance instructions covered in this section are strictly followed.

19.1 Maintenance Instructions

The following includes how to maintain your devices, together with precautions to take.

- Use a soft cloth and alcohol or a mild window cleaner to clean the touchscreen of the tablet.
- Do not use any abrasive cleansers, detergent, or automotive chemicals to the tablet.
- Keep the devices in dry conditions and within specified operating temperatures.
- Dry your hands before using the tablet. The touch screen of the tablet may not work if the touch screen is moist, or if you tap the touch screen with wet hands.
- Do not store the devices in humid, dusty or dirty areas.
- Check the housing, wiring, and connectors for dirt and damage before and after each use.
- Check the housing, wiring, and connectors for dirt and damage before and after each use.
- Do not attempt to disassemble your tablet or the VCI unit.
- Do not drop or cause severe impact to the devices.
- Use only authorized battery chargers and accessories. Any malfunction or damage caused by the use of unauthorized battery charger and accessories will void the limited product warranty.
- Ensure that the battery charger does not come in contact with conductive objects.
- Do not use the tablet beside microwave ovens, cordless phones and some medical or scientific instruments to prevent signal interference.

19.2 Troubleshooting Checklist

- A. When the tablet does not work properly:
- Make sure the tablet has been registered online.
 - Make sure the system software and diagnostic application software are properly updated.
 - Make sure the tablet is connected to the Internet.
 - Check all cables, connections, and indicators to see if the signal is being received.
- B. When battery life is shorter than usual:
- This may happen when you are in an area with low signal strength. Turn off your device if is not in use.
- C. When you cannot turn on the tablet:
- Make sure the tablet is connected to a power source or the battery is charged.
- D. When you are unable to charge the tablet:
- Your charger maybe out of order. Contact your nearest dealer.
 - You may be attempting to use the device in an overly hot/cold temperature. Charge the device in a cooler or warmer area.
 - Your device may have not been connected to the charger properly. Check the connector.

NOTE

If the problems persist, please contact Autel's technical support personnel or your local selling agent.

19.3 About Battery Usage

Your tablet is powered by a built-in lithium-ion polymer battery, which enables you to recharge your battery when there is electricity left.

DANGER

The built-in Lithium-ion Polymer battery is factory replaceable only; incorrect replacement or tampering with the battery pack may cause an explosion.

- Do not use a damaged battery charger.
- Do not disassemble, open, crush, bend, deform, puncture, or shred the battery.
- Do not modify, remanufacture or attempt to insert foreign objects into the battery, or expose the battery to fire, explosion, or other hazards.
- Only use the specified charger and USB cables. Use of non-Autel-authorized charger or USB cables may lead to device malfunction or failure.
- Use of an unqualified battery or charger may present a risk of fire, explosion, leakage, or other hazards.
- Avoid dropping the tablet. If the tablet is dropped, especially on a hard surface, and you suspect damage, take the tablet to a service center for inspection.
- Try to keep closer to your wireless router to reduce battery usage.
- The time needed to recharge the battery varies depending on the remaining battery capacity.
- Battery life inevitably shortens over time.
- Unplug the charger once the tablet is fully charged since overcharging may shorten battery life.
- Keep the battery in temperate environments. Do not place it inside a car when it is too hot or too cold, which may reduce the capacity and life of the battery.

19.4 Service Procedures

This section provides information on technical support, repair service, and application for replacement or optional parts.

19.4.1 Technical Support

If you have any question or problem on the operation of the product, please contact us.

Autel China Headquarters

- **Phone:** +86 (0755) 8614-7779 (Monday-Friday, 9AM-6PM Beijing Time)
- **Email:** support@autel.com
- **Address:** Floor 2, Caihong Keji Building, 36 Hi-tech North Six Road, Songpingshan Community, Xili Sub-district, Nanshan District, Shenzhen City, China
- **Web:** www.autel.com

Autel North America

- **Phone:** 1-855-288-3587 (Monday-Friday, 9AM-6PM Eastern Time)
- **Email:** ussupport@autel.com
- **Address:** 36 Harbor Park Drive, Port Washington, New York, USA 11050
- **Web:** www.autel.com/us

Autel Europe

- **Phone:** +49(0)89 540299608 (Monday-Friday, 9AM-6PM Berlin Time)
- **Email:** support.eu@autel.com
- **Address:** Landsberger Str. 408, 81241 München, Germany
- **Web:** www.autel.eu

Autel APAC

Japan:

- **Phone:** +81-045-548-6282
- **Email:** support.jp@autel.com
- **Address:** 6th Floor, Ari-nadoribiru 3-7-7, Shinyokohama, Kohoku-ku, Yokohama-shi, Kanagawa-ken, 222-0033 Japan
- **Web:** www.autel.com/jp

Australia:

- **Email:** ausupport@autel.com
- **Address:** Unit 5, 25 Veronica Street, Capalaba

Autel IMEA

- **Phone:** +971 585 002709 (in UAE)
- **Email:** imea-support@autel.com
- **Address:** 906-17, Preatoni Tower (Cluster L), Jumeirah Lakes Tower, DMCC, Dubai, UAE
- **Web:** www.autel.com

Autel Latin America

Mexico:

- **Phone:** +52 33 1001 7880 (Spanish in Mexico)
- **Email:** latsupport@autel.com

- **Address:** Avenida Americas 1905, 6B, Colonia Aldrete, Guadalajara, Jalisco, Mexico

Brazil:

- **Email:** brsupport@autel.com
- **Address:** Avenida José de Souza Campos n° 900, sala 32 Nova Campinas Campinas – SP, Brazil
- **Web:** www.autel.com/br

19.4.2 Repair Service

If it becomes necessary to return your device for repair, please download the repair service form from www.autel.com, and fill in the form. The following information must be included:

- Contact name
- Return address
- Telephone number
- Product name
- Complete description of the problem
- Proof-of-purchase for warranty repairs
- Preferred method of payment for non-warranty repairs

 **NOTE**

For non-warranty repairs, payment can be made with Visa, Master Card, or with approved credit terms.

Send the device to your local agent, or to the address below:

Floor 2, Caihong Keji Building, 36 Hi-tech North Six Road, Songpingshan Community, Xili Sub-district, Nanshan District, Shenzhen City, China

19.4.3 Other Services

You can purchase the optional accessories directly from Autel's authorized tool suppliers, and/or your local distributor or agent.

Your purchase order should include the following information:

- Contact information
- Product or part name
- Item description
- Purchase quantity

20 Compliance Information

FCC Compliance

FCC ID: WQ8-MS908S2122

This equipment has been tested and found to comply with the limits for a Class B digital device, pursuant to Part 15 of the FCC Rules. These limits are designed to provide reasonable protection against harmful interference in a residential installation. This equipment generates uses and can radiate radio frequency energy and, if not installed and used in accordance with the instructions, may cause harmful interference to radio communications. However, there is no guarantee that interference will not occur in a particular installation. If this equipment does cause harmful interference to radio or television reception, which can be determined by turning the equipment off and on, the user is encouraged to try to correct the interference by one or more of the following measures:

- Reorient or relocate the receiving antenna.
- Increase the separation between the equipment and receiver.
- Consult the dealer or an experienced radio/TV technician for help.

This device complies with part 15 of the FCC Rules. Operation is subject to the following two conditions:

- (1) This device may not cause harmful interference, and
- (2) This device must accept any interference received, including interference that may cause undesired operation.

Changes or modifications not expressly approved by the party responsible for compliance could void the user's authority to operate the equipment.

SAR

The radiated output power of this device is below the FCC radio frequency exposure limits. Nevertheless, the device should be used in such a manner that the potential for human contact is minimized during normal operation.

The exposure standard for wireless devices employs a unit of measurement known as the Specific Absorption Rate, or SAR. The SAR limit set by the FCC is 1.6 W/Kg. Tests for SAR are conducted using standard operating positions accepted by the FCC with the device transmitting at its highest certified power level in all tested frequency bands.

Although the SAR is determined at the highest certified power level, the actual SAR level

of the device while operating can be well below the maximum value. This is because the device is designed to operate at multiple power levels so as to use only the power required to reach the network. To avoid the possibility of exceeding the FCC radio frequency exposure limits, human proximity to antenna should be minimized.

RF WARNING STATEMENT

The device has been evaluated to meet general RF exposure requirement. The device can be used in portable exposure condition without restriction.

RoHS COMPLIANCE

This device is declared to be in compliance with the European RoHS Directive 2011/65/EU.

CE COMPLIANCE

This product is declared to conform to the essential requirements of the following directives and carries the CE mark accordingly:

Radio Equipment Directive 2014/53/EU

21 Warranty

12-Month Limited Warranty

Autel Intelligent Technology Corp., Ltd. (the Company) warrants to the original retail purchaser of this diagnostic tablet that should this product or any part thereof during normal usage and under normal conditions be proven defective in material or workmanship that results in product failure within twelve (12) months period from the date of purchase, such defect(s) will be repaired, or replaced (with new or rebuilt parts) with Proof of Purchase, at the Company's option, without charge for parts or labor directly related to the defect(s).

NOTE

If the warranty period is inconsistent with local laws and regulations, please comply with the relevant local laws and regulations.

The Company shall not be liable for any incidental or consequential damages arising from the use, misuse, or mounting of the device. Some states do not allow limitation on how long an implied warranty lasts, so the above limitations may not apply to you.

This warranty does not apply to:

- a) Products subjected to abnormal use or conditions, accident, mishandling, neglect, unauthorized alteration, misuse, improper installation or repair or improper storage;
- b) Products whose mechanical serial number or electronic serial number has been removed, altered or defaced;
- c) Damage from exposure to excessive temperatures or extreme environmental conditions;
- d) Damage resulting from connection to, or use of any accessory or other product not approved or authorized by the Company;
- e) Defects in appearance, cosmetic, decorative or structural items such as framing and non-operative parts.
- f) Products damaged from external causes such as fire, dirt, sand, battery leakage, blown fuse, theft or improper usage of any electrical source.

! **IMPORTANT**

All contents of the product may be deleted during the process of repair. You should create a back-up copy of any contents of your product before delivering the product for warranty service.

AUTEL[®]