

**Features:**

- n Isolated mounting base 3000V~
- n Solder joint technology with increased power cycling capability
- n Space and weight saving

Typical Applications:

- n Various rectifiers
- n DC supply for PWM inverter

V _{RRM}	Type & Outline
600V	MDC182-06-229H3
800V	MDC182-08-229H3
1000V	MDC182-10-229H3
1200V	MDC182-12-229H3
1400V	MDC182-14-229H3
1600V	MDC182-16-229H3
1800V	MDC182-18-229H3

SYMBOL	CHARACTERISTIC	TEST CONDITIONS	T _j (°C)	VALUE			UNIT
				Min	Type	Max	
I _{F(AV)}	Mean forward current	180° half sine wave 50Hz Single side cooled, T _c =100°C	150			182	A
I _{F(RMS)}	RMS forward current		150			286	A
I _{RRM}	Repetitive peak current	at V _{RRM}	150			12	mA
I _{FSM}	Surge forward current	10ms half sine wave V _R =0.6V _{RRM}	150			4	kA
I ² t	I ² t for fusing coordination					84.1	A ² s*10 ³
V _{FO}	Threshold voltage		150			0.83	V
r _F	Forward slope resistance					1.2	mΩ
V _{FM}	Peak forward voltage	I _{FM} =550A	25			1.55	V
R _{th(j-c)}	Thermal resistance Junction to case	Single side cooled per chip				0.19	°C/W
R _{th(c-h)}	Thermal resistance case to heatsink	Single side cooled per chip				0.08	°C/W
V _{iso}	Isolation voltage	50Hz, R.M.S, t=1min, I _{iso} :1mA(max)		3000			V
F _m	Terminal connection torque(M6)			4.5		6	N·m
	Mounting torque(M6)			4.5		6	N·m
T _{vj}	Junction temperature			-40		150	°C
T _{stg}	Stored temperature			-40		125	°C
W _t	Weight				165		g
Outline	229H3						

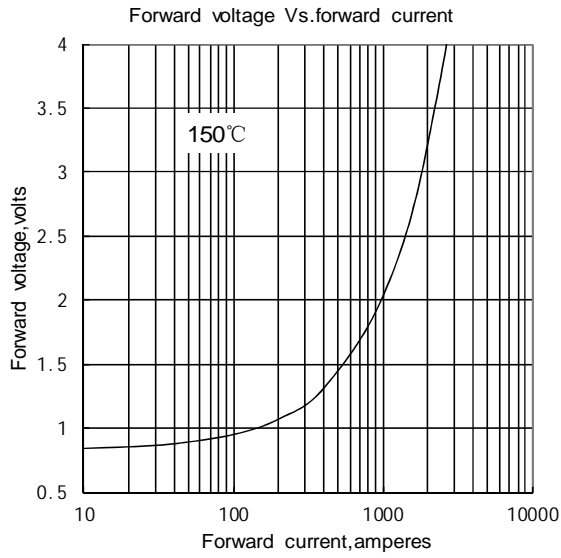

Fig1

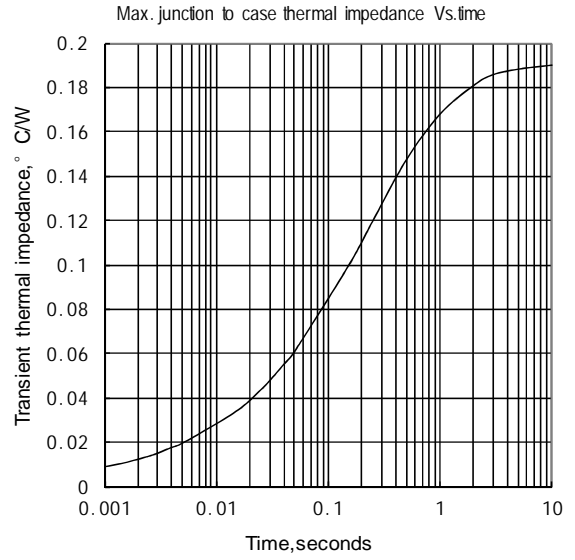

Fig2

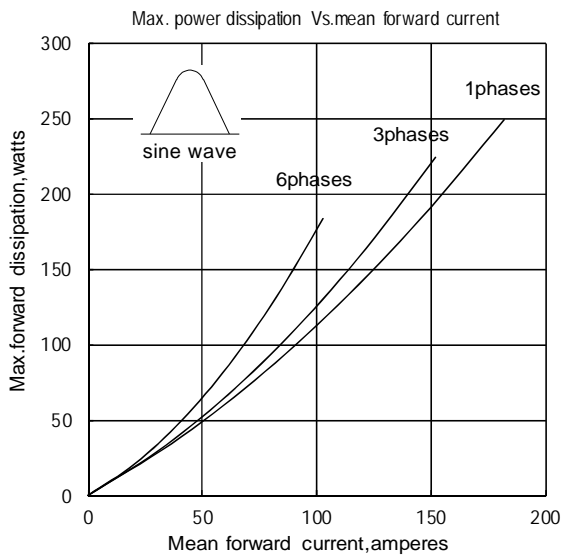

Fig3

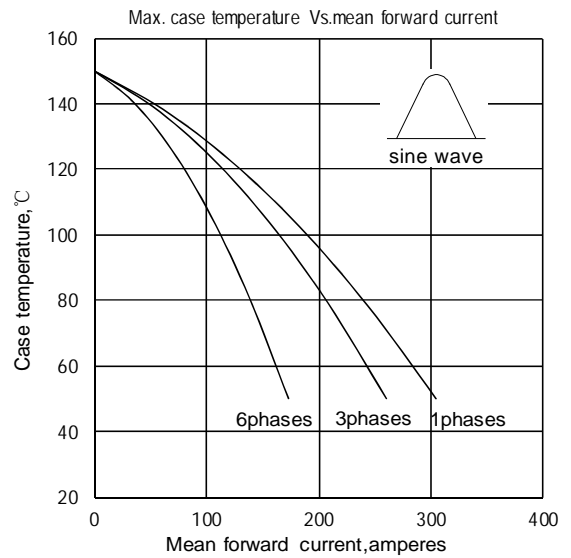

Fig4

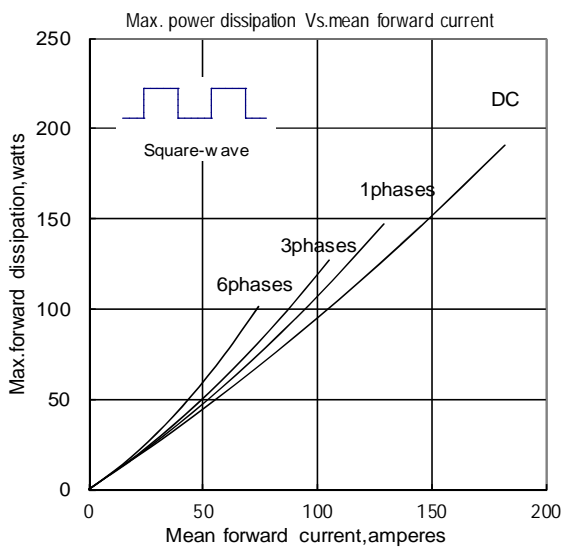

Fig5

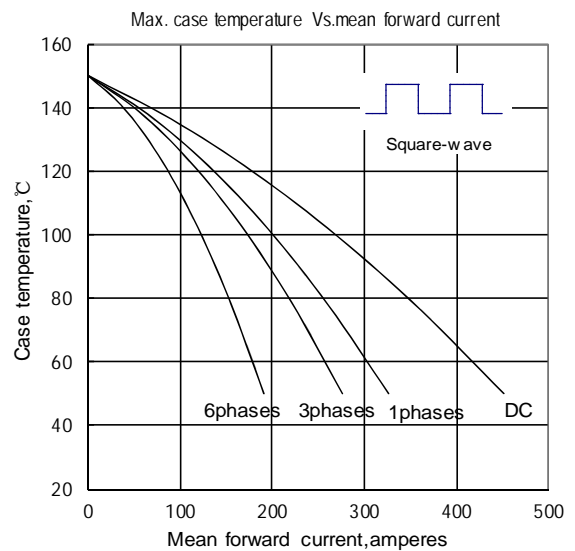

Fig6

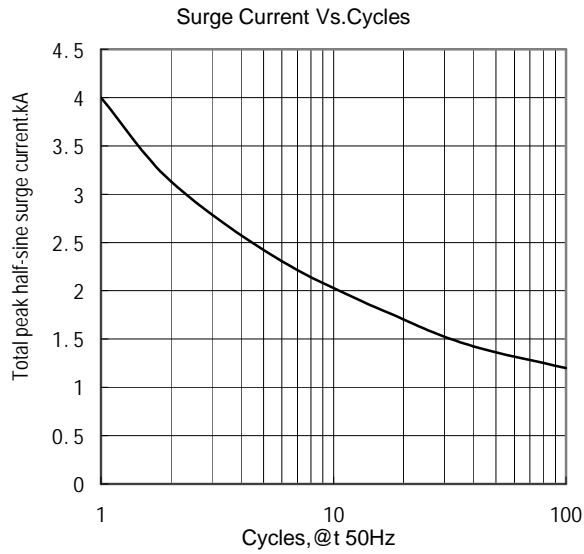

Fig7

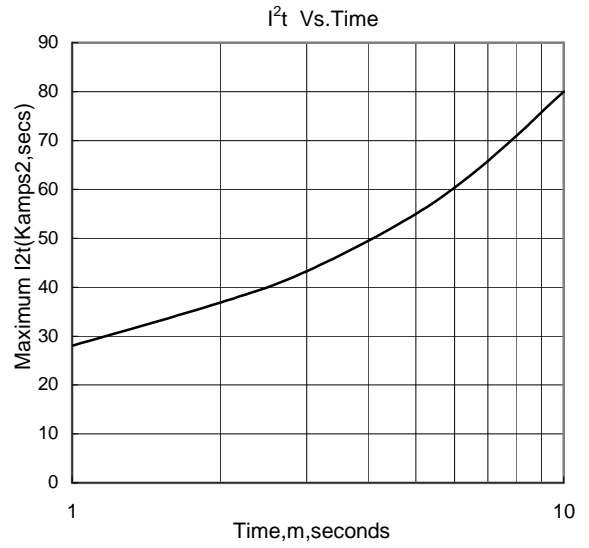
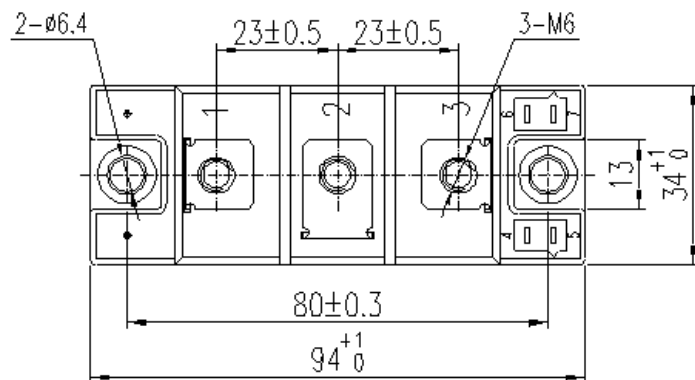
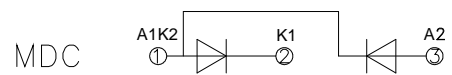
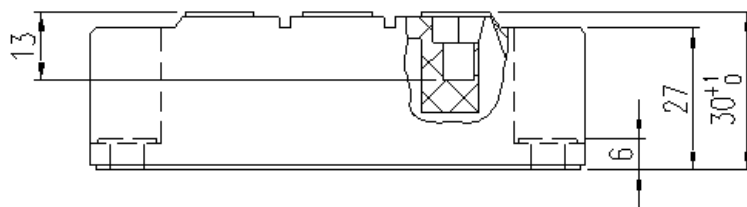

Fig8

Outline:



Unmarked dimensional tolerance: ±0.5mm