

**Features:**

- n Isolated mounting base 3000V~
- n Solder joint technology with increased power cycling capability
- n Space and weight saving

Typical Applications:

- n AC/DC Motor drives
- n Various rectifiers
- n DC supply for PWM inverter

V_{DRM}, V_{RRM}	Type & Outline
600V	MTC26-06-224H3/224H3B
800V	MTC26-08-224H3/224H3B
1000V	MTC26-10-224H3/224H3B
1200V	MTC26-12-224H3/224H3B
1400V	MTC26-14-224H3/224H3B
1600V	MTC26-16-224H3/224H3B
1800V	MTC26-18-224H3/224H3B

SYMBOL	CHARACTERISTIC	TEST CONDITIONS	$T_j(^{\circ}\text{C})$	VALUE			UNIT
				Min	Type	Max	
$I_{T(AV)}$	Mean on-state current	180° half sine wave 50Hz Single side cooled, $T_c = 85^{\circ}\text{C}$	125			26	A
$I_{T(RMS)}$	RMS on-state current		125			41	A
I_{DRM} I_{RRM}	Repetitive peak current	at V_{DRM} at V_{RRM}	125			15	mA
I_{TSM}	Surge on-state current	10ms half sine wave	125			1.6	kA
I^2t	I^2t for fusing coordination	$V_R = 60\% V_{RRM}$				12.8	$10^3 \text{A}^2\text{s}$
V_{TO}	Threshold voltage		125			0.75	V
r_T	On-state slope resistance					7.68	m Ω
V_{TM}	Peak on-state voltage	$I_{TM} = 80\text{A}$	25			1.55	V
dv/dt	Critical rate of rise of off-state voltage	$V_{DM} = 67\% V_{DRM}$	125			1000	V/ μs
di/dt	Critical rate of rise of on-state current	Gate source 1.5A $t_r \leq 0.5\mu\text{s}$ Repetitive	125			200	A/ μs
I_{GT}	Gate trigger current	$V_A = 12\text{V}, I_A = 1\text{A}$	25	30		200	mA
V_{GT}	Gate trigger voltage			0.6		2.5	V
I_H	Holding current			10		250	mA
I_L	Latching current					1000	mA
V_{GD}	Non-trigger gate voltage	$V_{DM} = 67\% V_{DRM}$	125			0.2	V
$R_{th(j-c)}$	Thermal resistance Junction to case	Single side cooled, per chip				0.90	$^{\circ}\text{C}/\text{W}$
$R_{th(c-h)}$	Thermal resistance case to heatsink	Single side cooled, per chip				0.15	$^{\circ}\text{C}/\text{W}$
V_{iso}	Isolation voltage	50Hz, R.M.S, $t = 1\text{min}, I_{iso} : 1\text{mA}(\text{MAX})$		3000			V
F_m	Thermal connection torque(M5)			2.5		4.0	N·m
	Mounting torque(M6)			4.5		6.0	N·m
T_{vj}	Junction temperature			-40		125	$^{\circ}\text{C}$
T_{stg}	Stored temperature			-40		125	$^{\circ}\text{C}$
W_t	Weight				100		g
Outline	224H3、224H3B						

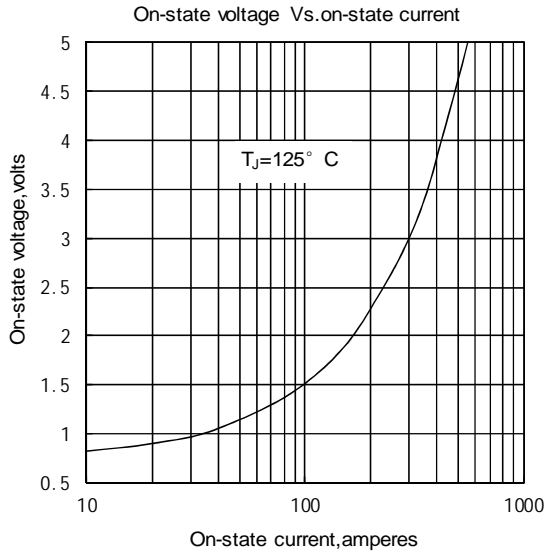

Fig.1

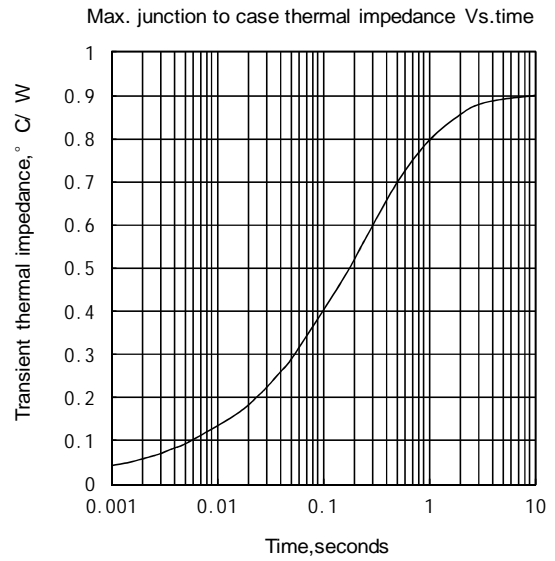

Fig.2

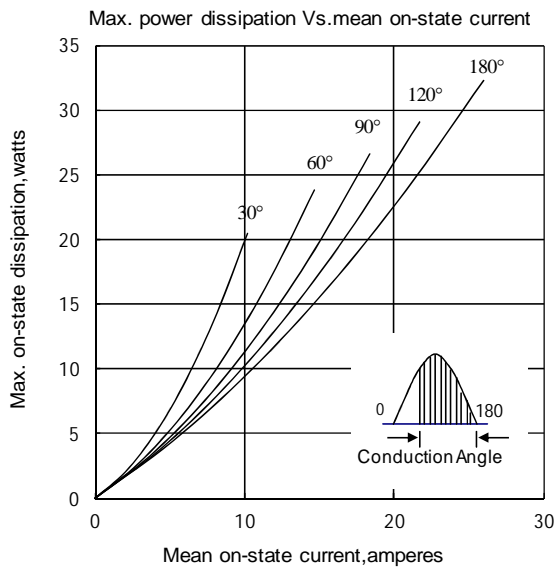

Fig.3

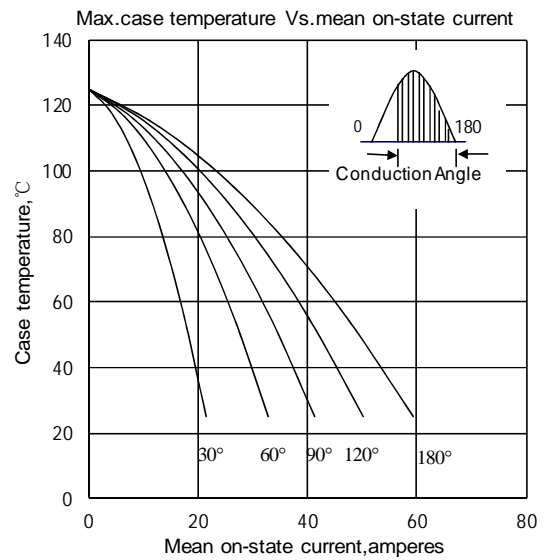

Fig.4

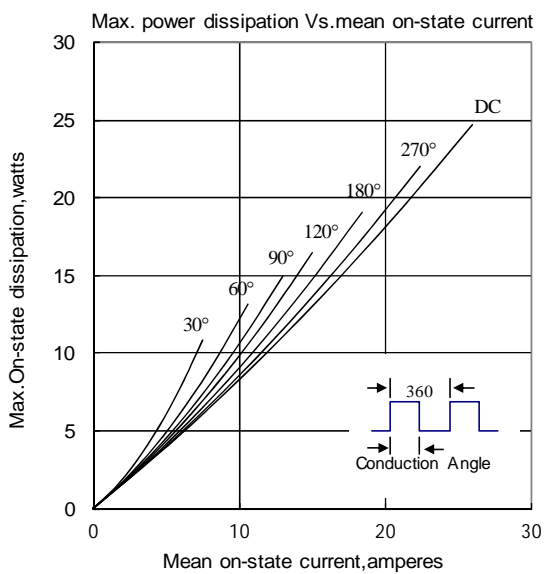

Fig.5

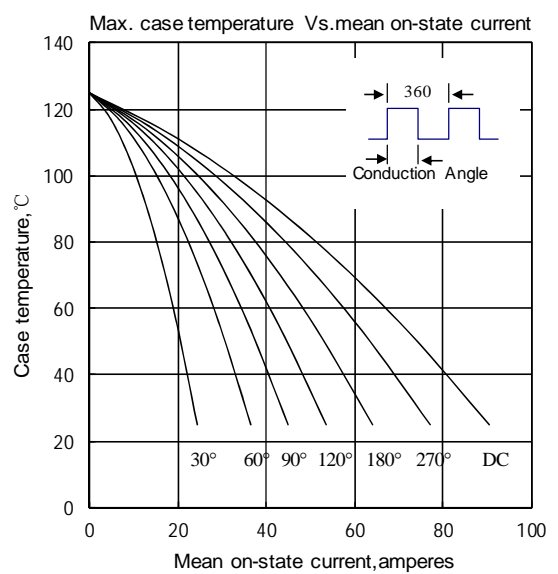

Fig.6

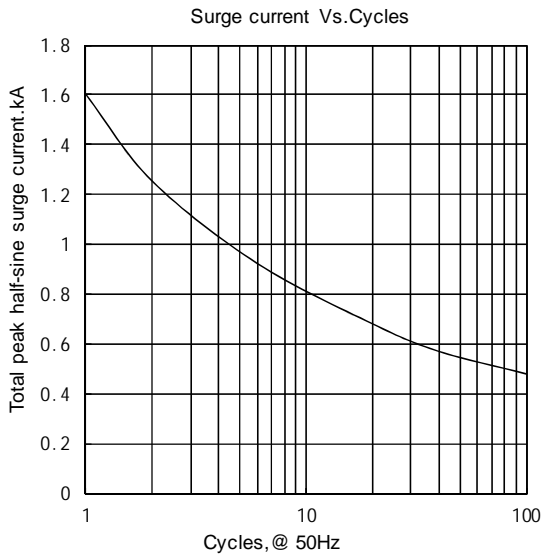

Fig.7

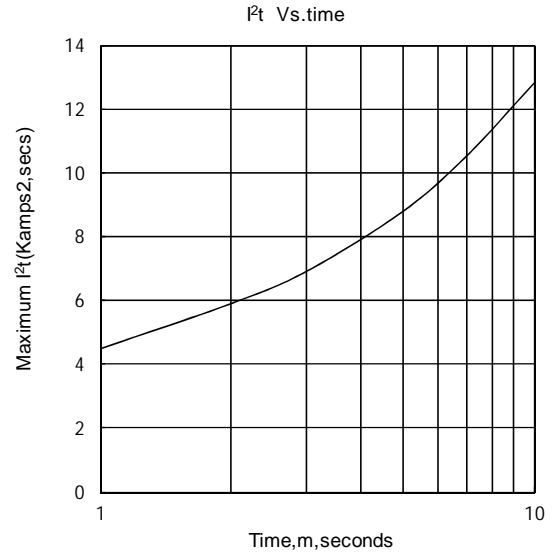

Fig.8

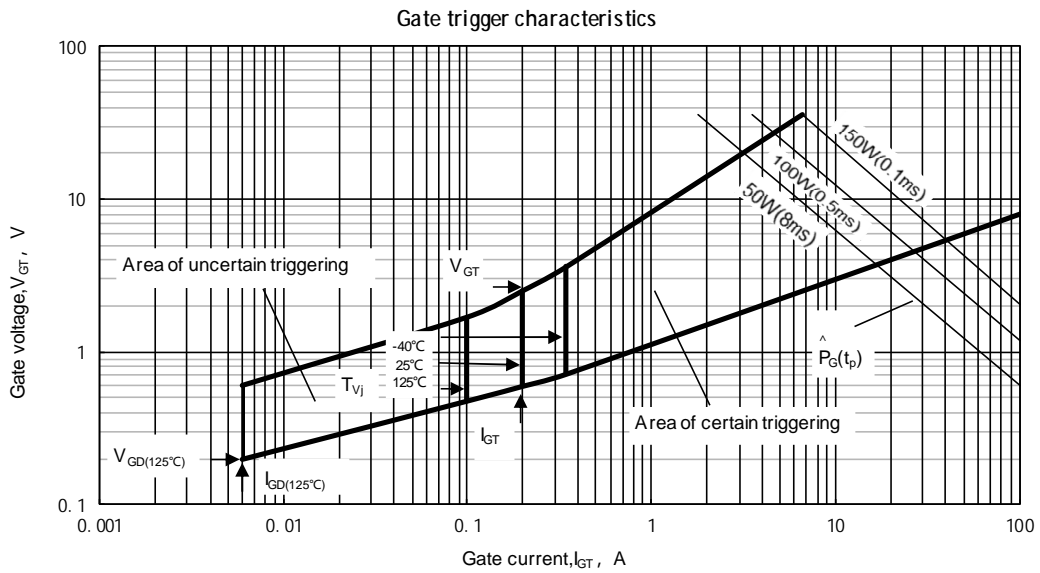
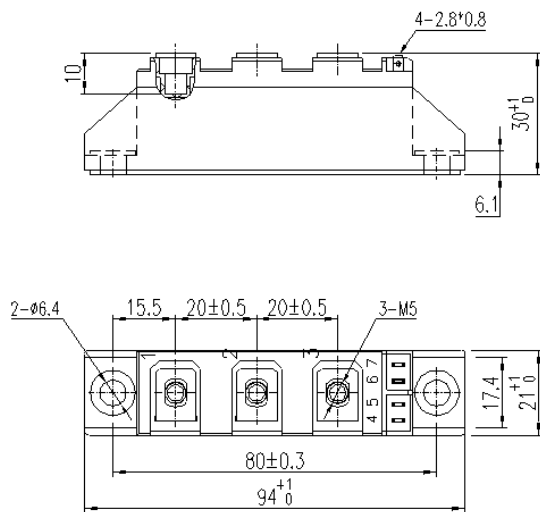

Fig.9

Outline:



Unmarked dimensional tolerance: ±0.5mm

