

**Features**

- n Low forward voltage drop
- n High reverse voltage
- n Hermetic metal cases with ceramic insulators

**Typical Applications**

- n All purpose high power rectifier diodes
- n High power resistance welding equipment
- n Non-controllable and half-controllable rectifiers
- n Controlled rectifiers

<b>Part No. H100ZPR-ZT100cT</b>			
<b>I<sub>F(AV)</sub></b>	<b>4380A</b>		
<b>V<sub>RRM</sub></b>	<b>5200V</b>	<b>5600V</b>	
	<b>6000V</b>	<b>6500V</b>	

SYMBOL	CHARACTERISTIC	TEST CONDITIONS		T <sub>j</sub> (°C)	VALUE			UNIT
					Min	Type	Max	
I <sub>F(AV)</sub>	Mean forward current	180° half sine wave 50Hz Double side cooled,	T <sub>C</sub> =100°C	150			4380	A
V <sub>RRM</sub>	Repetitive peak reverse voltage	tp=10ms		150	5100		6500	V
I <sub>RRM</sub>	Repetitive peak current	at V <sub>RRM</sub>		150			300	mA
I <sub>FSM</sub>	Surge forward current	10ms half sine wave		150			57	kA
I <sup>2</sup> t	I <sup>2</sup> t for fusing coordination	V <sub>R</sub> =0.6V <sub>RRM</sub>						16200
V <sub>FO</sub>	Threshold voltage			150			0.88	V
r <sub>F</sub>	Forward slope resistance							0.16
V <sub>FM</sub>	Peak forward voltage	I <sub>FM</sub> =5000A, F=108kN		25			1.70	V
Q <sub>rr</sub>	Recovery charge	I <sub>FM</sub> =2000A, tp=4000μs, di/dt=-20A/μs, V <sub>R</sub> =100V		150		17000		μC
R <sub>th(j-c)</sub>	Thermal resistance Junction to case	At 180° sine- double side cooled Clamping force 108kN					0.0057	°C /W
R <sub>th(c-h)</sub>	Thermal resistance case to heat sink						0.0015	
F <sub>m</sub>	Mounting force				81		108	kN
T <sub>vj</sub>	Junction temperature				-40		150	°C
T <sub>stg</sub>	Stored temperature				-40		160	°C
W <sub>t</sub>	Weight					2020		g
Outline	ZT100cT							

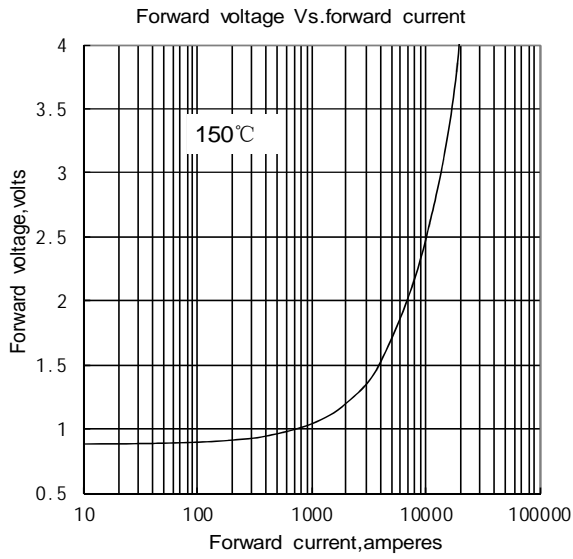

Fig.1

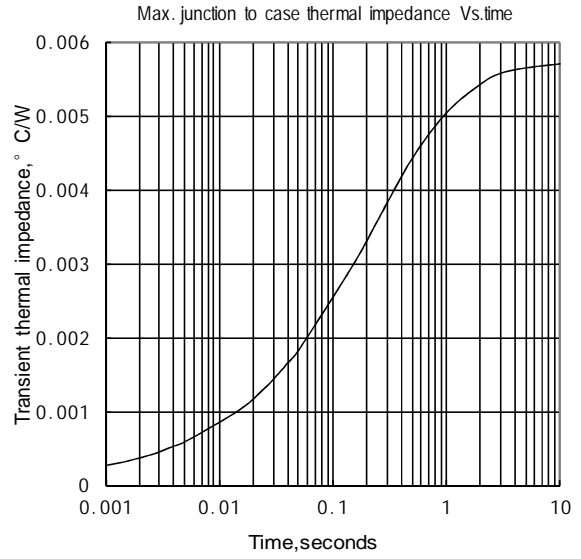

Fig.2

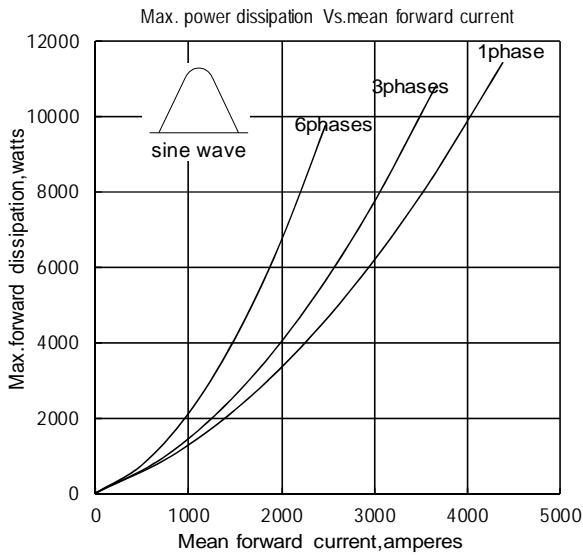

Fig.3

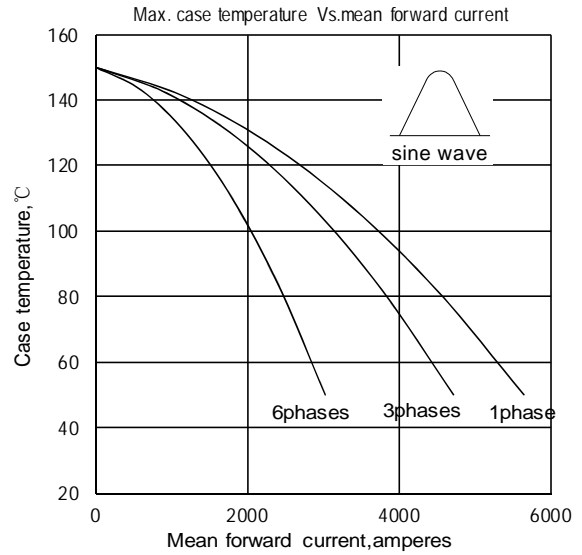

Fig.4

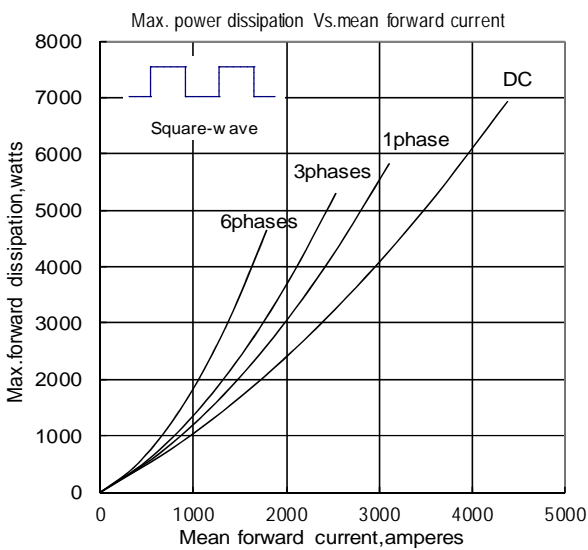

Fig.5

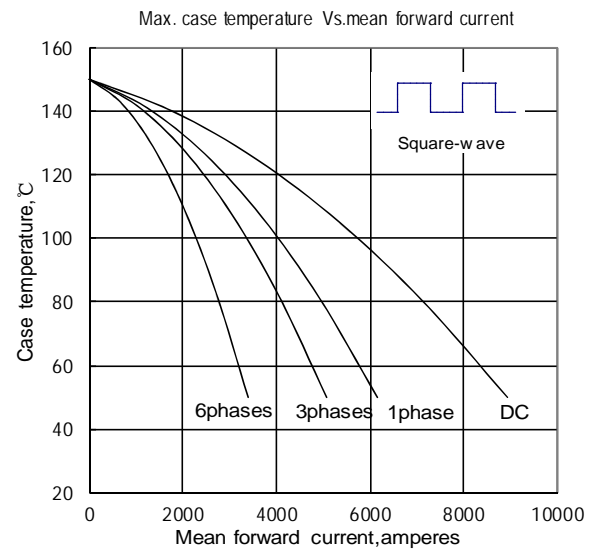

Fig.6

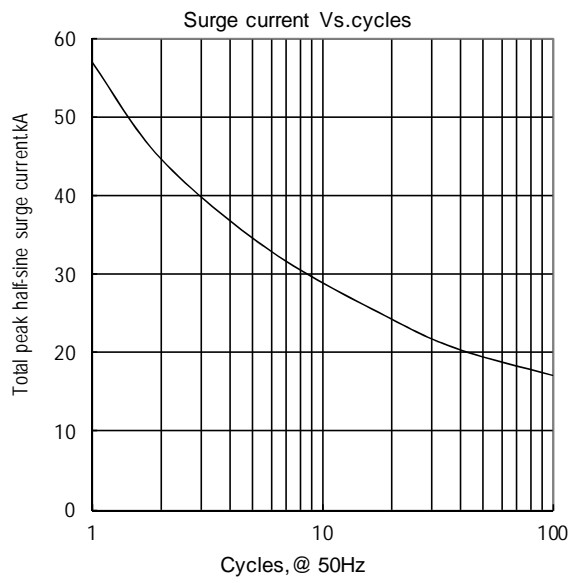

Fig.7

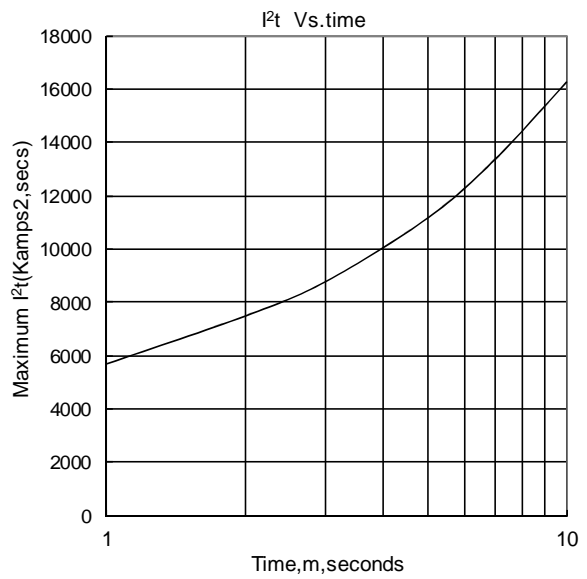
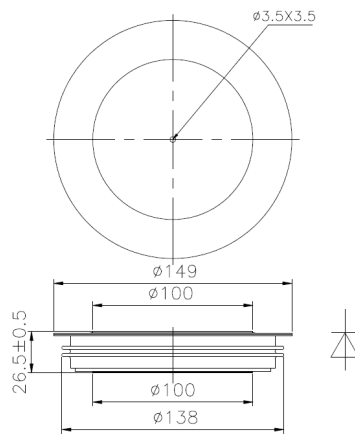

Fig.8

Outline:



TECHSEM reserves the right to change specifications without notice.