

**Features**

- n Center amplifying gate
- n Metal case with ceramic insulator
- n Low on-state and switching losses

Typical Applications

- n AC controllers
- n DC and AC motor control
- n Controlled rectifiers

Part No. H38KPU-KT33dT

I_{T(AV)}	300A
V_{DRM}, V_{RRM}	7500V 8000V
	8500V

SYMBOL	CHARACTERISTIC	TEST CONDITIONS	T _j (°C)	VALUE			UNIT
				Min	Type	Max	
I _{T(AV)}	Mean on-state current	180° half sine wave 50Hz Double side cooled T _C =70°C	125			300	A
V _{DRM} V _{RRM}	Repetitive peak off-state voltage Repetitive peak reverse voltage	tp=10ms	125	7300		8500	V
I _{DRM} I _{RDM}	Repetitive peak current	@V _{DRM} @V _{RRM}	125			200	mA
I _{TSM}	Surge on-state current	10ms half sine wave	125			4.0	kA
I ² t	I ² t for fusing coordination	V _R =0.6V _{RRM}				80	A ² s*10 ³
V _{TO}	Threshold voltage		125			2.02	V
r _T	On-state slope resistance					2.19	mΩ
V _{TM}	Peak on-state voltage	I _{TM} =500A, F=15kN	25			3.00	V
dv/dt	Critical rate of rise of off-state voltage	V _{DM} =0.67V _{DRM}	125			2000	V/μs
di/dt	Critical rate of rise of on-state current	V _{DM} = 67%V _{DRM} , Gate pulse t _r ≤0.5μs I _{GM} =1.5A	125			100	A/μs
Q _{rr}	Recovery charge	I _{TM} =2000A, tp=4000μs, di/dt=-5A/μs, V _R =100V	125		1500		μC
I _{GT}	Gate trigger current	V _A =12V, I _A =1A	25	40		300	mA
V _{GT}	Gate trigger voltage			0.8		3.0	V
I _H	Holding current			20		200	mA
I _L	Latching current					500	mA
V _{GD}	Non-trigger gate voltage	V _{DM} =0.67V _{DRM}	125			0.3	V
R _{th(j-c)}	Thermal resistance Junction to case	At 180° sine double side cooled Clamping force 15kN				0.045	°C /W
R _{th(c-h)}	Thermal resistance case to heatsink					0.008	°C /W
F _m	Mounting force			10	15	20	kN
T _{vj}	Junction temperature			-40		125	°C
T _{stg}	Stored temperature			-40		140	°C
W _t	Weight					300	g
Outline	KT33dT						

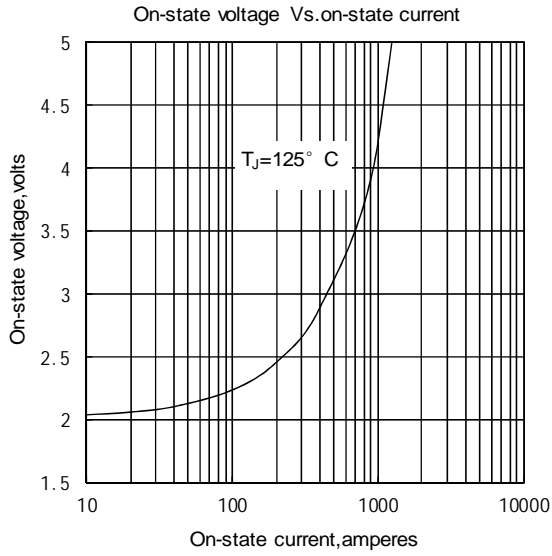

Fig.1

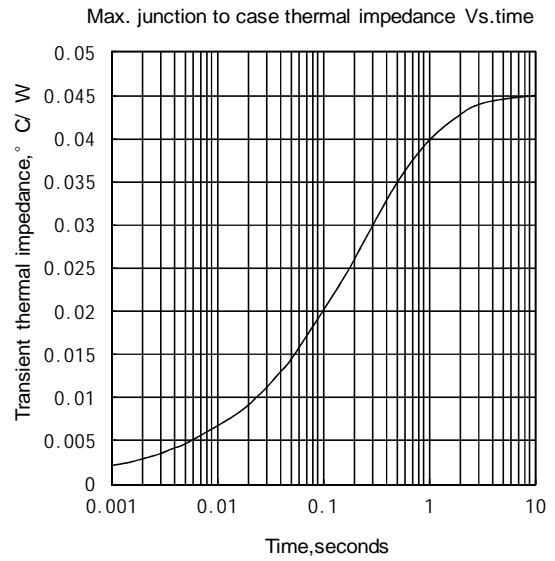

Fig.2

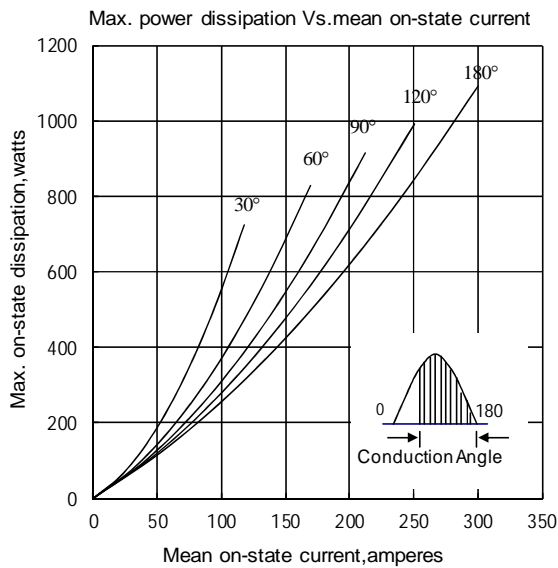

Fig.3

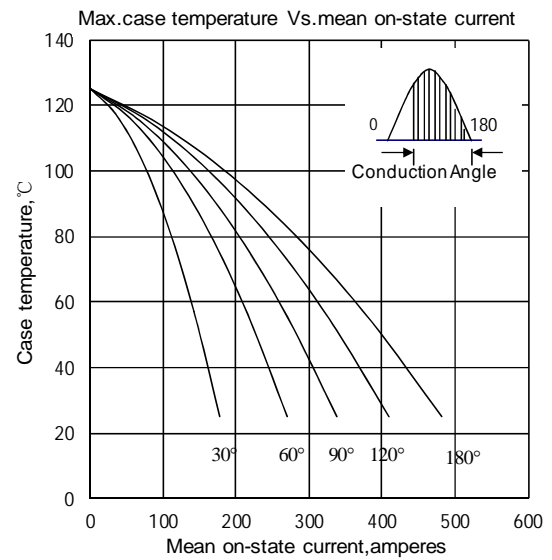

Fig.4

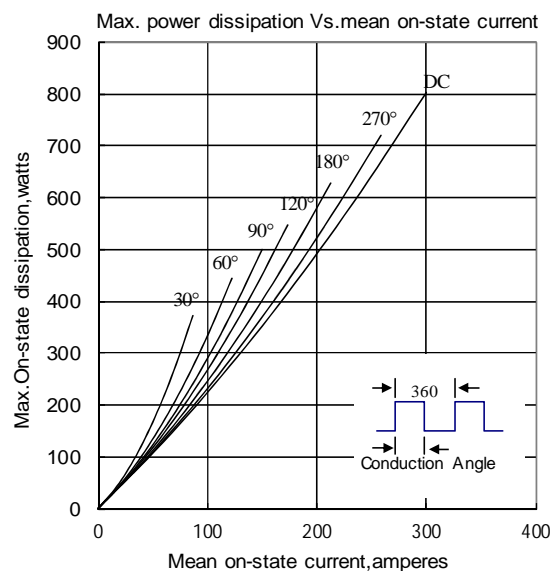

Fig.5

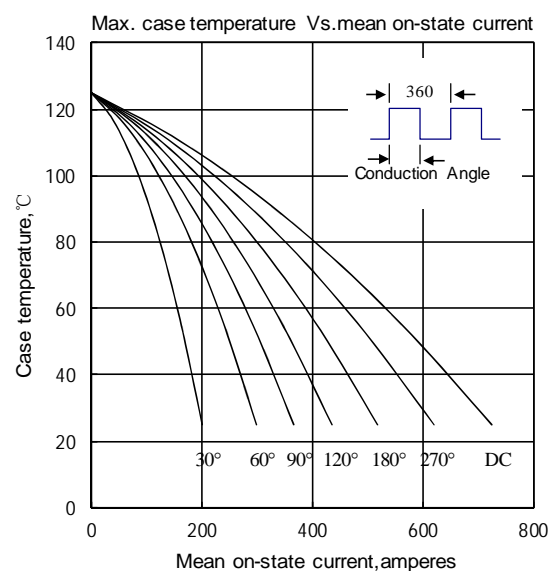

Fig.6

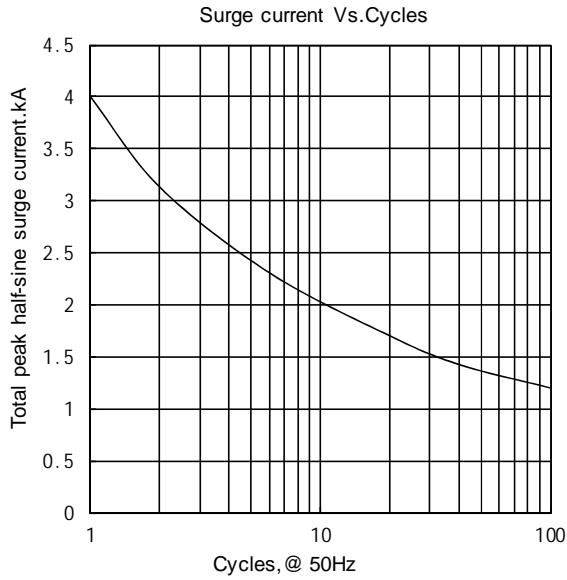

Fig.7

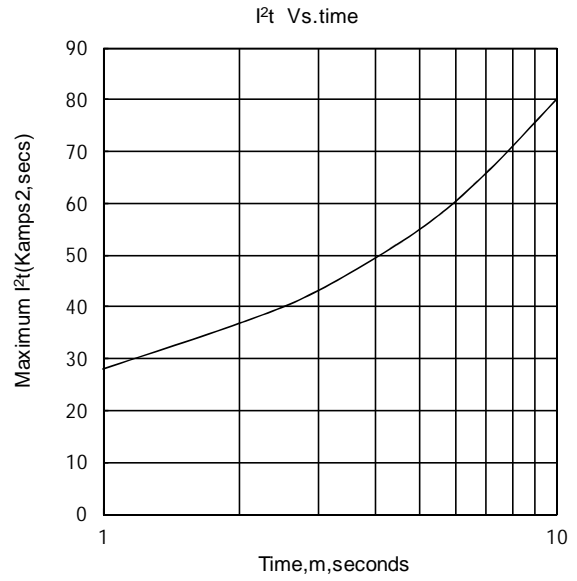

Fig.8

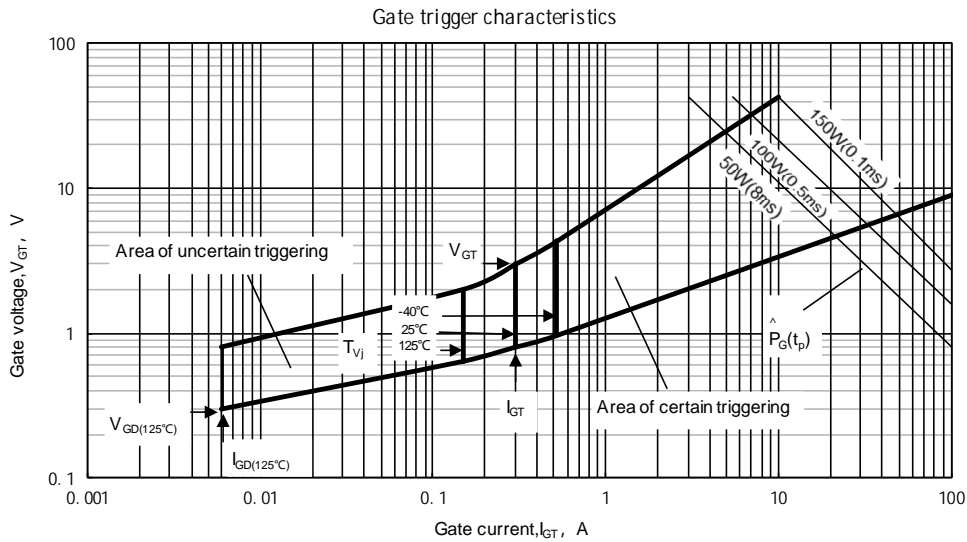
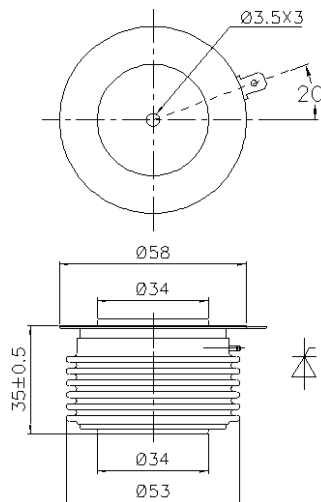

Fig.9

Outline:



TECHSEM reserves the right to change specifications without notice.