



Features

- Optimized for high current rectifiers
- Very low threshold voltage and slop resistance
- Very low thermal resistance

Typical Applications

- High current application For Welders up to 2000Hz
- Electrode plating

Part No. Y65ZPA-B-Z58T	
I_{F(AV)}	13500A
V_{RRM}	200V 400V

SYMBOL	CHARACTERISTIC	TEST CONDITIONS	T _J (°C)	VALUE			UNIT
				Min	Type	Max	
I _{F(AV)}	Mean forward current	180° half sine wave 50Hz Double side cooled, T _C =85°C	175			13500	A
V _{RRM}	Repetitive peak reverse voltage	tp=10ms	175	200		400	V
I _{RRM}	Repetitive peak current	at V _{RRM}	175			75	mA
I _{FSM}	Surge forward current	10ms half sine wave	175			85	kA
I ² t	I ² T for fusing coordination	V _R =0V _{RRM}					36000
V _{FO}	Threshold voltage	I _{FM} =10000-30000A	175			0.76	V
r _F	Forward slop resistance						0.021
V _{FM}	Max Peak on-state voltage	I _{FM} =6000A	25			0.90	V
Q _{rr}	Recovery charge	I _{FM} =2000A, tp=4000μs, di/dt=-20A/μs, V _R =100V	175			300	μC
R _{th(j-c)}	Thermal resistance Junction to case	At 180° sine double side cooled				0.004	°C /W
R _{th(c-h)}	Thermal resistance case to heat sink					0.002	
F _m	Mounting force			55	65	80	kN
T _{vj}	Junction temperature			-40		175	°C
T _{stg}	Stored temperature			-40		175	°C
W _t	Weight				160		g
Outline	Z58T						

Outline:

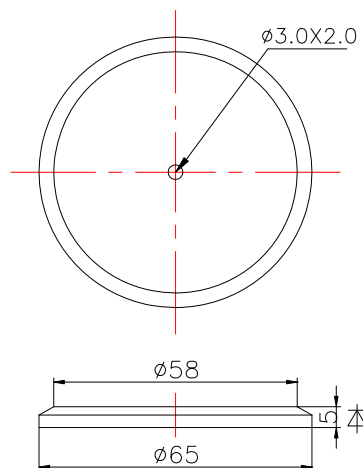

TECHSEM reserves the right to change specifications without notice.