

**Features**

- n Low forward voltage drop
- n High reverse voltage
- n Hermetic metal cases with ceramic insulators

Typical Applications

- n All purpose high power rectifier diodes
- n High power resistance welding equipment
- n Non-controllable and half-controllable rectifiers
- n Controlled rectifiers

Part No. H100ZPR-ZT100cT

I_{F(AV)}	4380A
V_{RRM}	5200V 5600V 6000V 6500V

SYMBOL	CHARACTERISTIC	TEST CONDITIONS		T _j (°C)	VALUE			UNIT
					Min	Type	Max	
I _{F(AV)}	Mean forward current	180° half sine wave 50Hz Double side cooled,	T _C =100°C	150			4380	A
V _{RRM}	Repetitive peak reverse voltage	tp=10ms		150	5100		6500	V
I _{RRM}	Repetitive peak current	at V _{RRM}		150			300	mA
I _{FSM}	Surge forward current	10ms half sine wave		150			57	kA
I ² t	I ² t for fusing coordination	V _R =0.6V _{RRM}						16200
V _{FO}	Threshold voltage			150			0.88	V
r _F	Forward slope resistance							0.16
V _{FM}	Peak forward voltage	I _{FM} =5000A, F=108kN		25			1.70	V
Q _{rr}	Recovery charge	I _{FM} =2000A, tp=4000μs, di/dt=-20A/μs, V _R =100V		150		17000		μC
R _{th(j-c)}	Thermal resistance Junction to case	At 180° sine- double side cooled Clamping force 108kN					0.0057	°C /W
R _{th(c-h)}	Thermal resistance case to heat sink						0.0015	
F _m	Mounting force				81		108	kN
T _{vj}	Junction temperature				-40		150	°C
T _{stg}	Stored temperature				-40		160	°C
W _t	Weight					2020		g
Outline	ZT100cT							

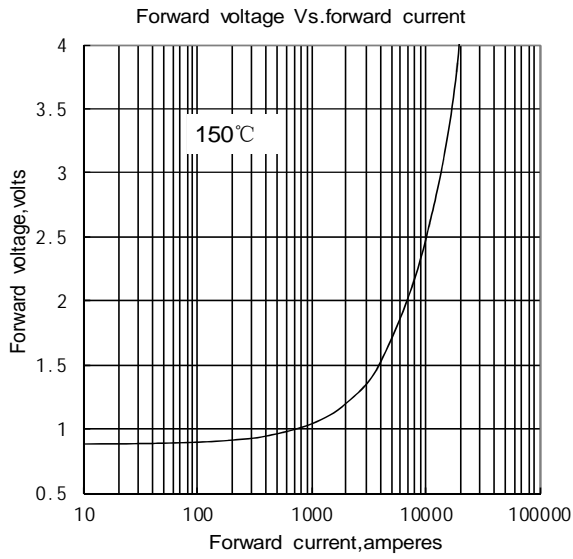

Fig.1

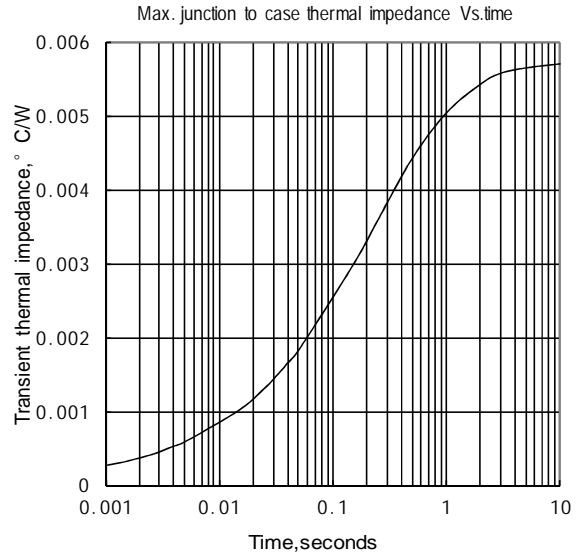

Fig.2

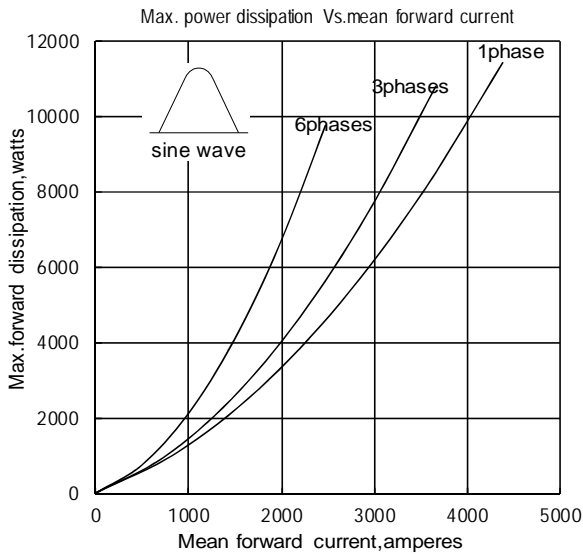

Fig.3

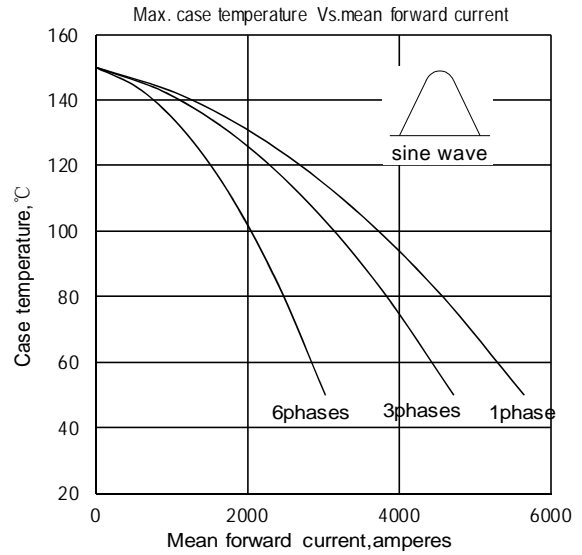

Fig.4

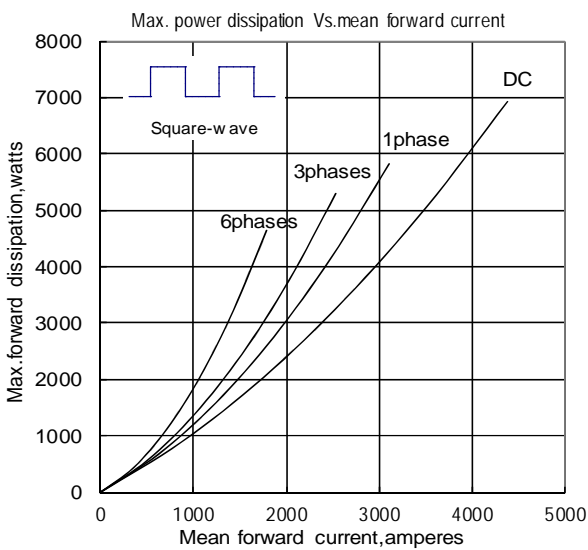

Fig.5

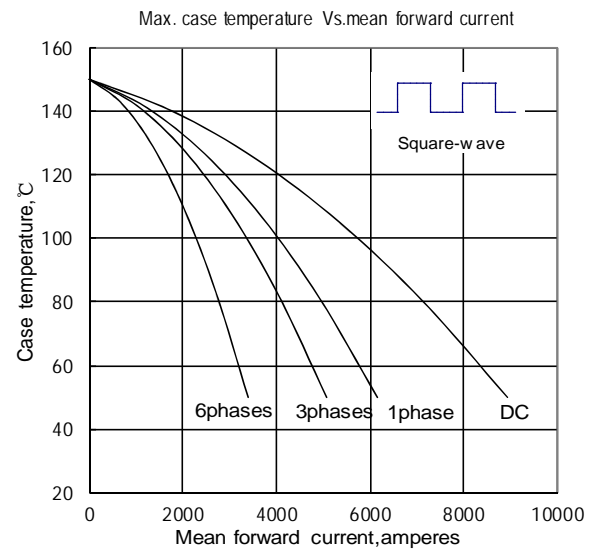

Fig.6

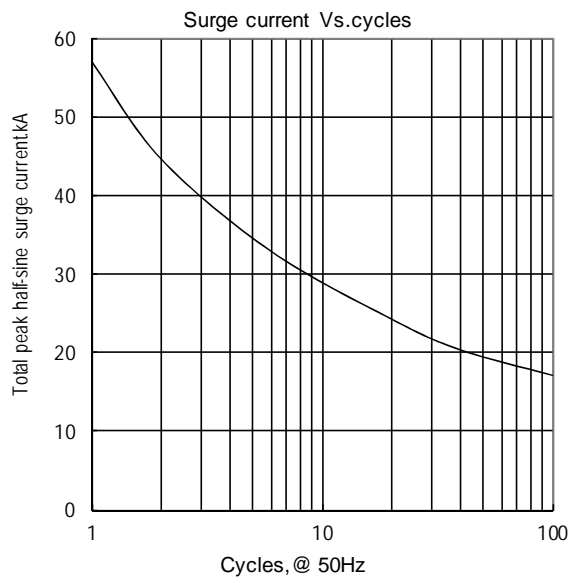

Fig.7

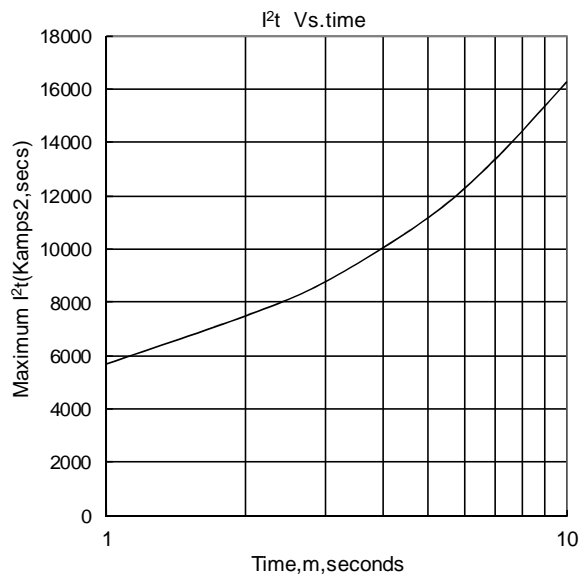
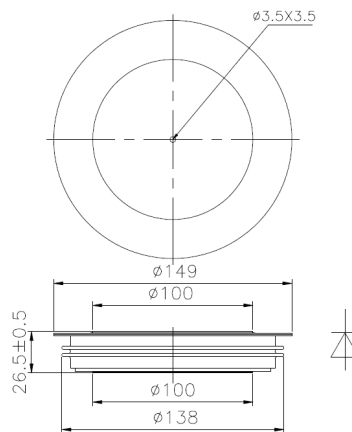

Fig.8

Outline:



TECHSEM reserves the right to change specifications without notice.