

**Features:**

- n Isolated mounting base 3000V~
- n Solder joint technology with increased power cycling capability
- n Space and weight saving

**Typical Applications:**

- n AC/DC Motor drives
- n Various rectifiers
- n DC supply for PWM inverter

$V_{DSM}, V_{RSM}$	$V_{DRM}, V_{RRM}$	Type & Outline
900V	800V	MTC90-08-224H3/224H3B
1100V	1000V	MTC90-10-224H3/224H3B
1300V	1200V	MTC90-12-224H3/224H3B
1500V	1400V	MTC90-14-224H3/224H3B
1700V	1600V	MTC90-16-224H3/224H3B
1900V	1800V	MTC90-18-224H3/224H3B

SYMBOL	CHARACTERISTIC	TEST CONDITIONS	$T_j$ (°C)	VALUE			UNIT
				Min	Type	Max	
$I_{T(AV)}$	Mean on-state current	180° half sine wave 50Hz Single side cooled, $T_c = 85^\circ\text{C}$	125			90	A
$I_{T(RMS)}$	RMS on-state current		125			141	A
$I_{DRM}$ $I_{RRM}$	Repetitive peak current	at $V_{DRM}$ at $V_{RRM}$	125			20	mA
$I_{TSM}$	Surge on-state current	10ms half sine wave	125			1.9	kA
$I^2t$	$I^2t$ for fusing coordination	$V_R = 60\%V_{RRM}$				18.1	$\text{A}^2\text{s} \cdot 10^3$
$V_{TO}$	Threshold voltage		125			0.70	V
$r_T$	On-state slope resistance					3.01	$\text{m}\Omega$
$V_{TM}$	Peak on-state voltage	$I_{TM} = 270\text{A}$	25			1.80	V
dv/dt	Critical rate of rise of off-state voltage	$V_{DM} = 67\%V_{DRM}$	125			1000	$\text{V}/\mu\text{s}$
di/dt	Critical rate of rise of on-state current	Gate source 1.5A $t_r \leq 0.5\mu\text{s}$ Repetitive	125			200	$\text{A}/\mu\text{s}$
$I_{GT}$	Gate trigger current	$V_A = 12\text{V}, I_A = 1\text{A}$	25	30		200	mA
$V_{GT}$	Gate trigger voltage			0.6		2.5	V
$I_H$	Holding current			10		250	mA
$I_L$	Latching current					1000	mA
$V_{GD}$	Non-trigger gate voltage	$V_{DM} = 67\%V_{DRM}$	125			0.2	V
$R_{th(j-c)}$	Thermal resistance Junction to case	Single side cooled per chip				0.28	$^\circ\text{C}/\text{W}$
$R_{th(c-h)}$	Thermal resistance case to heatsink	Single side cooled per chip				0.15	$^\circ\text{C}/\text{W}$
$V_{iso}$	Isolation voltage	50Hz, R.M.S., $t = 1\text{min}, I_{iso}: 1\text{mA(MAX)}$		3000			V
$F_m$	Thermal connection torque(M5)			2.5		4.0	$\text{N}\cdot\text{m}$
	Mounting torque(M6)			4.5		6.0	$\text{N}\cdot\text{m}$
$T_{vj}$	Junction temperature			-40		125	$^\circ\text{C}$
$T_{stg}$	Stored temperature			-40		125	$^\circ\text{C}$
$W_t$	Weight				100		g
Outline	224H3、224H3B						

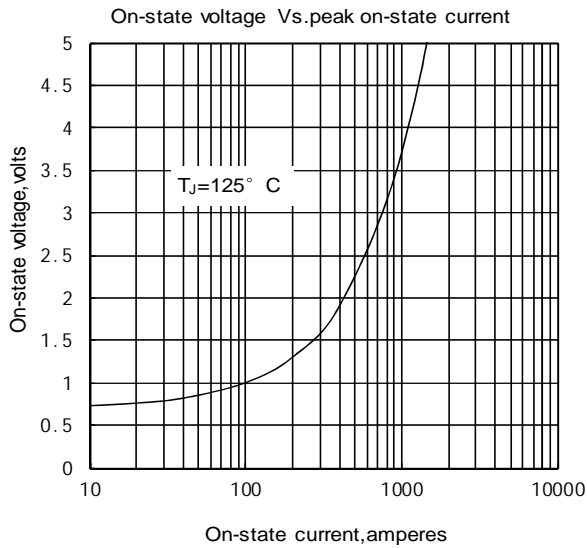

Fig1

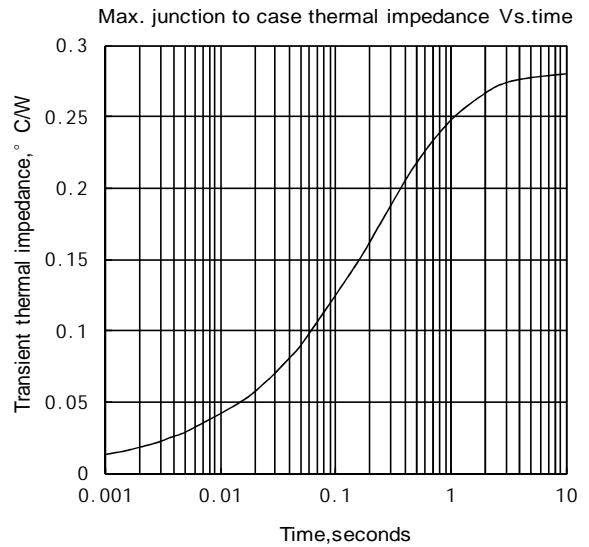

Fig2

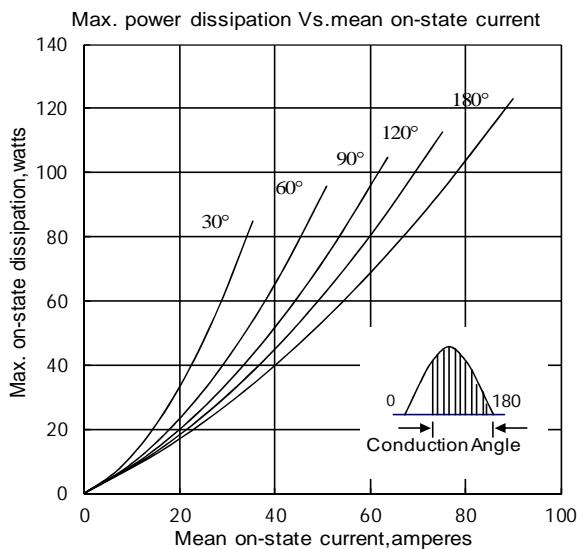

Fig3

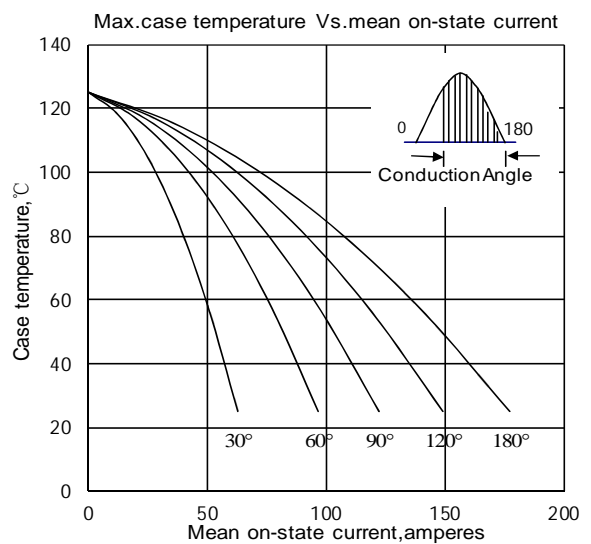

Fig4

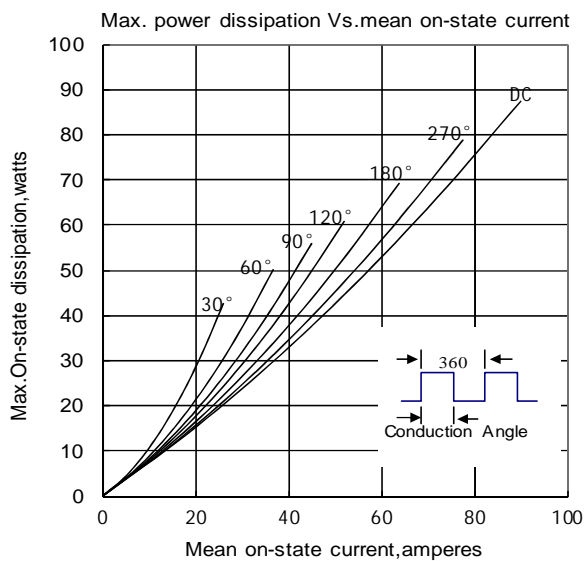

Fig5

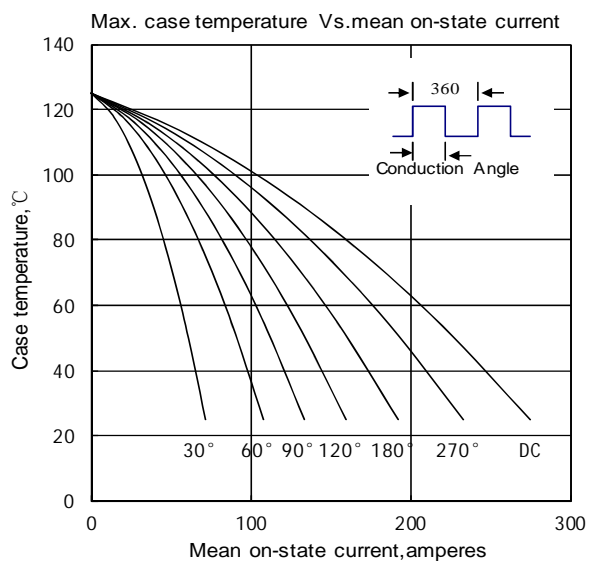

Fig6

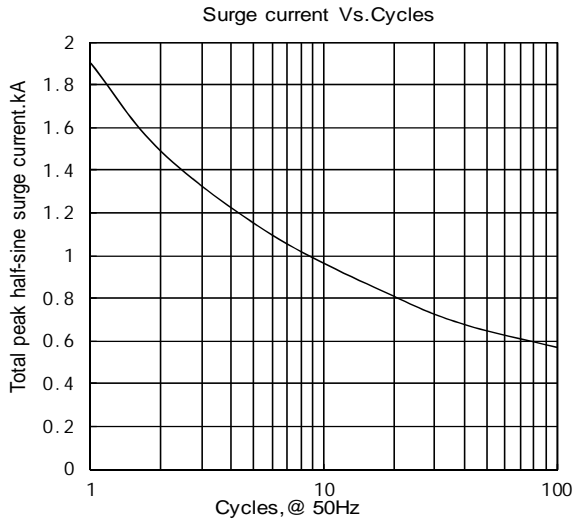

Fig 7

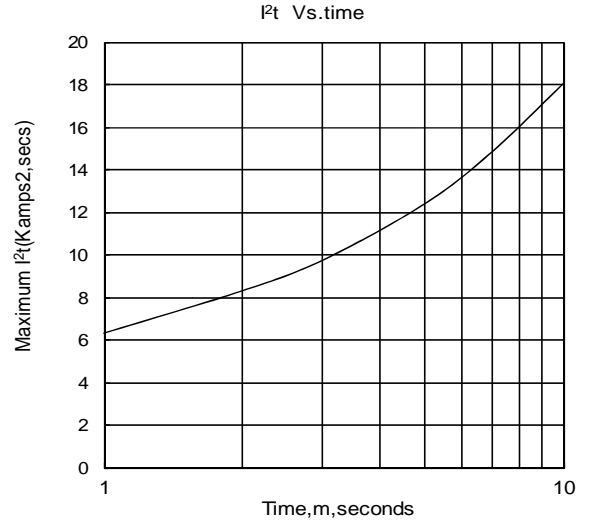

Fig 8

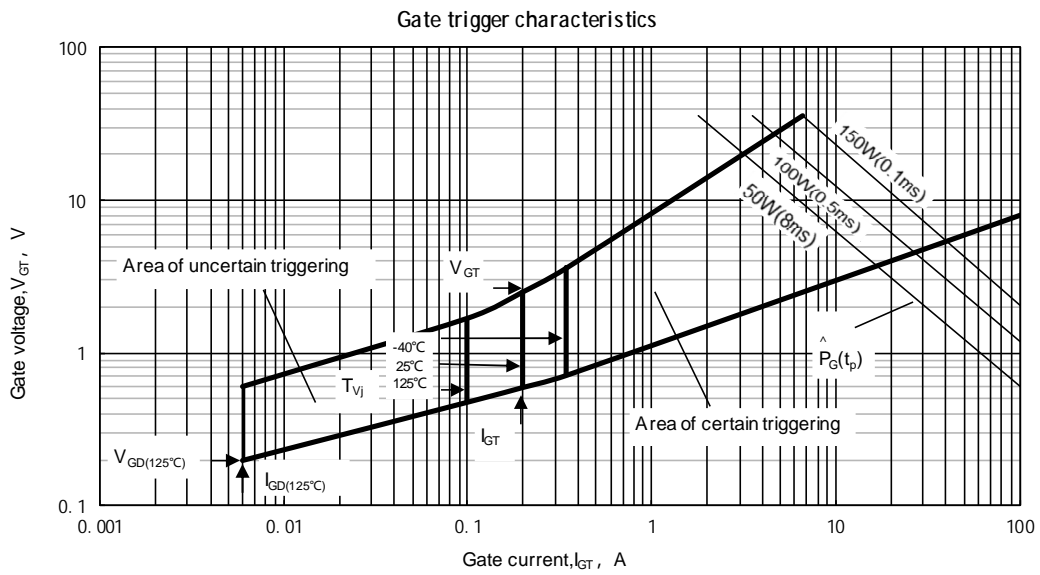
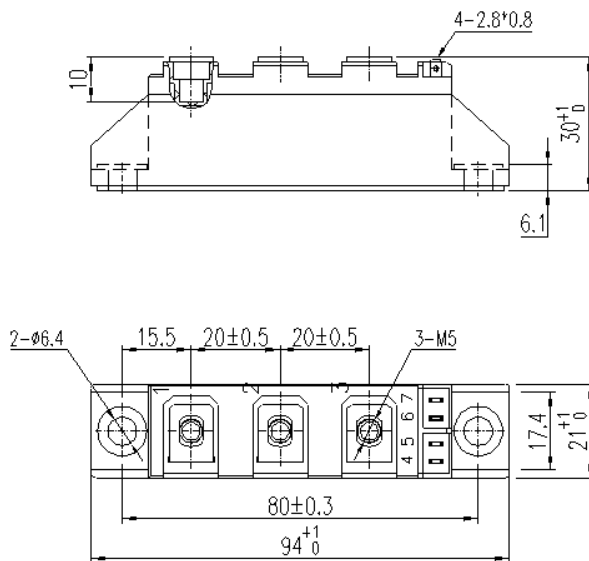
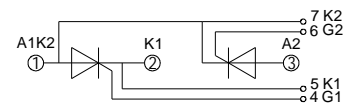

Fig.9

Outline:



MTC



MTC(B)

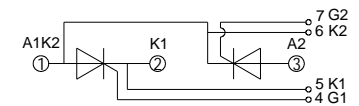

Unmarked dimensional tolerance: ±0.5mm

TECHSEM reserves the right to change specifications without notice.