



上海万狐实业有限公司

SHANGHAI FOXYGEN INDUSTRIAL CO., LTD



- **Stretch Ceiling**
- **Stretch Ceiling Accessories**
- **SEG LED Backlit Fabric Light Box**
- **3D 5D 8D Print Mural Wallpaper**

Advantages:

Stable quality and original factory price

Accept small orders

Fast delivery

Free training

Free samples,Free catalogs,Free artwork

Foxygen is a professional stretch ceiling, SEG fabric LED back lit light box & printing service industry. With more than 15 years of experience we can provide you with very good training of all our products.

We provide a one stop solution to our customers with our wide range of products. We have experienced designers and technicians who can offer our customers with specialized artwork, professional suggestions & technical advice.

We have a team of very experienced people to offer you our best services. Our Clients can get timely response which can ensure our customers receive high-quality products. We support our customers with HD PHOTO, HD VIDEOS, catalogs & Color card . Our all Products quality is reliable and durable which can meet the quality standards of Europe, USA, and other regions, and also can meet special needs of customer.

We are associated with a number of major brands in our industry. Our raw materials and finished products can meet the strict fire retardant classification and environment standards of Europe, USA and other regions. We can offer client a very good OEM and ODM Service.

You will benefit from our following advantages:

- A combination of high quality product & competitive price
- No minimum order quantity requirement
- Flexibility on packaging & optimized logistic process
- Professional technical expertise on production & supply chain
- Short lead time and on-time delivery

We are looking forward to establish a long-term partnership with you.

Foxygen is your right choice for industrial stretch ceiling, SEG fabric LED back lit light box & printing service industry. Don't hesitate to contact us for any of your inquiry, we trust this is going to be a win-win situation.





Lacquer Film >>>> Up to 5.0 Meters width

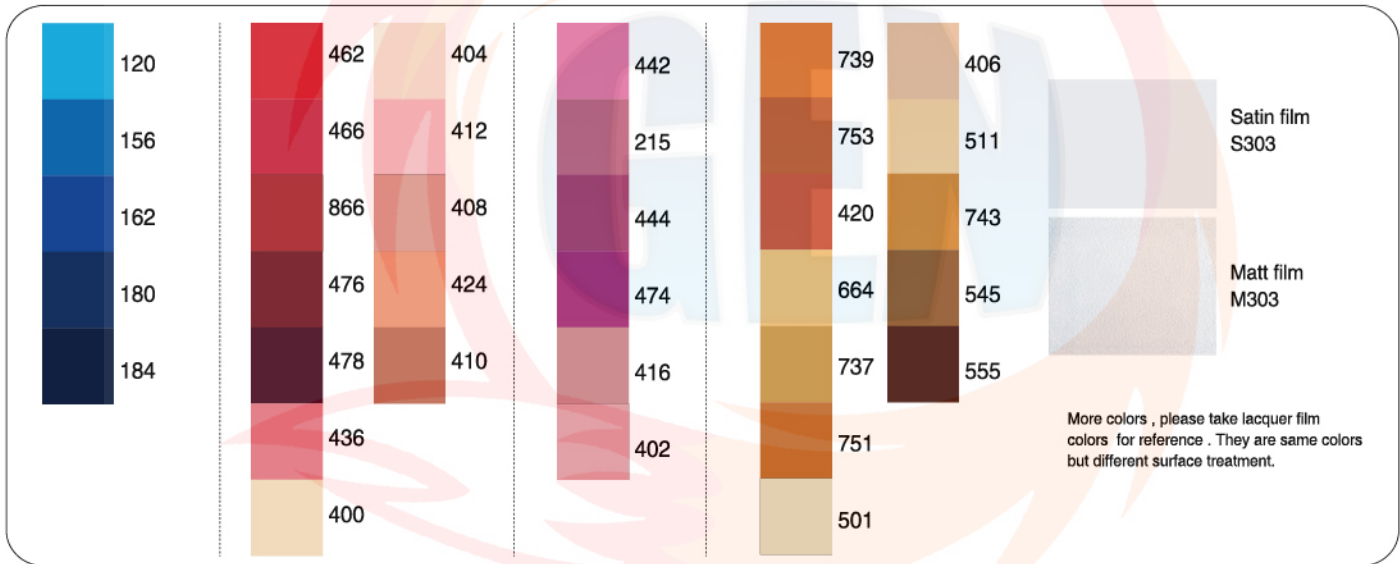
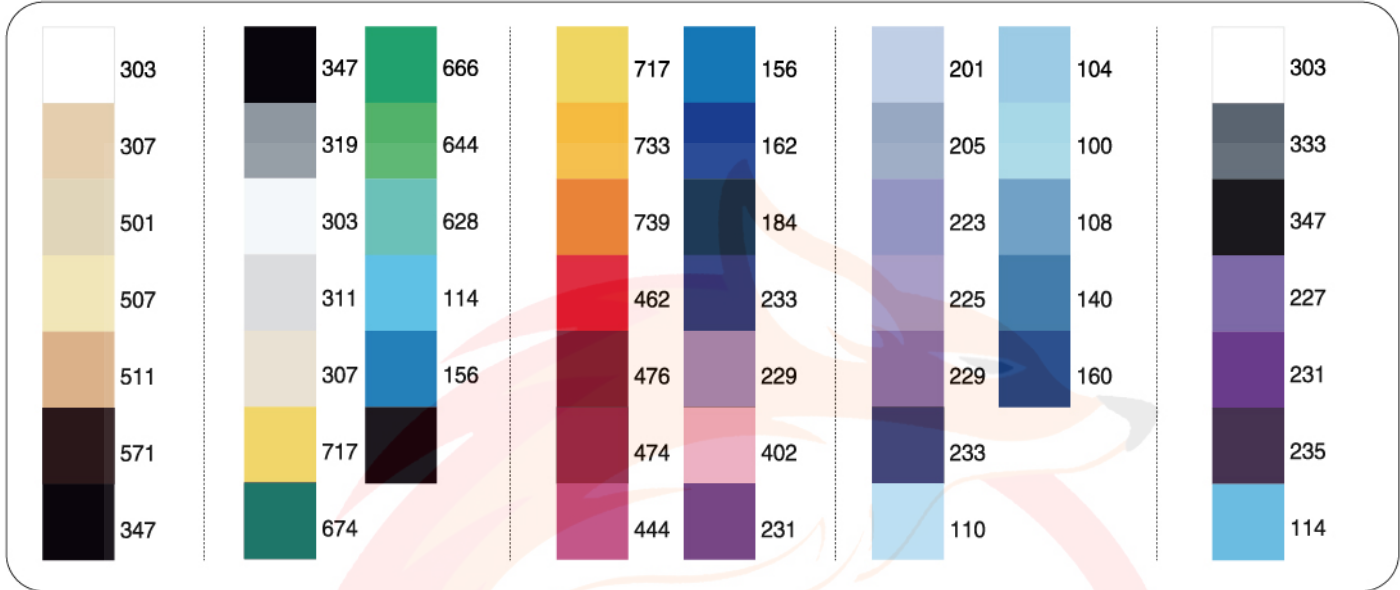

Lacquer Film >>>> Up to 5.0 Meters width

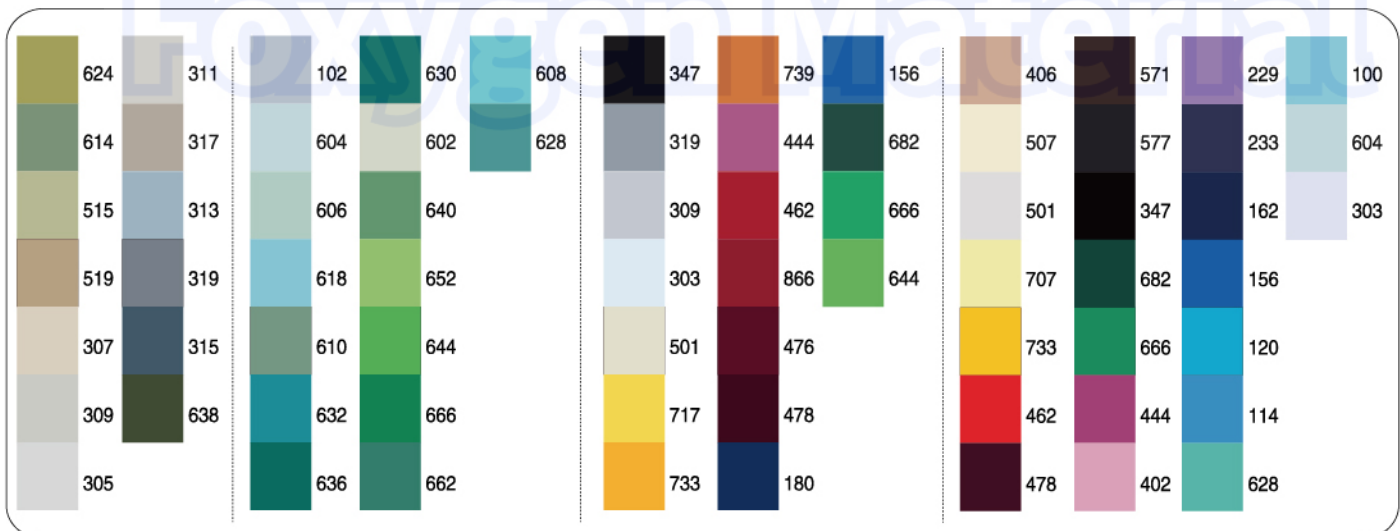

Galaxy Ceiling Film >>>> Up to 3.6 Meters width



Painting Film >>>> Up to 3.6 Meters width

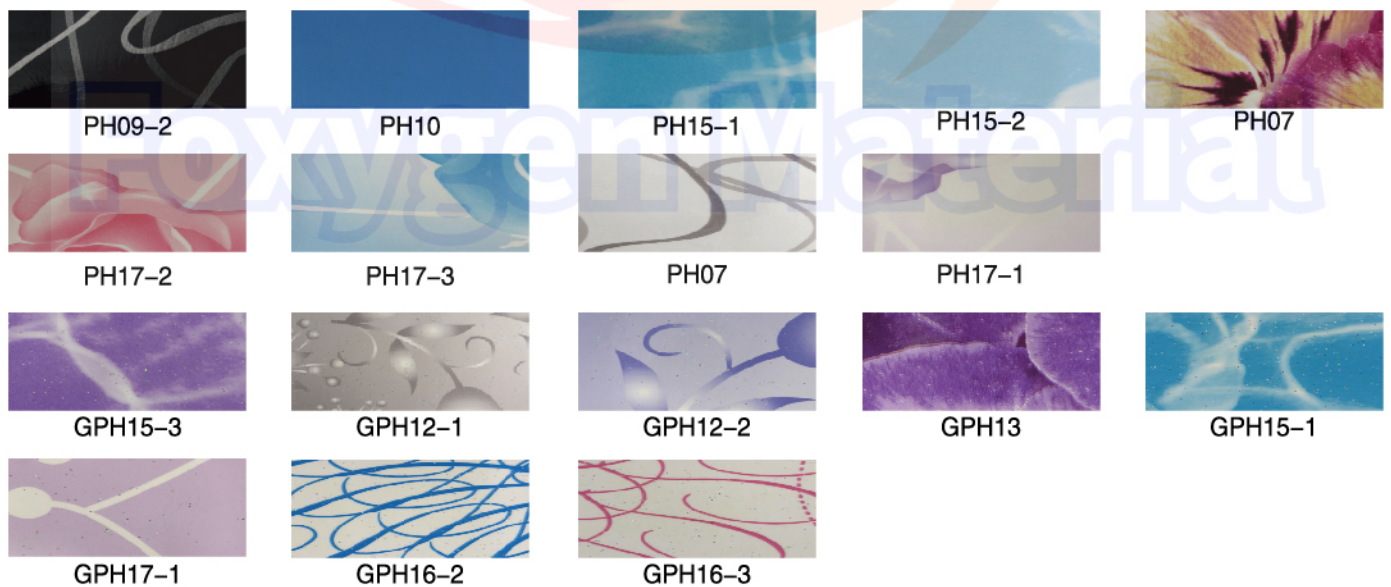



3D Drawing Film >>>> Up to 3.6 Meters width



Note: Because of the screen difference, above colors and patterns shown only for reference , please take the real products as standard .



FX3-006



FX3-007



FX2-501



FX2-608



FX2-903



FX3-501



FX4-005



FX3-008

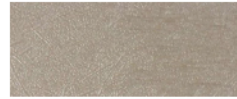

FX3-009



FX3-010



FX4-303



FX4-303PL



FX4-006



FX4-007



FX4-008



FX5-006



FX5-007



FX4-501



FX4-608



FX4-903



FX6-007



FX6-008



FX5-008



FX5-009



FX5-010

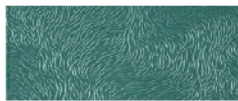

FX8

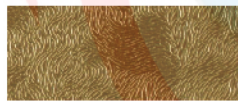

FX8-1



FX6-009



FX6-010

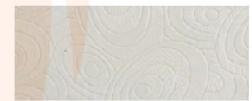

FX6-303



FX8-7

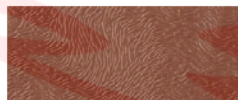

FX8-10



FX8-2



FX8-3

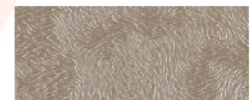

FX8-4



FX8-11



FX2-943



FX3-005



FX3-303



FX3-303PL



FX4-009

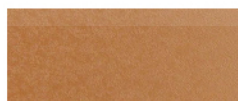

FX4-010

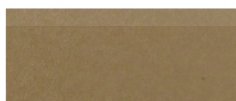

FX4-943



FX5-005



FX6-005



FX6-006



FX6-303PL



FX8



FX8-5



NET WEIGHT:	240-320 g/m ²
Afford Weight:	195kg/m ²
Thickness:	0.18 mm±10 percent
Translucent rate:	75%(translucent film),25-30%(lacquer film),35-40%(matte film), 10-25%(suede film)
Working temperature:	-30~65 degrees
Maximum tensile strength:	up to 17 MPa
Ultimate tensile strength:	30 N (both lengthwise and edgewise)
Light absorption coefficient:	30 percent (film canvases with mirror effect)
Shore hardness number:	41±2

Items (Colors)	Lacquer Film	Satin Film	Matt Film	Translucent Film	Printed Film
Standard Thickness	0.18 mm	0.18 mm	0.18 mm	0.18 mm	0.18 mm
Max. Thickness	0.25 mm	0.25 mm	0.25 mm	0.25 mm	0.25 mm
Width (Stock materials)	2.35/3.2 m	1.5/2.35 m	1.5/2.35 m	2.35/2.4/3.2/4.0 m	Customized
Max.Width	5.0 m	5.0 m	5.0 m	5.0 m	5.0 m
Length per Roll	100.0 m	100.0 m	100.0 m	100.0 m	6.0-20.0 m
MOQ(stock Materials)	1.0 Roll	1.0 Roll	1.0 Roll	1.0 Roll	Accept Small orders
Available Customized Width	1.5-5.0 m	1.5-5.0 m	1.5-5.0 m	1.5-5.0 m	Up to 5.0m



3D Patterns



FXGB2823



FXGB86



FXG22478



FXGB11023



FXGB3000

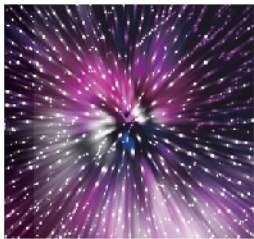

FXGB2887



FXG22319

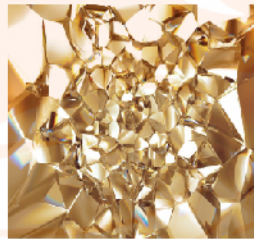

FXGB85

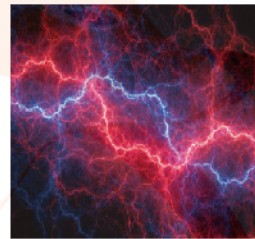

FXGB2787



FXG22355



FXGB2668



FXGB2621



FXGB2842

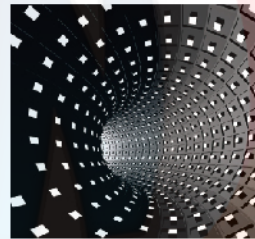

FXG2259



FXG22320

Wall Patterns

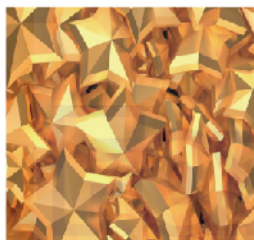

FXGB2914

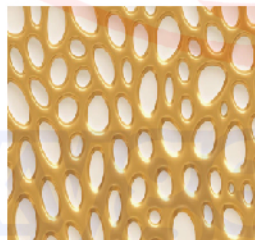

FXGB2912



FXGB2903



FXGW142



FXG22331



FXGW810



FXGW811

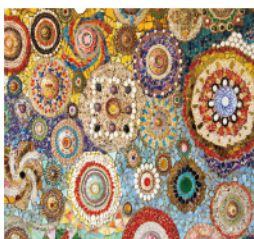

FXGW813

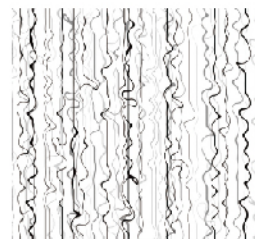

FXGB2850



FXG012



Wall Patterns



FXGW704

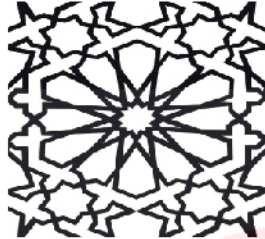

FXGB11028



FXGW809



FXGW805

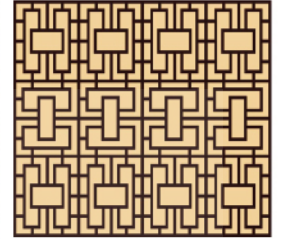

FXGB3004

Flower Patterns



G643



FXGB1154



FXGB2597



FXGB2824



G661



FXGB1155



FXG1876



FXGB2813



FXGB1156



FXGB2816



G652

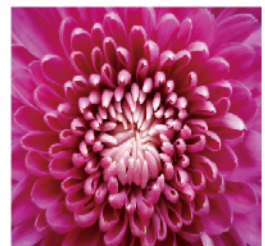

FXG1827



FXGB2536

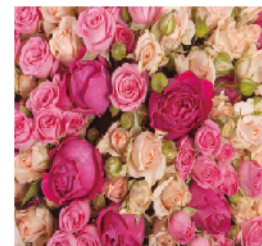

FXGB2537

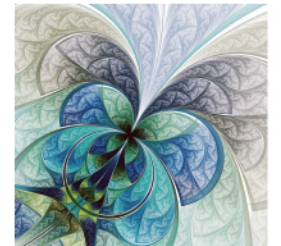

FXGB2818

Blue Sky



FXG1656



FXGB2885



FXG22323



FXG1635



FXGB2932



FXGB2680



FXGB11110



FXGB2864



GS107



FXG22325



FXG2286



FXG2302



FXG014



FXG22352



GS107

Stone Patterns

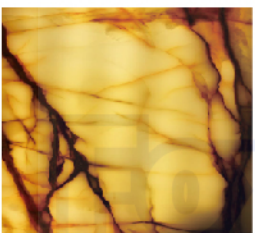

FXGB1176



FXG22420



FXG22421



FXGB2894

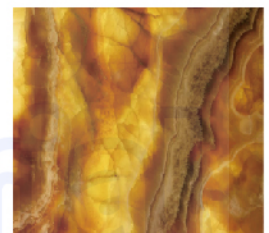

FXGB11024



FXGB2892

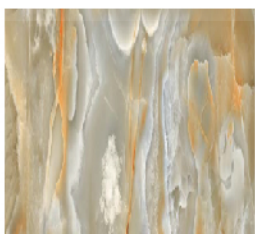

FXGB2891

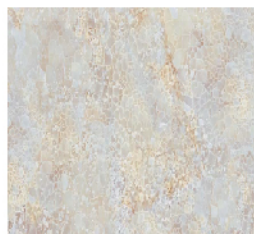

FXGB2772

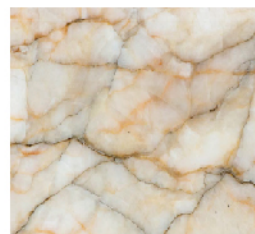

FXG22309



FXG22361



Stone Patterns



SD579

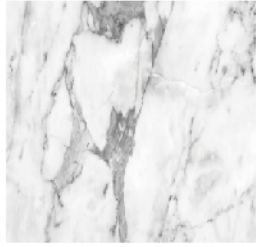

FXG22422



FXG22419

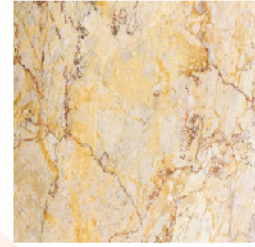

FXGB2919

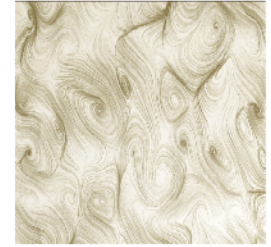

FXGB11032

Night Sky



FXGB50



FXGB49



FXGB94



FXGB48



FXGB46

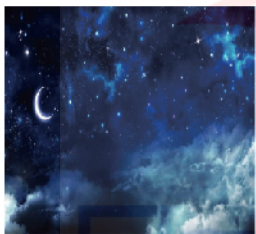

FXG22389



FXGB1119_1



FXGB47



FXGB02



FXG223412



FXGB2561

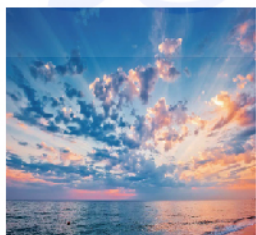

FXG22357



FXGB2751



FXGB2575



FXGB11032



F Aluminum Profile

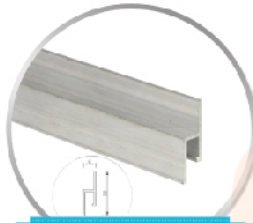

H Aluminum Profile



M Aluminum Profile

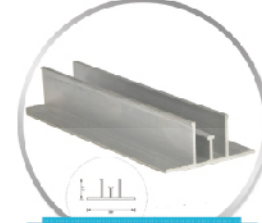

W Aluminum Profile

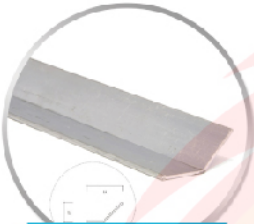

V Aluminum Profile



Small PVC Cover



Big PVC Cover



PVC Harpoon



Spatula



Welding Machine



Profile Bending Machine



Air Heater

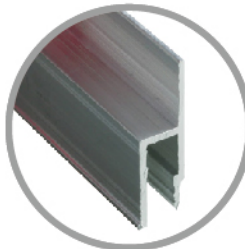
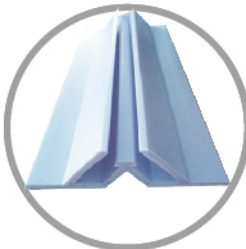
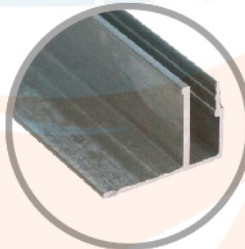
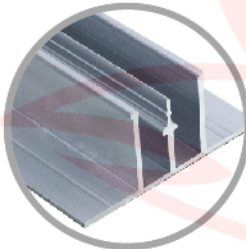

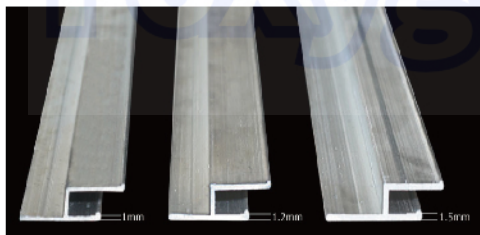
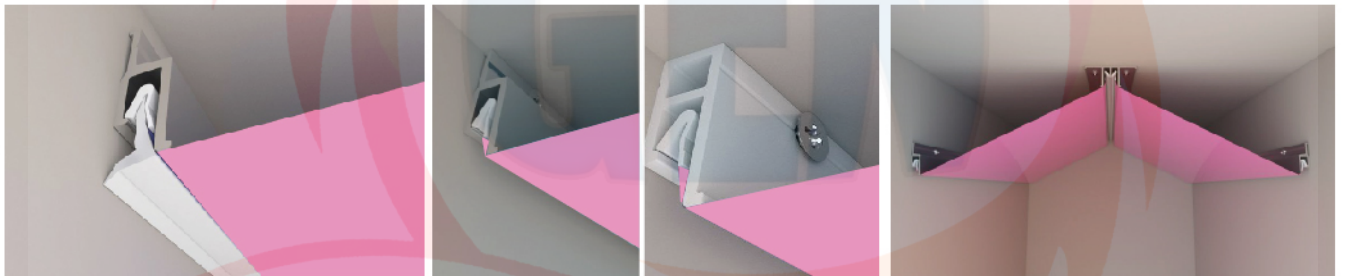
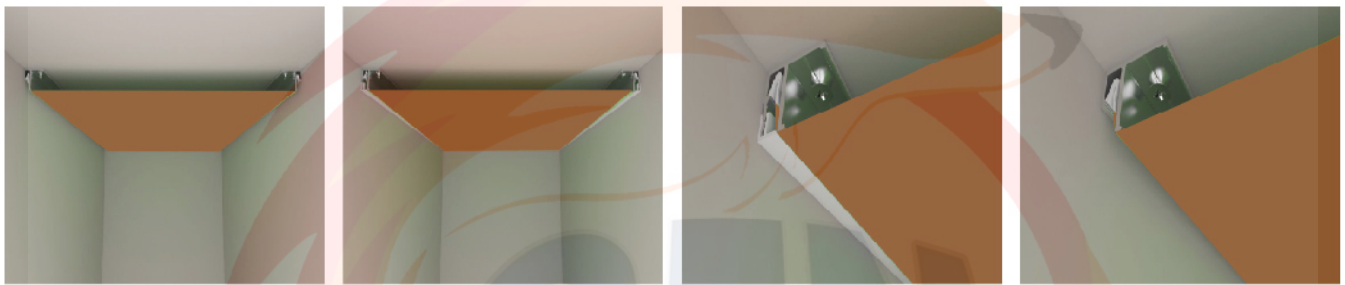
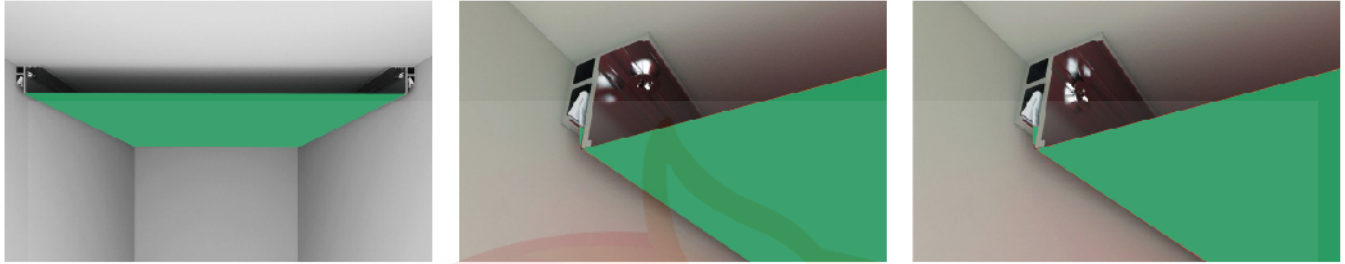

PVC decorative cover
(work with Type II aluminum profiles)



Aluminum Material	Aluminum Length	Aluminum Color	Thickness	Remark
6063 Aluminum alloy	2500 mm /pcs	Silver Anodized	1.0MM , 1.2MM, 1.5MM	Customized is available

1 Taking measurements

This process is carried out in the traditional manner, indicating the dimensions on the drawings.

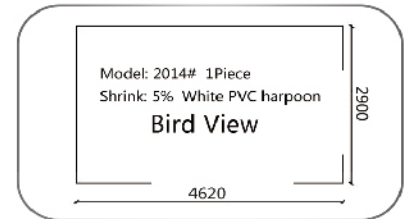

2 Manufacture of the FOXYGEN S stretch ceiling

Each Stretch Ceiling is made to measure by in-house designed computers, with a choice of over a hundred colors and a dozen textures. Cutting and assembly welding is conducted with the absolute millimeter precision. A standard ceiling can be dispatched from 1-10 days, by rapid delivery service.



3 Fitting profiles

On site, the peripheral structure is set in place by mechanical means(pegs, screws, stapling) on the wall or ceiling. FOXYGEN has developed some highly multi-variant profiles, with a limited number of options: in this way, ordering, stocking and installation are considerably simplified.



4 Fitting accessories

Finally, the details are seen to: posts, columns, integrated spotlights, chandeliers, LED systems, ventilation, sprinklers...Custom accessories simplify installation and guarantee perfect performance.

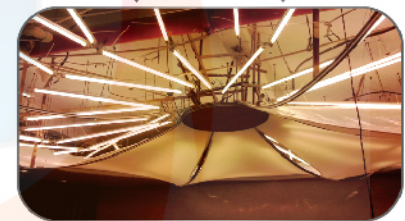

5 Installation of FOXYGEN Stretch ceiling film

Prior to installation, the thermo-expandable Stretch Ceiling is made supple by slightly raising the temperature of the surroundings for the time needed to lock the anchor into the profile. The Stretch Ceiling is automatically tensed as it cools, thanks to the thermo-retractable design. The ceiling remains firm with no problems. The site work is completed, with no noise, damage, or rubbish.

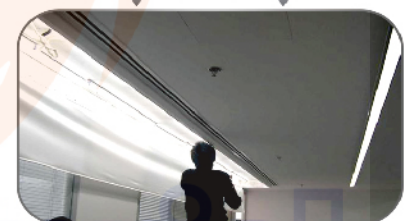

6 Removal for renovation and other work

Both installation and removal of the Stretch Ceiling are straightforward: no demolition or finishing when you need a new system, safety installation or IT network for example.





From the technical FOXYGEN or the aesthetic point of view multiplies the benefits

1. An infinity of creative possibilities

- ›› an exceptional choice of colors and performance qualities
- ›› creation of horizontal, vertical or inclined surfaces
- ›› creation of curves and volume
- ›› creative mastery of light effects: diffusion, depth, reflections...
- ›› adaptable to all styles of architecture



2. Rapid assembly and fitting, a clean site

- ›› simple preparatory work, with no removal necessary
- ›› fitting and assembly in a few hours
- ›› a dry working site, no smell, no dust
- ›› no drying required
- ›› premises immediately available



3. Perfect for new build and for renovation

- ›› masks all faults in pre-existing ceilings: cracks, ducts, cables...
- ›› no risk of cracking
- ›› no demolition time required
- ›› return to a perfect surface
- ›› additional comfort both from an acoustic and heat point of view
- ›› extremely rapid set up with no removal necessary



4. Extra comfort

- ›› improvement of temperature comfort by means of insulating cushion of air
- ›› results guaranteed in association with thermal or acoustic insulation
- ›› additional acoustic comfort, a warm, protective atmosphere
- ›› creation of upper space acoustic quality with perforated Stretch Ceiling
- ›› visual comfort, increase in space, a feeling of well-being
- ›› antistatic



5. Respect for the environment, today and tomorrow

- » Stretch Ceiling and the profiles are 100% recyclable, making use of existing channels
- » non-toxic materials conforming to international standards
- » longevity
- » low transport volumes and weight
- » manufacture: economical energy use
- » no painting required, minimal maintenance
- » guaranteed free of heavy metals, in accordance with EU standards



6. Fire-and-water resistant and durable

- » mechanically strong, absorbs impacts
- » automatic return to original tension and form(form memory)
- » insensitive to condensation and damp, perfect for humid environments
- » water-tight, protection in the event of damage caused by water
- » registration in terms of reaction to fire in a public place Bs2d0(formerly M1, B1, Assessed to Class O)
- » 15 years FOXYGEN guarantee in accordance with general terms and conditions of sale
- » washable with water or with particular cleaning agents
- » good preservation of aspect
- » considerable temperature stability
- » ceiling origin tracked

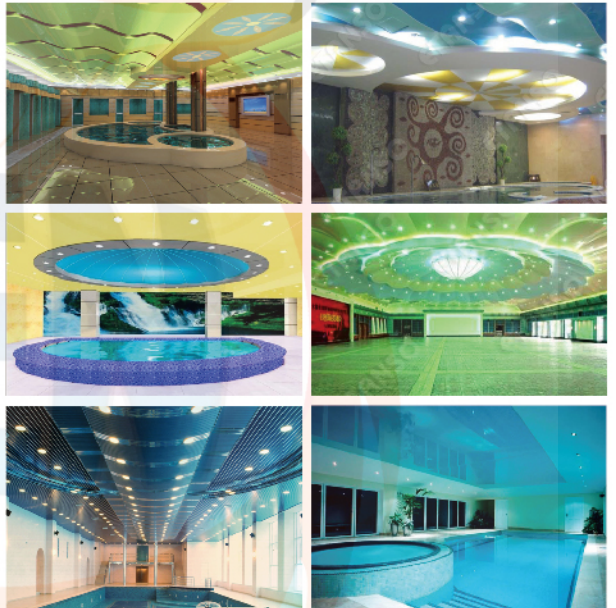

7. Daylight...integrated light

- » back-lighting of all Stretch Ceilings, whether white or colored
- » adaptable to tile ceilings, precisely located light sources and control systems
- » insulation materials increase sonic absorption
- » even without perforation improves acoustic



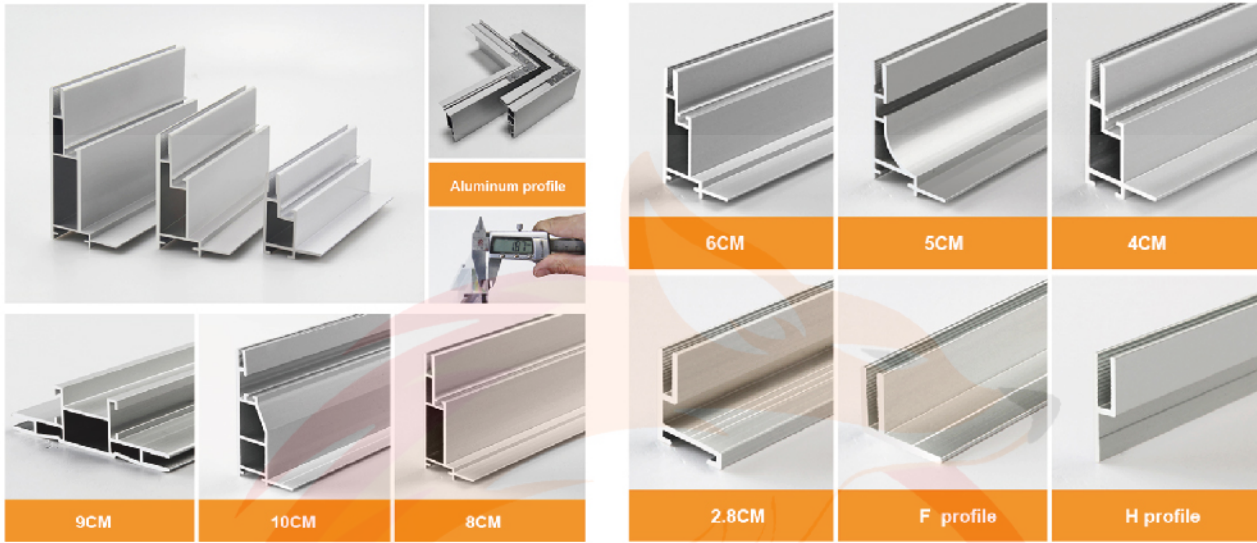

Fabric Lightbox

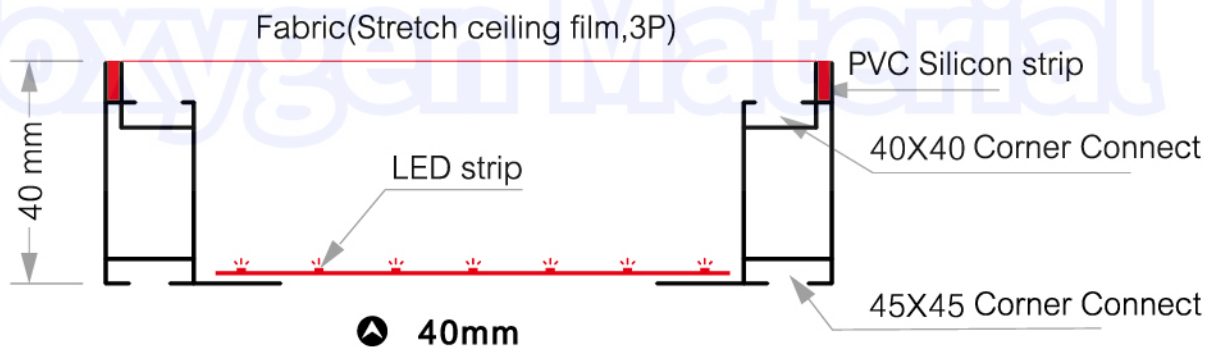
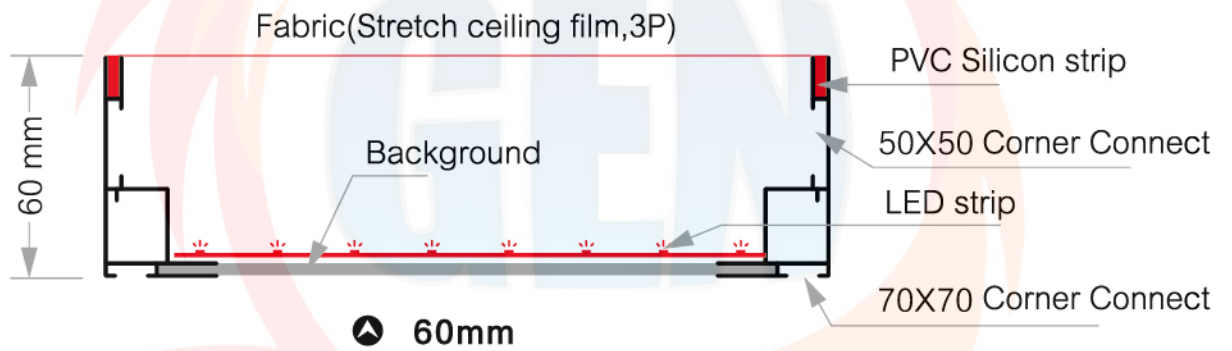
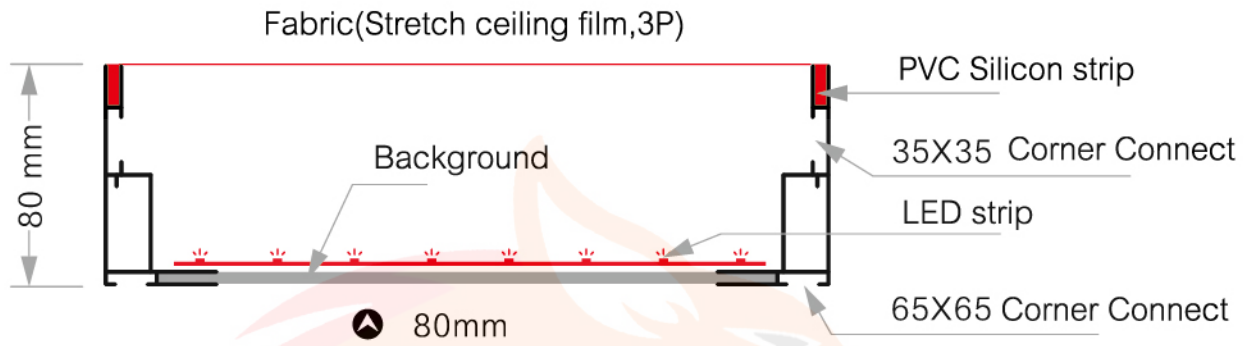

SEG Light Box

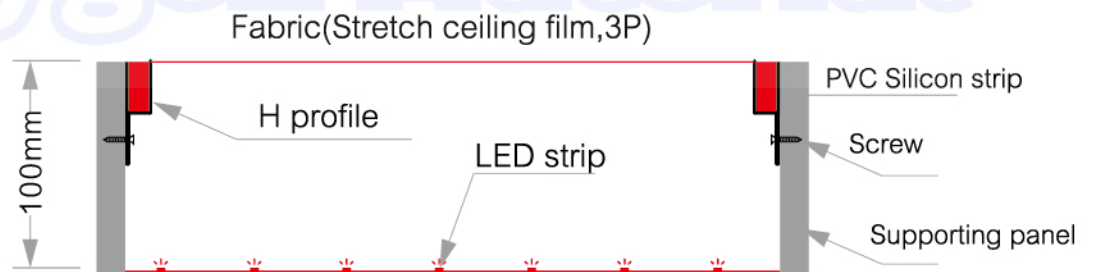
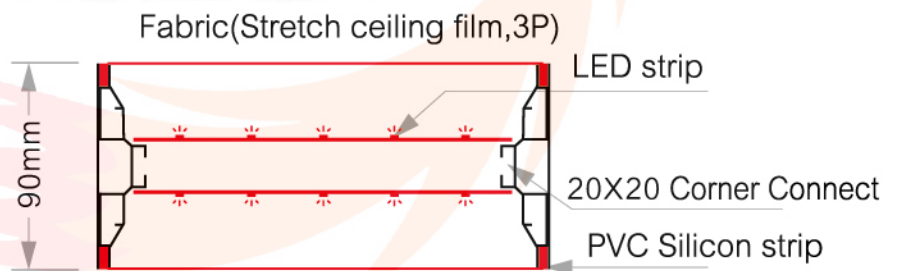
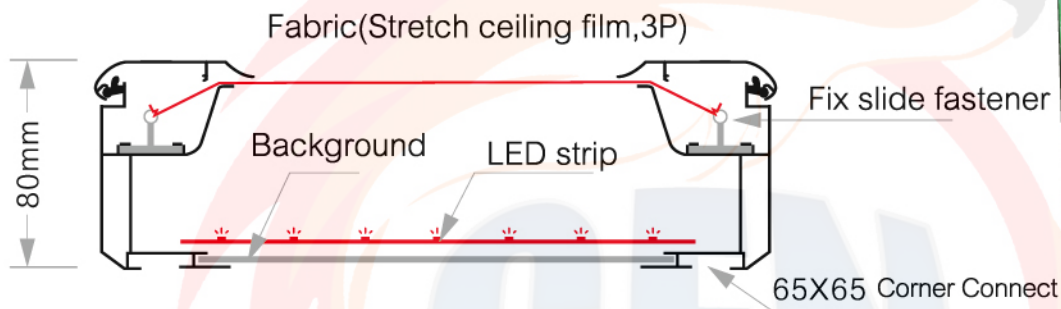
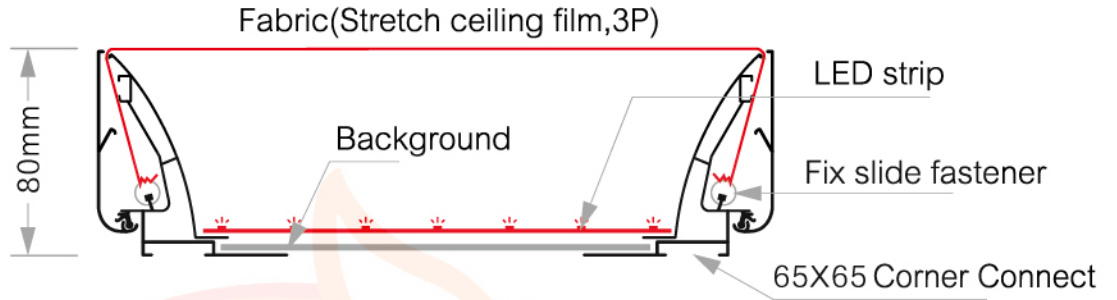

QUALITY GUARANTEE FOR ALL FILMS

15
YEARS



Company information



Wechat

Welcome to contact us

Contact Details :

Shanghai Foxygen Industrial Co.,Ltd
No. 59 Shenpu Road, Baoshan District,
Shanghai city, China
Zip : 200941
Tel: +0086-021-36382796
Foxygen@foxy-gen.com
www.foxygenstretchceiling.com

Katherina
Whatsapp/Wechat:+0086-15821951626
Email : Katherina@foxy-gen.com

Melody
Whatsapp/Wechat:+0086-18317033075
Email: Meldoy@foxy-gen.com

Lurita
Whatsapp/Wechat:+0086-15900703866
Email: Lurita@foxy-gen.com

Bring the World In