

# GTGMOTO AUTO PARTS

Yantai Zhenggang Auto Parts Manufacturing Co., Ltd.

<https://coolingsky.en.alibaba.com>

## Yantai Zhenggang Auto Parts Manufacturing Co., Ltd.

📍 No.66 Shaoshan Road, Fenggezhuang Street, Laiyang City, Yantai City, Shandong Province, China

🌐 <https://coolingsky.en.alibaba.com>

☎ +86 17820731480

✉ [alixjing@163.com](mailto:alixjing@163.com)

📞 +86 17820731480



3000+

Models of accessories



30000m<sup>2</sup>+

Total floorspace



One-stop

High quality service





# COMPANY PROFILE

Yantai Zhenggang Auto Parts Manufacturing Co., Ltd. is a Sino-foreign joint venture with registered capital of 25 million US dollars, covering a total area of 33,823 square metres, and is one of the manufacturers of all-aluminium automotive radiators with the highest degree of specialization and the largest production scale in China. The company mainly produces automotive radiator, intercooler, oil cooler, condenser, warm air system and other automotive modification accessories, product categories up to more than 3,000 kinds.

**3000+**  
models of accessories

**30,000+**  
total floorspace

**One-stop**  
high quality service

Our products are exported to USA, Canada, UK, Australia, Malaysia, Japan, New Zealand and other countries. In order to better serve our customers in major regions, we have set up 5 large ware-houses overseas, which are CA, NJ, USA, Melbourne, Australia, NRW, Germany, Fradley, Lichfeldo, UK.

The company is specially equipped with data processing centers, automatic welding robots, laser cutting machines, domestically advanced fiber optic welding furnaces, domestically advanced pipe making machines, automatic core loading machines, automatic stamping and other equipment to ensure the quality of auto parts products.



# COMPANY CULTURE

## CORPORATE VISION

To become the world's leading manufacturer of automotive parts, making every vehicle excel through our products.

## CORPORATE MISSION

To deeply understand customer needs, provide personalized and customized services, adhere to the highest quality standards, and ensure every product exceeds customer expectations.

## CORE CORPORATE VALUES

Integrity as the foundation, pursuit of excellence, continuous self-challenge, attention to detail, and striving for perfection in every process and product.



# BRAZING PROCESS



## Advanced production equipment

equipped with modern professional equipment such as data processing center, automatic welding robot, laser cutting machine, unique automotive heat exchanger brazing process, and using NOCOLOK flux furnace brazing.



# PRODUCTION EQUIPMENT



Laser Cutting Machine



Tube Making Machine

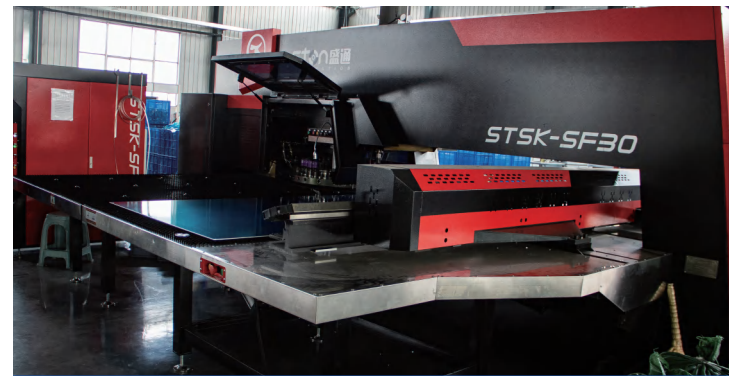

CNC Turret Punch Press

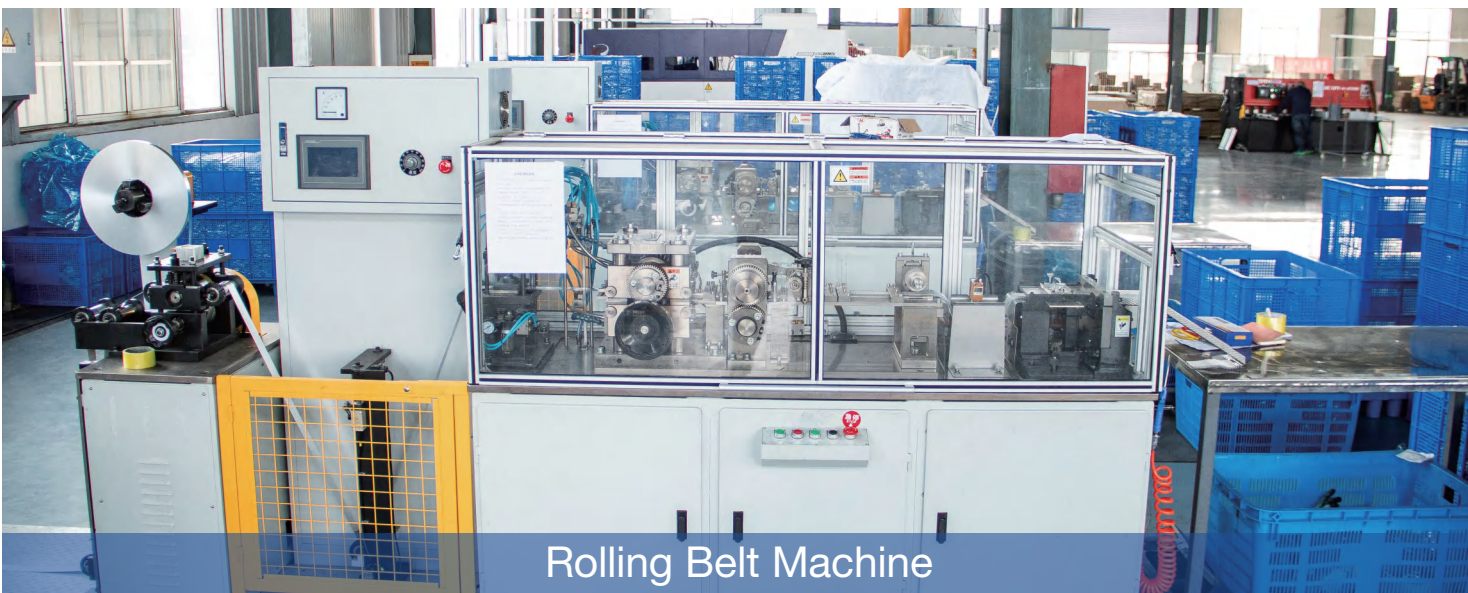

Rolling Belt Machine

# PRODUCTION PROCESS



Laser cutting

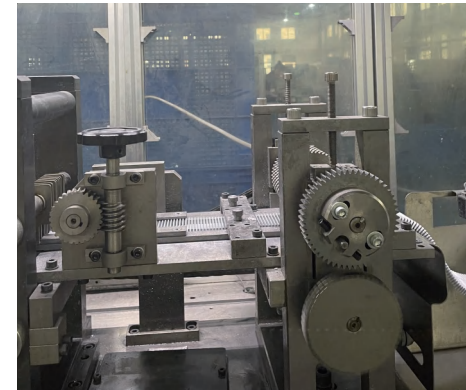

Aluminium Strip Fabrication



Radiator Core Assembly



Welding



Air Tightness Testing



Function Testing



Packaging



Warehouse



Shipment



# MAIN PRODUCTS

01 All-Aluminum Radiator

02 Aluminum-Plastic Radiator

03 Intercooler

04 Shroud & Fan

05 Oil Cooler

06 Intercooler

07 AC Condenser

08 Other Auto Parts



# PRODUCT INTRODUCTION

## HDAL20172DZFS

Material	Aluminum
Row	4 Row Core
Product Size	52*42*19cm
Vehicle Fitment	Honda 1992-2000 Acura1994-2001

Note: More adaptable models can be customised according to your car model and drawings.

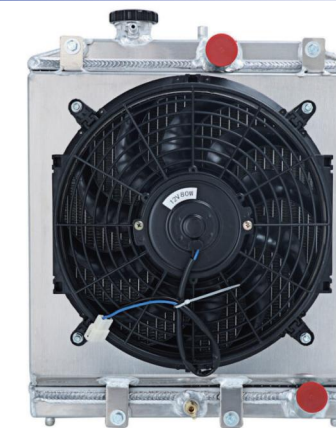

## HDAL20083D



Material	Aluminum
Row	3 Row Core
Product Size	53*35*20cm
Vehicle Fitment	Honda 1991-2002

Note: More adaptable models can be customised according to your car model and drawings.

## HDAL20029DZ

Material	Aluminum
Row	1 Row Core
Product Size	49*38*16cm
Vehicle Fitment	Honda 2001-2006

Note: More adaptable models can be customised according to your car model and drawings.





## HDAL20197DZ

Material	Aluminum
Row	3 Row Core
Product Size	61*61*16cm
Vehicle Fitment	Toyota 1960-1984

Note: More adaptable models can be customised according to your car model and drawings.



## HDAL20198DZFS

Material	Aluminum
Row	4 Row Core
Product Size	92*62*22cm
Vehicle Fitment	Lexus 1998-2006 Toyota 1998-2007

Note: More adaptable models can be customised according to your car model and drawings.

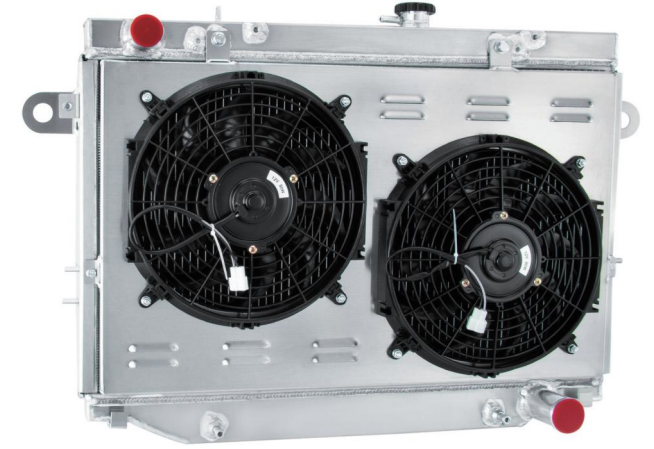

## HDAL20064DZ



Material	Aluminum
Row	4 Row Core
Product Size	87*64.7*20.5cm
Vehicle Fitment	Toyota 1993-1997 Lexus 1996-1997

Note: More adaptable models can be customised according to your car model and drawings.

## HDAL20088DZ



Material	Aluminum
Row	2 Row Core
Product Size	53*35*13.5cm
Vehicle Fitment	Yamaha 1987-2006

Note: More adaptable models can be customised according to your car model and drawings.

## HDAL20199DZ

Material	Aluminum
Row	3 Row Core
Product Size	87*63*19cm
Vehicle Fitment	Toyota 1990-1998

Note: More adaptable models can be customised according to your car model and drawings.

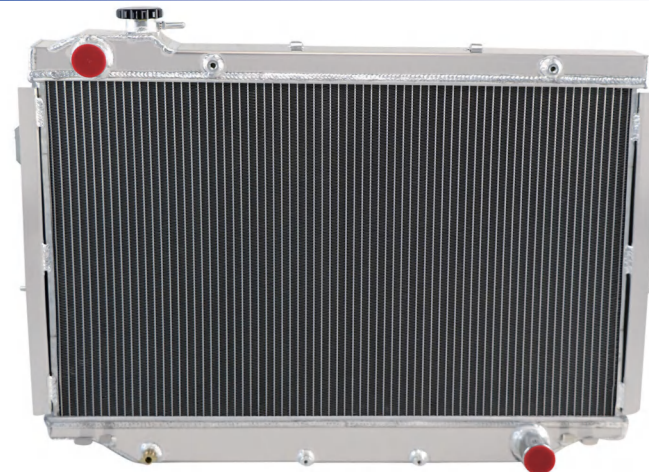

## HDAL20087DZ

Material	Aluminum
Row	1 Row Core
Product Size	47.5*35.5*14cm
Vehicle Fitment	Yamaha 2013-2020

Note: More adaptable models can be customised according to your car model and drawings.





## HDAL20123-DP

Material	Aluminum
Row	3 Row Core
Product Size	97*39*21cm
Vehicle Fitment	Jeep 1987-2001

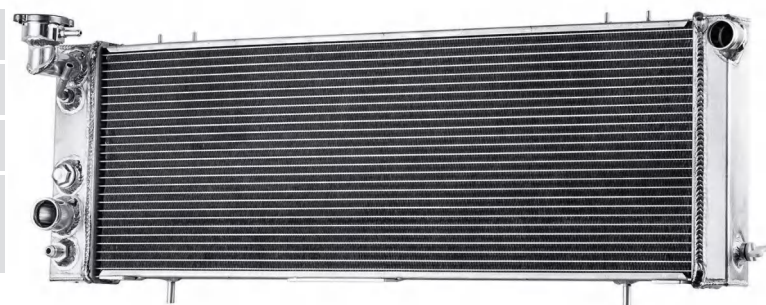

Note: More adaptable models can be customised according to your car model and drawings.

## HDAL20170DZ

Material	Aluminum
Row	3 Row Core
Product Size	120*17*63cm
Vehicle Fitment	Dodge 1994-2002



Note: More adaptable models can be customised according to your car model and drawings.

## HDAL20173DZFS



Material	Aluminum
Row	3 Row Core
Product Size	71.5*22.5*64.5cm
Vehicle Fitment	Jeep 1987-2006

Note: More adaptable models can be customised according to your car model and drawings.

## HDAL20175FSX-DP



Material	Aluminum
Row	3 Row Core
Product Size	92.5*21.5*61.5cm
Vehicle Fitment	Chevrolet 1981-1991 GMC 1973-1991

Note: More adaptable models can be customised according to your car model and drawings.

## HDAL20174DZFS

Material	Aluminum
Row	3 Row Core
Product Size	71*59*23cm
Vehicle Fitment	Ford 1930-1938



Note: More adaptable models can be customised according to your car model and drawings.

## HDAL20072DZFS

Material	Aluminum
Row	3 Row Core
Product Size	94*60*24cm
Vehicle Fitment	Nissan 1987-1997



Note: More adaptable models can be customised according to your car model and drawings.



## HDAL20200

Material	Aluminum, Plastic
Product Size	84*58*15cm
Vehicle Fitment	Kia 2016-2020

Note: More adaptable models can be customised according to your car model and drawings.

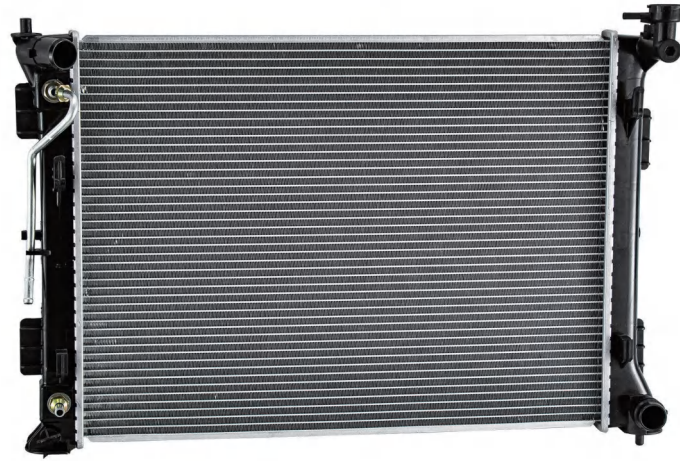

## HDAL20113

Material	Aluminum, Plastic
Product Size	86*53.5*15cm
Vehicle Fitment	Mitsubishi 2008-2014

Note: More adaptable models can be customised according to your car model and drawings.

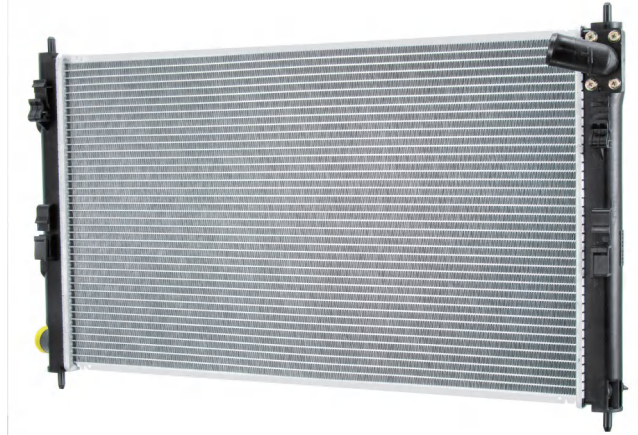

## HDAL20201

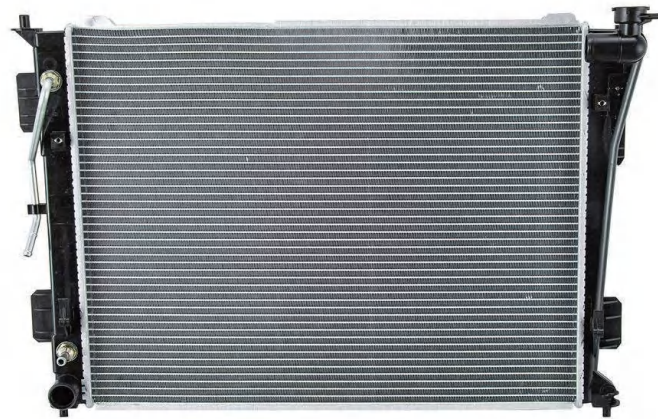

Material	Aluminum, Plastic
Product Size	84*56*17cm
Vehicle Fitment	Hyundai 2011-2017 Kia 2011-2016

Note: More adaptable models can be customised according to your car model and drawings.

## HDAL20202



Material	Aluminum, Plastic
Product Size	81*63*18cm
Vehicle Fitment	Caterpillar Engine CAT C3.3 C4.4

Note: More adaptable models can be customised according to your car model and drawings.

## HDAL20051

Material	Aluminum, Plastic
Product Size	75*53*10cm
Vehicle Fitment	Subaru 2015-2019

Note: More adaptable models can be customised according to your car model and drawings.



## HDAL20203

Material	Aluminum, Plastic
Product Size	83*58*13cm
Vehicle Fitment	Honda 2013-2017 Acura 2015-2020

Note: More adaptable models can be customised according to your car model and drawings.





## HDAL20204

Material	Aluminum, Plastic
Product Size	76*58*20cm
Vehicle Fitment	Jaguar 2003-2011

Note: More adaptable models can be customised according to your car model and drawings.

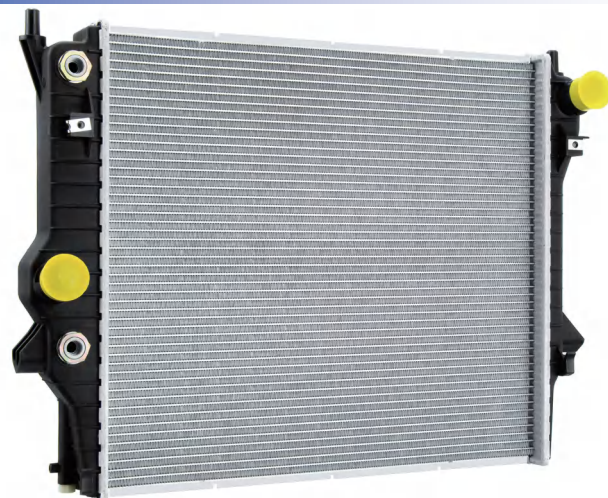

## HDAL20129

Material	Aluminum, Plastic
Product Size	98*62.5*20.5cm
Vehicle Fitment	Ram 2013-2018

Note: More adaptable models can be customised according to your car model and drawings.

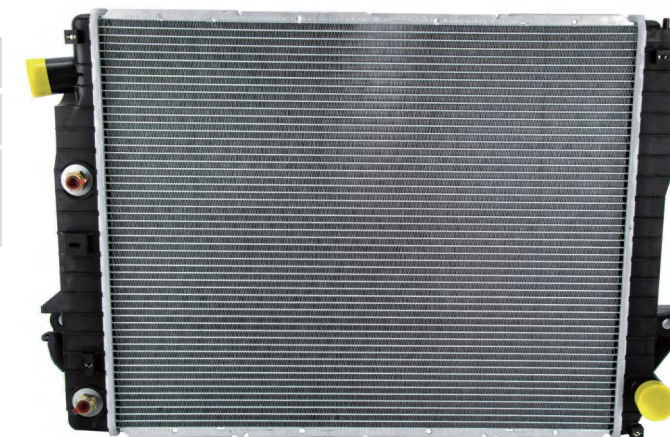

## HDAL20205



Material	Aluminum, Plastic
Product Size	67*56*20cm
Vehicle Fitment	Toyota 1989-2005

Note: More adaptable models can be customised according to your car model and drawings.

## HDAL20125



Material	Aluminum, Plastic
Product Size	114.7*63.2*15.5cm
Vehicle Fitment	Chevrolet 2019-2022 GMC 2019-2022

Note: More adaptable models can be customised according to your car model and drawings.

## HDAL20023

Material	Aluminum, Plastic
Product Size	81.5*68.5*23cm
Vehicle Fitment	Dodge 2004-2009 Chrysler 2007-2009

Note: More adaptable models can be customised according to your car model and drawings.



## HDAL20207

Material	Aluminum, Plastic
Product Size	76.5*54*13.6cm
Vehicle Fitment	Nissan 2007-2013

Note: More adaptable models can be customised according to your car model and drawings.





## HDAL20178B

Material	Aluminum
Product Size	38*27*7cm
Vehicle Fitment	Case IH Tractor DX35 DX40, DX45

Note: More adaptable models can be customised according to your car model and drawings.



## HDAL20209

Material	Aluminum
Product Size	101*17*9cm
Vehicle Fitment	Ford 2015-2017

Note: More adaptable models can be customised according to your car model and drawings.



## HDAL20018D



Material	Aluminum
Product Size	65*20*12cm
Vehicle Fitment	Mazda 1971-1995

Note: More adaptable models can be customised according to your car model and drawings.

## HDAL20210

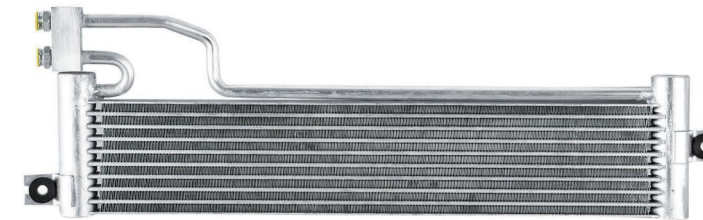

Material	Aluminum
Product Size	69*24*7cm
Vehicle Fitment	Jeep 2014-2021

Note: More adaptable models can be customised according to your car model and drawings.

## HDAL20208

Material	Aluminum
Product Size	91*61*12cm
Vehicle Fitment	Ford 2005-2007

Note: More adaptable models can be customised according to your car model and drawings.



## HDAL20140B

Material	Aluminum
Product Size	54*34*10cm
Vehicle Fitment	Chevrolet 2001-2005 GMC 2001-2005

Note: More adaptable models can be customised according to your car model and drawings.





## HDAL20141

Material	Aluminum
Product Size	70*17*9cm
Vehicle Fitment	Mercedes-Benz 2013-2021



Note: More adaptable models can be customised according to your car model and drawings.

## HDAL20032

Material	Aluminum
Product Size	48*31*16.5cm
Vehicle Fitment	Subaru 2005-2014



Note: More adaptable models can be customised according to your car model and drawings.

## HDAL20143



Material	Aluminum
Product Size	36.5*29*9cm
Vehicle Fitment	Holden 1950-2009 Jeep 1980-2019

Note: More adaptable models can be customised according to your car model and drawings.

## HDAL20047



Material	Aluminum
Product Size	100*38*14cm
Vehicle Fitment	For turbochargers superchargers

Note: More adaptable models can be customised according to your car model and drawings.

## HDAL20144

Material	Aluminum
Product Size	87*82*21cm
Vehicle Fitment	Hitachi EX200-5 Excavator



Note: More adaptable models can be customised according to your car model and drawings.

## HDAL20211

Material	Aluminum
Product Size	73*22*9cm
Vehicle Fitment	Universal

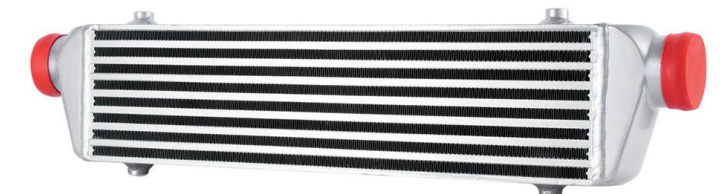

Note: More adaptable models can be customised according to your car model and drawings.



## HDAL20086

Material	Aluminum
Product Size	33*27*17cm
Vehicle Fitment	Polaris 2015-2022

Note: More adaptable models can be customised according to your car model and drawings.



## HDAL20161

Material	Aluminum
Product Size	93*34*20cm
Vehicle Fitment	Land Rover 1998-2016

Note: More adaptable models can be customised according to your car model and drawings.

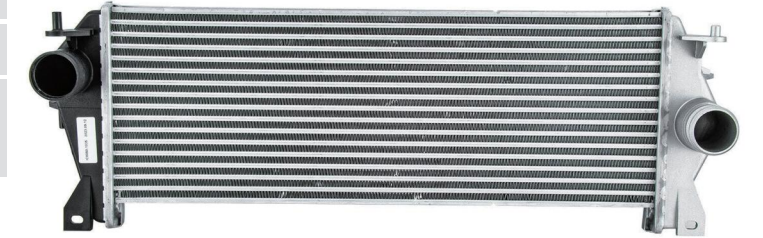

## HDAL20031B



Material	Aluminum
Product Size	83*38*12cm
Vehicle Fitment	Universal

Note: More adaptable models can be customised according to your car model and drawings.

## HDAL20213B



Material	Aluminum
Product Size	39*37*18cm
Vehicle Fitment	Sea-Doo 2016-2022

Note: More adaptable models can be customised according to your car model and drawings.

## HDAL20212B

Material	Aluminum
Product Size	47*29*16cm
Vehicle Fitment	Can-Am 2020-2023

Note: More adaptable models can be customised according to your car model and drawings.



## HDAL20046

Material	Aluminum
Product Size	83*39*13cm
Vehicle Fitment	Universal

Note: More adaptable models can be customised according to your car model and drawings.

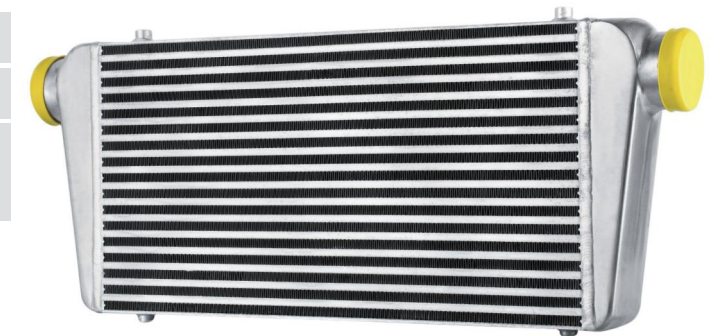



# HDAL20062

Material	Aluminum
Product Size	57*45*9cm
Vehicle Fitment	Vauxhall 2014-2018

Note: More adaptable models can be customised according to your car model and drawings.



# HDAL20215

Material	Aluminum
Product Size	86*54*12cm
Vehicle Fitment	Jaguar 1999-2002

Note: More adaptable models can be customised according to your car model and drawings.

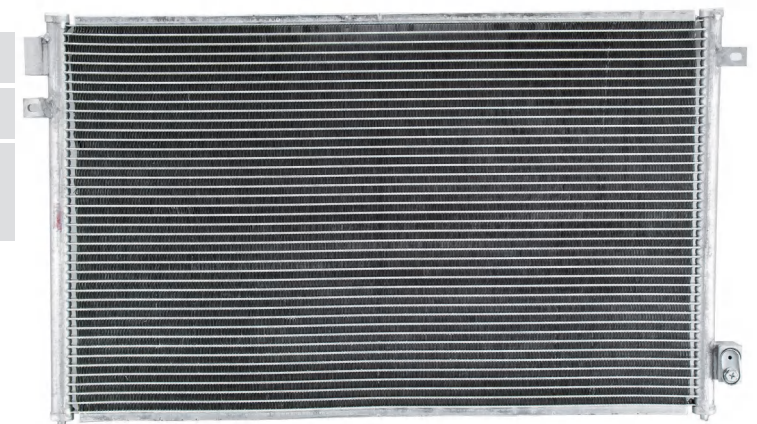

# HDAL20151



Material	Aluminum
Product Size	90.3*85.5*8cm
Vehicle Fitment	Peterbilt 1989-2007

Note: More adaptable models can be customised according to your car model and drawings.

# HDAL20152

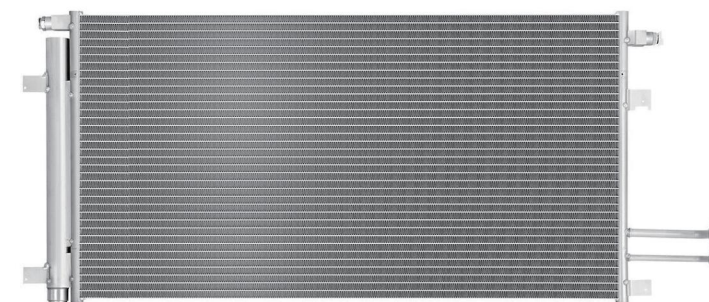

Material	Aluminum
Product Size	110*49*15cm
Vehicle Fitment	Cadillac 2015-2019 Chevrolet 2014-2019

Note: More adaptable models can be customised according to your car model and drawings.

# HDAL20214

Material	Aluminum
Product Size	86*56*6cm
Vehicle Fitment	Honda 2018-2022

Note: More adaptable models can be customised according to your car model and drawings.

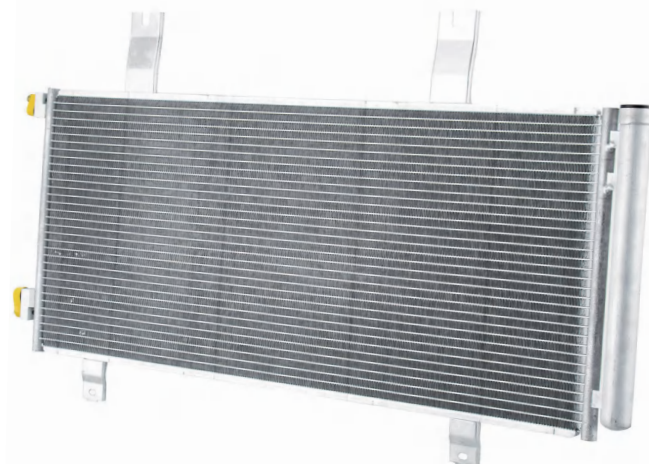

# HDAL20216

Material	Aluminum
Product Size	80*54*8cm
Vehicle Fitment	Nissan 2008-2015

Note: More adaptable models can be customised according to your car model and drawings.

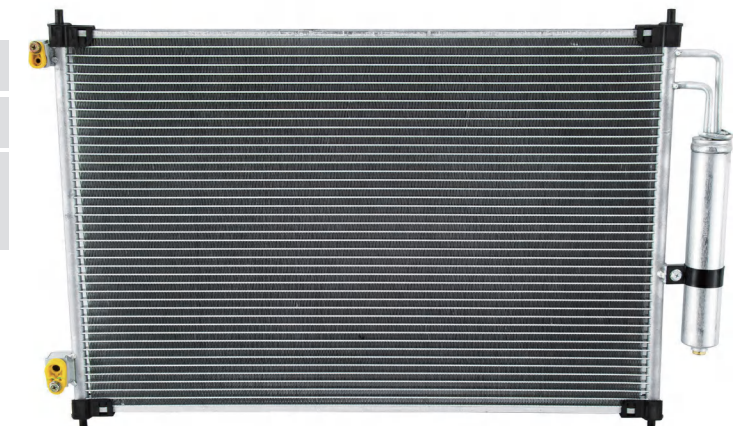



## HDAL20217-DFZ

Material	Aluminum
Product Size	68*42.5*10cm
Vehicle Fitment	Chevrolet 1994-2005 GMC 1994-2004

Note: More adaptable models can be customised according to your car model and drawings.



## HDAL20220-DFZ

Material	Aluminum
Product Size	62*45*13cm
Vehicle Fitment	Toyota 1984-1995

Note: More adaptable models can be customised according to your car model and drawings.



## HDAL20218-DFZ



Material	Aluminum
Product Size	73.2*54.2*12.7cm
Vehicle Fitment	Ford 1985-1997

Note: More adaptable models can be customised according to your car model and drawings.

## HDAL20221-DFZW



Material	Aluminum
Product Size	48*40*18cm
Vehicle Fitment	Acura 1994-2001 Honda 1992-2000

Note: More adaptable models can be customised according to your car model and drawings.

## HDAL20219-DFZ

Material	Aluminum
Product Size	71*42*13cm
Vehicle Fitment	Holden 1971-1980

Note: More adaptable models can be customised according to your car model and drawings.



## HDAL20222-DFZ

Material	Aluminum
Product Size	73*43*11cm
Vehicle Fitment	Chevrolet 1963-1968

Note: More adaptable models can be customised according to your car model and drawings.

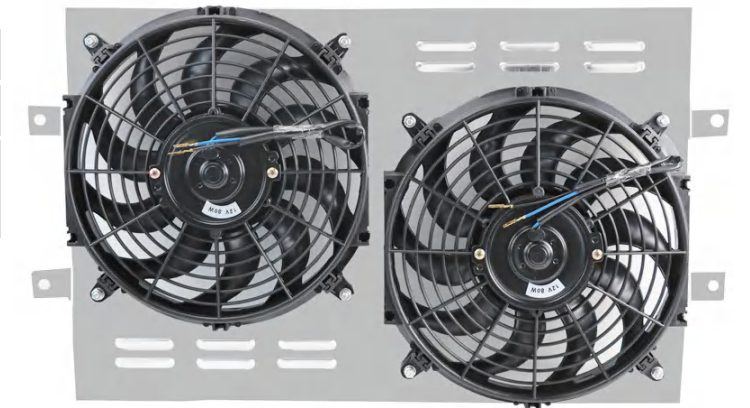



## HDAL20180B



Material	Aluminum
Product Size	30.7*19.8*6.7cm
Vehicle Fitment	Universal

Note: More adaptable models can be customised according to your car model and drawings.

## HDAL20187



Material	Aluminum
Size	6AN to 6AN
Product Size	16*14*3cm
Vehicle Fitment	Universal

Note: More adaptable models can be customised according to your car model and drawings.

## HDAL20223

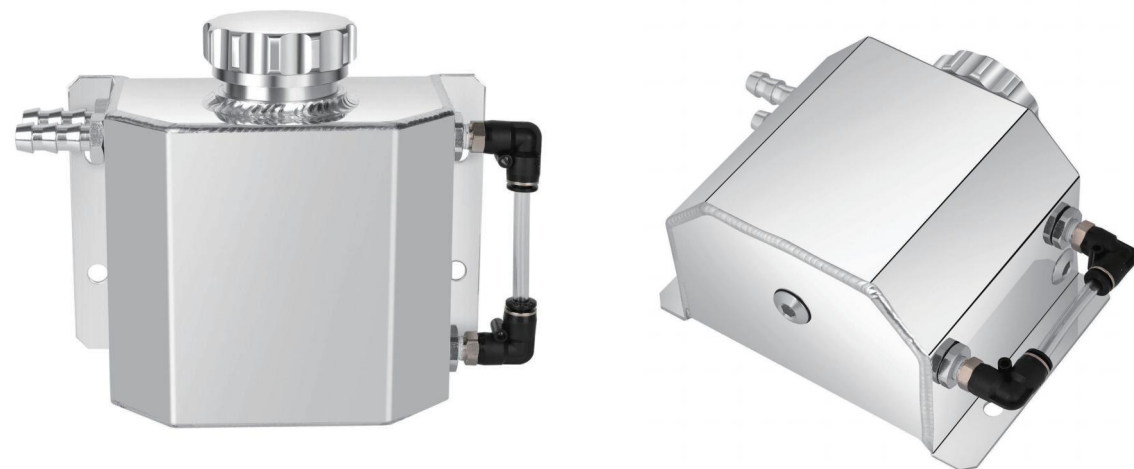

Material	Aluminum
Product Size	23.5*19.3*12cm
Vehicle Fitment	Acura 1990-2001, Honda 1991-2005

Note: More adaptable models can be customised according to your car model and drawings.

## HDAL20183



Material	Aluminum
Size	16 AN to 2x 12AN W/ 1/4 NPT
Product Size	10*10*10cm
Vehicle Fitment	Universal

Note: More adaptable models can be customised according to your car model and drawings.



## HDAL20224



Material	Aluminum
Product Size	19.5*18*14.5cm
Vehicle Fitment	Toyota 1968-1977

Note: More adaptable models can be customised according to your car model and drawings.

## HDAL20225

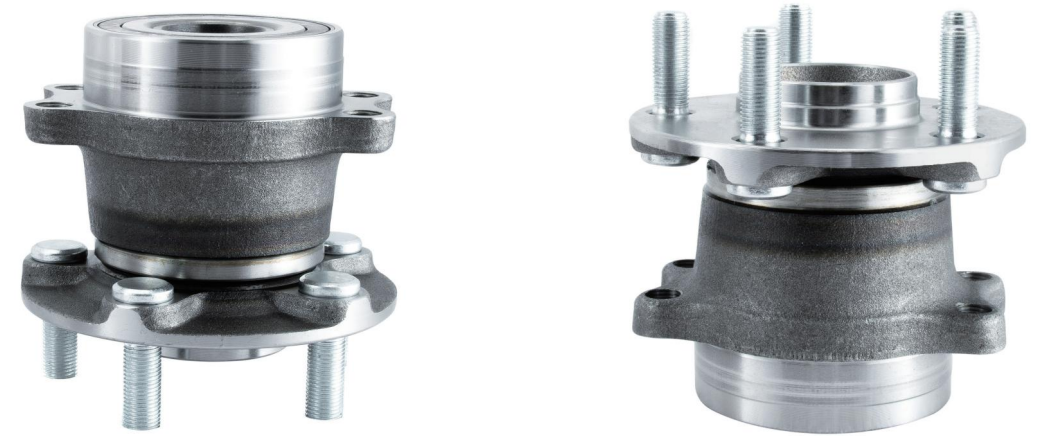

Material	Aluminum
Product Size	17*17*17cm
Vehicle Fitment	Subaru 2012-2020

Note: More adaptable models can be customised according to your car model and drawings.

## HDAL20111



Material	Aluminum
Product Size	19*19*10cm
Vehicle Fitment	Ford 1964-2022

Note: More adaptable models can be customised according to your car model and drawings.

## HDAL20226



Material	Aluminum
Product Size	20*18.5*16cm
Vehicle Fitment	Cadillac 2002-2006 Chevrolet 1999-2013 GMC 1999-2013

Note: More adaptable models can be customised according to your car model and drawings.



## HDAL20014



Material	Aluminum
Product Size	45.6*27.7*18.1cm
Vehicle Fitment	Yamaha 2006-2001

Note: More adaptable models can be customised according to your car model and drawings.

## HDAL20228-RED



Material	Aluminum
Product Size	60*10*7cm
Vehicle Fitment	Jeep 1995-2004

Note: More adaptable models can be customised according to your car model and drawings.

## HDAL20227



Material	Aluminum
Product Size	47*28.8*18.7cm
Vehicle Fitment	Yamaha 2001-2005

Note: More adaptable models can be customised according to your car model and drawings.

## HDAL20227

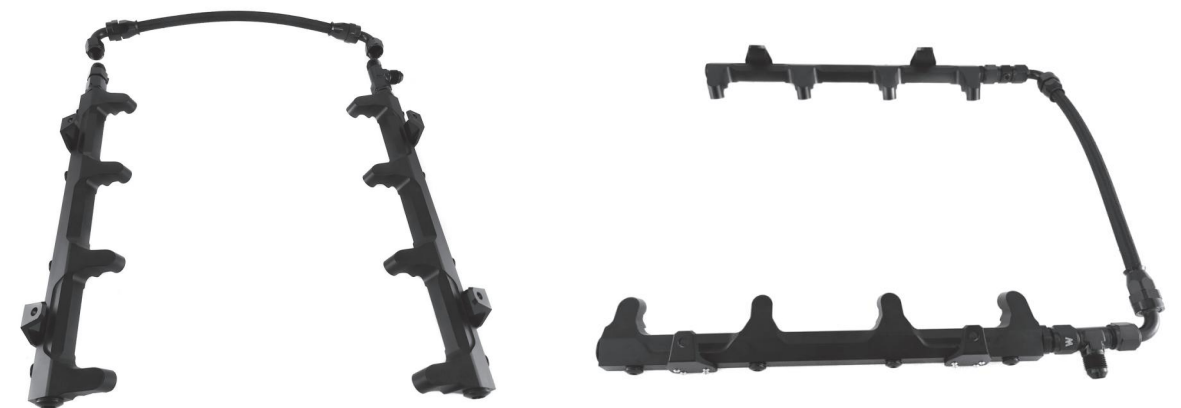

Material	Aluminum
Product Size	47*28.8*18.7cm
Vehicle Fitment	Yamaha 2001-2005

Note: More adaptable models can be customised according to your car model and drawings.



# HDAL20194B



Material	Aluminum
Product Size	92*29*21cm
Vehicle Fitment	Chevrolet 2001-2010 GMC 2001-2010

Note: More adaptable models can be customised according to your car model and drawings.

# CERTIFICATE DISPLAY



# INFLUENCERS REVIEW

# HDAL20195

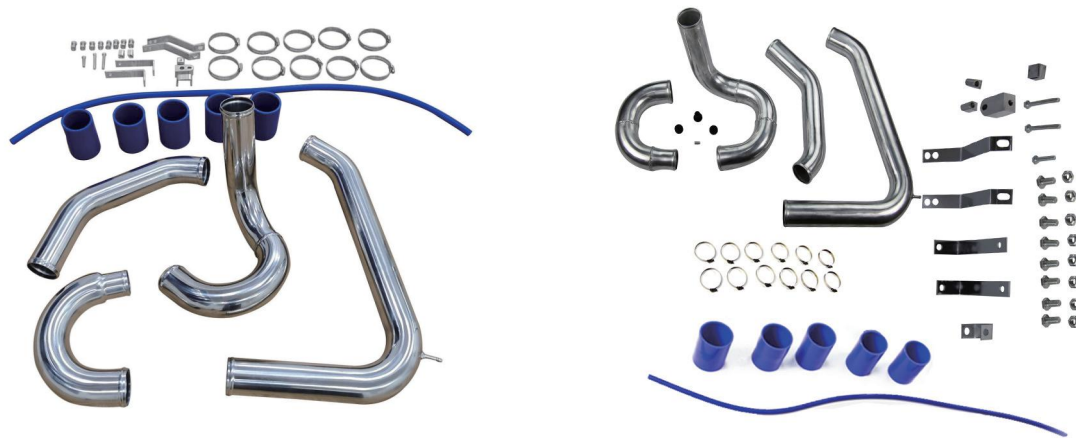

Material	Aluminum,Silica
Product Size	64*37*19cm
Vehicle Fitment	Ford 2002-2008

Note: More adaptable models can be customised according to your car model and drawings.

