

GPS Tracker ST-907

User Manual

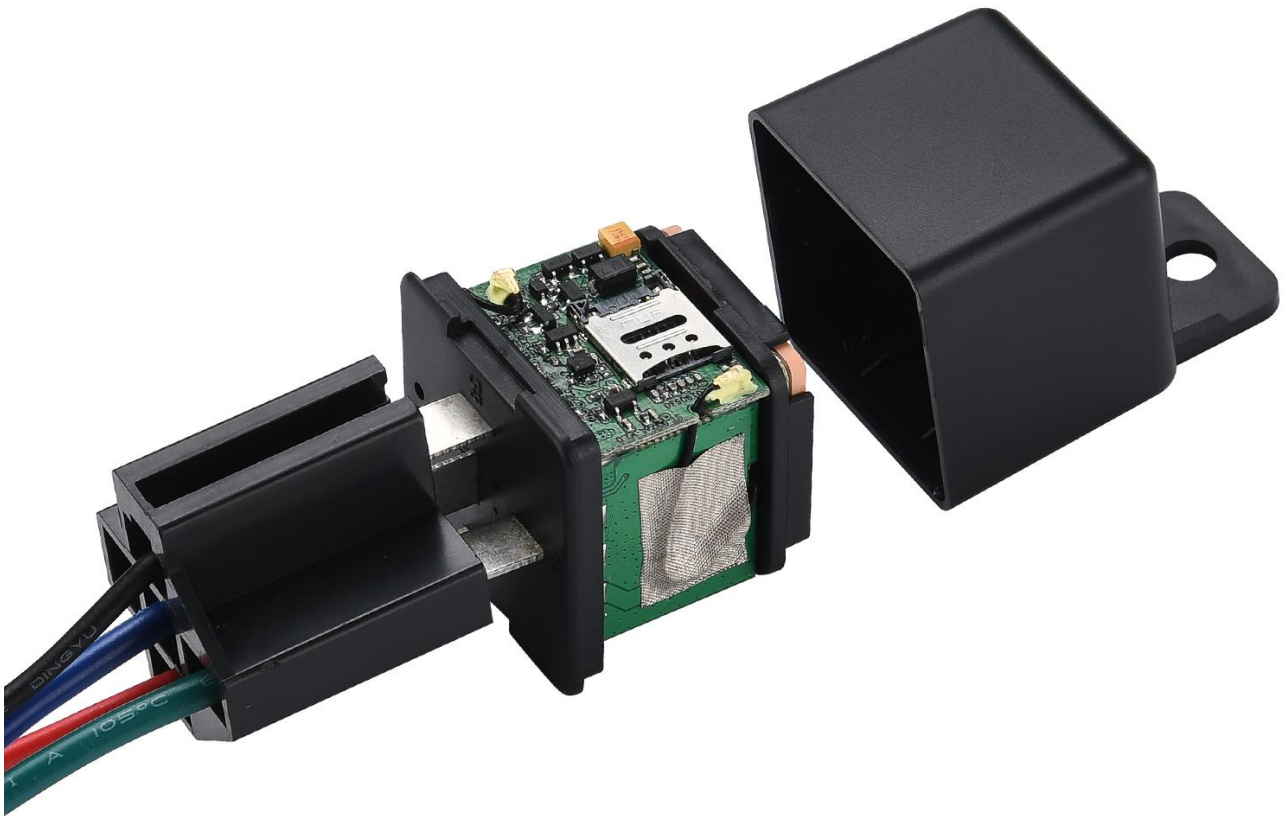

Quick Start

Thank you for purchasing our GPS tracker.
This Quick User shows how to operate the device smoothly and correctly.

WEBSITE Tracking (PC Version):

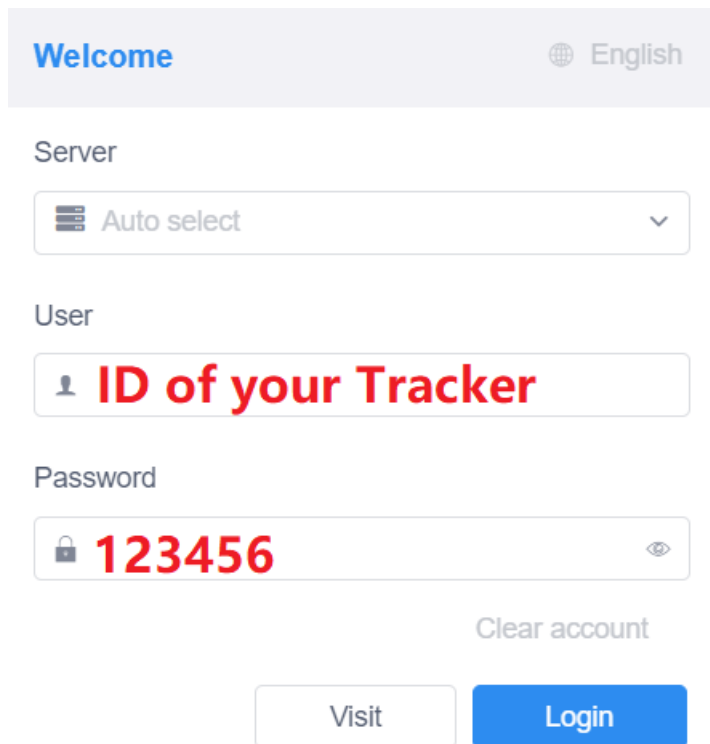

Welcome English

Server
Auto select

User
ID of your Tracker

Password
123456

Clear account

Visit Login

Platform: Pro.SinoTrack.com

User name: ID on the tracker

Password: 123456

APPLICATION Tracking (Mobile APP):

You can search **SinoTrack PRO** on APP Store (iOS) or Google Play (Android)
Or Download from the QR Code:



Server: Pro.SinoTrack
User Name: ID number on tracker
Password: 123456

If you have **more SinoTrack GPS trackers**, and want to manage them in one account, please contact us, we will create an account for you, so you can monitor **multiple devices** on the platform at the same time.

1. Choose GSM card, it should be Normal SIM card, without PIN code.



2. Open the top cover of tracker by screw.

3. Proper insert GSM card, the tracker will start, connect external power supply.

4. Put device outside around 30s, LED lights will keep lighting on stands for device can work normally.

5. Dialing device number, it will hang up and reply tracking message with valid Lon and lat.

6. Please send SMS to tracker to set the APN: (the yellow place is BLANK)

SMS: **8030000|APN**

(APN is Access Point Name of your SIM Card, please check with your SIM Card provider if you don't know it)

If the APN need User name and Password, please send the command:

SMS: **8030000|APN|APNuser|APNpassword**

7. Send SMS to set trackers to our server:

SMS: **8040000|45.112.204.246|8090**

8. If you set ok of all, you can track it online.

If the device is not online, please check device setting, send: **RCONF** to device, It will reply the setting.

1. The APN is correct;

2. The IP and Port is correct;

3. The ID on platform is correct;

4. The device working model, (SMS model or GPRS model)

If you need login account or still have problems or any suggestions,
Please leave message under your order,
Or send email to: sino@sinotrack.com

For order support, you'd better leave message under your order,
It will be fast to solve your problem,
Thanks.

LED Status

1.1. Blue LED--- GPS Status

Status	Meaning
Flashing	No GPS Signal or GPS starting
ON	GPS OK

1.2. Orange LED---GSM Status

Status	Meaning
Flashing	No SIM card or GSM starting
ON	GSM OK

The default password is: 0000

The default mode is normal working

GPS Status: A is get location, V is invalid location.

Alarm mode is on.

Alarm will send to the 3 control number.

Battery from 0% to 100%

Installation:

1. The GPS antenna side should towards to clear sky.
(Can't put under Metal, but Glass and Plastic is ok)

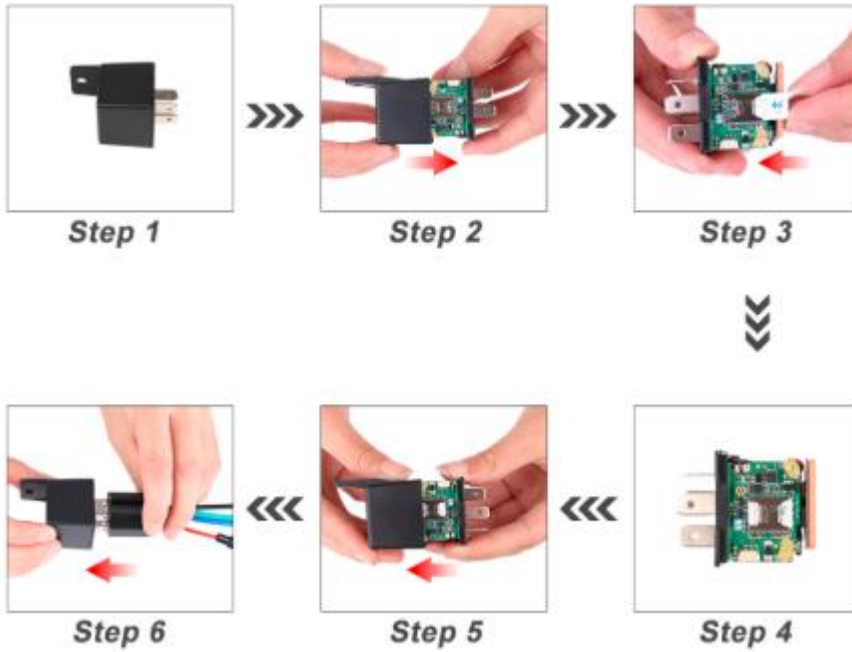

2. Connect the wires:

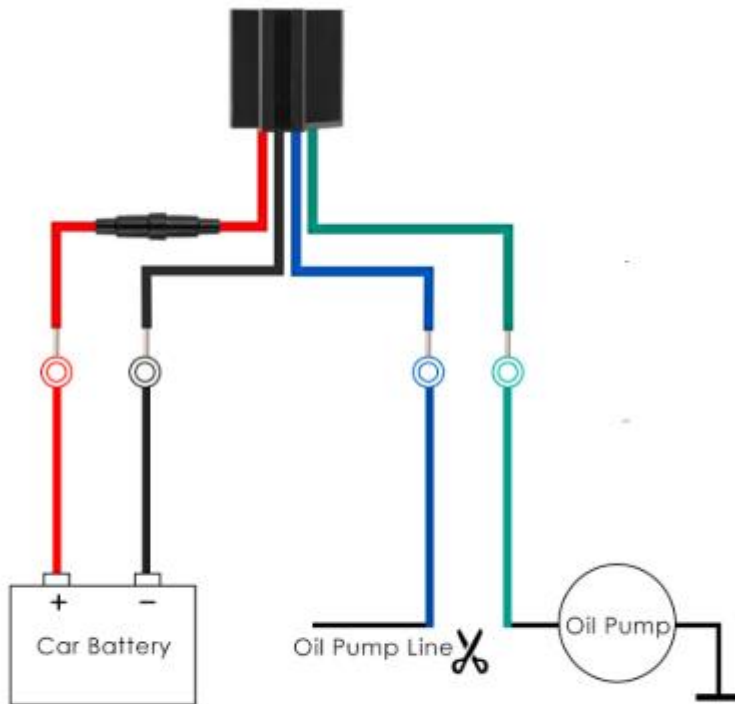

NOTE: Working voltage: 10-40V DC , please find professional repair man or 4S store to install the device!

Functions:

1. Set control number:

For example: you number is +86 13950443465

Sample: **1395044346500001**

+86 is country code, 13950443465 is mobile number, 0000 is password, 1 is serial means the first number.

When the tracker replies "SET OK" means the setting is ok.

You can set the second and third control number also.

2. Working mode:

ST-907 has both SMS and GPRS working mode.

1. If you want to control it by mobile and use SMS only, you can get Google location from you mobile, then you can choose SMS mode.

2. If you want to monitor the tracker online real time, and you want to install the tracker data for years, you should choose the GPRS mode.

You can send SMS to choose the mode.

SMS Mode:

Command: **700+Password**

Sample: **7000000**

Reply: SET OK

When ST-907 receives the command, it will change to SMS mode.

GPRS Mode: (Default)

Command: **710+Password**

Sample: **7100000**

Reply: SET OK

When ST-907 receives the command, it will change to GPRS mode.

3. Change Password

Command: **777+New Password+Old password**

Sample: **77712340000**

The 1234 is new password, and 0000 is old password.

When ST-907 received the command, it will reply SET OK

4. Get location with Google link

Command: **669+password**

Sample: **6690000**

When ST-907 receives the command, it will send back the location with Google link;

You can open the link to check the tracker location on maps.

6690000

[http://maps.google.com/maps?q=
+22.64208,+114.18828](http://maps.google.com/maps?q=) Date:
2016-5-18 Time:13:40 ID:
8160528336 Fix:A Speed:0KM/H Bat:
5

5. Get location by phone call.

You can use any mobile to call the SIM Card in tracker, it will reply the location with Google link; you can open the link to check the tracker location on maps.

[http://maps.google.com/maps?q=
+22.64207,+114.18829](http://maps.google.com/maps?q=) Date:
2016-5-18 Time:13:36 ID:
8160528336 STATE:Phone ACC OFF
Fix:A Speed:0KM/H Bat:5

When you call the tracker when it is in invalid location, it will reply the last valid location to you, after it get new location again, it will send the seconds SMS to you with new location.

6. Change Time Zone

Command: **896+password+E/W+HH**

Sample: **8960000E00 (default)**

E means East, W means west, 00 mean time zone.

Reply: SET OK

0 time zone is 8960000E00

7. Geo Fence (send alarm to the first number only)

Open Geo Fence: **211+password**

Sample: **2110000**

Reply: SET OK

Close Geo Fence: **210+password**

Sample: **2100000**

Reply: SET OK

Set the Geo Fence

Sample: **0050000 1000 (the Geo Fence is 1000 meters)**

Reply SET OK

We suggest the Geo Fence more than 1000 meters.

<http://maps.google.com/maps?q=>
[+22.64207,+114.18829](http://maps.google.com/maps?q=) Date:
2016-5-18 Time:13:36 ID:
8160528336 STATE: OVER FENCE ALARM
Fix:A Speed:0KM/H Bat:5

8. Over speed Alarm (send Alarm to control numbers)

Command: **122+password+Blank+XXX**

Sample: **1220000120**

Reply: SET OK

The XXX is the speed, from 0 to 999, the unit is KM/H.

If the XXX is 0, it means close the over speed alarm.

<http://maps.google.com/maps?q=>
[+22.64207,+114.18829](http://maps.google.com/maps?q=) Date:
2016-5-18 Time:13:36 ID:
8160528336 STATE: OVER SPEED ALARM
Fix:A Speed:0KM/H Bat:5

9. Mileage

Set the initial Mileage

Command: **142+Password<+M+X>**

X is the initial Mileage, the unit is meter.

Sample: **1420000**

Reply: MILEAGE RESET OK

Sample: **1420000M1000**

Reply: SET OK, CURRENT: 1000

Red the current Mileage

Command: **143+password**

Sample: **1430000**

Reply: CURRENT TOTAL MILEAGE:XX.

XX is the mileage, the unit is meter.

10. Shock Alarm (send SMS alarm to the first number)

Open Shock Alarm: **181+password+T**

Sample: **1810000T10**

Reply: SET OK

The T meaning shocking time, the unit is second,

It from 0 to 120 senconds.

Close Shock Alarm: **180+password**

Sample: **1800000**

Reply: SET OK

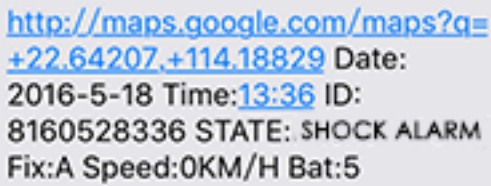

[http://maps.google.com/maps?q=+22.64207,+114.18829](http://maps.google.com/maps?q=) Date:
2016-5-18 Time:13:36 ID:
8160528336 STATE: SHOCK ALARM
Fix:A Speed:0KM/H Bat:5

11. Low battery alarm (send SMS to first number)

When the battery is low, the tracker will send the Low Power Alarm SMS to the first number

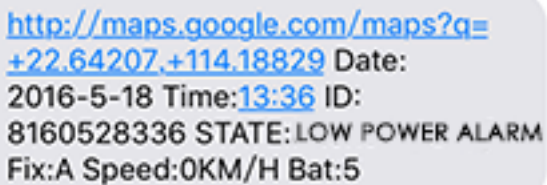

[http://maps.google.com/maps?q=+22.64207,+114.18829](http://maps.google.com/maps?q=) Date:
2016-5-18 Time:13:36 ID:
8160528336 STATE: LOW POWER ALARM
Fix:A Speed:0KM/H Bat:5

When the battery is Full, Bat:5, means 100%; Bat:4 means 80%, Bat:3 means 60%, Bat:2 means 40%, Bat:1 means 20%. When the Bat is 1, it will send low battery alarm.

12. Call mode

Call mode on:

Command: **150+password**

Sample: **1500000**

Reply: SET OK

Call mode off

Command: **151+password**

Sample: **1510000**

Reply: SET OK

When the call mode on, the alarms will call and send SMS to control number,

When the call mode off, only send SMS.

13. Cut Engine remotely

Cut Engine command: 940+password

Sample: 9400000

After tracker receive the command, it will cut engine and send back SMS "SET

OK”

Recover Engine command: 941+password

After tracker receive the command, it will recover engine and send back SMS
“SET OK”

14. Set APN

Command 1: **803+password+Blank+APN**

Sample: **8030000|CMNET**

Reply: SET OK

If your APN need user and pass:

Command 2: **803+password+Blank+ APN+Blank+ APN user+Blank+ APN
pass**

Sample: **8030000|CMNET|CMNET|CMNET**

Reply: SET OK

15. Set the IP and Port

Command: **804+password+Blank+IP+Blank+Port**

Sample: **8040000|45.112.204.246|8090**

Reply: SET OK

16. Set the time interval

(Default is 20 seconds)

Command: **805+password+Blank+T**

Sample: **8050000|20**

Reply: SET OK

T means the time interval, the unit is second,

It from 10 to 18000 seconds,

When T=0 means close GPRS.

The minimum time interval is 10 seconds.

17. Sleep Mode

Command: **SLEEP+password+Blank+T**

Sample: **SLEEP0000|5**

Reply: SET OK

The tracker will sleep when the vehicle stopped for 5 minutes.

SLEEP0000|0

To close the sleep mode, the tracker will work all the time.

Online Track:

Please login from www.SinoTrack.com or <http://45.112.204.246>

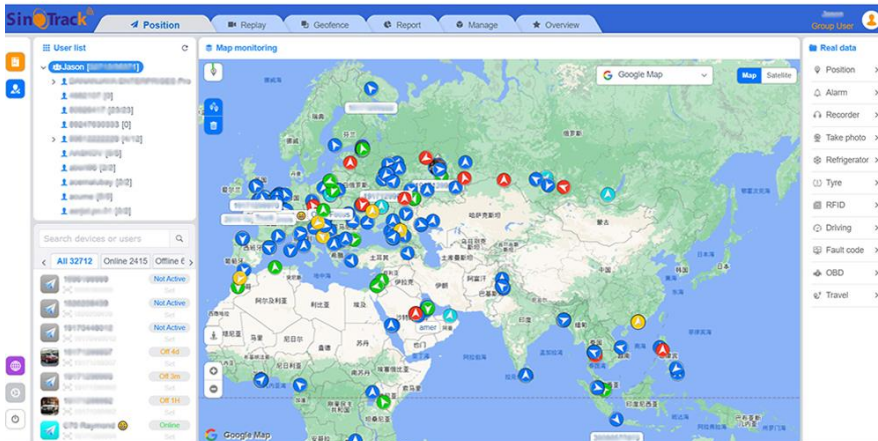
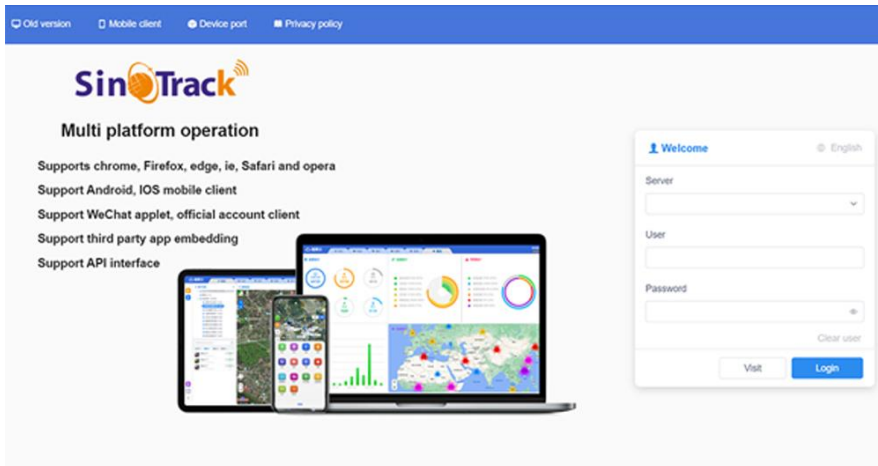

You can also down load our APPS on website to track on your mobile:

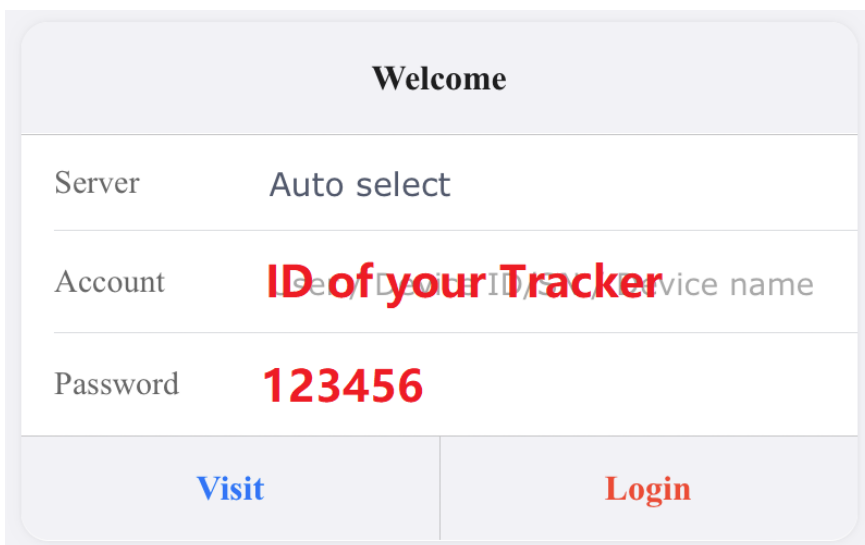

Other Functions:

1. RESTART

The tracker will restart.

2. RCONF

Read the configure of tracker

Tracker will reply:

**ST-907, ID: 8160528336, UP:0000, U1:, U2:, U3:, MODE:GPRS
DAILY:OFF, GEO FENCE: OFF, OVER SPEED:OFF
VOICE:ON, SHAKE
ALARM:OFF, SLEEP:OFF, APN:CMNET,,, IP:45.112.204.246:8090,
GPRS UPLOAD TIME:20
TIME ZONE:E00**

ST-907: software version

ID: 8160528336 (Tracker ID)

UP:0000 (password, default is 0000)

U1: the first control number,

U2: the second control number,

U3: the third control number.

MODE:GPRS (working mode, default is GPRS)

DAILY:OFF (Daily time to report, default off)

GEO FENCE: OFF (Geo Fence, default off)

OVER SPEED:OFF (over speed, default off)

VOICE:ON (Call mode, default on)

SHAKE ALARM:OFF (Shock Alarm, default off)

SLEEP MODE : OFF (sleep mode, default off)

APN:CMNET,,, (APN, default is CMNET)

IP:45.112.204.246:8090 (The IP and Port)

GPRS UPLOAD TIME:20 (time interval)

TIME ZONE:E00 (Time zone, default is +0)