

## 3. Power Supply Modules

### 3.1 General Information

Power supply modules create the voltages required internally by the PLC from the input voltage (24 VDC, 120 VAC or 230 VAC). Each main and expansion unit requires its own power supply module. The power supply module always has to be operated in the far left slot of the backplane. All power supply modules require two slots.

#### 3.1.1 Overview

Power Supply	Input Voltage	Output Power	Interface for System Expansions
PS465	24 VDC	Max. 60 W	Expansion Slot
PS477		Max. 58.5 W	Expansion Slave
PS692	120 VAC	Max. 48.5 W	Expansion Slave
PS694		Max. 50 W	Expansion Slot
PS792	230 VAC	Max. 48.5 W	Expansion Slave
PS794		Max. 50 W	Expansion Slot

Table 28: Power supply module overview

#### 3.1.2 Slots



**The power supply must always be located on the far left slot.**

When configuring a system, make sure that the power consumption of all modules installed is not larger than the output power of the power supply module. If a power supply cannot provide the power required by the modules, install the I/O modules on an expansion backplane.

#### 3.1.3 Current Limitation

Power supply modules are equipped with an internal current limit (short circuit protection) and have connections for an external buffer voltage (AC240 battery module). The current limitation is also activated if the modules require more power than the power supply can deliver. This causes a reset on the CPU before the current is too low.

3.1.4 10 Pin Terminal Block

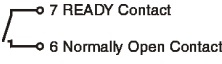
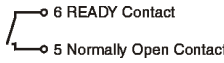
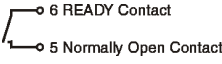
Connection	PS465, PS477	PS692, PS694
	10	External buffer + <sup>1)</sup>
9	External buffer - <sup>1)</sup>	External buffer - <sup>1)</sup>
8	—	---
7		Reserved
6 <sup>2)</sup>		
5 <sup>2)</sup>	+24V	
4	—	Phase L: 120 VAC
3	—	Neutral N: 120 VAC
2	GND	---
1	Ground	Protective Ground Conductor
Connection	PS792, PS794	
10	External buffer + <sup>1)</sup>	
9	External buffer - <sup>1)</sup>	
8	—	
7	Reserved	
6		
5 <sup>2)</sup>		
4	Phase L: 230 VAC	
3	Neutral N: 230 VAC	
2	—	
1	Protective Ground Conductor	

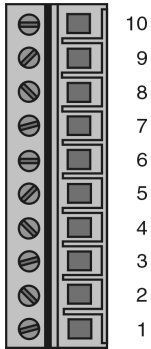

Table 29: Power supply modules 10 pin terminal blocks

- 1) With PS477, PS692 and PS792 power supply modules, these connections are only valid when used in a main rack.
  - 2) Contacts for the READY relay when the PLC is not under power.
- L: Phase  
N: Neutral

### 3.1.5 READY Relay

If a reset occurs, the ready relay reacts to a loss in current by stopping the entire PLC through the programming system. It can be set or reset by the operating system. Errors that cause the relay to open are defined in the operating system.

It is also possible using software to define other errors that should cause a drop in the ready relay. The ready relay is coupled with the status LED "RUN" on the CPU.



**The READY relay is controlled by the CPU, therefore the pin assignments listed for the power supplies PS477, PS692 and PS792 are only valid for use in a main backplane.**

Wiring the ready relay is carried out using the 10 pin terminal block. The ready relay contact can be integrated in the emergency stop circuit:

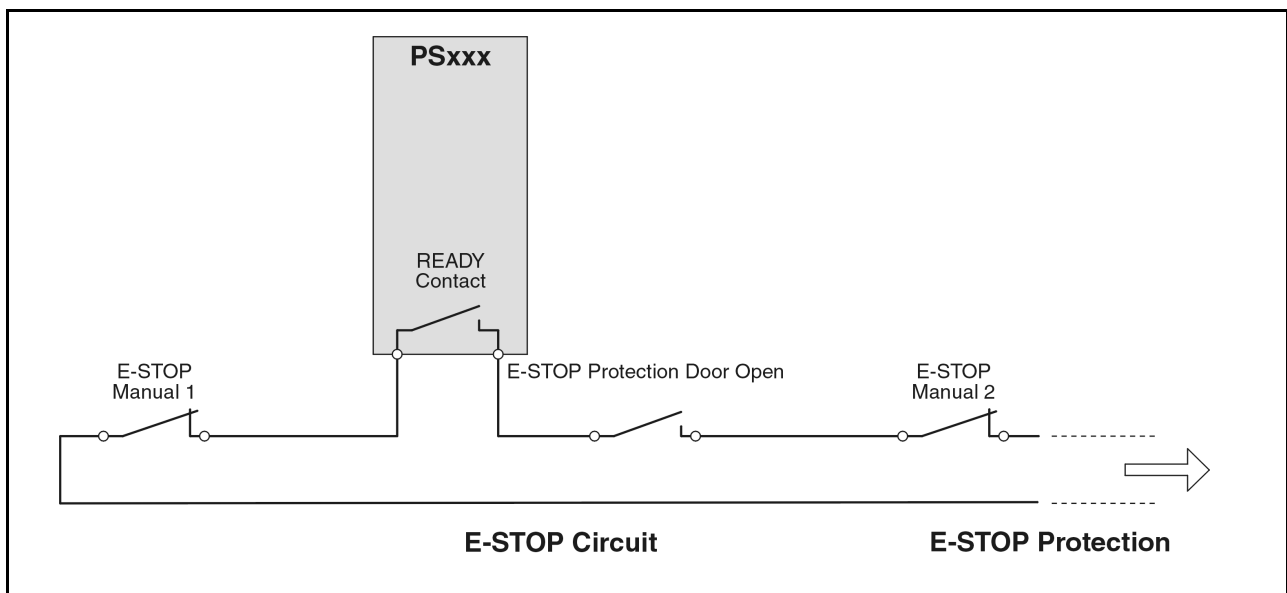

Figure 48: Power Supply READY Relay

### 3.1.6 LED Displays

Power supply modules have LED displays which indicate specific operational states:

LED Name	Function
DC1	Control LED for 5 V voltage supply.
DC2	Control LED for 24 V voltage supply.
DC3	Control LED for 11 V voltage supply.
	If one of the DCn LEDs is not lit, it means the internal voltage is not within the valid range. This can be caused by an overload or the input voltage has slipped under the required minimum range.
DC 24V	The connected 24 VDC input voltage is OK.
AC	The connected AC input voltage is OK.

Table 30: Power supply modules operational states

The following table contains an overview of the LEDs the power supply modules are equipped with.

LED Name	PS465	PS477	PS692	PS694	PS792	PS794
DC1	•	•	•	•	•	•
DC2	•	•	•	•	•	•
DC3	•	•				
DC 24V	•	•				
AC			•	•	•	•

Table 31: Power supply modules LED overview

### 3.1.7 Fuses

The power supply is equipped with a fuse which protects it from reverse polarity and overload. The compartment for the fuse is located behind the module door.

	Module	Glass Tube Fuse 5 * 20 mm
	PS4xx	6.3 A time lag / 250 V
	PS6xx	1.6 A time lag / 250 V
	PS7xx	1.6 A time lag / 250 V

Table 32: Fuses for the power supply modules



**Before changing the fuse, the power supply must be disconnected.**

#### Procedure when Changing a Fuse

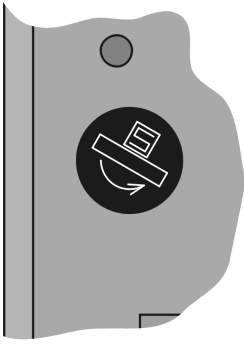
- 1) Disconnect the power supply.
- 2) Touch the mounting rail or ground connection (not the power supply!) in order to discharge any electrostatic charge from your body.
- 3) Open the module door.
- 4) Loosen fuse holder by turning with a screwdriver in the direction shown by the arrow
- 5) Remove the fuse holder.
- 6) Remove the old fuse from the fuse holder.
- 7) Place the new fuse in the fuse holder.
- 8) Replace fuse holder in the power supply module.
- 9) Tighten fuse holder by turning with a screwdriver in the opposite direction as shown by the arrow
- 10) Close the module door.
- 11) Connect the lines to the power supply.

### 3.1.8 Expansion Slot

Power supply modules PS465, PS694, PS754 and PS794 have an expansion slot. The XP152 CPU e.g. can be placed in this expansion slot.

### 3.1.9 Expansion Slave (local expansion)

An expansion slave is integrated into PS477, PS692 and PS792 power supply modules which allows another I/O bus segment to be started (see Chapter 2 "Installation", Section 2 "System Configuration and Power Supply", on page 50).

Interfaces for bus expansion are located behind the module door:

- Interface 1 (expansion slave IN) is connected with the EX350 I/O master controller or with interface 2 of a PS477, PS692 or PS792 power supply module.
- Interface 2 (expansion slave OUT) is connected with interface 1 of another PS477, PS692 or PS792 power supply module.

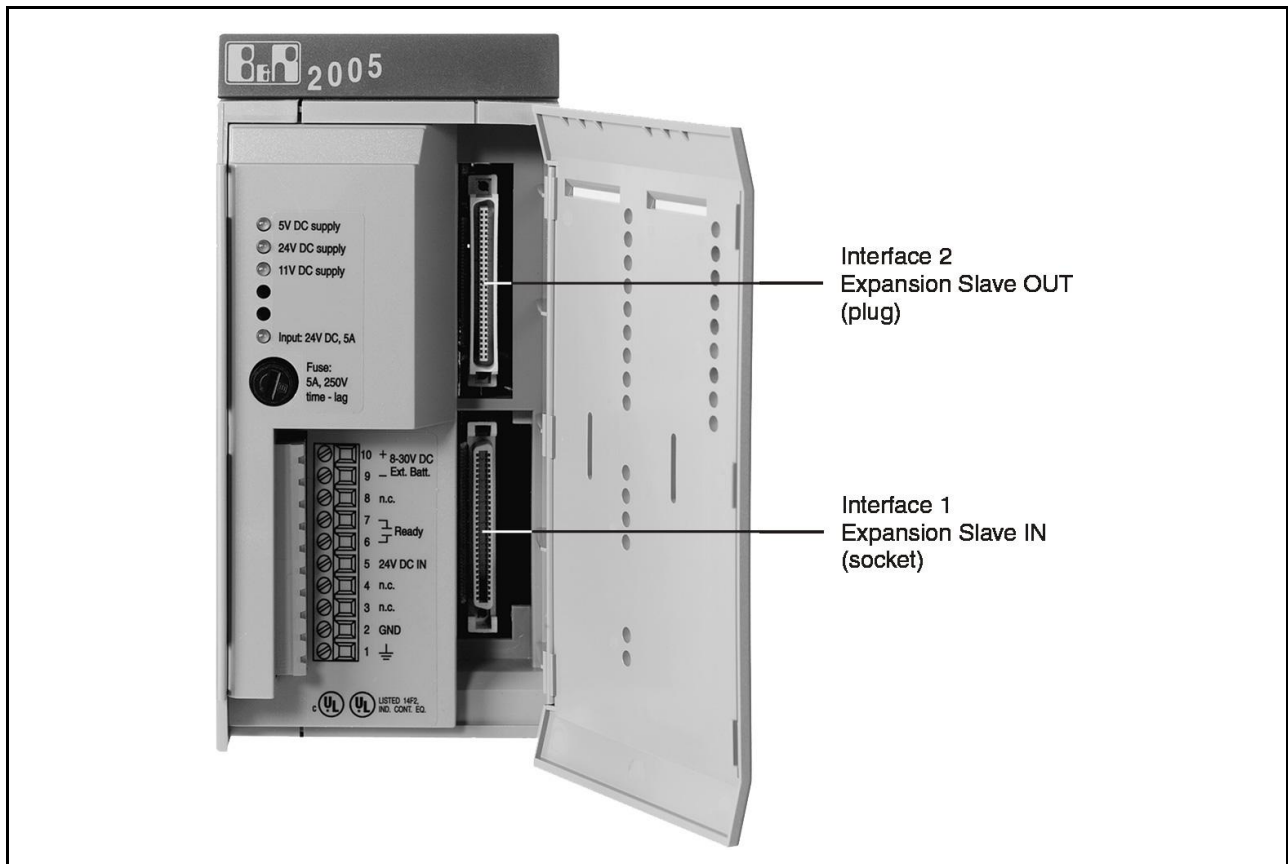

Figure 49: Power supply module interfaces for expansion slaves

### **3.1.10 Remote Slave (remote expansion)**

The remote slave EX250 can be inserted in the expansion slot on power supply modules PS465, PS694 and PS794. The remote slave can be connected to the remote master bus cable on 2005 or 2010 systems.

With remote expansion (remote I/O), the expansion unit (remote slave) can be up to 1200 m away from the main unit (remote master). With a repeater, the network can be extended even further. Without a repeater, a maximum of 31 remote slaves can be connected to a remote master.

### 3.2 PS465 / PS477

#### 3.2.1 Order Data

Model Number	Short Description	Image
<b>Power Supply Modules</b>		
3PS465.9	2005 power supply module, 24 VDC, 50 W, with expansion slot	
3PS477.9	2005 power supply module, 24 VDC, 50 W, with expansion slave	
<b>Accessories</b>		
0G0010.00-090	Cable I/O bus expansion, 1 m, bus expansion for B&R 2005 / B&R 2010	
0G0012.00-090	Cable I/O bus expansion, 2 m, bus expansion for B&R 2005 / B&R 2010	

Table 33: PS465 / PS477 order data

#### 3.2.2 Technical Data

Product ID	PS465	PS477
C-UL-US Listed	Yes	
Input Voltage		
Minimum	18 VDC	
Nominal	24 VDC	
Maximum	30 VDC	
External Backup Capacitor		
For Single Phase Bridge	10000 µF	
For Three Phase Bridge	6000 µF	
Output Power		
5 V	Max. 40 W	Max. 40 W
24 V	Max. 50 W	Max. 50 W
Total	Max. 60 W	Max. 58.5 W
Current Requirements	Max. 3.5 A	
Input Capacitance	500 µF	

Table 34: PS465 / PS477 technical data

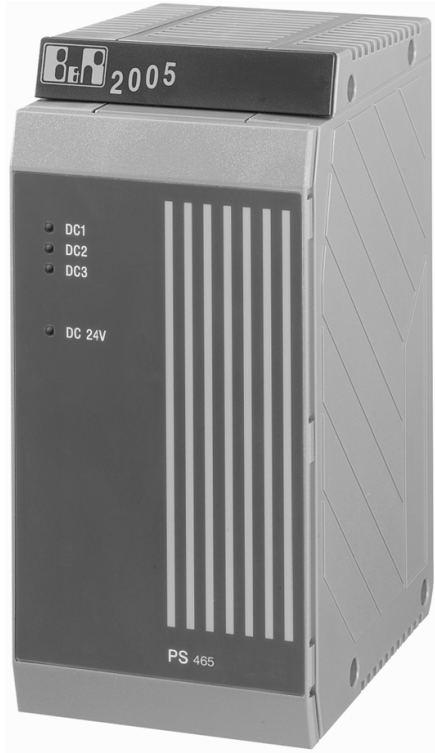
**B&R 2005 Modules • Power Supply Modules • PS465 / PS477**

<b>Product ID</b>	<b>PS465</b>	<b>PS477</b>
Fuse	6.3 A time lag / 250 V	
Expansion Slave	No	Yes
Expansion Slot	Yes	No
External RAM Buffering by Supplying	12 V (min. 8 V / max. 30 V)	
Contact for READY Relay Design Switching Voltage Switching Current Protection	Normally open Max. 30 VDC Max. 3 A 370 V transient voltage protection diode to ground	
Dimensions	B&R 2005 double width	

Table 34: PS465 / PS477 technical data (cont.)

### 3.3 PS692 / PS694

#### 3.3.1 Order Data

Model Number	Short Description	Image
<b>Power Supply Modules</b>		
3PS692.9	2005 power supply module, 120 VAC, 45 W, with expansion slave	
3PS694.9	2005 power supply module, 120 VAC, 45 W, with expansion slot	
<b>Accessories</b>		
0G0010.00-090	Cable I/O bus expansion, 1 m, bus expansion for B&R 2005 / B&R 2010	
0G0012.00-090	Cable I/O bus expansion, 2 m, bus expansion for B&R 2005 / B&R 2010	

Table 35: PS692 / PS694 order data

#### 3.3.2 Technical Data

Product ID	PS692	PS694
C-UL-US Listed	Yes	
Input Voltage		
Minimum	92 VAC	
Nominal	120 VAC	
Maximum	133 VAC	
Input Voltage Frequency	47 to 63 Hz	
Overvoltage		
Peak Value	< 500 V	
Half-peak Duration	<10 ms (non-periodic)	
Output Power		
5 V	Max. 26 W	Max. 26 W
24 V	Max. 48 W	Max. 48 W
Total	Max. 48.5 W	Max. 50 W
Current Requirements	Max. 0.8 A	

Table 36: PS692 / PS694 technical data

**B&R 2005 Modules • Power Supply Modules • PS692 / PS694**

<b>Product ID</b>	<b>PS692</b>	<b>PS694</b>
Fuse	1.6 A time lag / 250 V	
Expansion Slave	Yes	No
Expansion Slot	No	Yes
External RAM Buffering by Supplying	12 V (min. 8 V / max. 30 V)	
Contact for READY Relay Design Switching Voltage Switching Current Protection	Normally open Max. 270 VAC / 30 VDC Max. 3 A 780 V VDR internal	
Dimensions	B&R 2005 double width	

Table 36: PS692 / PS694 technical data (cont.)

### 3.4 PS792 / PS794

#### 3.4.1 Order Data

Model Number	Short Description	Image
<b>Power Supply Modules</b>		
3PS792.9	2005 power supply module, 230 VAC, 45 W, with expansion slave	
3PS794.9	2005 power supply module, 230 VAC, 45 W, with expansion slot	
<b>Accessories</b>		
0G0010.00-090	Cable I/O bus expansion, 1 m, bus expansion for B&R 2005 / B&R 2010	
0G0012.00-090	Cable I/O bus expansion, 2 m, bus expansion for B&R 2005 / B&R 2010	

Table 37: PS792 / PS794 order data

#### 3.4.2 Technical Data

Product ID	PS792	PS794
C-UL-US Listed	Yes	
Input Voltage		
Minimum	187 VAC	
Nominal	230 VAC	
Maximum	265 VAC	
Input Voltage Frequency	47 to 63 Hz	
Overvoltage		
Peak Value	< 500 V	
Half-peak Duration	<10 ms (non-periodic)	
Output Power		
5 V	Max. 26 W	Max. 26 W
24 V	Max. 48 W	Max. 48 W
Total	Max. 48.5 W	Max. 50 W
Current Requirements	Max. 0.4 A	

Table 38: PS792 / PS794 technical data

**B&R 2005 Modules • Power Supply Modules • PS792 / PS794**

<b>Product ID</b>	<b>PS792</b>	<b>PS794</b>
Fuse	1.6 A time lag / 250 V	
Expansion Slave	Yes	No
Expansion Slot	No	Yes
External RAM Buffering by Supplying	12 V (min. 8 V / max. 30 V)	
Contact for READY Relay Design Switching Voltage Switching Current Protection	Normally open Max. 270 VAC / 30 VDC Max. 3 A 780 V VDR internal	
Dimensions	B&R 2005 double width	

Table 38: PS792 / PS794 technical data (cont.)