

# 3300 XL 11 mm Proximity Transducer System

## Datasheet

Cordant™

146256 Rev. T

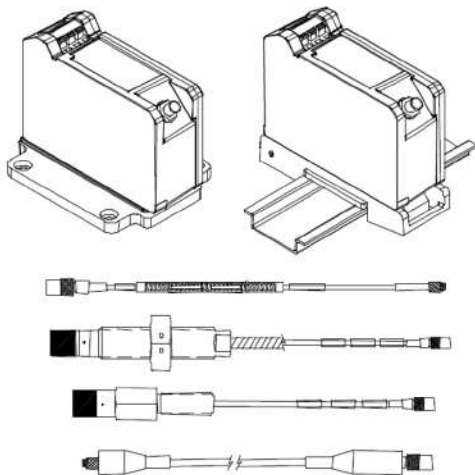

## Description

### Transducer System

The Bently Nevada™ 3300 XL 11 mm Proximity Transducer System consists of:

- 3300 XL 11 mm probe
- 3300 XL 11 mm extension cable
- 3300 XL 11 mm Proximator Sensor<sup>1</sup>

The 3300 XL 11 mm Proximity Transducer System has a 3.94 V/mm (100 mV/mil) output for non-contacting vibration and displacement measurements on fluid film bearing machines. The large 11 mm tip enables this transducer system to have a longer linear range compared to our standard 3300 XL 8 mm Transducer System. It is primarily used in the following applications where the longer linear range is necessary:

- Axial (thrust) position measurements
- Ramp differential expansion measurements on steam turbines
- Rod position or rod drop measurements on reciprocating compressors
- Tachometer and zero speed measurements
- Phase reference (Keyphasor) signals

The 3300 XL 11 mm Proximator Sensor is designed to replace the 7200-series 11 mm and 14 mm Transducer Systems. When upgrading from the 7200-series system to the 3300 XL 11 mm system, every component must be replaced with 3300 XL 11 mm components. In addition, the monitoring system must be updated. If using a 3500 Monitoring System, an updated version of the configuration software that lists the 3300 XL 11 mm Transducer System as a compatible option is required.



Existing 3300 Monitoring Systems may need a modification. Contact your local sales and service representative for assistance.



The 3300 XL 11 mm Proximity Transducer is designed for measuring position or vibration within a frequency range of 0 to 8 kHz. Typical applications of this system include radial vibration and position, axial position and Keyphasor measurements.

Although the terminals and connector on the Proximitor sensor have protection against electrostatic discharge, take reasonable precautions to avoid electrostatic discharge during handling.

## Proximitor Sensor

The 3300 XL 11 mm Proximitor Sensor has the same advanced features found in the 3300 XL 8 mm Proximitor Sensor. Its thin design allows it to be mounted in either a high-density DIN-rail installation or a more traditional panel mount configuration. Improved RFI/EMI immunity allows the 3300 XL Proximitor Sensor to achieve European CE mark approvals without any special mounting considerations. This RFI immunity also prevents the transducer system from being adversely affected by nearby high frequency radio signals. SpringLoc terminal strips on the Proximitor Sensor require no special installation tools and facilitate faster, highly robust field wiring connections.

## Proximity Probe and Extension Cable

The 3300 XL 11 mm probe comes in varying probe case configurations, including armored and unarmored  $\frac{1}{2}$ -20,  $\frac{5}{8}$ -18, M14 X 1.5 and M16 X 1.5 probe threads. The reverse mount 3300 XL 11 mm probe comes standard with either  $\frac{3}{8}$ -24 or M10 X 1 threads. All components of the transducer system have gold-plated brass ClickLoc connectors. ClickLoc connectors lock into place, preventing the connection from becoming loose. The patented TipLoc molding method provides a robust bond between the probe tip and the probe body. The probe cable

is securely attached to the probe tip utilizing our patented CableLoc design that provides 330 N (75 lb) pull strength.

3300 XL Probes and Extension Cables can also be ordered with a FluidLoc cable option. This option prevents oil and other liquids from leaking out of the machine through the cable's interior. The connector protector option provides additional protection of the connectors in a humid or moist environment. Connector protectors are recommended for all installations and provide increased environmental protection<sup>2</sup>. Additionally, the 3300 XL 11 mm probe comes standard with a locknut with pre-drilled safety wire holes.

Notes:

1. Proximitor Sensors are supplied by default from the factory calibrated to AISI 4140 steel. Calibration to other target materials is available upon request.
2. Silicone tape is also provided with each 3300 XL extension cable and can be used instead of connector protectors. Silicone tape is not recommended in applications where the probe-to-extension cable connection will be exposed to turbine oil.

## Specifications

Unless otherwise noted, the following specifications are for a 3300 XL 11 mm Proximitor Sensor, extension cable and probe between 0°C and +45°C (+32°F to +113°F) at a maximum altitude of 2000m, with a -24 Vdc power supply, a 10 kΩ load, our supplied AISI 4140 steel target that is 31 mm (1.2 in) diameter or larger, and a probe gap of 2.5 mm (100 mils). The system accuracy and interchangeability specifications do not apply when using a transducer system calibrated to any target other than our AISI 4140 steel target.

## Electrical

| Proximitor Sensor   |  |
|---------------------|--|
| Input               | Accepts one non-contacting 3300 XL 11 mm Proximity Probe and Extension Cable.  |
| Power               | Requires -17.5 Vdc to -26 Vdc without barriers at 12 mA maximum consumption, -23 Vdc to -26 Vdc with barriers. Operation at a more positive voltage than -23.5 Vdc can result in reduced linear range. |
| Supply Sensitivity  | Less than 2 mV change in output voltage per volt change in input voltage.  |
| Output resistance   | 50 Ω   |
| Probe dc Resistance |  |
| Probe Length (m)    | Resistance from the Center Conductor to the Outer Conductor ( $R_{PROBE}$ ) (ohms)   |
| 1.0                 | 5.9 ± 0.5  |
| 5.0                 | 7.2 ± 0.8  |
| 9.0                 | 8.5 ± 1.1  |

| Extension Cable dc Resistance |  |   |
|-------------------------------|--|---|
| Length of Extension Cable (m) | Resistance from Center Conductor to Center Conductor ( $R_{CORE}$ ) (ohms) | Resistance from Coaxial Conductor to Coaxial Conductor ( $R_{JACKET}$ ) (ohms)  |
| 4.0                           | 1.0 ± 0.25   | 0.3 ± 0.1   |
| 8.0                           | 2.0 ± 0.5  | 0.6 ± 0.2   |
| Extension cable capacitance   |  | 69.9 pF/m (21.3 pF/ft) typical  |
| Field wiring                  |  | 0.2 to 1.5 mm <sup>2</sup> (16 to 24 AWG) [0.25 to 0.75 mm <sup>2</sup> (18 to 23 AWG) with ferrules]. Recommend using three-conductor shielded triad cable. Maximum length of 305 meters (1,000 feet) between the 3300 XL Proximitor Sensor and the monitor. See the frequency response graph for signal rolloff at high frequencies when using longer field wiring lengths. |
| Linear Range                  |  | 4.0 mm (160 mils). Linear range begins at approximately 0.5 mm (20 mils) from target and is from 0.5 to 4.5 mm (20 to 180 mils) (approximately -1 to -17 Vdc). Extended Deviation from Straight Line (DSL) range is from approximately 0.5 to 5.0 mm (20 to 200 mils) (-1 to -19 Vdc). The extended DSL range is not applicable when using zener barriers.                    |
| Recommended Gap Setting       |  | 2.5 mm (100 mils)   |

|                                |  |
|--------------------------------|--|
| Incremental Scale Factor (ISF) | 3.94 V/mm (100 mV/mil) ±10% including interchangeability error when measured in increments of 0.5 mm (20 mils) over the 4.0 mm (160 mil) linear range. |
|--------------------------------|--|

**Deviation from best fit straight line (DSL)**

|                    |                               |
|--------------------|-------------------------------|
| Standard DSL range | Less than ±0.10 mm (±4 mils). |
| Extended DSL range | Less than ±0.15 mm (±6 mils). |

|   |  |
|---|--|
| System Performance over extended temperatures | <p>Over a probe temperature range of -35°C to +120°C (-31°F to +248°F) with the Proximitor Sensor and extension cable between 0°C to +45°C (+32°F to +113°F), the ISF remains within ±25% of 3.94 V/mm (100 mV/mil), the DSL remains within ±0.51 mm (±20 mils) and the extended range DSL remains within ±0.59 mm (±23 mils)</p> <p>Over a Proximitor Sensor and extension cable temperature range of -35°C to +65°C (-31°F to +149°F) with the probe between 0°C to +45°C (+32°F to +113°F), the ISF remains within ±25% of 3.94 V/mm (100 mV/mil), the DSL remains within ±0.51 mm (±20 mils) and the extended range DSL remains within ±0.59 mm (±23 mils)</p> |
|---|--|

|                    |   |
|--------------------|---|
| Frequency Response | 0 to 8 kHz: +0, -3 dB typical, with up to 305 meters (1000 feet) of field wiring. |
|--------------------|---|

**Cross-talk Limitation:**

**Target Size - Flat Surface**  
**Diameter**

|                     |                  |
|---------------------|------------------|
| Recommended Minimum | 30.5 mm (1.2 in) |
|---------------------|------------------|

**Shaft Diameter**

|                     |                 |
|---------------------|-----------------|
| Recommended Minimum | 152 mm (6.0 in) |
|---------------------|-----------------|

 When operating below recommended limits, there will be cross-talk between the probes. To minimize this effect, close the gap as much as possible while still keeping the needed linear range.

A shaft diameter of 76.2 mm (3.0 in) can keep the cross-talk below 50 mV by having the minimum separation of transducer tips; it needs to be at least 64 mm (2.5 in) for axial position measurements and 58 mm (2.3 in) for radial vibration measurements.

Many factors affect the cross-talk when operating below the recommended limit. Consult Performance Specification, document 144979 for additional information.

**Effects of 60 Hz Magnetic Fields Up to 300 Gauss (5 meter system)**

**Output voltage in mil pp/gauss**

| Gap              | Proximitor Sensor | Probe | Ext. Cable |
|------------------|-------------------|-------|------------|
| 0.5 mm (20 mil)  | 0.006             | 0.001 | 0.001      |
| 2.5 mm (100 mil) | 0.033             | 0.009 | 0.005      |
| 4.6 mm (180 mil) | 0.033             | 0.027 | 0.007      |

## Mechanical

|                                  |  |
|----------------------------------|--|
| Probe Tip Material               | Polyphenylene sulfide (PPS).   |
| Probe Case Material              | AISI 304 stainless steel (SST).  |
| Probe Cable Specification        | 75 $\Omega$ triaxial, fluoroethylene propylene (FEP) insulated probe cable in the following total probe lengths: 1, 5 or 9 meters. |
| Extension Cable Material         | 75 $\Omega$ triaxial, fluoroethylene propylene (FEP) insulated.  |
| Proximator Sensor Material       | A380 aluminum  |
| System Length                    | 5 or 9 meters including extension cable  |
| Extension Cable Armor (optional) | Flexible AISI 302 SST with FEP outer jacket.   |
| Tensile Strength (maximum rated) | 330 N (75 pounds) probe case to probe lead. 270 N (60 pounds) at probe lead to extension cable connectors.                         |
| Connector Material               | Gold-plated brass  |

### Probe Case Torque

|                                 | Maximum Rated           | Recommended             |
|---------------------------------|-------------------------|-------------------------|
| 1/2-20 and 5/8-18 probe cases   | 45.2 N•m<br>(400 in•lb) | 15.2 N•m<br>(133 in•lb) |
| M14x1.5 and M16x1.5 probe cases | 63.3 N•m<br>(560 in•lb) | 21.1 N•m<br>(187 in•lb) |
| Reverse mount probes            | 22.6 N•m<br>(200 in•lb) | 7.5 N•m<br>(66 in•lb)   |

### Connector-to-connector torque

|   |                     |
|---|---------------------|
| Recommended torque                              | Finger tight        |
| Maximum torque                                  | 0.565 N•m (5 in•lb) |
| Minimum Bend Radius (with or without SST armor) | 25.4 mm (1.0 in)    |

### System Weight (typical)

#### Probe

70 g (2.5 oz) (minimum length case, 1m lead, no armor)

170 g (6.0 oz) (minimum length case, 1m lead, with armor)

For longer case lengths add 1.1 g/mm (1.0 oz/in).

For 5 m probe length add 180 g (6 oz) for non-armored probe or 560 g (20 oz) for armored probe.

For 9 m probe length add 360 g (12 oz) for non-armored probe or 1120 g (40 oz) for armored probe.

|                         |                     |
|-------------------------|---------------------|
| Extension Cable         | 45 g/m (0.5 oz/ft)  |
| Armored Extension Cable | 140 g/m (1.5 oz/ft) |
| Proximator Sensor       | 255 g (9 oz)        |

### Thread Engagement Limits

| Probe Case Thread | Maximum Length of Thread Engagement |
|-------------------|-------------------------------------|
| <b>1/2-20</b>     | 0.750 in                            |
| <b>5/8-18</b>     | 0.938 in                            |

| Probe Case Thread | Maximum Length of Thread Engagement |
|-------------------|-------------------------------------|
| <b>M14x1.5</b>    | 21 mm                               |
| <b>M16x1.5</b>    | 24 mm                               |

 Maximum thread engagement lengths are per the industry standard of 1.5 times the nominal thread diameter. A fit class matching that of the external probe thread is assumed for all internal threads. Applications with thread engagement lengths exceeding the values in the table above may exhibit binding during installation. Contact your Bently Nevada representative if you require probe thread engagement lengths exceeding the values above. Bently Nevada does not replace proximity probes under warranty due to excessive thread engagement lengths.

|                     |   |
|---------------------|---|
| Storage Temperature | -52°C to +105°C (-62°F to +221°F)   |
| Relative Humidity   | 100% condensing, non-submersible when connectors are protected. Tested to IEC 68-2-3 damp heat.   |
| Probe Pressure      | 3300 XL probes are designed to seal differential pressure between the probe tip and case. The probe sealing material consists of a Viton O-ring. Probes are not pressure tested prior to shipment. Contact our custom design department if you require a test of the pressure seal for your application |

 It is the responsibility of the customer or user to ensure that all liquids and gases are contained and safely controlled should leakage occur from a proximity probe. In addition, solutions with high or low pH values may erode the tip assembly of the probe causing media leakage into surrounding areas. Bently Nevada not be held responsible for any damages resulting from leaking 3300 XL proximity probes. In addition, 3300 XL proximity probes does not be replaced under the service plan due to probe leakage.

## Environmental Limits

### Probe Temperature Range

|                                   |                                   |
|-----------------------------------|-----------------------------------|
| Operating and Storage Temperature | -52°C to +177°C (-62°F to +351°F) |
|-----------------------------------|-----------------------------------|

 Exposing the probe to temperatures below -34°C (30°F) may cause premature failure of the pressure seal.

### Extension Cable Temperature Range

|                                   |                                   |
|-----------------------------------|-----------------------------------|
| Operating and Storage Temperature | -52°C to +177°C (-62°F to +351°F) |
|-----------------------------------|-----------------------------------|

### Proximitors Sensor Temperature Range

|                       |                                   |
|-----------------------|-----------------------------------|
| Operating Temperature | -52°C to +100°C (-62°F to +212°F) |
|-----------------------|-----------------------------------|

## Compliance and Certifications

### FCC

This device complies with part 15 of the FCC Rules. Operation is subject to the following two conditions:

- This device may not cause harmful interference.
- This device must accept any interference received, including interference that may cause undesired operation.

### EMC

European Community Directive:

EMC Directive 2014/30/EU

Standards

EN 61000-6-2; Immunity for Industrial Environments

EN 61000-6-4; Emissions for Industrial Environments

### RoHS

European Community Directive:

RoHS Directive 2011/65/EU

### China RoHS

Cables associated with the product(s) mentioned in this datasheet have an EFUP designation of 15 years, in accordance with SJ/T 11364-2024.



### Maritime

2019 Rules for Conditions of Classification,  
Part 1, 1-1-1/7.7, 1-1-A3, 1-1-A4

2019 Rules for Conditions of Classification,  
Part 1, Offshore Units and Structures  
1-1-4/9.7, 1-1-A2, 1-1-A3

## Functional Safety

SIL 2, HFT = 0

SIL 3, HFT = 1

## Ordering Information

 For the detailed listing of country and product-specific approvals, refer to the [Approvals Quick Reference Guide \(108M1756\)](#).

For additional technical documentation, please log in to [bntechsupport.com](http://bntechsupport.com) and access the Bently Nevada Media Library.

### 3300 XL 11 mm Proximity Probes

**330701** 3300 XL 11 mm Probe, 1/2-20 UNF thread, without armor

**330702** 3300 XL 11 mm Probe, 1/2-20 UNF thread, with armor

**330707** 3300 XL 11 mm Probe, 5/8-18 UNF thread, without armor

**330708** 3300 XL 11 mm Probe, 5/8-18 UNF thread, with armor

#### Part Number-AA-BB-CC-DD-EE-

#### A: Unthreaded Length Option

 Unthreaded length must be at least 1.0 inch less than the case length.

Order in increments of 0.1 in  
 Length configurations:  
**Maximum unthreaded length:**  
 8.9 in  
**Minimum unthreaded length:**  
 0.0 in  
 Example: **0 4** = 0.4 in

#### B: Overall Case Length Option

Order in increments of 0.1 in  
 Threaded length configurations:  
**Maximum case length:** 9.9 in  
**Minimum case length:** 1.0 in  
 Example: **2 4** = 2.4 in

#### C: Total Length Option

|           |                        |
|-----------|------------------------|
| <b>10</b> | 1.0 meter (3.3 feet)   |
| <b>50</b> | 5.0 meters (16.4 feet) |
| <b>90</b> | 9.0 meters (29.5 feet) |

 Five meter probes are designed for use with the five meter Proximity Sensor only.

#### D: Connector and Cable-Type Option

|           |   |
|-----------|---|
| <b>01</b> | Miniature coaxial ClickLoc connector with connector protector, standard cable |
| <b>02</b> | Miniature coaxial ClickLoc connector, standard cable                          |
| <b>11</b> | Miniature coaxial ClickLoc connector with connector protector, FluidLoc cable |
| <b>12</b> | Miniature coaxial ClickLoc connector, FluidLoc cable                          |

#### E: Agency Approval Option

|           |                    |
|-----------|--------------------|
| <b>00</b> | Not required       |
| <b>05</b> | Multiple Approvals |

### 3300 XL 11 mm Proximity Probes, Metric

**330703** 3300 XL 11 mm Probe, M14 x 1.5 thread, without armor

**330704** 3300 XL 11 mm Probe, M14 x 1.5 thread, with armor

**330709** 3300 XL 11 mm Probe, M16 x 1.5 thread, without armor

**330710** 3300 XL 11 mm Probe, M16 x 1.5 thread, with armor

#### Part Number-AAA-BBB-CC-DD-EE

**A: Unthreaded Length Option**

|  |  |
|--|--|
|  |  Unthreaded length must be at least 26 mm less than the case length.                        |
|  | Order in increments of 2 mm.<br>Length configuration:<br><b>Maximum unthreaded length:</b> 224 mm<br><b>Minimum unthreaded length:</b> 0 mm<br>Example: <b>0 6 0</b> = 60 mm |

**B: Overall Case Length Option**

|  |   |
|--|---|
|  | Order in increments of 2 mm.<br>Metric thread configurations:<br><b>Maximum length:</b> 250 mm<br><b>Minimum length:</b> 26 mm<br>Example: <b>0 6 0</b> = 60 mm |
|--|---|

**C: Total Length Option**

|           |  |
|-----------|--|
| <b>10</b> | 1.0 meter (3.3 feet)   |
| <b>50</b> | 5.0 meters (16.4 feet)   |
|           | 9.0 meters (29.5 feet)   |
| <b>90</b> |  Five meter probes are designed for use with the five meter Proximator Sensor only. |

**D: Connector and Cable-Type Option**

|           |   |
|-----------|---|
| <b>01</b> | Miniature coaxial ClickLoc connector with connector protector, standard cable |
| <b>02</b> | Miniature coaxial ClickLoc connector, standard cable                          |
| <b>11</b> | Miniature coaxial ClickLoc connector with connector protector, FluidLoc cable |

|           |  |
|-----------|--|
| <b>12</b> | Miniature coaxial ClickLoc connector, FluidLoc cable |
|-----------|--|

**E: Agency Approval Option**

|           |                    |
|-----------|--------------------|
| <b>00</b> | Not required       |
| <b>05</b> | Multiple Approvals |

**3300 XL 11 mm Reverse Mount Probe**

**330705-02-18- CC-DD-EE** 3/8-24 UNF threads

**330706-005-046- CC-DD-EE** M10 x 1 threads

**C: Total Length Option**

|           |   |
|-----------|---|
| <b>10</b> | 1.0 meter (3.3 feet)  |
| <b>50</b> | 5.0 meters (16.4 feet)  |
|           | 9.0 meters (29.5 feet)  |
| <b>90</b> |  Five meter probes are designed for use with the five meter Proximator Sensor only. |

**D: Connector Option**

|           |                                      |
|-----------|--------------------------------------|
| <b>02</b> | Miniature ClickLoc coaxial connector |
|-----------|--------------------------------------|

**E: Agency Approval Option**

|           |                    |
|-----------|--------------------|
| <b>00</b> | Not required       |
| <b>05</b> | Multiple Approvals |

For a shorter delivery time, order commonly stocked probes. Currently, stocked probes consist of the following part numbers: 330701-00-10-10-02-00, 330701-00-20-10-02-00, 330703-000-050-10-02-00, 330705-02-18-10-02-00, 330706-005-046-10-02-00.