

3300 XL 11 mm Proximity Transducer System

Datasheet

Cordant™

146256 Rev. T

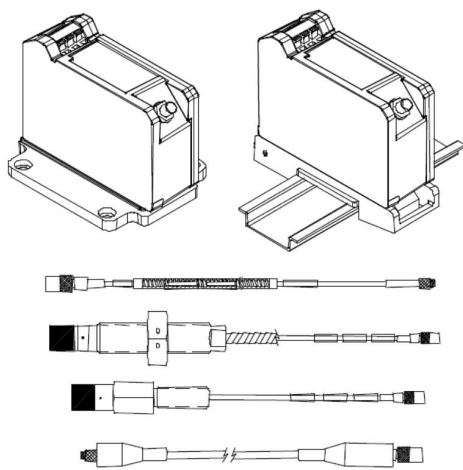

Description

Transducer System

The Bently Nevada™ 3300 XL 11 mm Proximity Transducer System consists of:

- 3300 XL 11 mm probe
- 3300 XL 11 mm extension cable
- 3300 XL 11 mm Proximitor Sensor¹

The 3300 XL 11 mm Proximity Transducer System has a 3.94 V/mm (100 mV/mil) output for non-contacting vibration and displacement measurements on fluid film bearing machines. The large 11 mm tip enables this transducer system to have a longer linear range compared to our standard 3300 XL 8 mm Transducer System. It is primarily used in the following applications where the longer linear range is necessary:

- Axial (thrust) position measurements
- Ramp differential expansion measurements on steam turbines
- Rod position or rod drop measurements on reciprocating compressors
- Tachometer and zero speed measurements
- Phase reference (Keyphasor) signals

The 3300 XL 11 mm Proximitor Sensor is designed to replace the 7200-series 11 mm and 14 mm Transducer Systems. When upgrading from the 7200-series system to the 3300 XL 11 mm system, every component must be replaced with 3300 XL 11 mm components. In addition, the monitoring system must be updated. If using a 3500 Monitoring System, an updated version of the configuration software that lists the 3300 XL 11 mm Transducer System as a compatible option is required.



Baker Hughes 

Existing 3300 Monitoring Systems may need a modification. Contact your local sales and service representative for assistance.



The 3300 XL 11 mm Proximity Transducer is designed for measuring position or vibration within a frequency range of 0 to 8 kHz. Typical applications of this system include radial vibration and position, axial position and Keyphasor measurements.

Although the terminals and connector on the Proximitor sensor have protection against electrostatic discharge, take reasonable precautions to avoid electrostatic discharge during handling.

Proximitor Sensor

The 3300 XL 11 mm Proximitor Sensor has the same advanced features found in the 3300 XL 8 mm Proximitor Sensor. Its thin design allows it to be mounted in either a high-density DIN-rail installation or a more traditional panel mount configuration. Improved RFI/EMI immunity allows the 3300 XL Proximitor Sensor to achieve European CE mark approvals without any special mounting considerations. This RFI immunity also prevents the transducer system from being adversely affected by nearby high frequency radio signals. SpringLoc terminal strips on the Proximitor Sensor require no special installation tools and facilitate faster, highly robust field wiring connections.

Proximity Probe and Extension Cable

The 3300 XL 11 mm probe comes in varying probe case configurations, including armored and unarmored $\frac{1}{2}$ -20, $\frac{5}{8}$ -18, M14 X 1.5 and M16 X 1.5 probe threads. The reverse mount 3300 XL 11 mm probe comes standard with either $\frac{3}{8}$ -24 or M10 X 1 threads. All components of the transducer system have gold-plated brass ClickLoc connectors. ClickLoc connectors lock into place, preventing the connection from becoming loose. The patented TipLoc molding method provides a robust bond between the probe tip and the probe body. The probe cable

is securely attached to the probe tip utilizing our patented CableLoc design that provides 330 N (75 lb) pull strength.

3300 XL Probes and Extension Cables can also be ordered with a FluidLoc cable option. This option prevents oil and other liquids from leaking out of the machine through the cable's interior. The connector protector option provides additional protection of the connectors in a humid or moist environment. Connector protectors are recommended for all installations and provide increased environmental protection². Additionally, the 3300 XL 11 mm probe comes standard with a locknut with pre-drilled safety wire holes.

Notes:

1. Proximitor Sensors are supplied by default from the factory calibrated to AISI 4140 steel. Calibration to other target materials is available upon request.
2. Silicone tape is also provided with each 3300 XL extension cable and can be used instead of connector protectors. Silicone tape is not recommended in applications where the probe-to-extension cable connection will be exposed to turbine oil.

Specifications

Unless otherwise noted, the following specifications are for a 3300 XL 11 mm Proximity Sensor, extension cable and probe between 0°C and +45°C (+32°F to +113°F) at a maximum altitude of 2000m, with a -24 Vdc power supply, a 10 kΩ load, our supplied AISI 4140 steel target that is 31 mm (1.2 in) diameter or larger, and a probe gap of 2.5 mm (100 mils). The system accuracy and interchangeability specifications do not apply when using a transducer system calibrated to any target other than our AISI 4140 steel target.

Electrical

Proximity Sensor

Input	Accepts one non-contacting 3300 XL 11 mm Proximity Probe and Extension Cable.
Power	Requires -17.5 Vdc to -26 Vdc without barriers at 12 mA maximum consumption, -23 Vdc to -26 Vdc with barriers. Operation at a more positive voltage than -23.5 Vdc can result in reduced linear range.
Supply Sensitivity	Less than 2 mV change in output voltage per volt change in input voltage.
Output resistance	50 Ω

Probe dc Resistance

Probe Length (m)	Resistance from the Center Conductor to the Outer Conductor (R_{PROBE}) (ohms)
1.0	5.9 ± 0.5
5.0	7.2 ± 0.8
9.0	8.5 ± 1.1

Extension Cable dc Resistance

Length of Extension Cable (m)	Resistance from Center Conductor to Center Conductor (R_{CORE}) (ohms)	Resistance from Coaxial Conductor to Coaxial Conductor (R_{JACKET}) (ohms)
4.0	1.0 ± 0.25	0.3 ± 0.1
8.0	2.0 ± 0.5	0.6 ± 0.2

Extension cable capacitance	69.9 pF/m (21.3 pF/ft) typical
Field wiring	0.2 to 1.5 mm ² (16 to 24 AWG) [0.25 to 0.75 mm ² (18 to 23 AWG) with ferrules]. Recommend using three-conductor shielded triad cable. Maximum length of 305 meters (1,000 feet) between the 3300 XL Proximity Sensor and the monitor. See the frequency response graph for signal rolloff at high frequencies when using longer field wiring lengths.
Linear Range	4.0 mm (160 mils). Linear range begins at approximately 0.5 mm (20 mils) from target and is from 0.5 to 4.5 mm (20 to 180 mils) (approximately -1 to -17 Vdc). Extended Deviation from Straight Line (DSL) range is from approximately 0.5 to 5.0 mm (20 to 200 mils) (-1 to -19 Vdc). The extended DSL range is not applicable when using zener barriers.
Recommended Gap Setting	2.5 mm (100 mils)

Incremental Scale Factor (ISF)	3.94 V/mm (100 mV/mil) ±10% including interchangeability error when measured in increments of 0.5 mm (20 mils) over the 4.0 mm (160 mil) linear range.
--------------------------------	--

Deviation from best fit straight line (DSL)

Standard DSL range	Less than ±0.10 mm (±4 mils).
Extended DSL range	Less than ±0.15 mm (±6 mils).

System Performance over extended temperatures	<p>Over a probe temperature range of -35°C to +120°C (-31°F to +248°F) with the Proximitor Sensor and extension cable between 0°C to +45°C (+32°F to +113°F), the ISF remains within ±25% of 3.94 V/mm (100 mV/mil), the DSL remains within ±0.51 mm (±20 mils) and the extended range DSL remains within ±0.59 mm (±23 mils)</p> <p>Over a Proximitor Sensor and extension cable temperature range of -35°C to +65°C (-31°F to +149°F) with the probe between 0°C to +45°C (+32°F to +113°F), the ISF remains within ±25% of 3.94 V/mm (100 mV/mil), the DSL remains within ±0.51 mm (±20 mils) and the extended range DSL remains within ±0.59 mm (±23 mils)</p>
---	--

Frequency Response	0 to 8 kHz: +0, -3 dB typical, with up to 305 meters (1000 feet) of field wiring.
--------------------	---

Cross-talk Limitation:

Target Size - Flat Surface

Diameter	
Recommended Minimum	30.5 mm (1.2 in)

Shaft Diameter

Recommended Minimum	152 mm (6.0 in)
---------------------	-----------------

 When operating below recommended limits, there will be cross-talk between the probes. To minimize this effect, close the gap as much as possible while still keeping the needed linear range.

A shaft diameter of 76.2 mm (3.0 in) can keep the cross-talk below 50 mV by having the minimum separation of transducer tips; it needs to be at least 64 mm (2.5 in) for axial position measurements and 58 mm (2.3 in) for radial vibration measurements.

Many factors affect the cross-talk when operating below the recommended limit. Consult Performance Specification, document 144979 for additional information.

Effects of 60 Hz Magnetic Fields Up to 300 Gauss (5 meter system)

Output voltage in mil pp/gauss

Gap	Proximitor Sensor	Probe	Ext. Cable
0.5 mm (20 mil)	0.006	0.001	0.001
2.5 mm (100 mil)	0.033	0.009	0.005
4.6 mm (180 mil)	0.033	0.027	0.007

Mechanical

Probe Tip Material	Polyphenylene sulfide (PPS).
Probe Case Material	AISI 304 stainless steel (SST).
Probe Cable Specification	75 Ω triaxial, fluoroethylene propylene (FEP) insulated probe cable in the following total probe lengths: 1, 5 or 9 meters.
Extension Cable Material	75 Ω triaxial, fluoroethylene propylene (FEP) insulated.
Proximator Sensor Material	A380 aluminum
System Length	5 or 9 meters including extension cable
Extension Cable Armor (optional)	Flexible AISI 302 SST with FEP outer jacket.
Tensile Strength (maximum rated)	330 N (75 pounds) probe case to probe lead. 270 N (60 pounds) at probe lead to extension cable connectors.
Connector Material	Gold-plated brass

Probe Case Torque

	Maximum Rated	Recommended
1/2-20 and 5/8-18 probe cases	45.2 N•m (400 in•lb)	15.2 N•m (133 in•lb)
M14x1.5 and M16x1.5 probe cases	63.3 N•m (560 in•lb)	21.1 N•m (187 in•lb)
Reverse mount probes	22.6 N•m (200 in•lb)	7.5 N•m (66 in•lb)

Connector-to-connector torque

Recommended torque	Finger tight
Maximum torque	0.565 N•m (5 in•lb)
Minimum Bend Radius (with or without SST armor)	25.4 mm (1.0 in)

System Weight (typical)

Probe

70 g (2.5 oz) (minimum length case, 1m lead, no armor)

170 g (6.0 oz) (minimum length case, 1m lead, with armor)

For longer case lengths add 1.1 g/mm (1.0 oz/in).

For 5 m probe length add 180 g (6 oz) for non-armored probe or 560 g (20 oz) for armored probe.

For 9 m probe length add 360 g (12 oz) for non-armored probe or 1120 g (40 oz) for armored probe.

Extension Cable	45 g/m (0.5 oz/ft)
Armored Extension Cable	140 g/m (1.5 oz/ft)
Proximator Sensor	255 g (9 oz)

Thread Engagement Limits

Probe Case Thread	Maximum Length of Thread Engagement
1/2-20	0.750 in
5/8-18	0.938 in

Probe Case Thread	Maximum Length of Thread Engagement
M14x1.5	21 mm
M16x1.5	24 mm

 Maximum thread engagement lengths are per the industry standard of 1.5 times the nominal thread diameter. A fit class matching that of the external probe thread is assumed for all internal threads. Applications with thread engagement lengths exceeding the values in the table above may exhibit binding during installation. Contact your Bently Nevada representative if you require probe thread engagement lengths exceeding the values above. Bently Nevada does not replace proximity probes under warranty due to excessive thread engagement lengths.

Storage Temperature	-52°C to +105°C (-62°F to +221°F)
Relative Humidity	100% condensing, non-submersible when connectors are protected. Tested to IEC 68-2-3 damp heat.
Probe Pressure	3300 XL probes are designed to seal differential pressure between the probe tip and case. The probe sealing material consists of a Viton O-ring. Probes are not pressure tested prior to shipment. Contact our custom design department if you require a test of the pressure seal for your application

 It is the responsibility of the customer or user to ensure that all liquids and gases are contained and safely controlled should leakage occur from a proximity probe. In addition, solutions with high or low pH values may erode the tip assembly of the probe causing media leakage into surrounding areas. Bently Nevada not be held responsible for any damages resulting from leaking 3300 XL proximity probes. In addition, 3300 XL proximity probes does not be replaced under the service plan due to probe leakage.

Environmental Limits

Probe Temperature Range

Operating and Storage Temperature	-52°C to +177°C (-62°F to +351°F)
-----------------------------------	-----------------------------------

 Exposing the probe to temperatures below -34°C (30°F) may cause premature failure of the pressure seal.

Extension Cable Temperature Range

Operating and Storage Temperature	-52°C to +177°C (-62°F to +351°F)
-----------------------------------	-----------------------------------

Proximity Sensor Temperature Range

Operating Temperature	-52°C to +100°C (-62°F to +212°F)
-----------------------	-----------------------------------

Compliance and Certifications

FCC

This device complies with part 15 of the FCC Rules. Operation is subject to the following two conditions:

- This device may not cause harmful interference.
- This device must accept any interference received, including interference that may cause undesired operation.

EMC

European Community Directive:

EMC Directive 2014/30/EU

Standards

EN 61000-6-2; Immunity for Industrial Environments

EN 61000-6-4; Emissions for Industrial Environments

RoHS

European Community Directive:

RoHS Directive 2011/65/EU

China RoHS

Cables associated with the product(s) mentioned in this datasheet have an EFUP designation of 15 years, in accordance with SJ/T 11364-2024.



Maritime

2019 Rules for Conditions of Classification,
Part 1, 1-1-1/7.7, 1-1-A3, 1-1-A4

2019 Rules for Conditions of Classification,
Part 1, Offshore Units and Structures
1-1-4/9.7, 1-1-A2, 1-1-A3

Functional Safety

SIL 2, HFT = 0

SIL 3, HFT = 1

Hazardous Area Approvals



For the detailed listing of country and product-specific approvals, refer to the [Approvals Quick Reference Guide \(108M1756\)](#).

For additional technical documentation, please log in to bntechsupport.com and access the Bently Nevada Media Library.

<p>nA, ec</p> <p>When installed with non-incendive circuit connected per drawing 140979.</p>	<p>Class I, Zone 2: AEx/Ex nA IIC T5...T1 Gc; Class I, Division 2, Groups A, B, C, D; Class I, Zone 2: AEx/Ex ec IIC T5...T1 Gc; Class I, Division 2, Groups A, B, C, and D;</p> <p>(see Temperature Schedule table to follow)</p>
---	---

ATEX/IECEx

3300 XL Proximito Sensor

cnRTLus

3300 XL Proximito Sensor

<p>ia</p> <p>When installed with intrinsically safe zener barriers per drawing 141092 or when installed with galvanic isolators.</p>	<p>Class I, Zone 0: AEx/Ex ia IIC T4/T5 Gc; Class I, Groups A, B, C, and D, Class II, Groups E, F and G, Class III;</p> <p>T5 @ Ta= -55°C to + 40°C. T4 @ Ta= -55°C to + 80°C.</p>
<p>nA, ec</p> <p>When installed with non-incendive circuit connected per drawing 140979.</p>	<p>Class I, Zone 2: AEx/Ex nA IIC T4/T5 Gc; Class I, Division 2, Groups A, B, C, and D; Class I, Zone 2: AEx/Ex ec IIC T4/T5 Gc; Class I, Division 2, Groups A, B, C, and D;</p> <p>T5 @ Ta= -55°C to + 40°C T4 @ Ta= -55°C to + 80°C</p>

<p>ia</p>	<p style="text-align: center;"></p> <p>II 1 G Ex ia IIC T4/T5 Ga Ex ia III C T90C/T105C Dc For EPL Dc: T105C @ Ta = -55°C to 100°C T90C @ Ta = -55°C to +85°C</p> <table border="1" style="width: 100%;"> <tr> <td>Ui= -28V</td> <td>Uo= -28V</td> </tr> <tr> <td>Ii= 140mA</td> <td>Io= 140mA</td> </tr> <tr> <td>Pi= 0.91W</td> <td>Po= 0.742W</td> </tr> <tr> <td>Ci= 47nF</td> <td>Co= 1.5nF</td> </tr> <tr> <td>Li= 1460µH</td> <td>Lo= 610µH</td> </tr> </table>	Ui= -28V	Uo= -28V	Ii= 140mA	Io= 140mA	Pi= 0.91W	Po= 0.742W	Ci= 47nF	Co= 1.5nF	Li= 1460µH	Lo= 610µH
Ui= -28V	Uo= -28V										
Ii= 140mA	Io= 140mA										
Pi= 0.91W	Po= 0.742W										
Ci= 47nF	Co= 1.5nF										
Li= 1460µH	Lo= 610µH										
<p>nA,ec</p>	<p style="text-align: center;"></p> <p>II 3 G Ex nA IIC T4/T5 Gc Ex ec IIC T4/T5 Gc</p> <table border="1" style="width: 100%;"> <tr> <td>Ui= -28V</td> <td>Ii= 140 mA</td> </tr> </table> <p>T5 @ Ta= -55°C to + 40°C T4 @ Ta= -55°C to + 80°C</p>	Ui= -28V	Ii= 140 mA								
Ui= -28V	Ii= 140 mA										



3300 XL Probe

<p>ia</p> <p>When installed with intrinsically safe zener barriers per drawing 141092 or when installed with galvanic isolators.</p>	<p>Class I, Zone 0: AEx/Ex ia IIC T5...T1 Gc; Class I, Groups A, B, C, and D, Class II, Groups E, F, and G, Class III;</p> <p>(see Temperature Schedule table to follow)</p>
---	---

3300 XL Probe



Probe entity parameters are met when used with BN extension cables and connected to BN Prox.

<p>ia</p>	<p style="text-align: center;"></p> <p>II 1 G Ex ia IIC T5...T1 Ga, (see Temperature Schedule table to follow)</p> <p>Ex ia III C T90°C ... T280°C Dc For EPL Dc:</p> <table border="1" data-bbox="379 517 730 663"> <tr> <td>Ui = -28V</td> <td>Ci = 1.5 nF</td> </tr> <tr> <td>Ii = 140 mA</td> <td>Li = 610 μH</td> </tr> <tr> <td>Pi = 0.91 W</td> <td></td> </tr> </table>	Ui = -28V	Ci = 1.5 nF	Ii = 140 mA	Li = 610 μH	Pi = 0.91 W	
Ui = -28V	Ci = 1.5 nF						
Ii = 140 mA	Li = 610 μH						
Pi = 0.91 W							
<p>nA,ec</p>	<p style="text-align: center;"></p> <p>II 3 G Ex nA IIC T5...T1 Gc, Ex ec IIC T5...T1 Gc, (see Temperature Schedule table to follow)</p> <table border="1" data-bbox="379 875 730 920"> <tr> <td>Ui = -28V</td> <td>Ii = 140 mA</td> </tr> </table>	Ui = -28V	Ii = 140 mA				
Ui = -28V	Ii = 140 mA						

Hazardous Area Conditions of Safe Use

cNRTLus:

ia

Install per Bently Nevada drawing 141092.

nA, ec

Install per Bently Nevada drawing 140979.

ATEX/IECEx:

ia

Install per Bently Nevada drawing 141092.

nA, ec

The Proximito must be installed so as to provide the terminals with a degree of protection of at least IP54.

Temperature Schedule

Temperature Classification	Ambient Temperature (Probe Only)
For EPL Ga and Gc	
T1	-55°C to +232°C
T2	-55°C to +177°C
T3	-55°C to +120°C
T4	-55°C to +80°C
T5	-55°C to +40°C
For EPL Dc	
T280°C @ Ta	-55°C to +232°C
T225°C @ Ta	-55°C to +177°C
T170°C @ Ta	-55C to +120°C
T130°C @ Ta	-55°C to +80°C
T105°C @ Ta	-55°C to +100°C
T90°C @ Ta	-55°C to +40°C

Ordering Information



For the detailed listing of country and product-specific approvals, refer to the [Approvals Quick Reference Guide \(108M1756\)](#).

For additional technical documentation, please log in to bntechsupport.com and access the Bently Nevada Media Library.

3300 XL 11 mm Proximity Probes

330701 3300 XL 11 mm Probe, 1/2-20 UNF thread, without armor

330702 3300 XL 11 mm Probe, 1/2-20 UNF thread, with armor

330707 3300 XL 11 mm Probe, 5/8-18 UNF thread, without armor

330708 3300 XL 11 mm Probe, 5/8-18 UNF thread, with armor

Part Number-AA-BB-CC-DD-EE-

A: Unthreaded Length Option



Unthreaded length must be at least 1.0 inch less than the case length.

Order in increments of 0.1 in
 Length configurations:

Maximum unthreaded length:
 8.9 in

Minimum unthreaded length:
 0.0 in

Example: **0 4** = 0.4 in

B: Overall Case Length Option

Order in increments of 0.1 in
 Threaded length configurations:

Maximum case length: 9.9 in

Minimum case length: 1.0 in

Example: **2 4** = 2.4 in

C: Total Length Option

10	1.0 meter (3.3 feet)
50	5.0 meters (16.4 feet)
90	9.0 meters (29.5 feet)



Five meter probes are designed for use with the five meter Proximitor Sensor only.

D: Connector and Cable-Type Option

01	Miniature coaxial ClickLoc connector with connector protector, standard cable
02	Miniature coaxial ClickLoc connector, standard cable
11	Miniature coaxial ClickLoc connector with connector protector, FluidLoc cable
12	Miniature coaxial ClickLoc connector, FluidLoc cable

E: Agency Approval Option

00	Not required
05	Multiple Approvals

3300 XL 11 mm Proximity Probes, Metric

330703 3300 XL 11 mm Probe, M14 x 1.5 thread, without armor

330704 3300 XL 11 mm Probe, M14 x 1.5 thread, with armor

330709 3300 XL 11 mm Probe, M16 x 1.5 thread, without armor

330710 3300 XL 11 mm Probe, M16 x 1.5 thread, with armor

Part Number-AAA-BBB-CC-DD-EE

A: Unthreaded Length Option

 Unthreaded length must be at least 26 mm less than the case length.

Order in increments of 2 mm.
 Length configuration:
Maximum unthreaded length: 224 mm
Minimum unthreaded length: 0 mm
 Example: **0 6 0** = 60 mm

B: Overall Case Length Option

Order in increments of 2 mm.
 Metric thread configurations:
Maximum length: 250 mm
Minimum length: 26 mm
 Example: **0 6 0** = 60 mm

C: Total Length Option

10	1.0 meter (3.3 feet)
50	5.0 meters (16.4 feet)
90	9.0 meters (29.5 feet)

 Five meter probes are designed for use with the five meter Proximitor Sensor only.

D: Connector and Cable-Type Option

01	Miniature coaxial ClickLoc connector with connector protector, standard cable
02	Miniature coaxial ClickLoc connector, standard cable
11	Miniature coaxial ClickLoc connector with connector protector, FluidLoc cable

12	Miniature coaxial ClickLoc connector, FluidLoc cable
-----------	--

E: Agency Approval Option

00	Not required
05	Multiple Approvals

3300 XL 11 mm Reverse Mount Probe

330705-02-18- CC-DD-EE 3/8-24 UNF threads

330706-005-046- CC-DD-EE M10 x 1 threads

C: Total Length Option

10	1.0 meter (3.3 feet)
50	5.0 meters (16.4 feet)
90	9.0 meters (29.5 feet)

 Five meter probes are designed for use with the five meter Proximitor Sensor only.

D: Connector Option

02	Miniature ClickLoc coaxial connector
-----------	--------------------------------------

E: Agency Approval Option

00	Not required
05	Multiple Approvals

For a shorter delivery time, order commonly stocked probes. Currently, stocked probes consist of the following part numbers: 330701-00-10-10-02-00, 330701-00-20-10-02-00, 330703-000-050-10-02-00, 330705-02-18-10-02-00, 330706-005-046-10-02-00.

3300 XL 11 mm Proximator Sensor

330780-AA-BB

A: Total Length and Mounting Option

50	5.0 meter (16.4 feet) system length, panel mount
51	5.0 meter (16.4 feet) system length, DIN mount
52	5.0 meter (16.4 feet) system length, no mounting hardware
90	9.0 meters (29.5 feet) system length, panel mount
91	9.0 meters (29.5 feet) system length, DIN mount
92	9.0 meters (29.5 feet) system length, no mounting hardware

B: Agency Approval Option

00	Not required
05	Multiple approvals



Country specific approvals may be available, consult your local Customer Care Representative for more information.

3300 XL 11 mm Extension Cable

330730-AAA-BB-CC

Make sure that the extension cable length and the probe length, when added together, **equal the Proximator Sensor Total length.**

A: Cable Length Option

040	4.0 meters (13.1 feet)
080	8.0 meters (26.2 feet)

B: Connector and Cable Option

00	Standard cable
01	Armored cable
02	Standard cable with connector protector
03	Armored cable with connector protector
10	FluidLoc cable
11	Armored FluidLoc cable
12	FluidLoc cable with connector protector
13	Armored FluidLoc cable with connector protector

C: Agency Approval Option

00	Not required
05	Multiple Approvals

Accessories

146255	3300XL 11 mm User Guide
144979	Performance Specification
02120015	Bulk field wire. 1.0 mm ² (18 AWG), 3 conductor, twisted, shielded cable with drain wire. Specify length in feet.
02173009	Bulk field wire. 1.0 mm ² (18 AWG), 3 conductor, twisted, shielded cable. Specify length in feet.
138492-01	Replacement panel-mount mounting pad
138493-01	Replacement DIN-mount mounting pad
01609137	BNC (F) to banana plugs
01609138	Proximator Connector Test Pin wiring (two test pins to a BNC (F) connector)

40971-04	50 Ω cable with two BNC (M) connectors. Use this cable in combination with adapter 01609137 and adapter 01609138 when checking performance of the transducer system from the Proximitor Sensor test pin holes.	03839420	Female Connector Protector. Placed on the probe lead to connect to the male connector protector on the extension cable and provide environmental protection of connectors. Also placed on the extension cable to slide over the Proximitor Sensor connection and protect it from the environment.
04310310	3300XL Proximitor Sensor Panel-mount Screws. Package includes four 6-32 UNC thread forming mounting screws (Supplied standard with 3300 XL Proximitor Housings [3300 XL option]).	330153-01	3300 XL Connector Kit. Used on 3300 XL probes and extension cables. Contains one set of male and female ClickLoc connectors, sleeves and one strip of silicone tape.
03200006	Silicone Self-fusing tape. A 9.1 meter (10 yard) roll of silicone tape to protect connectors. It is easy to install and provides excellent electrical isolation and protection from the environment. It is not recommended for use inside the casing of the machine.	163356	Connector Crimp Tool Kit. Includes one set of 75 Ω 3300 XL ClickLoc inserts and connector installation instructions. Supplied with carrying case.
40113-02	Connector Protector Kit. Connector Protector Kit for 3300 XL probes and extension cables, including connector protectors and installation tools.		
136536-01	Connector Protector Adapter. Makes our previous 3300 connector protector kits compatible with 3300 XL probes and extension cable connectors.		
40180-02	Connector Protectors. Package contains 10 pairs of connector protectors.		
03839410	Male Connector Protector. Placed on the extension cable to connect to the female connector protector on the probe and provide environmental protection of connectors.		