

All lithium batteries on the market must be charged with a dedicated lithium battery charger. Failure to do so may result in undercharging or permanent damage to your battery. The WG-36BC1500M 36V 1500W Bidirectional Battery Charger has been optimized for use with LiFePO4 and LiMn2O4 batteries. It features a DC input voltage range of 10–60 VDC and a rated output of 36VDC / 1500W. The charger implements intelligent multi-stage charging with constant current (CC) and constant voltage (CV) phases:

- ※ For 36V LiFePO4 (12-cell series) batteries, the CC charging voltage is set to 43.8V.
- ※ For 36V LiMn2O4 (10-cell series) batteries, the CC charging voltage is set to 42V.

Once the CC voltage threshold is reached, the charger will reduce the charging current to 10% of the rated current. There is no float charge stage, making it professionally designed for lithium battery charging.

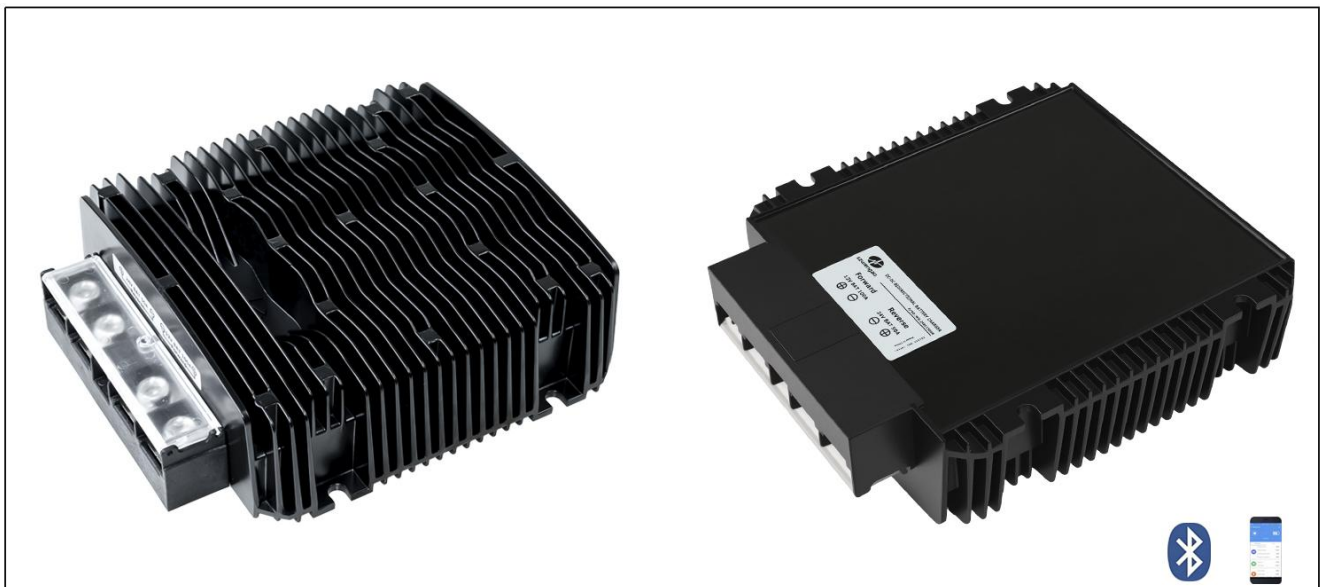

Key Features

- ※ Design meeting by CE, RoHS, ISO9001-2015
- ※ Special design for LiFePO4 and LiMn2O4 batteries CC/CV Value.
- ※ Full charge current design and efficiency up to 96%
- ※ Provide OV, OT, OC(@CC model), and short circuit protection.
- ※ DC output terminals diversify, suit for any battery system.
- ※ Advanced switching mode power supply technology.
- ※ Waterproof, Dust-proof, Shockproof design suit for much environment.
- ※ RS485&CAN protocol (optional): control of current and voltage.
- ※ Provide LED to show charging state, Compact and light weight, natural cooling.
- ※ Built-in Bluetooth module and APP functionality.
- ※ 2 years limited warranty.



Model Naming Method

WG-36BC1500M₁	WG : "szwengao" company name
	36 : Battery voltage (B)
	BC : Bidirectional Charging
	1500 : Charging power (watt)
	M : Type of shell
	1 : Battery type

How to Choose the Model

Model No.	Application		Charging Direction	Charging Conditions
	A		B	
WG-36BC1500M	12V Vehicle (AGM/GEL)	→	38.4V (12S) (LiFePO4)	→ (Forward) 43.8V, 35A (CC-CV) Input Low Voltage Cutoff: ≤12V Input Startup Voltage: 13V
		←		← (Reverse) 14.4V, 100A (CC-CV) Input Low Voltage Cutoff: ≤36V Input Startup Voltage: 37V
WG-36BC1500M1	12V Vehicle (AGM/GEL)	→	37V (10S) (LiMn2O4)	→ (Forward) 42V, 35A (CC-CV) Input Low Voltage Cutoff: ≤12V Input Startup Voltage: 13V
		←		← (Reverse) 14.4V, 100A (CC-CV) Input Low Voltage Cutoff: ≤33V Input Startup Voltage: 34V
WG-36BC1500M2	24V Vehicle (AGM/GEL)	→	37V (10S) (LiMn2O4)	→ (Forward) 42V, 35A (CC-CV) Input Low Voltage Cutoff: ≤24V Input Startup Voltage: 25V
		←		← (Reverse) 28.8V, 50A (CC-CV) Input Low Voltage Cutoff: ≤33V Input Startup Voltage: 34V
WG-36BC1500M3	24V Vehicle (AGM/GEL)	→	38.4V (12S) (LiFePO4)	→ (Forward) 43.8V, 35A (CC-CV) Input Low Voltage Cutoff: ≤24V Input Startup Voltage: 25V
		←		← (Reverse) 28.8V, 50A (CC-CV) Input Low Voltage Cutoff: ≤36V Input Startup Voltage: 37V

Note: The basic parameters listed in this table are factory default values. Please contact us if you need to make any relevant adjustments.

**szwengao****DC-DC Lithium Bidirectional Battery Charger Specification**

Model: WG-36BC1500M

Specifications				
Model No.	WG-36BC1500M	WG-36BC1500M1	WG-36BC1500M2	WG-36BC1500M3
Battery type	LiFePO4	LiMn2O4	LiMn2O4	LiFePO4
DC input voltage range	10-60VDC			
DC input peak voltage	60VDC			
CC (constant current)	A: 43.8V↓, 35A B: 14.4V↓, 100A	A: 42V↓, 35A B: 14.4V↓, 100A	A: 42V↓, 35A B: 28.8V↓, 35A	A: 43.8V↓, 35A B: 28.8V↓, 35A
CV (constant voltage)	A: 43.8V, 35A↓ B: 14.4V, 100A↓	A: 42V, 35A↓ B: 14.4V, 100A↓	A: 42V, 35A↓ B: 28.8V, 35A↓	A: 43.8V, 35A↓ B: 28.8V, 35A↓
Input fuse type	150A (Unit input positive has built-in fuses)			
Max. input current (A)	105A(Vin=10V)			
No load current	200mA (Vin=12VDC)			
Power efficiency	96% @ (Vin=12VDC)			
Ripple & Noise (A→B)	220-600mVp-p			
RS485 remote output(OFF)	100mA (Vin=12VDC)			
Ignition shutdown(ACC OFF)	250uA (Vin=12VDC)			
Battery leakage current	0.7mA			
Anti backflow function	YES			
Bidirectional Charging	YES			
Full Charge Cutoff (Lithium)	YES			
Float charging (AGM/GEL)	YES			
Remote OTA function	YES (Optional)			
Power-on Delay Function	YES			
V/I Calibration Function	YES			
Current Soft Start Function	YES			
Reverse Sleep Function	Available (When ACC is OFF and RMT is ON for reverse charging, the system enters sleep mode 1 minute after the battery is fully charged. It exits sleep mode when Battery A voltage falls below the cutoff point, or when ACC is on for forward charging.)			
Bidirectional Charging Function	1, Auto bidirectional charging when both ACC and RMT are ON. 2, Forward charging when ACC is on and RMT is OFF. 3, Reverse charging when ACC is off and RMT is ON.			
Working temperature	-40°C ~ +55°C			
ACC Signal (Forward)	ON: 10-60 VDC, OFF: 0-8 VDC			
RMT Signal (Reverse)	ON: 10-60 VDC, OFF: 0-8 VDC			
Waterproof level	IP65			
Dimension	200*178*60mm (7.87*7.07*2.36 inch)			
Weight	≤2.7kg			
Input cable type(suggest)	4AWG	If the wire length is greater than 1m, it is recommended to use a thicker wire diameter.		
Output cable type(suggest)	4AWG			
Cooling	Natural			
Packing	Box			
LED light display	RED: battery is charging; GREEN: fully charged.			



Function & Safety			
Short circuit protection	YES (Automatic recovery)		
Over voltage protection	YES (Automatic recovery)		
Over current protection	YES (Automatic recovery)		
Over temperature protection	YES(Automatic derating of output charging power for high temperatures, refer to derating curve)		
Anti electric strength	Input to shell	≥ 500V	Leakage current ≤ 1mA, 1min, no breakdown, no arcing
	Output to shell		
Insulation resistance	Input to Shell	≥10MΩ	Test voltage = 500V
	Output to Shell		
MTBF	≥ 200,000H	Vin=12V/24V/36V/48V	

RS485 & App Communication Function (optional)

- 1, Input undervoltage and overvoltage protection point and recovery point can be set (customized for different application scenarios)
- 2, Adjustable output voltage 10-60V (customized charging curve for different types and capacities of batteries).
- 3, Adjustable output current 1A-100A (customized charging curve for different types and capacities of batteries).
- 4, Battery full state indicator current conversion point 1-20A can be set (customized for different capacity batteries).
- 5, RS485 remote output ON/OFF function (battery full stop charging).
- 6, Output voltage and current calibration function (ensures batch consistency).
- 7, Real-time reporting of input and output operating parameters(protection alarms).
- 8, All settable parameters have a power-down storage function.
- 9, [Built-in Bluetooth module, controllable via mobile app.](#)

Signal Line Wiring and Functions

- **485 Communication Cable**
Pin 1 (Red): RS485+/A, Pin 2 (Black): RS485-/B
- **CAN Communication Cable**
Pin 3 (Blue):CANH(N/A Reserved), Pin 4 (Grey): CANL(N/A Reserved)
- **ACC Enable Signal**
Pin 5 (Yellow): ACC
- **Reverse Enable Signal**
Pin 6 (Green): RMT
- **Mode Switching Signal**
Pin 8 (Orange): PG, In battery mode, grounding this pin automatically switches between forward and reverse (PG and BAT- short-circuited). If left unconnected, the mode remains manual forward/reverse (PG and BAT- open).
- **Battery Negative Signal**
Pin 7 (White): BAT-

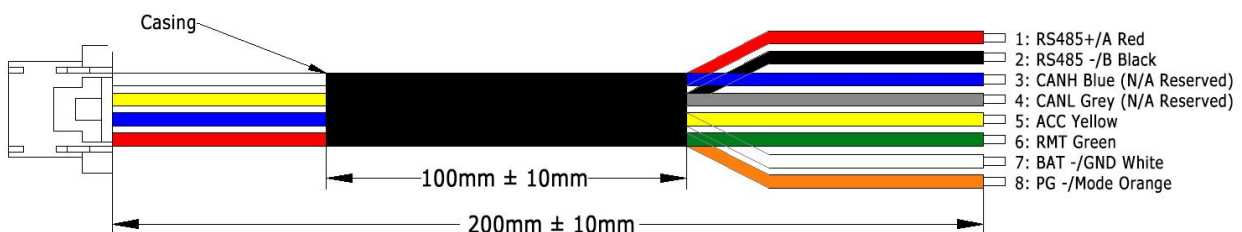

▾ Dual-Battery Application

1) Automatic Mode (with ACC and RMT connected)

Example: Battery A (12V-AGM) vs. Battery B (24V-LIFEPO4), ACC is connected to the ignition key switch. RMT is directly connected to the positive terminal of the auxiliary battery.

- **State 1:** Forward Charging (A → B)

Conditions: $A > 13V$, $16V > B < 31V$; ACC ignition key is ON (vehicle driving); RMT is connected to the positive terminal of the auxiliary battery.

Action: Activate forward vehicle charging from A to B

Stop Condition: Stop operation when Battery A voltage drops below 12V.

- **State 2:** Reverse Charging (B → A)

Conditions: $A > 8V$, $25V > B < 31V$; ACC ignition key is OFF (vehicle parked); RMT is connected to the positive terminal of the auxiliary battery.

Action: Activate reverse charging and power supply from B to A.

Stop Condition: Stop operation when Battery B voltage drops below 24 V.

- **State 3:** Reverse Sleep Mode (B → A)

Conditions: ACC ignition key is OFF (vehicle parked); RMT is connected to the positive terminal of the auxiliary battery.

Operation: During reverse operation, when Battery A is under no load, Battery B will fully charge Battery A, then enter sleep mode after 3 minutes (leakage current of Battery B: 1.5mA).

When Battery A voltage $< 12V$, the system exits sleep mode after 20 seconds and resumes charging from B to A, repeating the cycle.

- **State 4:** Quick Exit from Reverse Sleep Mode

When the ACC ignition key is turned ON, the system exits sleep mode after 20 seconds and switches to forward charging.

When ACC is turned OFF, it switches back to reverse operation, repeating the cycle.

2) Manual Bidirectional Mode

Example: Battery A (12V-AGM) vs. Battery B (24V-LIFEPO4), ACC is connected to the ignition key switch. RMT is connected to the positive terminal of the auxiliary battery via a switch.

- **State 1:** Forward Charging (A → B)

Conditions: $A > 13V$ and $16V > B < 31V$; ACC ignition key is ON (vehicle driving); RMT switch is OFF (disconnected from the auxiliary battery positive).

Action: Activate forward vehicle charging from A to B.

Stop Condition: Stop operation when Battery A voltage drops below 12V

- **State 2:** Reverse Charging (B → A)

Conditions: $A > 8V$ and $25V > B < 31V$; ACC ignition key is OFF (vehicle parked); RMT switch is ON (connected to the auxiliary battery positive)

Action: Activate reverse charging and power supply from B to A.

Stop Condition: Stop operation when Battery B voltage drops below 24V

● **State 3: Stop Operation**

ACC ignition key is OFF (vehicle parked), and RMT switch is disconnected from the positive pole of the auxiliary battery.

With ACC ignition key OFF and RMT switch disconnected from the positive pole of the auxiliary battery, the leakage current of Battery B is 55 μ A.

Regarding indicator status:

1. Pre-charge: Red indicator blinks at 3 s ON / 3 s OFF.
2. CC/CV charging (charging current > 10% of rated charging current): Red indicator ON continuously.
3. Fully charged or float charge (charging current < 10% of rated charging current): Green indicator ON continuously.
4. After lithium battery fully charged and charging stopped: Green indicator blinks at 3 s ON / 3 s OFF.
5. Forward fault: Red indicator blinks at 400 ms interval.
6. Reverse fault: Red indicator blinks at 250 ms interval.

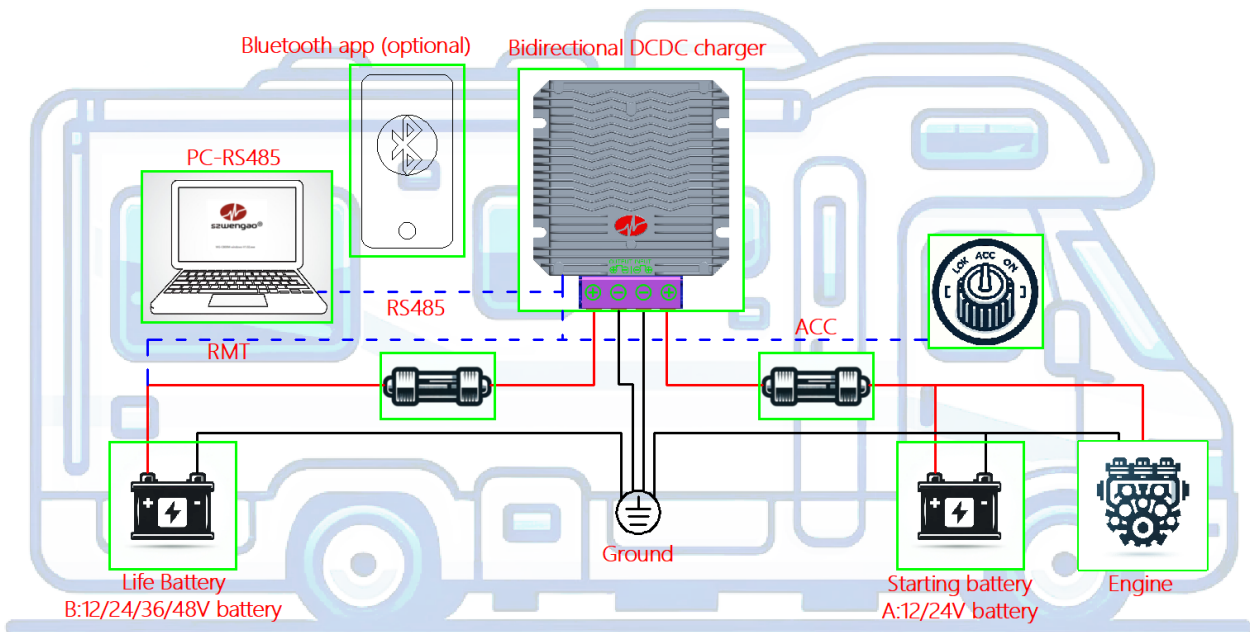

⚠ Note: Please ensure all connecting wires are properly connected as required. Incorrect connection of the power wires will cause permanent damage to the product, and wrong connection of the signal wires will result in abnormal operation.



Characteristic Curves

Efficiency

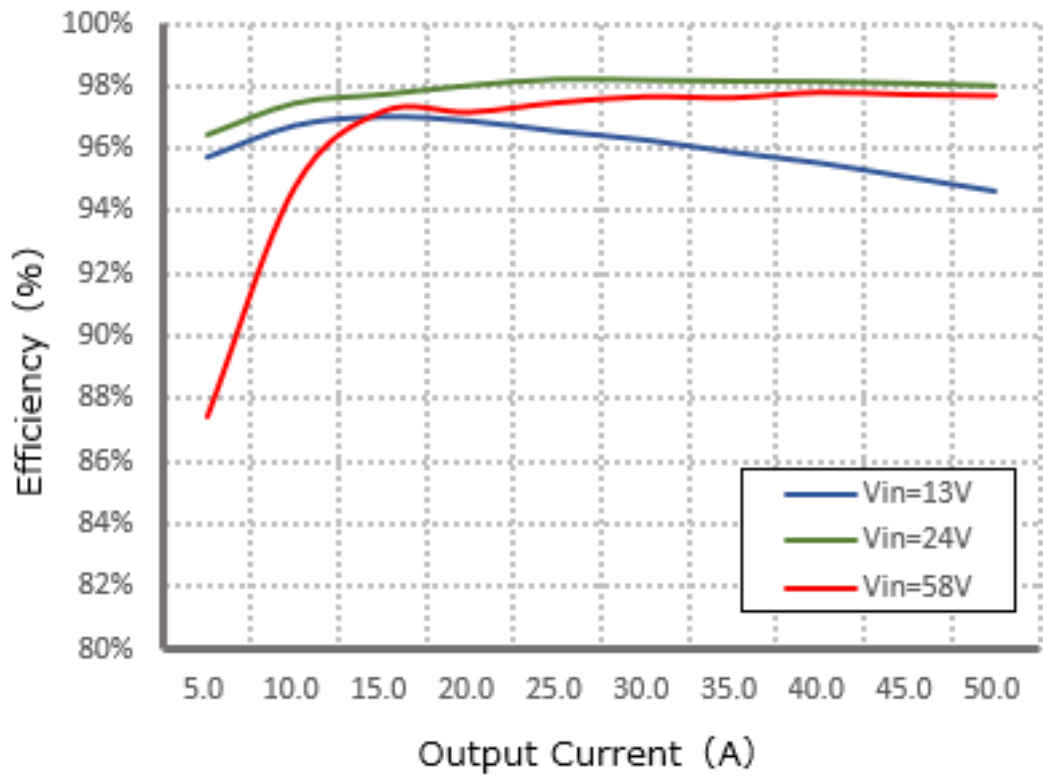

Power dissipation

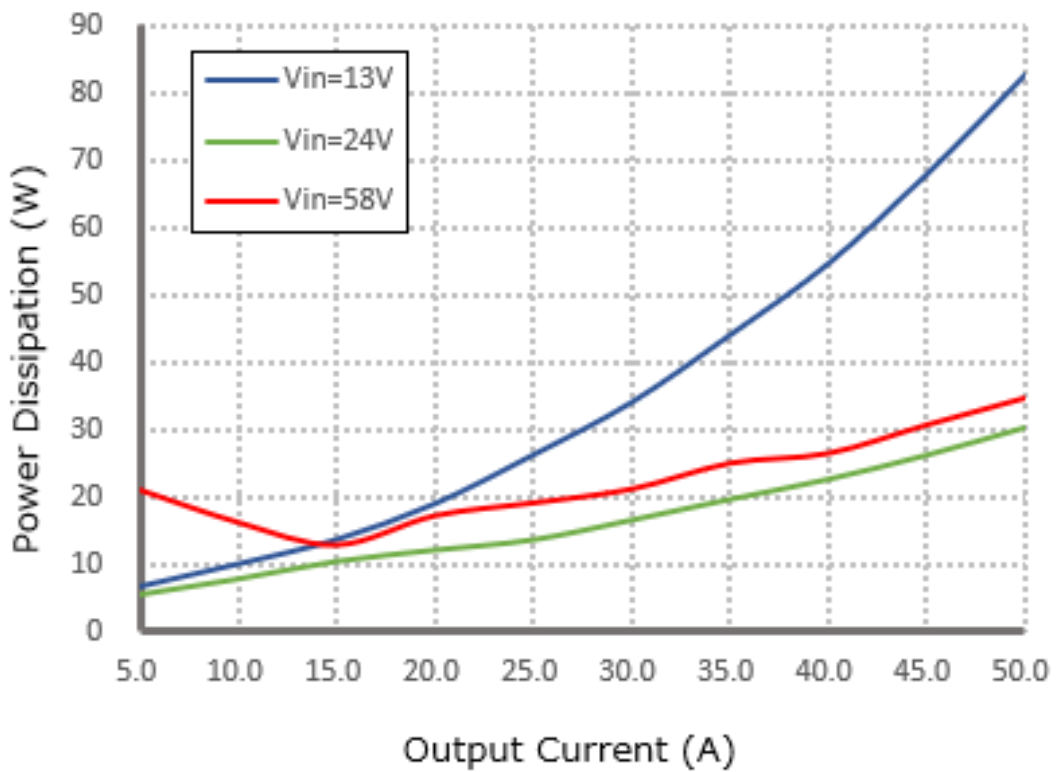

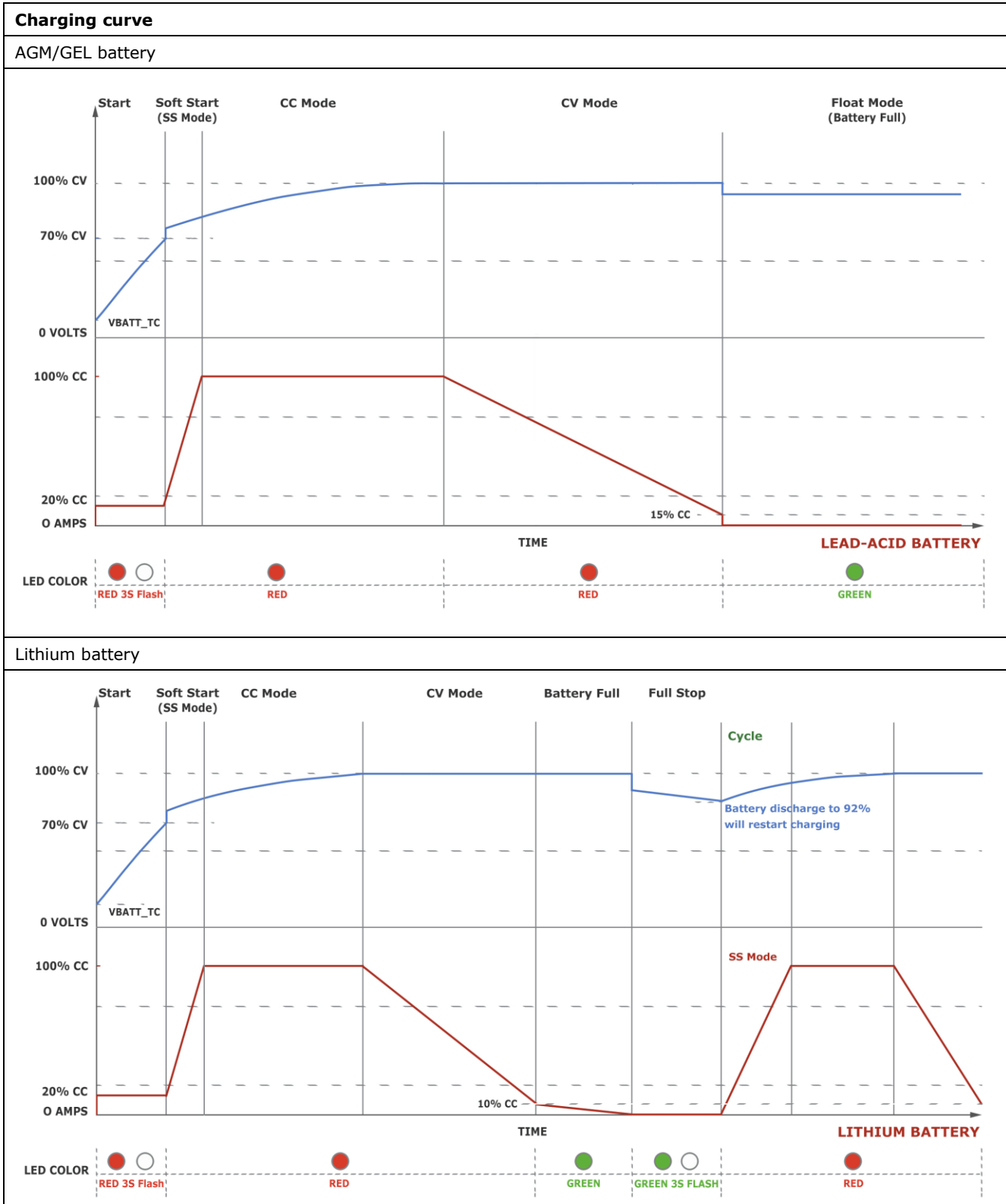



Temperature Derating Curve

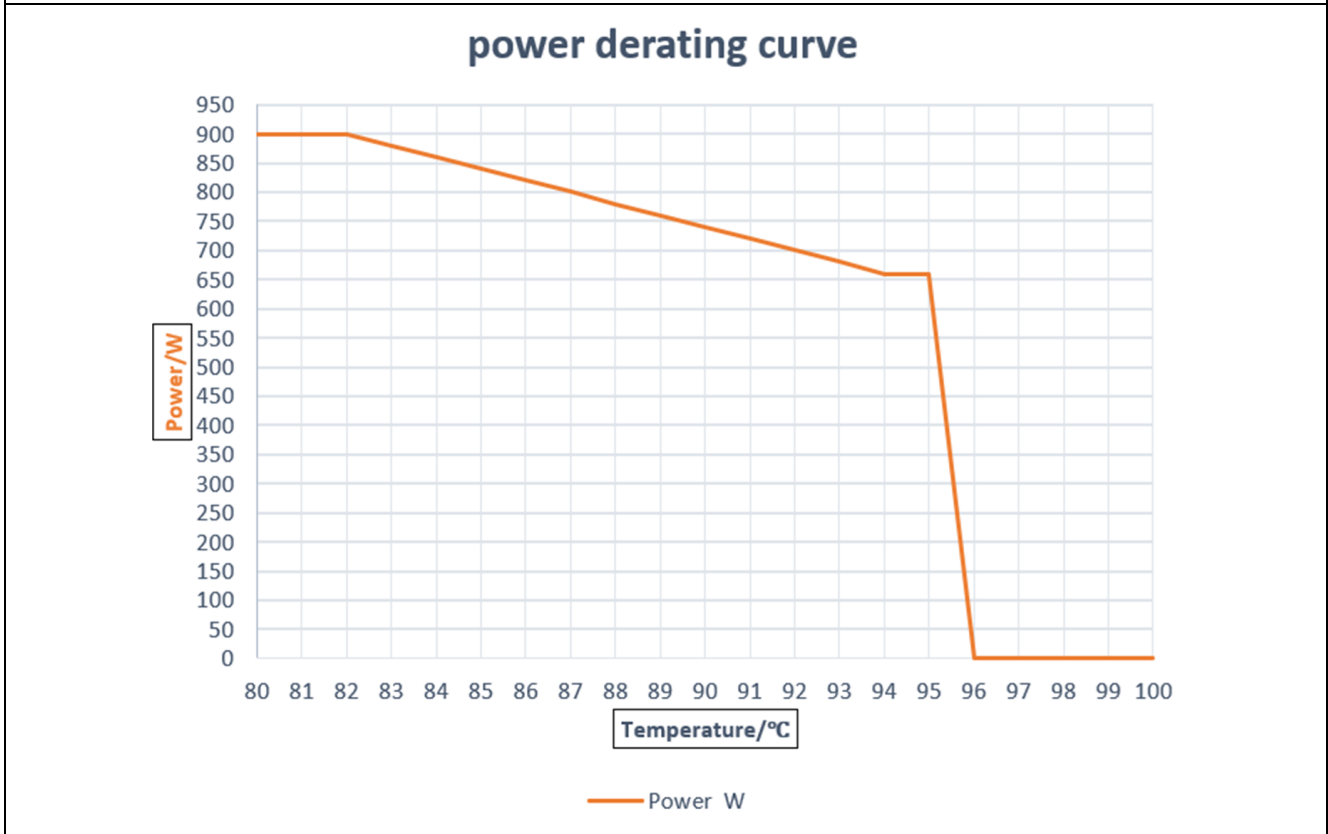

How it works

Vehicle-to-battery (V2B), Battery-to-vehicle (B2V)



Dual battery system: Battery-to-battery (B2B)



With a WG-36BC1500M bidirectional charger, you can charge your dual battery system, and charge your car with the auxiliary battery.



szwengao

DC-DC Lithium Bidirectional Battery Charger Specification

Model: WG-36BC1500M

Dimension

Unit: mm

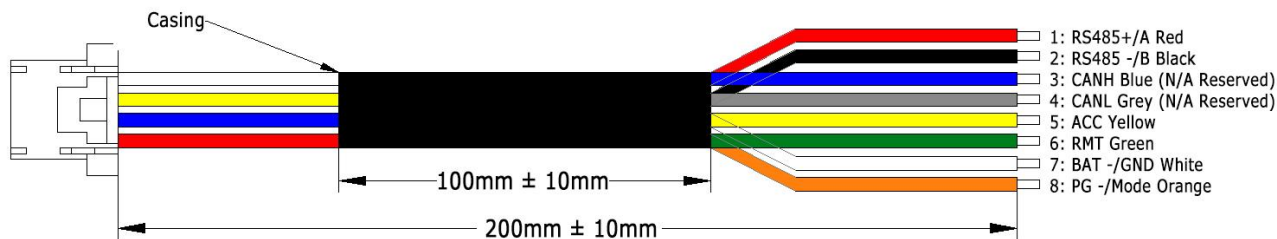
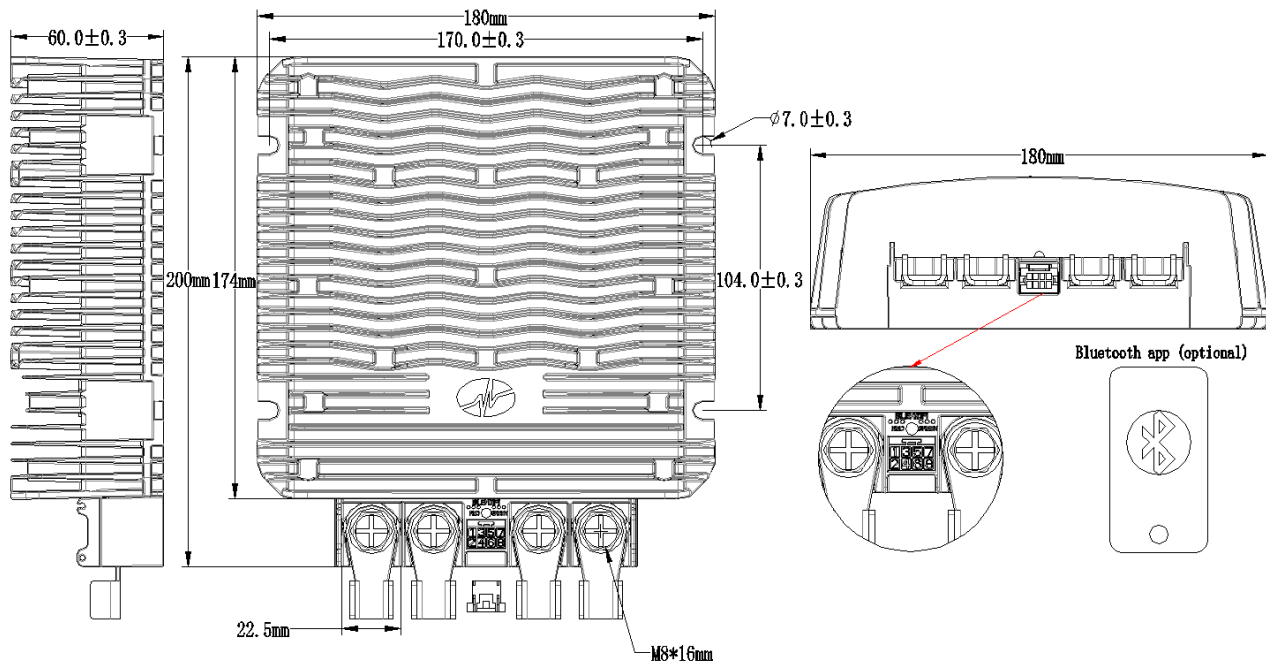

Shenzhen Wengao Electronic Co., Ltd

A: 2/F A, Bldg.A2, Anle Ind. Hangcheng RD., Xixiang Street, Baoan Dist., Shenzhen, China 518102

T: +86 755 29418061

F: +86 755 29418061

E: info@wengaoelec.com

W: www.wengaoelec.com