



INSTRUCTION MANUAL BOOK

Dear Customer,

Thank you for purchasing the “PREMIUM” series water purifier.

Rest assured that all our products are designed and manufactured to the highest standards.

We would like you to utilize all the features of our device which equipped with internal smart filtration system.

Now you can enjoy an unlimited supply of high-quality, healthy, tasty water, just the way you like it - cold, hot or ambient.

We care about the same things you care about: your and your family's health. We are here to take care of you!

Please read this manual carefully before operation. Thanks.



PT-2488

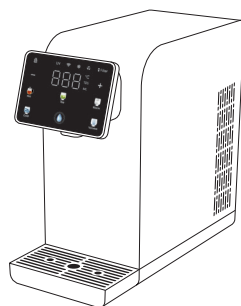

PT-2489

[SAFETY PRECAUTIONS]

1. Keep electrical appliances out of reach from children. Do not let them to operate the appliances without supervision.
2. To protect against the risk of electrical shock, do not immerse the product, cord or plug into water or any other liquids.
3. This product is not intended for use by person (including children) with reduced physical, sensory or mental capabilities unless they have been given supervision or instruction concerning use of the appliance by a person responsible for their safety.
4. If the power cord or plug is damaged, it must be replaced by the service centre or a qualified service technician to avoid hazard.

[WARNING]

to reduce the risk of fire, electrical shock or injury to persons or property, please read and follow below instructions carefully.

1. Always operate the product from a power source of the same voltage, frequency and rating as indicated on the product identification marking.
2. Do not operate this product if it has malfunctioned, damaged cord or plug or appears damaged in any way. Return the complete product to the place of purchase for inspection, repair or replacement.
3. This product should not be used in the immediate vicinity of water, such as bathtub, washbowls, swimming pool etc. where the likelihood of immersion or splashing could occur.
4. Always switch off and unplug the plug from outlet when not in use, before assembling or disassembling parts and before cleaning. Fully assemble the set before operating.
5. Avoid contacting with moving parts. Do not insert any object through the guard when the set is operating.
6. Always disconnect the appliance when moving it from one location to another.

The appliance is not to be used by persons (including children) with reduced physical, sensory or mental capabilities, or lack of experience and knowledge, unless they have been given supervision or instruction. Children being supervised not to play with the appliance.

This appliance is intended to be used in household and similar applications such as:

- staff kitchen areas in shops, offices and other working environments;
- family houses;
- by clients in hotels, motels and other residential type environments;
- bed and breakfast type environments.

The appliance must not be immersed.

If the supply cord is damaged, it must be replaced by the manufacturer, its service agent or similarly qualified persons in order to avoid a hazard.

The appliances connected to the water mains

- max.inlet water pressure:0.4Pa
- min. inlet water pressure: 0.1Pa

Do not store explosive substances such as aerosol cans with a flammable propellant in this appliance.

WARNING: When positioning the appliance, ensure the supply cord is not trapped or damaged.

【PRODUCT DESCRIPTION】

1.GENERAL OVERVIEW

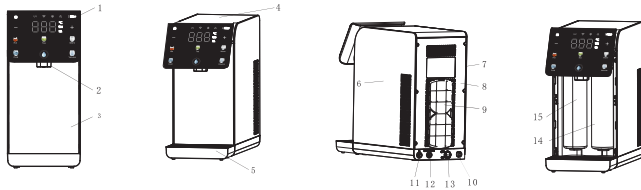

- | | |
|-----------------------|---|
| 1).User Interface(UI) | 9).Dust Screen |
| 2).Water Spout | 10).Power Cord |
| 3).Front Panel | 11).Water Inlet |
| 4).Top Panel | 12).Clean(UF version)/Drain (Ro version) |
| 5).Drip Tray | 13).Cooling On/Off (Optional) |
| 6).Right Panel | 14).Stage 1st Filter (Sediment&Carbon Composite) |
| 7).Left Panel | 15).Stage 2nd Filter UF&ACF Composite(UF version) |
| 8).Back Panel | Or Stage 2nd 100GPD RO Membrane (Ro version) |

2.OPERATION USER INTERFACE(UI)

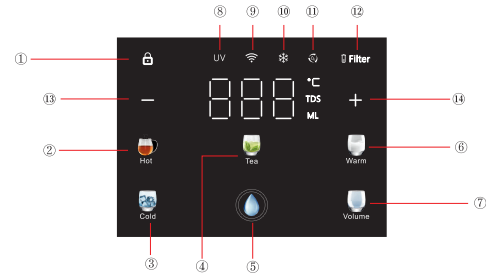

- | | |
|--|--------------------|
| ① Child Lock | ② Hot Water |
| ③ Cold Water | ④ Tea Water |
| ⑤ Waterdrops Dispensing /Ambient Water | ⑥ Warm Water |
| ⑦ Volume Selection | ⑧ UV LED |
| ⑨ Wifi(Optional) | ⑩ Cooling Icon |
| ⑪ Auto clean(UF version) / Auto-flush(RO version) | ⑬ Setting Decrease |
| ⑫ Filter | |
| ⑭ Setting Increase | |

3.DESRIPTION OF BUTTON FUNCTIONS AND OPERATION:

1). Child Lock: Red Light

When the child lock is on, a red light shows. After unlocking, the icon disappears

The child lock is enabled by default, shown by a red light when the screen is on. In this mode, the child lock button can only unlock the hot, tea, and warm water functions. Cold water, ambient water, and volume buttons remain usable.

To dispense hot, tea, or warm water, You should press the child lock button to unlock and then combine with waterdrops  to take water.

Holding & press for 5 seconds disables the lock permanently (red light off), and press it again for 5 seconds reactivates it. If not permanently disabled, the lock automatically reactivates when the screen turns off.

2). Hot Water Dispensing Button: White light , combined with the waterdrops

 to starts hot water dispensing.

- When the voltage is 220V, the default temp. is 95°C.
- When the voltage is 110V, the default temp. is 90°C.
- The hot water temp. is adjustable between 86-100°C.
- You can select your preferred temp. by adjusting the “+” and “-”

· Operation:

- When the child lock is on,
- You first need to press the child lock , then press the hot water button  and then push the waterdrops  to dispense hot water.



When the child lock is off,

You can directly press the hot water  and then push the waterdrops  to dispense hot water.

- Press any key to stop dispensing.

Boiling Point Setting

Press and hold the hot button for 5 seconds to enter the boiling point setting status.

- For 220V devices, set the boiling point between 85°C and 98°C.
- For 110V devices, set the boiling point between 85°C and 95°C.
- Use  or  to adjust the data. The system will save and remembers your last custom temp.

3).  Tea Water dispensing Button: White light , combined with the waterdrops  to starts tea water dispensing.



- The default temp. is 85°C.
- The tea water temp. is adjustable between 66-85°C.
- You can select your preferred temp. by adjusting the “+” and “-”

· Operation:

When the child lock is on,



You first need to press the child lock , then press the tea water  and then push the waterdrops  to dispense tea water.

When the child lock is off,

You can press the tea water  directly, then push waterdrops  to dispense tea water.

You can directly press the tea water  and then push the waterdrops  to dispense tea water.

- Press any key to stop dispensing.

4).  Warm Water Dispensing Button; White light , combined with the waterdrops  to start warm water dispensing.

- The default temp. is 50°C.
- The warm water temp. is adjustable between 40-65°C.
- You can select your preferred temp. by adjusting the “+” and “-” .

· Operation:

When the child lock is on,



You first need to press the child lock , then press the warm water  and then push the waterdrops  to dispense warm water.

When the child lock is off,

You can directly press the warm water  and then push the waterdrops  to dispense warm water.

- Press any key to stop dispensing.

5).  Cold Water Dispensing Button: Blue light , used to start the cold water dispensing

- (1) Direct press cold  button to start cold water dispensing
- (2) Holding the cold  button for 5 seconds turns on/off the cooling(the default is on) .



6). **Waterdrops/Ambient Water Button:** White light, used to start the ambient/hot/tea/warm water dispensing.

(1) Direct press waterdrops  to start ambient water dispensing

(2) Combine with the hot, tea, and warm water buttons work together to dispense hot water at multiple temp option .

7). **Volume Selection Button:** White light, allows you to choose a fixed water volume. the defaults volume option you have : 140ml, 250ml, 500ml, or 999ml. You can define your preferred volume:

- a. 140 ml (50-200 ml),
- b. 250 ml (210-400 ml),
- c. 500 ml (410-700 ml),
- d. 999 ml (710-999 ml).

Use  or  to adjust in 10 ml increments. The system saves and remembers your last custom volume.

8). **UV Sterilizer Indication :** Blue light

The UV light operates when the water temperature not high then 65°C.

When UV function fails, the UV light flashes for 3 seconds every 6 hours as a reminder.

9). **WIFI Module Option**

10). **Cooling Status Indication**

The cooling is on shows a blue light , and when a white light show in insulation status, and the light off show the cooling off

11). **Auto-clean Or Auto-flush Function**

A: Auto-clean function (UF Version Only)



1)The Auto-clean is automatically cleans the instant heating module periodically.

2)Cleaning Process :

Preparation:

①Close the water inlet valve or switch, Prepare 1L of citric acid cleaning liquid in a container and place it near the cleaning inlet.

②Place a water container with at least 1L volume at the outlet nozzle to collect waste water.

③Start cleaning:You can press and hold both the warm"  "and volume"  "for 5 seconds to enter auto clean status.

④Cleaning Cycle:The machine heats water to 95°C, dispenses the first 200mL, then enters soaking mode. It repeats a 250mL discharge every 10 minutes for 3 cycles.

⑤Ending:

(a)The buzzer will beep 3 times and the machine will automatic exit cleaning mode.

(b)Open the water inlet valve and flush with 1L of room-temperature water before use.

B: Auto-flush function (RO version only) :

The Auto-Flush working periodically and flushes the system to maintain optimal performance.

12). **Filter Lifespan Indication:** Blue & red light

The filter lifespan is determined by both the flow meter and elapsed time. When either of the following conditions is met:

Filter usage reaches below 2100L, or Elapsed time exceeds 270 days,

The filter indicator light will turn red and begin flashing. Once the filter's lifespan expires, the buzzer will sound 3 times every 3 hours until the filter is restored.

12.1 Filter Replacement Instruction

Step 1: Take out water tray



Step 2: Take out front panel

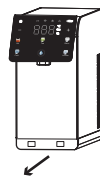

Step 3: Turn the old filter and replace with new

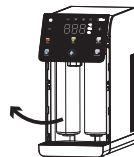

Step 4: Install back the front panel and tray



Item No.	Description	Reduction &Function	Lifespan
PT-3788 1 ST Stage	Sediment & Carbon Block Composite	Sediment- remove sand,dust, mud, impurity,iron rust and substance Carbon -Absorb unusual colors and odors,remove residual chlorine and organic substance	2100L/ 6 Months
PT-3789 (UF Version) 2 nd Stage)	UF Membrane & ACF Composite	UF-remove bacteria,iron rust colloids and impurities Carbon fiber -further absorb chlorine, micro-mole clues and organic substance,special improve water taste	2100L/ 6 Months
PT-3790 (RO Version) 2 nd stage	RO Membrane (100GPD)	RO membrane accuracy up to 0.0001 microns. the impurities such pesticides, bacterial, virus, heavy metal ions and other harmful substances in the water are effectively intercepted and eliminated	3000L/ 12 Months

12.2 Filter Usage Status Check: Press the "Filter" button once to view the filter's lifespan, displayed as a number from 0 to 100, based on its sphere cycle usage.



12.3 Filter Life Restore: Hold the "Filter"  for 5 seconds to reset only when the filter life is due.

COMBINATION KEY SETTING INSTRUCTIONS

1.Ambient Water Flow Rate Setting (Available for 220V device only)

You can press and hold both the Waterdrop  and  control to adjust the flow rate between 650ml and 850ml (The default is 750ml), and each adjustment step increases or decreases the flow rate by 50ml.

2.Cold Water Flow Rate Setting

You can press and hold both the cold  and  control to adjust the flow rate from 80%,90% 100% (The default is 100%), and each adjustment step increases or decreases the flow rate by 10%.



3.Auto-cleaning Model Setting (For UF version only)

You can press and hold both the warm  and volume  for 5 seconds to enter auto clean status. And push again both button 5 second exit.

4.Turn On & Off The Buzzer Function Setting

You can press and hold both the  and  for 5 seconds to turn the buzzer on or off.

Standby Mode & Night Light Instructions

- * Standby mode: After 120 seconds of inactivity, the system enters standby mode. All lights turn off except the waterdrops  on, to reactivate press any key.
- * The night light is always on show blue light as default.
- * When dispensing hot and tea water the night light will turn red color.
- * When dispensing warm/milk water the night light will turn purple color.
- * When dispensing cold and ambient water the night light will turn blue color.
- * When water is not flowing, press and hold the tea  for 5 seconds to turn the night light off or on.
- * Any buttons are touched, the buzzer will be activated, and the sound with a chord voice.

MACHINE WORKING PRINCIPLE

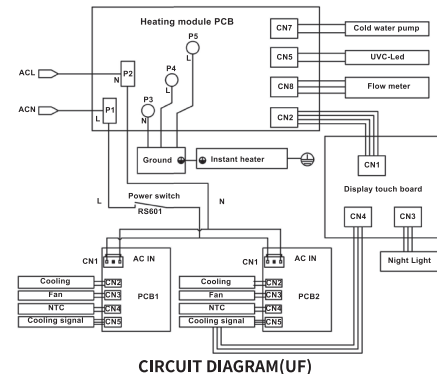
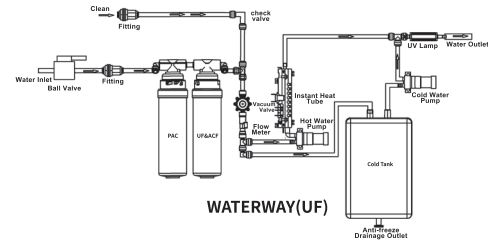

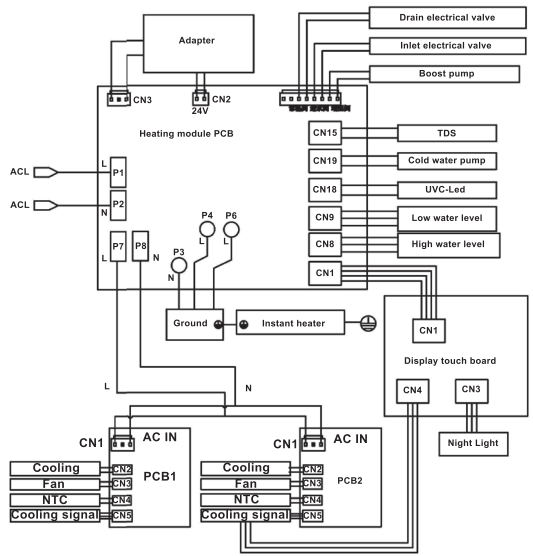
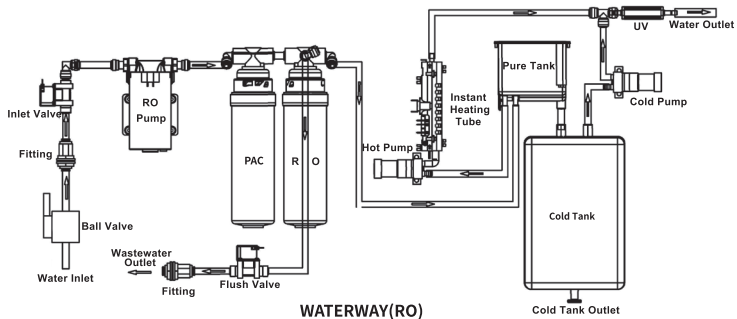

Item	Power supply	110-120Voltes	220-230Voltes
1	Voltage	115V, 1phase	230, 1phase
	Frequency	60Hz	50Hz/60Hz
	Cooling Power	125W	125W
	Heating Power	1400W	2100W
	UVC Led Power	2.5W	2.5W
	Climate Class	ST/T	ST/T
2	Cold tank vol	0.396GAL	1.5L
	Cold water output	0.396GAL/H	1.5L/H
3	Cold water Temp	41-53.6°F	5-12°C
	Hot water output	Unlimited	Unlimited
4	Hot water Temp	104-212°F	40-100°C
	1st-Sediment&Carbon Composite 2nd-UF&ACF Composite Or 100GPD RO Membrane	1st-Lifespan: 2100L(554GAL)/210 Days 2nd-Lifespan: 2100L(554GAL)/210 Days(UF) Or 2nd-Lifespan: 3000L(792GAL)/360 Days(RO)	1st-Lifespan: 2100L(554GAL)/210 Days 2nd-Lifespan: 2100L(554GAL)/210 Days(UF) Or 2nd-Lifespan: 3000L(792GAL)/360 Days(RO)
5	Applicable water pressure	0.1-0.4MPa	0.1-0.4MPa
6	Applicable water	Tap Water	Tap Water
7	Product size	425(D)*180(W)*380(H)mm	425(D)*180(W)*380(H)mm
	Packing size	480(D)*240(W)*480(H)mm	480(D)*240(W)*480(H)mm
8	Net.weight	7.3kgs/16lbs(RO)	6.3kgs/13lbs(UF)
	Gross.weight	8.3kgs/18lbs(RO)	7.3kgs/16lbs(UF)

(INSTALLATION&UNPACKING)

Please cut off water source before replacing filters. Never plug filters in water running state.

- 1.Open the top of the packing case,take out the top foam and its accessories. put the accessories aside.
- 2.Unpack the product,install the water collector.
- 3.Take out the quick joint,and install it on the water pipe.

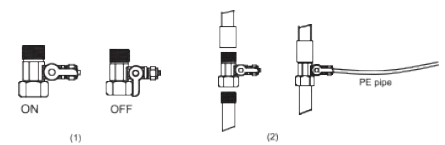

4. Filter should be cleaned for the first use, Turn on the faucet to flush the filter for 10 minutes, When installing the machine, please pay attention to the installation dimension in case for the blocking of air inlet and outlet.

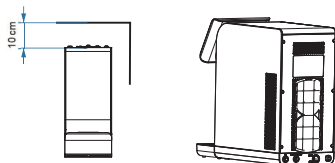

5. Drip tray cover must be properly placed inside the machine. No suspending in midair in case of falling off.

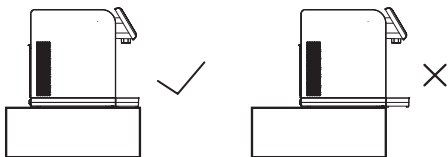

6. Take out the pin of the quick joint at the rear of the product's base plate, and then take out the blue plug. Insert the water inlet PE pipe in the quick joint, and tighten the pin.

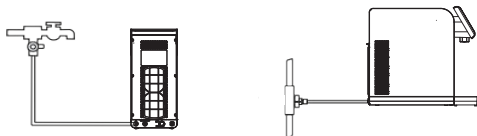

7. The water cooler plug cord into a ground fault interrupter receptacle.

After installing, supply power, and begin to use the Water purifier.

8. When installing filter and replace filter please turn off the water and power supply before installation and replacement.

ATTENTIONS:

It is a normal state that the following circumstances occur when the water purifier is used.

1. During the heating, the heating tube may generate slight noises. This is a normal state.

2. When the heating module is being heated without water, the anti dry- burning device, will disconnect automatically and can not reset by its own. The reset must be completed by a professional technician. The design is in accordance with the national safety requirements.

[TROUBLESHOOTING GUIDE]

In case of failure, please carry out inspection according to the requirements below. If unresolved, please contact the local service agency.

Failure&Error Code	Cause
E1	Outlet water temperature sensor failure
E2	Lacks water
E4	Heating membrane circuit failure
E7	Thick-film inlet NTC failure
E7	Zero-crossing circuit failure
E9	Water pump short circuit
EA	Communication error
EB	Water pump open circuit
H1	Sensor failure
H2	Voltage sensor failure Inlet water temperature
H2	Ice formation alarm triggered when the inlet Water temperature falls below 0-1°C
H3	Over-temperature alarm (triggered when the ntc temperaturesensor on the heating element reaches or exceeds 106°C)at this point, cold water can still be dispensed, and normaloperation will resume once the membrane surface temperaturedrops below the inlet water temperature by 30°C
H4	Over-temperature alarm (triggered when the ntc temperaturesensor on the heating element reaches or exceeds 110°C).At this point,any water dispensing operation is not permitted.