

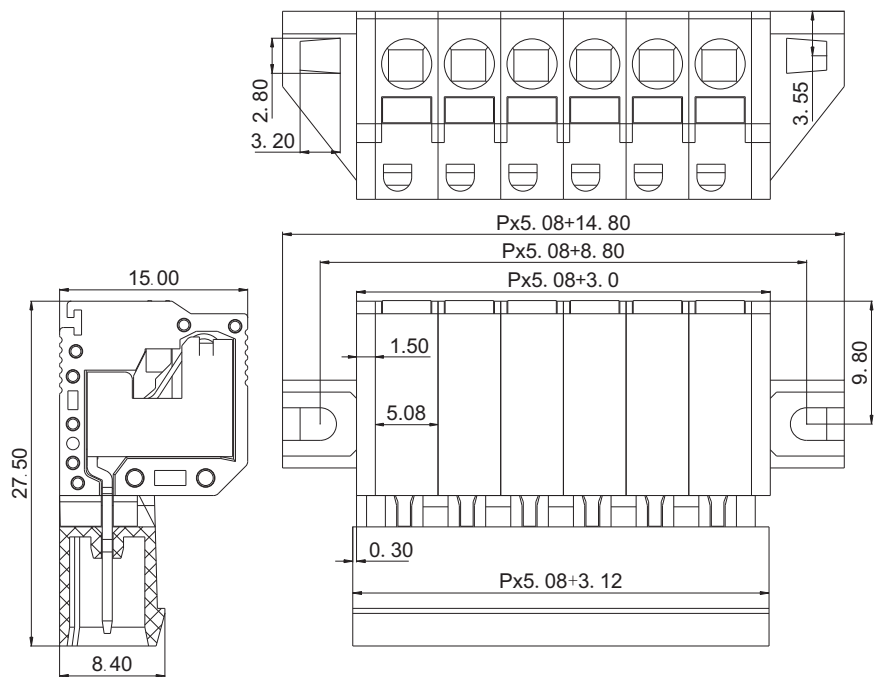

慈溪市科发电子有限公司

CIXI KEFA ELECTRONICS CO., LTD.

产品规格书

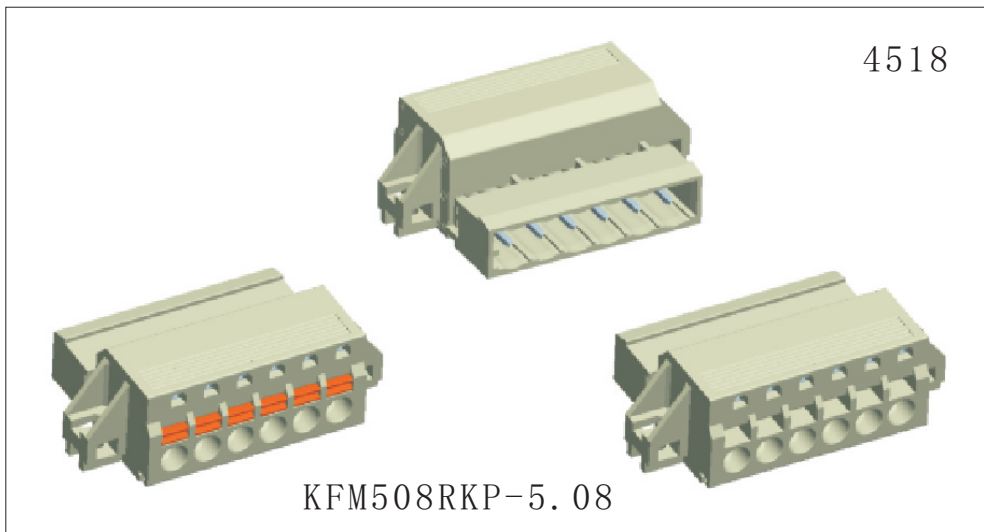

认证	CE	
电气性能		
参考标准	UL	IEC
额定电压	300V	300V
额定电流	10A	15A
使用线径	28-12 AWG	2.5mm ²
耐电压	AC2500V/1Min	
机械性能		
温度范围	-40℃—+105℃	
剥线长度	10.0-11.0mm	
尺寸		
间距	5.08mm	
极数	2P-24P	
材质及电镀		
塑体	PA66 UL94V-0	
脚子	紫铜 镀锡	
弹片	不锈钢	

订购方式:



mm (INCH)

KEFA 慈溪市科发电子有限公司 CIXI KEFA ELECTRONICS CO., LTD.

THIROANGIF PROJECTION

NAME KFM508RKP-5.08