

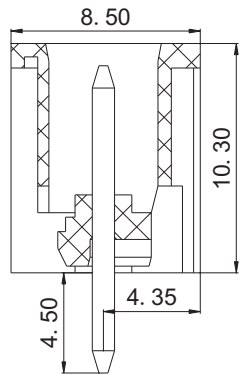

慈溪市科发电子有限公司

CIXI KEFA ELECTRONICS CO., LTD.

产品规格书

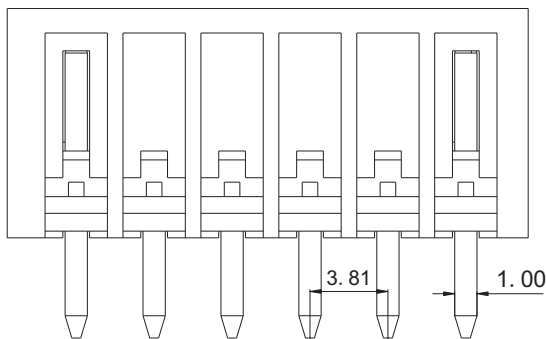
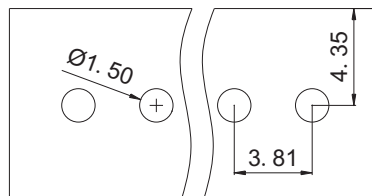
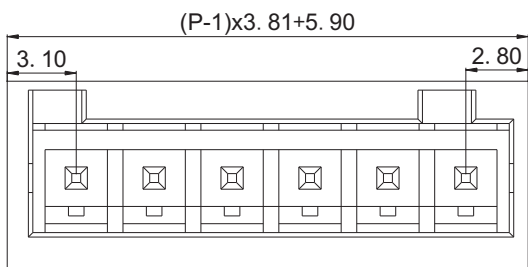
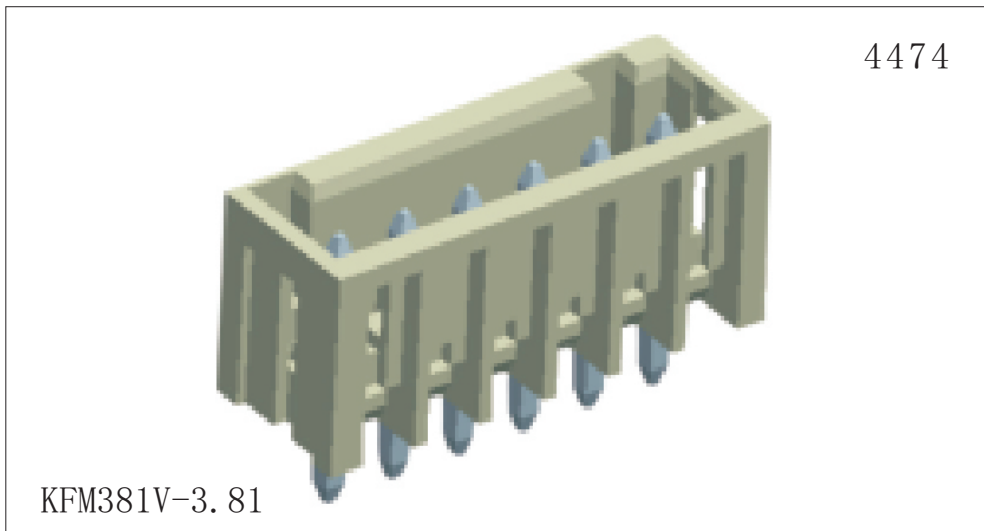

认证	CE	
电气性能		
参考标准	UL	IEC
额定电压	300V	250V
额定电流	8A	10A
耐电压	AC2000V/1Min	

机械性能	
温度范围	-40℃—+105℃

尺寸	
间距	3.81mm
极数	2P-24P

材质及电镀	
塑体	PA66 UL94V-0
焊针	黄铜 镀锡

订购方式:

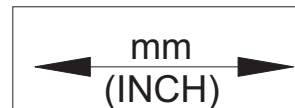
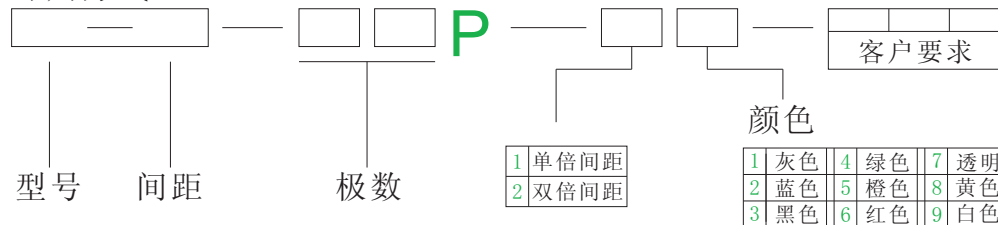

慈溪市科发电子有限公司
CIXI KEFA ELECTRONICS CO., LTD.

NAME KFM381V-3.81