

FEATURES

- 100 meters long distance stable transmission, optional POE power supply.
- Support external trigger and flash synchronization, up to 7 GPIO, all photoelectric isolation..
- Supports 8bit and 12bit lossless format output.
- Support multiple cameras work at the same time, the number is not limited, any networking.
- Unique data packet retransmission technology to ensure reliable data transmission.
- Supports PCLinux system and ARM Linux system.
- Compatible with VISION standard, drive free direct support for Halcon, VisionPro and other software.



SPECIFICATIONS

Parameter	Model	MV-31GC-GE	MV-31GM-GE
Sensor		1/3" CMOS	
Shutter		Global	
Color/Mono		Color	Mono
Pixel Size		6um x 6um	
Resolution		0.3MP	
Frame rate		752X480@108.25FPS	
Pixel bit depth		12bit	
Sensitivity		4.8 V/lux-sec@550nm	
GPIO		1 optical isolation input, 1 optical isolation output; Optional 3 input 4 output	
SNR		45dB	
Maximum gain		4	
Exposure time(ms)		0.017~57.1	
Dynamic range		55dB	
Frame buffer		128M Bytes	
Camera custom data		2K Bytes	
Video output format		Bayer GR 8/12bit	Mono 8/12bit
Visual standard protocol		GigE Vision V1.2, GenICam	
Lens mount		C/CS interface, provide adapter ring	
Data interface		Gigabit network, POE(optional)	
Power supply		12~24V/POE, 48~57V(POE is optional)	
Power		< 2.5W	
Dimensions		29(mm)X29(mm)X40(mm) (excluding lens base and rear shell interface)	
Weight		< 75g	
Working temperature		0~50°	
Storage temperature		-30~60°	
Operating system		WINXP, WIN7/8/10 32-bit & 64-bit systems, Linux and ARM Linux drivers, Android platform drivers, MAC OS systems	
Drivers		Directshow component Halcon Dedicated Component Labview Dedicated Driver OCX Component TWAIN component	
Programming language package		C/C++/C#/VB6/VB.NET/Delphi/BCB/Python/Java	

SPECTROGRAMS

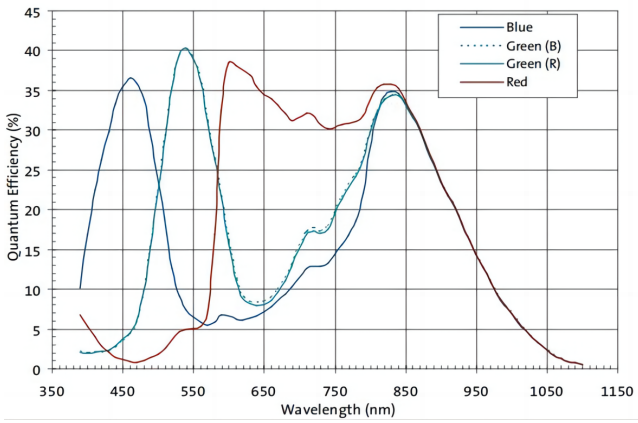

MV-31GC-GE

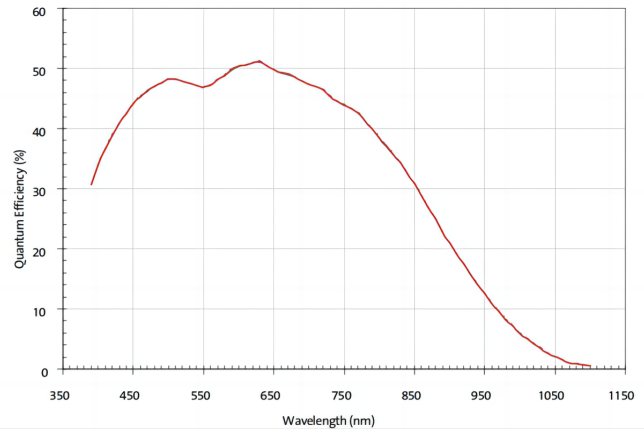

MV-31GM-GE

DIMENSIONS(Unit: mm)

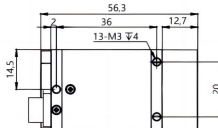
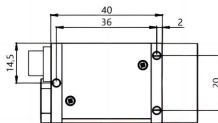
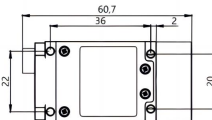
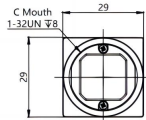
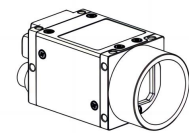

GE-T1-C

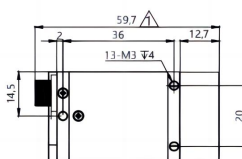
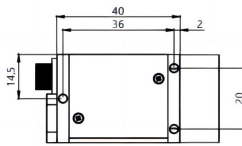
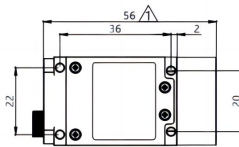
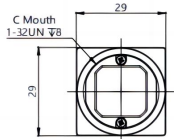
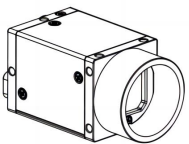
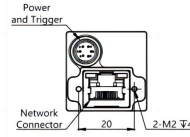
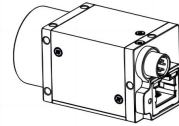

GE-T-CL

GE/GEF/GED cameratailselectiontable

Function Suffix	Defindigram of aviation head line sequence	PoE power supply	Dual aviation head extension IO	Shrapnel type aviation head interface	Thread type aviation head interface	Lens interface C-mount	Lens interface CS-mount	State
-T-CL	1				•	•		Recommend
-T-L	1				•		•	Reserve
-TPO-CL	2	•	•		•	•		Reserve
-T1-C	3			•		•		Recommend
-T1P-C	3	•		•		•		Reserve
-T	4			•				Plan to stop production
-TPO	5	•	•	•			•	Plan to stop production
-TPO-C	5	•	•	•		•	•	Plan to stop production

-T-CL、 -T-L Line sequencedefinition 1

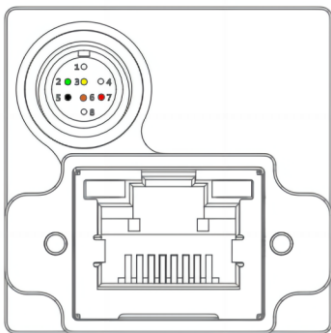

Port	Pin	Line Color	Signal Name	Signal Description	Remark	
PortA	1	white	GPI1+/TRIG_IN+	GPI1 positive end/Trigger input positive end	Default to trigger input	
	2	green	GPO1+/STRB_OUT +	GPO1 positive end/flash output positive end	Default flash output	
	3	yellow	GPO1-/STRB_OUT-	GPO1 negative end/flash output negative end	Default flash output	
	4	Empty foot				
	5	black	PWRGND	Camera power input negative end		
	6	brown <small>(High soft blue)</small>		GPI1-/TRIG_IN-	GPI1 negative end/Trigger input negative end	Default to trigger input
	7	red	PWR12V	Camera power input positive end		
	8	Empty foot				

-TPO-CL Line sequencedefinition 2

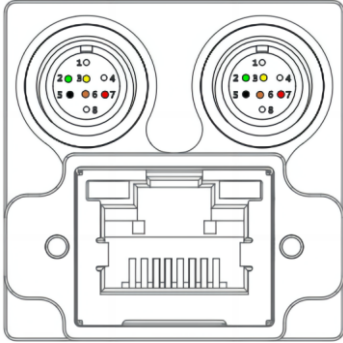

Port	Pin	Line Color	Signal Name	Signal Description	Remark
PortA	1	white	GPI1+/TRIG_IN+	GPI1 positive end/Trigger input positive end	Default to trigger input
	2	green	GPO1+/STRB_OUT +	GPO1 positive end/flash output positive end	Default flash output
	3	yellow	GPO1-/STRB_OUT-	GPO1 negative end/flash output negative end	Default flash output
	4	Empty foot			
	5	black	PWRGND	Camera power input negative end	
	6	brown <small>(High soft blue)</small>	GPI1-/TRIG_IN-	GPI1 negative end/Trigger input negative end	Default to trigger input
	7	red	PWR12V	Camera power input positive end	
	8	Empty foot			
PortB	1	white	GPO4+	GPO4 positive end output	
	2	green	GPO2+	GPO2 positive end output	
	3	yellow	GPO3+	GPO3 positive end output	
	4	Empty foot			
	5	black	GPIO_COM	GPIO public negative terminal	
	6	brown	GPI2+	GPI2 positive end input	
	7	red	GPI3+	GPI3 positive end input	
	8	Empty foot			

-T1-C、 -T1P-C Line sequencedefinition 3

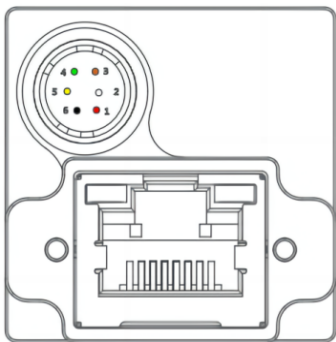

Port	Pin	Line Color	Signal Name	Signal Description	Remark
PortA	1	red	PWR12V	Camera power input positive end	
	2	white	GPI1+/TRIG_IN+	GPI1 Positive end/Trigger input positive end	Default to trigger input
	3	brown	GPO2+	GPO2 outputs the positive end	Empty foot
	4	green	GPO1+/STRB_OUT+	GPO1 Positive end/Flash output positive end	Default to flash output
	5	yellow	GPO1-/STRB_OUT- /TRIG_IN-	GPO1 negative end/flash output negative end/trigger input negative end	GPIO public negative end
	6	black	PWRGND	Camera power input negative end	

-T Linesequencedefinition 4

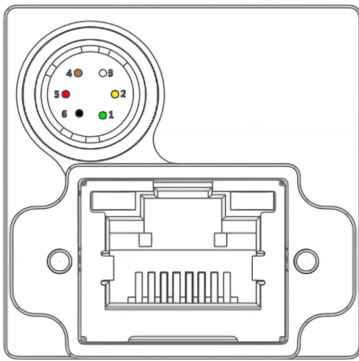

Port	Pin	Line Color	Signal Name	Signal Description	Remark
PortA	1	green	GPO1+/STRB_OUT+	GPO1 Positive end/Flash output positive end	Default to flash output
	2	yellow	GPO1-/STRB_OUT-	GPO1 Negative end/flash output negative end	Default to flash output
	3	white	GPI1+/TRIG_IN+	GPI1 Positive end/Trigger input positive end	Default to trigger input
	4	brown	GPI1-/TRIG_IN-	GPI1 negative end/Trigger input negative end	Default to trigger input
	5	red	PWR12V	Camera power input positive end	
	6	black	PWRGND	Camera power input negative end	

-TPO、 -TPO-C Linesequencedefinition 5

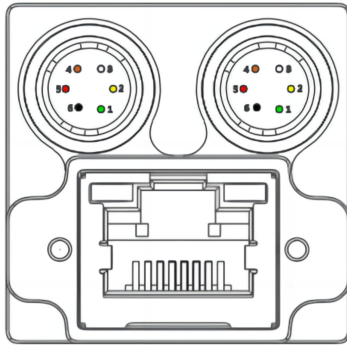

Port	Pin	Line Color	Signal Name	Signal Description	Remark
PortA	1	green	GPO1+/STRB_OUT+	GPO1 Positive end/Flash output positive end	Default to flash output
	2	yellow	GPO1-/STRB_OUT-	GPO1 Negative end/flash output negative end	Default to flash output
	3	white	GPI1+/TRIG_IN+	GPI1 Positive end/Trigger input positive end	Default to trigger input
	4	brown	GPI1-/TRIG_IN-	GPI1 negative end/Trigger input negative end	Default to trigger input
	5	red	PWR12V	Camera power input positive end	
	6	black	PWRGND	Camera power input negative end	
PortB	1	green	GPO2+	GPO2 positive end output	
	2	yellow	GPO3+	GPO3 positive end output	
	3	white	GPO4+	GPO4 positive end output	
	4	brown	GPI2+	GPI2 positive end input	
	5	red	GPI3+	GPI3 positive end input	
	6	black	GPIO_COM	GPIO public negative end	

C interface /CS interface camera diagram

Unit: mm

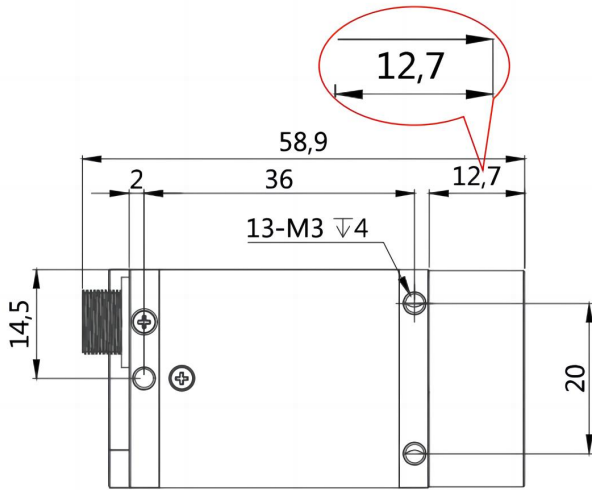

C interface lens

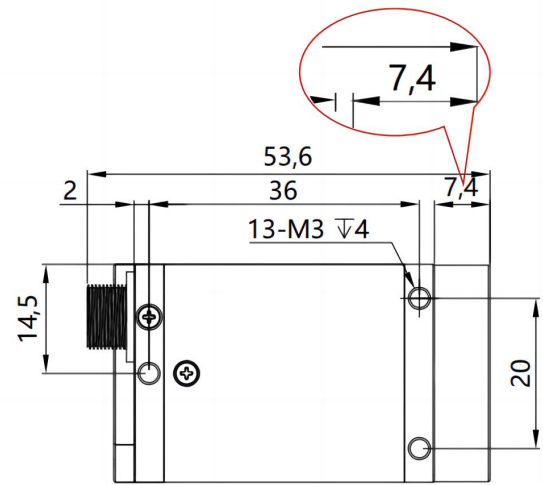

CS interface lens