

# Installation Manual

Compatible Model	CJetour CDashing
Year	2023



## 1. Points to note

- For safety and to ensure the proper use of product, please ask a professional technician to install. Do not disassemble and install it privately in case of damaging product and installation accidents.
- Please arrange each wiring harness according to the wiring method in this manual, be sure to tie each wiring harness to the vehicle's original wiring harness with cable ties. Make sure the wiring harnesses are not located at the fasteners or screw holes to avoid the wiring harnesses crushed by the vehicle interior trim panel buckles and screws during the installation process.
- Because some of the wiring harness terminals (as shown in the red ellipses below) are not inserted into the wiring harness connectors during manufacture, please insert terminals into the wiring harness connector first to avoid short circuit between terminals after the wiring harnesses have been arranged, then connect other plugs of the wiring harnesses (as shown in the blue ellipses below) with the original plugs.



- Check the function display of instrument panel before installation, whether the button of the vehicle is working properly, whether the doors and windows work properly while opening and closing, whether there are scratches on the internal and external surfaces of the vehicle; and report to the customers in a timely manner if there are any problems.
- During the process of disassembly and assembly, do not carry metal ornaments and other hard objects with you to prevent damage to the paintwork, seats and interior. Be sure to place the removed trim components properly to avoid scratching them.
- All the pictures in this manual are for reference only, vehicle models with different configurations may have different pictures, but the installation methods are the same.

## 2. Installation tools

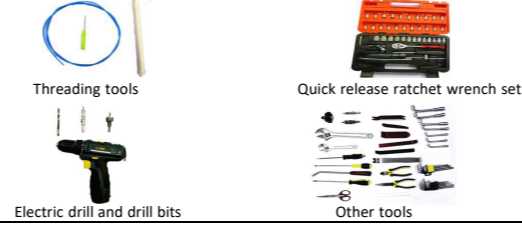

## 3. Product list

No.	Name	QTY	Picture
①	Strut	2	
②	ECU	1 set	
③	Wiring harness	1 set	
④	Power latch	1	
⑤	Added tailgate switch	1	
⑥	Other parts (screws, brackets, etc.)	1 set	Omitted



1. Remove the indicated driver side trim panel and door sill panels.



2. Remove the rear left door sill panel and B-pillar trim panel.



3. Remove the tailgate trim panels.



4. Remove the indicated trunk trim panels.



5. Remove the original gas struts.



6. Replace the left body bracket and pay attention to the direction.



7. Replace the left body bracket and pay attention to the direction.



8. Install the electric struts, L on the left and R on the right (the first letter of the strut code).



9. Thread the strut wiring harnesses through the indicated hole on both sides.



10. Route the strut wiring harness to the tailgate (routing first, then insert the terminals into the connector).

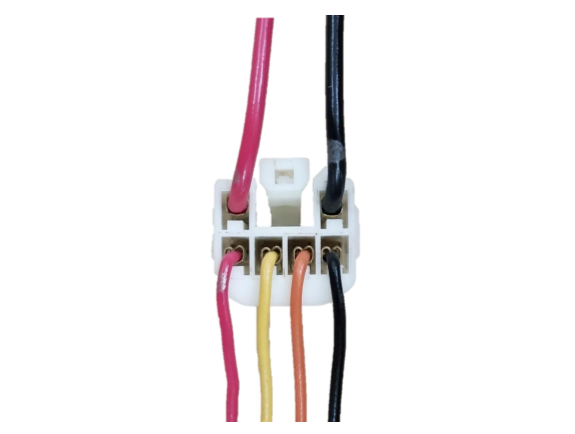

11. Insert the strut wiring harness terminals into the connector according to the diagram.



12. Remove the original latch, install the power latch with original screws and adjust the latch to the locked state.



13. Connect the plugs of the lock signal harness to the plugs of the power latch.



14. Remove the taillight and find out the plugs of the original tailgate switch

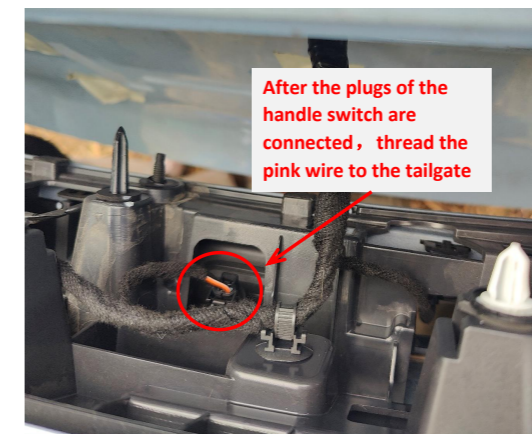



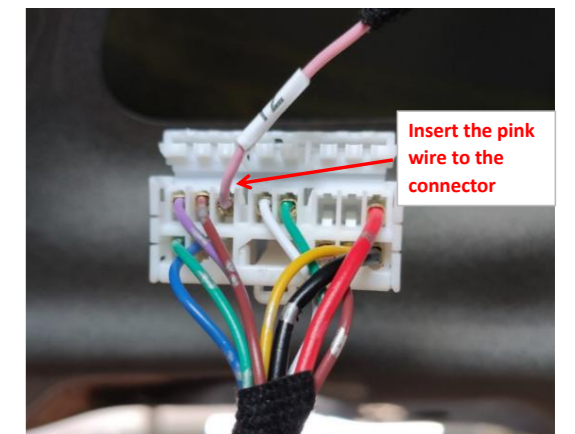

15. Connect the plugs with pink wire to the plugs of the original tailgate switch.



16. Insert the pink wire (No.12) into the indicated slot of the connector.



 <p>Power supply</p> <p>B-pillar signal</p> <p>ECU</p> <p>Grounding</p> <p><b>Routing only, no plug or power connection</b></p>		 <p>Note: For models with fewer than 10 wires, just insert them according to the corresponding label or color.</p>	 <p>Grounding</p>	
<p>17. Route the power harness as indicated.</p>	<p>18. Thread the power harness to the tailgate (routing only, no plug or power connection).</p>	<p>19. Insert the power harness terminals into the connector according to the diagram.</p>	<p>20. Ground at the indicated position on the left side of the trunk.</p>	<p>21. Move the original fuse from the fuse box to the fuse tap.</p>
 <p>Wire points to the left</p>	 <p>Connect to the B-pillar plugs</p>	 <p>The screw on the bracket can be adjusted freely , find a proper position for installation.</p>		
<p>22. Plug the fuse tap into the fuse box and pay attention to the direction.</p>	<p>23. Connect the signal plugs of the power harness to the B-pillar plugs.</p>	<p>24. Place an oval screw on the ECU bracket and mount the ECU onto the bracket.</p>	<p>25. Secure the ECU at the indicated position.</p>	<p>26. Insert the left and right strut wiring harnesses ① ②, lock signal harness ③, and power harness ④ into the ECU in sequence.</p>
 <p>27. Install the added tailgate switch (remove the original small cover).</p>	 <p>28. Press the added tailgate switch to close the tailgate once, the system completes initialization, and then test each function of the electric tailgate.</p>	<p><b>5. System initialization method</b></p> <ol style="list-style-type: none"> <li>1. Press the added tailgate switch button to make the tailgate close automatically;</li> <li>2. Press the switch button outside the tailgate to open the tailgate and it will make a long sound of "beep".</li> <li>3. The system initialization is complete.</li> </ol> <p><b>6. Instructions for the electric tailgate</b></p> <ol style="list-style-type: none"> <li>1. Methods to open and close the tailgate: <ul style="list-style-type: none"> <li>● Press and hold the tailgate button on the remote keys;</li> <li>● Press the unlock button at the driver's area 3 times;</li> <li>● Press the original tailgate switch button;</li> <li>● Press the added tailgate switch button.</li> </ul> </li> <li>2. Method to pause the tailgate: <ul style="list-style-type: none"> <li>During the operation of the tailgate, press the button with any of the above methods, and the tailgate will be paused. Press again, and the tailgate will move in reverse.</li> </ul> </li> </ol>	<p>3. Instructions for the added tailgate switch</p> <ol style="list-style-type: none"> <li>① Closing speed acceleration (5 Settings) <ol style="list-style-type: none"> <li>1. Press and hold the switch button until hearing the first short beep sound.</li> <li>2. After releasing the button, you will hear a short beep, indicating that the closing speed acceleration has taken effect.</li> <li>3. Repeat this step once to increase by one setting.</li> </ol> </li> <li>② Opening speed acceleration (5 Settings) <ol style="list-style-type: none"> <li>1. Press and hold the switch button until hearing the second short beep sound</li> <li>2. After releasing the button, you will hear two short beeps, indicating that the opening speed acceleration has taken effect.</li> <li>3. Repeat this step once to increase by one setting.</li> </ol> </li> <li>③ Settings of the voice module <ol style="list-style-type: none"> <li>1. Press and hold the switch button until hearing the third short beep sound.</li> <li>2. After releasing the button, you will hear three short beeps, indicating that the voice module has entered configuration mode. (For details, see the voice module operation manual)</li> <li>④ Block the voice module <ol style="list-style-type: none"> <li>1. Press and hold the added switch button until hearing the fourth beep sound.</li> <li>2. After releasing the button, you will hear three four beeps indicating that the voice module has been blocked.</li> </ol> </li> </ol> </li> </ol>	<ol style="list-style-type: none"> <li>⑤ Height setting <ol style="list-style-type: none"> <li>1. Press and hold the switch button until hearing the fifth short beep sound.</li> <li>2. After releasing the button, you will hear a long beep sound indicating that the height setting has taken effect.</li> </ol> </li> <li>⑥ Switch between quick/slow press of the unlock button on remote key <ol style="list-style-type: none"> <li>1. Press and hold the switch button until hearing the sixth short beep sound.</li> <li>2. After releasing the button, you will hear a long beep sound and a short beep sound indicating that the switch between quick and slow press of the unlock button has taken effect.</li> </ol> </li> <li>⑦ Switch between pressing the unlock button twice/three times <ol style="list-style-type: none"> <li>1. Press and hold the switch button until hearing the seventh short beep sound.</li> <li>2. After releasing the button, you will hear a long beep sound and two short beeps indicating that the switch between pressing the unlock button twice/three times has taken effect.</li> </ol> </li> <li>⑧ Braking force increase (five settings) <ol style="list-style-type: none"> <li>1. Press and hold the unlock button until hearing the eighth short beep sound.</li> <li>2. After releasing the button, you will hear a long beep sound and three short beeps indicating that the switch between pressing the unlock button twice/three times has taken effect.</li> <li>3. Repeat this step to increase by one setting.</li> </ol> </li> </ol>
<p>⑨ Restore to factory settings</p> <ol style="list-style-type: none"> <li>1. Press and hold the unlock button until hearing the ninth short beep sound.</li> <li>2. After releasing the button, you will hear a long beep sound and four short beeps indicating that the restoration to the factory setting has taken effect.</li> </ol> <p>4. Meanings of the buzzer sound:</p> <p>"Beep" once: Receiving an open/close or pause signal, the tailgate will immediately open/close or pause;</p> <p>"Beep" twice: The tailgate has been fully opened or closed;</p> <p>"Beep" three times: The resistance during opening or closing the tailgate is too large, and the intelligent anti-pinch has been turned on.</p>				