

# Installation Manual

Compatible Model	CGeely CCoolray
Year	2019-2021



## 1. Points to note

- For safety and to ensure the proper use of product, please ask a professional technician to install. Do not disassemble and install it privately in case of damaging product and installation accidents.
- Please arrange each wiring harness according to the wiring method in this manual, be sure to tie each wiring harness to the vehicle's original wiring harness with cable ties. Make sure the wiring harnesses are not located at the fasteners or screw holes to avoid the wiring harnesses crushed by the vehicle interior trim panel buckles and screws during the installation process.
- Because some of the wiring harness terminals (as shown in the red ellipses below) are not inserted into the wiring harness connectors during manufacture, please insert terminals into the wiring harness connector first to avoid short circuit between terminals after the wiring harnesses have been arranged, then connect other plugs of the wiring harnesses (as shown in the blue ellipses below) with the original plugs.



- Check the function display of instrument panel before installation, whether the button of the vehicle is working properly, whether the doors and windows work properly while opening and closing, whether there are scratches on the internal and external surfaces of the vehicle; and report to the customers in a timely manner if there are any problems.
- During the process of disassembly and assembly, do not carry metal ornaments and other hard objects with you to prevent damage to the paintwork, seats and interior. Be sure to place the removed trim components properly to avoid scratching them.
- All the pictures in this manual are for reference only, vehicle models with different configurations may have different pictures, but the installation methods are the same.

## 2. Installation tools

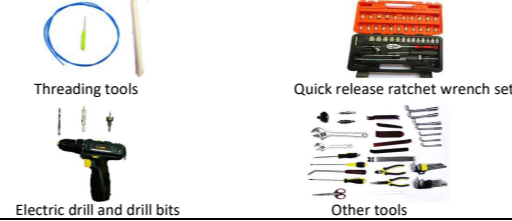

## 3. Product list

No.	Name	QTY	Picture
①	Strut	2	
②	ECU	1 set	
③	Wiring harness	1 set	
④	Power latch	1	
⑤	Added tailgate switch	1	
⑥	Other accessories (screws, brackets, etc.)	1 set	Omitted



1. Remove the front left side trim panel, door sill panel and storage box.



2. Remove the rear left door sill panel and B-pillar trim panel.



3. Remove the tailgate trim panels.



4. Take out the trunk floor mat and remove the trim panel on the left side of the trunk.



5. Remove the tailgate lamp covers on both sides.



6. Remove the indicated ball stud and the nut on the tailgate lamp.



7. Install the tailgate brackets on both sides.



8. Install the covers back after installing the tailgate brackets.



9. Replace the ball the studs on both sides.



10. Install the electric struts, L on the left and R on the right (the first letter of the strut code).



11. Thread the left and right strut wiring harnesses through the holes on both sides of the tailgate.



12. Route the strut wiring harnesses to the tailgate as indicated.



13. Leave a certain length of rubber tube outside to prevent it from being pulled during the movement of tailgate.



14. Remove the original latch.



15. Connect the plugs of the lock signal harness to the power latch.

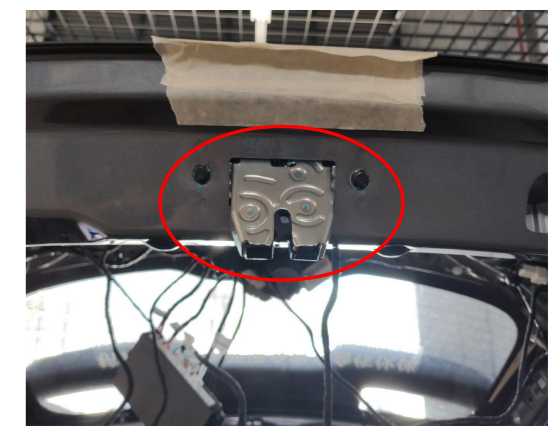

16. Install the power latch.



Separate

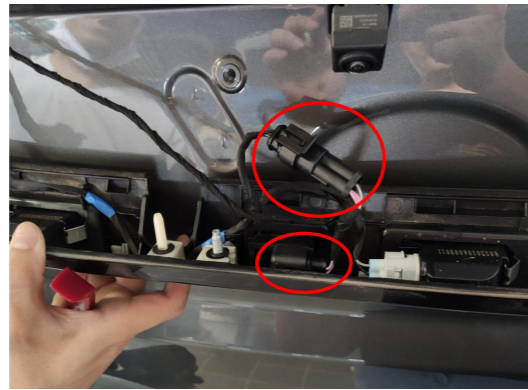

18. Connect the plugs of the lock signal harness to the original tailgate switch. Thread the pink wire into the tailgate along with the original wiring harness.

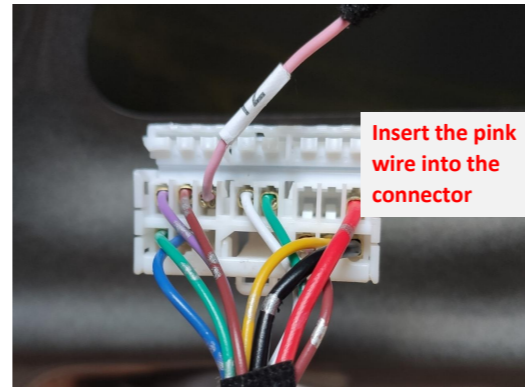

Insert the pink wire into the connector

19. Insert that pink wire into the connector of the lock signal harness and connect the lock signal harness to the added tailgate switch.

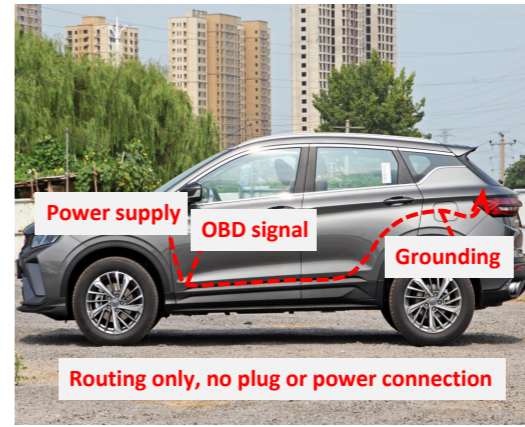

Power supply OBD signal Grounding

Routing only, no plug or power connection

20. Route the power harness (routing only, no plug or power connection).



21. Thread power harness to the tailgate.

17. Separate the trim strip from the tailgate.

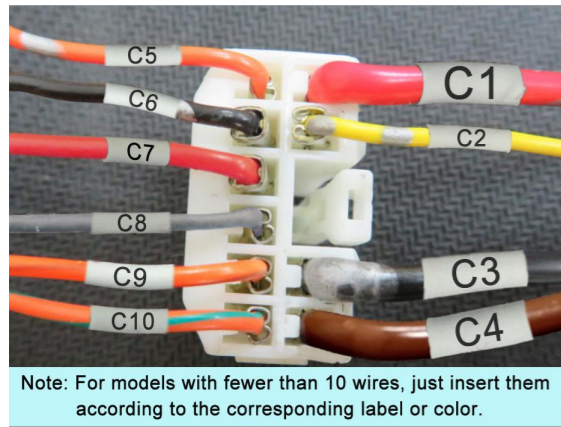

Note: For models with fewer than 10 wires, just insert them according to the corresponding label or color.



Grounding

23. Ground at the indicated position on the left side of the trunk.



24. Connect to the OBD plug at the driver's position.

Check if all the plugs are properly connected.

25. Check all the plugs.

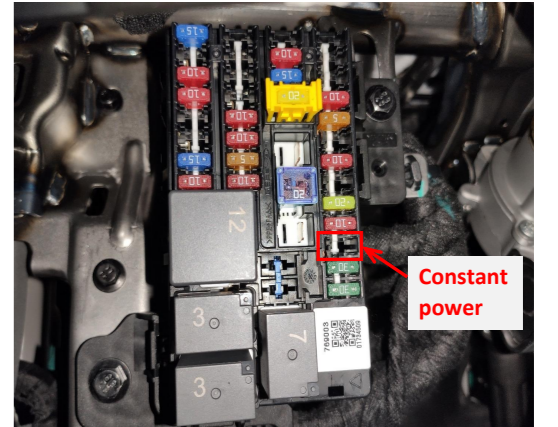

Constant power

26. The fuse box is located at the driver's position and the fuse slot for power supply is as indicated.

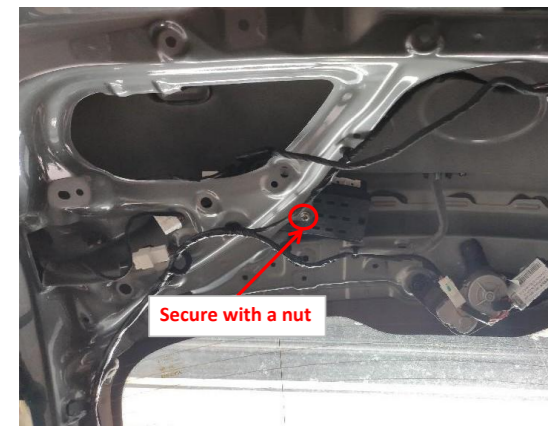

Secure with a nut



28. Insert the strut wire harnesses ①②, lock signal harness ③, and power harness ④ into the ECU in sequence.

27. Secure the ECU at the indicated hole with a nut.

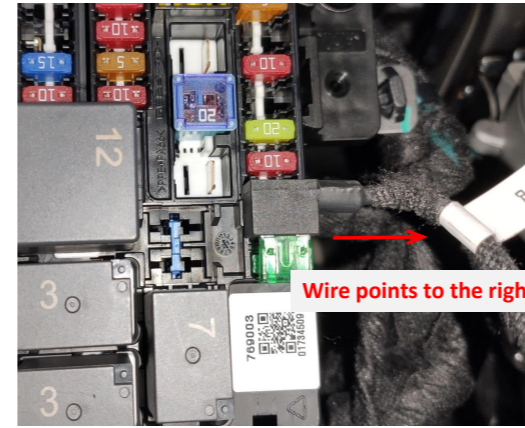

Wire points to the right

29. Plug the fuse tap into the fuse box and pay attention to the direction.



30. Press the added tailgate switch to close the tailgate once, the system completes initialization, and then test each function of the electric tailgate.



31. Install all trim panels back and fit the added tailgate switch in (remove the original small cover).

**5. System initialization method**

1. Press the added tailgate switch button to make the tailgate close automatically;
2. Press the switch button outside the tailgate to open the tailgate and it will make a long sound of "beep".
3. The system initialization is complete.

**6. Instructions for the electric tailgate**

1. Methods to open and close the tailgate:
  - Press and hold the tailgate button on the remote key;
  - Press the unlock button on the remote key 3 times;
  - Press the unlock button at the driver's position 3 times;
  - Press the original tailgate switch button;
  - Press the added tailgate switch button.

**2. Method to pause the tailgate:**

During the operation of the tailgate, press the button with any of the above methods, and the tailgate will be paused. Press again, and the tailgate will move in reverse.

**3. Method to memorize the height:**

Open the tailgate to the height you want to set, long press the added tailgate switch, and release the switch after hearing a long "beep ----". The height memory is complete.

Tip: During the operation of the tailgate, pause the tailgate, and then push the tailgate to the ideal height with your hand.

**4. Meanings of the buzzer sound:**

- "Beep" once: Receiving an open/close or pause signal, the tailgate will immediately open/close or pause;
- "Beep" twice: The tailgate has been fully opened or closed;
- "Beep" three times: The resistance during opening or closing the tailgate is too large, and the intelligent anti-pinch has been turned on;
- Long sound of "beep": The height memory is complete.