

全心全意·只做配件
With All Your Heart For Accessories

江苏宏仕达环保科技有限公司
Jiangsu Hongshida Environmental Technology Co., Ltd.

江苏省张家港市锦丰镇合兴星火村龙潭湾路1号

No.1 Longtanwan Road, Hexing Xinghuo Village, Jinfeng Town, Zhangjiagang City, Jiangsu Province.
China·215626

Email:Info@hongshidafilter.com

Web:www.hongshidafilter.com



江苏宏仕达环保科技有限公司
Jiangsu Hongshida Environmental Technology Co. ,Ltd.



公司简介

Company Introduction

江苏宏仕达环保科技有限公司成立于2012年04月25日，是一家集产品研发、生产制造、品牌运营，销售贸易及售后服务于一体的高新技术企业，公司占地面积10000余平米，固定资产5000多万，现有员工100余人，各类专业技术研发人员15人，质量检测人员10人，拥有20多项实用新型专利证书。能够独立自主完成车、铣、刨、磨、钻、线切割、冲压、折弯、卷板、焊接、热处理等生产工艺流程。

公司秉持“为客户解决问题，就是我们存在的价值和意义”。专业生产销售各种环保过滤设备配件，包括各种过滤器滤芯端盖、异形盖等五金冲压、铝压铸制品、注塑制品、金属网，以及各种规格的密封条、密封圈等产品，致力为全球客户提供优质的产品、先进高效的一站式采购服务和技术支持。

Jiangsu Hongshida Environmental Technology Co., Ltd. was founded on April 25, 2012. It is a high-tech enterprise integrating product research and development, manufacturing, brand operation, sales and trade, and after-sales service. The company covers an area of over 10,000 square meters, with fixed assets of over 50 million yuan. It has more than 100 employees, including 15 professional technical research and development personnel and 10 quality inspection personnel. It holds more than 20 utility model patent certificates. The company can independently complete various production processes such as turning, milling, planing, grinding, drilling, wire cutting, stamping, bending, rolling, welding, and heat treatment.

Adhering to the philosophy of "solving problems for customers is the value and significance of our existence," the company specializes in the production and sales of various environmental protection filtration equipment accessories, ranging from precision metal stamping parts, aluminum die-casting components, injection molded products, metal meshes, to filter cartridge end caps, special-shaped caps, sealing strips and seals of diverse specifications. It is committed to providing global customers with quality products, advanced and efficient one-stop procurement services, and technical support.



专利证书

Patent Certificate



CONTENTS

产品目录

01	滤芯圆形上下盖	Filter Cartridge Round End Cover
02	拉伸金属网	Expanded Metal Mesh
03	冲孔网	Perforated Metal Mesh
04	方形盖/卡盘盖	Square Cover/Chuck Cover
05	法兰盖	Flange Cover
06	螺纹盖	Thread Cover
07	花板(褶式长滤筒花板/BHA/踩入式端盖)	Pleated Bag Filter For Cell Plate Design End Cap
08	塑料制品	Plastic Products
09	除尘器配件	Dust Collector Accessories
10	滤芯长端盖	Filter Cartridge Long End Cover
11	密封件	Seal Elements

01 滤芯圆形上下盖

FILTER CARTRIDGE ROUND END COVER



材料

Materials

镀锌板、铝板、304/316L不锈钢板等材质
Galvanized sheet, aluminum sheet, 304/316L stainless steel sheet, etc.

表面处理

Surface Treatments

喷塑、镀锌、镀铬、阳极氧化等 注:可粘贴密封圈(PU, EPDM, EVA, 毛毡等)
Powder coating, galvanizing, chroming, anodizing, etc.

特点

Feature

- 产品规格、种类齐全,能满足行业常规的需求,接受客户非标定制产品
 - 产品按照标准生产、检测、销售。严格要求产品端面平整度、光洁度等技术指标
- Complete product specifications and types, which can satisfied with the requirement of the industry, and support customized products.
 - Products are produced, tested and sold in accordance with standards. Strictly require flatness of product end surface, smoothness and other technical indicators.

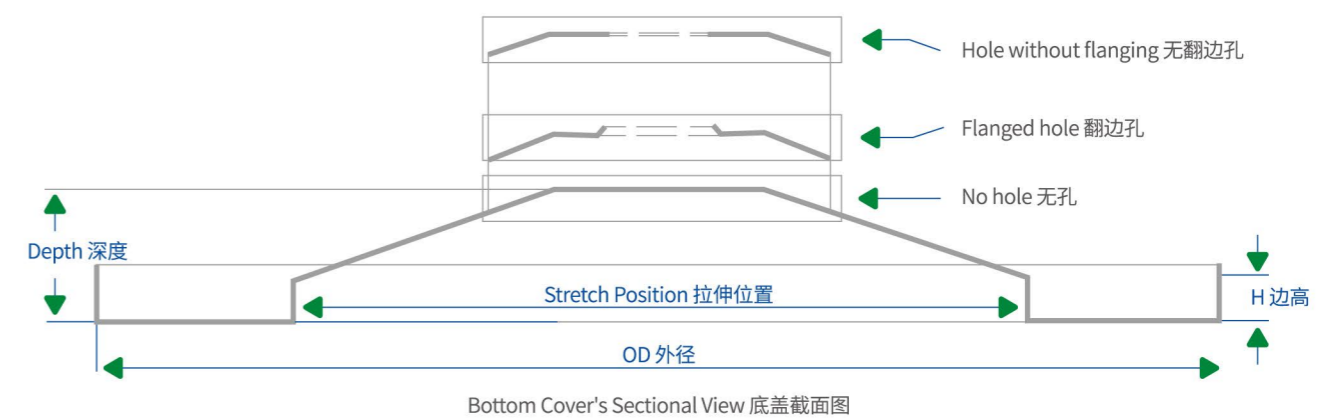

SPECIFICATIONS 规格表

可做厚度 0.5 0.6 0.8 1.0 1.2 2.0

外径(OD)X内径(ID)	外径(OD)X内径(ID)	外径(OD)X内径(ID)	外径(OD)X内径(ID)	外径(OD)X内径(ID)	外径(OD)X内径(ID)
43x22	120x80	146x95	165x85	190x115	210x110
55x20反口	120x90	146x97	165x86	190x120	210x115
60x28	122x65	146x100	165x90	190x133	210x120
65x30	122x75	150x46	165x95	196x40	210x125
71.5x24	125x55	150x50	165x100	196x50	210x130
80x30	125x65	150x60	170x70	196x60	210x133
80x46	125x70	150x65	170x85	196x75	210x140
88x30	125x75	150x70	170x90	196x85	210x145
88x40	125x80	150x75	170x95	196x100	210x150
88x46	125x85	150x80	170x100	196x105	210x152
95x46	125x90	150x85	170x110	196x110	210x155
95x50	127x72	150x88	170x115	196x115	210x180
95x58	128x65	150x90	175x70	196x120	212x110
96x55	128x70	150x95	175x75	196x133	215x80
100x30	128x75	150x100	175x80	196x135	215x90
100x40	128x85	150x110	175x85	196x145	215x100
100x50	130x58	152x63	175x90	197x157	215x120
100x46	130x65	152x65	175x100	200x40	215x125
100x55	130x90	152x70	175x110	200x46	215x130
100x60	133x75	152x75	175x120	200x50	215x140
100x70	133x77	152x80	180x60	200x60	215x145
103.8x63	133x80	152x85	180x70	200x65	215x152
104x52	133x90	152x90	180x75	200x70	215x155
105x40	135x60	152x100	180x80	200x80	215x160
105x95	135x65	155x90	180x85	200x85	220x90
110x30	135x75	156x70	180x90	200x90	220x100
110x46	135x85	156x80	180x100	200x95	220x110
110x50	135x90	156x85	180x105	200x96.8	220x120
110x55	140x60	156x90	180x110	200x100	220x125
110x60	140x65	156x100	180x115	200x105	220x135
110x70	140x70	160x46	180x120	200x110	220x140
110x75	140x75	160x50	180x130	200x115	220x145
110x80	140x80	160x55	180x140	200x120	220x152
114x84	140x85	160x60	185x60	200x122	220x160
115x46	140x90	160x65	185x70	200x125	225x110
115x60	140x100	160x70	185x75	200x133	225x115
115x65	142x75	160x75	185x85	200x135	225x120
115x70	142x80	160x80	185x90	200x140	225x125
115x75	142x90	160x85	185x95	200x145	220x135
115x83	144x85	160x90	185x100	200x152	225x140
118x60	145x80	160x95	185x115	200x155	225x145
118x75	146x46	160x100	185x120	200x160	220x152
118x80	146x50	160x105	185x133	202x85	225x160
120x46	146x60	160x110	190x60	202x90	227x115
120x50	146x65	160x115	190x70	202x100	227x120
120x55	146x70	160x120	190x80	202x140	227x133
120x60	146x75	160x130	190x85	202x145	227x145
120x65	146x80	160.7x90.3	190x90	202x152	227x152
120x70	146x85	165x75	190x100	210x100	230x40
120x75	146x90	165x80	190x110	210x105	230x46

外径(OD)X内径(ID)	外径(OD)X内径(ID)	外径(OD)X内径(ID)	外径(OD)X内径(ID)	外径(OD)X内径(ID)	外径(OD)X内径(ID)
230x60	250x75	270x240	300x225	340x210	390x250
230x70	250x90	275x75	307x155	340x220	390x255
230x90	250x100	275x90	307x196	340x230	390x260
230x100	250x120	275x115	307x200	340x240	390x292
230x105	250x130	275x145	310x200	340x255	400x180
230x115	250x140	275x150	310x210	340x300	400x200
230x120	250x145	275x155	310x220	348x230	400x240
230x125	250x150	275x160	310x230	348x260	400x255
230x130	250x152	275x165	315x190	350x170	400x270
230x133	250x160	275x170	315x210	350x190	400x292
230x140	250x170	275x175	315x220	350x200	400x300
230x145	250x175	275x190	315x225	350x210	406x255
230x146	250x180	275x200	315x250	350x220	406x270
230x152	255x75	275x210	315x265	350x240	406x290
230x155	255x80	275x220	320x150	350x255	406x292
230x160	255x90	275x225	320x152	350x260	406x301
230x165	255x133	280x90	320x175	351x241	409x294
230x170	255x155	280x133	320x190	351.5x241	410x255
235x120	255x160	280x135	320x200	352x240	410x270
235x133	255x170	280x150	320x210	360x125	410x292
235x140	255x200	280x160	320x215	360x133	410x301
235x145	260x46	280x170	320x220	360x160	410x335
235x149	260x80	280x180	320x225	360x200	413x295
235x152	260x125	280x200	320x230	360x210	415x365
235x160	260x133	280x210	320x240	360x220	420x255
235x175	260x140	280x220	320x250	360x225	420x310
240x85	260x145	290x60	324x130	360x230	420x320
240x90	260x152	290x100	324x152	360x240	430x330
240x105	260x155	290x115	324x160	360x250	445x160
240x110	260x160	290x175	324x180	360x255	445x255
240x120	260x170	290x180	324x190	360x280	445x292
240x133	260x175	290x190	324x210	360x292	445x300
240x135	260x176.4	290x200	324x213	360x301	455x301
240x140	260x190	290x210	324x215	370x210	445x310
240x145	260x200	290x220	324x220	370x230	445x330
240x150	260*210	290x230	324x225	370x255	445x335
240x152	265x105	299x186x1.3	330x80	370x260	447x332
240x160	265x135	300x110	330x90	370x270	480x292
240x180	265x140.2	300x120	330x160	370x292	480x370
245x195	265x145	300x133	330x190	375x325	498x358
248x125	265x152	300x135	330x200	380x200	498x420
248x133	265x154	300x152	330x210	380x210	500x100
248x140	265x155	300x160	330x220	380x220	500x400
248x145	265x165	300x165	330x225	380x240	518x360
248x152	265x190	300x175	330x230	380x255	518x400
248x155	265x200	300x180	330x255	380x260	560x445
248x160	265x210	300x190	335x220	380x270	560x460
248x175	265x220	300x200	335x230	380x292	580x470
248x180	270x193	300x210	335x255	390x200	595x505
248x200	270x220	300x220	340x200	390x246	

02 拉伸金属网

EXPANDED METAL MESH

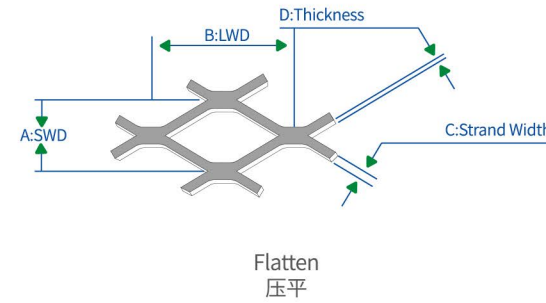
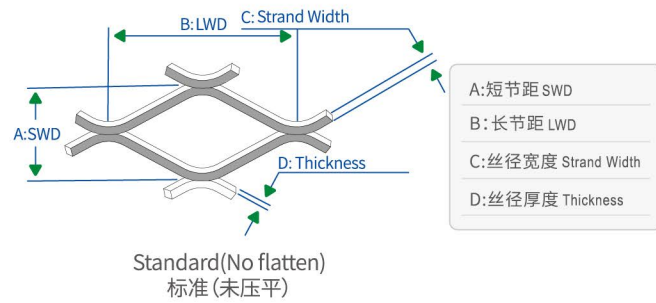
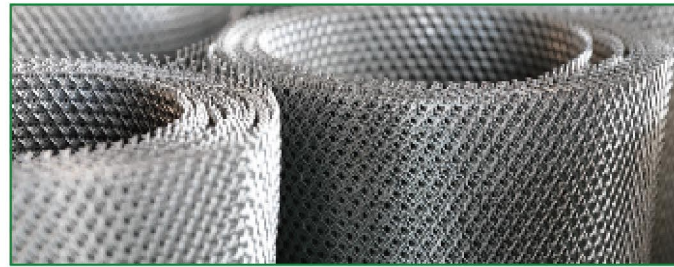

材料 Materials	低碳钢、热镀锌、不锈钢、铝、铜、镁铝合金等金属板 Low carbon steel, galvanized, stainless steel, aluminum, copper, magnesium aluminum alloy and other metal plates
表面处理 Surface Treatments	粉末喷镀、电镀锌等 Powder spraying, galvanizing, etc
应用范围 Application	防护装置、人行护栏、栅栏、建筑外立面、筛分过滤、楼梯踏板、户外遮阳等 Protection device, pedestrian guardrail, fence, building facade, screening and filtering, stair treads, outdoor shading, etc

CODE	SWD(MM)	LWD(MM)	STRAND WIDTH(MM)	THICKNESS(MM)
10x20	11.3	20	0.8-1.4	0.6-2.0
8x16	8	16		
7x12	7	12		
2x3	2	3		
4x6	4	6		

03 冲孔网

PERFORATED METAL MESH

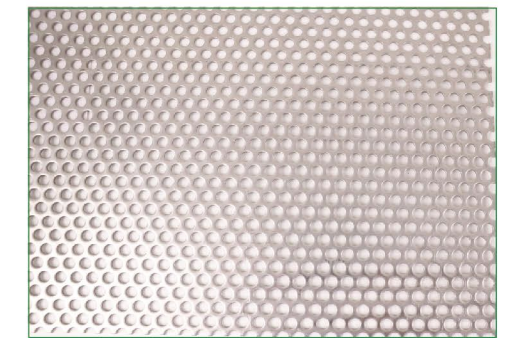
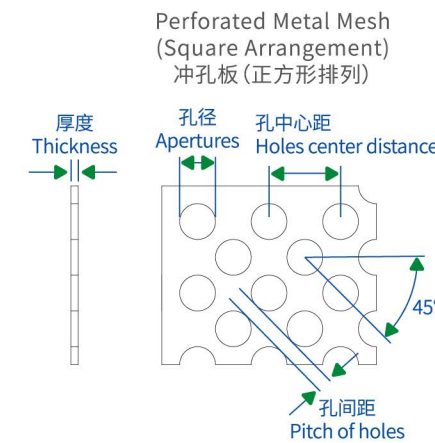
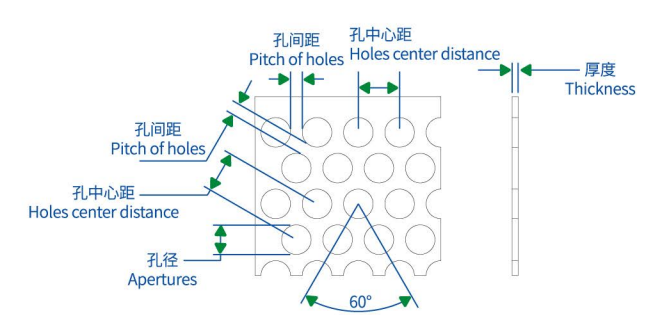
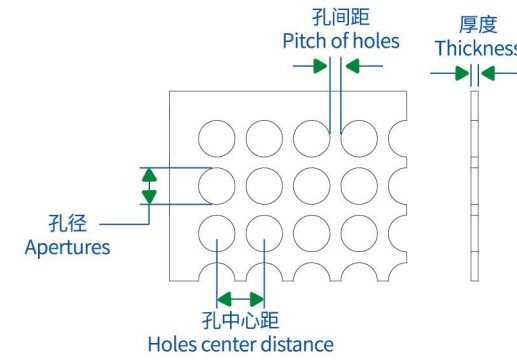

材料 Materials	不锈钢、碳钢、PVC、铝、铜等其他板材 Stainless steel, carbon steel, PVC, aluminum, copper and other plates; coating, galvanizing, chroming, anodizing, etc.
孔型 Hole type	圆孔、菱形孔、六角形孔、三角孔、方孔、长圆孔、梅花孔等其他不规则孔 Round hole, diamond hole, hexagonal hole, triangle hole, square hole, long round hole, plum hole and other irregular holes
用途 Application	过滤、通风、防尘、隔热、装饰、围栏等 Filtration, ventilation, dust prevention, heat insulation, decoration, fence, etc

04 方形盖/卡盘盖

SQUARE COVER/CHUCK COVER



- 滑杆式安装, 维护方便快捷
- 顶部开口, 底部封底
- 镀锌防锈金属材质结构件
- 搭配橡胶密封圈
- Slide rod installation, make the installation convenient and fast
- Top open, bottom closed
- Material: Galvanized anti-rust metal
- Option: With rubber gasket

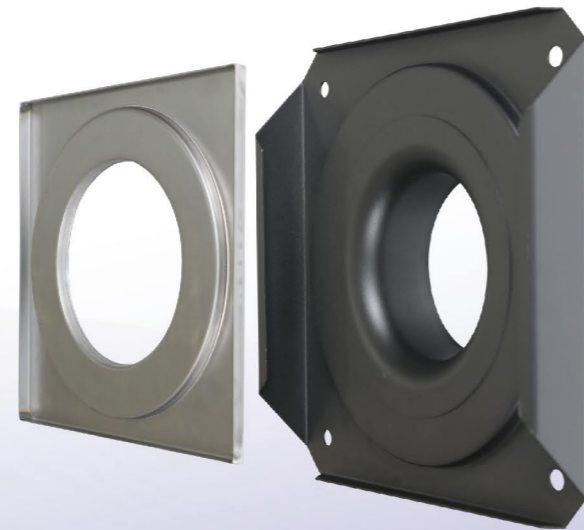

产品 Product	编号 Number	产品 Product	编号 Number	产品 Product	编号 Number
	HSD-FG-1 406x362带2孔 圆角 Filleted corner		HSD-FG-2 280x250x0.8/1.0 圆角 Filleted corner		HSD-FG-3 370x370x2.0 直角 Rectangular corner
	HSD-FG-4 370x370x213 焊支撑环 Weld support ring		HSD-FG-5 380x380x2.5 带文氏管 Weld Venturi tube		HSD-FG-6 圆缺角 Filleted notch corner
	HSD-FG-7 424x406x2.0 斜缺角 Oblique notch corner		HSD-FG-8 406x362x2.0 直缺角 Rectangular notch corner		HSD-FG-9 406x362x1.2/ 1.0/0.8 圆角 Filleted corner

05 法兰盖

FLANGE COVER



材料 Materials

镀锌板、冷轧碳钢板、不锈钢、铝等
Galvanized plate, cold-rolled carbon steel plate, stainless steel plate, aluminum, etc

加工工艺 Processing Technology

冲压、焊接、铝压铸等
Stamping, welding, aluminum die casting, etc

产品样式 Product Style

三耳、四耳设计
3-lugs, 4-lugs design

注: 可加装文氏管
Note: Venturi tube can be added

产品 Product	编号 Number	产品 Product	编号 Number
	HSD-LG-1		HSD-LG-2
	HSD-LG-3		HSD-LG-4
	HSD-LG-5		HSD-LG-6

06 螺纹盖 THREAD COVER

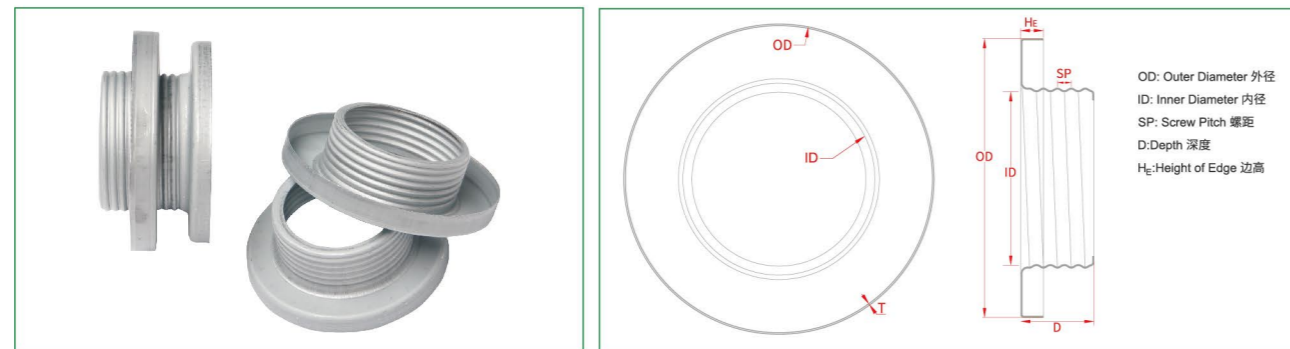

材料 Materials	镀锌板、不锈钢板 Galvanized plate, stainless steel plate
表面处理 Surface Treatments	电镀锌、粉末喷涂等 Galvanizing, powder spraying, etc
特点 Note	1.规格齐全、种类多样 2.多种螺距可选 1.Complete specifications, variety 2.Various pitch options

编号 Code	产品名称 Product Name	外径(OD) X内径(ID) Outer Diameter Xinner Diameter	备注 Remark
1	旋转螺纹盖 Thread Cover	118x58	2-piece(不带齿) 两件套
2	旋转螺纹盖 Thread Cover	120x72	3-piece(不带齿) 三件套
3	旋转螺纹盖 Thread Cover	120x73	3-piece(不带齿) 三件套
4	旋转螺纹盖 Thread Cover	120x74	3-piece(Regular/toothed) 三件套
5	旋转螺纹盖 Thread Cover	146x80	3-piece(不带齿) 三件套
6	旋转螺纹盖 Thread Cover	150x80	3-piece(不带齿) 三件套
7	旋转螺纹盖 Thread Cover	150x98	2-piece(不带齿) 两件套
8	旋转螺纹盖 Thread Cover	152x100	3-piece(不带齿) 三件套
9	旋转螺纹盖 Thread Cover	160x100	3-piece(不带齿) 三件套
10	旋转螺纹盖 Thread Cover	200x135	3-piece(不带齿) 三件套
11	旋转螺纹盖 Thread Cover	275x175	2-piece(不带齿) 两件套
12	旋转螺纹盖 Thread Cover	300x215	3-piece(带齿) 三件套

Note:The 2-piece contains the female thread cover and bottom cover,and the 3-piece contains the male thread cover, female thread cover and bottom cover
两件套指外螺纹盖+底盖、三件套指内外螺纹盖和底盖

07 花板 (褶式长滤筒花板/BHA/踩入式端盖) PLEATED BAG FILTER FOR CELL PLATE DESIGN END CAP

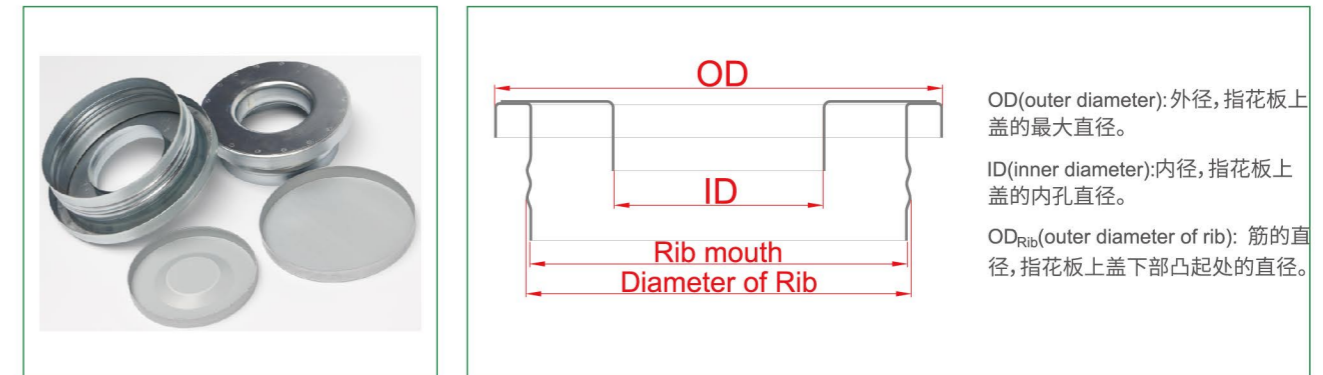

材料 Materials	镀锌板、不锈钢板 Galvanized plate, stainless steel plate
------------------------	---

编号 Code	产品名称 Product Name	外径(OD) X筋口X内径(ID) Outer Diameter X Rib Mouth X inner Diameter	筋的直径 The Diameter Of The Rib
1	花板125	142x115x65孔	116.5-117.5
2	花板127	142x117x65孔	119-120
3	花板133	152x120x73孔	125.5-126.5
4	花板133	152x122x65孔	125-126
5	花板138	156x126x75孔	130-131
6	花板143	165x131x80孔	135-136
7	花板151	178x140x83孔	141.5-142.5
8	花板155	178x145x83孔	146.5-147.5
9	花板162	178x150x83孔	152.5-153
10	花板166	185x153x83孔	156-157
11	花板176	194x163x95孔	166-167
12	花板206	232x196x105孔	202-203

适配密封圈 Suitable Sealing Ring	可选三元乙丙橡胶、硅胶、布袋涨圈(65Mn 钢圈+聚酯布套)等 Optional epdm rubber, silicone, cloth bag ring (65mn steel ring + polyester cloth cover)
---------------------------------------	---

08 塑料制品 PLASTIC PRODUCTS

公司现有注塑设备十余台,各类型注塑模具百余款,除满足过滤行业客户的配件需求外,还生产各类包装,装饰等塑料配件。依托公司现有技术团队,公司也对外承接客户产品日益丰富的定制化需求——模具加工制作等

Our company currently has more than ten injection molding equipment and more than 100 types of injection molds, in addition to meeting the accessories needs of customers in the filtration industry, it also produces various types of packaging, decoration and other plastic accessories, Relying on the company's existing technical team, the company also undertakes the increasingly rich customized needs of customers products mold processing and production, etc.



Folding Storage Box
折叠式收纳箱



4-Lugs End Cover
四耳盖



3-Lugs End Cover With Venturi-tube
三耳法兰盖配文氏管

产品 Product	编号 Number	产品 Product	编号 Number	产品 Product	编号 Number
	HSD-SL-1		HSD-SL-2		HSD-SL-3
	HSD-SL-4		HSD-SL-5		HSD-SL-6
	HSD-SL-7		HSD-SL-8		HSD-SL-9
	HSD-SL-10		HSD-SL-11		HSD-SL-12
	HSD-SL-13		HSD-SL-14		HSD-SL-15
	HSD-SL-16		HSD-SL-17		HSD-SL-18

09 除尘器配件 DUST COLLECTOR ACCESSORIES

我公司目前主营除尘器系列配件有：除尘器检修盖板、S形骨架、圆片形骨架、手柄、文丘里管、盖板用密封圈，自洁式反吹喷头。规格型号多样，欢迎客户来图来样定制加工。

Our company currently specializes in a range of accessories for dust collectors, including: Dust Collector Cover Plates, S-type (round-type) filter frames, hand shanks, Venturi tubes, sealing rings for covers, and split plastic nozzles. We offer a variety of specifications and models, and welcome customers to customize and process products according to their drawings and samples

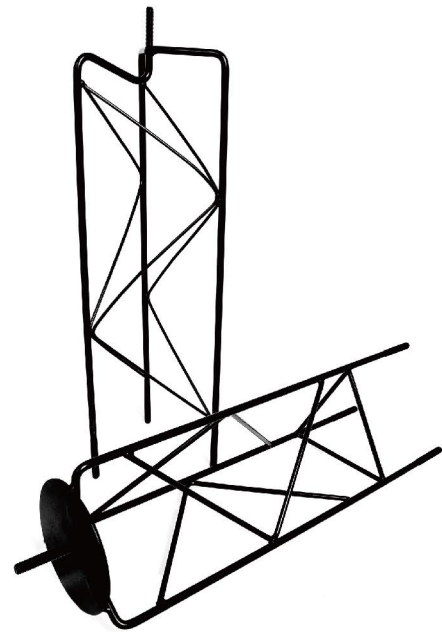
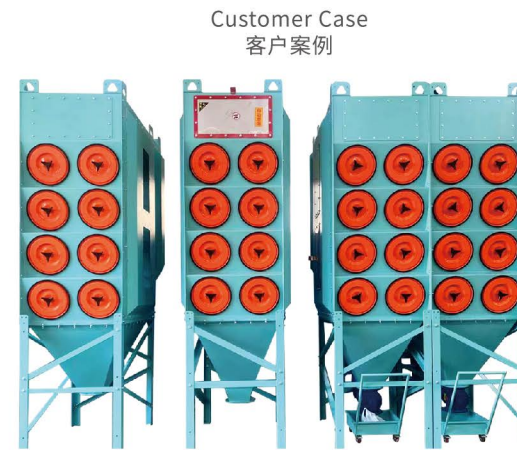

骨架合集
Filter Frames

可做高度660mm、1320mm
Can be made to a height of 660mm、1320mm

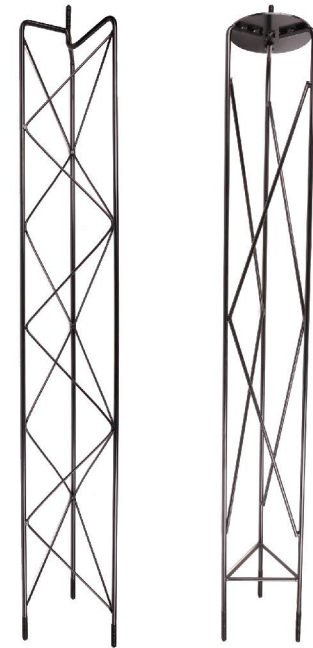

除尘器盖板 Dust Collector Cover Plate



盖板配件全图 Cover Plate Fittin



三角手柄 Triangle Handle



喷头 Air Nozzle



橡胶凸垫 Convex Rubber Gasket



文氏管集合 Venturi-tube

10 滤芯长端盖 FILTER CARTRIDGE LONG END COVER

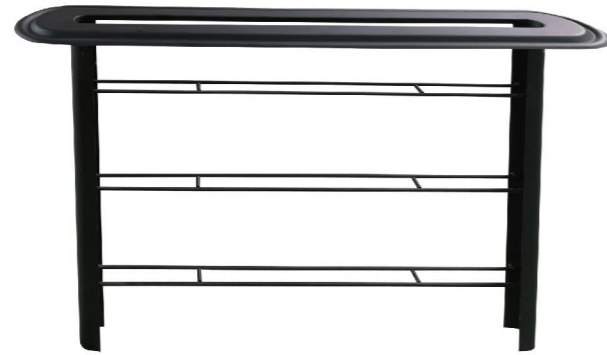

材质 Materials	冷轧碳钢板、304不锈钢材质等 Cold-rolled carbon steel plate, 304 stainless steel material, etc
表面处理 Surface Treatments	电镀锌、粉末喷涂等 Electrogalvanizing, powder spraying, etc.
其他配件 Filter element form	搭配底盖、橡胶密封圈 Apply laser cutting dust filter cartridge

产品名称 Product name	编号 Number	规格/单位(mm) Specification/Unit(mm)
	HSD-CG-1	上盖Top Cover 498x100x0.8 下盖Bottom Cover 475x73x0.8
	HSD-CG-2	上盖Top Cover 715*171*1.0 下盖Bottom Cover 635x150x1.0
	HSD-CG-3	上盖Top Cover 780x140x1.0 下盖Bottom Cover 690x90x1.0

可定做不锈钢材质,根据客户图纸或实样定制
Note: The end cap material can be tailor-made as stainless-steel.
Non-standard product can be customized as per the supplied sample and/or the drawing

11 密封件 SEAL ELEMENTS



丁腈密封圈
Nitrile sealing ring

EPDM 密封条
EPDM sealing strip

EVA垫片
EVA gasket

材质 Materials	硅胶、三元乙丙、聚氨酯 Silicone、EPDM、Polyurethane, etc
产品名称 Product name	硅胶密封条/圈、三元乙丙发泡密封条/密封圈, 发泡聚氨酯密封圈等 Silicone sealing strip/sealing ring, EPDM foam sealing strip/sealing ring, foam polyurethane(PU) sealing ring, etc
应用场景 Filter element form	可用于各行各业需要密封的场所, 以及实现机械、纺织、化工等耐腐蚀、耐磨损、耐高温的条件 It can be used in places that need to be sealed in all walks of life, and to achieve corrosion resistance, wear resistance and high temperature resistance in machinery, textile, chemical industry, etc

各种截面类型 Various section types

