



PROFESSIONAL  
AQUARIUM MANUFACTURER  
专业水族器材制造商

# 2024

## Promotion Manual

产品推广手册



## 启立文化COMPANY CULTURE

服务宗旨:品质第一、客户至上  
Services tenet: Quality first, customer first

经营理念:诚信、专业、服务、共赢  
Business philosophy: Integrity, professional services, win-win

服务特色:高效、完善、精益求精  
Feature: Efficient, perfect, excellent



## 公司简介COMPANY PROFILE

广州启立环保设备有限公司成立于2015年,专注研发养殖、景观水循环净化等设备,国内首家专业鱼池过滤设备生产厂家;致力于锦鲤养殖事业研究与实践,为您提供一站式鱼池、水处理设备及整体解决方案!工厂位于广州市白云区,公司获得高新技术企业、ISO 质量体系、CE、Rohs 认证等。拥有独立的设计研发部门、多条完整自主的生产线;严格按照科学而现代的生产方式,保证高品质产品的稳定输出,专业售后团队;高效地为客户提供优质产品。

业务覆盖全球,拥有数千个应用场所,提供终身技术支持;承接鱼塘净化设计、景观水系统、水处理解决方案及制造,并提供 OEM 和 ODM 合作!

Guangzhou Qili Environmental Equipment Co.,LTD. was founded in 2015, focus on research and development of aquaculture and landscape water treatment, the first manufacturer of KOI pond filtration equipment from China.Dedicated to the research and practice of koi breeding area, provide one-stop fish ponds, water treatment equipment and overall solutions!

The factory is located in Baiyun District, Guangzhou city. We obtained high-tech enterprises, ISO9001 ,CE, Rohs certificate. With Independent design and development departments, a number of complete independent production lines; Strictly in accordance with scientific and modern production methods to ensure the stable output of high-quality products, professional after-sales team; efficiently provide customers with quality products!

Business covers all the country, with thousands of application sites, provide lifelong technical support; undertake fish pond purification design, landscape water system, water treatment solutions and manufacture, and provide OEM and ODM cooperation!

## ▷ PUMP FREQUENCY CONVERSION PUMP

- P1 DCP-521 变频水泵
  - P2 DCP-522 变频水泵
  - P3 ACP-631变频水泵
  - P4 ACP-632 AC正弦波水泵
  - P5 ACP-532 变频水泵
  - P6 XP-502 高级潜水泵
  - P7 X-501高级静音水泵
  - P8 X-5000无堵塞系列潜水泵
  - P9 X-101 三合一过滤器
  - P10 XP-301 底吸潜水泵
- 

## ▷ POND PUMP

- P11 AFA锦鲤鱼池泵
  - P12 AFC锦鲤鱼池泵
  - P13 KMB大流量泵
- 

## ▷ HEATER

- P14 X-218 智能恒温加热器
  - P15 X-338 圆形加热棒
  - P16 X-388 PTC数码节能恒温加热棒
  - P17 X-518 LED数码控温加热棒
  - P18 X-511 石英防爆加热棒
  - P19 X-512 石英防爆加热棒
  - P20 X-816 防爆玻璃加热棒
  - P21 X-611 PTC节能恒温加热棒
- 

## ▷ UV-C FILTERS

- P22 UV-567 高效过流式杀菌灯
  - P23 UV-566 高效UV杀菌灯
- 

## ▷ LIGHTING

- P24 XT.AT系列 LED 龙鱼专用潜水灯
  - P25 LED-203 LED强光夹灯
  - P26 LED-567 LED夹灯
  - P27 LED-569 LED强光夹灯
  - P28 LED-568 LED 支架灯
- 

## ▷ AUTO FISH FEEDER

- P29 自动喂食器
- 

## ▷ CLEANING

- P30 低水位过滤器
  - P31 AS-587 悬浮鱼缸磁力刷
  - P32 超静音增氧泵
-

# SINE DC PUMP

## DC正弦波水泵

### 直流无刷变频水泵

DC brushless frequency conversion pump

- Separate motor and drive .
- Adjustable flow controller, energy saving.
- IC chip control, lack of water, stuck protection.
- Suitable for freshwater and marine use.
- 实现电机与驱动分离。
- 可调流量、高效节能。
- IC芯片控制,缺水,卡死保护。
- 适用于淡、海水使用。



DCP-521

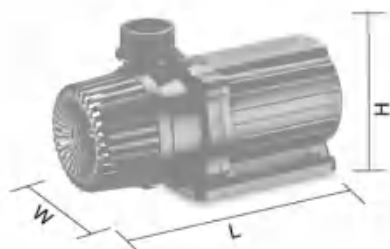

### Feature

产品特点



DC 24V  
智能变频  
Intelligent frequency conversion

型号Model	电压Voltage	功率Power	流量Flow	扬程H.max	进/出水口尺寸 In/Out(∅mm)	产品尺寸Product size L*W*H(mm)
DCP-521	DC24V	12W	1000L/H	1.5M	∅18 20	120*6*93
	DC24V	20W	2000L/H	2.2M	∅18 20	120*6*93
	DC24V	28W	3000L/H	2.8M	∅20 25	162*79*106
	DC24V	43W	5000L/H	3.2M	∅20 26 32	195*89*119
	DC24V	55W	6000L/H	3.6M	∅20 26 32	195*89*119
	DC24V	75W	9000L/H	4.3M	∅20 26 32	210*89*119
	DC24V	85W	12000L/H	4.8M	∅20 25 32 38	210*89*119
	DC48V	130W	15000L/H	6.0M	∅25 32 40 50	262*126*150
	DC48V	150W	20000L/H	6.5M	∅25 32 40 50	262*126*150
	DC48V	200W	25000L/H	7.0M	∅25 32 40 50	262*126*150
	DC48V	280W	30000L/H	8.0M	∅32 40 50 62	360*150*185
	DC48V	360W	40000L/H	9.0M	∅32 40 50 62	360*150*185

# SINE DC PUMP

## DC正弦波水泵

### 直流无刷变频水泵

DC brushless frequency conversion pump

- Separate motor and drive .
- Adjustable flow controller, energy saving.
- IC chip control, lack of water, stuck protection.
- Suitable for freshwater and marine use.
- 实现电机与驱动分离。
- 可调流量、高效节能。
- IC芯片控制,缺水,卡死保护。
- 适用于淡、海水使用。



### Feature

产品特点



DCP-522



型号Model	电压Voltage	功率Power	流量Flow	扬程H.max	进/出水口尺寸 In/Out(∅mm)	产品尺寸Product size L * W * H (mm)
DCP-522	DC24V	12W	1000L/H	1.5M	∅18 20	120*6*93
	DC24V	20W	2000L/H	2.2M	∅18 20	120*6*93
	DC24V	28W	3000L/H	2.8M	∅20 25	162*79*106
	DC24V	43W	5000L/H	3.2M	∅20 26 32	195*89*119
	DC24V	55W	6000L/H	3.6M	∅20 26 32	195*89*119
	DC24V	75W	9000L/H	4.3M	∅20 26 32	210*89*119
	DC24V	85W	12000L/H	4.8M	∅20 25 32 38	210*89*119
	DC48V	130W	15000L/H	6.0M	∅25 32 40 50	262*126*150
	DC48V	150W	20000L/H	6.5M	∅25 32 40 50	262*126*150
	DC48V	200W	25000L/H	7.0M	∅25 32 40 50	262*126*150
	DC48V	280W	30000L/H	8.0M	∅32 40 50 62	360*150*185
	DC48V	360W	40000L/H	9.0M	∅32 40 50 62	360*150*185

# SINE AC PUMP

## AC正弦波水泵

### 交流无刷变频水泵

AC brushless frequency conversion pump

ACP-631

- Separate motor and drive .
- Adjustable flow controller、energy saving.
- IC chip control, lack of water, stuck protection.
- Suitable for freshwater and marine use; 5minutes stop feeding function.
- 实现电机与驱动分离。
- 可调流量、高效节能。
- IC芯片控制,缺水,卡死保护。
- 适用于淡、海水使用; 5分钟暂停喂食功能。

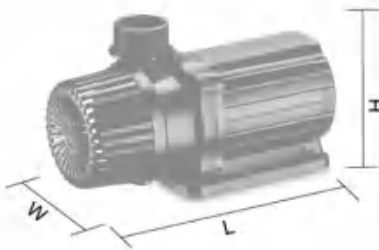

### Feature

产品特点

AC  
智能变频  
Intelligent frequency  
conversion

型号Model	电压Voltage	功率Power	流量Flow	扬程H.max	进/出水口尺寸 In/Out(∅mm)	产品尺寸Product size L * W * H (mm)
ACP-631	110/220V-240V	28W	3000L/H	2.8M	∅20 25	162*79*106
	110/220V-240V	43W	5000L/H	3.2M	∅20 26 32	195*89*119
	110/220V-240V	55W	6000L/H	3.6M	∅20 26 32	195*89*119
	110/220V-240V	75W	9000L/H	4.3M	∅20 26 32	210*89*119
	110/220V-240V	85W	12000L/H	4.8M	∅20 25 32 38	210*89*119
	110/220V-240V	130W	15000L/H	6.0M	∅25 32 40 50	262*126*150
	110/220V-240V	150W	20000L/H	6.5M	∅25 32 40 50	262*126*150
	110/220V-240V	200W	25000L/H	7.0M	∅25 32 40 50	262*126*150
	110/220V-240V	280W	30000L/H	8.0M	∅32 40 50 62	360*150*185
	110/220V-240V	360W	40000L/H	9.0M	∅32 40 50 62	360*150*185

# SINE AC PUMP

## AC正弦波水泵

### 交流无刷变频水泵

AC brushless frequency conversion pump

- Separate motor and drive .
- Adjustable flow controller, energy saving.
- IC chip control, lack of water, stuck protection.
- Suitable for freshwater and marine use; 5minutes stop feeding function.

- 实现电机与驱动分离。
- 可调流量、高效节能。
- IC芯片控制,缺水,卡死保护。
- 适用于淡、海水使用; 5分钟暂停喂食功能。

ACP-632

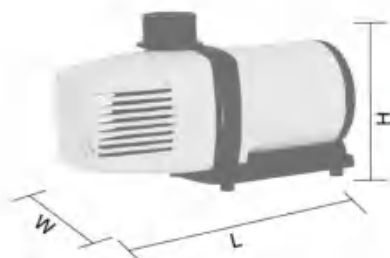

### Feature

产品特点



型号Model	电压Voltage	功率Power	流量Flow	扬程H.max	进/出水口尺寸 In/Out(∅mm)	产品尺寸Product size L * W * H (mm)
ACP-632	110/220V-240V	28W	3000L/H	2.8M	∅20 25	178*79*106
	110/220V-240V	32W	4000L/H	3.0M	∅20 25	178*79*106
	110/220V-240V	43W	5000L/H	3.2M	∅20 26 32	220*89*119
	110/220V-240V	55W	6000L/H	3.6M	∅20 26 32	220*89*119
	110/220V-240V	75W	9000L/H	4.3M	∅20 26 32	220*89*119
	110/220V-240V	85W	12000L/H	4.8M	∅20 25 32 38	220*89*119
	110/220V-240V	130W	15000L/H	6.0M	∅25 32 40 50	262*126*150
	110/220V-240V	150W	20000L/H	6.5M	∅25 32 40 50	262*126*150
	110/220V-240V	200W	25000L/H	7.0M	∅25 32 40 50	262*126*150
	110/220V-240V	280W	30000L/H	8.0M	∅32 40 50 62	360*150*185
	110/220V-240V	360W	40000L/H	9.0M	∅32 40 50 62	360*150*185

# SINE AC PUMP

## AC正弦波水泵

### 交流无刷变频水泵

AC brushless frequency conversion pump

- Separate motor and drive .
- Adjustable flow controller, energy saving.
- IC chip control, lack of water, stuck protection.
- Suitable for freshwater and marine use; 5minutes stop feeding function.

- 实现电机与驱动分离。
- 可调流量、高效节能。
- IC芯片控制,缺水,卡死保护。
- 适用于淡、海水使用; 5分钟暂停喂食功能。

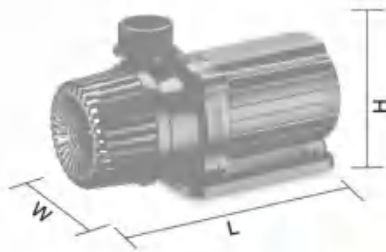

#### Feature 产品特点

AC  
智能变频  
Intelligent frequency  
conversion

ACP-532



型号Model	电压Voltage	功率Power	流量Flow	扬程H.max	进/出水口尺寸 In/Out(Ømm)	产品尺寸Product size L * W * H (mm)
ACP-532	110/220V-240V	28W	3000L/H	2.8M	Ø20 25	162*79*106
	110/220V-240V	43W	5000L/H	3.2M	Ø20 26 32	195*89*119
	110/220V-240V	55W	6000L/H	3.6M	Ø20 26 32	195*89*119
	110/220V-240V	75W	9000L/H	4.3M	Ø20 26 32	210*89*119
	110/220V-240V	85W	12000L/H	4.8M	Ø20 25 32 38	210*89*119
	110/220V-240V	130W	15000L/H	6.0M	Ø25 32 40 50	262*126*150
	110/220V-240V	150W	20000L/H	6.5M	Ø25 32 40 50	262*126*150
	110/220V-240V	200W	25000L/H	7.0M	Ø25 32 40 50	262*126*150
	110/220V-240V	280W	30000L/H	8.0M	Ø32 40 50 62	360*150*185
	110/220V-240V	360W	40000L/H	9.0M	Ø32 40 50 62	360*150*185



# SENIOR SUBMERSIBLE PUMP

## 高级潜水泵

XP-502

安全静音、高效节能、水陆两用

Safe and silent, highly efficient and energy-saving, amphibious

- Energy saving and power saving, long operation life.
  - Safe and ultra-quiet.
  - Suitable for all kinds of aquatic plants and fish farming filtration.
  - Applied to aquariums or fountain display.
  - Amphibious water inlet connection pipes can be used on land.
- 
- 节能省电，使用寿命长。
  - 安全、超静。
  - 适用于各种水草及鱼类养殖过滤。
  - 应用于水族箱及喷泉造景。
  - 水陆两用，进水口连接水管可在陆地使用。



### Feature

产品特点



水陆两用  
Amphibious

型号Model	电压Voltage	功率Power	流量Flow	扬程H.max	产品尺寸Product size L*W*H(mm)
XP-502	110/220V-240V	15W	1500L/H	1.5M	100*50*75
	110/220V-240V	20W	2000L/H	1.8M	125*60*85
	110/220V-240V	35W	2500L/H	2.5M	125*60*85
	110/220V-240V	40W	3000L/H	2.8M	125*60*85
	110/220V-240V	50W	3500L/H	3.0M	130*65*95
	110/220V-240V	75W	4000L/H	3.5M	160*75*115
	110/220V-240V	85W	5000L/H	4.0M	160*75*115

# SENIOR SUBMERSIBLE PUMP

## 高级潜水泵

完全潜水、省电耐用、安全超静

Fully submersible, energy saving, durable, safe ultra-quiet

XP-501

- Submersible, Energy saving and power saving, long operation life.
- safe and ultra - quiet .
- suitable for all kinds of aquatic plants and fish farming filtration.
- Applied to aquariums or fountain display.
- 完全潜水，节能省电，使用寿命长。
- 安全、超静。
- 适用于各种水草及鱼类养殖过滤。
- 应用于水族箱及喷泉造景。

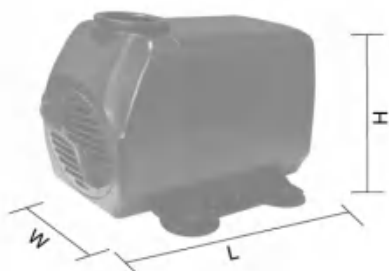

### Feature

产品特点

型号Model	电压Voltage	功率Power	流量Flow	扬程H.max	产品尺寸Product size L* W * H (mm)
XP-501	110/220V-240V	3W	240L/H	0.5M	43*38*30
	110/220V-240V	8.5W	530L/H	0.9M	63*44*51
	110/220V-240V	20W	1200L/H	1.8M	88*59*69
	110/220V-240V	50W	3100L/H	2.8M	110*66*96
	110/220V-240V	85W	3400L/H	3.6M	135*79*120
	110/220V-240V	108W	4000L/H	4.0M	180*100*150

# ADVANCED SUBMERSIBLE PUMP

## 无堵塞潜水泵

### 完全潜水，省电耐用，安全超静

Fully submersible, energy saving, durable, safe ultra-quiet

- Submersible, Energy saving and power saving, long operation life.
- safe and ultra - quiet .
- suitable for all kinds of aquatic plants and fish farming filtration.
- Applied to aquariums or fountain display.
- 完全潜水，节能省电，使用寿命长。
- 安全、超静。
- 适用于各种水草及鱼类养殖过滤。
- 应用于水族箱及喷泉造景。

X-3000

X-4000

X-5000



型号Model	电压Voltage	功率Power	流量Flow	扬程H.max	产品尺寸Product size L * W * H (mm)
X3000	220-240V	45W	2800L/H	2.6M	170 * 75 * 110
X4000	220-240V	65W	3500L/H	3.0M	180 * 80 * 120
X5000	220-240V	90W	4000L/H	3.5M	210 * 90 * 130

# 3IN1 DIVING FILTER

## 三合一潜水过滤器

完全潜水，省电耐用，安全超静

Fully submersible, energy saving, durable, safe ultra-quiet

- Submersible, Energy saving and power saving, long operation life.
- safe and ultra-quiet.
- suitable for all kinds of aquatic plants and fish farming filtration.
- Applied to aquariums or fountain display.
- 完全潜水，节能省电，使用寿命长。
- 安全、超静。
- 适用于各种水草及鱼类养殖过滤。
- 应用于水族箱及喷泉造景。

### XP-101

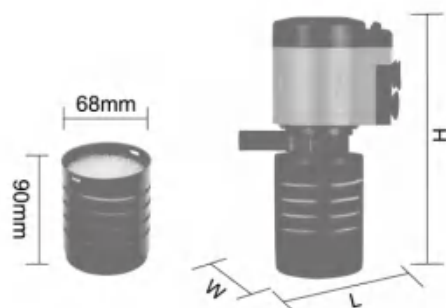

型号Model	电压Voltage	功率Power	流量Flow	扬程H.max	产品尺寸Product size L*W*H(mm)
XP-101	110/220V-240V	15W	1200L/H	1.2M	93*70*180
	110/220V-240V	25W	1500L/H	1.5M	98*72*185
	110/220V-240V	35W	1800L/H	1.9M	110*75*190

# SENIOR

## SUBMERSIBLE PUMP

### 底吸潜水泵

**完全潜水、省电耐用、安全超静**

Fully submersible, energy saving, durable, safe ultra-quiet

- Submersible, Energy saving and power saving, long operation life.
- safe and ultra - quiet .
- suitable for all kinds of aquatic plants and fish farming filtration.
- Applied to aquariums or fountain display.
- 完全潜水，节能省电，使用寿命长。
- 安全、超静。
- 适用于各种水草及鱼类养殖过滤。
- 应用于水族箱及喷泉造景。

XP-301  
(底部过滤)



型号Model	电压Voltage	功率Power	流量Flow	扬程H.max	产品尺寸Product size L* W* H(mm)
XP-301	110/220V~240V	7W	500L/H	0.5M	80*70*90
	110/220V~240V	15W	950L/H	0.9M	100*80*110
	110/220V~240V	25W	1500L/H	1.8M	100*80*110
	110/220V~240V	35W	2400L/H	2.8M	125*100*135
	110/220V~240V	55W	3300L/H	3.6M	175*135*180
	110/220V~240V	95W	4500L/H	4.0M	175*135*180

# KOI FILTER PUMP

## 锦鲤鱼池泵

### Application:

- Garden pools
- Koi pond
- Filter operations
- Water circulations

AFA series

### 适用:

- 花园池塘
- 锦鲤鱼池
- 水过滤
- 水循环



型号Model	电压Voltage	功率Power	流量Flow	扬程H.max	进/出水口尺寸 In/Out(∅mm) D1	产品尺寸Product size D2*H(mm)
AFA	110V/220-240V	100W	18000L/H	2.5M	∅75	∅108*400
	110V/220-240V	150W	22000L/H	3.0M	∅75	∅108*400
	110V/220-240V	200W	26000L/H	4.0M	∅110	∅250*540
	110V/220-240V	300W	36000L/H	4.2M	∅110	∅250*540
	110V/220-240V	400W	40000L/H	4.5M	∅110	∅250*540
	110V/220-240V	500W	45000L/H	5.0M	∅110	∅250*540
	110V/220-240V	600W	57000L/H	5.5M	∅110	∅250*540
	110V/220-240V	1000W	60000L/H	6.0M	∅110	∅250*540

# KOI FILTER PUMP

## 锦鲤鱼池泵

### Application:

- Garden pools
- Koi pond
- Filter operations
- Water circulations

### 适用:

- 花园池塘
- 锦鲤鱼池
- 水过滤
- 水循环

AFC series

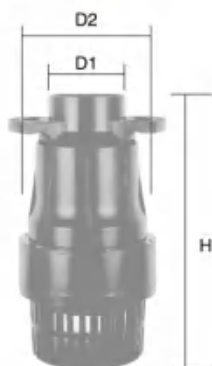

型号Model	电压Voltage	功率Power	流量Flow	扬程H.max	进/出水口尺寸 In/Out(∅mm) D1	产品尺寸Product size D2*H(mm)
AFC	110V/220-240V	50W	16000L/H	2.5M	∅75	∅108*340
	110V/220-240V	100W	20000L/H	3.0M	∅75	∅108*340
	110V/220-240V	200W	28000L/H	4.0M	∅75	∅108*340
	110V/220-240V	300W	40000L/H	4.5M	∅110	∅250*430
	110V/220-240V	500W	48000L/H	5.0M	∅110	∅250*430
	110V/220-240V	600W	58000L/H	5.5M	∅110	∅250*430
	110V/220-240V	800W	100000L/H	6.0M	∅110	∅250*430

# LARGE FLOW PUMP

## 大流量泵

### Application:

- Garden pools
- Koi pond
- Filter operations
- Water circulations

### 适用:

- 花园池塘
- 锦鲤鱼池
- 水过滤
- 水循环

KMB series



型号Model	电压Voltage	功率Power	流量Flow	扬程H.max	进/出水口尺寸 In/Out(∅mm) D1	产品尺寸Product size L*W*H(mm)
KMB	110V/220-240V	40W	16000L/H	2.0M	∅75	300*250*630
	110V/220-240V	50W	18000L/H	2.0M	∅75	300*250*630
	110V/220-240V	75W	20000L/H	2.5M	∅75	300*250*630
	110V/220-240V	100W	25000L/H	2.8M	∅75	300*250*630
	110V/220-240V	150W	30000L/H	2.8M	∅75	300*250*630
	110V/220-240V	180W	32000L/H	3.5M	∅75	300*250*630
	110V/220-240V	220W	35000L/H	3.5M	∅75	300*250*630



# DRAGON FISH FOR INTELLIGENT CONSTANT TEMPERATURE HEATER

## 龙鱼专用 智能恒温加热器

- LED double digital power protection and over-temperature water from 36 °C, automatic off thermal protection.
- The heating temperature can be set during 20-34 °C. With a tolerance of less than ± 1°C.
- With plastic anti-collision jacket, external temperature control.
- 100% pure nickel-chromium heating wire does not rust.
- Remote control, dual probe temperature control safer.
- LED双数字式+离水断电保护超温36°C,自动断热保护。
- 温度可以设定, 调温范围20-34°C, 控制温差±1°C。
- 配塑料防撞护套, 触摸式外置调节温度。
- 采用100%纯镍铬发热丝不生锈。
- 分体式控制, 双探头控温更安全。

# X-218

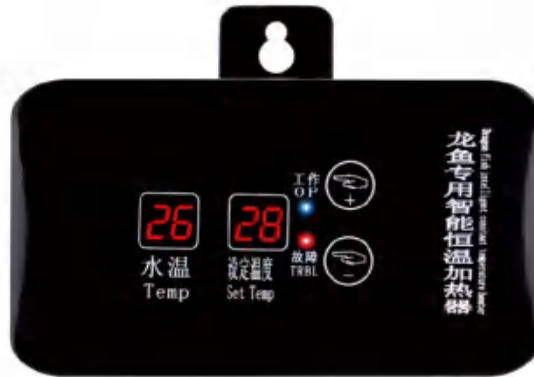
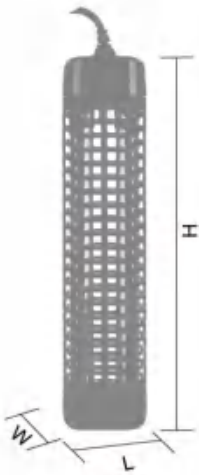

### Feature

产品特点

**离水断电**

Leaving the water power off

**超温保护**

Overtemperature protection

**配防撞护套**

collision avoidance sheet



**原装进口 IC 芯片**  
Imported IC chip

型号Model	电压Voltage	功率Power	产品尺寸Product size L* W * H (mm)
X-218	110V/220-240V	300W	76 * 36 * 340
	110V/220-240V	500W	76 * 36 * 340
	110V/220-240V	600W	76 * 36 * 340
	110V/220-240V	1000W	76 * 36 * 340

# THE CIRCULAR ELEMENT

## 圆形加热棒

- THE ROUND HEATER
- Digital display temperature .
- 20-34°C Circulating setting water temperature
- External adjust temperature , over -temperature protection.
- Ultra-thin fan design, heating better.
- Quartz explosion-proof glass tube.

- 圆形加热棒
- 数码显示温度
- 20-34°C循环设置水温
- 外置调温, 超温保护
- 超薄扇形设计, 加热效果更好
- 采用石英防爆玻璃管

# X-338



原装进口  
IC 芯片  
Imported IC chip

型号Model	电压Voltage	功率Power	产品尺寸Product size D * H (mm)
X-338	110V/220-240V	25W	∅ 79*28
	110V/220-240V	50W	∅ 79*28
	110V/220-240V	75W	∅ 79*28
	110V/220-240V	100W	∅ 79*28
	110V/220-240V	200W	∅ 128*30
	110V/220-240V	300W	∅ 128*30

# PTC

## AQUARIUM HEATER

# PTC数码节能恒温加热棒

PTC Digital energy-saving constant temperature heater

# X-399

- PTC thermistor resistance heating technology.
- Leaving water power -off and over-temperature function.
- Double PTC heating rods, Automatically adjust the heating rods power as water temperature rises
- 50% energy saving, safe and reliable, long service life.
- Soft-touch to adjust temperature. The temperature control range of 20-34°C.

- 采用先进的PTC 热敏半导体电阻加热技术
- 离水断电保护及超温保护功能
- 双PTC 发热片, 随水温上升自动调节发热片功率
- 高效节能50%, 安全可靠, 使用寿命长
- 轻触式循环调节温度, 温度调节范围为20-34°C.

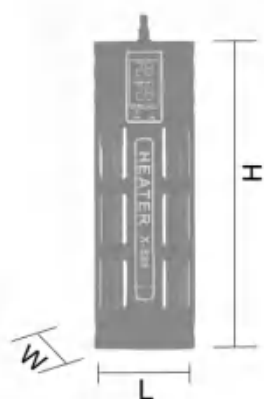

500W



1000W



### Feature

产品特点

石英  
防爆

Quartz  
explosion - proof

外置  
调温

External  
thermostat

超温  
保护

Overtemperature  
protection



原装进口  
IC芯片

Imported IC chip

型号Model	电压Voltage	功率Power	产品尺寸Product size L * W * H(mm)
X-399	110V/220-240V	25W	74 * 26 * 130
	110V/220-240V	50W	74 * 26 * 130
	110V/220-240V	75W	74 * 26 * 130
	110V/220-240V	100W	74 * 26 * 130
	110V/220-240V	200W	82 * 26 * 240
	110V/220-240V	300W	82 * 26 * 240
	110V/220-240V	500W	82 * 26 * 240
	110V/220-240V	800W	82 * 26 * 280
	110V/220-240V	1000W	82 * 26 * 280

# LED

## DIGITAL CONTROL HEATER

# LED数码温控加热棒

# X-518

- Double digital electronic temperature control
- Leaving water power off protection function
- The heater can be adjust temperature range 20-34°C , temperature difference is  $\pm 0.5^{\circ}\text{C}$
- With plastic protective cover , Soft-touch to adjust temperature

- LED 双数字式电子控温
- 离水断电保护功能
- 温度可设定, 调节范围为20-34°C, 温差为 $\pm 0.5^{\circ}\text{C}$ 。
- 配塑料防护罩, 轻触式调节温度

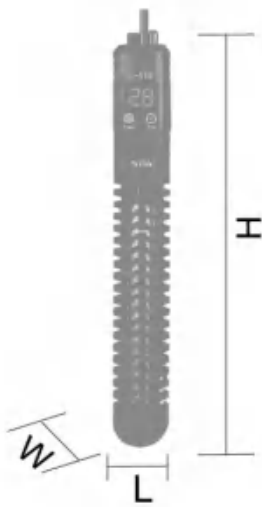

### Feature

产品特点

石英  
防爆

Quartz  
explosion-proof

外置  
调温

External  
thermostat

配防撞  
护套

Collision avoidance  
sheath

超温  
保护

Overtemperature  
protection



原装进口  
IC芯片  
Imported IC chip

型号Model	电压Voltage	功率Power	产品尺寸Product size L* W * H (mm)
X-518	110V/220-240V	50W	28*28*140
	110V/220-240V	100W	28*28*140
	110V/220-240V	200W	35*35*241
	110V/220-240V	300W	35*35*241
	110V/220-240V	500W	35*35*280

# HEATING

## DIGITAL CONTROL HEATER

### 石英防爆加热棒

Quartz explosion-proof heater

X-511

- The heater can be adjust temperature range 20-34°C , temperature difference is +-1°C
- 100% pure nickel heating rods , will not rust.
- 温度可设定，温度调节范围20-34°C。温差±1°C
- 采用100%纯镍洛发热丝，不生锈



#### Feature

产品特点

石英  
防爆

Quartz  
explosion-proof

型号Model	电压Voltage	功率Power	产品尺寸Product size D * H (mm)
X-511	110V/220-240V	25W	Ø23 * 240
	110V/220-240V	50W	Ø23 * 240
	110V/220-240V	100W	Ø23 * 290
	110V/220-240V	200W	Ø23 * 340
	110V/220-240V	300W	Ø23 * 390
	110V/220-240V	500W	Ø23 * 460

# HEATING

## DIGITAL CONTROL HEATER

### 石英防爆加热棒

Quartz explosion-proof heater

- The heater can be adjust temperature range 20-34°C , temperature difference is +-1°C
- 100% pure nickel heating rods , will not rust.
- 温度可设定，温度调节范围20-34°C。温差±1°C
- 采用100%纯镍洛发热丝，不生锈



### Feature

产品特点

石英  
防爆

Quartz  
explosion - proof

## X-512



型号Model	电压Voltage	功率Power	产品尺寸Product size L* W * H (mm)
X-512	110V/220-240V	50W	35*35*120
	110V/220-240V	100W	35*35*120
	110V/220-240V	200W	35*35*240
	110V/220-240V	300W	35*35*240
	110V/220-240V	500W	35*35*275

# HEATING

## DIGITAL CONTROL HEATER

### 防爆玻璃加热棒

Quartz explosion-proof heater

# X-816

- The heater can be adjust temperature range 20-34°C , temperature difference is +-1°C
- 100% pure nickel heating rods , will not rust.
- 温度可设定，温度调节范围20-34°C。温差±1°C
- 采用100%纯镍洛发热丝，不生锈



型号Model	电压Voltage	功率Power	产品尺寸Product size D * H (mm)
X-816	110V/220-240V	25W	Ø22 * 170
	110V/220-240V	50W	Ø22 * 170
	110V/220-240V	100W	Ø22 * 230
	110V/220-240V	200W	Ø22 * 280
	110V/220-240V	300W	Ø22 * 330

# PTC

## AQUARIUM HEATER

# PTC304不锈钢节能加热棒

### PTC 304 Stainless steel energy-saving heater

## X-611

- PTC thermistor resistance heating technology.
- Imported PTC heating rods , Automatically adjust the heating rods power as water temperature rises
- Automatic constant temperature, accurate temperature control
- The heater can be adjust temperature range 16-32°C , temperature difference is +-1°C
- 30% energy saving , safe and reliable , long service life.

- 采用先进的PTC热敏半导体电阻加热技术
- 进口PTC发热体，随水温上升自动调节发热片功率
- 自动恒温，温度控制精确
- 加热可设定，调温范围16-32°C，使用方便
- 节能30%，安全可靠，使用寿命长

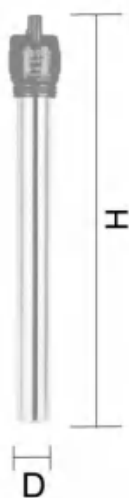

型号Model	电压Voltage	功率Power	产品尺寸Product size D * H (mm)
X-611	110V/220-240V	25W	Ø22 * 170
	110V/220-240V	50W	Ø22 * 170
	110V/220-240V	100W	Ø22 * 180
	110V/220-240V	200W	Ø22 * 260
	110V/220-240V	300W	Ø22 * 290
	110V/220-240V	500W	Ø22 * 320



# UV LAMP

## 高效过流式杀菌灯

瞬间杀灭细菌，灭菌率达99.99%

Instant kill bacteria, sterilization rate of 99.99%

UV-567

- high quality quartz lamp wick long life.
- 360° full range of sterilization and no secondary pollution.
- 采用优质石英灯管灯芯超长寿命。
- 360° 全方位杀菌无二次污染。



型号Model	电压Voltage	功率Power	水池体积 Pond size(M <sup>3</sup> )	进/出水口尺寸 In/Out(∅mm)	产品尺寸 Product size(mm)
UV567	110V/220-240V	5W	3.2	∅ 20 25 32	∅80*210
	110V/220-240V	7W	3.5	∅ 20 25 32	∅80*210
	110V/220-240V	9W	4.2	∅ 20 25 32	∅80*230
	110V/220-240V	11W	4.5	∅ 20 25 32	∅80*290
	110V/220-240V	13W	5.0	∅ 20 25 32	∅80*290
	110V/220-240V	18W	6.0	∅ 20 25 32	∅80*310
	110V/220-240V	24W	10	∅ 20 25 32	∅80*390
	110V/220-240V	36W	15	∅ 20 25 32	∅80*490
	110V/220-240V	55W	20	∅ 20 25 32	∅80*610

# UV LAMP

## 高效UV杀菌灯

瞬间杀灭细菌，灭菌率达99.99%

Instant kill bacteria, sterilization rate of 99.99%

- high quality quartz lamp wick long life.
- 360° full range of sterilization and no secondary pollution.
- 采用优质石英灯管灯芯超长寿命。
- 360° 全方位杀菌无二次污染。

UV-566



UV-20W



UV-30W



UV-40W

型号Model	电压Voltage	功率Power	产品尺寸Product size D * H (mm)
UV-566	220V-240V	6W	∅28*330
	220V-240V	10W	∅28*490
	220V-240V	15W	∅28*590
	220V-240V	20W	∅28*810
	220V-240V	30W	∅28*1050
	220V-240V	40W	∅28*1350

# LIGHTING

## LED 龙鱼专用潜水灯

Arowana dedicated LED dive light

- Double rubber seal, water proofing property is good, can amphibious
- Split power drive, the output voltage is 24V, safe and reliable
- Environmental protection and energy saving
- 双重橡胶密封，防水性好，可水陆两用
- 分体电源驱动，输出电压24V，安全可靠
- 环保，节能，省电



可搭配微电脑温度计

It can be equipped with a microcomputer thermometer



型号Model (单排灯)	电压Voltage	功率Power	产品尺寸Product size D * H (mm)
XT-58	110V-240V	LED 4W	∅22 * 550
XT-78	110V-240V	LED 5W	∅22 * 720
XT-88	110V-240V	LED 6W	∅22 * 820
XT-98	110V-240V	LED 7W	∅22 * 920
XT-118	110V-240V	LED 9W	∅22 * 1120
XT-148	110V-240V	LED 12W	∅22 * 1420

型号Model (双排灯)	电压Voltage	功率Power	产品尺寸Product size D * H (mm)
XT-58	110V-240V	LED 8W	∅22 * 550
XT-78	110V-240V	LED 10W	∅22 * 720
XT-88	110V-240V	LED 12W	∅22 * 820
XT-98	110V-240V	LED 14W	∅22 * 920
XT-118	110V-240V	LED 18W	∅22 * 1120
XT-148	110V-240V	LED 24W	∅22 * 1420

# LIGHTING

## LED 强光夹灯

LED clip light

### 可调亮度

Adjustable brightness

### 触控式开关

Touch switch

- Use of aluminium viewfinder with strong reflex.
- Light&handy, fixed on the tank easily.
- Flexible, suit for all tanks of different sizes.
- Full illumination, especially good for float grass, tropical fish, and marine organism.
- 使用原装进口镜面反光铝板，反光射强。
- 结构轻巧，直接安装于鱼缸之上，使用方便。
- 可伸缩支架可翻盖，适合更多尺寸的鱼缸。
- 强光设计，特别适合水草，热带鱼类及海洋生物的生长。



LED-203L



LED-203

#### Feature

产品特点



Can move 90 degrees

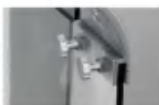

多国认证电源  
CE RoHS

型号Model	输入电压Voltage	输出电压Voltage	功率Power	产品尺寸Product size L* W* H(mm)
LED-203	110V/220-240V	DC-12V	5W	285*75*92
LED-203L	110V/220-240V	DC-12V	8W	335*75*92

# LIGHTING

## LED夹灯

LED clip light

- 超强光设计可以直接安装在鱼缸上。
- 适合水生植物、热带鱼类和海洋生物。
- 可以上下90度调整角度，方便鱼缸清洁。
- 12V输出电压，安全可靠。
- 可任意调整亮度，选择适合水生植物所需的色温。
- ABS塑料外壳不腐蚀，氧化。

LED-567

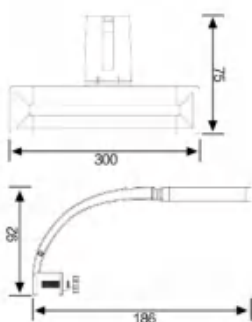

### Feature

产品特点



多国认证电源  
CE GS RoHS



触控开关  
Touch switch



角度展示  
Angle display



角度展示  
Angle display



型号Model	输入电压Voltage	输出电压Voltage	功率Power	产品尺寸Product size L * W * H (mm)
LED-567	110V/220-240V	DC-12V	8W	300 * 186 * 92
	110V/220-240V	DC-12V	12W	350 * 186 * 92
	110V/220-240V	DC-12V	15W	450 * 186 * 92
	110V/220-240V	DC-12V	18W	550 * 186 * 92

# LIGHTING

## LED 强光夹灯

LED clip light

### 触控式开关

Touch switch

LED-569

- Use of aluminium viewfinder with strong reflex.
- Light&handy , fixed on the tank easily.
- Flexible , suit for all tanks of different sizes.
- Full illumination, especially good for float grass , tropical fish , and marine organism.
- 使用原装进口镜面反光铝板, 反光射强。
- 结构轻巧, 直接安装于鱼缸之上, 使用方便。
- 可伸缩支架可翻盖, 适合更多尺寸的鱼缸。
- 强光设计, 特别适合水草, 热带鱼类及海洋生物的生长。



### Feature

产品特点

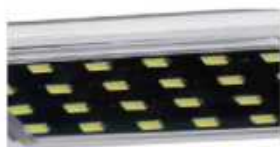

多国认证电源  
CE GS RoHS

型号Model	输入电压Voltage	输出电压Voltage	功率Power	产品尺寸Product size L * W * H (mm)
LED-569	110V/220-240V	DC-12V	5W	285 * 75 * 92
	110V/220-240V	DC-12V	8W	335 * 75 * 92
	110V/220-240V	DC-12V	12W	350 * 75 * 92

# LIGHTING

## LED超薄铝合金水族灯

Slim Aluminum LED Aquarium Light

- Uses the aluminium viewfinder made in, strong reflex
- Novel & convenient
- Flexible, suit all tanks of different size
- Full illumination, especially suit Float grass, tropical fish, water Plants, etc
- 使用原装进口镜面反光铝板，反光射强
- 结构轻巧，直接安装于鱼缸之上，使用方便
- 可伸缩支架可翻盖，适合更多尺寸的鱼缸
- 强光设计，特别适合水草，热带鱼类及海洋生物的生长

LED-568



### Feature

产品特点



优质LED灯  
Quality LED lights



多国认证电源  
CE GS RoHS



型号MODEL	LED-568						
电压VOLTAGE	INPUT:110V/220-240V			50/60Hz	OUTPUT:DV12V		
功率POWER	6W	8W	13W	15W	18W	21W	24W
尺寸SIZE(MM)	300*100*10	400*100*10	500*100*10	600*100*10	900*100*10	1000*100*10	1200*100*10
数量QUANTITY	12	12	12	12	12	8	8

# AUTO FISH FEEDER

## 自动喂食器

- Manual or automatic feeding operation
- Multiple feeding periods
- Replaceable Barrel
- Various Kinds of installation
- 手动或自动喂食
- 多个投喂时段
- 可替换料筒
- 多种安装方式



X-100



X-200

### 产品特点

- 从每日4次到每两日1次自动投喂，多达6个不同自动投喂时段
- 有110ml和240ml两个不同容量的料斗
- 配合不同支架可夹在鱼缸壁或置于鱼缸顶部使用
- 出料口大小可调节，自由控制每次喂食量
- 自定义模式下可以自由设置每天最多6次自动投喂时间

### Feature

- From 4 times a day to 1 time every 2 days, there are 6 different periods of automatic feeding
- With 2 different capacities --110ml and 240ml hopper
- With different supports, it can be clamped on the tank wall or put on the top of the tank
- The size of the feeding mouth can be adjusted, and the feeding amount can be controlled freely every time
- The automatic feeding time can be set up to 6 times per day in the custom mode



# ULTRA SLIM

## 低水位过滤器

Low water filter

流量可调 / 滤棉可换 / 高效除油

Flow adjustable / replaceable filter cotton / efficient oil removal

- Slim design, ultra-quiet.
- wave modeling outlet design, effectively increasing water oxygen capacity.
- supporting special filter cotton, long-term repeated use.
- regulating valve designed to effectively regulate water flow, power-free water.
- with a oil removal device, the effect is superb.
- 超薄设计，超静音。
- 波浪造型出水口设计，有效的增加水的氧容量。
- 配套专用过滤棉，可长期反复使用。
- 调节水阀设计，有效调节水流量，停电免加水。
- 配有除油装置，效果俱佳。



X-450



X-620

内置  
过滤棉

型号Model	流量Gas flow	功率Power
X-450	450L/H	5W
X-620	620L/H	8W

# MAGNETIC GLASS CLEANER

## 悬浮鱼缸磁力刷

AS-587



**磁力  
超强**

Powerful Magnetic

**防滑  
把手**

Non-slip  
griped handle

**高效  
清洁垫**

Efficient  
cleaning pads

### Feature

#### 产品特点

- Super strong magnets for use with varying thicknesses of glass.
- Floats avoiding lost magnets on the bottom of your aquarium.
- Anti-Scratch cleaning pads that are highly efficient in removing algae from glass.
- Non-slip griped handle improving cleaning action.
- 超强磁力，适用于各种厚度的玻璃。
- 漂浮设计，使用方便。
- 采用高效清洁垫，能轻松去除玻璃上的藻类。
- 独特防滑把手设计，让清洁更轻松。

# AIR PUMP

## 超静音增氧气泵

Ultra silent AIR pump

AP-573



AP-572



AP-571



AP-571

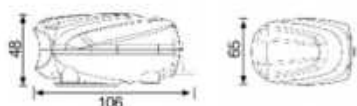

AP-572

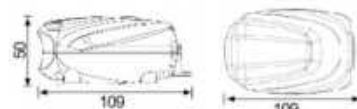

AP-573

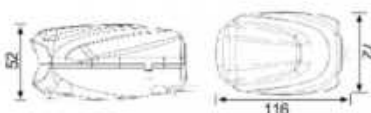

AP-572和AP-573流量可调  
AP-572 and AP-573 flow can be adjusted



AP-571背面  
AP-571 back

### Feature

#### 产品特点

型号Model	电压Voltage	功率Power	气流量Gas flow	气压力Pressure	气孔Porosity	气量调节Air conditioning	产品尺寸Product size L*W*H(mm)
AP-571	220-240V	2.5W	1.8L/min	0.018Mpa	单气孔	不可调节	106*65*48
AP-572	220-240V	2.5W	1.8L/min	0.018Mpa	单气孔	可调节	109*66*50
AP-573	220-240V	7W	2L/minx2	0.018Mpa x2	双气孔	可调节	116*72*52

- 先进的空气压缩系统和减震系统，多级消声设计，噪声极低。
- 特种合成橡胶组件，压力、气量恒定。
- 结构合理紧凑，使用寿命长。
- 均可通过出气管、分配器与一个或多个气泡石连接。

- The advanced air compression system and damping system, multi-stage noise reduction design, low noise.
- The special synthetic rubber components, pressure, gas constant.
- The reasonable and compact structure, long service life.
- Through the outlet pipe, the distributor is connected with one or more bubble stone.



启立抖音号

## 广州启立环保设备有限公司

Guangzhou Qili Environmental Equipment Co.,Ltd

## 广州启航进出口有限公司

Guangzhou Qihang Imp&Exp CO.,LTD

电话: 18520739875/020-37324923

Tel: 86-18520739875

邮箱: qlozone@qlozone.com

Email: qlozone@qlozone.com

网站: www.qlozone.com/www.qihangras.com

Website: www.qlozone.com/www.qihangras.com

地址: 广州市白云区嘉禾街望岗西岭工业园路27号

Website: www.qlozone.com/www.qihangras.com

Add.No.27, Xiling Industrial Park Road, Jiahe Street, Baiyun District, Guangzhou, China