



# ET-HV

## 51.2V200Ah

### User Manual

Light up every corner of the world with renewable energy.

---

## CONTENT

1 General Information .....	2
2 Security Measures .....	3
3 Technical Parameters .....	4
4 Product Overview .....	5
4.1 Product Profile .....	5
4.2 EITAI-HV BCU .....	6
4.2.1 Technical Data .....	6
4.2.2 BCU Port .....	6
4.3 Battery Module .....	7
5 Installation Guide .....	8
5.1 Inspection Before the Installation .....	8
5.1.1 Check the Outer Packaging .....	8
5.1.2 Check Deliverables .....	8
5.2 Tools .....	9
5.3 Installation Requirements .....	9
5.4 Fix the Battery .....	9
5.5 Connect the Power Cable, Communication Cable .....	10
6 Cleaning and Maintenance .....	10
6.1 Cleaning Work .....	10
6.2 Maintenance .....	11
6.2.1 Recharging Requirements During Normal Storage .....	11
6.2.2 Recharging Requirements for Excessive Discharge .....	11
7 Common Issues and Solutions .....	11
7.1 Common Issues and Solutions .....	11
7.2 Emergency .....	13
7.3 About Battery System .....	13

## 1 General Information

This manual introduces EITAI ET-HV51.2V200Ah battery products. Please read this manual carefully before using the battery. If you have any questions, please contact EITAI for advice and assistance.

ET-HV51.2V200Ah is an energy storage unit designed for residential or commercial grid applications with short-term backup capability. Which is not suitable for supporting life-sustaining medical devices. This product is intended for used only in accordance with the information provided in the enclosed documents and applicable local standards and regulations. Any other use may result in personal injury or property damage. The illustrations in this manual are only intended to help explain the concept of the system configuration, including use guidelines, safety precautions, common operating problems, and subsequent battery maintenance.

Alterations to the product, e.g. changes or modifications, are only permitted with the express written permission of EITAI. Unauthorized changes will not be allowed by warranty claims. EITAI shall not be liable for any damage resulting from such changes. Any use of the product other than described in the intended use section does not qualify as appropriate. The enclosed documentation is an integral part of this product. Please keep the documentation in a safe and convenient place for future reference.

The label is attached to the product and contains product identification information. For safe use, the user must fully understand the contents of the label.

The label:

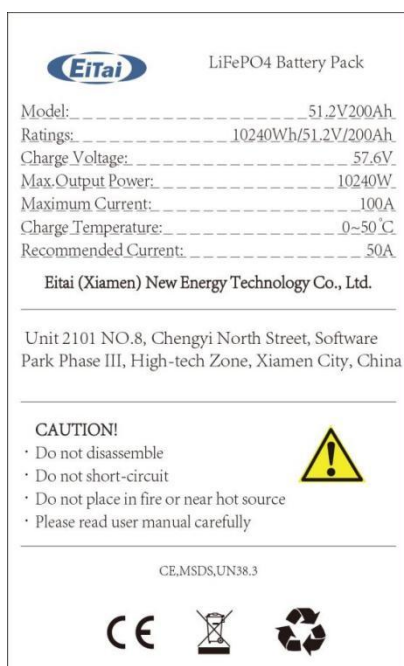

---

## 2 Security Measures

This section contains safety information that must be followed at all times when using or installing batteries. To prevent personal injury or property damage, and to ensure the long-term operation of batteries, read this section carefully and always watch for "warnings" issued by all safety information.

### Environmental requirements

1. Do not expose the battery to more than 50°C;
2. Do not place the battery near any heat source;
3. Do not expose the battery to moisture or liquid;
4. Do not expose the battery to corrosive gases or liquids;
5. Do not expose the battery to flammable gases or liquids;
6. Do not expose the battery to direct sunlight for a long time;
7. Keep the battery in a safe place away from children and animals.

### Operation Precautions:

1. Do not disassemble the battery;
2. Do not touch the battery pack with wet hands;
3. Do not smash, fall, or puncture the battery;
4. Do not short-circuit the terminal, and remove all metal jewelry items that may produce a short-circuit before installation and repair;
5. Always handle the products in accordance with the local safety regulations;
6. Store and use the battery in the user's manual, ensure reliable grounding;
7. Disconnecting all batteries to the wires before installation and repair;
8. The stacking of packaging batteries shall not exceed the quantity specified on the packaging.

### 3 Technical Parameters

ET-HV51.2V200Ah						
Basic Parameters	ET-HV-61	ET-HV-72	ET-HV-82	ET-HV-92	ET-HV-102	ET-HV-113
Number of Battery Module	6	7	8	9	10	11
System Rated Voltage	307.2V	358.4V	409.6V	460.8V	512V	563.2V
System Rated Capacity	61.44KW.h	71.68KW.h	81.92KW.h	92.16KW.h	102.4KW.h	112.64KW.h
System Usable Capacity (90%DOD)	55.30KW.h	64.51KW.h	73.73KW.h	82.94KW.h	92.16KW.h	101.38KW.h
Cabinet Size (W*D*H)	1394*1015**2164.5mm					
Weight	868kg	946kg	1024kg	1102kg	1180kg	1258kg
Cooling Mode	Air conditioning duct refrigeration					
Protection Level	IP65					
Max. Continuous Work Current	100A					
Temperature	-20℃ ~ 60℃					
Storage Temperature	≤25℃, 12 Months					
	≤35℃, 6 Months					
	≤45℃, 3 Months					
Work Environment Air Humidity	<85%RH(No Condensation)					
Operating Altitude	<2000m					
Certificate	UN38.3,MSDS,CE					
Cycle Life	≥6000 times					

Battery Module Parameters	
Rated Voltage	51.2V
Weight	78Kg
Dimensions (W*D*H)	455*579.2*244.5(mm)
Protection Level	IP21

## 4 Product Overview

### 4.1 Product Profile



EITAI-HV high voltage lithium battery energy storage system, consisting of 6-11 battery modules (51.2V200Ah) and a BCU (Battery Control Unit) in series, with an operating voltage range of 185.6V-576V, is used for household / commercial energy storage applications, working with a high voltage inverter for energy storage purposes.

EITAI-HV has a built-in BMS (battery management system, including the main BMS in BCU and the slave BMS in battery module), which can manage and monitor battery information, including voltage, current and temperature. In addition, BMS can balance battery charging to prolong service life. BMS has over discharge, over charge, over-

current, high / low temperature and other protection functions. The system can automatically manage the charge state, discharge state and balance state  
 EITAI-HV have soft-start circuit inside so it can support inverters without soft-start function.

## 4.2 EITAI-HV BCU

The BCU includes the master BMS, DC fuse, soft starting circuit, charging circuit, discharge circuit, 24VDC/DC power supply module.

The BMS in the battery module collects the battery voltage and temperature data uploaded to the master BMS via the internal CAN. BMS's BCU controls the charging voltage / current and discharge voltage / current.

### 4.2.1 Technical Data

Adaptable battery model	ET-HV51.2V200Ah
Rated voltage	185.6V-576V
Max. power	5120W*battery module number
Max. Current	100A
Refer dimension (W*D*H)	455*579.2*244.5(mm)
Refer Weight	15Kg

### 4.2.2 BCU Port

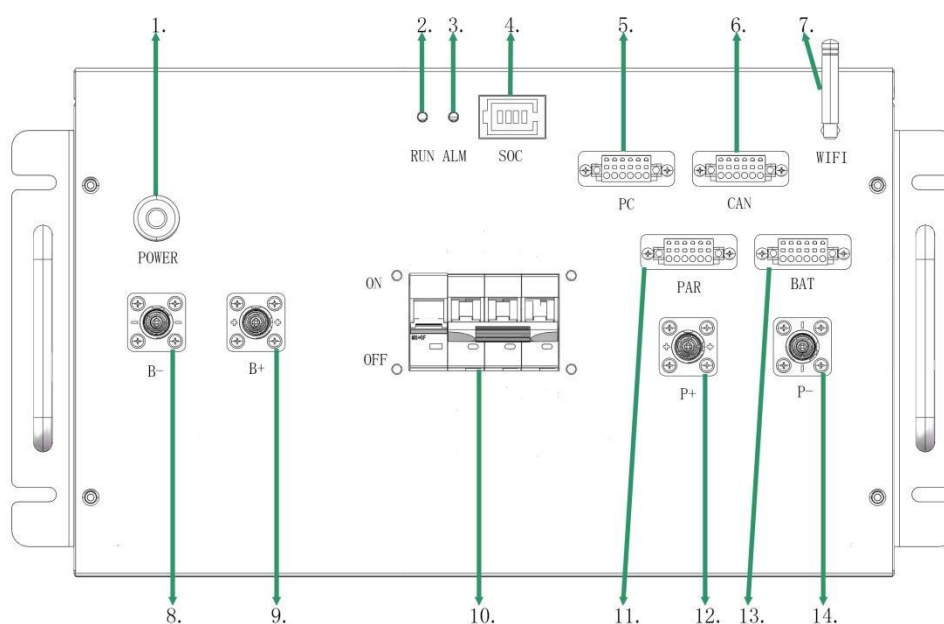

NO.	Name	Description	NO.	Name	Description
1.	POWER	System start switch	2.	RUN	Work normal
3.	ALM	Alarm	4.	SOC	Power light
5.	PC	Communication with computer	6.	CAN	Communication with inverters
7.	Wifi	Wifi wire	8.	B-	Connection position of battery negative pole
9.	B+	Connection position of battery positive pole	10.	ON/OFF	Cut-off switch
11.	PAR	Parallel communication port	12.	P+	Connection position of battery positive pole
13.	BAT	Communication with battery module	14.	P-	Connection position of PCS negative pole

### 4.3 Battery Module

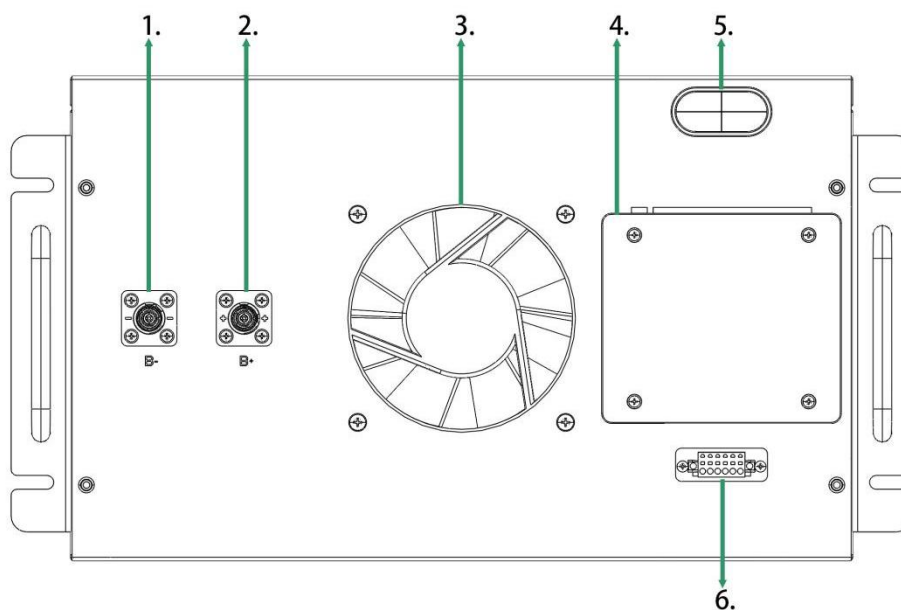

NO.	Name	Description
1.	B-	Battery module negative pole (black)
2.	B+	Battery module positive pole (orange)
3.		Cooling fan
4.		Salve BMS
5.		Cooling fan power
6.	COM	Connection position of battery module communication



The battery module includes battery cell, the slave BMS and the cooling fan. The slave BMS collects and transfers the battery voltage and temperature of the battery cell in real time and the BCU to the main BMS via internal communication.

## 5 Installation Guide

### 5.1 Inspection Before the Installation

#### 5.1.1 Check the Outer Packaging

Packaging materials and components may be damaged during transportation. Check the outer packaging material before installing the battery. Check the packaging material surface for damage, such as holes and cracks. If any damage is found, do not unpacking the battery and contact the dealer as soon as possible. It is recommended that you remove the packaging material within 24 hours before installing the battery.









#### 5.1.2 Check Deliverables

After unpacking the package, check that the deliverables are intact and complete. If any damage or missing parts is found, please contact EITAI.

#### Accessories list in the package

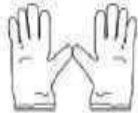
ET-HV51.2V200Ah					
NO.	Name	Model	Unit	Qty	Mark
1	Battery module	ET-HV51.2V200Ah	PCS	1	
2	Communication cable		PCS	1	For battery connection
3	Power cable	Red/black 4AWG	SET	1	For battery connection
NO.1~3 are accessories for battery module; NO.4~9 are accessories for BCU.					
4	Battery control unit	BCU	PCS	1	
5	Power cable	Red/black 4AWG	PCS	2	For battery connection
6	Communication cable		PCS	1	For battery connection
7	Matching resistor		PCS	1	For BCU PAR port connection
8	User manual	User manual	PCS	1	
9	Upper computer cable	USB-CAN	PCS	1	For computer connection
NO.10~11 are accessories for battery installation and storage.					
10	Cabinet	Steel	SET	1	
11	PCS		PCS	1	Optional

## 5.2 Tools

Type	Tools			
Installation	Measuring tape 	Hammer drill 	Socket wrench 	Cross Screwdriver 
Protection	ESD gloves 	Safety goggles 	Dust mask 	Safety shoes 

## 5.3 Installation Requirements

1. Install the battery in an indoor environment.
2. Place the battery in a safe position away from children and animals.
3. Do not place the battery near any heat source, and avoid generating sparks.
4. Do not expose the battery to moist air or liquid.
5. Do not expose the battery to direct sunlight.
6. Do not expose the battery to a combustible gas or liquid.
7. The mounting carrier shall be fire resistant. Do not install batteries on flammable buildings.
8. Ensure ground connection.

## 5.4 Fix the Battery

Insufficient or no grounding may cause an electric shock. Device malfunctions, and insufficient or no grounding may cause device damage and life-threatening electric shocks.

Install the battery module and BCU on the mounting ear sheet metal, and install them into the cabinet one by one.

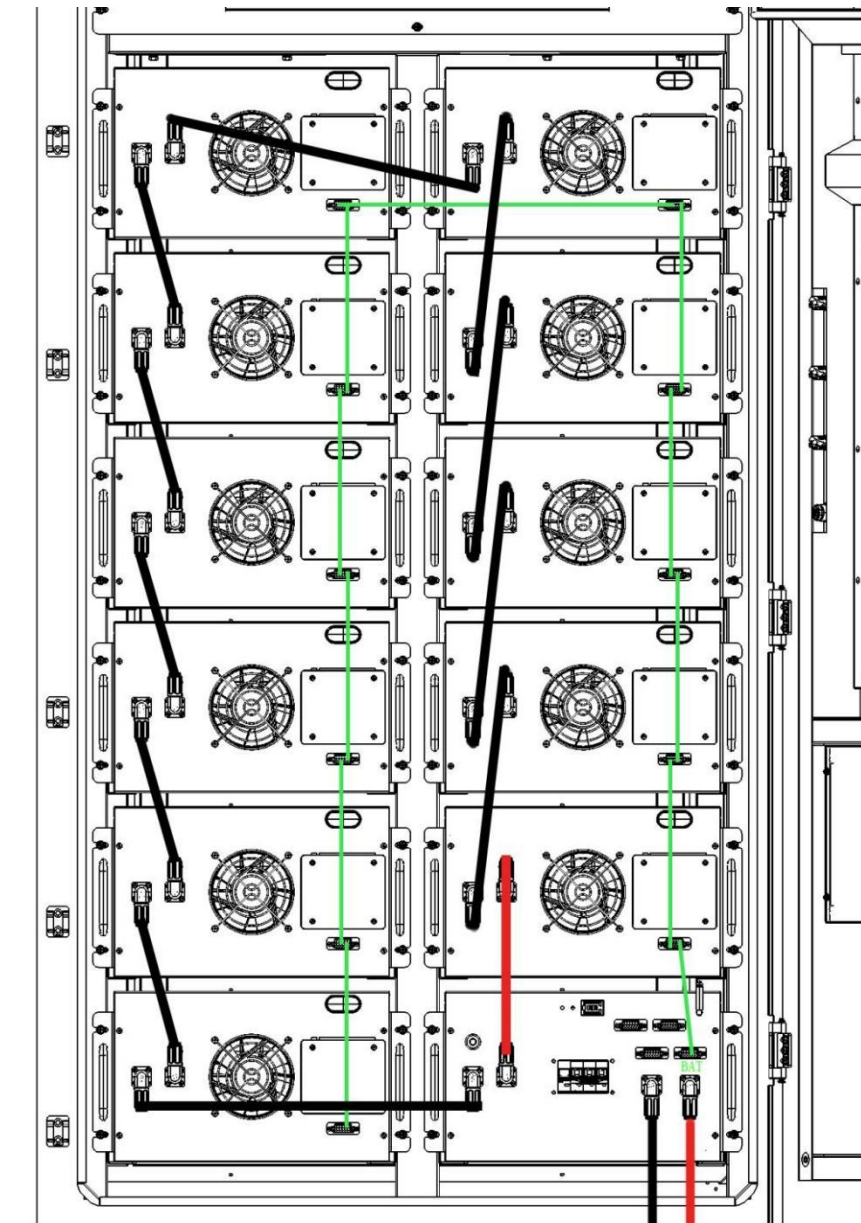

### 5.5 Connect the Power Cable, Communication Cable

Before connecting the battery power cable, verify that the installed battery module and the BCU are sent together. Do not mix the battery module with the BCU. Otherwise, system exceptions may occur. Figure: Red/black is the power cable, green is the communication cable.

## 6 Cleaning and Maintenance

### 6.1 Cleaning Work

Please note: please turn off the power supply of the system before cleaning. It is recommended to clean battery regularly. If the shell is dirty, please use a soft and dry

brush or dust collector to remove the dust. Do not use solvents, or corrosive liquids to clean the enclosure.

## 6.2 Maintenance

### 6.2.1 Recharging Requirements During Normal Storage

The battery shall be stored in an environment with a temperature range of  $-10^{\circ}\text{C}\sim 45^{\circ}\text{C}$  and shall be maintained regularly according to the following table to 0.5C current is charged until 60%SOC after long storage.

Charging conditions during storage

Store the ambient temperature	Relative humidity of the storage environment	Storage time	SOC
Below $-10^{\circ}\text{C}$		Prohibit	/
$-10\sim 25^{\circ}\text{C}$	5%~70%	$\leq 12$ months	$30\%\leq \text{soc}\leq 60$
$25\sim 35^{\circ}\text{C}$	5%~70%	$\leq 6$ months	$30\%\leq \text{soc}\leq 60$
$35\sim 45^{\circ}\text{C}$	5%~70%	$\leq 3$ months	$30\%\leq \text{soc}\leq 60$
Above $45^{\circ}\text{C}$		Prohibit	

### 6.2.2 Recharging Requirements for Excessive Discharge

Charge the over-discharge (90%DOD) battery within the time of meeting the table below, otherwise the over-discharge battery module will be damaged.

Charging requirements for excessive battery discharge

Storage environment temperature	Storage time	Note:
$-10\sim 25^{\circ}\text{C}$	$\leq$ on Day 15	The battery pack disconnected to PCS, charge the battery with DC charger.
$25\sim 45^{\circ}\text{C}$	$\leq$ on Day 7	
$-10\sim 45^{\circ}\text{C}$	<12 hours	Battery pack connect to the Inverter, charge the battery with PV or grid.

## 7 Common Issues and Solutions

### 7.1 Common Issues and Solutions

The user can monitor the operating status, warning, and alarm information through the inverter LCD display.

1. The battery cannot be turned on, and the LED indicator lights all turn off the battery depth discharge and requires charging first. If the external charger supply voltage is 51V or above and the battery still cannot be opened, contact EITAI.

2. If red light shows system abnormal, please check below values:

1) Temperature: Above 60°C or below 0°C, the battery protection turns on, could not charge.

Solution: Move the battery to normal operating temperature range between 0°C to 60 °C.

2) Temperature: above 60°C or below -20°C, the battery cannot discharge.

Solution: Move the battery to normal operating temperature range between -20°C to 60 °C.

3) Current: If ET-HV51.2V200Ah's current is greater than 100A, the battery protection device will be turned on.

Solution: Stop using electrical appliances that exceed the maximum battery power load.

4) High voltage: If the single battery cell's voltage is above 3.6V or higher, battery charging protection turns on.

Solution: The inverter will stop charging the battery if it sets the intelligent LI mode or a reasonable charging voltage.

5) Low voltage: If the single battery cell's voltage is below 2.9V or lower, battery charging protection turns on.

Solution: Charge the battery.

Excluding the above five points, if the fault cannot be found, turn off the battery and contact EITAI.

3. It's normal that the SOC LED are different if in multiple battery parallel systems. Before installing batteries in parallel, measure the voltage of each battery to ensure that the voltage difference of each battery is within 1V, and the the battery production date within 1 year.

1) When installing for the first time, please charge in full first to balance the capacity gap;

2) If the error is within 10% when the lowest SOC display percentage is compared with the highest SOC display percentage, and the SOC display percentage is the same within 10 minutes, it is normal operation;

3) Before expanding battery capacity, please charge and discharge the online battery to 45%-50%SOC; After expanding the capacity, charge the battery system to balance the capacity gap. Ensure that the capacity difference before parallel is no more than 10%. If the capacity gap is large, it will take about 2 cycles to balance the capacity gap. The actual equilibrium time depends on the capacity difference and the charge-discharge current.

Exclude the above three points. If the SOC display still fails, please contact EITAI.

## 7.2 Emergency

Please cut off the power supply and turn off the battery in an emergency.

1. **If the battery pack is damp or immersed in water**, do not get close to the battery, and then contact EITAI or an authorized dealer for technical support.
2. **Do not use water to fire when a fire!** Only dry powder extinguishers; place the battery pack in a safe area if possible.
3. **Battery leaking the electrolyte.** If the battery pack leaks the electrolyte, avoid contact with leaking liquid or gas.

**If someone is exposed to the leaking material, do the following immediately:**

**Inhalation:** evacuate the contaminated areas and seek medical treatment.

**Contact eye:** Rinse eyes with running water for 15 minutes and seek medical treatment.

**Contact skin:** Wash the infected site with soap and water and seek medical treatment.

**Swallow in:** urge vomiting, and seek medical treatment.

4. **Battery damage:** Damaged battery is dangerous and must be treated with very carefully. Battery cannot be used or may be dangerous to person or property. If the battery pack is damaged, contact EITAI for handling.

## 7.3 About Battery System

- 1.The system treatment must comply with the locally applicable disposal regulations of electronic waste and second-hand batteries.
- 2.Do not treat the battery system along with household waste.
- 3.Avoid exposing the battery to high heat or direct sunlight.
- 4.Avoid exposing the battery to high humidity or corrosive environments.
- 5.Do not expose the battery to a combustible gas or liquid.



**Eitai (Xiamen) New Energy Technology Co.,Ltd.**

**Add: Unit 2101 NO.8, Chengyi North Street, Software Park Phase III,  
High-tech Zone, Xiamen City, China**