



YOU BETTER MEDICAL APPARATUS 优贝特医疗器械

www.youbetter.cn

更好的术中体验 · 更佳的术后效果
Better Intraoperative Experience · Better Post-operative Effects



苏州优贝特医疗器械有限公司
SUZHOU YOUTBETTER MEDICAL APPARATUS CO.,LTD.

- 📍 张家港市锦丰镇创业路
Chuangye Road, Jinfeng Town, Zhangjiagang
- ☎ 0086-13913613681
- ☎ 0512-56913268
- ✉ yeahxixi@126.com Candyxu@youbetter.cn
- 🌐 www.youbetter.cn



COMPANY PROFILE 公司简介



苏州优贝特医疗器械有限公司是一家集研发、制造、销售为一体的专业化医疗器械产品制造企业。公司占地面积 60 余亩,建筑面积达 3 万多平方米。

公司建成了具有国际一流水平的研发团队,目前已设立了健全的产品研发体系,拥有国际先进的研发装备和项目管理系统,确保产品的先进、有效和可靠。并且组建了富有经验的专业生产管理和营销团队,同时还搭建了一个网络化、信息共享化,并具有延伸和渗透作用的物流仓储系统。目前,本公司现有的脊柱和创伤内植入物产品共计百余种品种,千余个规格,经销渠道遍布全国各省市。

优贝特的愿景是将中国医生的智慧和经验转化为真正造福于广大病患的优质产品。

Suzhou Youbetter Medical Apparatus Co., Ltd. is a specialized interprise focus on researching, developing, manufacturing, selling medical instrument products. The area is more than 60 acres, including building area of more than 30000 square meters.

The company owns an international standard medical researching and developing team. To make sure the products advanced, effective and reliable, the company has established sound researching and developing system, contained internationally advanced researching and developing device and running system. Besides, the company has organized experienced sales team, and built a networkd, information-sharing logistics warehousing platform which is extended and penetrating. Hundreds kinds of spine and trauma implants with over thousands of sizes are being sold to all over the world.

It is our wish to bring patients health and happiness with outstanding quality products from Chinese doctors' wisdom.

目录 CONTENTS

单侧一体式外固定系统

UNILATERAL NONDETACHABLE EXTERNAL FIXATION SYSTEM

动力腕关节支架 DYNAMIC WRIST FIXATOR	02
微动力调节支架 DYNAMIC AXIAL FIXATOR	04
骨盆支架系列 PELVIC FIXATOR	06
肢体重建系列 LIMB RECONSTRUCTION SYSTEM	07
跨关节支架系列 INTERJOINT FIXATOR	08
指掌骨系列 MINI FIXATOR(PHALANGE & METACARPAL)	09
外固定支架(标准型) EXTERNAL FIXATOR (STANDARD)	10

组合式外固定系统

MODULAR FIXATION SYSTEM

NH II 5外固定支架系统 NH II 5 EXTERNAL FIXATOR SYSTEM	15
NH II 8外固定支架系统 NH II 8 EXTERNAL FIXATOR SYSTEM	20
AO III外固定支架系统 AO III EXTERNAL FIXATOR SYSTEM	26
GY IV外固定支架系统 GY IV EXTERNAL FIXATOR SYSTEM	34
单侧一体式、AO III、GY IV外固定系统工具 INSTRUMENTS OF NONDETACHABLE UNILATERAL、AO III、GY IV EXTERNAL FIXATION SYSTEM	35

环形外固定系统

RING FIXATION SYSTEM

环形外固定系统 RING FIXATION SYSTEM	38
---------------------------------	----

外固定支架针、杆对应表

SHEET FOR THE ROD & SCREWS

标准骨牵引针 STANDARD BONE SCREWS	42
自攻自钻骨牵引针 SELF DRILLING/SELF TAPPING BONE SCREWS	43
髌骨针(带孔别针) TENSION PIN	43
克氏针 K-WIRE	43
弹性髓内针 ELASTIC NAIL	44
橄榄针 K-WIRE WITH OLIVE	44
螺纹导针 THREADED GUIDE WIRE	44
骨钻 DRILL BIT	44
扎丝 SUTURE-WIRE	44

NONDETACHABLE UNILATERAL EXTERNAL FIXATION SYSTEM

单侧一体式外固定系统

产品特点

- >> 单边支架, 轻便、固定可靠(适用于急诊)。
- >> 手术时间短, 操作简单。
- >> 微创手术, 不影响骨折端血供。
- >> 无需二次手术, 门诊可拆除支架。
- >> 支架与骨干长轴一致, 可控制的动力化设计, 可以微动, 促进骨折愈合。
- >> 针夹设计、能使支架自身当模板, 方便插螺钉。
- >> 骨螺钉采用锥形螺纹设计, 越旋越紧, 固定可靠。

Product features

- >> Unilateral fixator, light, stable(applicable for emergency cases).
- >> Easy to operate, saving surgery time.
- >> Minimal-invasive surgery, no effect to the blood supply to fracture.
- >> No second surgery, can be removed at the clinic.
- >> Consistent with the bone shaft, controllable dynamic design, micro movement, promote the union.
- >> Clamp design, make the fixator itself as a template, easy to position the screws.
- >> Bone screw is designed with conical screw thread, turning more and more tightly, fixed and reliable.



图示配置仅供参考, 具体配置以实际为准。
Illustrates configuration for reference only, a specific configuration to the actual subject.

NO.YB2020900

腕关节支架(单针型) Wrist fixator



配置 To configure		数量 Qty
腕关节支架	Wrist fixator	1套 Set
骨牵引针Φ2.5×60mm	Bone screws	2支 Piece
骨牵引针Φ3.5×70mm	Bone screws	2支 Piece
内六角扳手4mm	Allen wrench	1把 Piece
上钉器Φ3.5mm	T-wrench	1把 Piece

NO.YB2020901

腕关节支架 Wrist fixator



配置 To configure		数量 Qty
腕关节支架	Wrist fixator	1套 Set
骨牵引针Φ2.5×60mm	Bone screws	2支 Piece
骨牵引针Φ3.5×70mm	Bone screws	2支 Piece
内六角扳手4mm	Allen wrench	1把 Piece
上钉器Φ3.5mm	T-wrench	1把 Piece

NO.YB2020902

腕关节支架(L型) Wrist fixator (L type)



配置 To configure		数量 Qty
腕关节支架	Wrist fixator	1套 Set
骨牵引针Φ3.5×70mm	Bone screws	4支 Piece
内六角扳手4mm	Allen wrench	1把 Piece
上钉器Φ3.5mm	T-wrench	1把 Piece

NO.YB2020903

前臂架 Forearm fixator



配置 To configure		数量 Qty
前臂架	Forearm fixator	1套 Set
骨牵引针Φ3.5×70mm	Bone screws	4支 Piece
上钉器Φ3.5mm	T-wrench	1把 Piece
内六角扳手5mm	Allen wrench	1把 Piece
两用扳手10mm	Combination wrenches	1把 Piece

图示配置仅供参考，具体配置以实际为准。
Illustrates configuration for reference only, a specific configuration to the actual subject.



NO.YB2020904
腕关节支架(半球型) Wrist fixator

配置 To configure		数量 Qty
腕关节支架	Wrist fixator	1套 Set
骨牵引针Φ2.5×60mm	Bone screws	2支 Piece
骨牵引针Φ3.5×70mm	Bone screws	2支 Piece
内六角扳手4mm	Allen wrench	1把 Piece
上钉器Φ3.5mm	T-wrench	1把 Piece



NO.YB2020905
腕关节支架(单锁型) Wrist fixator

配置 To configure		数量 Qty
腕关节支架	Wrist fixator	1套 Set
骨牵引针Φ2.5×60mm	Bone screws	2支 Piece
骨牵引针Φ3.5×70mm	Bone screws	2支 Piece
内六角扳手4mm	Allen wrench	1把 Piece
上钉器Φ3.5mm	T-wrench	1把 Piece



NO.YB2020906
腕关节支架(透光多关节型) Wrist fixator(Radiolucent multi-joint type)

配置 To configure		数量 Qty
腕关节支架	Wrist fixator	1套 Set
骨牵引针Φ2.5×60mm	Bone screws	2支 Piece
骨牵引针Φ3.5×70mm	Bone screws	2支 Piece
内六角扳手5mm	Allen wrench	1把 Piece
上钉器Φ3.5mm	T-wrench	1把 Piece



NO.YB2020907
腕关节支架(PEEK可透光) Radiolucent wrist fixator

配置 To configure		数量 Qty
腕关节支架	Wrist fixator	1套 Set
骨牵引针Φ2.5×60	Bone screws	2支 Piece
骨牵引针Φ3.5×80	Bone screws	2支 Piece
内六角扳手4mm	Allen wrench	1把 Piece
上钉器Φ3.5mm	T-wrench	1把 Piece

图示配置仅供参考，具体配置以实际为准。
Illustrates configuration for reference only, a specific configuration to the actual subject.



微动力支架(T型) Dynamic axial fixator(T type)

型号 Type	产品编号 No.	配置 To configure	数量 Qty
大号 X	YB2020-001	微动力支架 Dynamic axial fixator	1套 Set
	YB2020-002	骨牵引针Φ6.0×150mm Bone screws	2支 Piece
	YB2020-003	骨牵引针HBΦ6.0×150mm Bone screws	2支 Piece
	YB2020-004	内六角扳手6mm Allen wrench	1把 Piece
	YB2020-005	上钉器Φ6mm T-wrench	1把 Piece
中号 M	YB2020-006	微动力支架 Dynamic axial fixator	1套 Set
	YB2020-007	骨牵引针Φ6.0×130mm Bone screws	2支 Piece
	YB2020-008	骨牵引针HBΦ6.0×150mm Bone screws	2支 Piece
	YB2020-009	内六角扳手6mm Allen wrench	1把 Piece
	YB2020-010	上钉器Φ6mm T-wrench	1把 Piece
小号 S	YB2020-011	微动力支架 Dynamic axial fixator	1套 Set
	YB2020-012	骨牵引针Φ5.0×120mm Bone screws	2支 Piece
	YB2020-013	骨牵引针HBΦ5.0×130mm Bone screws	2支 Piece
	YB2020-014	内六角扳手5mm Allen wrench	1把 Piece
	YB2020-015	上钉器Φ5mm T-wrench	1把 Piece
特小号 XS	YB2020-016	微动力支架 Dynamic axial fixator	1套 Set
	YB2020-017	骨牵引针Φ4.0×100mm Bone screws	4支 Piece
	YB2020-018	内六角扳手4mm Allen wrench	1把 Piece
	YB2020-019	上钉器Φ4mm T-wrench	1把 Piece



微动力支架(直型) Dynamic axial fixator(Straight type)

型号 Type	产品编号 No.	配置 To configure	数量 Qty
大号 X	YB2020-020	微动力支架 Dynamic axial fixator	1套 Set
	YB2020-021	骨牵引针Φ6.0×150mm Bone screws	4支 Piece
	YB2020-022	内六角扳手6mm Allen wrench	1把 Piece
中号 M	YB2020-023	上钉器Φ6mm T-wrench	1把 Piece
	YB2020-024	微动力支架 Dynamic axial fixator	1套 Set
	YB2020-025	骨牵引针Φ6.0×130mm Bone screws	4支 Piece
	YB2020-026	内六角扳手6mm Allen wrench	1把 Piece
	YB2020-027	上钉器Φ6mm T-wrench	1把 Piece
小号 S	YB2020-028	微动力支架 Dynamic axial fixator	1套 Set
	YB2020-029	骨牵引针Φ5.0×120mm Bone screws	4支 Piece
	YB2020-030	内六角扳手5mm Allen wrench	1把 Piece
	YB2020-031	上钉器Φ5mm T-wrench	1把 Piece
特小号 XS	YB2020-032	微动力支架 Dynamic axial fixator	1套 Set
	YB2020-033	骨牵引针Φ4.0×100mm Bone screws	4支 Piece
	YB2020-034	内六角扳手4mm Allen wrench	1把 Piece
	YB2020-035	上钉器Φ4mm T-wrench	1把 Piece

图示配置仅供参考，具体配置以实际为准。
Illustrates configuration for reference only, a specific configuration to the actual subject.



微动力支架(胫骨近端) Dynamic axial fixator

型号 Type	产品编号 No.	配置 To configure	数量 Qty
大号 X	YB2020-036	微动力支架 Dynamic axial fixator	1套 Set
	YB2020-037	骨牵引针Φ6.0×150mm Bone screws	2支 Piece
	YB2020-038	骨牵引针HBΦ6.0×150mm Bone screws	2支 Piece
	YB2020-039	内六角扳手6mm Allen wrench	1把 Piece
	YB2020-040	上钉器Φ6mm T-wrench	1把 Piece



微动力支架(踝关节型) Dynamic axial fixator(Ankle joint type)

型号 Type	产品编号 No.	配置 To configure	数量 Qty
大号 X	YB2020-041	微动力支架 Dynamic axial fixator	1套 Set
	YB2020-042	骨牵引针Φ6.0×130mm Bone screws	4支 Piece
	YB2020-043	内六角扳手6mm Allen wrench	1把 Piece
	YB2020-044	上钉器Φ6mm T-wrench	1把 Piece
中号 M	YB2020-045	微动力支架 Dynamic axial fixator	1套 Set
	YB2020-046	骨牵引针Φ6.0×130mm Bone screws	4支 Piece
	YB2020-047	内六角扳手6mm Allen wrench	1把 Piece
小号 S	YB2020-048	上钉器Φ6mm T-wrench	1把 Piece
	YB2020-049	微动力支架 Dynamic axial fixator	1套 Set
	YB2020-050	骨牵引针Φ5.0×120mm Bone screws	4支 Piece
	YB2020-051	内六角扳手5mm Allen wrench	1把 Piece
	YB2020-052	上钉器Φ5mm T-wrench	1把 Piece

图示配置仅供参考，具体配置以实际为准。
Illustrates configuration for reference only, a specific configuration to the actual subject.



NO.YB2020908

骨盆支架A Pelvis fixator A

配置 To configure	数量 Qty
骨盆支架 The pelvis fixator	1套 Set
骨牵引针HBΦ6.0×150mm Bone screws	4支 Piece
内六角扳手6mm Allen wrench	1把 Piece
上钉器Φ6mm T-wrench	1把 Piece



NO.YB2020909

骨盆支架B Pelvis fixator B

配置 To configure	数量 Qty
骨盆支架 The pelvis fixator	1套 Set
骨牵引针HBΦ6.0×150mm Bone screws	4支 Piece
内六角扳手6mm Allen wrench	1把 Piece
上钉器Φ6mm T-wrench	1把 Piece



NO.YB2020910

骨盆支架C Pelvis fixator C

配置 To configure	数量 Qty
骨盆支架 The pelvis fixator	1套 Set
骨牵引针HBΦ6.0×150mm Bone screws	4支 Piece
内六角扳手6mm Allen wrench	1把 Piece
上钉器Φ6mm T-wrench	1把 Piece
两用扳手10mm Combination wrenches	1把 Piece

图示配置仅供参考，具体配置以实际为准。
Illustrates configuration for reference only, a specific configuration to the actual subject.



NO.YB2020911

骨延长A LRS A

配置 To configure		数量 Qty
骨延长支架	LRS fixator	1套 Set
骨牵引针Φ6.0×150mm	Bone screws	6支 Piece
内六角扳手6mm	Allen wrench	1把 Piece
上钉器Φ6mm	T-wrench	1把 Piece



NO.YB2020912

骨延长B LRS B

配置 To configure		数量 Qty
骨延长支架	LRS fixator	1套 Set
骨牵引针Φ6.0×150mm	Bone screws	4支 Piece
内六角扳手6mm	Allen wrench	1把 Piece
上钉器Φ6mm	T-wrench	1把 Piece



NO.YB2020913

骨延长C LRS C

配置 To configure		数量 Qty
骨延长支架	LRS fixator	1套 Set
骨牵引针Φ6.0×150mm	Bone screws	6支 Piece
骨牵引针HBΦ6.0×150mm	Bone screws	2支 Piece
内六角扳手6mm	Allen wrench	1把 Piece
上钉器Φ6mm	T-wrench	1把 Piece



NO.YB2020914

骨延长D LRS D

配置 To configure		数量 Qty
骨延长支架	LRS fixator	1套 Set
骨牵引针Φ6.0×150mm	Bone screws	4支 Piece
骨牵引针HBΦ6.0×150mm	Bone screws	2支 Piece
内六角扳手6mm	Allen wrench	1把 Piece
上钉器Φ6mm	T-wrench	1把 Piece

图示配置仅供参考，具体配置以实际为准。
Illustrates configuration for reference only, a specific configuration to the actual subject.

NO.YB2020915

肘关节支架 Elbow fixator

配置 To configure		数量 Qty
肘关节支架	Elbow fixator	1套 Set
骨牵引针Φ5.0×110mm	Bone screws	4支 Piece
内六角扳手5mm	Allen wrench	1把 Piece
加压扳手Φ4mm	Allen wrench	1把 Piece
上钉器Φ5mm	T-wrench	1把 Piece



NO.YB2020916

膝关节支架 Knee fixator

配置 To configure		数量 Qty
膝关节支架	Knee fixator	1套 Set
骨牵引针Φ6.0×150mm	Bone screws	2支 Piece
骨牵引针Φ6.0×130mm	Bone screws	2支 Piece
内六角扳手6mm	Allen wrench	1把 Piece
加压扳手Φ4mm	Allen wrench	1把 Piece
上钉器Φ6mm	T-wrench	1把 Piece



NO.YB2020917

股骨平台支架 Petrochanteric fixator

配置 To configure		数量 Qty
股骨平台支架	Petrochanteric fixator	1套 Set
骨牵引针Φ6.0×150mm	Bone screws	2支 Piece
骨牵引针HBΦ6.0×180mm	Bone screws	2支 Piece
内六角扳手5mm	Allen wrench	1把 Piece
上钉器Φ6mm	T-wrench	1把 Piece

图示配置仅供参考，具体配置以实际为准。
Illustrates configuration for reference only, a specific configuration to the actual subject.



NO.YB2020918

指掌骨活动型支架 Mini fixator joint motion type

配置 To configure	数量 Qty
指掌骨支架 Mini fixator	1套 Set
骨牵引针Φ2.0×50mm Bone screws	4支 Piece
内六角扳手3mm Allen wrench	1把 Piece
上钉器Φ2mm T-wrench	1把 Piece



NO.YB2020919

指掌骨直型支架 Mini fixator straight type

配置 To configure	数量 Qty
指掌骨支架 Mini fixator	1套 Set
骨牵引针Φ2.0×50mm Bone screws	4支 Piece
内六角扳手3mm Allen wrench	1把 Piece
上钉器Φ2mm T-wrench	1把 Piece



NO.YB2020920

迷你导轨支架水平型 Minirail horizontal axis type

配置 To configure	数量 Qty
指掌骨支架 Minirail horizontal axis fixator	1套 Set
骨牵引针Φ2.0×50mm Bone screws	4支 Piece
内六角扳手3mm Allen wrench	1把 Piece
上钉器Φ2mm T-wrench	1把 Piece



NO.YB2020921

迷你导轨支架伸长型 Minirail lengtheners

配置 To configure	数量 Qty
指掌骨支架 Minirail lengthener	1套 Set
骨牵引针Φ2.0×50mm Bone screws	4支 Piece
内六角扳手3mm Allen wrench	1把 Piece
上钉器Φ2mm T-wrench	1把 Piece



NO.YB2020922

迷你导轨支架垂直型 Minirail vertical axis type

配置 To configure	数量 Qty
指掌骨支架 Minirail vertical axis fixator	1套 Set
骨牵引针Φ2.0×50mm Bone screws	4支 Piece
内六角扳手3mm Allen wrench	1把 Piece
上钉器Φ2mm T-wrench	1把 Piece



NO.YB2020923

指掌骨支架A型 Mini fixator A type

配置 To configure	数量 Qty
指掌骨支架 Mini fixator A	1套 Set
骨牵引针Φ2.0×50mm Bone screws	4支 Piece
内六角扳手3mm Allen wrench	1把 Piece
上钉器Φ2mm T-wrench	1把 Piece



NO.YB2020924

指掌骨支架B型 Mini fixator B type

配置 To configure	数量 Qty
指掌骨支架 Mini fixator B	1套 Set
骨牵引针Φ2.0×50mm Bone screws	4支 Piece
内六角扳手3mm Allen wrench	1把 Piece
上钉器Φ2mm T-wrench	1把 Piece

NO.YB2020925

指掌骨支架C型 Mini fixator C type

配置 To configure	数量 Qty
指掌骨支架 Mini fixator C	1套 Set
骨牵引针Φ2.0×50mm Bone screws	4支 Piece
内六角扳手3mm Allen wrench	1把 Piece
上钉器Φ2mm T-wrench	1把 Piece

图示配置仅供参考，具体配置以实际为准。
Illustrates configuration for reference only, a specific configuration to the actual subject.

普通直型 Straight type

型号 Type	产品编号 No.	配置 To configure	数量 Qty
大号 L	YB2020-053	直型支架 Straight fixator	1套 Set
	YB2020-054	骨牵引针Φ6.0×130mm Bone screws	4支 Piece
	YB2020-055	内六角扳手6mm Allen wrench	1把 Piece
	YB2020-056	上钉器Φ6mm T-wrench	1把 Piece
中号 M	YB2020-057	直型支架 Straight fixator	1套 Set
	YB2020-058	骨牵引针Φ5.0×120mm Bone screws	4支 Piece
	YB2020-059	内六角扳手6mm Allen wrench	1把 Piece
	YB2020-060	上钉器Φ5mm T-wrench	1把 Piece
小号 S	YB2020-061	直型支架 Straight fixator	1套 Set
	YB2020-062	骨牵引针Φ4.0×110mm Bone screws	4支 Piece
	YB2020-063	内六角扳手5mm Allen wrench	1把 Piece
	YB2020-064	上钉器Φ4mm T-wrench	1把 Piece
特小号 XS	YB2020-065	直型支架 Straight fixator	1套 Set
	YB2020-066	骨牵引针Φ4.0×90mm Bone screws	4支 Piece
	YB2020-067	内六角扳手4mm Allen wrench	1把 Piece
	YB2020-068	上钉器Φ4mm T-wrench	1把 Piece

普通T型 T type

型号 Type	产品编号 No.	配置 To configure	数量 Qty
大号 L	YB2020-069	T型支架 T type fixator	1套 Set
	YB2020-070	骨牵引针Φ6.0×130mm Bone screws	2支 Piece
	YB2020-071	骨牵引针HBΦ6.0×150mm Bone screws	2支 Piece
	YB2020-072	内六角扳手6mm Allen wrench	1把 Piece
中号 M	YB2020-073	上钉器Φ6mm T-wrench	1把 Piece
	YB2020-074	T型支架 T type fixator	1套 Set
	YB2020-075	骨牵引针Φ5.0×120mm Bone screws	2支 Piece
	YB2020-076	骨牵引针HBΦ5.0×130mm Bone screws	2支 Piece
小号 S	YB2020-077	内六角扳手6mm Allen wrench	1把 Piece
	YB2020-078	上钉器Φ5mm T-wrench	1把 Piece
	YB2020-079	T型支架 T type fixator	1套 Set
	YB2020-080	骨牵引针Φ4.0×110mm Bone screws	2支 Piece
特小号 XS	YB2020-081	骨牵引针HBΦ4.0×120mm Bone screws	2支 Piece
	YB2020-082	内六角扳手5mm Allen wrench	1把 Piece
	YB2020-083	上钉器Φ4mm T-wrench	1把 Piece
	YB2020-084	T型支架 T type fixator	1套 Set
特小号 XS	YB2020-085	骨牵引针Φ4.0×90mm Bone screws	4支 Piece
	YB2020-086	内六角扳手4mm Allen wrench	1把 Piece
	YB2020-087	上钉器Φ4mm T-wrench	1把 Piece

踝关节支架 Ankle fixator

型号 Type	产品编号 No.	配置 To configure	数量 Qty
大号 L	YB2020-088	踝关节支架 Ankle fixator	1套 Set
	YB2020-089	骨牵引针Φ6.0×130mm Bone screws	4支 Piece
	YB2020-090	内六角扳手6mm Allen wrench	1把 Piece
	YB2020-091	上钉器Φ6mm T-wrench	1把 Piece
中号 M	YB2020-092	踝关节支架 Ankle fixator	1套 Set
	YB2020-093	骨牵引针Φ5.0×130mm Bone screws	4支 Piece
	YB2020-094	内六角扳手6mm Allen wrench	1把 Piece
	YB2020-095	上钉器Φ5mm T-wrench	1把 Piece
小号 S	YB2020-096	踝关节支架 Ankle fixator	1套 Set
	YB2020-097	骨牵引针Φ4.0×120mm Bone screws	4支 Piece
	YB2020-098	内六角扳手5mm Allen wrench	1把 Piece
	YB2020-099	上钉器Φ4mm T-wrench	1把 Piece

图示配置仅供参考，具体配置以实际为准。
Illustrates configuration for reference only, a specific configuration to the actual subject.

NO.YB2020926

胫骨支架(PEEK 可透光)长型、短型 Tibia fixator (radiolucent) L/S

配置 To configure	数量 Qty
胫骨支架 Tibia fixator	1
骨牵引针Φ6.0×150 Bone screws	4
通用扳手H3-H5 Universal allen wrench	1
上钉器Φ6mm T-wrench	1



NO.YB2020927

踝关节支架(PEEK 可透光)长型、短型 Ankle fixator (radiolucent) L/S

配置 To configure	数量 Qty
踝关节支架 Ankle fixator	1
骨牵引针Φ6.0×150 Bone screws	4
通用扳手H3-H5 Universal allen wrench	1
上钉器Φ6mm T-wrench	1



NO.YB2020928

环形组合式支架 (PEEK 可透光) Hybird kit fixator (radiolucent)

配置 To configure	数量 Qty
环形组合式支架 Hybird kit fixator	1
骨牵引针Φ6.0×150 Bone screws	2
克氏针Φ2×300 K-wire	2
通用扳手H3-H5 Universal allen wrench	1
两用扳手10mm Combination spanner	2
六角扳手H6 Allen wrench	1
上钉器Φ6mm T-wrench	1



NO.YB2020929

踝关节固定 Ankle fixator

配置 To configure	数量 Qty
踝关节固定 Ankle fixator	1
骨牵引针6.0×150 Bone screws	2
克氏针2.5×250 K-wire	2
克氏针2.0×250 K-wire	1
两用扳手 Combination spanner	2
内六角扳手3mm Allen wrench	1
内六角扳手5mm Allen wrench	1
内六角扳手6mm Allen wrench	1



图示配置仅供参考，具体配置以实际为准。
Illustrates configuration for reference only, a specific configuration to the actual subject.

万向型支架 Universal type fixator

型号 Type	产品编号 No.	配置 To configure	数量 Qty
大号 X	YB2020-100	万向型支架 Universal type fixator	1套 Set
	YB2020-101	骨牵引针Φ6.0×130mm Bone screws	4支 Piece
	YB2020-102	开口扳手13-16mm Open spanner	1把 Piece
	YB2020-103	内六角扳手4mm Allen wrench	1把 Piece
	YB2020-104	内六角扳手5mm Allen wrench	1把 Piece
中号 M	YB2020-105	上钉器Φ6mm T-wrench	1把 Piece
	YB2020-106	万向型支架 Universal type fixator	1套 Set
	YB2020-107	骨牵引针Φ5.0×120mm Bone screws	4支 Piece
	YB2020-108	开口扳手10-14mm Open spanner	1把 Piece
	YB2020-109	内六角扳手4mm Allen wrench	1把 Piece
	YB2020-110	内六角扳手5mm Allen wrench	1把 Piece
	YB2020-111	上钉器Φ5mm T-wrench	1把 Piece
小号 S	YB2020-112	万向型支架 Universal type fixator	1套 Set
	YB2020-113	骨牵引针Φ5.0×110mm Bone screws	4支 Piece
	YB2020-114	开口扳手10-14mm Open spanner	1把 Piece
	YB2020-115	内六角扳手4mm Allen wrench	1把 Piece
	YB2020-116	内六角扳手5mm Allen wrench	1把 Piece
	YB2020-117	上钉器Φ5mm T-wrench	1把 Piece



产品编号YB9202**** 配不加压延长杆，其他配置同上
No.YB9202**** Can configure non-compression/distractiontube and have same other configurations

直型支架 Straight type fixator

型号 Type	产品编号 No.	配置 To configure	数量 Qty
大号 X	YB2020-118	万向型支架 Universal type fixator	1套 Set
	YB2020-119	骨牵引针Φ6.0×130mm Bone screws	4支 Piece
	YB2020-120	开口扳手13-16mm Open spanner	1把 Piece
	YB2020-121	内六角扳手4mm Allen wrench	1把 Piece
	YB2020-122	两用扳手10mm Combination spanner	1把 Piece
中号 M	YB2020-123	上钉器Φ6mm T-wrench	1把 Piece
	YB2020-124	万向型支架 Universal type fixator	1套 Set
	YB2020-125	骨牵引针Φ5.0×120mm Bone screws	4支 Piece
	YB2020-126	开口扳手10-14mm Open spanner	1把 Piece
	YB2020-127	内六角扳手4mm Allen wrench	1把 Piece
	YB2020-128	上钉器Φ5mm T-wrench	1把 Piece
	YB2020-129	万向型支架 Universal type fixator	1套 Set
小号 S	YB2020-130	骨牵引针Φ5.0×110mm Bone screws	4支 Piece
	YB2020-131	开口扳手10-14mm Open spanner	1把 Piece
	YB2020-132	内六角扳手4mm Allen wrench	1把 Piece
	YB2020-133	上钉器Φ5mm T-wrench	1把 Piece



产品编号YB9204**** 配不加压延长杆，其他配置同上
No.YB9204**** Can configure non-compression/distractiontube and have same other configurations

图示配置仅供参考，具体配置以实际为准。
Illustrates configuration for reference only, a specific configuration to the actual subject.

NO.YB2020930

横向骨搬移支架 Lateral limb reconstruction fixator

产品特点 Product Features

- >> 简便、易操作
- >> 创面小、减少痛苦
- >> 通过移动骨块，改善血运，阻止肢体坏死
- >> 费用低，病情不易复发
- >> Simple and easy to operate
- >> Small wounds and reduced pain
- >> Improve blood flow and prevent limb necrosis by moving bones
- >> Low cost, the disease is not easy to relapse

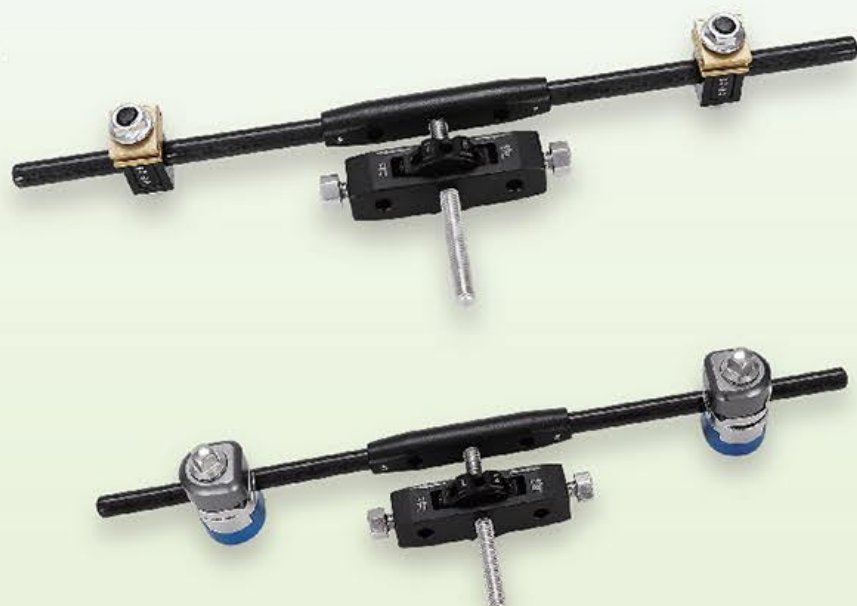

规格 Size
Φ3.0、Φ4.0、Φ5.0

NO.YB2020931

皮肤牵拉器 Skin retractor

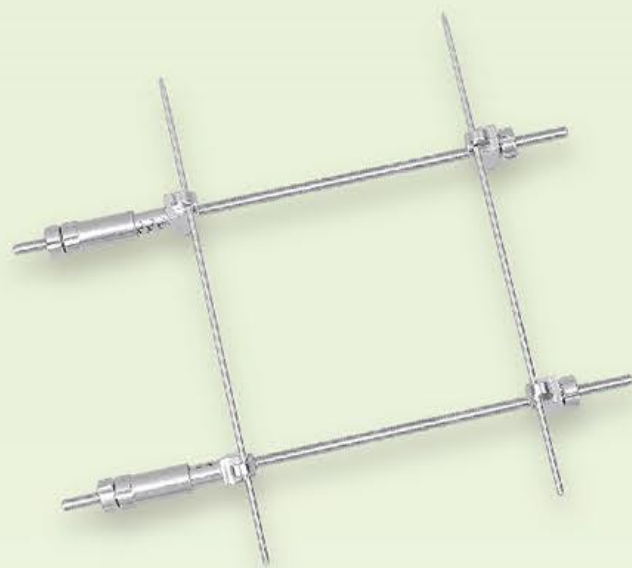

规格 Size
Φ1.5×250mm
Φ2.0×250mm

MODULAR FIXATION SYSTEM 组合式外固定系统

产品特点

- >> 具有技术先进、使用方便的特点。
- >> 在近端和远端骨折处可以进行独立的钢钉布局。
- >> 设计中应用弹簧载荷预咬合机制 (snap-fit)，提高了操作处理和缩短了术中操作时间。
- >> 增加了骨折视野的清晰度，这主要是通过使用高性能材料医用铝和碳纤维完成的。
- >> 设计提供了最佳的稳定性和弹性。
- >> 设计为紧凑的、体积小的框架。
- >> 针对骨折方式的复杂性和软组织缺失进行设计，同时兼顾多样性和使用方便。
- >> 使用简单、有效的器械。

Product features

- >> With the characteristic of advanced technology and convenient usage.
- >> Independent arrangement of bone screws in proximal and distal fractures.
- >> Apply snap-fit to the design which leads to easier operation and less time.
- >> Enhance the sharpness of the fracture vision by using Medical aluminum & carbon fiber.
- >> Offer the best stability and elasticity.
- >> Make the frame compactly.
- >> Design aiming at the complexity of the fracture and loss of soft tissue and considering both variety and convenience.
- >> Simple and effective usage.



NH II 5外固定支架单件、工具

Parts & instruments of NH II 5 external fixator



针杆固定夹
Pin to rod coupling

编号No	YB2020-134
规格Size	Φ5/3-4
材料:	不锈钢、合金铝
Material:	Stainless steel, Aluminum



杆杆固定夹
Rod to rod coupling

编号No	YB2020-135
规格Size	Φ5/5
材料:	不锈钢、合金铝
Material:	Stainless steel, Aluminum



近关节固定夹
Peri-articular pin clamp

编号No	YB2020-136
规格Size	Φ5/3-4
材料:	不锈钢、合金铝
Material:	Stainless steel, Aluminum



4孔钢针固定夹
4-hole pin clamp

编号No	YB2020-137
规格Size	Φ5/3-4
材料:	不锈钢、合金铝
Material:	Stainless steel, Aluminum



针杆固定夹
Pin to rod coupling

编号No	YB2020-138
规格Size	Φ5×3-4
材料:	PEEK
Material:	PEEK



杆杆固定夹
Rod to rod coupling

编号No	YB2020-139
规格Size	Φ5×5
材料:	PEEK
Material:	PEEK



MINI双针杆夹
Pin to rod coupling (small)

编号No	YB2020-140
规格Size	Φ3/2
材料:	不锈钢、合金铝
Material:	Stainless steel, Aluminum



MINI杆杆夹
Rod to rod coupling (small)

编号No	YB2020-141
规格Size	Φ3/3
材料:	不锈钢、合金铝
Material:	Stainless steel, Aluminum



30° 支柱
30° post

编号No	YB2020-142
规格Size	Φ5
材料:	不锈钢
Material:	Stainless steel



直支柱
Straight post

编号No	YB2020-143
规格Size	Φ5
材料:	不锈钢
Material:	Stainless steel



肘关节活动器
Elbow joint mobilizer

编号No	YB2020-144
规格Size	Φ5
材料:	不锈钢
Material:	Stainless steel



腕关节活动器
Wrist joint mobilizer

编号No	YB2020-145
规格Size	Φ5
材料:	不锈钢
Material:	Stainless steel

NH II 5外固定支架单件、工具

Parts & instruments of NH II 5 external fixator



连接杆
Connecting rod

编号No	YB2020-146
规格Size	Φ5 长度100-400
材料:	合金铝、碳纤维
Material:	Aluminum, Carbon fibre



加压延长单杆
Compression/Distractor single rod

编号No	YB2020-147
规格Size	Φ5
材料:	不锈钢、合金铝
Material:	Stainless steel, Aluminum



T型扳手
T wrench

编号No	YB2020-148
规格Size	#5
材料:	不锈钢
Material:	Stainless steel



稳定复位扳手
Stabilization/Reduction wrench

编号No	YB2020-149
规格Size	#15
材料:	不锈钢、合金铝
Material:	Stainless steel, Aluminum



弓形钻架
Hand drill

编号No	YB2020-150
规格Size	Φ4
材料:	不锈钢、合金铝
Material:	Stainless steel, Aluminum



上钉器
Screw driver

编号No	YB2020-151
规格Size	Φ3/4
材料:	不锈钢
Material:	Stainless steel



定位器
Guides

编号No	YB2020-152
规格Size	Φ3/4
材料:	不锈钢
Material:	Stainless steel



拇指轮
Thumb wheel

编号No	YB2020-153
规格Size	#5/7
材料:	合金铝
Material:	Aluminum



开口扳手
Open spanner

编号No	YB2020-154
规格Size	#4/5、#5/7
材料:	不锈钢
Material:	Stainless steel

NH II 5外固定支架器械包

NH II 5 external fixator instrument boxes

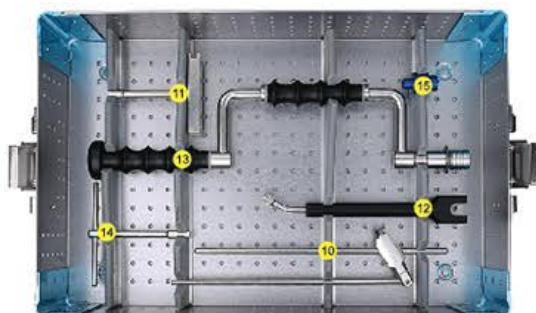

序号 No.	产品名称 Product Name	产品编号 Product No.	规格 Specification	数量 Qty
1	针杆固定夹 Pin to rod coupling	YB2020-155	Φ5/3-4	12
2	杆杆固定夹 Rod to rod coupling	YB2020-156	Φ5/5	12
3	4孔钢针固定夹 4-hole pin clamp	YB2020-157	Φ5/3-4	3
4	近关节固定夹 Peri-articular pin clamp	YB2020-158	Φ5/3-4	1
5	直支柱 Straight post	YB2020-159	Φ5	2
6	30° 支柱 30° post	YB2020-160	Φ5	4
7	自攻自钻骨牵引针 Self drilling/Self tapping bone screws	YB2020-161	Φ4×130	4
		YB2020-162	Φ4×120	4
		YB2020-163	Φ4×100	4
		YB2020-164	Φ4×80	4
		YB2020-165	Φ3×80	4
8	定位器 Guides	YB2020-166	Φ3-4	1
9	连接杆 Carbon fibre rod	YB2020-167	Φ5×250	2
		YB2020-168	Φ5×200	4
		YB2020-169	Φ5×180	2
		YB2020-170	Φ5×150	4
YB2020-171	Φ5×120	2		
10	肘关节活动器 Elbow joint mobilizer	YB2020-172	Φ5	1
11	T型扳手 T wrench	YB2020-173	#5	1
12	稳定复位扳手 Stabilization/Reduction wrench	YB2020-174	#15	1
13	弓形钻架 Hand drill	YB2020-175	Φ4	1
14	上钉器 Screw driver	YB2020-176	Φ3-4	1
15	拇指轮 Thumb wheel	YB2020-177	#5/7	1
16	器械盒 Instrument set	YB2020-178		1

 图示配置仅供参考，具体配置以实际为准。
 Illustrates configuration for reference only, a specific configuration to the actual subject.

NO.YB2020932

尺桡骨跨关节型 Ulna&Radius spanning external fixator

配置 To configure	数量 Qty
杆杆固定夹Φ5/5 Rod to rod coupling	4
4孔钢针固定夹Φ5/3-4 4-hole pin clamp	2
30° 支柱Φ5 30° post	4
连接杆Φ5×200mm Carbon fibre rod	2
自攻自钻骨牵引针Φ3×80mm Self drilling/Self tapping bone screws	4

适应症：胫骨、桡骨 Used for: Tibia, Radius

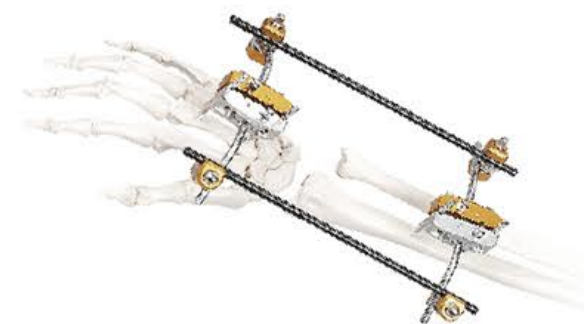

NO.YB2020933

尺桡骨型 Ulna&Radius fixator

配置 To configure	数量 Qty
杆杆固定夹Φ5/5 Rod to rod coupling	2
4孔钢针固定夹Φ5/3-4 4-hole pin clamp	2
直支柱Φ5 Straight post	2
连接杆Φ5×200mm Carbon fibre rod	1
自攻自钻骨牵引针Φ3×80mm Self drilling/Self tapping bone screws	4

适应症：前臂 Used for: Forearm

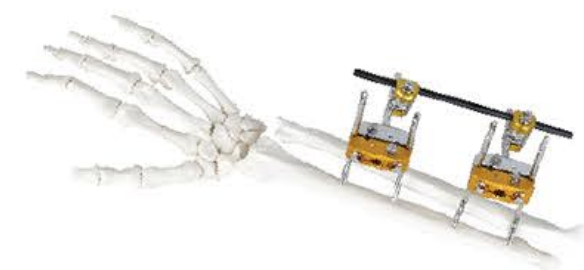

NO.YB2020934

尺桡骨型 Ulna&Radius fixator

配置 To configure	数量 Qty
杆杆固定夹Φ5/5 Rod to rod coupling	1
针杆固定夹Φ5/3-4 Pin to rod coupling	2
近关节固定夹Φ5/3-4 Peri-articular pin clamp	1
连接杆Φ5×200mm Carbon fibre rod	1
自攻自钻骨牵引针Φ3×100mm Self drilling/Self tapping bone screws	4

适应症：尺骨、桡骨 Used for: Ulna, Radius



NO.YB2020935

腕关节型 Wrist joint fixator

配置 To configure	数量 Qty
腕关节活动器Φ5 Wrist joint mobilizer	1
针杆固定夹Φ5/3-4 Pin to rod coupling	4
自攻自钻骨牵引针Φ3×100mm Self drilling/Self tapping bone screws	4

适应症：腕关节 Used for: Wrist joint



NO.YB2020936

指掌骨型 Mini-fixator(Finger&Palm)

配置 To configure	数量 Qty
MINI双针杆夹Φ3/2 Pin to rod coupling	2
连接杆 Φ3×80 Carbon fibre rod	1
骨牵引针Φ2×60 Bone screws	1

适应症：指掌骨折 Used for: Finger, Palm



图示配置仅供参考，具体配置以实际为准。
Illustrates configuration for reference only, a specific configuration to the actual subject.

NO.YB2020937

肘关节型 Elbow joint fixator

配置 To configure	数量 Qty
肘关节活动器Φ5 Elbow joint mobilizer	1
针杆固定夹Φ5/3-4 Pin to rod coupling	4
自攻自钻骨牵引针Φ4×120mm Self drilling/Self tapping bone screws	4
适应症: 肘关节骨折 Used for: Elbow joint fracture	



NO.YB2020938

肱骨骨干骨折 Humeral shaft external fixator

配置 To configure	数量 Qty
杆杆固定夹Φ5/5 Rod to rod coupling	2
4孔钢针固定夹Φ5/3-4 4-hole pin clamp	2
30° 支柱Φ5 30° post	2
连接杆Φ5×200mm Carbon fibre rod	1
自攻自钻骨牵引针Φ4×120mm Self drilling/Self tapping bone screws	4
适应症: 肱骨骨干 Used for: Humeral shaft	

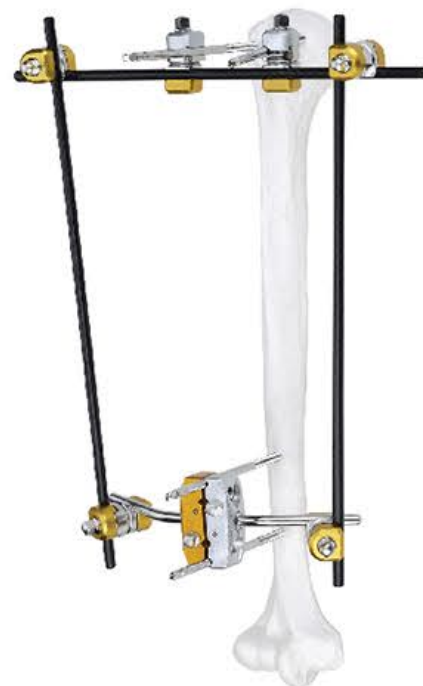

NO.YB2020939

肱骨近端骨折 Proximal humerus fixator

配置 To configure	数量 Qty
杆杆固定夹Φ5/5 Rod to rod coupling	4
针杆固定夹Φ5/3-4 Pin to rod coupling	2
4孔钢针固定夹Φ5/3-4 4-hole pin clamp	1
连接杆Φ5×250mm Carbon fibre rod	2
连接杆Φ5×200mm Carbon fibre rod	1
30° 支柱Φ5 30° post	2
自攻自钻骨牵引针Φ4×120mm Self drilling/Self tapping bone screws	4
适应症: 肱骨近端和外踝颈 Used for: Proximal humerus, Condyle neck	

NH II 8外固定支架单件、工具

Parts & instruments of NH II 8 external fixator



针杆固定夹
Pin to rod coupling

编号No	YB2020-179
规格Size	Φ8/4-5
材料: 不锈钢、合金铝	
Material: Stainless steel、Aluminum	



杆杆固定夹
Rod to rod coupling

编号No	YB2020-180
规格Size	Φ8/8
材料: 不锈钢、合金铝	
Material: Stainless steel、Aluminum	



5孔钢针固定夹
5-hole pin clamp

编号No	YB2020-181
规格Size	Φ8/5
材料: 不锈钢、合金铝	
Material: Stainless steel、Aluminum	



棒杆夹
Tube to rod coupling

编号No	YB2020-182
规格Size	Φ20/8
材料: 不锈钢、合金铝	
Material: Stainless steel、Aluminum	



针杆固定夹
Pin to rod coupling

编号No	YB2020-183
规格Size	Φ8/5-6
材料: PEEK	
Material: PEEK	



杆杆固定夹
Rod to rod coupling

编号No	YB2020-184
规格Size	Φ8/8
材料: PEEK	
Material: PEEK	



30° 支柱
30° post

编号No	YB2020-185
规格Size	Φ8
材料: 不锈钢	
Material: Stainless steel	



直支柱
Straight post

编号No	YB2020-186
规格Size	Φ8
材料: 不锈钢	
Material: Stainless steel	



踝关节活动器
Ankle joint mobilizer

编号No	YB2020-187
规格Size	Φ8
材料: 不锈钢	
Material: Stainless steel	



膝关节活动器
Knee joint mobilizer

编号No	YB2020-188
规格Size	Φ8
材料: 不锈钢	
Material: Stainless steel	

NH II 8外固定支架单件、工具

Parts & instruments of NH II 8 external fixator



半环形弓

Semi-circular curved connecting rod

编号No	YB2020-189
规格Size	Φ8×160、Φ8×180、Φ8×200mm
材料:	合金铝
Materal:	Aluminum



连接杆

Connecting rod

编号No	YB2020-190
规格Size	Φ8 长度100-400mm
材料:	碳纤维、合金铝
Materal:	Carbon fibre、Aluminum



直型延长杆

Compression/Distraction rod

编号No	YB2020-191
规格Size	Φ20
材料:	不锈钢、合金铝
Materal:	Stainless steel、Aluminum



T型扳手

T wrench

编号No	YB2020-194
规格Size	#7
材料:	不锈钢
Materal:	Stainless steel



弓形钻架

Hand drill

编号No	YB2020-197
规格Size	Φ5
材料:	不锈钢、合金铝
Materal:	Stainless steel、Aluminum



拇指轮

Thumb wheel

编号No	YB2020-200
规格Size	#5/7
材料:	合金铝
Materal:	Aluminum



加压延长单杆

Compression/Distraction single rod

编号No	YB2020-192
规格Size	Φ8
材料:	不锈钢、合金铝
Materal:	Stainless steel、Aluminum



加压延长双杆

Compression/Distraction double rods

编号No	YB2020-193
规格Size	Φ8
材料:	不锈钢、合金铝
Materal:	Stainless steel、Aluminum



稳定复位扳手

Stabilization/Reduction wrench

编号No	YB2020-195
规格Size	#22
材料:	不锈钢、合金铝
Materal:	Stainless steel、Aluminum



扭力扳手

Torque wrench

编号No	YB2020-196
规格Size	#7
材料:	不锈钢、合金铝
Materal:	Stainless steel、Aluminum



上钉器

Screw driver

编号No	YB2020-198
规格Size	Φ5
材料:	不锈钢
Materal:	Stainless steel



定位器

Guides

编号No	YB2020-199
规格Size	Φ5
材料:	不锈钢
Materal:	Stainless steel

NH II 8外固定支架器械包

NH II 8 external fixator instrument boxes

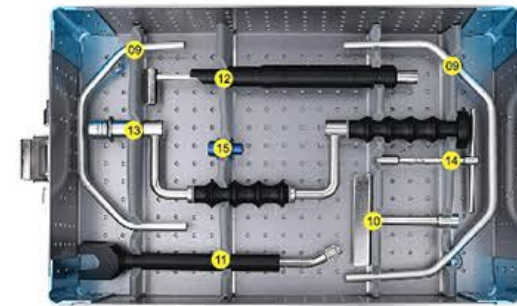
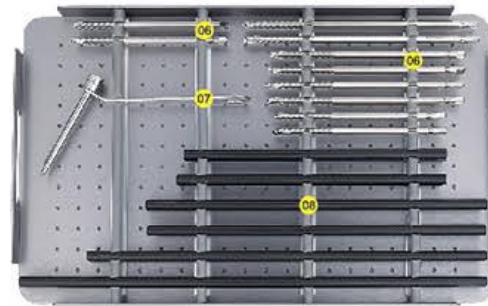
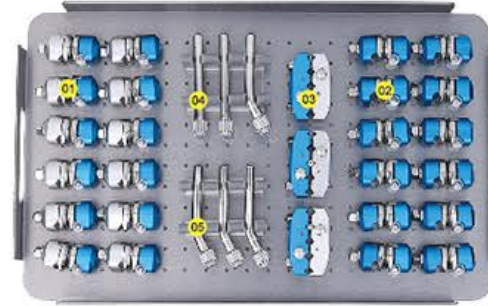

序号 No.	产品名称 Product Name	产品编号 Product No.	规格 Specification	数量 Qty
1	针杆固定夹 Pin to rod coupling	YB2020-201	Φ8/4-5	12
2	杆杆固定夹 Rod to rod coupling	YB2020-202	Φ8/8	12
3	5孔钢针固定夹 5-hole pin clamp	YB2020-203	Φ8/5	3
4	直支柱 Straight post	YB2020-204	Φ8	2
5	30° 支柱 30° post	YB2020-205	Φ8	4
6	自攻自钻骨牵引针 Self drilling/Self tapping bone screws	YB2020-206	Φ5×180	4
		YB2020-207	Φ5×150	8
		YB2020-208	Φ5×130	4
		YB2020-209	Φ5×120	4
7	定位器 Guides	YB2020-210	Φ5	1
8	连接杆 Carbon connecting rod	YB2020-211	Φ8×350	2
		YB2020-212	Φ8×300	2
		YB2020-213	Φ8×250	4
		YB2020-214	Φ8×200	4
9	半环形弓 Semi-circular curved connecting rod	YB2020-215	Φ8×160	1
		YB2020-216	Φ8×200	1
10	T型扳手 T wrench	YB2020-217	#7	1
11	稳定复位扳手 Stabilization/Reduction wrench	YB2020-218	#22	1
12	扭力扳手 Torque wrench	YB2020-219	#7	1
13	弓形钻架 Hand drill	YB2020-220	Φ5	1
14	上钉器 Screw driver	YB2020-221	Φ5	1
15	拇指轮 Thumb wheel	YB2020-222	#5/7	1
16	器械盒 Instrument set	YB2020-223		1

图示配置仅供参考，具体配置以实际为准。
Illustrates configuration for reference only, a specific configuration to the actual subject.



NO.YB2020940
胫骨近端骨折 Proximal tibia external fixator

配置 To configure	数量 Qty
杆杆固定夹Φ8/8 Rod to rod coupling	4
针杆固定夹Φ8/4-5 Pin to rod coupling	3
5孔钢针固定夹Φ8/5 5-hole pin clamp	1
30° 支柱Φ8 30° post	2
半环形弓Φ8×180mm Semi-circular curved connecting rod	1
连接杆Φ8×250mm Carbon fibre rod	2
自攻自钻骨牵引针Φ5×150mm Self drilling/Self tapping bone screws	5

适应症: 胫骨近端 Used for: Proximal tibia



NO.YB2020941
股骨干骨折 Femoral shaft fixator

配置 To configure	数量 Qty
杆杆固定夹Φ8/8 Rod to rod coupling	2
针杆固定夹Φ8/4-5 Pin to rod coupling	4
连接杆Φ8×200mm Carbon fibre rod	1
连接杆Φ8×250mm Carbon fibre rod	2
自攻自钻骨牵引针Φ5×150mm Self drilling/Self tapping bone screws	4

适应症: 股骨干 Used for: Femoral shaft

NO.YB2020942
半环形 (标准型) Half ring fixator(Standard)

配置 To configure	数量 Qty
杆杆固定夹Φ8/8 Rod to rod coupling	6
5孔钢针固定夹Φ8/5 5-hole pin clamp	2
30° 支柱Φ8 30° post	4
连接杆Φ8×300mm Carbon fibre rod	2
连接杆Φ8×250mm Carbon fibre rod	1
自攻自钻骨牵引针Φ5×150mm Self drilling/Self tapping bone screws	4

适应症: 胫骨、腓骨 Used for: Tibia, perone



NO.YB2020943
股骨近端骨折 Proximal femur fixator

配置 To configure	数量 Qty
杆杆固定夹Φ8/8 Rod to rod coupling	4
5孔钢针固定夹Φ8/5 5-hole pin clamp	2
30° 支柱Φ8 30° post	4
连接杆Φ8×300mm Carbon fibre rod	2
自攻自钻骨牵引针Φ5×150mm Self drilling/Self tapping bone screws	2
自攻自钻骨牵引针Φ5×180mm Self drilling/Self tapping bone screws	2

适应症: 股骨粗隆 Used for: Ptertrochanteric

图示配置仅供参考，具体配置以实际为准。
Illustrates configuration for reference only, a specific configuration to the actual subject.

NO.YB2020944
骨盆固定 Pelvic fixator

配置 To configure	数量 Qty
杆杆固定夹Φ8/8 Rod to rod coupling	6
5孔钢针固定夹Φ8/5 5-hole pin clamp	2
30° 支柱Φ8 30° post	2
连接杆Φ8×300mm Carbon fibre rod	2
连接杆Φ8×200mm Carbon fibre rod	2
自攻自钻骨牵引针Φ5×150mm Self drilling/Self tapping bone screws	4

适应症: 骨盆 Used for: Pelvic



NO.YB2020945
踝关节固定 Ankle joint fixator

配置 To configure	数量 Qty
杆杆固定夹Φ8/8 Rod to rod coupling	3
针杆固定夹Φ8/4-5 Pin to rod coupling	4
连接杆Φ8×250mm Carbon fibre rod	2
连接杆Φ8×200mm Carbon fibre rod	1
自攻自钻骨牵引针Φ5×150mm Self drilling/Self tapping bone screws	3
自攻自钻骨牵引针Φ4×130mm Self drilling/Self tapping bone screws	1

适应症: 踝关节 Used for: Ankle joint



NO.YB2020946
胫骨近端支架 Proximal tibia external fixator

配置 To configure	数量 Qty
针杆固定夹Φ8/4-5 Pin to rod coupling	4
杆杆固定夹Φ8/8 Rod to rod coupling	5
5孔钢针固定夹Φ8/5 5-hole pin clamp	1
30° 支柱Φ8 30° post	2
半环形弓Φ8×160 Semi-circular curved connecting rod	1
连接杆Φ8×200 Carbon fibre rod	3
自攻自钻骨牵引针Φ5×150mm Self drilling/Self tapping bone screws	5

适应症: 胫骨 Used for: Tibia



NO.YB2020947
踝关节融合 Ankle joint fixator

配置 To configure	数量 Qty
针杆固定夹Φ8/4-5 Pin to rod coupling	2
杆杆固定夹Φ8/8 Rod to rod coupling	2
5孔钢针固定夹Φ8/5 5-hole pin clamp	2
30° 支柱Φ8 30° post	2
连接杆Φ8×200 Carbon fibre rod	2
自攻自钻骨牵引针Φ5×150mm Self drilling/Self tapping bone screws	4

适应症: 踝关节 Used for: Ankle joint

图示配置仅供参考，具体配置以实际为准。
Illustrates configuration for reference only, a specific configuration to the actual subject.

NO.YB2020948

膝关节架 Knee joint fixator

配置 To configure	数量 Qty
针杆固定夹Φ8/4-5 Pin to rod coupling	3
杆杆固定夹Φ8/8 Rod to rod coupling	10
5孔钢针固定夹Φ8/5 5-hole pin clamp	2
30° 支柱Φ8 30° post	4
铝棒8×200 Connecting rod	1
铝棒8×250 Connecting rod	2
铝棒8×300 Connecting rod	2
半环形弓 Semi-circular curved connecting rod	1
自攻自钻骨牵引针5×150mm Self drilling/Self tapping bone screws	7

适应症: 膝关节 Used for: Knee joint fracture



NO.YB2020949

膝关节架 Knee joint fixator

配置 To configure	数量 Qty
杆杆固定夹Φ8/8 Rod to rod coupling	2
针杆固定夹Φ8/4-5 Pin to rod coupling	4
膝关节活动器Φ8 Knee joint mobilizer	1
5孔固定夹Φ8/5 5-hole pin clamp	1
30° 支柱Φ8 30° post	1
连接杆Φ8×150mm Carbon fibre stick	1
自攻自钻骨牵引针Φ5×150mm Self drilling/Self tapping bone screws	6

适应症: 膝关节 Used for: Knee joint



NO.YB2020950

踝关节架 Ankle joint fixator

配置 To configure	数量 Qty
针杆固定夹Φ5/3-4 Pin to rod coupling	1
针杆固定夹Φ8/4-5 Pin to rod coupling	4
踝关节活动器Φ8 Ankle joint mobilizer	1
自攻自钻骨牵引针Φ3×80mm Self drilling/Self tapping bone screws	1
自攻自钻骨牵引针Φ5×150mm Self drilling/Self tapping bone screws	4

适应症: 踝关节 Used for: Ankle joint



AO III外固定支架系统单件、工具 Parts & instruments of AO III external fixator



针杆固定夹
Pin to rod coupling

编号No	YB2020-224
规格Size	Φ8/4-5
材料: 不锈钢、合金铝	
Materal: Stainless steel、Aluminum	



开口杆杆固定夹
Ringent rod to rod coupling

编号No	YB2020-226
规格Size	Φ8/8
材料: 不锈钢、合金铝	
Materal: Stainless steel、Aluminum	



开口针杆固定夹
Ringent pin to rod coupling

编号No	YB2020-228
规格Size	Φ8/4-5
材料: 不锈钢、合金铝	
Materal: Stainless steel、Aluminum	



横向针杆固定夹
T clamp

编号No	YB2020-230
规格Size	Φ8/4
材料: 不锈钢、合金铝	
Materal: Stainless steel、Aluminum	



杆杆固定夹
Rod to rod coupling

编号No	YB2020-232
规格Size	Φ8/8
材料: 不锈钢、合金铝	
Materal: Stainless steel、Aluminum	



圆棒挂座针固定夹
Pin to rod coupling

编号No	YB2020-234
规格Size	Φ11/5-6、Φ8/3-4
材料: 不锈钢、合金铝	
Materal: Stainless steel、Aluminum	



针杆固定夹
Pin to rod coupling

编号No	YB2020-225
规格Size	Φ11/5-6
材料: 不锈钢、合金铝	
Materal: Stainless steel、Aluminum	



开口杆杆固定夹
Ringent rod to rod coupling

编号No	YB2020-227
规格Size	Φ11/11
材料: 不锈钢、合金铝	
Materal: Stainless steel、Aluminum	



开口针杆固定夹
Ringent pin to rod coupling

编号No	YB2020-229
规格Size	Φ11/5-6
材料: 不锈钢、合金铝	
Materal: Stainless steel、Aluminum	



横向针杆固定夹
T clamp

编号No	YB2020-231
规格Size	Φ11/5
材料: 不锈钢、合金铝	
Materal: Stainless steel、Aluminum	



杆杆固定夹
Rod to rod coupling

编号No	YB2020-233
规格Size	Φ11/11
材料: 不锈钢、合金铝	
Materal: Stainless steel、Aluminum	



针杆固定夹
Pin to rod coupling

编号No	YB2020-235
规格Size	Φ11/6
材料: 不锈钢、合金铝	
Materal: Stainless steel、Aluminum	

AO III外固定支架系统单件、工具
Parts & instruments of AO III external fixator



半环梯型弓
Semi-circular trapezoidal curved rod
编号No YB2020-236
规格Size $\Phi 11$ 、 $\Phi 8$
材料: 不锈钢、合金铝
Material: Stainless steel, Aluminum



主杆(梯形)
Trapezoidal curved rod
编号No YB2020-237
规格Size $\Phi 11$ 、 $\Phi 8$
材料: 不锈钢、合金铝
Material: Stainless steel, Aluminum



弧型弓
Curved rod
编号No YB2020-238
规格Size $\Phi 11$ 、 $\Phi 8$
材料: 不锈钢、合金铝
Material: Stainless steel, Aluminum



主杆
Carbon fibre rod
编号No YB2020-239
规格Size $\Phi 8$ - $\Phi 11$ 、长度100-400mm
材料: 碳纤维
Material: Stainless steel, Aluminum



开口扳手
Open spanner
编号No YB2020-240
规格Size 10/14、13/16mm



两用扳手
Combination spanner
编号No YB2020-241
规格Size 10mm、13mm



加压延长杆
Compression/distraction rod
编号No YB2020-242
规格Size $\Phi 8$
材料: 不锈钢
Material: Stainless steel



加压延长杆
Compression/distraction rod
编号No YB2020-243
规格Size $\Phi 8$
材料: 不锈钢
Material: Stainless steel



加压器
Pressurizer
编号No YB2020-244
规格Size $\Phi 11$
材料: 不锈钢
Material: Stainless steel



保护套
Tapered trocar & guide
编号No YB2020-245
规格Size $\Phi 4$ 、 $\Phi 5$ 、 $\Phi 6$
材料: 不锈钢
Material: Stainless steel



上钉器
T-wrench
编号No YB2020-246
规格Size $\Phi 2$ 、 $\Phi 2.5$ 、 $\Phi 3$ 、 $\Phi 3.5$ 、 $\Phi 4$ 、 $\Phi 5$ 、 $\Phi 6$
材料: 不锈钢
Material: Stainless steel

AO III外固定支架器械包 I
AO III external fixator instrument boxes I

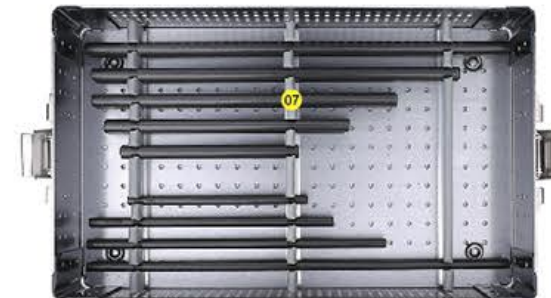
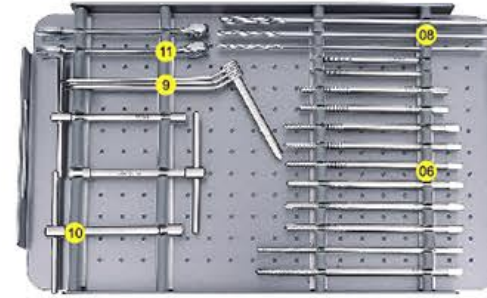

序号 No.	产品名称 Product Name	产品编号 Product No.	规格 Specification	数量 Qty
1	针杆固定夹 Pin to rod coupling	YB2020-247	$\Phi 8/4-5$	8
2	杆杆固定夹 Rod to rod coupling	YB2020-248	$\Phi 8/8$	4
3	针杆固定夹 Pin to rod coupling	YB2020-249	$\Phi 11/5-6$	12
4	杆杆固定夹 Rod to rod coupling	YB2020-250	$\Phi 11/11$	4
5	横向针杆固定夹 T clamp	YB2020-251	$\Phi 11/5$	2
6	骨牵引针 Bone screws	YB2020-252	$\Phi 6 \times 150(\text{HB})$	2
		YB2020-253	$\Phi 5 \times 150(\text{HB})$	4
		YB2020-254	$\Phi 5 \times 150$	4
		YB2020-255	$\Phi 5 \times 130$	4
		YB2020-256	$\Phi 4 \times 110$	4
		YB2020-257	$\Phi 4 \times 90$	4
		YB2020-258	$\Phi 11 \times 350$	2
		YB2020-259	$\Phi 11 \times 300$	2
		YB2020-260	$\Phi 11 \times 250$	2
		YB2020-261	$\Phi 11 \times 200$	2
		YB2020-262	$\Phi 11 \times 150$	2
		7	主杆 Carbon fibre rod	YB2020-263
YB2020-264	$\Phi 8 \times 250$			2
YB2020-265	$\Phi 8 \times 200$			2
YB2020-266	$\Phi 8 \times 150$			2
YB2020-267	$\Phi 2.8 \times 200$			2
YB2020-268	$\Phi 3.8 \times 200$			2
YB2020-269	$\Phi 4.8 \times 200$			2
8	骨钻 Drill bits	YB2020-270	$\Phi 4$ 、 $\Phi 5$ 、 $\Phi 6$	1
9	保护套 Tapered trocar & guide	YB2020-271	$\Phi 4$	1
10	上钉器 T-wrench	YB2020-272	$\Phi 5$	1
		YB2020-273	$\Phi 6$	1
		YB2020-274	10mm	2
11	两用扳手 Combination spanner	YB2020-275	AO- I型	1
12	AO器械盒 Instrument set			

AO III外固定支架器械包 II

AO III external fixator instrument boxes II

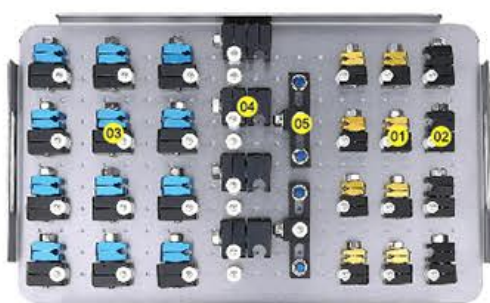

序号 No.	产品名称 Product Name	产品编号 Product No.	规格 Specification	数量 Qty
1	开口针杆固定夹 Ringent pin to rod coupling	YB2020-276	Φ8/4-5	8
2	开口杆杆固定夹 Ringent rod to rod coupling	YB2020-277	Φ8/8	4
3	开口针杆固定夹 Ringent pin to rod coupling	YB2020-278	Φ11/5-6	12
4	开口杆杆固定夹 Ringent rod to rod coupling	YB2020-279	Φ11/11	4
5	横向针杆固定夹 T clamp	YB2020-280	Φ11/5	2
6	骨牵引针 Bone screws	YB2020-281	Φ6×150(HB)	2
		YB2020-282	Φ5×150(HB)	2
		YB2020-283	Φ6×130	6
		YB2020-284	Φ5×130	6
		YB2020-285	Φ5×110	4
		YB2020-286	Φ4×90	4
7	主杆 Carbon fibre rod	YB2020-287	Φ11×350	2
		YB2020-288	Φ11×300	2
		YB2020-289	Φ11×250	2
		YB2020-290	Φ11×200	2
		YB2020-291	Φ11×150	2
		YB2020-292	Φ8×300	2
		YB2020-293	Φ8×250	2
		YB2020-294	Φ8×200	2
		YB2020-295	Φ8×150	2
		8	骨钻 Drill bits	YB2020-296
YB2020-297	Φ3.8×200			2
YB2020-298	Φ4.8×200			2
9	保护套 Tapered trocar & guide	YB2020-299	Φ4、Φ5、Φ6	1
10	上钉器 T-wrench	YB2020-300	Φ4	1
		YB2020-301	Φ5	1
		YB2020-302	Φ6	1
11	两用扳手 Combination spanner	YB2020-303	10mm	2
12	AO器械盒 Instrument set	YB2020-304	AO- II型	1

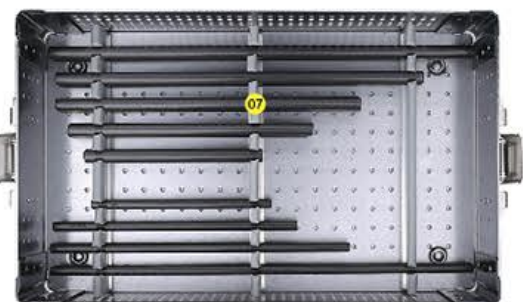
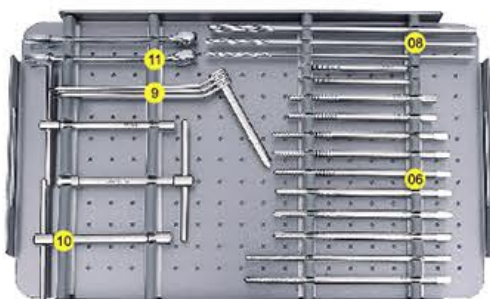

AO III外固定支架器械包 III

AO III external fixator instrument boxes III



序号 No.	产品名称 Product Name	产品编号 Product No.	规格 Specification	数量 Qty
1	圆棒挂座针固定夹 Pin to rod coupling	YB2020-305	Φ11/5-6	12
2	针杆固定夹 Ringent rod to rod coupling	YB2020-306	Φ11/5-6	9
3	横向针杆固定夹 T clamp	YB2020-307	Φ11/5	2
4	骨牵引针 Bone screws	YB2020-308	Φ6×150HB	2
		YB2020-309	Φ6×130	6
		YB2020-310	Φ5×150HB	2
		YB2020-311	Φ5×130	6
		YB2020-312	Φ5×110	4
		YB2020-313	Φ11×350	4
5	主杆 Carbon fibre rod	YB2020-314	Φ11×300	4
		YB2020-315	Φ11×250	4
		YB2020-316	Φ11×200	4
		YB2020-317	Φ11×150	4
		YB2020-318	Φ3.8×200	2
6	骨钻 Drill bits	YB2020-319	Φ4.8×200	2
		YB2020-320	Φ4、Φ5、Φ6	1
7	保护套 Tapered trocar & guide	YB2020-320	Φ4、Φ5、Φ6	1
8	上钉器 T-wrench	YB2020-321	Φ5	1
		YB2020-322	Φ6	1
9	两用扳手 Combination spanner	YB2020-323	10mm	2
10	AO器械盒 Instrument set	YB2020-324	AO- III型	1

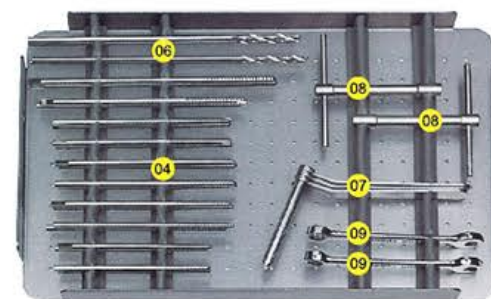

图示配置仅供参考，具体配置以实际为准。
Illustrates configuration for reference only, a specific configuration to the actual subject.

NO.YB2020951

Z型架 (T型) Pelvic fixator



配置 To configure	数量 Qty
开口针杆固定夹Φ8/4-5 Ringent pin to rod coupling	4
开口杆杆固定夹Φ8/8 Ringent rod to rod coupling	2
横向针杆固定夹Φ8/4 T clamp	1
主杆Φ8×100mm Carbon fibre rod	1
主杆Φ8×200mm Carbon fibre rod	2
骨牵引针Φ4×100mm Bone screws	4
骨牵引针HBΦ4×100mm Bone screws	2

适应症: 肱骨、胫骨、邻近关节端 Used for: Proximal humerus & tibia & adjacent joints

NO.YB2020952

半环型架 Half ring type



配置 To configure	数量 Qty
开口针杆固定夹Φ8/4-5 Ringent pin to rod coupling	6
开口杆杆固定夹Φ8/8 Ringent rod to rod coupling	6
半环梯形弓Φ8 Semi-circular curved rod	2
主杆Φ8×300 Carbon fibre rod	1
加压延长杆Φ8 Compression/distraction rod	2
骨牵引针Φ4.0×120mm Bone screws	6

适应症: 胫腓骨开放、闭合 Used for: Tibia & perone open & closed

NO.YB2020953

胫骨关节架 Tibial joint side fixator



配置 To configure	数量 Qty
开口针杆固定夹Φ8/4-5 Ringent pin to rod coupling	7
开口杆杆固定夹Φ8/8 Ringent rod to rod coupling	3
半环梯形弓Φ8 Semi-circular curved rod	1
弧形弓Φ8 Curved rod	1
主杆Φ8×300mm Carbon fibre rod	1
骨牵引针Φ4.0×120 Bone screws	7

适应症: 胫骨远端1/3关节、近端骨折 Used for: Distal tibial joint, proximal fracture

NO.YB2020954

髌上架 Condylar fixator



配置 To configure	数量 Qty
开口针杆固定夹Φ8/4-5 Ringent pin to rod coupling	6
开口杆杆固定夹Φ8/8 Ringent rod to rod coupling	3
半环梯形弓Φ8 Semi-circular trapezoidal curved rod	1
主杆(梯形)Φ8 Trapezoidal curved rod	1
主杆Φ8×250mm Carbon fibre rod	1
骨牵引针Φ4.0×120 Bone screws	6

适应症: 肱骨上髌、胫骨上髌、远端骨折 Used for: Humeral epicondyle, tibial epicondyle, distal fracture

图示配置仅供参考，具体配置以实际为准。
Illustrates configuration for reference only, a specific configuration to the actual subject.

NO.YB2020955

T型架 T type



配置 To configure	数量 Qty
圆棒挂座针固定夹Φ11/5-6 Pin to rod coupling	4
横向针杆固定夹Φ11/5 T clamp	1
主杆Φ11×300 Carbon fibre rod	1
骨牵引针Φ5×130mm Bone screws	4
骨牵引针HBΦ5×150mm Bone screws	2

适应症: 股骨、胫骨 Used for: Femur, Tibia

NO.YB2020956

直型架 (胫骨骨折) Straight type



配置 To configure	数量 Qty
针杆固定夹Φ11/5 Pin to rod coupling	4
主杆Φ11×250mm Carbon fibre rod	1
骨牵引针Φ5×120mm Bone screws	4

适应症: 胫骨 Used for: Tibia

NO.YB2020957

直型架 (股骨骨折) Straight type



配置 To configure	数量 Qty
针杆固定夹Φ11/5 Pin to rod coupling	4
主杆Φ11×250mm Carbon fibre rod	1
骨牵引针Φ6×120mm Bone screws	4

适应症: 胫骨 Used for: Tibia

NO.YB2020958

踝关节骨折 Ankle Joint external fixator



配置 To configure	数量 Qty
针杆固定夹Φ11/5 Pin to rod coupling	4
杆杆固定夹Φ11/11 Rod to rod coupling	1
主杆Φ11×250mm Carbon fibre rod	1
主杆Φ11×200mm Carbon fibre rod	1
骨牵引针Φ5×130mm Bone screws	4

适应症: 踝关节 Used for: Ankle Joint

NO.YB2020959

T型架 T type



配置 To configure	数量 Qty
针杆固定夹Φ11/5 Pin to rod coupling	4
横向针杆固定夹Φ11/5 T clamp	1
主杆Φ11×300 Carbon fibre rod	1
骨牵引针Φ5×130mm Bone screws	4
骨牵引针HBΦ5×130mm Bone screws	2

适应症: 胫骨多段 Used for: Tibia comminuted

图示配置仅供参考，具体配置以实际为准。
Illustrates configuration for reference only, a specific configuration to the actual subject.

NO.YB2020960

Z型架 (加强型) Z frame(Enhancement mode)



配置 To configure		数量 Qty
针杆固定夹Φ11/5	Pin to rod coupling	4
杆杆固定夹Φ11/11	Rod to rod coupling	2
主杆Φ11×200mm	Carbon fibre rod	2
主杆Φ11×150mm	Carbon fibre rod	1
骨牵引针Φ5×130mm	Bone screws	4
适应症: 股骨胫骨 Used for: Femur, Tibia		

NO.YB2020961

Z型架(T型) Z frame(T type)



配置 To configure		数量 Qty
针杆固定夹Φ11/5	Pin to rod coupling	2
杆杆固定夹Φ11/11	Rod to rod coupling	2
横向针杆固定夹Φ11/5	T clamp	1
主杆Φ11×100mm	Carbon fibre rod	1
主杆Φ11×150mm	Carbon fibre rod	2
骨牵引针Φ5×120mm	Bone screws	2
骨牵引针HBΦ5×130mm	Bone screws	2
适应症: 肱骨多段 Used for: Femur comminuted		

NO.YB2020962

标准型 (骨盆骨折) Straight type



配置 To configure		数量 Qty
针杆固定夹Φ11/5	Pin to rod coupling	8
杆杆固定夹Φ11/11	Rod to rod coupling	2
主杆Φ11×250mm	Carbon fibre rod	4
骨牵引针Φ5×120mm	Bone screws	4
适应症: 骨盆 Used for: Pelvic		

GY IV外固定支架系统单件

Parts of GY IV external fixator



单杆针管夹
Single rod clamp

编号No	YB2020-325
规格Size	Φ8/4-5
材料: 不锈钢	
Material: Stainless steel	



单杆管管夹
Double rods clamp

编号No	YB2020-326
规格Size	Φ8/8
材料: 不锈钢	
Material: Stainless steel	



双杆针管夹
Double rods pin clamp

编号No	YB2020-327
规格Size	Φ8/4-5
材料: 不锈钢	
Material: Stainless steel	



万向接头
Double rod to rod clamp

编号No	YB2020-328
规格Size	Φ8/8
材料: 不锈钢	
Material: Stainless steel	



弧形连接管
Curved connecting rod

编号No	YB2020-329
规格Size	Φ8
材料: 不锈钢	
Material: Stainless steel	



环形管
Semi-circular curved connecting rod

编号No	YB2020-330
规格Size	Φ8
材料: 不锈钢	
Material: Stainless steel	



梯形连接管
Trapezoidal curved connecting rod

编号No	YB2020-331
规格Size	Φ8
材料: 不锈钢	
Material: Stainless steel	



直杆
Stainless steel connecting rod

编号No	YB2020-332
规格Size	Φ8 长度150-350mm
材料: 不锈钢	
Material: Stainless steel	



加压延长杆
Compression/distraction rod

编号No	YB2020-333
规格Size	Φ8
材料: 不锈钢	
Material: Stainless steel	



加压延长杆
Compression/distraction rod

编号No	YB2020-334
规格Size	Φ8
材料: 不锈钢	
Material: Stainless steel	

单侧一体式、AO III、GY IV外固定系统工具

Instruments of Nondetachable unilateral, AO III, GY IV external fixation system



加压扳手
Wrench

编号No	YB2020-335
规格Size	4、5、6、7mm
材料: 不锈钢	
Material: Stainless steel	



钻头导向器
Template with handle

编号No	YB2020-336
规格Size	2.5、3.5mm
材料: 不锈钢	
Material: Stainless steel	



截骨器
Hto Instruments

编号No	YB2020-337
规格Size	Φ2.0、Φ2.5mm
材料: 不锈钢	
Material: Stainless steel	



内六角扳手
Hex wrench

编号No	YB2020-338
规格Size	3、4、5、6mm
材料: 不锈钢	
Material: Stainless steel	



两用扳手
Combination wrenches

编号No	YB2020-339
规格Size	10mm、13mm



开口扳手
Open spanner

编号No	YB2020-340
规格Size	10/14mm、13/16mm



保护套
Tapered trocar & guide

编号No	YB2020-341
规格Size	Φ3、Φ4、Φ5、Φ6mm
材料: 不锈钢	
Material: Stainless steel	

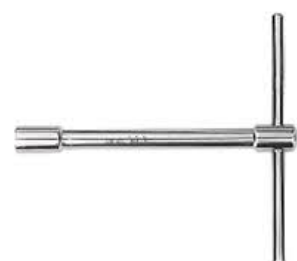

上钉器
Screw driver

编号No	YB2020-342
规格Size	Φ2、2.5、3、3.5、4、5、6mm



上钉器
Tension with pin

编号No	YB2020-343
规格Size	Φ3/4/5mm
材料: 不锈钢	
Material: Stainless steel	

图示配置仅供参考，具体配置以实际为准。
Illustrates configuration for reference only, a specific configuration to the actual subject.

NO.YB2020963

指骨型 Mini-fixator(Finger&Plam)

配置 To configure		数量 Qty
指掌骨支架	Mini fixator	1
骨牵引针Φ2.0×50mm	Bone screws	4
内六角扳手4mm	Allen wrench	1
上钉器Φ2.0mm	T-wrench	1

适应症: 指骨 Used for: Finger



NO.YB2020964

指掌骨型 Mini-fixator(Finger&Plam)

配置 To configure		数量 Qty
指掌骨支架	Mini fixator	1
骨牵引针Φ2.5×60mm	Bone screws	4
内六角扳手4mm	Allen wrench	1
上钉器Φ2.5mm	T-wrench	1

适应症: 指掌骨 Used for: Finger, Palm



NO.YB2020965

腕关节型 Wrist external fixator

配置 To configure		数量 Qty
腕关节支架	Mini fixator	1
骨牵引针Φ2.5×60mm	Bone screws	2
骨牵引针Φ3.5×70mm	Bone screws	2
内六角扳手4mm	Allen wrench	1
上钉器Φ2.5-3.5mm	T-wrench	1

适应症: 腕关节 Used for: Wrist joint



NO.YB2020966

骨盆架 Pelvic fixator

配置 To configure		数量 Qty
单杆管管夹Φ8/8	Double rods clamp	6
单杆针管夹Φ8/4-5	Single rod clamp	6
弧形连接管Φ8mm	Curved connecting rod	2
加压延长杆Φ8mm	Compression/distraction rod	1
直杆Φ8×150mm	Stainless steel connecting rod	2
骨牵引针Φ5×130mm	Bone screws	6

适应症: 骨盆 Used for: Pelvic



图示配置仅供参考，具体配置以实际为准。
Illustrates configuration for reference only, a specific configuration to the actual subject.

NO.YB2020967

半环型架(标准型) Semi-circular type(Standard)



配置 To configure		数量 Qty
单杆管管夹Φ8/8	Double rods clamp	6
单杆针管夹Φ8/4-5	Single rod clamp	6
环形管Φ8mm	Semi-circular curved connecting rod	2
直杆Φ8×300mm	Stainless steel connecting rod	1
加压延长杆Φ8mm	Compression/distraction rod	2
骨牵引针Φ4×120mm	Bone screws	2
克氏针Φ4×250mm	K-wire	2
适应症: 胫腓骨开放、闭合 Used for: Tibia&perone open&closed		

NO.YB2020968

胫骨关节端架(标准型) Tibial articular end frame (standard)



配置 To configure		数量 Qty
单杆针管夹Φ8/4-5	Single rod clamp	8
单杆管管夹Φ8/8	Double rods clamp	3
环形管Φ8mm	Semi-circular curved connecting rod	1
直杆Φ8×300mm	Stainless steel connecting rod	1
弧形连接管Φ8mm长	Curved connecting rod	1
骨牵引针Φ5×130mm	Bone screws	6
克氏针Φ4×250mm	K-wire	1
适应症: 胫骨近端、远端 Used for: proximal,distal tibial		

NO.YB2020969

股骨髁架(加强型) Femoral condylar fixator



配置 To configure		数量 Qty
单杆管管夹Φ8/8	Double rods clamp	3
单杆针管夹Φ8/4-5	Single rod clamp	5
双杆针管夹Φ8/4-5	Double rods pin clamp	2
环形管Φ8mm	Semi-circular curved connecting rod	1
直杆Φ8×300mm	Stainless steel connecting rod	2
弧形连接管Φ8mm长	Curved connecting rod	1
骨牵引针Φ5×130mm	Bone screws	7
适应症: 胫骨近端、远端 Used for: proximal,distal tibial		

NO.YB2020970

肘关节型 Elbow joint fixator



配置 To configure		数量 Qty
单杆针管夹Φ8/4-5	Single rod clamp	5
单杆管管夹Φ8/8	Double rods clamp	3
直杆Φ8×200mm	Stainless steel connecting rod	4
直杆Φ8×300mm	Stainless steel connecting rod	1
骨牵引针Φ4×120mm	Bone screws	5
适应症: 肘关节 Used for: Elbow joint		

环形外固定系统单件、工具

Parts&instruments of cyclic annular external fixator



全环
Rings

编号No	YB2020-344
规格Size	Φ80, 100, 120, 140, 160, 180, 200, 220mm
材料: 合金铝	Materal: Aluminum

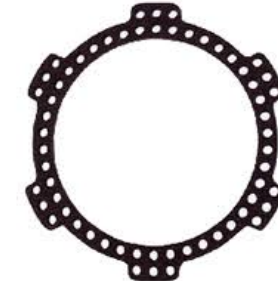

六耳全环
Rings with six ears

编号No	YB2020-345
规格Size	大、中、小
材料: 合金铝	Materal: Aluminum



三耳环
Rings with 3 ears

编号No	YB2020-346
规格Size	大、中、小
材料: 合金铝	Materal: Aluminum



三耳全环
Rings with 3 ears

编号No	YB2020-347
规格Size	大、中、小
材料: 合金铝	Materal: Aluminum



半环
Half rings

编号No	YB2020-348
规格Size	Φ80, 100, 120, 140, 160, 180, 200, 220mm
材料: 合金铝	Materal: Aluminum



2/3环
2/3 rings

编号No	YB2020-349
规格Size	Φ80, 100, 120, 140, 160, 180, 200, 220mm
材料: 合金铝	Materal: Aluminum



U型环
Foot ring

编号No	YB2020-350
规格Size	Φ140, 160, 180
材料: 不锈钢	Materal: Stainless steel



足环
U-Ring

编号No	YB2020-351
规格Size	大、中、小
材料: 合金铝	Materal: Aluminum



标准杆
Standard rod

编号No	YB2020-352
规格Size	长、标准、短



环形架斜拉杆
Annular diagonal tie
YB2020-355



快装杆
Packaged rod

编号No	YB2020-353
规格Size	长、标准、短



套管
Annular tubes
YB2020-356



弹簧
Spring
YB2020-357



调节螺母
Adjusting nut
YB2020-358



螺纹杆 (M6)
Threaded rod

编号No	YB2020-354
规格Size	Φ6×40-550



单关节
Single joint
YB2020-359



单关节
Single joint
YB2020-360



万向节
Universal joint
YB2020-361

环形外固定系统单件、工具

Parts&instruments of cyclic annular external fixator



四棱立柱
Post with 4 edges

编号No	YB2020-362
规格Size	1、2、3、4、5、6孔
材料: 不锈钢	
Material: Stainless steel	



四棱立柱衬套
Bush

编号No	YB2020-363
规格Size	Φ4、Φ5、Φ6
材料: 铝合金	
Material: Aluminum	



螺纹套筒
Post with 6 edges

编号No	YB2020-364
材料: 不锈钢	
Material: Stainless steel	



圆形立柱
Post

编号No	YB2020-365
材料: 不锈钢	
Material: Stainless steel	



孔针座
Pin to post coupling

编号No	YB2020-366
规格Size	Φ4、Φ5
材料: 不锈钢	
Material: Stainless steel	



带螺纹直形支柱
Threaded column

编号No	YB2020-367
规格Size	1-6孔
材料: 不锈钢	
Material: Stainless steel	



偏心螺母立柱
Hinge-female

编号No	YB2020-368
材料: 不锈钢	
Material: Stainless steel	



偏心螺纹立柱
Hinge-male

编号No	YB2020-369
材料: 不锈钢	
Material: Stainless steel	



直形支柱
Nut column

编号No	YB2020-370
规格Size	1-6孔
材料: 不锈钢	
Material: Stainless steel	



L型连接板
L connecting plate

编号No	YB2020-371
规格Size	1、4、5、6、7、8、9、10孔
材料: 不锈钢	
Material: Stainless steel	



直形连接板
Connecting plate

编号No	YB2020-372
规格Size	2-8孔
材料: 不锈钢	
Material: Stainless steel	



克氏针张紧器
Tension with pin

编号No	YB2020-373
规格Size	Φ1.5-3.0mm
材料: 不锈钢	
Material: Stainless steel	



曲形连接板
Cross connecting plate

编号No	YB2020-374
规格Size	1-6孔
材料: 不锈钢	
Material: Stainless steel	



延长套
Inner threaded connecting rod

编号No	YB2020-375
规格Size	60、80、100、120
材料: 不锈钢	
Material: Stainless steel	



针座
Pin clamp

编号No	YB2020-376
规格Size	Φ4、5mm
材料: 不锈钢	
Material: Stainless steel	



针座(加厚)
Pin clamp(Thickening)

编号No	YB2020-377
规格Size	Φ1.5-2、Φ2-3mm
材料: 不锈钢	
Material: Stainless steel	



钻头限位器
Drill bit stop unit

编号No	YB2020-378
材料: 不锈钢	
Material: Stainless steel	



六角螺母M6(加厚)
Hex nut M6(Thickening)

编号No	YB2020-379
材料: 不锈钢	
Material: Stainless steel	



螺栓
M6 bolt

编号No	YB2020-380
材料: 不锈钢	
Material: Stainless steel	



环杆螺栓
Rod to ring bolt

编号No	YB2020-381
材料: 不锈钢	
Material: Stainless steel	



垫片(带槽)
Cone washer

编号No	YB2020-382
材料: 不锈钢	
Material: Stainless steel	

图示配置仅供参考，具体配置以实际为准。
Illustrates configuration for reference only, a specific configuration to the actual subject.



NO.YB2020971

延长架 Lower limb lengthening external fixator

适应症: 胫骨、股骨骨折带延长
Used for: Tibia, Femur

NO.YB2020972

矫形架 Orthopedic external fixator

适应症: 肱骨外上髁、胫骨外上髁
Used for: Humeral & tibial lateral epicondyle



NO.YB2020973

环状架 Ring fixator

适应症: 胫骨、股骨骨折
Used for: Tibia, Femur

NO.YB2020974

2/3环状架 2/3Ring fixator

适应症: 胫骨、股骨骨折
Used for: Tibia, Femur



图示配置仅供参考，具体配置以实际为准。
Illustrates configuration for reference only, a specific configuration to the actual subject.



NO.YB2020975
踝关节架 Ankle joint fixator
适应症：马蹄足内翻、外翻
Used for: Equinus



NO.YB2020976
环状架 Ring fixator
适应症：胫骨、股骨骨折
Used for: Tibia, Femur



NO.YB2020977
膝关节架 Knee joint fixator
适应症：膝关节
Used for: Knee joint



NO.YB2020978
泰勒三维空间外固定支架 Ring fixator
适应症：胫骨、股骨骨折
Used for: Tibia, Femur

以下产品规格均可以定制
The size can be adjusted according to the customer's requirement

标准骨牵引针
Standard bone screws



编号 No.	直径 × 总长 D × L (mm)	HA/HB	螺纹直径 D (mm)	螺纹长度 L (mm)	材质 M			
YB2020-383	Φ2.0 × 50	HA	Φ2.0	15	不锈钢 SS 钛 Ti			
YB2020-384	Φ2.0 × 60			15				
YB2020-385	Φ2.0 × 70			15				
YB2020-386	Φ2.5 × 60	HA	Φ2.5	15	不锈钢 SS 钛 Ti			
YB2020-387	Φ2.5 × 70			15				
YB2020-388	Φ2.5 × 80			15				
YB2020-389	Φ3.0 × 60	HA	Φ3.0	18	不锈钢 SS 钛 Ti			
YB2020-390	Φ3.0 × 70			18				
YB2020-391	Φ3.0 × 80			18				
YB2020-392	Φ3.5 × 70	HA	Φ3.5	20	不锈钢 SS 钛 Ti			
YB2020-393	Φ3.5 × 80			20				
YB2020-394	Φ4.0 × 70	HA	Φ4.0	20	不锈钢 SS 钛 Ti			
YB2020-395	Φ4.0 × 80			25				
YB2020-396	Φ4.0 × 90			25				
YB2020-397	Φ4.0 × 100			25				
YB2020-398	Φ4.0 × 110			30				
YB2020-399	Φ4.0 × 120			30				
YB2020-400	Φ4.0 × 130			35				
YB2020-401	Φ5.0 × 90			HB		Φ5.0	25	不锈钢 SS 钛 Ti
YB2020-402	Φ5.0 × 100						25	
YB2020-403	Φ5.0 × 110						30	
YB2020-404	Φ5.0 × 120	30						
YB2020-405	Φ5.0 × 130	30						
YB2020-406	Φ5.0 × 150	40						
YB2020-407	Φ5.0 × 180	45						
YB2020-408	Φ5.0 × 200	50						
YB2020-409	Φ5.0 × 220	50						
YB2020-410	Φ5.0 × 90	HA	Φ5.0	25	不锈钢 SS 钛 Ti			
YB2020-411	Φ5.0 × 100			25				
YB2020-412	Φ5.0 × 110			30				
YB2020-413	Φ5.0 × 120			30				
YB2020-414	Φ5.0 × 130			30				
YB2020-415	Φ5.0 × 150			40				
YB2020-416	Φ5.0 × 180			45				
YB2020-417	Φ5.0 × 200	50						
YB2020-418	Φ5.0 × 220	50						
YB2020-419	Φ6.0 × 100	HB	Φ6.0	25	不锈钢 SS 钛 Ti			
YB2020-420	Φ6.0 × 110			30				
YB2020-421	Φ6.0 × 120			30				
YB2020-422	Φ6.0 × 130			35				
YB2020-423	Φ6.0 × 150			40				
YB2020-424	Φ6.0 × 180			45				
YB2020-425	Φ6.0 × 200			50				
YB2020-426	Φ6.0 × 80	HA	Φ6.0	25	不锈钢 SS 钛 Ti			
YB2020-427	Φ6.0 × 90			25				
YB2020-428	Φ6.0 × 100			25				
YB2020-429	Φ6.0 × 110			30				
YB2020-430	Φ6.0 × 120			30				
YB2020-431	Φ6.0 × 130			35				
YB2020-432	Φ6.0 × 150			40				
YB2020-433	Φ6.0 × 180			45				
YB2020-434	Φ6.0 × 200			50				

自攻自钻骨牵引针

Self drilling/Self tapping bone screws

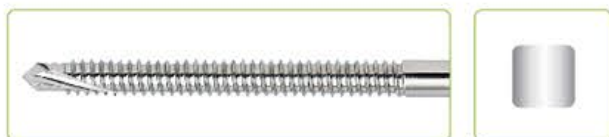

针尾形状

编号 No.	直径×总长 D×L(mm)	HA/HB	螺纹直径 D(mm)	螺纹长度 L(mm)	材质 M
YB2020-435	Φ3.0×60	HA	Φ3.0	15	不锈钢 SS 钛 Ti
YB2020-436	Φ3.0×80			20	
YB2020-437	Φ3.0×90			20	
YB2020-438	Φ3.0×100			25	
YB2020-439	Φ3.0×120			25	
YB2020-440	Φ4.0×80	HA	Φ4.0	20	不锈钢 SS 钛 Ti
YB2020-441	Φ4.0×90			20	
YB2020-442	Φ4.0×100			25	
YB2020-443	Φ4.0×120			30	
YB2020-444	Φ4.0×130			30	
YB2020-445	Φ4.0×150			40	
YB2020-446	Φ5.0×100			HA	
YB2020-447	Φ5.0×120	30			
YB2020-448	Φ5.0×130	30			
YB2020-449	Φ5.0×150	40			
YB2020-450	Φ5.0×180	45			
YB2020-451	Φ5.0×200	50			
YB2020-452	Φ5.0×220	50			

(髌骨针) 带孔别针

Tension pin



编号 No.	直径×总长 D×L(mm)	材质 M
YB2020-453	Φ2.0×50	钛合金 Ti
YB2020-454	Φ2.0×55	
YB2020-455	Φ2.0×60	
YB2020-456	Φ2.0×65	
YB2020-457	Φ2.0×70	
YB2020-458	Φ2.5×70	

克氏针

K-wire



编号 No.	直径 D(mm)	长度 L(mm)	材质 M
YB2020-459	0.80	100	不锈钢 SS 钛 Ti
YB2020-460	1.00		
YB2020-461	1.20		
YB2020-462	1.50	120	不锈钢 SS 钛 Ti
YB2020-463	0.80		
YB2020-464	1.00		
YB2020-465	1.20		
YB2020-466	1.50		
YB2020-467	0.80	150	不锈钢 SS 钛 Ti
YB2020-468	1.00		
YB2020-469	1.20		
YB2020-470	1.50		
YB2020-471	0.80	250	不锈钢 SS 钛 Ti
YB2020-472	1.00		
YB2020-473	1.20		
YB2020-474	1.50		
YB2020-475	1.60		
YB2020-476	1.80		
YB2020-477	2.00		
YB2020-478	2.50		
YB2020-479	3.00		
YB2020-480	3.50		
YB2020-481	4.00		
YB2020-482	4.50		
YB2020-483	0.80	300	不锈钢 SS 钛 Ti
YB2020-484	1.00		
YB2020-485	1.20		
YB2020-486	1.50		
YB2020-487	1.60		
YB2020-488	1.80		
YB2020-489	2.00		
YB2020-490	2.50		
YB2020-491	3.00		
YB2020-492	3.50		
YB2020-493	4.00		
YB2020-494	4.50		

弹性髓内针

Elastic nail



编号 No.	直径 D(mm)	长度 L(mm)	材质 M
YB2020-495	1.50	440	钛合金 Ti
YB2020-496	2.00		
YB2020-497	2.50		
YB2020-498	3.00		
YB2020-499	3.50		
YB2020-500	4.00		

橄榄针

K-wire with olive



针头形状

编号 No.	直径 D(mm)	长度 L(mm)	材质 M
YB2020-501	1.50	350	不锈钢 SS
YB2020-502	2.00		
YB2020-503	2.50		

螺纹导针

Threaded guide wire



编号 No.	直径 D(mm)	长度 L(mm)	材质 M
YB2020-504	1.20	100	不锈钢 SS 钛 Ti
YB2020-505	1.50		
YB2020-506	2.00		
YB2020-507	2.50	120	不锈钢 SS 钛 Ti
YB2020-508	3.00		
YB2020-509	1.20		
YB2020-510	1.50		
YB2020-511	2.00		
YB2020-512	2.50	150	不锈钢 SS 钛 Ti
YB2020-513	3.00		
YB2020-514	1.20		
YB2020-515	1.50		
YB2020-516	2.00	250	不锈钢 SS 钛 Ti
YB2020-517	2.50		
YB2020-518	3.00		
YB2020-519	1.20		
YB2020-520	1.50		
YB2020-521	2.00	300	不锈钢 SS 钛 Ti
YB2020-522	2.50		
YB2020-523	3.00		
YB2020-524	1.20		
YB2020-525	1.50	300	不锈钢 SS 钛 Ti
YB2020-526	2.00		
YB2020-527	2.50		
YB2020-528	3.00		

骨钻

Drill bit



编号 No.	直径 D(mm)	长度 L(mm)	材质 M
YB2020-529	1.0	115	不锈钢 SS
YB2020-530	1.2	115	
YB2020-531	1.5	115	
YB2020-532	1.8	115	
YB2020-533	2.0	115	
YB2020-534	2.5	115	
YB2020-535		150	
YB2020-536	200		
YB2020-537	115		
YB2020-538	2.8	150	
YB2020-539	3.0	200	
YB2020-540		115	
YB2020-541	150		
YB2020-542	200		
YB2020-543	3.2	115	
YB2020-544		150	
YB2020-545	200		
YB2020-546	3.5	115	
YB2020-547		150	
YB2020-548	200		
YB2020-549	3.8	115	
YB2020-550		150	
YB2020-551	200		
YB2020-552	4.0	115	
YB2020-553		150	
YB2020-554	200		
YB2020-555	4.2	115	
YB2020-556		150	
YB2020-557	200		
YB2020-558	4.5	115	
YB2020-559		150	
YB2020-560	200		
YB2020-561	4.8	115	
YB2020-562		150	
YB2020-563	200		
YB2020-564	5.0	150	
YB2020-565		200	

扎丝

Suture-wire



编号 No.	直径 D(mm)	材质 M
YB2020-566	0.6	不锈钢 SS 钛合金 Ti
YB2020-567	0.8	
YB2020-568	1.0	
YB2020-569	1.2	