

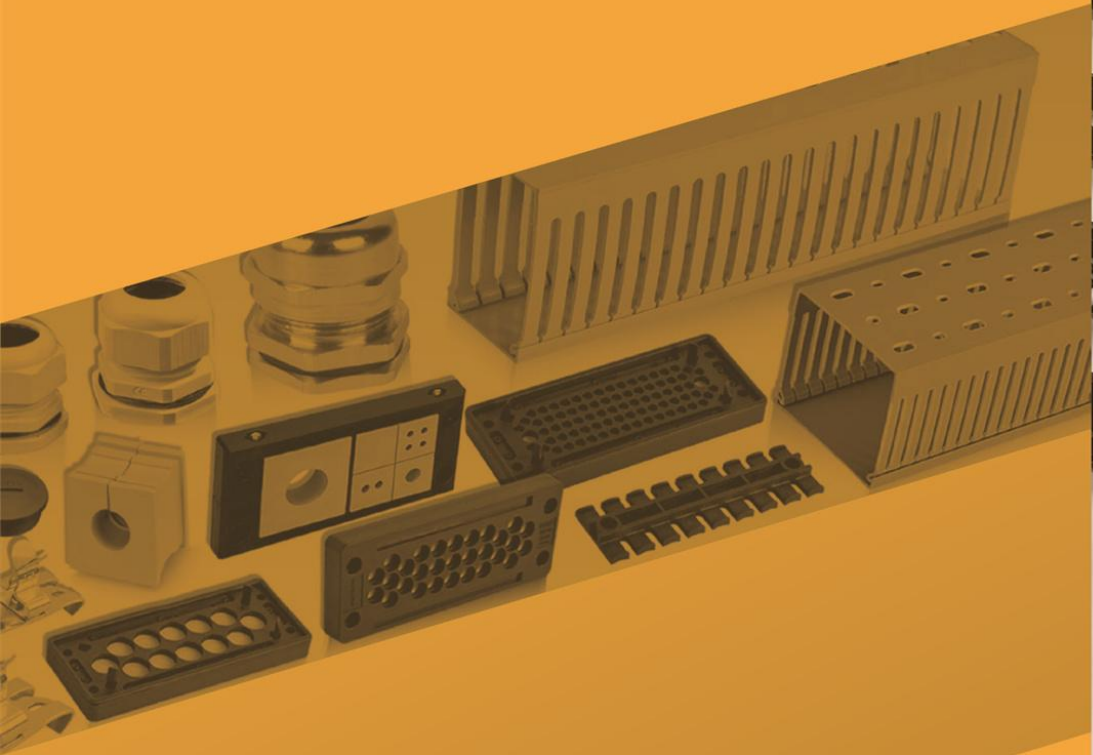

LINKWELL[®]
ELECTRIC



CABLE
MANAGEMENT
SYSTEM



LKP SERIES

PLASTIC RECTANGULAR CABLE ENTRY PLATE

Energy saving, environmental protection, and efficient product performance meet the requirements of temperature control systems

IP65 

LKP/N 24/11



LKP/N 24/12



LKP/N 24/13



LKP/N 24/14



LKP/N 24/17



LKP/N 24/17-1



LKP/N 24/22



LKP/N 24/22-1



LKP/N 24/23



LKP/N 24/29



LKP/N 24/29-1



LKP/N 24/80



PARAMETERS
Material: improved polyamides

Temperature range: -30°C ~ +70°C

Protection grade: IP65

Flame retardancy: UL 94 V0

External dimensions: L=147mm×B=59×15mm

The tensile properties are consistent DIN/EN 50262/98 weak acids and bases.

Color: black

The size of the hole: 36×112mm

Thickness of protection: 14mm

Harmful ingredients: halogen-free

PECULIARITY

- Save space
- Built-in sealing structure
- Single entry mode
- The possibility of cable and cable marking

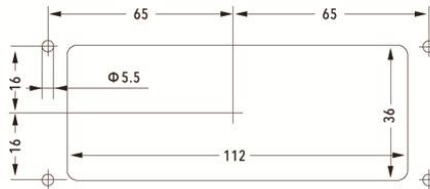
DIMENSION (mm)

Model No.	The corresponding cable diameter(mm)									Holes
	1.5-2.6	2.5-5.0	3.0-6.5	4.1-8.1	5.0-9.2	8.0-12.5	9.0-14.0	9.6-15.9	14.0-20.0	
LKP/N 24/11	--	--	4	--	4	--	--	--	3	11
LKP/N 24/12	--	--	--	--	--	12	--	--	--	12
LKP/N 24/13	--	--	2	6	--	--	4	--	1	13
LKP/N 24/14	--	--	6	--	4	--	--	4	--	14
LKP/N 24/17	--	--	--	--	17	--	--	--	--	17
LKP/N 24/17-1	--	--	11	1	--	5	--	--	--	17
LKP/N 24/22	--	--	15	--	6	--	--	--	1	22
LKP/N 24/22-1	--	--	16	--	4	2	--	--	--	22
LKP/N 24/23	--	--	--	23	--	--	--	--	--	23
LKP/N 24/29	--	--	29	--	--	--	--	--	--	29
LKP/N 24/29-1	--	--	26	--	3	--	--	--	--	29
LKP/N 24/80	78	2	--	--	--	--	--	--	--	80

LK series



LK stress-relieving plates can be used to reduce the stress on cables, ropes or wires, making them reasonably arranged, simplifying and reducing costs.

Material: polyamides

Temperature range: -40 ~ +125°C can be up to +140°C in a short time.

Flame retardancy: UL 94 V0



Model No.	Color	No. of Teeth	Model No.	Color	No. of Teeth
LK04	black	12	LK87/50	black	6
LK05	black	15	LK103	black	7
LK39	black	3	LK121	black	8
LK60	black	4	LK140	black	9
LK70	black	5	LK180/6	black	12
LK80	black	6	LK180/8	black	12
LK87/68	black	6			

LK-KAF series



LK stress-relieving plates can be used to reduce the stress on cables, ropes or wires, making them reasonably arranged, simplifying and reducing costs.

Applicable: 35mm HAT rail (EN 50022; Niedax 2934; 2936) or track C (Niedax2970); 2971).

Material: polyamides

Temperature range: -40 ~ +125°C can be up to +140°C in a short time.

Flame retardancy: UL 94 V0



Model No.	Color	No. of Teeth
LK-KAF11	Black	1
LK-KAF75	Black	5
LK-KAF140	Black	9

LK-MH series

MH is to add metal gaskets to standard LK products to enhance the fixed strength.

Material: polyamides

Temperature range: -40 ~ +125°C can be up to +140°C in a short time.

Flame retardancy: UL 94 V0



Model No.	Color	No. of Teeth	Model No.	Color	No. of Teeth
LK-MH39	black	3	LK-MH39/6	black	3
LK-MH60	black	4	LK-MH60/6	black	4
LK-MH87	black	6	LK-MH70/6	black	5
LK-MH103	black	7	LK-MH87/6	black	6
LK-MH121	black	8	LK-MH103/6	black	7
LK-MH140	black	9	LK-MH121/6	black	8
LK-MH180	black	12	LK-MH140/6	black	9
			LK-MH180/6	black	12

LK-SW series

SW is a metal fixing device which can be directly fixed on the C track on the standard LK products and is specially used in the locomotive industry.

Material: polyamides

Temperature range: -40 ~ +125°C can be up to +140°C in a short time.

Flame retardancy: UL 94 V0



Model No.	Color	No. of Teeth
LK-SW39	black	3
LK-SW60	black	4
LK-SW87	black	6
LK-SW103	black	7
LK-SW121	black	8
LK-SW140	black	9
LK-SW180/6	black	12



CES-CABLE
ENTRY SYSTEMS

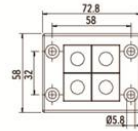
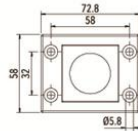

FRAME HEIGHT: 17MM
CES 6 Standard cable entry frame

 -40 ~ +140
°C

Material: Nylon 66, halogen free
Protection level: IP54/IP65 (with gasket and correct selection of the cable inserts)
Cut-out dimensions: 46x46mm

Type	Inserts Small/large	Order No.	PU
CES6/1	Insert Medium	600101	5
CES6/4	Insert Small	600102	5

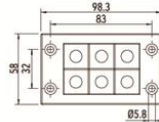
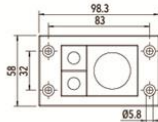
CES 10 Standard cable entry frame

 -40 ~ +140
°C

Material: Nylon 66, halogen free
Protection level: IP54/IP65 (with gasket and correct selection of the cable inserts)
Cut-out dimensions: 36x65mm

Type	Inserts Small/large	Order No.	PU
CES10/3	Insert Medium/Insert small	600103	5
CES10/6	Insert Small	600104	5



Material: Nylon 66, halogen free
Protection level: IP54/IP65 (with gasket and correct selection of the cable inserts)
Cut-out dimensions: 36x86mm

CES 16 Standard cable entry frame

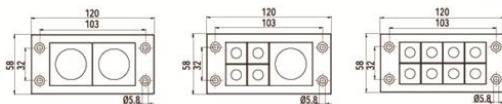

Type	Inserts Small/large	Order No.	PU
CES 16/2	Insert Medium	600105	5
CES 16/5	Insert Medium/Insert Small	600106	5
CES 16/8	Insert Small	600107	5



Material: Nylon 66, halogen free
Protection level: IP54/IP65 (with gasket and correct selection of the cable inserts)
Cut-out dimensions: 36x112mm

CES 24 Standard cable entry frame

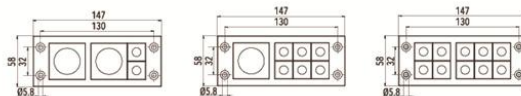

Type	Inserts Small/large	Order No.	PU
CES 24/4	Insert Medium/Insert Small	600108	5
CES 24/7	Insert Medium/Insert Small	600109	5
CES 24/10	Insert Small	600110	5



Protection level: IP54/IP65 (with gasket and correct selection of the cable inserts)

CES standard snap frame



Used to assemble CES6,10,16,24 series frame, connected with cabinet with screw bolts

Type	Order No.	PU
CES SNAP6	600111	5
CES SNAP10	600112	5
CES SNAP16	600113	5
CES SNAP24	600114	5



Frame: polyamide (nylon)
Brush: polyamide (nylon)
Temperature: -20°C-90°C Halogen free, silicon free
Height: 10mm

Standard cable entry frame with brush

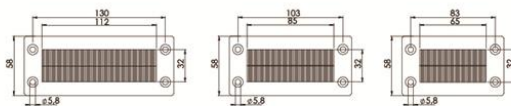

Type	Cut-out dimensions	Order No.	PU
CES BES/24	36x112mm	600431	5
CES BES/16	36x86mm	600432	5
CES BES/10	36x65mm	600433	5

Brush

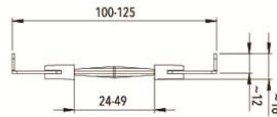

Type	Control cabinet length	Brush Length	Drilling Length	Order No.	PU
CES-BES-TS8-600	600	458mm	436mm	600434	5
CES-BES-TS8-800	800	658mm	636mm	600435	5
CES-BES-TS8-1000	1000	858mm	836mm	600436	5

Single row cable entry frame

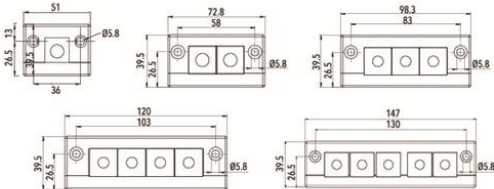

Material: Nylon 66, halogen free

Protection level: IP54/IP65 (with gasket and correct selection of the cable inserts)

Cut-out dimensions: E1: 24x24mm E2: 43x24mm
E3: 65x24mm E4: 86x24mm
E5: 112x24mm

Type	Inserts Small/large	Order No.	PU
CES E1	Insert Small	600437	5
CES E2	Insert Small	600115	5
CES E3	Insert Small	600116	5
CES E4	Insert Small	600117	5
CES E5	Insert Small	600118	5

CES ED double row cable entry frame

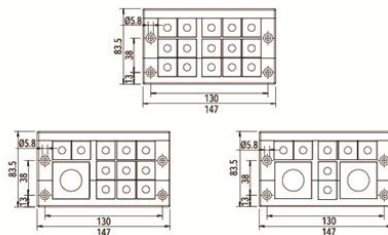

Frame: polyamide (nylon)

Brush: polyamide (nylon)

Temperature: -20°C-90°C Halogen free, silicon free

Cut-out dimensions: 62x112mm

Type	Inserts Small/large	Order No.	PU
CES 24/15-ED	Insert small	600119	5
CES 24/12-ED	Insert Medium/Insert Small	600120	5
CES 24/9-ED	Insert Medium/Insert Small	600121	5



Material: Nylon 66, halogen free
Protection level: IP54/IP65 (with gasket and correct selection of the cable inserts)
Cut-out dimensions: 82x112mm

CES ET double row cable entry frame

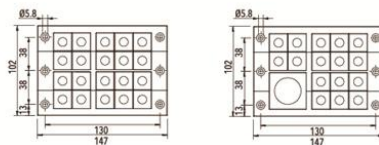

Type	Inserts Small/large	Order No.	PU
CES 24/20-ET	Insert Small	600122	5
CES 24/17-ET	Insert Medium/Insert Small	600123	5



Material: Nylon 66, halogen free
Protection level: IP54/IP65 (with gasket and correct selection of the cable inserts)
Cut-out dimensions: 82x112mm

CES ET double row cable entry frame

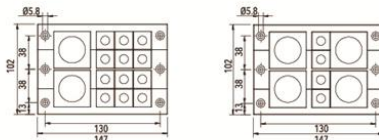

Type	Inserts Small/large	Order No.	PU
CES 24/14-ET	Insert Medium/Insert Small	600124	5
CES 24/8-ET	Insert Medium/Insert Small	600125	5



Material: Nylon 66, halogen free
Protection level: IP54/IP65 (with gasket and correct selection of the cable inserts)
Cut-out dimensions: 82x86mm

CES ET double row cable entry frame

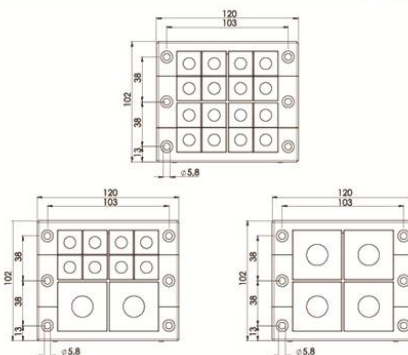

Type	Inserts Small/large	Order No.	PU
CES 16/16-ET	Insert Small	600438	5
CES 16/10-ET	Insert Medium/Insert Small	600439	5
CES 16/4-ET	Insert Medium	600440	5



CES ET Triple row cable entry frame

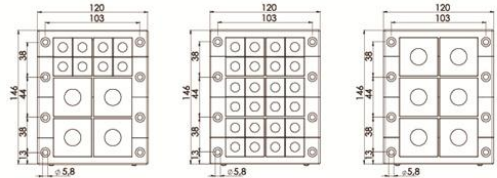

Material: Nylon 66, halogen free
Protection level: IP54/IP65 (with gasket and correct selection of the cable inserts)
Cut-out dimensions: 126x86mm

Type	Inserts Small/large	Order No.	PU
CES 16/24-2ET	Insert Small	600441	5
CES 16/12-2ET	Insert Medium/Insert Small	600442	5
CES 16/6-2ET	Insert Medium	600443	5



CES 2ET triple row cable entry frame

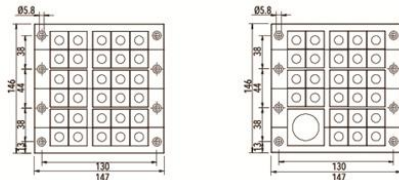

Material: Nylon 66, halogen free
Protection level: IP54/IP65 (with gasket and correct selection of the cable inserts)
Cut-out dimensions: 126x112mm

Type	Inserts Small/large	Order No.	PU
CES 24/30-2ET	Insert small	600126	5
CES 24/27-2ET	Insert Medium/Insert small	600127	5

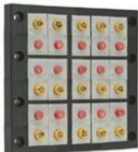

CES 2ET triple row cable entry frame

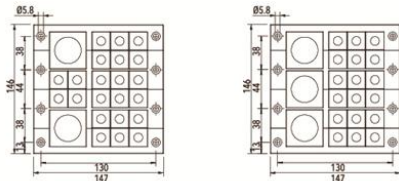

Material: Nylon 66, halogen free
Protection level: IP54/IP65 (with gasket and correct selection of the cable inserts)
Cut-out dimensions: 126x112mm

Type	Inserts Small/large	Order No.	PU
CES 24/24-2ET	Insert Medium/Insert small	600128	5
CES 24/21-2ET	Insert Medium/Insert small	600129	5



Material: Nylon 66, halogen free
Protection level: IP54/IP65 (with gasket and correct selection of the cable inserts)
Cut-out dimensions: 126x112mm

FRAME HEIGHT: 35MM

CES 2ET triple row cable entry frame

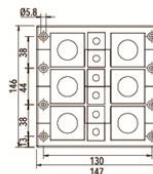

Type	Inserts Small/large	Order No.	PU
CES 24/12-2ET	Insert Medium/Insert Small	600130	5

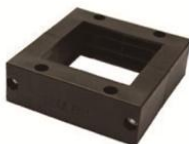

Material: Nylon 66, halogen free
Protection level: IP54/IP65 (with gasket and correct selection of the cable inserts)
Cut-out dimensions: Cable diameter+15-50%
Thickness: 34.5mm

CES 64 Cable entry frame for large conductor

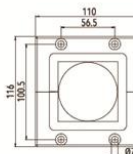

Type	Inserts Small/large	Order No.	PU
CES 64/1	Insert large	6004501	5



Material: Nylon 66, halogen free
Protection level: IP54/IP65 (with gasket and correct selection of the cable inserts)
Cut-out dimensions: Cable diameter+15-50%
Thickness: 34.5mm

CES 64 Cable entry frame for large conductor

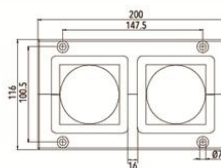

Type	Inserts Small/large	Order No.	PU
CES 64/2	Insert large	6004502	5

Cable inserts for large Conductor

Inserts for large conductor X: 34-74mm
Material: TPE, halogen free
Color: Grey, Black
Protection level: IP54/IP65 (with gasket and correct selection of the cable inserts)
Flame Class: UL94 V2, V0(Customized)



Type	Order No.(Grey)	Order No.(Black)	PU
CES X-(X+1)	60045X	60145X	5

FRAME HEIGHT: 17MM



Material: Nylon 66, halogen free
Protection level: IP54/IP65 (with gasket and correct selection of the cable inserts)
Cut-out dimensions: 24x24mm, 43x24mm, 65x24mm

CES NL Cable entry frame for flat conductor

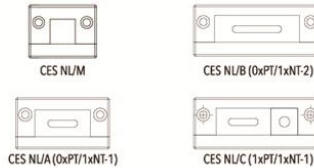

Type	Order No.	PU
CES NL/M	600444	5
CES NL/A (0xPT/1xNT-1)	600133	5
CES NL/B (0xPT/1xNT-2)	600134	5
CES NL/C (1xPT/1xNT-1)	600135	5



Material: Nylon 66, halogen free
Protection level: IP54/IP65 (with gasket and correct selection of the cable inserts)
Cut-out dimensions: 86x24mm

CES NL Cable entry frame for flat conductor

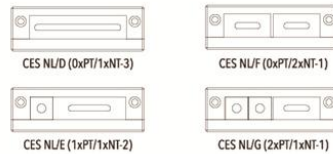

Type	Order No.	PU
CES NL/D (0xPT/1xNT-3)	600136	5
CES NL/E (1xPT/1xNT-2)	600137	5
CES NL/F (0xPT/2xNT-1)	600138	5
CES NL/G (2xPT/1xNT-1)	600139	5



Material: Nylon 66, halogen free
Protection level: IP54/IP65 (with gasket and correct selection of the cable inserts)
Cut-out dimensions: 112x24mm

CES NL Cable entry frame for flat conductor

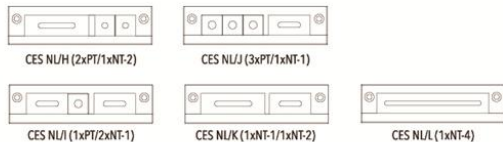

Type	Order No.	PU
CES NL/H (2xPT/1xNT-2)	600140	5
CES NL/I (1xPT/2xNT-1)	600141	5
CES NL/J (3xPT/1xNT-1)	600142	5
CES NL/K (1xNT-1/1xNT-2)	600143	5
CES NL/L (1xNT-4)	600144	5

Inserts for flat cables



Material: TPE, halogen free
Color: Light Grey
Protection level: IP54

Type	Clamping range	Order No.	PU
E1	adapter inserts	600445	5
FT-1/0	Blind Inserts	600446	5
FT-1/A	Width: 19.0-23.0mm Thickness5.5-6.0mm	600447	5
FT-1/B	Width: 28.0-33.0mm Thickness5.5-6.0mm	600448	5
FT-1/C	Width: 24.0-30.0mm Thickness8.5-9.0mm	600449	5
FT-1/F	Width: 28.0-33.0mm Thickness9.0-9.5mm	600450	5
FT-2/0	Blind Inserts	600451	5
FT-2/A	Width: 32.5-38.0mm Thickness5.0-5.5mm	600452	5
FT-2/B	Width: 45.0-50.5mm Thickness6.0-6.5mm	600453	5
FT-2/C	Width: 47.0-52.0mm Thickness9.5-10.0mm	600454	5
FT-3/0	Blind Inserts	600455	5
FT-3/A	Width: 72.0-77.0mm Thickness5.0-5.5mm	600456	5
FT-4/A	Width: 85.0-99.0mm Thickness4.2-5.2mm	600457	5
FT-4/0	Blind Inserts	600458	5

CES NG bowled angle cable entry frame

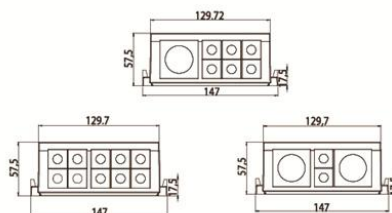

Material: Nylon 66, halogen free
Protection level: IP54/IP65 (with gasket and correct selection of the cable inserts)
Cut-out dimensions: 36x112mm

Type	Inserts Small/large	Order No.	PU
CES NG A10	Insert Small	600145	5
CES NG A7	Insert Medium/Insert Small	600146	5
CES NG A4	Insert Medium/Insert Small	600147	5



Material: Nylon 66, halogen free
Protection level: IP54/IP65 (with gasket and correct selection of the cable inserts)
Cut-out dimensions: 46x36mm

CES NG bowled angle cable entry frame

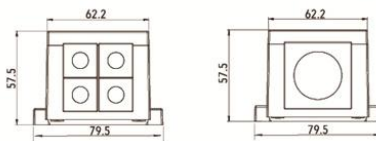

Type	Inserts Small/large	Order No.	PU
CES NG B4	Insert Small	600148	5
CES NG B1	Insert Medium	600149	5



Material: TPE, halogen free
Color: Light Grey
Protection level: IP54/IP65 (with gasket and correct selection of the cable inserts)

CES KPF conical cable seal



Type	Bottom External Diameter	Order No.	PU
CES KPF/M25/3-17	39mm	600163	5
CES KPF/M32/6-24	46mm	600164	5
CES KPF/M40/11-32	54mm	600165	5
CES KPF/M50/17-42	64mm	600166	5
CES KPF/M63/23-55	77mm	600167	5

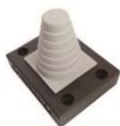

Material: TPE, Nylon 66, halogen free
Color: Light Grey
Protection level: IP54/IP65 (with gasket and correct selection of the cable inserts)

CES DPF conical cable seal

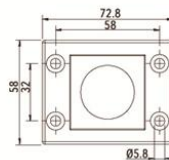

Type	Order No.	PU
CES DPF-C-SET	600168	5



Material: TPE, Nylon 66, halogen free
Color: Light Grey
Protection level: IP54/IP65 (with gasket and correct selection of the cable inserts)

CES DPF conical cable seal

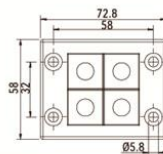

Type	Order No.	PU
CES DPF-4A-SET	600169	5

Accessories

UL94-V0 40 +140 °C



Type	product description	Order No.	PU
CES BP 6	Blind plate (Zinc-plated steel)	600181	5
CES BP 10		600182	5
CES BP 16		600183	5
CES BP 24		600184	5
RH 800449		600459	5

CES RVT Split cable glands

UL94-V0 -30 +100 °C

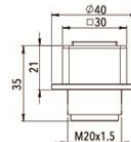
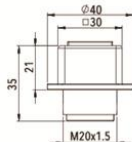

Material: Poly carbonate (PC), halogen free
Color: Light Grey, Black
Protection level: IP54/IP65 (with gasket and correct selection of the cable inserts)

Type	Inserts Small/large	Order No.	PU
CES RVT/M20	Insert Small	600158	5
CES RVT/M25	Insert Small	600159	5

CES RVT Split cable glands

UL94-V0 -30 +100 °C

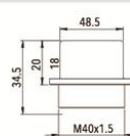
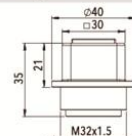

Material: Poly carbonate (PC), halogen free
Color: Light Grey, Black
Protection level: IP54/IP65 (with gasket and correct selection of the cable inserts)

Type	Inserts Small/large	Order No.	PU
CES RVT/M32	Insert Small	600160	5
CES RVT/M40/2	Insert Small	600161	5

CES RVT Split cable glands

UL94-V0 -30 +100 °C

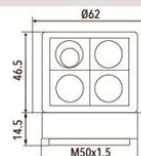

Material: Poly carbonate (PC), halogen free
Color: Light Grey, Black
Protection level: IP54/IP65 (with gasket and correct selection of the cable inserts)

Type	Inserts Small/large	Order No.	PU
CES RVT/M50/4	Insert Small	600162	5
CES RVT/M50/1	Insert Medium	600164	5



Material: Poly carbonate (PC)
Screw: stainless steel **Color:** Grey
Properties: Halogen-free, silicone-free
Protection level: IP54 (with gasket and correct selection of the cable inserts)
Cut-out dimension: 80mm in diameter

KVT 80 Split Cable Glands

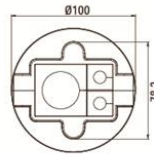

Type	Inserts Small/large	Order No.	PU
CES RVT 80/3	Insert Medium/Insert Small	600465	1



Material: Poly carbonate (PC)
Screw: stainless steel **Color:** Grey
Properties: Halogen-free, silicone-free
Protection level: IP54 (with gasket and correct selection of the cable inserts)
Cut-out dimension: 80mm in diameter

KVT 80 Split Cable Glands

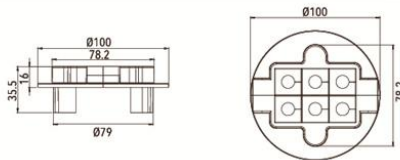

Type	Inserts Small/large	Order No.	PU
CES RVT 80/6	Insert Small	600466	1



Material: Poly carbonate (PC), halogen free
Color: Light Grey,Black
Protection level: IP54/IP65 (with gasket and correct selection of the cable inserts)

CES 90 Split Cable Glands

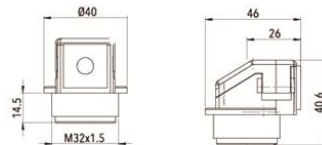

Type	Inserts Small/large	Order No.	PU
CES RVT 32-W90	Insert Small	600467	10



Material: Poly carbonate (PC), halogen free
Color: Light Grey,Black
Protection level: IP54/IP65 (with gasket and correct selection of the cable inserts)

CES 90 Split Cable Glands

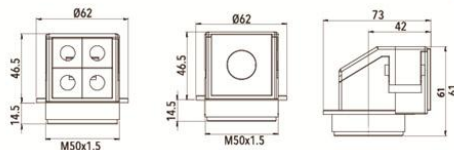

Type	Inserts Small/large	Order No.	PU
CES RVT 50/4-W90	Insert Small	600468	10
CES RVT 50/1-W90	Insert Medium	600469	10



Material: PA6
Protection level: IP54

Split locknut



Type	product description	Order No.	PU
CES GMT20	split locknut	600470	10
CES GMT25	split locknut	600471	10
CES GMT32	split locknut	600472	10
CES GMT40	split locknut	600473	10
CES GMT50	split locknut	600474	10



Material: Poly carbonate (PC)
Properties: Halogen-free, silicone-free
Protection level: IP54

CES Bulk head fittings



The 90° angled conduit fitting is for installation of parallel corrugated cable protection conduits, for example in machines, control panels or control cabinets. The liftable cover is tightly fixed by a hinge to the mounting box. The system is therefore very easy to handle. CES-FWS will be offered for corrugated conduits with sizes NW 13, 17, 23, 29, 37 and 50.

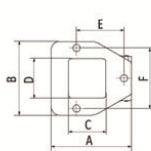

FWS-AD15.8 to 28.5

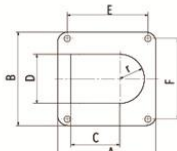

FWS-AD34.5 to 54.5

CES-FWS Assembly



1. Fix FWS with screws



2. Insert conduit with cables



3. Lock FWS with screws

Type	Hole Ø(mm)	Size (mm)	Cut-out (Cx D)(mm)	Drill. Templ. (E x F)(mm)	Order No.	PU
CES FWS-AD15.8	3x4.3	49x45	22x26.5	29.0x37.0	600475	10
CES FWS-AD21.2	3x4.3	49x45	22x26.5	29.0x37.0	600476	10
CES FWS-AD28.5	3x4.3	67x63	37x28	41.5x51.5	600477	10
CES FWS-AD34.5	4x6.6	85.5x76	41.9x40 r=20	64.5x64.5	600478	10
CES FWS-AD42.5	4x6.6	97x92	48.3x48.4 r=24.2	79.5x79.5	600479	5
CES FWS-AD54.5	4x6.6	111.5x100.5	53x60.5 r=30.25	87.5x87.5	600480	5

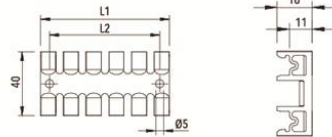

Material: Nylon 66, halogen free

CES ZD Strain relief plates

Type	No. of Teeth	Order No.	PU
CES ZD80 (L1: 79, L2: 68)	6	600131	10
CES ZD140 (L1: 139, L2: 128)	9	600132	10

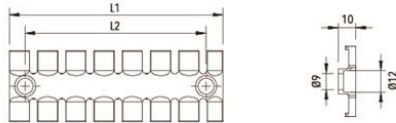

Material: Nylon 66, halogen free

CES ZL Strain relief plates

Type	No. of Teeth	Order No.	PU
CES ZL87 (L1: 86.5, L2: 68)	6	600481	10
CES ZL140 (L1: 139.5, L2: 121)	9	600482	10
CES ZL180 (L1: 180, L2: 157)	12	600483	10

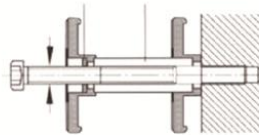
CES DH Distance bushings

Type	Length	Outside diameter	Order No.	PU
CES DH50	50mm	8mm	322511	10



Material: PA6, PE,PP
Color: Light Grey, Black, Dark Grey
Temperature: PA6: -40°C-115°C
 PE: -20°C-80°C PP: -40°C-110°C
Flame Class: UL94 V2/V0 Customized

SFN NRG Split corrugated conduit

Type	Internal/External Diameter(mm)	Order No.	PU
SFN NRG-10.0	6.5x10.0	600499	100
SFN NRG-13.0	10.0x13.0	600500	100
SFN NRG-15.8	12.0x15.8	600501	100
SFN NRG-18.5	14.3x18.5	600502	100
SFN NRG-20.0	16.0x20.0	600503	100
SFN NRG-21.2	17.0x21.2	600504	50
SFN NRG-25.0	21.0x25.0	600505	50
SFN NRG-28.5	23.0x28.5	600506	25
SFN NRG-30.0	25.0x30.0	600507	25
SFN NRG-34.5	29.0x34.5	600508	25
SFN NRG-42.5	36.0x42.5	600509	10
SFN NRG-54.5	48.0x54.5	600510	10
SFN NRG-67.2	56.3x67.2	600511	25
SFN NRG-80.0	66.5x80.0	600512	10
SFN NRG-106.0	91.0x106.0	600513	10



Material: PA6, PE,PP
Color: Light Grey, Black, Dark Grey
Temperature: PA6: -40°C-115°C
 PE: -20°C-80°C PP: -40°C-110°C
Flame Class: UL94 V2/V0 Customized

SFN NRG Standard corrugated conduit

Type	Internal/External Diameter(mm)	Order No.	PU
SFN NRG-10.0	6.5x10.0	600484	100
SFN NRG-13.0	10.0x13.0	600485	100
SFN NRG-15.8	12.0x15.8	600486	100
SFN NRG-18.5	14.3x18.5	600487	100
SFN NRG-20.0	16.0x20.0	600488	100
SFN NRG-21.2	17.0x21.2	600489	50
SFN NRG-25.0	21.0x25.0	600490	50
SFN NRG-28.5	23.0x28.5	600491	25
SFN NRG-30.0	25.0x30.0	600492	25
SFN NRG-34.5	29.0x34.5	600493	25
SFN NRG-42.5	36.0x42.5	600494	10
SFN NRG-54.5	48.0x54.5	600495	10
SFN NRG-67.2	56.3x67.2	600496	25
SFN NRG-80.0	66.5x80.0	600497	10
SFN NRG-106.0	91.0x106.0	600498	10



CES Cable ties with hook-and-loop fastener

Type	Size (mm)			Order No.	PU
	L	B1	B2		
CES LKB 200x7bk	200	13	7	600514	100
CES LKB 200x13bk	200	20	13	600515	100



CES Cable ties with hook-and-loop fastener



Type	Size (mm)			Order No.	PU
	L	B1	B2		
CES LKB 230x13bk	230	20	13	600516	100
CES LKB 300x17bk	300	25	17	600517	100



Material: Polypropylene + Velour PA
Flame Class: UL94 V0/V2

CES Cable ties with hook-and-loop fastener



Type	Size (mm)	Order No.	PU
	B2		
CES LB 7bk	7	600518	25
CES LB 10bk	10	600519	25
CES LB 15bk	15	600520	25
CES LB 20bk	20	600521	25
CES LB 25bk	25	600542	25



Material: Nylon 66, halogen free

CES Holder for hook-and-loop fastener, screwable

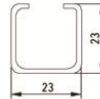
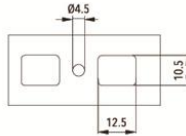

CES BH-R



CES BH-SB

23x23mm Installation Guide

Type	Fit for LKB/LB	Order No.	PU
CES BH-R	LKB 200x7/LKB 200x13/LB 10/LB 15	600522	100
CES BH-SB	LKB 200x7/LB 10	600523	100



CES BH-RBA



CES BH-RBB

CES Holder for hook-and-loop fastener, assemble and KD by turning 90°



Material: Nylon 66, halogen free
Color: Light Grey/Black
Cut-out dimension: RBA:Φ6mm, RBB:Φ6.5mm

Type	Fit for LKB/LB	Order No.	PU
CES BH-RBA	LKB 200x7/LB 10	600525	100
CES BH-RBB	LKB 200x7/LB 10	600526	100



Material: TPE halogen free
Color: Light Grey, Black
Protection level: IP54

CES small



Type	Clamping range mm	Order No.		PU
		Grey	Black	
CES 2	2-3	600302	601302	5
CES 3	3-4	600303	601303	5
CES 4	4-5	600304	601304	5
CES 5	5-6	600305	601305	5
CES 6	6-7	600306	601306	5
CES 7	7-8	600307	601307	5
CES 8	8-9	600308	601308	5
CES 9	9-10	600309	601309	5
CES 10	10-11	600310	601310	5
CES 11	11-12	600311	601311	5
CES 12	12-13	600312	601312	5
CES 13	13-14	600313	601313	5
CES 14	14-15	600314	601314	5
CES 15	15-16	600315	601315	5
CES 16(S)	16-17	600316(S)	601316(S)	5

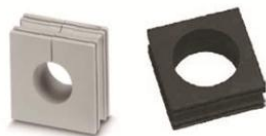

Material: TPE halogen free
Color: Light Grey, Black
Protection level: IP54

CES medium



Type	Clamping range mm	Order No.		PU
		Grey	Black	
CES 16(M)	16-17	600316(M)	601316(M)	5
CES 17	17-18	600317	601317	5
CES 18	18-19	600318	601318	5
CES 19	19-20	600319	601319	5
CES 20	20-21	600320	601320	5
CES 21	21-22	600321	601321	5
CES 22	22-23	600322	601322	5
CES 23	23-24	600323	601323	5
CES 24	24-25	600324	601324	5
CES 25	25-26	600325	601325	5
CES 26	26-27	600326	601326	5
CES 27	27-28	600327	601327	5
CES 28	28-29	600328	601328	5
CES 29	29-30	600329	601329	5
CES 30	30-31	600330	601330	5
CES 31	31-32	600331	601331	5
CES 32	32-33	600332	601332	5
CES 33	33-34	600333	601333	5



Material: TPE halogen free
Color: Light Grey, Black
Protection level: IP54

CES adapter insert(small)

Type	Clamping range mm	Order No.		PU
		Grey	Black	
CES 2/3	2xΦ3	600334	601334	5
CES 2/4	2xΦ4	600335	601335	5
CES 2/5	2xΦ5	600336	601336	5
CES 2/6	2xΦ6	600337	601337	5
CES 2/7	2xΦ7	600338	601338	5
CES 2/8	2xΦ8	600339	601339	5
CES 4/3	4xΦ3	600340	601340	5
CES 4/4	4xΦ4	600341	601341	5
CES 4/5	4xΦ5	600342	601342	5
CES 4/6	4xΦ6	600343	601343	5



Material: TPE halogen free
Color: Light Grey, Black
Protection level: IP54

Drilling, wide cable range

Type	Clamping range mm	Size	Order No.	PU
KTMB 6.5	2.5-6.5	CES small	600527	5
KTMB 7.5	4-7.5	CES small	600528	5
KTMB 10	6.5-10	CES small	600529	5
KTMB 13	9.5-13	CES small	600530	5
KTMB 16	13-16	CES small	600531	5



Material: TPE halogen free
Color: Light Grey, Black
Protection level: IP54

Drilling, wide cable range

Type	Clamping range mm	Size	Order No.	PU
CES DPF-A	3-12	CES small	600532	5



Material: TPE halogen free
Color: Light Grey, Black
Protection level: IP54

CES DT Cable entry inserts



Type	Clamping range mm	Size	Order No.	PU
KTMB 18	13-18	CES medium	600533	5
KTMB 23	18-23	CES medium	600534	5
KTMB 28	23-28	CES medium	600535	5
KTMB 33	28-33	CES medium	600536	5



Material: TPE halogen free
Color: Light Grey, Black
Protection level: IP54

Cable Entry Inserts, multi range



Type	Clamping range mm	Size	Order No.	PU
KTMB2x18	2x13-18	CES medium	600537	5



Material: TPE halogen free
Color: Light Grey, Black
Protection level: IP54

Cable Entry Inserts, multi range



Type	Clamping range mm	Size	Order No.	PU
CES DPF-B	4-18	CES medium	600538	5
CES DPF-C	11-23	CES medium	600539	5
CES DPF-D	14-26	CES medium	600540	5



Material: TPE halogen free
Color: Light Grey, Black
Protection level: IP54

DT cable entry inserts are designed for routing standard cables (wireless connector)

Cable Entry Inserts, multi range

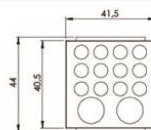

CES DT1

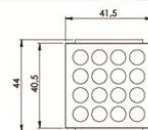

CES DT2

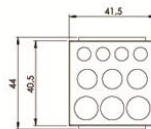

CES DT3

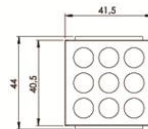

CES DT4

Type	Cable number	Order No.	PU
CES DT1	12x max.6.5mm/2x max.12.2mm	600460	10
CES DT2	16x max.7.1mm	600461	10
CES DT3	4x max.6.5/3x max.9.5/3x max.11.3mm	600462	10
CES DT4	9x max.9.5mm	600463	10

CES Conversion template

Material: TPE halogen free
Color: Light Grey, Black
Protection level: IP54

Type	Size	Order No.		PU
		Grey	Black	
CES BSA	conversion template from large to small	600344	601344	5
CES BSG	solid template small	600345	601345	5
CES BBG	solid template medium	600346	601346	5

CES plugs for sealing

Material: Nylon 66 halogen free
Color: white

Type	Diameter mm	length mm	Order No.	PU
CES PT2	2	25	600402	5
CES PT3	3	25	600403	5
CES PT4	4	25	600404	5
CES PT5	5	25	600405	5
CES PT6	6	25	600406	5
CES PT7	7	25	600407	5
CES PT8	8	20	600408	5
CES PT9	9	20	600409	5
CES PT10	10	20	600410	5
CES PT11	11	20	600411	5
CES PT12	12	20	600412	5
CES PT13	13	20	600413	5
CES PT14	14	20	600414	5
CES PT15	15	20	600415	5
CES PT16	16	20	600416	5
CES PT17	17	20	600417	5

Thread Type



ST1



ST3



ST8



Thread style - bottom

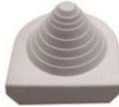

US1

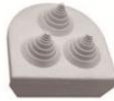

US3



US8

Model	ST1	ST3	ST8	US1	US3	US8
Maximum diameter	44	21	13	47	21	13
Number of cables	1	3	8	1	3	8

DIMENSION (mm)

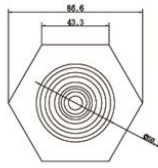

ST1

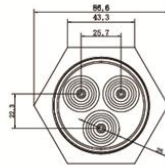

ST3

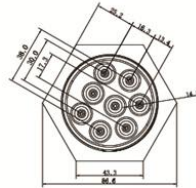

ST8

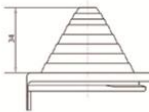
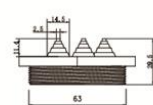
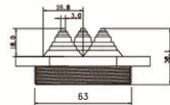
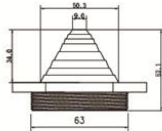

US1

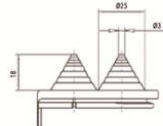

US3

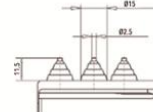

US8

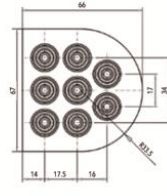
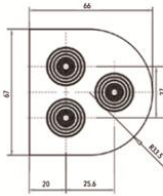
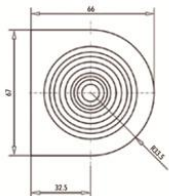

CHC16



CHC29



CHC36



CHC48



Cable hose clamp

Used for safe and reliable cable laying, such as from control cabinets or from installation boards to doors. The cable hose clamp can be fixed with commercial standard cable hole straps and supports multiple splicing uses. Therefore, the cable can be fixed when entering and exiting the cable hose.

Material:

Cable hose clamp: Polyamide

DIMENSION (mm)

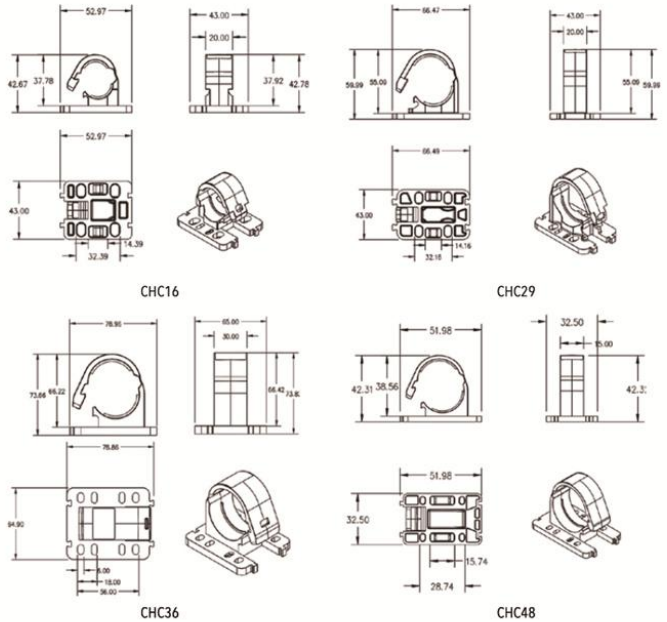

Model	Used for cable hoses Φ mm
CHC16	16
CHC29	29
CHC36	36
CHC48	48

PVW500.270 SYSTEM WINDOW

For covering display and operating instruments or openings to protect against dirt and liquid intrusion and unauthorized use

Sketch map

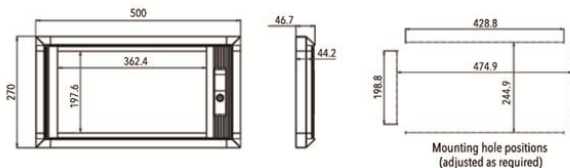

Cabinet width	Dimension		Model no
	Width	Length	
600	500	270	PVW500.270
		370	PVW500.370
		470	PVW500.470
		570	PVW500.570
		670	PVW500.670

Cabinet width	Dimension		Model no
	Width	Length	
800	700	270	PVW700.270
		370	PVW700.370
		470	PVW700.470
		570	PVW700.570
		670	PVW700.670

PTOP500 CABLE ENTRY GLAND

IP65

Protection category IP to IEC 60 529:IP 65 if installed correctly

Sketch map

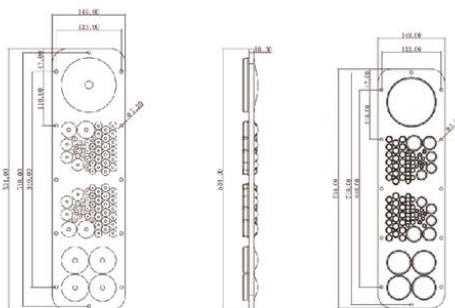

Effect pictures



Model	PTOP500		
Weight	0.96kg		
Applicable to	Cabinet type: AE		
IP code	IP 65		
Number of cable entries and min/max direct (mm)	18×5-9	6-15-24	4×26-54
	16×7-12	2×23-30	1×50-110
	36×10-15	2×26-35	

PTOP750 CABLE ENTRY GLAND
IP65

Protection category IP to IEC 60 529:1P 65 if installed correctly

Sketch map

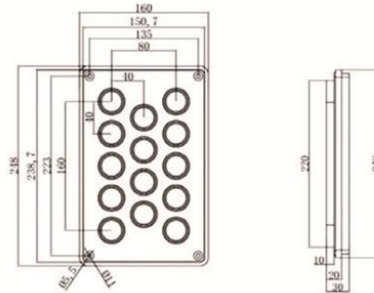

Effect pictures



Model	PTOP750
Material	Insulating material
Insulating material	RAL 7035
Version	14xM25/32
Packs of	1 pc(s)

PTOP760 CABLE ENTRY GLAND
IP65

Protection category IP to IEC 60 529:1P 65 if installed correctly

Sketch map

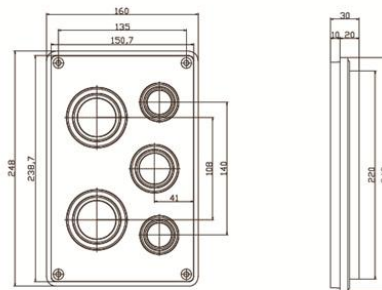

Effect pictures



Model	PTOP760
Material	Insulating material
Insulating material	RAL 7035
Version	2xM25/32/40, 1xM32/40/50, 2xM40/50/63
Packs of	1 pc(s)



Effect pictures



PTOP760 CABLE ENTRY GLAND

IP65

Protection category IP to IEC 60 529:1P 65 if installed correctly

Sketch map

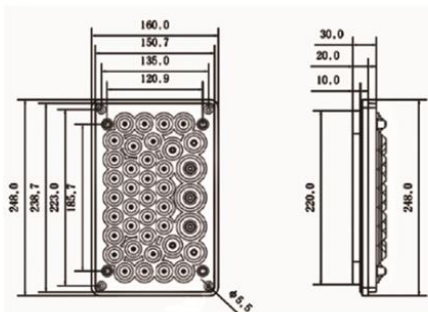

Model	PTOP770
Material	Insulating material
Insulating material	RAL 7035
Version	32×Ø7-16mm,4xØ 10-20mm,3xØ 14-26mm
Packs of	1 pc(s)

PTOP500 CABLE ENTRY GLAND

IP65

Protection category IP to IEC 60 529:1P 65 if installed correctly

Sketch map

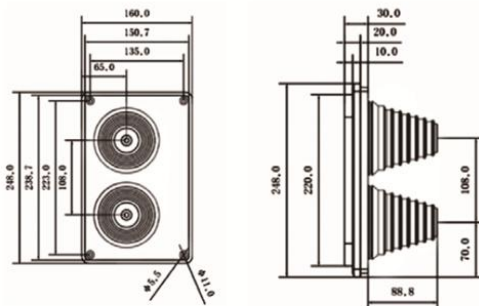

Effect pictures



Model	PTOP780
Material	Insulating material
Insulating material	RAL 7035
Version	With entry fittings up to Ø66mm
Packs of	1 pc(s)

PTOP785 CABLE ENTRY GLAND
IP65

Protection category IP to IEC 60 529:1P 65 if installed correctly

Sketch map

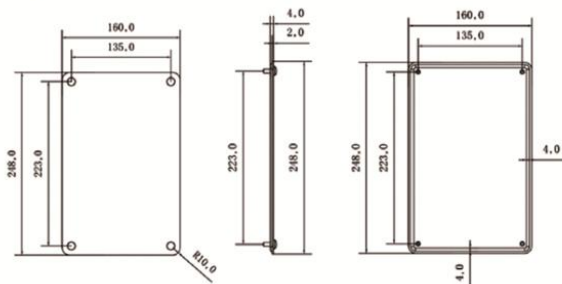

Effect pictures



Model	PTOP785
Material	Sheet steel, spray-finished
Insulating material	RAL 7035
Version	Solid
Packs of	1 pc(s)

EMC CLAMP SERIES

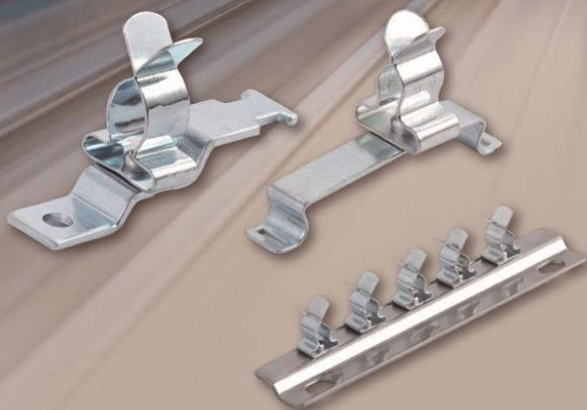

SFZ/SKL EMC
MATERIAL

Spring steel zinc-plated

SF/SFZ-foot Spring steel

The shield clamps SFZ/SKL range are used for shielding single cables in combination with strain relief. Simple to use and effective shielding of cables.

Cables are secured with a cable tie. Strain relief in accordance with VDE standards is achieved.

For assembly on 35 mm DIN rails.

PERFORMANCE

- Simple and tool-free assembly cost effective solution Cost effective solution.
- Strain relief of the cable with shielding in a single device.
- Optimum contact permanent spring pressure and continuous spring pressure for cable shield layer.
- Cable shielding, no need to adjust the spring load.

Model No.	Protective diameter
SFZ/SKL 3-5	3.0-5.0mm
SFZ/SKL 6-8	6.0-8.0mm
SFZ/SKL 9-11	9.0-11.0mm

SF/SKL EMC
MATERIAL

Spring steel zinc-plated

SF foot Spring steel

SKL range of protection clip is used to shield single cable.

Easy to use and effective shielding cable.

For assembly on 35 mm DIN rails.

PERFORMANCE

- Optimal contact of the cable shield simple and tool-free assembly.
- Permanent and continuous spring pressure on the cable shield - adjustment of the pressure is not necessary.
- Space saving by an optimized arrangement.
- Cost effective solution.

Model No.	Protective diameter
SF/SKL 3-5	3.0-5.0mm
SF/SKL 6-8	6.0-8.0mm
SF/SKL 9-11	9.0-11.0mm

**LFZ/SKL EMC****MATERIAL**

Spring steel zinc-plated

SKL shield clamps can be used for shielding single cables. The shield clamps enable an easy to use and reliable shielding of cables. Cables are secured with a cable tie. Strain relief in accordance with VDE standards is achieved.

Shield clamps are easily attached to moun-ting plates via screw.

PERFORMANCE

- Comprehensive strain elimination.
- Optimum contact for cable shielding.
- Simple and tool-free assembly.
- Permanent and continous pressure on the cable shield - no adjustment of the spring load required.
- Higher cost performance.

Model No.	Protective diameter	Applicable hole
LFZ/SKL 3-5	3.0-5.0mm	4.1mm
LFZ/SKL 6-8	6.0-8.0mm	4.1mm
LFZ/SKL 9-11	9.0-11.0mm	4.1mm

**LF/SKL EMC****MATERIAL**

SKL-clamp: spring steel, zinc-plated.

LF-foot: Steel, zinc-plated zinc-plated.

Fixing hole 4.2 mm for screw M4.

SKL shield clamps can be used for shielding single cables .

The shield clamps enable an easy to use and a reliable shielding of cables.

**PERFORMANCE**

- Optimum contact for cable shielding.
- Simple and tool-free assembly.
- Permanent and continous spring load on the cable shield - no adjustment of the spring load required.
- Vibration-proof, maintenance free.
- High packing density because of an optimized arrangement.

Model No.	Protective diameter	Applicable hole
LF/SKL 1.5-3	1.5 - 3.0 mm	4.2 mm
LF/SKL 3-6	3.0 - 6.0 mm	4.2 mm
LF/SKL 6-8	6.0 - 8.0 mm	4.2 mm
LF/SKL 8-11	8.0 - 11 mm	4.2 mm
LF/SKL 12-16	12 - 16 mm	4.2 mm
LF/SKL 17-22	17 - 22 mm	4.2 mm
LF/SKL 23-29	23 - 29 mm	4.2 mm

SPS/SKL EMC
MATERIAL

SKL-clamp spring steel, zinc-plated

SPS- foot: spring steel.

PERFORMANCE

- Easy to install to DIN rail 35 mm.
- Simple and no alcohol assembly high density packaging.
- Anti-vibration, maintenance-free cable shielding layer of the best contact.

Model No.	Protective diameter
SPS/SKL 1.5-3	1.5-3.0mm
SPS/SKL 3-6	3.0-6.0mm
SPS/SKL 6-8	6.0-8.0mm

PF/SKL EMC
MATERIAL

SKL-clamp spring steel, zinc-plated.

PFS-foot: Spring steel.

Bus: copper, tin plated, current load 140A.

Specification: installed on 10x3mm bus.

PERFORMANCE

- Easy installation to bus 10x3mm simple and tool-free assembly.
- High packing density, anti-vibration, maintenance-free cable protective layer of the best contact point.

Model No.	Protective diameter
PF/SKL 1.5-3	1.5 - 3.0 mm
PF/SKL 3-6	3.0 - 6.0 mm
PF/SKL 6-8	6.0 - 8.0 mm
PF/SKL 8-11	8.0 - 11 mm
PF/SKL 12-16	12 - 16 mm
PF/SKL 17-22	17 - 22 mm
PF/SKL 23-29	23 - 29 mm

**PFZ/SKL EMC****MATERIAL**

SKL-clamp spring steel, zinc-plated.

PFS-foot: Spring steel.

Bus: copper, tin plated, current load 140A.

Specification: to fix the cable by tightening 10x3mm busbar mounting cable strap.

PERFORMANCE

- Comprehensive strain elimination.
- Easy installation to busbar 10x3mm simple and tool-free assembly, shockproof, maintenance-free cable shielding for optimal contact.

Model No.	Protective diameter
PFZ/SKL 1.5-3	1.5-3.0mm
PFZ/SKL 3-6	3.0-6.0mm
PFZ/SKL 6-8	6.0-8.0mm
PFZ/SKL 8-11	8.0-11.0mm

**PFSZ/SKL EMC****MATERIAL**

SKL-clamp spring steel, zinc-plated.

PF-foot: spring steel.

Bus: copper, tin plated, current load 140A.

Specification: installed on 10x3mm bus.

PERFORMANCE

- Easy to install to bus 10x3mm simple and toolless assembly with high packing density.
- Shock-proof, maintenance-free cable shielding layer for optimal contact.

Model No.	Protective diameter
PFSZ/SKL 1.5-3	1.5-3.0mm
PFSZ/SKL 3-6	3.0-6.0mm
PFSZ/SKL 6-8	6.0-8.0mm
PFSZ/SKL 8-11	8.0-11.0mm

LFZ/SKL EMC
MATERIAL

SKL-clamp Spring steel, zinc-plated.

PF-foot: spring steel.

Specifications: Screw mounting, 4.2mm hole fixing.

PERFORMANCE

- Simple and tool-free assembly with high packing density.
- Shockproof, maintenance-free.
- Optimum contact for cable shielding.

Model No.	Protective diameter
LFZ/SKL 1.5-3	1.5 - 3.0 mm
LFZ/SKL 3-6	3.0 - 6.0 mm
LFZ/SKL 6-8	6.0 - 8.0 mm
LFZ/SKL 8-11	8.0 - 11 mm
LFZ/SKL 12-16	12 - 16 mm
LFZ/SKL 17-22	17 - 22 mm
LFZ/SKL 23-29	23 - 29 mm

TW/RL EMC
MATERIAL

SKL-clamp Spring steel, zinc-plated

PF-foot: spring steel.

Busbar: copper, tinned, current load to 140A.

Specifications: install by capturing 10x3mm busbars.

PERFORMANCE

- Easy to install to busbar 10x3mm simplification and tool assembly.
- High packing density.
- The best contact for shockproof, maintenance-free cable shielding.

Model No.	Protective diameter
TW/RL 1.5-3	1.5-3.0mm
TW/RL 3-6	3.0-6.0mm
TW/RL 6-8	6.0-8.0mm

**KLF EMC****MATERIAL**

clamp Spring steel, zinc-plated.

Bottom: stainless steel.

PERFORMANCE

- Optimized design for higher mounting density.
- Customization: can be customized according to customer's required size.

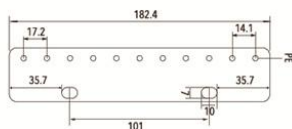
DIMENSION (mm)

Model No.	Number of earthing terminals
KLF 10/182.4(3-6)	10
KLF 10/182.4(6-8)	10
KLF 10/182.4(8-11)	10

**LF/SKL EMC****MATERIAL**

Clamp Spring steel, zinc-plated. Bottom: spring steel.

Fixed hole: 4.2mm

PERFORMANCE

- combined stress release.
- The optimal contact area of the cable shield, no need for easy assembly of the tool, permanent and continuous elastic pressure on the cable shield, no need to adjust the pressure, shockproof, maintenance-free for 10x3mm busbar.
- Customization: can be customized according to customer's required size.

Model No.	Protective diameter
LF/SKL 1.5-3	1.5 - 3.0 mm
LF/SKL 3-6	3.0 - 6.0 mm
LF/SKL 6-8	6.0 - 8.0 mm
LF/SKL 8-11	8.0 - 11 mm
LF/SKL 12-16	12 - 16 mm
LF/SKL 17-22	17 - 22 mm
LF/SKL 23-29	23 - 29 mm

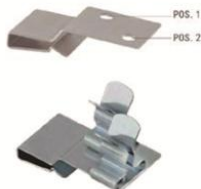
TW2/RL EMC

MATERIAL

Clamp Spring steel, zinc-plated. Bottom: spring steel.

PERFORMANCE

- combined stress release.
- The optimal contact area of the cable shield, no need for easy assembly of the tool, permanent and continuous elastic pressure on the cable shield, no need to adjust the pressure, shockproof, maintenance-free for 10x3mm busbar. Customization: can be customized according to customer's required size.

Model No.	Wire diameter POS.1	Wire diameter POS.2
TW2/RL 1.5-3	1.5 - 3.0 mm	1.5 - 3.0 mm
TW2/RL 3-6	3.0 - 6.0 mm	3.0 - 6.0 mm
TW2/RL 6-8	6.0 - 8.0 mm	6.0 - 8.0 mm
TSC2/RL 0306	1.5 - 3.0 mm	3.0 - 6.0 mm
TSC2/SKL 0308	1.5 - 3.0 mm	6.0 - 8.0 mm
TSC2/SKL 0603	3.0 - 6.0 mm	1.5 - 3.0 mm
TSC2/SKL 0608	3.0 - 6.0 mm	6.0 - 8.0 mm
TSC2/SKL 0803	6.0 - 8.0 mm	1.5 - 3.0 mm
TSC2/SKL 0806	6.0 - 8.0 mm	3.0 - 6.0 mm

KLF EMC

MATERIAL

clamp Spring steel, zinc-plated. Bottom: stainless steel.

PERFORMANCE

- Advantages: optimized design for higher mounting density.
- Customization: can be customized according to customer's required size.

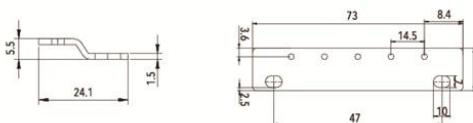
DIMENSION (mm)

Model No.	Number of earthing terminals
KLF 5/73(3-6)	5
KLF 5/73(6-8)	5
KLF 5/73(8-11)	5



KLF EMC

MATERIAL

clamp Spring steel, zinc-plated. Bottom: stainless steel.

ADVANTAGES

- Optimized design for higher mounting density.
- Customization: can be customized according to customer's required size.

DIMENSION (mm)

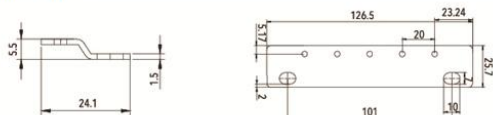

Model No.	Number of earthing terminals
KLF 5/126.5(3-6)	5
KLF 5/126.5(6-8)	5
KLF 5/126.5(8-11)	5



KLF EMC

MATERIAL

clamp Spring steel, zinc-plated. Bottom: stainless steel.

PERFORMANCE

- Optimized design for higher mounting density.
- Customization: can be customized according to customer's required size.

DIMENSION (mm)

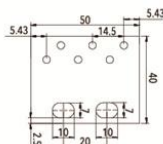

Model No.	Number of earthing terminals
KLF 5/50(3-6)	6
KLF 5/50(6-8)	6
KLF 5/50(8-11)	6

LK 2X2-6

Length	24 mm
Width	15 mm
Height	18 mm
Net weight	9.9 g
Minimum cable diameter	2 mm
Maximum cable diameter	6 mm

LK 3-8

Length	26 mm
Width	13 mm
Height	18 mm
Net weight	9 g
Minimum cable diameter	3 mm
Maximum cable diameter	8 mm

LK 3-8 FM4

Length	50 mm
Width	14.5 mm
Height	26 mm
Net weight	17.5 g
Minimum cable diameter	3 mm
Maximum cable diameter	8 mm

LK 4-13.5

Length	24 mm
Width	15 mm
Height	18 mm
Net weight	15.5 g
Minimum cable diameter	4 mm
Maximum cable diameter	13.5 mm

LK 4-13.5 FM4

Length	50.5 mm
Width	20.5 mm
Height	31.5 mm
Net weight	21.941 g
Minimum cable diameter	4 mm
Maximum cable diameter	13.5 mm

**LK 10-20**

Length	40 mm
Width	25 mm
Height	26 mm
Net weight	29.848 g
Minimum cable diameter	10 mm
Maximum cable diameter	20 mm

**LK 10-20 FM4**

Length	50.5 mm
Width	25 mm
Height	40 mm
Minimum cable diameter	10 mm
Maximum cable diameter	20 mm

**LK 15-32**

Length	64 mm
Width	36 mm
Height	32 mm
Net weight	80.8 g
Minimum cable diameter	15 mm
Maximum cable diameter	32 mm

**LK 15-32 FM4**

Length	50.5 mm
Width	34.5 mm
Height	64 mm
Minimum cable diameter	15 mm
Maximum cable diameter	32 mm

CABLE GLANDS SERIES

Thread: PG, Metric, G, and NPT thread

Materials: UL approved Nylon PA66 (Flammability) UL 94V-2) for A. C. E parts, (Accept to make flammability UL 94V-0); EPDM rubber for B. D parts. (Also accept to make super rubber: resist high temperature rubber, resist strong acid/al-kali, etc).

Protection degree: IP68

Working temperature: -40°C ~ +100°C

Features: The claws and seals of excellent design, sealing nut have a "click" sound and re-open, can hold cable firmly and have a wider cable range. Resistant to salt water, weak acid, alcohol, oil, grease and common solvency.

Colours: Black(RAL9005), gray(RAL7035), other color available upon request.



IP68

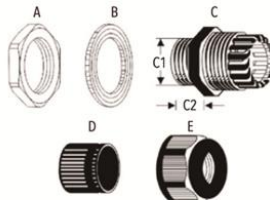

Nylon Cable Glands (Standard type)

PG Type	PG Thicken Type	Applicable to cable	Thread diameter C1	Thread length C2	Wrench diameter
PG7	PG7-T	3~6.5	12.5	8	16
PG9	PG9-T	4~8	15.2	8	19
PG11	PG11-T	5~10	18.6	8	22
PG13.5	PG13.5-T	6~12	20.4	10	24
PG16	PG16-T	10~14	22.5	10	27
PG19	PG19-T	12~16	24	10	27
PG21	PG21-T	13~18	28.3	10	33
PG25	PG25-T	16~21	30	11	35
PG29	PG29-T	18~25	37	12	42
PG36	PG36-T	22~32	47	14	52
PG42	PG42-T	32~38	54	14	60
PG48	PG48-T	37~44	59.3	15	64
PG63	PG63-T	42~50	71	28	77

Nylon Cable Glands (Standard type)

PG Type	PG Thicken Type	Applicable to cable	Thread diameter C1	Thread length C2	Wrench diameter
M12x1.5	M12x1.5-T	3~6.5	12	8	16
M16x1.5	M16x1.5-T	4~8	16	8	19
M18x1.5	M18x1.5-T	5~10	18	8	22
M20x1.5	M20x1.5-T	6~12	20	10	24
M22x1.5	M22x1.5-T	10~14	22	10	27
M24x1.5	M24x1.5-T	12~16	24	10	27
M25x1.5	M25x1.5-T	13~18	25	10	33
M27x1.5	M27x1.5-T	13~18	27	10	33
M30x1.5	M30x1.5-T	16~21	30	11	35
M32x1.5	M32x1.5-T	16~21	32	11	35
M36x1.5	M36x1.5-T	18~25	36	12	42
M40x1.5	M40x1.5-T	22~32	40	14	52
M50x1.5	M50x1.5-T	32~38	50	14	60
M63x1.5	M63x1.5-T	37~44	63	15	64
M71x1.5	M71x1.5-T	42~50	71	28	77



Product Overview
Material: Nylon PA66

Protection degree: IP68

Working temperature: -40°C~+100°C

Application: Dust-proof for spare holes

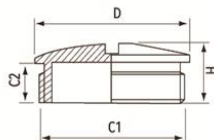
Colours: Black and gray

IP68

Nylon Screw Plugs PG Type

PG Type	Thread diameter C1	Thread length C2	Main Dimensions H	Cover Dimensions D
PG7	12.5	8.5	12.5	15
PG9	15.2	8.5	13	19
PG11	18.6	9	13	22
PG13.5	20.4	9	13	25
PG16	22.5	10.5	15	27
PG21	28.3	10.5	15.5	33
PG29	37	11.5	16	44
PG36	47	13.5	18	55
PG42	54	13.5	18.5	62
PG48	59.3	14.5	19.5	68

Nylon Screw Plugs M Type

M Type	Thread diameter C1	Thread length C2	Main Dimensions H	Cover Dimensions D
M12x1.5	12	8.5	12.5	15
M16x1.5	16	8.5	13	19
M18x1.5	18	9	13	22
M20x1.5	20	9	13	25
M22x1.5	22	10.5	15	27
M25x1.5	25	10.5	15.5	30
M27x1.5	27	10.5	15.5	33
M32x1.5	32	10.5	16	38
M40x1.5	40	11.5	16	46
M50x1.5	50	13.5	18	56
M63x1.5	63	14.5	19	68

IP68

**Product Overview****Thread:** PG, Metric, G, and NPT thread**Materials:** UL approved Nylon PA66 (Flammability) UL 94V-2) for A. C. E parts, (Accept to make flammability UL 94V-0); EPDM rubber for B. D parts, (Also accept to make super rubber: resist high temperature rubber, resist strong acid/alkali, etc).**Protection degree:** IP68**Working temperature:** -40°C to 100°C**Features:** The claws and seals of excellent design, sealing nut have a "click" sound and re-open, can hold cable firmly and have a wider cable range. Resistant to salt water, weak acid, alcohol, oil, grease and common solvency.**Colours:** Black(RAL9005), gray(RAL7035), other color available upon request.**Spiral Cable Glands PG type**

PG Type	Cable Range	Thread diameter C1	Thread length C2	Wrench diameter
PG7	3~6.5	12.5	8	16
PG7	2~5	12.5	8	16
PG9	4~8	15.2	8	19
PG9	2~6	15.2	8	19
PG11	5~10	18.6	8	22
PG11	3~7	18.6	8	22
PG13.5	6~12	20.4	9	24
PG13.5	5~9	20.4	9	24
PG16	10~14	22.5	10	27
PG16	7~12	22.5	10	27
PG21	13~18	28.3	10	33
PG21	9~16	28.3	10	33

Spiral Cable Glands M type

M Type	Cable Range	Thread diameter C1	Thread length C2	Wrench diameter
M12x1.5	3~6.5	12	8	16
M12x1.5	2~5	12	8	16
M16x1.5	4~8	16	8	19
M16x1.5	2~6	16	8	19
M18x1.5	5~10	18	8	22
M18x1.5	3~7	18	8	22
M20x1.5	6~12	20	9	24
M20x1.5	5~9	20	9	24
M22x1.5	10~14	22	10	27
M22x1.5	7~12	22	10	27
M25x1.5	13~18	25	10	33
M25x1.5	9~16	25	10	33
M27x1.5	13~18	27	10	33
M27x1.5	9~16	27	10	33

IP68

Product Overview

Material: Parts A, C, F are made of brass plated with nickel, part D is made of UL approved nylon PA66, parts B and E are made of nitrile butadiene rubber (NBR).

Thread spec.: Metric, PG, G, NPT.

Working temperature: -40°C ~ +100°C, instantaneous heat resistance up to 120°C.

Characteristics: Special design of clamping die and rubber part, large range in clamping the cable, ultrastrong stretching resistance, waterproof, dustproof, and high ability to resist salt, acid, alkali, alcohol, grease and general solvent.

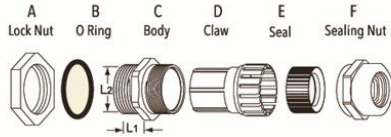

Model	Thread Size	Cable Range (mm)	Thread O. D. L2 (mm)	Thread Length L1 (mm)	Spanner Size (mm)
PG7-M	PG7	3~6.5	12.5	5	14
PG7-M	PG7	2~5	12.5	5	14
PG9-M	PG9	5~9	15.2	6	17
PG9-M	PG9	2~6	15.2	6	17
PG11-M	PG11	6.5~11	18.6	6	20
PG11-M	PG11	3~7	18.6	6	20
PG13.5-M	PG13.5	7~13	20.4	6.5	22
PG13.5-M	PG13.5	5~9	20.4	6.5	22
PG16-M	PG16	9~14	22.5	6.5	24
PG16-M	PG16	6~12	22.5	6.5	24
PG21-M	PG21	11~18	28.3	7	30
PG21-M	PG21	9~16	28.3	7	30
PG29-M	PG29	18~26	37	8	40
PG29-M	PG29	13~20	37	8	40
PG36-M	PG36	24~33	47	9	50
PG36-M	PG36	20~26	47	9	50
PG42-M	PG42	30~39	54	10	58
PG42-M	PG42	25~31	54	10	58
PG48-M	PG48	34~45	59.3	10	64
PG48-M	PG48	29~35	59.3	10	64

Metallic cable gland PG-LM type



Model	Thread Size	Cable Range (mm)	Thread O. D. L2 (mm)	Thread Length L1 (mm)	Spanner Size (mm)
PG7-LM	PG7	3~6.5	12.5	6	14
PG7-LM	PG7	2~5	12.5	6	14
PG9-LM	PG9	4~8	15.2	7	17
PG9-LM	PG9	6~10	15.2	7	17
PG11-LM	PG11	6.5~11	18.6	7	20
PG11-LM	PG11	3~7	18.6	7	20
PG13.5-LM	PG13.5	6~12	20.4	8	22
PG13.5-LM	PG13.5	5~9	20.4	8	22
PG16-LM	PG16	10~14	22.5	8	24
PG16-LM	PG16	6~12	22.5	8	24
PG21-LM	PG21	11~18	28.3	8	30
PG21-LM	PG21	9~16	28.3	8	30
PG29-LM	PG29	18~26	37	9	40
PG29-LM	PG29	13~20	37	9	40
PG36-LM	PG36	25~32	47	10	50
PG36-LM	PG36	20~26	47	10	50
PG42-LM	PG42	32~38	54	10	58
PG42-LM	PG42	25~31	54	10	58
PG48-LM	PG48	34~45	59.3	12	64
PG48-LM	PG48	37~44	59.3	12	64

Metallic cable gland M-M type

Model	Thread Size	Cable Range (mm)	Thread O. D. L2 (mm)	Thread Length L1 (mm)	Spanner Size (mm)
M12-M	M12x1.5	3~6.5	12	5	14
M14-M	M14x1.5	3~6.5	14	6	17
M16-M	M16x1.5	4~8	16	6	17
M18-M	M18x1.5	6~10	18	6	20
M20-M	M20x1.5	8~12	20	6	22
M22-M	M22x1.5	10~14	22	6	24
M24-M	M24x1.5	9~14	24	7	30
M25-M	M25x1.5	9~14	25	7	30
M27-M	M27x1.5(2)	11~18	27	7	30
M30-M	M30x1.5(2)	11~18	30	7	37
M32-M	M32x1.5(2)	15~22	32	8	37
M33-M	M33x1.5(2)	15~22	33	8	37
M36-M	M36x1.5(2)	18~25	36	8	42
M40-M	M40x1.5(2)	18~25	40	8	46
M42-M	M42x1.5(2)	18~25	42	9	46
M48-M	M48x1.5(2)	25~32	48	9	52
M50-M	M50x1.5(2)	33~38	50	9	55
M54-M	M54x1.5(2)	30~38	54	12	58
M60-M	M60x1.5(2)	37~44	60	12	68
M63-M	M63x1.5(2)	37~44	63	12	68
M64-M	M64x1.5(2)	37~44	64	12	68



Product Overview
IP68

Material: Parts A, C, F are made of brass plated with nickel, part D is made of UL approved nylon PA66, parts B and E are made of nitrile butadiene rubber (NBR).

Thread spec.: Metric, PG, G, NPT.

Working temperature: -40°C~+100°C, instantaneous heat resistance up to 120°C.

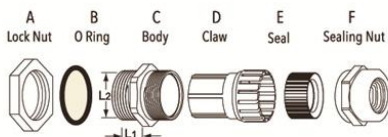
Characteristics: Special design of clamping die and rubber part, large range in clamping the cable, ultrastrong stretching resistance, waterproof, dustproof, and high ability to resist salt, acid, alkali, alcohol, grease and general solvent.



Model	Thread Size	Cable Range (mm)	Thread O. D. L2 (mm)	Thread Length L1 (mm)	Spanner Size (mm)
M12-LM	M12x1.5	3~6.5	12	6	14
M14-LM	M14x1.5	3~6.5	14	6	17
M16-LM	M16x1.5	4~8	16	7	17
M18-LM	M18x1.5	6~10	18	7	20
M20-LM	M20x1.5	8~12	20	8	22
M22-LM	M22x1.5	10~14	22	8	24
M24-LM	M24x1.5	10~14	24	8	27
M25-LM	M25x1.5	10~14	25	8	27
M27-LM	M27x1.5(2)	13~18	27	8	30
M30-LM	M30x1.5(2)	13~18	30	8	34
M32-LM	M32x1.5(2)	15~22	32	9	34
M33-LM	M33x1.5(2)	15~22	33	9	36
M36-LM	M36x1.5(2)	18~25	36	9	40
M40-LM	M40x1.5(2)	22~28	40	10	43
M42-LM	M42x1.5(2)	22~28	42	10	45
M48-LM	M48x1.5(2)	25~32	48	10	52
M50-LM	M50x1.5(2)	25~32	50	10	55
M54-LM	M54x1.5(2)	30~38	54	12	58
M60-LM	M60x1.5(2)	37~44	60	12	68
M63-LM	M63x1.5(2)	37~44	63	12	68
M64-LM	M64x1.5(2)	37~44	64	12	68

Metallic cable gland NPT-M type



Model	Thread Size	Cable Range (mm)	Thread O. D. L2 (mm)	Thread Length L1 (mm)	Spanner Size (mm)
NPT3/8" -M	NPT3/8"	4-8	17.1	13	18
NPT3/8" -M	NPT3/8"	2-6	17.1	13	18
NPT1/2" -M	NPT1/2"	6-12	21.3	13	22
NPT1/2" -M	NPT1/2"	5-9	21.3	13	22
NPT3/4" -M	NPT3/4"	13-18	26.6	15	30
NPT3/4" -M	NPT3/4"	9-16	26.6	15	30
NPT1" -M	NPT1"	15-22	33.5	16	36
NPT1" -M	NPT1"	13-20	33.5	16	36
NPT1" -M	NPT1 1/4"	22-28	42	18	45
NPT1" -M	NPT1 1/4"	18-25	42	18	45
NPT1" -M	NPT1 1/2"	25-32	48	18	50
NPT1" -M	NPT1 1/2"	20-26	48	18	50

Metallic cable gland PG-MA type



Model	Thread Size	Cable Range (mm)	Thread O. D. L2 (mm)	Thread Length L1 (mm)	Spanner Size (mm)
PG7-MA	PG7	3-6.5	12.5	6	14
PG7-MA	PG7	2-5	12.5	6	14
PG9-MA	PG9	4-8	15.2	7	17
PG9-MA	PG9	2-6	15.2	7	17
PG11-MA	PG11	5-10	18.6	7	20
PG11-MA	PG11	3-7	18.6	7	20
PG13.5-MA	PG13.5	6-12	20.4	7.5	22
PG13.5-MA	PG13.5	5-9	20.4	7.5	22
PG16-MA	PG16	10-14	22.5	7.5	24
PG16-MA	PG16	6-12	22.5	7.5	24
PG21-MA	PG21	13-18	28.3	8	30
PG21-MA	PG21	9-16	28.3	8	30
PG29-MA	PG29	18-25	37	9	40
PG29-MA	PG29	13-20	37	9	40
PG36-MA	PG36	25-32	47	9	50
PG36-MA	PG36	20-26	47	9	50
PG42-MA	PG42	32-38	54	10	58
PG42-MA	PG42	25-31	54	10	58
PG48-MA	PG48	37-44	59.3	11	64
PG48-MA	PG48	29-35	59.3	11	64

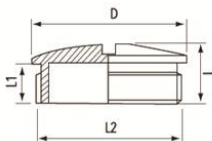

Material: Made of brass plated with nickel.
O-sealing element: Made of nitrile butadiene rubber (NBR).
Working temperature: -40°C ~ +100°C.

Metallic threaded plug PG-TM type

Model	Thread Size	Thread O. D. L2 (mm)	Thread Length L1 (mm)	Main body Dimensions L (mm)	Cover Dimensions D (mm)
PG7-TM	PG7	12.5	5	8	14
PG9-TM	PG9	15.2	6	9	17
PG11-TM	PG11	18.6	6	9	20
PG13.5-TM	PG13.5	20.4	6.5	9.5	22
PG16-TM	PG16	22.5	6.5	9.5	24
PG21-TM	PG21	28.3	7	11	30
PG29-TM	PG29	37	8	12	40
PG36-TM	PG36	47	9	15	50
PG42-TM	PG42	54	10	16	60
PG48-TM	PG48	59.3	10	16	65

Metallic threaded plug M-TM type

Model	Thread Size	Thread O. D. L2 (mm)	Thread Length L1 (mm)	Main body Dimensions L (mm)	Cover Dimensions D (mm)
M12-TM	M12x1.5	12	5	8	114
M16-TM	M16x1.5	16	6	9	18
M18-TM	M18x1.5	18	6	9	20
M20-TM	M20x1.5	20	6.5	9.5	22
M22-TM	M22x1.5	22	6.5	9.5	25
M25-TM	M25x1.5	25	7	11	28
M32-TM	M32x1.5	32	8	12	35
M40-TM	M40x1.5	40	9	15	44
M50-TM	M50x1.5	50	10	16	54
M63-TM	M63x1.5	63	10	16	67

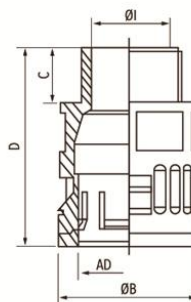

Product Overview

Material: plastic(Pa6).

Temperature: -40°C~+115°C

Colour: Black and grey.

Properties: Rational tubing assembly due to one-piece screw connector with push-in lock. Simple dismantling by displacing the snap-in sleeve. Smallest outer dimensions to be used under confined conditions. Resistant against oil and acids and solvents. Free of silicon, cadmium, halogen. Black connectors are UV-resistant.

Application: For protectively insulated electrical installations.

Thread	Applicable tubing Outer Ø ADmm	Length of thread Cmm	Smallest inner Ø lmm	Largest outer Ø Bmm	Total length Dmm
M10x1.5	10.0	12.0	6.0	17.0	35.0
M12x1.5	10.0	12.0	7.0	17.0	35.0
M16x1.5	13.0	12.0	7.0	20.0	37.0
M16x1.5	13.0	12.0	10.0	20.0	37.0
M16x1.5	15.8	12.0	11.5	23.0	39.5
M18x1.5	15.8	12.0	12.0	23.0	39.5
M20x1.5	18.5	13.0	14.5	26.0	42.0
M20x1.5	21.2	13.0	15.5	29.5	45.0
M22x1.5	21.2	13.0	17.0	29.5	45.0
M24x1.5	21.2	13.0	17.0	29.5	45.0
M25x1.5	21.2	13.0	17.0	29.5	45.0
M25x1.5	25.5	13.0	20.5	34.0	46.5
M25x1.5	28.5	13.0	20.5	37.0	47.0
M27x2.0	28.5	13.0	22.5	37.0	47.0
M30x1.5	28.5	13.0	23.5	37.0	47.0
M32x1.5	28.5	13.0	23.5	37.0	47.0

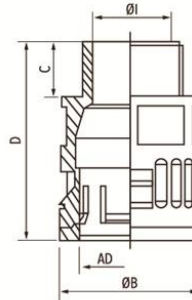

Thread	Applicable tubing Outer Ø ADmm	Length of thread Cmm	Smallest inner Ø Imm	Largest outer Ø Bmm	Total length Dmm
M32x1.5	34.5	15.0	26.0	44.0	51.0
M33x2.0	34.5	15.0	26.0	44.0	51.0
M36x2.0	34.5	15.0	30.0	44.0	51.0
M40x1.5	34.5	15.0	30.0	44.0	51.0
M40x1.5	42.5	15.0	33.0	52.0	54.0
M42x2.0	42.5	15.0	35.0	52.0	54.0
M48x2.0	42.5	15.0	36.5	52.0	54.0
M50x1.5	42.5	15.0	36.5	52.0	54.0
M50x1.5	54.5	16.0	43.0	64.0	55.0
M56x2.0	54.5	16.0	48.0	64.0	55.0
M60x2.0	54.5	16.0	48.0	64.0	55.0
M63x1.5	54.5	16.0	48.0	64.0	55.0
PG7	10.0	12.0	7.0	17.0	35.0
PG9	13.0	12.0	10.0	20.0	37.0
PG11	15.8	12.0	12.0	23.0	39.0
PG13.5	18.5	13.0	14.5	26.0	42.0
PG16	21.2	13.0	17.0	29.5	45.0
PG21	25.5	13.0	21.0	34.0	46.5
PG21	28.5	13.0	23.5	37.0	47.0
PG29	34.5	15.0	30.0	44.0	51.0
PG36	42.5	15.0	36.5	52.0	54.0
PG48	54.5	16.0	48.0	64.0	55.0



Colours:

- W=White & Natural
- BR=Brown
- OR=Orange
- GN=Green
- PP=Purple
- B=Black
- RD=Red
- YL=Yellow
- BL=Blue
- GY=Gray

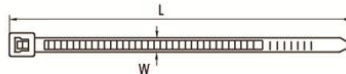

Product Overview

Material: Nylon 66,94V-2 certified by UL. Acid & erosion control, insulate well and not apt to age. Heat-resistant, weather-resistant are available.

Operating temperature: -35°C ~ +85°C.

Colours: Natural (or white, standard color), UV black and other colors are available as requested.

Item NO.	L		W (mm)	Max.Bundle Dia.E (mm)	Min.loop Tensile Strength	
	Inch	mm			LBS	KGS
LK-3x60	2 3/8"	60	2.5	11	18	8
LK-3x80	3 3/16"	80	2.5	16	18	8
LK-3x90	3 5/8"	90	2.5	18	18	8
LK-3x100	4"	100	2.5	22	18	8
LK-3x120	4 3/4"	120	2.5	28	18	8
LK-3x140	5 1/2"	140	2.5	33	18	8
LK-3x150	6"	150	2.5	35	18	8
LK-3x160	6 1/4"	160	2.5	40	18	8
LK-3x200	8"	200	2.5	53	18	8
LK-3x250	10"	250	2.5	65	18	8
LK-4x100	4"	100	3.6	22	40	18
LK-4x120	4 3/4"	120	3.6	30	40	18
LK-4x140	5 1/2"	140	3.6	33	40	18
LK-4x150	6"	150	3.6	35	40	18
LK-4x180	7"	180	3.6	44	40	18
LK-4x200	8"	200	3.6	53	40	18
LK-4x220	8 5/8"	220	3.6	58	40	18
LK-4x250	10"	250	3.6	65	40	18
LK-4x280	11"	280	3.6	70	40	18
LK-4x300	11 5/8"	300	3.6	80	40	18
LK-4x370	14 1/2"	370	3.6	102	40	18
LK-5x120	4 3/4"	120	4.6	26	50	22
LK-5x160	6 1/4"	160	4.8	39	50	22
LK-5x180	7"	180	4.6	46	50	22
LK-5x190	7 1/2"	190	4.6	48	50	22

Item NO.	L		W (mm)	Max.Bundle Dia.E (mm)	Min.loop Tensile Strength	
	Inch	mm			LBS	KGS
LK-5x200	8"	200	4.8	53	50	22
LK-5x250	10"	250	4.8	65	50	22
LK-5x280	11"	280	4.8	70	50	22
LK-5x300	11 8/5"	300	4.8	82	50	22
LK-5x350	13 3/4"	350	4.8	90	50	22
LK-5x380	15"	380	4.8	105	50	22
LK-5x400	15 3/4"	400	4.8	108	50	22
LK-5x430	17"	430	4.8	115	50	22
LK-5x450	17 3/4"	450	4.8	130	50	22
LK-5x500	19 11/16"	500	4.8	150	50	22
LK-7x150	6"	150	6.8	33	85	38
LK-7x180	7"	180	6.8	42	85	38
LK-7x200	8"	200	6.8	50	85	38
LK-7x250	10"	250	6.8	65	85	38
LK-8x200	8"	200	7.6	50	120	55
LK-8x250	10"	250	7.6	63	120	55
LK-8x300	11 5/8"	300	7.6	80	120	55
LK-8x350	13 3/4"	350	7.6	90	120	55
LK-8x370	14 1/4"	370	7.6	98	120	55
LK-8x400	15 3/4"	400	7.6	105	120	55
LK-8x450	17 3/4"	450	7.6	125	120	55
LK-8x500	19 11/16"	500	7.6	145	120	55
LK-8x550	21 1/16"	550	7.6	160	120	55
LK-8x600	23 5/8"	600	7.6	170	120	55
LK-8x650	25 9/16"	650	7.6	190	120	55
LK-8x750	29 9/16"	750	7.6	220	120	55
LK-9x450	17 3/4"	450	9.0	120	175	80
LK-9x530	20 3/4"	530	9.0	150	175	80
LK-9x550	21 1/16"	550	9.0	160	175	80
LK-9x600	23 5/8"	600	9.0	170	175	80
LK-9x650	25 9/16"	650	9.0	190	175	80
LK-9x700	27 1/2"	700	9.0	205	175	80
LK-9x760	30"	760	9.0	225	175	80
LK-9x920	36 1/4"	920	9.0	265	175	80
LK-9x1020	40 1/6"	1020	9.0	295	175	80
LK-9x1150	45 1/4"	1150	9.0	310	175	80
LK-9x1220	48"	1210	9.0	340	175	80
LK-9x1350	53"	1350	9.0	380	175	80
LK-9x1550	61"	1550	9.0	470	175	80
LK-10x450	17 3/4"	450	10.0	125	200	91
LK-10x500	19 11/16"	500	10.0	145	200	91
LK-12x300	11 5/8"	300	12.7	80	250	114
LK-12x400	15 3/4"	400	12.7	105	250	114
LK-12x540	21 1/4"	540	12.7	155	250	114
LK-12x650	25 9/16"	650	12.0	190	250	114
LK-12x750	29 9/16"	750	12.0	220	250	114
LK-12x780	30 3/4"	780	12.7	230	250	114
LK-13x 540	21 1/4"	540	13.0	155	250	114

Item NO.	L		W (mm)	Max.Bundle Dia.E (mm)	Min.loop Tensile Strength	
	Inch	mm			LBS	KGS
LK-1.8x100	4"	100	1.8	22	14	6.5
LK-1.9x120	4 3/4"	120	1.9	28	14	6.5
LK-1.9x150	6"	150	1.9	35	14	6.5
LK-2.0x200	8"	200	2.0	50	14	6.5
LK-2.2x60	2 3/8"	60	2.2	11	18	8
LK-2.2x80	3 3/16"	80	2.2	18	18	8
LK-2.2x100	4"	100	2.2	22	18	8
LK-2.2x120	4 3/4"	120	2.2	28	18	8
LK-2.2x150	6"	150	2.2	35	18	8
LK-2.2x200	8"	200	2.2	50	18	8
LK-2.9x150	6"	150	2.9	35	33	15
LK-2.9x200	8"	200	2.9	50	33	15
LK-2.7x250	10"	250	2.7	65	33	15
LK-2.9x300	11 5/8"	300	2.9	80	33	15
LK-3.2x150	6"	150	3.2	35	40	18
LK-3.2x180	7"	180	3.2	42	40	18
LK-3.2x200	8"	200	3.2	50	40	18
LK-3.2x250	10"	250	3.2	65	40	18
LK-3.2x300	11 5/8"	300	3.2	80	40	18
LK-3.7x350	13 3/4"	350	3.7	90	40	18
LK-3.7x400	15 3/4"	400	3.7	108	40	18
LK-4.2x180	7"	180	4.2	42	50	22
LK-4.2x200	8"	200	4.2	50	50	22
LK-4.2x250	10"	250	4.2	65	50	22
LK-4.2x300	11 5/8"	300	4.2	80	50	22
LK-4.2x350	13 3/4"	350	4.2	90	50	22
LK-4.2x380	15"	380	4.2	102	50	22
LK-4.2x400	15 3/4"	400	4.2	105	50	22
LK-5.2x180	7"	180	5.2	42	65	30
LK-5.2x200	8"	200	5.2	50	65	30
LK-5.2x250	10"	250	5.2	65	65	30
LK-5.2x300	11 5/8"	300	5.2	80	65	30
LK-5.5x350	13 3/4"	350	5.5	90	65	30
LK-5.5x400	15 3/4"	400	5.5	105	65	30
LK-5.5x500	19 11/16"	500	5.5	150	65	30
LK-6.0x270	10 5/8"	270	6.0	65	65	30
LK-6.5x250	10"	250	6.5	65	85	38
LK-6.5x300	11 5/8"	300	6.5	80	85	38
LK-6.5x350	13 3/4"	350	6.5	90	85	38
LK-6.5x400	15 3/4"	400	6.5	105	85	38
LK-6.5x450	17 3/4"	450	6.5	125	85	38
LK-6.5x500	19 11/16"	500	6.5	145	85	38

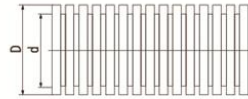

Product Overview

Material: polyamide (PA6)/ polyethylene (PE)/ polypropylene (PP)/ HB according to UL 94.

Temperature: polyamide (PA6) -40°C~+115°C+150°C; polyethylene (PE) -50°C~+80°C+100°C; polypropylene (PP) -40°C~+110°C+130°C

Colours: Black and grey.

Properties: Liquid and Dust proof; Highly resistant to oil, acid and solvents; Free of silicon, cadmium, halogen; Flexible, luster On Surface, abrasion resistant; Racking resistant high mechanical strength; Black tubings are UV-resistant.

Application: For protectively insulated electrical installations.

PA Polyamide corrugated pipe

Thread	int.x ext.(mm)	Dimensions mm±10%		Lengths in rings m/roll
		Stat	Dyn	
AD10.0	6.5x10.0	14.0	35.0	100
AD11.6	8.00x11.6	17.0	40.0	100
AD13.0	9.50x13.0	20.0	45.0	100
AD15.8	12.0x15.8	27.0	55.0	100
AD18.5	14.3x18.5	35.0	65.0	100
AD21.2	17.0x21.2	40.0	75.0	100
AD25.5	21.0x25.5	43.0	85.5	100
AD28.5	23.0x28.5	47.0	100.0	50
AD34.5	29.0x34.5	58.0	120.0	50
AD42.5	36.0x42.5	69.0	150.0	50
AD54.5	48.0x54.5	83.0	190.0	25

PE Polyethylene corrugated pipe

Thread	int.x ext.(mm)	Dimensions mm±10%		Lengths in rings m/roll
		Stat	Dyn	
AD10.0	6.5x10.0	13.0	33.0	100
AD11.6	8.00x11.6	15.0	37.0	100
AD13.0	9.50x13.0	18.0	41.0	100
AD15.8	12.0x15.8	22.0	50.0	100
AD18.5	14.3x18.5	33.0	61.0	100
AD21.2	17.0x21.2	38.0	72.0	100
AD25.5	21.0x25.5	40.0	80.0	100
AD28.5	23.0x28.5	44.0	92.0	50
AD34.5	29.0x34.5	53.0	113.0	50
AD42.5	36.0x42.5	61.0	140.0	50
AD54.5	48.0x54.5	78.0	180.0	25

PP Polypropylene corrugated pipe

Thread	int.x ext.(mm)	Dimensions mm \pm 10%		Lengths in rings m/roll
		Stat	Dyn	
AD10.0	6.5x10.0	16.0	37.0	100
AD11.6	8.00x11.6	18.0	43.0	100
AD13.0	9.50x13.0	21.0	48.0	100
AD15.8	12.0x15.8	26.0	56.0	100
AD18.5	14.3x18.5	37.0	70.0	100
AD21.2	17.0x21.2	44.0	79.0	100
AD25.5	21.0x25.5	49.0	88.0	100
AD28.5	23.0x28.5	52.0	104.0	50
AD34.5	29.0x34.5	58.0	123.0	50
AD42.5	36.0x42.5	68.0	152.0	50
AD54.5	48.0x54.5	84.0	193.0	25

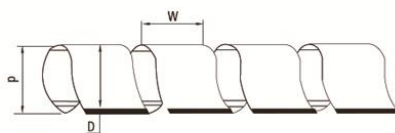

Product Overview

Material: made from PE.

Usage: fix one end with safety belt first, then circle the wires clockwise to make them tighen.

Application: a protection wear for electric wires, and make them insulation and look nice.

Thread	Inside diameter D(mm)	Outside diameter D(mm)	W.(mm)	Wrapping Range (mm)	Packing
SWB-03	1.5	3.0	4.0	1.5-10	10M/ROLL
SWB-06	4	6	7.0	4-50	
SWB-08	6	8	10.8	6-60	
SWB-10	7.5	10	11.4	7.5-60	
SWB-12	9	12	13.9	9-65	
SWB-15	12	15	15.0	12-75	
SWB-19	15	19	18.2	15-100	
SWB-24	20	24	19.6	20-130	
SWB-30	26	30	43.0	26-150	

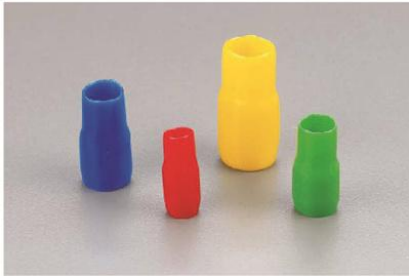

Product Overview

Material: Made from PVC.

Usage: device the colorful cable in machine, used to various terminals as soft feature, easy to take off.

Character: clearly color, shine, soft, insulated.

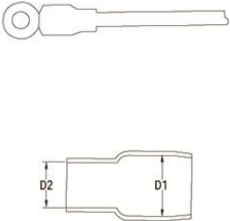
Color: red white blue yellow,black green, brown available upon special request.

Item NO.	SQ(mm ²)	Dimension		Packing	Dimension
		D1(mm)	D2(mm)		
V-1.25	1.25	3.3	3.1	100PCS	
V-2	2	4.5	3.7		
V-3.5	3.5	5.7	4.1		
V-5.5	5.5	5.7	5.2		
V-8	8	7.2	6.2		
V-14	14	10.0	8.0		
V-22	22	12.0	9.5		
V-38	38	14.0	11.8		
V-60	60	16.8	13.5		
V-80	80	19.0	16.0		
V-100	100	22.0	18.0	50PCS	
V-125	125	24.0	20.0		
V-150	150	24.4	22.0		
V-200	200	32.0	24.0	25PCS	
V-250	250	38.0	26.5		
V-325	325	38.0	29.0		
V-400	400	44.0	37.0		
V-500	500	45.0	40.4		
V-630	630	52.0	45.0		

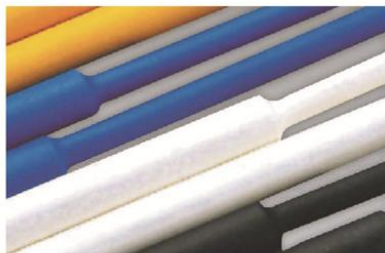

Product Overview

Function: 1. wire coat and insulation.

2. make the joint of terminal block and wire insulated.

3. divide the colors.

4. water-proof.

5. protection and insulation of insitors and electrical capacitors.

Standard color: black, white, red, blue, yellow, green, brown, grey, orange and purple.

Item NO.	As Supplied		After Shrinkang		Packing (m/roll)
	I.D (mm)	Thickness(mm)	I.D (mm)	Thickness(mm)	
DRS-1	1.0	0.2±0.05	0.5	0.4±0.05	200m/roll
DRS-1.5	1.5	0.2±0.05	0.75	0.4±0.05	
DRS-2	2.0	0.25±0.05	1.0	0.45±0.1	
DRS-2.5	2.5	0.25±0.05	1.25	0.45±0.1	
DRS-3	3.0	0.25±0.05	1.5	0.45±0.1	
DRS-3.5	3.5	0.25±0.05	1.75	0.45±0.1	
DRS-4	4.0	0.25±0.05	2.0	0.45±0.1	
DRS-5	5.0	0.35±0.05	2.5	0.55±0.1	
DRS-6	6.0	0.35±0.05	3.0	0.55±0.1	
DRS-7	7.0	0.35±0.05	3.5	0.55±0.1	
DRS-8	8.0	0.35±0.05	4.0	0.55±0.1	100m/roll
DRS-9	9.0	0.35±0.05	4.5	0.55±0.1	
DRS-10	10.0	0.35±0.05	5.0	0.60±0.1	
DRS-11	11.0	0.35±0.05	5.5	0.60±0.1	
DRS-12	12.0	0.35±0.1	6.0	0.70±0.1	
DRS-13	13.0	0.35±0.1	6.5	0.70±0.1	
DRS-14	14.0	0.35±0.1	7.0	0.70±0.1	
DRS-15	15.0	0.35±0.1	7.5	0.70±0.1	
DRS-16	16.0	0.35±0.1	8.0	0.70±0.1	
DRS-18	18.0	0.4±0.1	9.0	0.80±0.1	
DRS-20	20.0	0.5±0.1	10.0	0.90±0.1	50m/roll
DRS-22	22.0	0.5 ± 0.1	11.0	0.90±0.1	
DRS-25	25.0	0.5 ± 0.1	12.5	0.90±0.1	
DRS-28	28.0	0.5±0.1	14.0	0.90±0.1	
DRS-30	30.0	0.5±0.1	15.0	1.00±0.2	
DRS-35	35.0	0.5±0.1	17.5	1.00±0.2	
DRS-40	40.0	0.5 ± 0.1	20.0	1.00 ± 0.2	
DRS-50	50.0	0.5±0.1	25.0	1.00±0.2	
DRS-60	60.0	0.6±0.1	30.0	1.20±0.2	
DRS-70	70.0	0.6±0.1	35.0	1.20±0.2	
DRS-80	80.0	0.6±0.1	40.0	1.20±0.2	25m/roll
DRS-90	90.0	0.6±0.1	45.0	1.30±0.2	
DRS-100	100.0	0.7±0.1	50.0	1.30±0.2	
DRS-120	120	0.7±0.1	60.0	1.30±0.2	
DRS-150	150	0.8±0.1	75.0	1.60±0.2	

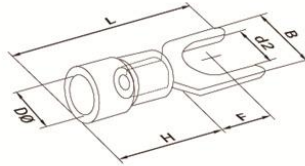
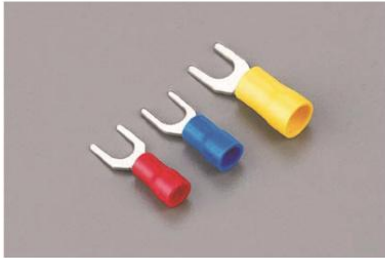

	Item NO.	USA screw	screw dia. d2(mm)	Dimension					Color
				B(mm)	L(mm)	F(mm)	H(mm)	D Ø(mm)	
0.5~1.5mm ² (22-16) I _{max} =19A	SV1.25-3	#4	3.2	5.7	21.2	6.5	10.0	4.3	Red
	SVS1.25-3.5	#6	3.7	5.7	21.2	6.5			
	SVL1.25-3.5	#6	3.7	6.4	21.2	6.5			
	SVS1.25-4	#8	4.3	6.4	21.2	6.5			
	SVM1.25-4	#8	4.3	7.2	21.2	6.5			
	SVL1.25-4	#8	4.3	8.1	21.2	6.5			
	SVS1.25-5	#10	5.3	8.1	21.2	6.5			
	SVL1.25-5	#10	5.3	9.5	21.2	6.5			
	SVS1.25-6	1/4	6.5	9.5	21.2	6.5			
SVL1.25-6	1/4	6.5	12.0	21.2	11.0				
1.5~2.5mm ² (16-14) I _{max} =27A	SV2-3	#4	3.2	5.7	21.2	6.5	10.0	4.9	blue
	SVS2-3.5	#6	3.7	5.7	21.2	6.5			
	SVL2-3.5	#6	3.7	6.4	21.2	6.5			
	SVS2-4	#8	4.3	6.0	21.2	6.5			
	SVM2-4	#8	4.3	7.2	21.2	6.5			
	SVL2-4	#8	4.3	8.1	21.2	6.5			
	SVS2-5	#10	5.3	8.1	21.2	6.5			
	SVL2-5	#10	5.3	9.5	21.2	6.5			
	SVS2-6	1/4	6.5	9.5	21.2	6.5			
SVL2-6	1/4	6.5	12.0	21.2	11.0				
2.5~4mm ² (14-12) I _{max} =37A	SV3.5-4	#8	4.3	8.0	24.8	7.0	12.5	6.2	black
	SV3.5-5	#10	5.3	8.0	24.8	7.0			
	SV3.5-6	1/4	6.5	12.0	28.0	12.1			
4~6mm ² (12-10) I _{max} =48A	SVS.5-3.5	#6	3.7	8.3	25.2	7.5	12.5	6.7	yellow
	SVS5.5-4	#8	4.3	8.3	25.2	7.5			
	SVL5.5-4	#8	4.3	9.0	23.9	7.5			
	SVS5.5-5	#10	5.3	9.0	23.9	7.5			
	SVS5.5-6	1/4	6.5	9.0	23.9	7.5			
	SVL5.5-6	1/4	6.5	12.0	31.2	12.0			
	SV5.5-8	5/16	8.4	14.0	30.0	11.5			

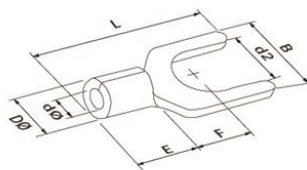

	Item NO.	USA screw	screw dia. d2(mm)	Dimension					
				B(mm)	L(mm)	F(mm)	E Ø(mm)	D Ø(mm)	d Ø(mm)
0.5~1.5mm ² (22-16) I _{max} =19A	SNB 1.25-3	#4	3.2	5.7	16.0	6.5	4.8	3.4	1.7
	SNBS1.25-3.5	#6	3.7	5.7	16.0	6.5			
	SNBL1.25-3.5	#6	3.7	6.4	16.0	6.5			
	SNBS1.25-4	#8	4.3	6.4	16.0	6.5			
	SNBM1.25-4	#8	4.3	7.2	16.0	6.5			
	SNBL1.25-4	#8	4.3	8.1	16.0	6.5			
	SNBS1.25-5	#10	5.3	8.1	16.0	6.5			
	SNBL1.25-5	#10	5.3	9.5	16.0	6.5			
	SNBS1.25-6	1/4	6.4	9.5	16.0	6.5			
SNBL1.25-6	1/4	6.4	12.0	22.0	11.0				
1.5~2.5mm ² (16-14) I _{max} =27A	SNB 2-3	#4	3.2	5.7	16.0	6.5	4.8	4.1	2.3
	SNBS 2-3.5	#6	3.7	5.7	16.0	6.5			
	SNBL2-3.5	#6	3.7	6.4	16.0	6.5			
	SNBS 2-4	#8	4.3	6.4	16.0	6.5			
	SNBM2-4	#8	4.3	7.2	16.0	6.5			
	SNBL 2-4	#8	4.3	8.1	16.0	6.5			
	SNBS 2-5	#10	5.3	8.1	16.0	6.5			
	SNBL 2-5	#10	5.3	9.5	16.0	6.5			
	SNBS 2-6	1/4	6.4	9.5	16.0	6.5			
SNBL 2-6	1/4	6.4	12.0	22.0	11.0				
2.5~4mm ² (14-12) I _{max} =37A	SNB 3.5-3	#4	3.2	5.7	18.3	7.0	6.0	5.0	3.0
	SNB 3.5-4	#8	4.3	8.0	18.3	7.0			
	SNB 3.5-5	#10	5.3	8.0	18.3	7.0			
	SNB 3.5-6	1/4	6.4	12.0	21.5	12.1			
4~6mm ² (12-10) I _{max} =48A	SNB 5.5-3.5	#8	3.7	8.3	19.5	7.5	6.8	5.6	3.4
	SNBS 5.5-4	#10	4.3	8.3	19.5	7.5			
	SNBL 5.5-4	#8	4.3	9.0	19.5	7.5			
	SNB 5.5-5	#10	5.3	9.0	19.5	7.5			
	SNBS 5.5-6	1/4	6.4	9.0	19.5	7.5			
	SNBL5.5-6	1/4	6.4	12.0	25.5	12.0			
	SNBS 5.5-8	5/16	8.4	14.0	24.5	11.5			
6~10mm ² (8) I _{max} =62A	SNB 8-4	#8	4.3	8.7	23.0	6.0	8.5	7.2	4.5
	SNB8-5	#10	5.3	12.0	24.5	5.7	8.5	7.2	4.5
	SNB8-6	1/4	6.4	12.0	24.5	5.7	8.5	7.2	4.5
	SNB8-8	5/16	8.4	14.5	28.0	8.3	8.5	7.2	4.5
	SNB14-6	1/4	6.4	12.0	28.0	7.5	10.5	9.0	5.8
	SNB14-8	5/16	8.4	14.0	28.0	7.5	10.5	9.0	5.8
	SNB22-8	5/16	8.4	14.0	34.5	9.0	12.0	11.5	7.7

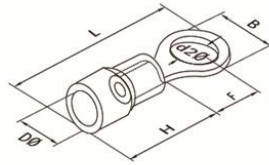

	Item NO.	USA screw	screw dia. d2 (mm)	Dimension					Color
				B (mm)	L (mm)	F (mm)	H (mm)	DØ (mm)	
0.5~1.5mm ² (22-16) I _{max} =19A	RV1.25-3	#4	3.2	5.7	17.8	4.95	10.0	4.3	Red
	RVS1.25-3.5	#6	3.7	5.7	17.8	4.95			
	RVM1.25-3.5	#6	3.7	6.6	20.1	6.3			
	RVL1.25-3.5	#6	3.7	8.0	21.5	7.0			
	RVS1.25-4	#8	4.3	6.6	20.1	6.3			
	RVL1.25-4	#8	4.3	8.0	21.5	7.0			
	RV1.25-5	#10	5.3	8.0	21.5	7.0			
	RV1.25-6	1/4	6.5	11.6	27.5	11.1			
	RV1.25-8	5/16	8.4	11.6	27.5	11.1			
RV1.25-10	3/8	10.5	13.6	31.6	13.9				
1.5~2.5mm ² (16-14) I _{max} =27A	RV2-3	#4	3.2	6.6	17.8	4.3	10.0	4.9	blue
	RVS2-3.5	#6	3.7	6.6	17.8	4.3			
	RVM2-3.5	#6	3.7	6.6	21.0	7.0			
	RVL2-3.5	#6	3.7	8.5	22.5	7.75			
	RVS2-4	#8	4.3	6.6	21.0	7.0			
	RVL2-4	#8	4.3	8.5	22.5	7.75			
	RVS2-5	#10	5.3	8.5	22.5	7.75			
	RVL2-5	#10	5.3	9.5	22.5	7.25			
	RV2-6	1/4	6.5	12.0	27.6	11.0			
RV2-8	5/16	8.4	12.0	27.6	11.0				
RV2-10	3/8	10.5	13.6	30.2	13.9				
2.5~4mm ² (14-12) I _{max} =37A	RV3.5-4	#8	4.3	8.0	24.5	7.7	12.5	6.2	black
	RVS3.5-5	#10	5.3	8.0	24.5	7.7			
	RVL3.5-5	#10	5.3	12.0	27.9	7.7			
	RV3.5-6	1/4	6.5	12.0	27.9	7.7			
4~6mm ² (12-10) I _{max} =48A	RV5.5-3.5	#6	3.7	7.2	21.4	5.9	12.5	6.7	yellow
	RVS5.5-4	#8	4.3	7.2	21.5	5.9			
	RVL5.5-4	#8	4.3	9.5	25.5	8.3			
	RV5.5-5	#10	5.3	9.5	25.5	8.3			
	RV5.5-6	1/4	6.5	12.0	31.5	13.0			
	RV5.5-8	5/16	8.4	15.0	33.7	13.7			
	RV5.5-10	3/8	10.5	15.0	33.7	13.7			
	RV5.5-12	1/2	13.0	19.2	38.1	16.0			

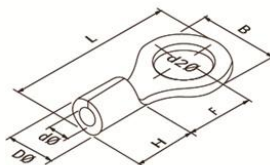

	Item NO.	USA screw	screw dia. d2 (mm)	Dimension					
				B (mm)	L (mm)	F (mm)	EØ (mm)	DØ (mm)	dØ (mm)
0.5–1.5mm ² (22-16) I _{max} =19A	RNB 1.25-3	#4	3.2	5.7	12.6	4.95	4.8	3.4	1.7
	RNBS 1.25-3.5	#6	3.7	5.7	12.6	4.95			
	RNBM 1.25-3.5	#6	3.7	6.6	14.4	6.3			
	RNBL 1.25-3.5	#6	3.7	8.0	15.8	7.0			
	RNBS1.25-4	#8	4.3	6.6	14.4	6.3			
	RNBL 1.25-4	#8	4.3	8.0	15.8	7.0			
	RNB1.25-5	#10	5.3	8.0	15.8	7.0			
	RNB1.25-6	1/4	6.4	11.6	21.8	11.1			
	RNB1.25-8	5/16	8.4	11.6	21.8	11.1			
RNB1.25-10	3/8	10.5	13.6	25.5	13.6				
1.5–2.5mm ² (16-14) I _{max} =27A	RNB2-3	#4	3.2	6.6	12.3	4.3	4.8	4.1	2.3
	RNBS 2-3.5	#6	3.7	6.6	12.3	4.3			
	RNBM2-3.5	#6	3.7	6.6	16.0	7.0			
	RNBL 2-3.5	#6	3.7	8.5	16.8	7.75			
	RNBS2-4	#8	4.3	6.6	16.0	7.0			
	RNBL 2-4	#8	4.3	8.5	16.8	7.75			
	RNBS 2-5	#10	5.3	8.5	16.8	7.75			
	RNBL2-5	#10	5.3	9.5	16.8	7.25			
	RNB 2-6	1/4	6.4	12.0	21.8	11.0			
	RNB 2-8	5/16	8.4	12.0	21.8	11.0			
	RNB 2-10	3/8	10.5	13.6	25.5	13.9			
	RNB 2-12	1/2	13.0	19.2	3.1	16.5			
2.5–4mm ² (14-12) I _{max} =37A	RNB 3.5-4	#8	4.3	8.0	18.0	7.7	6.0	5.0	3.0
	RNBS 3.5-5	#10	5.3	8.0	18.0	7.7			
	RNBL3.5-5	#10	5.3	12.0	21.4	7.7			
	RNB 3.5-6	1/4	6.4	12.0	21.4	7.7			
4–6mm ² (12-10) I _{max} =48A	RNB 5.5-3.5	#6	3.7	7.2	15.7	5.9	6.8	5.6	3.4
	RNBS 5.5-4	#8	4.3	7.2	15.7	5.9			
	RNBL 5.5-4	#8	4.3	9.5	19.8	8.3			
	RNB 5.5-5	#10	5.3	9.5	19.8	8.3			
	RNB 5.5-6	1/4	6.4	12.0	25.8	13.0			
	RNB 5.5-8	5/16	8.4	15.0	28.0	13.7			
	RNB 5.5-10	3/8	10.5	15.0	28.0	13.7			
	RNB 5.5-12	1/2	13.0	19.2	32.4	16.0			

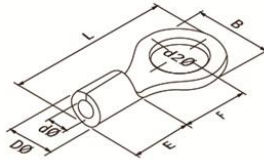

	Item NO.	USA screw	screw dia. d2 (mm)	Dimension					
				B (mm)	L (mm)	F (mm)	EØ (mm)	DØ (mm)	dØ (mm)
6~10mm ² (8) I _{max} =62A	RNB 8-4	#8	4.3	8.8	23.8	9.3	8.5	7.2	4.5
	RNBS 8-5	#10	5.3	8.8	23.8	11.1			
	RNBM 8-5	#10	5.3	12.0	23.8	9.3			
	RNBL 8-5	#10	5.3	15.0	29.8	13.8			
	RNBS 8-6	1/4	6.4	12.0	23.8	9.3			
	RNBL 8-6	1/4	6.4	15.0	29.8	13.8			
	RNB 8-8	5/16	8.4	15.0	29.8	13.8			
	RNB 8-10	3/8	10.5	15.0	29.8	13.8			
	RNB 8-12	1/2	13.0	20.0	33.5	15.0			
10~16mm ² (6) I _{max} =88A	RNB 14-4	#8	4.3	12.0	29.8	13.3	10.5	9.0	5.8
	RNB 14-5	#10	5.3	12.0	29.8	13.3			
	RNBS 14-6	1/4	6.4	12.0	29.8	13.3			
	RNBL 14-6	1/4	6.4	16.0	32.8	13.3			
	RNB 14-8	5/16	8.4	16.0	32.8	14.5			
	RNB 14-10	3/8	10.5	16.0	32.8	14.5			
	RNB 14-12	1/2	13.0	22.0	41.0	19.5			
	RNBS 22-5	#10	5.3	12.2	33.2	14.5			
	RNBL 22-5	#10	5.3	16.5	33.7	13.5			
16~25mm ² (4) I _{max} =115A	RNBS 22-6	1/4	6.4	12.2	33.2	14.5	12.0	11.5	7.7
	RNBL 22-6	1/4	6.4	6.5	33.7	13.5			
	RNB 22-8	5/16	8.4	16.5	33.7	13.5			
	RNB 22-10	3/8	10.5	16.5	33.7	13.5			
	RNB 22-11	7/16	11.5	22.0	42.5	19.5			
35~50mm ² (2) I _{max} =160A	RNB 22-12	1/2	13.0	22.0	42.5	19.5	14.0	13.3	9.4
	RNB 38-5	#10	5.3	15.3	39.0	18.3			
	RNB 38-5	1/4	6.4	15.3	39.0	18.3			
	RNBS 38-8	5/16	8.4	15.3	39.0	18.3			
	RNBL 38-8	5/16	8.4	22.0	42.7	17.7			
	RNBS 38-10	3/8	10.5	15.3	39.0	18.3			
	RNBL 38-10	3/8	10.5	22.0	42.7	17.7			
	RNB 38-11	7/16	11.5	22.0	42.7	17.7			
RNB 38-12	1/2	13.0	22.0	42.7	17.7				

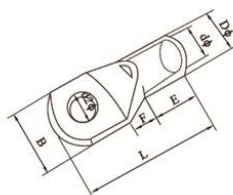

Item NO.	screw dia. d2(mm)	Dimension					Cinle Sq
		dØ (mm)	DØ (mm)	B (mm)	E (mm)	L (mm)	
SC1.5-5	5.2	1.8	3.7	8.0	6.5	16	1.5
SC2.5-4	4.2	2.4	4.0	8.0	7.0	18	2.5
SC2.5-5	5.2	2.4	4.0	10.0	7.0	20	2.5
SC4-5	5.2	3.1	4.8	10	7.5	20	4
SC4-6	6.5	3.1	4.8	10	7.5	20	4
SC6-5	5.2	3.8	5.5	10	8.0	23	6
SC6-6	6.5	3.8	5.5	12	8.0	23	6
SC10-6	6.5	4.5	6.2	12	9.0	25	10
SC10-8	8.4	4.5	6.2	12	9.0	25	10
SC16-6	6.5	5.4	7.1	12	11.0	30	16
SC16-8	8.4	5.4	7.1	12	11.0	30	16
SC25-6	6.5	6.8	8.8	13	13.5	33	25
SC25-8	8.4	6.8	8.8	18	13.5	33	25
SC35-8	8.4	8.2	10.6	15.3	14.5	38	35
SC35-10	10.5	8.2	10.6	18	14.5	38	35
SC50-8	8.4	9.5	12.4	17.8	17	45	50
SC50-10	10.5	9.5	12.4	17.8	17	45	50
SC70-10	10.5	11.2	14.7	21.0	19.5	50	70
SC70-12	13.0	11.2	14.7	21.0	19.5	50	70
SC95-10	10.5	13.5	17.4	25	23.5	55	95
SC95-12	13	13.5	17.4	25	23.5	55	95
SC120-12	13	15	19.4	28	26	63	120
SC120-16	17	15	19.4	28	26	63	120
SC150-12	13	16.5	21.2	30	29	70	150
SC150-16	17	16.5	21.2	30	29	70	150
SC185-16	17	18.5	23.5	34	33	75	185
SC240-16	17	21	26.5	38	40	90	240
SC240-20	21	21	26.5	38	40	90	240
SC300-16	17	23.5	30	43	44	98	300
SC300-20	21	23.5	30	43	44	98	300
SC400-16	17	28.5	36.5	50.1	46	110	400
SC400-20	21	28.5	36.5	50.1	46	110	400
SC500-16	17	30	39	56	50	120	500
SC500-20	21	30	39	56	50	120	500
SC630-20	21	35	45	65	56	140	630
SC800-BL	-	39	50.6	73.5	60	170	800
SC1000-BL	-	43	56.2	81	87	200	1000

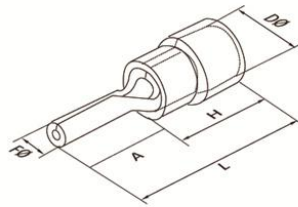
Cross section: 0.5~1.5mm² (22-16) Max current: I_{max}=19A

Item NO.	Dimension				Color
	F Ø(mm)	L (mm)	H (mm)	D Ø(mm)	
PTV1.25-9	1.9	19.0	10.0	4.3	Red
PTV1.25-10	1.9	20.0			
PTV1.25-12	1.9	22.0			
PTV1.25-13	1.9	23.0			
PTV1.25-18	1.9	28.0			

Cross section: 1.5-2.5mm² (16-14) Max current: I_{max}=27A

Item NO.	Dimension				Color
	F Ø(mm)	L (mm)	H (mm)	D Ø(mm)	
PTV2-9	1.9	19.0	10.0	4.3	Blue
PTV2-10	1.9	20.0			
PTV2-12	1.9	22.0			
PTV2-13	1.9	23.0			
PTV2-18	1.9	28.0			

Cross section: 4~6mm² (12-10) Max current: I_{max}=48A

Item NO.	Dimension				Color
	F Ø(mm)	L (mm)	H (mm)	D Ø(mm)	
PTV5.5-13	2.8	25.5	12.5	6.7	yellow

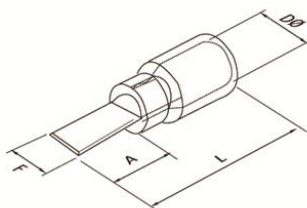
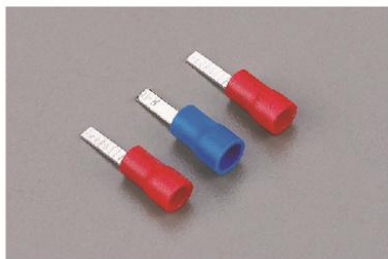

Cross section:0.5~1.5mm² (22-16) Max current: I_{max}=19A

Item NO.	Dimension			
	F (mm)	L (mm)	A (mm)	D (mm)
DBV1.25-10	2.3	20.0	10.0	4.3
DBV1.25-11	3.0	21.0	11.0	
DBV1.25-14	3.0	24.0	14.0	
DBV1.25-18	2.3	28.0	18.0	

Cross section:1.5~2.5mm² (16-14) Max current: I_{max}=19A

Item NO.	Dimension			
	F (mm)	L (mm)	A (mm)	D (mm)
DBV2-9	2.8	19.0	9.0	4.9
DBV2-15	2.3	25.0	15.0	
DBV2-18	2.3	28.0	18.0	

Cross section:4-6mm² (12-10) Max current: I_{max}=48A

Item NO.	Dimension			
	F (mm)	L (mm)	A (mm)	D (mm)
DBV5.5-10	2.8	22.5	10.0	5.6

KE10.1
Al 4×10-35mm² / Cu 1.5-25mm²

Description: KE10.1 connector can be used for aluminum and copper conductors. Tightening torque is 10Nm.

The connectors are used either inside metal poles or in separate boxes.

KE10.504
Al 4×10-50mm² / Cu 2.5-35mm²

Description: KE 10.504 connector can be used for aluminum and copper conductors. Tightening torque is 10Nm.

The connectors are used either inside metal poles or in separate boxes.

Item No.	KE10.1	KE10.504
Ratings	ETIM class, low current connector	ETIM class, low current connector
Length	55.7 mm	62mm
Height	29.4mm	29.55mm
Weight	0.048kg	0.053kg
Colour	Transparent	Transparent
Model	Branch	Branch
Tightening torque	10 Nm	10 Nm
Conductor size Al	10...35 mm ²	10...50 mm ²
Conductor size Cu	1.5...25 mm ²	2.5...35 mm ²
Conductor diameter	1.7...9 mm ²	2...10.2 mm ²
Material insulation	PC	PC
Nominal cross section	1.5...35 mm ²	2.5...50 mm ²
Core diameter	1.7...9 mm	2...10.2 mm

KE10.3
Al 6×10-35mm² / Cu 1.5-25mm²

Description: KE10.3 connector can be used for aluminum and copper conductors. Tightening torque is 10Nm.

The connectors are used either inside metal poles or in separate boxes.

KE10.506
Al 6×10-50mm² / Cu 2.5-35mm²

Description: KE 10.506 connector can be used for aluminum and copper conductors. Tightening torque is

10Nm. The connectors are used either inside metal poles or in separate boxes.

Item No.	KE10.3	KE10.506
Ratings	ETIM class, low current connector	ETIM class, low current connector
Length	80.5mm	90.05mm
Height	29mm	29.55mm
Weight	0.070kg	0.077kg
Colour	Transparent	Transparent
Model	Branch	Branch
Tightening torque	10 Nm	10 Nm
Conductor size Al	10...35 mm ²	10...50 mm ²
Conductor size Cu	1.5...25 mm ²	2.5...35 mm ²
Conductor diameter	1.7...9mm ²	2...10.2 mm ²
Material insulation	PC	PC
Nominal cross section	1.5...35 mm ²	2.5...50 mm ²
Core diameter	1.7...9 mm	2...10.2 mm

**SV15**Al 10-35mm² / Cu 1.5-25mm²

Description: SV15 includes three phase connectors of KE10.1 and one connector of KE10.3, plus an 16mm² earth wire of 35mm with a cable lug.

Item No.	SV15
Ratings	ETIM class, low current connector
Weight	0.28kg
Colour	Transparent
Model	Branch
Tightening torque	10 Nm
Conductor size Al	10...35 mm ²
Conductor size Cu	1.5...25 mm ²
Conductor diameter	1.7...9 mm
Material insulation	PC
Nominal cross section	1.5...35 mm ²
Core diameter	1.7...9 mm
Max. number of cores	4

**SV15.5**Al 10-35mm² / Cu 1.5-25mm²

Description: SV15.5 includes four phase connectors of KE10.1 and one connector of KE10.3, plus an 16mm² earth wire of 35mm with a cable lug.

Item No.	SV15.5
Ratings	ETIM class, low current connector
Weight	0.33kg
Colour	Transparent
Model	Branch
Tightening torque	10 Nm
Conductor size Al	10...35 mm ²
Conductor size Cu	1.5...25 mm ²
Conductor diameter	1.7...9 mm
Material insulation	PC
Nominal cross section	1.5...35mm ²
Core diameter	1.7...9mm
Max. number of cores	5

**SV50**Al 10-50mm² / Cu 2.5-35mm²

Description: SV50 includes three phase connectors of KE10.504 and one connector of KE10.506, plus an 16mm² earth wire of 35mm with a cable lug.

Item No.	SV50
Ratings	ETIM class, low current connector
Weight	0.3kg
Colour	Transparent
Model	Branch
Tightening torque	10 Nm
Conductor size Al	10...50 mm ²
Conductor size Cu	2.5...35mm ²
Conductor diameter	2...10.2 mm
Material insulation	PC
Nominal cross section	2.5...50 mm ²
Core diameter	2...10.2 mm
Max. number of cores	4

WIRING DUCT SERIES

Multiple models and sizes, equipped with complete cable tray covers, support special color customization. Standard length of 2 meters, manufacturer provides customized length.



L-UD/R,L-VD/R SERIES LOW SMOKE HALOGEN FREE WIRING DUCT

Polycarbonate [PC] + Engineering Plastics [ABS]
The new low-smoke halogen-free reinforced trunking

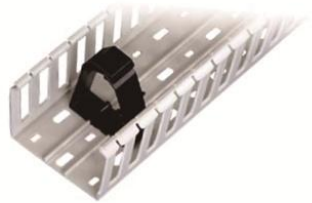

Material

- Polycarbonate (PC)+engineering plastics (ABS), halogen-free, low smoke and environmentally friendly insulation material, with electrical and fire safety.
- Fire rating:UL94 V-0 Non Flame Spread Product

Structure

1. Both sides gradually thicken from top to bottom, making them more sturdy and durable;
2. The combination of reverse buckle groove body and groove cover design makes it easy to disassemble and safer;
3. The bottom right angle is concave and easy to fold. Simply cut both ends to connect with the vertical trunking, forming a flat surfaceDirect channel, all-round protection of cables;
4. The bottom track is convenient for attaching coils to fix cables, ensuring proper and tidy wiring, and saving space.





L-UD/R series low-smoke halogen-free insulated wiring trough (reinforced type)

Model	Specification		Slot width mm	Sliver width mm	Wires to be Contained	Package meter
	Height(mm)	Width(mm)				
L-UD/R 25/25	25	25	10	10	10-25pcs	100
L-UD/R 37.5/37.5	37.5	37.5	10	10	60-70pcs	100
L-UD/R 50/25	50	25	10	10	20-30pcs	100
L-UD/R 50/37.5	50	37.5	10	10	20-35pcs	80
L-UD/R 50/50	50	50	10	10	80-90pcs	80
L-UD/R 50/75	50	75	10	10	180-200pcs	48
L-UD/R 50/100	50	100	10	10	220-250pcs	48
L-UD/R 75/25	75	25	10	10	50-55pcs	60
L-UD/R 75/37.5	75	37.5	10	10	110-115pcs	60
L-UD/R 75/50	75	50	10	10	180-200pcs	48
L-UD/R 75/75	75	75	10	10	200-240pcs	36
L-UD/R 75/100	75	100	10	10	260-320pcs	24

L-VD/R series low-smoke halogen-free insulated wiring trough (reinforced type)

Model	Specification		Slot width mm	Sliver width mm	Wires to be Contained	Package meter
	Height(mm)	Width(mm)				
L-VD/R 25/25	25	25	6	6.5	10-25pcs	100
L-VD/R 37.5/37.5	37.5	37.5	6	6.5	60-70pcs	100
L-VD/R 50/25	50	25	6	6.5	20-30pcs	100
L-VD/R 50/37.5	50	37.5	6	6.5	20-35pcs	80
L-VD/R 50/50	50	50	6	6.5	80-90pcs	80
L-VD/R 50/75	50	75	6	6.5	180-200pcs	48
L-VD/R 50/100	50	100	6	6.5	220-250PCS	48
L-VD/R 75/25	75	25	6	6.5	50-55pcs	60
L-VD/R 75/37.5	75	37.5	6	6.5	110-115pcs	60
L-VD/R 75/50	75	50	6	6.5	180-200pcs	48
L-VD/R 75/75	75	75	6	6.5	200-240pcs	36
L-VD/R 75/100	75	100	6	6.5	260-320pcs	24

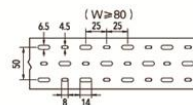
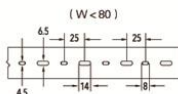
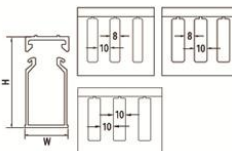

Model	Specification		Slot width mm	Sliver width mm	Wires to be Contained	Package meter
	Height(mm)	Width(mm)				
L-UD 35 35	35	35	10	8	20-25pcs	100
L-UD 40 25	40	25	8	10	20-30pcs	100
L-UD 40 30		30	8	10	35-40pcs	100
L-UD 40 40		40	8	10	60-70pcs	100
L-UD 40 50		50	8	10	50-70pcs	80
L-UD 40 60		60	8	10	100-115pcs	64
L-UD 40 80		80	8	10	120-135pcs	48
L-UD 50 25		50	25	8	10	20-35pcs
L-UD 50 35	35		8	10	40-60pcs	100
L-UD 50 50	50		8	10	80-90pcs	80
L-UD 50 80	80		8	10	160-180pcs	48
L-UD 60 25	60	25	8	10	40-55pcs	80
L-UD 60 30		30	8	10	40-65pcs	80
L-UD 60 40		40	8	10	100-115pcs	46
L-UD 60 60		60	8	10	120-135pcs	48
L-UD 60 80		80	8	10	180-210pcs	36
L-UD 60 100		100	8	10	230-250pcs	32
L-UD 60 120		120	8	10	260-350pcs	24
L-UD 80 25	80	25	8	10	100-120pcs	60
L-UD 80 30		30	8	10	105-125pcs	60
L-UD 80 35		35	8	10	110-130pcs	60
L-UD 80 40		40	8	10	140-160pcs	48
L-UD 80 45		45	8	10	140-165pcs	48
L-UD 80 50		50	8	10	160-180pcs	48
L-UD 80 60		60	8	10	180-210pcs	36
L-UD 80 80		80	8	10	240-290pcs	36
L-UD 80 100		100	8	10	260-350pcs	24
L-UD 80 120	120	8	10	280-380pcs	24	
L-UD 100 30	100	30	10	10	130-160pcs	48
L-UD 100 33		33	10	10	130-165pcs	48
L-UD 100 40		40	10	10	130-175pcs	48
L-UD 100 50		50	10	10	220-250pcs	48
L-UD 100 60		60	10	10	240-290pcs	32
L-UD 100 75		75	10	10	260-350pcs	24
L-UD 100 80		80	10	10	260-360pcs	24
L-UD 100 100		100	10	10	300-400pcs	24

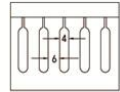
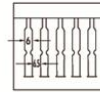
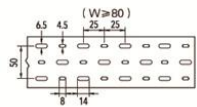
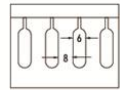
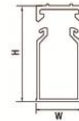
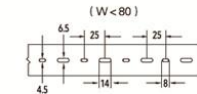

(H ≥ 80)

Model	Specification		Slot width mm	Sliver width mm	Wires to be Contained	Package meter
	Height(mm)	Width(mm)				
LVD 25 25	25	25	6	6.5	10-25pcs	100
LVD 35 35	35	35	4	6	20-25pcs	100
LVD 40 25	40	25	4	6	20-25pcs	100
LVD 40 30		30	4	6	35-40pcs	100
LVD 40 40		40	4	6	60-70pcs	100
LVD 40 50		50	4	6	50-70pcs	80
LVD 40 60		60	4	6	100-115pcs	64
LVD 40 80		80	4	6	120-135pcs	48
LVD 50 25		50	25	4	6	20-35pcs
LVD 50 35	35		4	6	40-60pcs	100
LVD 50 50	50		4	6	80-90pcs	80
LVD 50 80	80		4	6	160-180pcs	48
LVD 60 25	60		25	4	6	40-55pcs
LVD 60 30		30	4	6	40-65pcs	80
LVD 60 40		40	4	6	100-115pcs	64
LVD 60 60		60	4	6	120-135pcs	48
LVD 60 80		80	4	6	180-210pcs	36
LVD 60 100		100	4	6	230-250pcs	32
LVD 60 120		120	4	6	260-350pcs	24
LVD 80 25	80	25	4	6	100-120pcs	60
LVD 80 30		30	4	6	105-125pcs	60
LVD 80 35		35	4	6	110-130pcs	60
LVD 80 40		40	4	6	140-160pcs	48
LVD 80 45		45	4	6	140-165pcs	48
LVD 80 50		50	4	6	160-180pcs	48
LVD 80 60		60	4	6	180-210pcs	36
LVD 80 80		80	4	6	240-290pcs	36
LVD 80 100		100	4	6	260-350pcs	24
LVD 80 120		120	4	6	280-380pcs	24
LVD 100 30	100	30	6	8	130-160pcs	48
LVD 100 33		33	6	8	130-165pcs	48
LVD 100 40		40	6	8	130-175pcs	48
LVD 100 50		50	6	8	220-250pcs	48
LVD 100 60		60	6	8	240-290pcs	32
LVD 100 75		75	6	8	260-350pcs	24
LVD 100 80		80	6	8	260-360pcs	24
LVD 100 100		100	6	8	300-400pcs	24

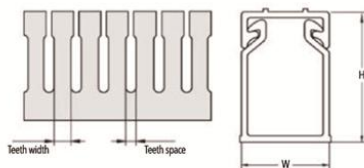

Wide slot/lifter Model No.	Dimension		Teeth space-Teeth with[mm]			Package [m]
	H[mm]	W[mm]	4-6	6-6	6-8	
KD 25 25	25	25	•			100
KD 30 20	30	20	•			100
KD 30 35	30	35	•			100
KD 30 30	30	30	•			100
KD 30 35	30	35	•			100
KD 35 35	35	35	•			100
KD 40 25	40	25	•			100
KD 40 40	40	40	•			100
KD 40 60	40	60	•			64
KD 40 80	40	80	•			48
KD 45 33	45	33	•			100
KD 45 45	45	45	•			80
KD 50 25	50	25	•			100
KD 50 35	50	35	•			100
KD 50 45	50	45	•			80
KD 50 50	50	50	•			80
KD 50 60	50	60	•			48
KD 50 80	50	80	•			48
KD 60 40	60	40	•			64
KD 60 60	60	60	•			48
KD 60 80	60	80	•			36
KD 65 33	65	33	•			80
KD 65 45	65	45	•			80
KD 65 65	65	65	•			48
KD 80 25	80	25	•		•	60
KD 80 35	80	35	•		•	60
KD 80 40	80	40	•		•	48
KD 80 45	80	45	•		•	48
KD 80 50	80	50	•		•	48
KD 80 60	80	60	•		•	36
KD 80 80	80	80	•		•	36
KD 80 100	80	100	•		•	24
KD 80 120	80	120	•		•	24
KD 100 35	100	35		•		48
KD 100 40	100	40		•		48
KD 100 50	100	50		•		48
KD 100 60	100	60		•		32
KD 100 80	100	80		•		24
KD 100 100	100	100		•		24
KD 100 120	100	120		•		24

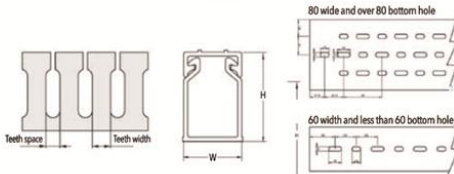

Material

- Made of hard PVC, certified by ROHS, free from harmful substances such as lead, low smoke, and environmentally friendly.
- Fire resistance rating:UL94V-0 flame retardant rating, good self extinguishing performance, and excellent insulation characteristics.

Structure

1. The groove body is formed by matching with the groove cover, which is easy to assemble and does not fall off, and the joint surface is smooth and does not harm hands;
2. The outlet holes on both sides of the slot body are symmetrical, ensuring a smooth and neat cross-section without damaging the wires.
3. Complete sizes and diverse side and installation hole designs for easy selection and wiring;
4. The unique marking line design on the slot cover can make the wiring identification clear, fast and beautiful. Color category: gray, (white, blue, black, etc. can be customized)
5. Working temperature: -20~+85 °C

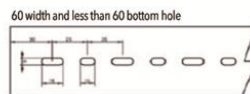
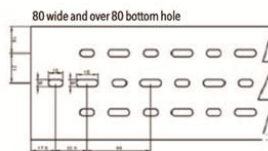
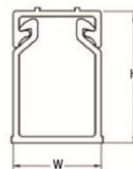
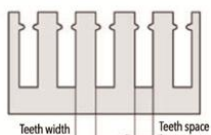
Wide slot/finger Model No.	Dimension		Teeth space-Teeth with[mm]			Package [m]
	H [mm]	W [mm]	6-8	8-10	10-10	
LD 50 25	50	25	●			100
LD 50 35	50	35	●			100
LD 50 45	50	45	●			80
LD 50 50	50	50	●			80
LD 50 60	50	60	●			48
LD 50 80	50	80	●			48
LD 60 40	60	40		●		64
LD 60 60	60	60		●		48
LD 60 80	60	80		●		36
LD 65 33	65	33		●		80
LD 65 45	65	45		●		80
LD 65 65	65	65		●		48
LD 80 25	80	25		●		60
LD 80 35	80	35		●		60
LD 80 40	80	40		●		48
LD 80 45	80	45		●		48
LD 80 50	80	50		●		48
LD 80 60	80	60		●		36
LD 80 80	80	80		●		36
LD 80 100	80	100		●		24
LD 80 120	80	120		●		24
LD 100 35	100	35			●	48
LD 100 40	100	40			●	48
LD 100 50	100	50			●	48
LD 100 60	100	60			●	32
LD 100 80	100	80			●	24
LD 100 100	100	100			●	24
LD 100 120	100	120			●	24
LD 100 140	100	140			●	16
LD 130 100	130	100			●	16



Wide slot /finger Model No.	Dimension		Teeth space-Teeth with[mm]			Package [m]
	H [mm]	W [mm]	4-6	6-8	8-10	
LFD 80 25	80	25			•	60
LFD 80 35	80	35			•	60
LFD 80 40	80	40			•	48
LFD 80 45	80	45			•	48
LFD 80 50	80	50			•	48
LFD 80 60	80	60			•	36
LFD 80 80	80	80			•	36
LFD 80 100	80	100			•	24
LFD 80 120	80	120			•	24
LFD 100 33	100	33			•	48
LFD 100 35	100	35			•	48
LFD 100 40	100	40			•	48
LFD 100 50	100	50			•	48
LFD 100 60	100	60			•	32
LFD 100 80	100	80			•	24
LFD 100 100	100	100			•	24
LFD 100 120	100	120			•	24

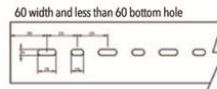
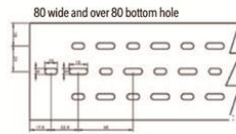
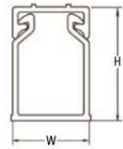
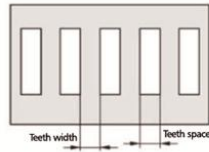

Wide slot /finger	Dimension		Teeth space-Teeth with [mm]			Package [m]
	Model No.	H [mm]	W [mm]	6-6	6-8	
KFD 60 40	60	40	•			64
KFD 60 60	60	60	•			48
KFD 60 80	60	80	•			36
KFD 100 30	100	35			•	48
KFD 100 40	100	40			•	48
KFD 100 50	100	50			•	48
KFD 100 60	100	60			•	36
KFD 100 80	100	80			•	24
KFD 100 100	100	100			•	24
KFD 100 120	100	120			•	24
KFD 100 140	100	140			•	24
KFD 150 100	150	100			•	16



Overview

LK - FLEX Duct is a unique product offering from LINKWELL, that is a flexible, resilient and efficient harnessing solution to your wiring needs. For wiring to cabinet doors, from control panels and for electronic equipment. For that part of the cable run that leans against the side of the control cabinet.

Performance

- Due to the flexibility of the trunking material, it is easy to add or remove individual cables.
- Keel trunking without slotted cover facilitates routing in tight spaces without the need for lashing straps.
- It can be used under extreme conditions (high temperature resistance up to 176 °C), and can also resist radiation in a nuclear environment in time.
- LF-FLEX has high mechanical strength and can withstand earthquakes, equipment falls, etc. When burning, it does not emit harmful and toxic gases, and only produces a small amount of smoke.
- The length of the trunking can be cut with scissors or props as required. When securing LK-FLEX with self-adhesive, make sure the surface is clean and tidy.

LK series

Flexible ducts self-adhesive

Material: polypropylene

Color: gray RAL 7030



Flexible trunking

Material: polypropylene RAL 7030 (gray)

Model	Dimension		
	Width (mm)	Height (mm)	Length (mm)
LK-20	17	25	50
LK-30	30	40	50

FD series

Flexible trunking

Material: NYLON66 (gray)

Model	Dimension		
	Width (mm)	Height (mm)	Length (mm)
FD-20	20.4	14.4	50
FD-30	29	24.9	50
FD-40	39	36	50



MKD series

Wide slot/finger Model No.	Dimension		Package meter
	Height (mm)	Width (mm)	
MKD 25 25	25	25	100
MKD 30 20	30	20	100
MKD 30 35	30	35	100
MKD 30 30	30	30	100
MKD 30 35	30	35	100
MKD 35 35	35	35	100
MKD 40 25	40	25	100
MKD 40 40	40	40	80
MKD 40 60	40	60	60
MKD 50 25	50	25	100
MKD 50 35	50	35	100
MKD 50 45	50	45	80
MKD 50 50	50	50	80
MKD 50 60	50	60	64
MKD 50 80	50	80	48
MKD 60 40	60	40	64
MKD 60 60	60	60	48
MKD 60 80	60	80	36
MKD 65 33	65	33	80
MKD 65 45	65	45	80
MKD 65 65	65	65	48
MKD 80 25	80	25	60
MKD 80 35	80	35	60
MKD 80 40	80	40	48
MKD 80 45	80	45	48
MKD 80 50	80	50	48
MKD 80 60	80	60	36
MKD 80 80	80	80	36
MKD 80 100	80	100	24
MKD 80 120	80	120	24
MKD 100 35	100	35	48
MKD 100 40	100	40	48
MKD 100 50	100	50	48
MKD 100 60	100	60	36
MKD 100 80	100	80	24
MKD 100 100	100	100	24
MKD 100 120	100	120	24
MKD 100 140	100	140	24
MKD 130 100	130	100	24
MKD 150 100	150	100	16

Cover



Model: KB-Width

Model No.	Model No.	Model No.	Model No.
KB-15	KB-35	KB-60	KB-120
KB-20	KB-40	KB-65	KB-140
KB-25	KB-45	KB-80	KB-535
KB-30	KB-50	KB-100	
KB-33	KB-55		

BK series

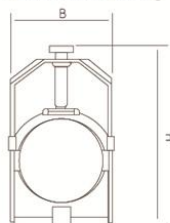

Dimensioned drawing



Model No.		Cable diameter Ø(mm)	Dimensional	
Galvanized steel	Stainless steel		B(mm)	H(mm)
BK 14	BK 14 E	6-12	21	70
BK 18	BK 18 E	12-18	23	70
BK 22	BK 22 E	18-22	27	75
BK 30	BK 30 E	22-30	39	85
BK 38	BK 38 E	30-38	45	90
BK 42	BK 42 E	38-42	47	95
BK 50	BK 50 E	42-50	57	120
BK 64	BK 64 E	50-64	70	130
BK 70	BK 70 E	64-72	77	165
BK 80	BK 80 E	72-82	87	183
BK 100	BK 100 E	95-102	108	217

UZ series



Fix the cable on the cable clamp orbit by plastic pad.

Model No.	Dimeter [mm]	Model No.	Dimeter [mm]
UZ6-12	6-12	UZ30-34	30-34
UZ12-16	12-16	UZ34-38	34-38
UZ14-18	14-18	UZ38-42	38-42
UZ18-22	18-22	UZ42-46	42-46
UZ22-26	22-26	UZ46-50	46-50
UZ26-30	26-30		

Type C guide(Used in conjunction with BK cable clamp)

BK cable clamp is used

IF001 series cabinet sealing strip

IF001-16x3 / 5 / 7

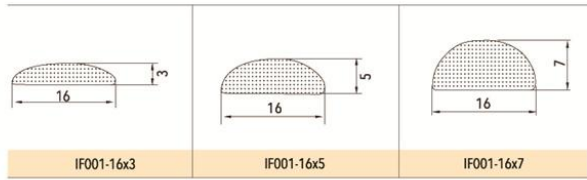
ENCLOSURE SERIES Cable fastener

P4319.090



- Used for professional, safe and reliable fixing of cables and pipes.
- Can be inserted into punched rails 23×23mm
- Can be screwed to the round holes in the cabinet
- Can be screwed onto punched rails and punched profiles
- Multiple fixings of different sizes can be fixed with only two screws to achieve parallel connection of the fixings.



Model No.	Suitable for cable diameter [mm]
P4319.090	6-9
P4319.120	9-12
P4319.160	12-16
P4319.200	16-20

TS series Din rail



The installing guide is designed according to the new Europe standard EN 50 022, EN 50 035, EN50 045. It has a precise height, strict tolerance, fine surface and good finish. The steel guide has been zinc-plated and yellow processed.

For the convenience of installing and making holes, there is a line printed on the center of guide which also exists on the aluminum and copper guide. Length and can be with round hole, long hole or trough.

Dimensioned

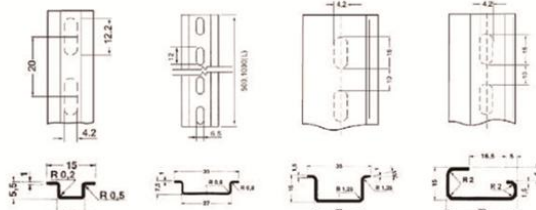

TS 15/5.5

TS 35/7.5

TS 35/15

TS 32



Product description

TS 15/5.5 According to 50 045-15×5mm
Made of steel, yellow, without hole length: 2m
NS 15/5.5 without hole

TS 35/7.5 According to EN 50 022-35X7.5mm
Made of steel, yellow, without hole length: 2m
TS 35/7.5 without hole

TS 35/15 According to EN 50 022-35X15mm
Made of steel, yellow, without hole length: 2m
TS 35/15 without hole

TS 32 According to EN 50 035-G 32
Made of steel, yellow, without hole length: 2m
TS 32 without hole



Aluminum Din rail and accessories



Aluminum DIN rail

AL 35/15 thickness : 1.5mm
AL 35/7.5 thickness : 1.1mm or 1.5mm
AL 30/15 thickness : 1mm or 2mm



DIN rail retainer TST2/TST3/TSTW

Thickness : 2mm

LKWC-001
LKWC-001 wiring duct cutter

Used to cut wiring duct and cover, Max available width:125mm

High strength cutting blade, anti-abrasion

High efficient, free of burrs after cutting

LKDC-002
LKDC-002 Standard Din Rail Cutter

Used for: Din rail 35(W)x7.5(H)x1.0(T) mm or 35(w)x15(H)x1.5(T)mm,customizable for other size. Din rail Use Method and Notes:

- Lift the handle and insert the guide rail that needs to be cut into the corresponding cavity gap. When inserting the guide rail, try to maintain a 90 degree angle with the cavity surface to allow the guide rail to pass smoothly. Press down on the handle with force, and the guide rail will be cut off.
- When cutting, try to choose a relatively flat work site, which can ensure that the bottom plate of the cutter is under stable force and also reduce the cutting pressure on the cutter cavity.

LKDC-003
LKDC-003 Bench Type Din Rail Cutter

This guide rail cutter needs to be installed on a workbench and comes with a measuring ruler. It can cut any size you need. The standard type cutter can cut specifications: 35 (W) × 7.5 (H) × 1.0 (T)mm , 35 (W) × 15 (H) × 1.5 (T)mm, if other specifications of guide rails need to be cut, they can be customized. Usage and precautions:

- Lift the handle, insert the Din Rail into the matching cavity, make it vertical to the cavity surface at the same time and Din Rail will go through,press the handle, Din Rail will be cut off.
- Choose the flat ground during the operation, it ensures the cutter base bear stress evenly and reduces the stress on cavity.
- This cutter needs to be installed in the workbench, which also makes cutting guide rail more relaxed, no longer need to bend over for a long time to work, humanized design.