

LINGTONG Lintel
Portable Display Solution

CHANGZHOU LINTEL DISPLAY CO., LTD

Add: No.333, Lingtong Industrial Zone, Changhong Road, Changzhou, Jiangsu, China

Tel: +86(0)519 68217886 +86(0)519 68217885

E-mail: marketing@lintel.com.cn

- www.linteldisplay.com -



**28 YEARS PROFESSIONAL
DISPLAY MANUFACTURER**

Pop Up Stand SEG Light Box Adjustable Frame EZ Tube Frame
Twister Tower Outdoor Display ...

**PORTABLE
DISPLAY SOLUTION**

2023.01 VERSION

HAND BOOK
PORTABLE DISPLAY SOLUTION

CONTENTS



Pop Up Stand
2-9



EZ Tube Frame
10-21



SEG Light Box
22-27



Adjustable Frame
28-31



Twister Tower
32-37



Outdoor Display
38-49



Promotion Range
50-65



Roll Up Stand
66-69



Pop Up Stand

Never stop designing and developing...

Small package, large display is the main character of the pop up stands. Stable structure and fantastic design makes it popular as a trade show backwall, promotion screen, conference backdrop etc.

Pop Up Stand



- Anodized aluminum frame that is quick and easy to set up
- Green locking arms to make it stable
- Graphic stays attached to frame with hook and loop webbing into bag
- Single-sided or double-sided as option
- Square or circle aluminum cross bars are available to choose



LT-09L2-A Square Tube Frame
LT-09L2-B Circle Tube Frame

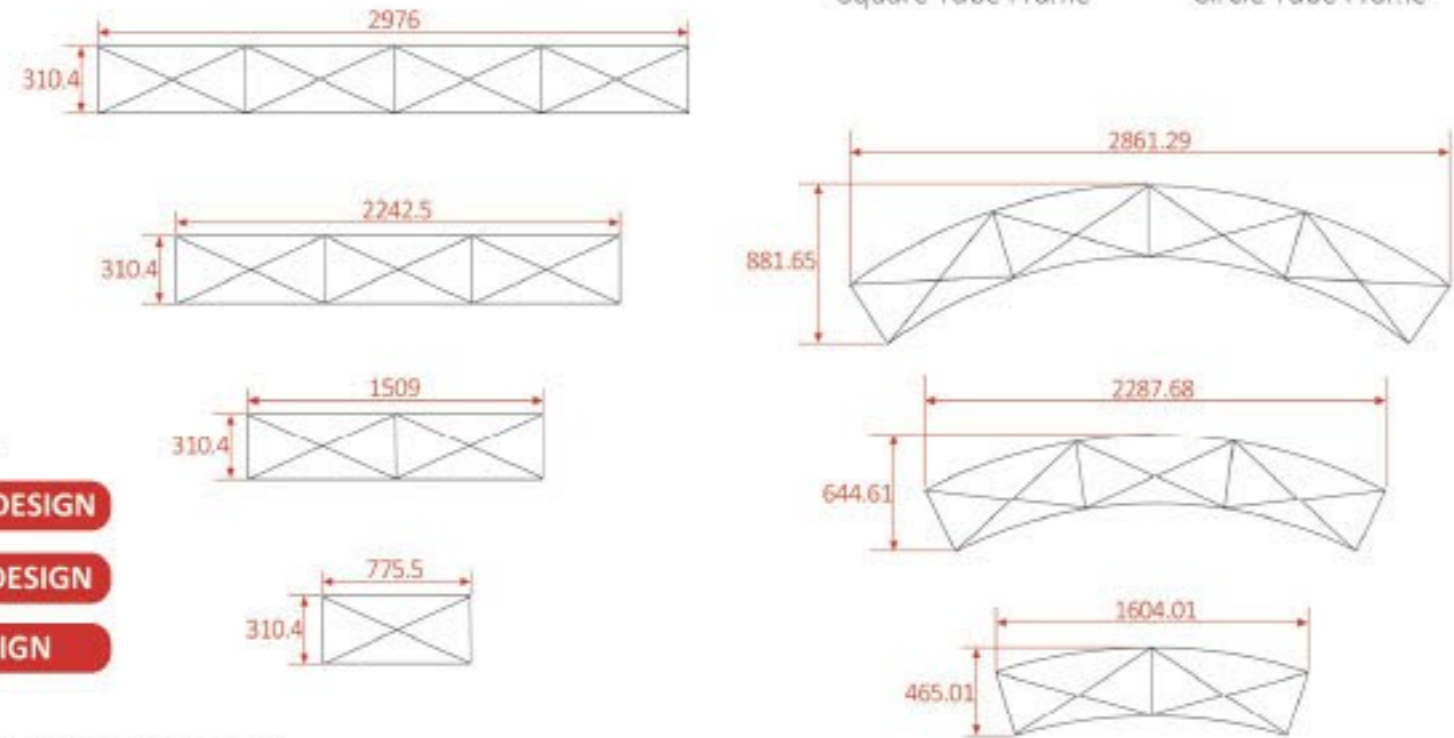

- Style Option:
- EUROPEAN DESIGN**
 - AMERICAN DESIGN**
 - ASIAN DESIGN**

LT-09L2-A Square Tube Frame

Size	3*3S	4*3S	3*3C	4*3C
Graphic Size	224.5*290cm	224.5*364cm	224.5*272cm	224.5*339cm
Packing Size	30*30*85cm	37*30*85cm	30*30*85cm	37*30*89cm
PC/CTN	1pc	1pc	1pc	1pc
N.W.	7.8kgs	10.5kgs	7.8kgs	10.5kgs
G.W.	10.3kgs	13.3kgs	10.3kgs	13.3kgs

LT-09L2-B Circle Tube Frame

Size	3*3S	4*3S	3*3C	4*3C
Graphic Size	224.5*290cm	224.5*364cm	224.5*272cm	224.5*339cm
Packing Size	30*30*85cm	37*30*85cm	30*30*85cm	37*30*89cm
PC/CTN	1pc	1pc	1pc	1pc
N.W.	6.5kgs	8.5kgs	6.5kgs	8.5kgs
G.W.	9.0kgs	11.3kgs	9.0kgs	11.3kgs

LT-09L2-A/B
Hook & Loop Webbing Fabric Option



LT-09L1-A Hook Fabric Option



Size	3*3/4*3
Graphic Size	73.35*73.35cm
Packing Size	30*30*85cm/37*30*85cm(Nylon bag)



Steel shelf or plastic shelf as option

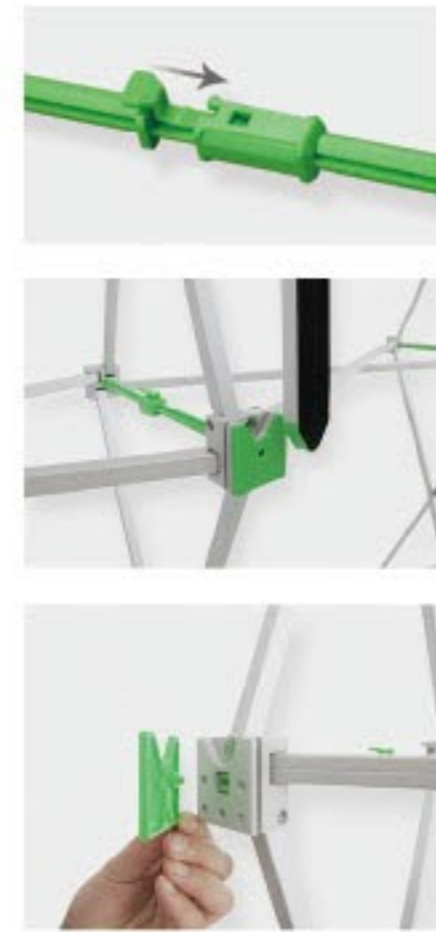

One structure could create endless possibilities for printing assembled.

Size	3*3S	4*3S	3*3C	4*3C
Graphic Size	330*224.3cm	403.4*224.3cm	311*224.3cm	378*224.3cm
Packing Size	71*41*100cm	71*41*100cm	71*41*100cm	71*41*100cm (YSX-001A)
	44*42*94cm	44*42*94cm	44*42*94cm	44*42*94cm (YSX-003A)

Pop Up Stand

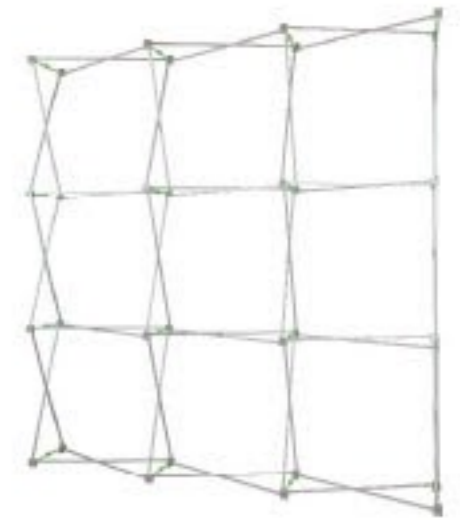

LT-09L-A
Magnetic PVC Graphic Option

Pop Up Stand



LT-09L4
Backlit structure

LED Single Backlit		
Size	1*3	2*3
Packing Size	16*16*75cm	30*16*75cm
PC/CTN	1pc	1pc
N.W.	2.5kgs	5.0kgs
G.W.	3.0kgs	6.0kgs



LED Backlit assemble
with plastic tension hook

Small frame, big display backwall

LED light strip installation,
clip and fixed



LT-09L4
Sided Light Structure



Double-groove Bar Structure

New



LT-09L5

*One structure only,
but creates changeable design
and surprising styles!*

Size	3*3S	4*3S	3*3C	4*3C
Graphic Size	/	/	/	/
Packing Size	45*22*88cm	45*22*88cm	45*22*88cm	45*22*88cm
PC/CTN	1pc	1pc	1pc	1pc
N.W.	15.4kgs	19.7kgs	16.5kgs	21.1kgs
G.W.	17.9kgs	22.2kgs	19.0kgs	23.6kgs



LT-09L4				
Size	3*3S	4*3S	3*3C	4*3C
Graphic Size	2-224*224cm 2-35*224cm	2-297.2*224cm 2-35*224cm	201.7/249.7*224cm 2-35*224cm	267.5/332.2*224cm 2-35*224cm
Packing Size	27*21*88cm	31*21*88cm	35*22*88cm	35*22*88cm
PC/CTN	1pc	1pc	1pc	1pc
N.W. (only frame, without LED backlit)	12.4kgs	13.6kgs	16.9kgs	16.9kgs
G.W. (only frame, without LED backlit)	14.9kgs	17.9kgs	16.1kgs	19.4kgs

Pop Up Stand

- Lightweight anodized aluminum frame that is quick and easy to set up
- Green locking arms to make it stable
- Separate plastic channel bars connect to frame and fit fabric graphics in
- Fabric graphic creates clean, straight edges, smooth effect
- Carry bag included, trolley bag as an optional upgrade



LT-09L3-A
SEG Option



-SEG POP UP ACCESSORY



LT-09L3-A				
Size	3*3S	4*3S	3*3C	4*3C
Graphic Size	2-224*224cm 2-35*224cm	2-297.2*224cm 2-35*224cm	201.7/249.7*224cm 2-35*224cm	267.5/332.2*224cm 2-35*224cm
Packing Size	27*21*88cm	31*21*88cm	35*22*88cm	35*22*88cm
PC/CTN	1pc	1pc	1pc	1pc
N.W. (only frame, without LED backlit)	12.4kgs	15.4kgs	13.6kgs	16.9kgs
G.W. (only frame, without LED backlit)	14.9kgs	17.9kgs	16.1kgs	19.4kgs

Pop Up Stand

Classical style forever, incredibly easy, two minutes set-up without any tool

- Incredibly easy, two minutes set-up without any tool
- Adjustable leveling feet to keep much more stable
- More customized sizes are available
- Graphic stays attached to frame with hook and loop webbing into bag
- Large backdrop frame just need to put into one nylon bag and carton only



Size	3*3S	4*3S	3*3C	4*3C
Graphic Size	225*225cm	299*225cm	209.4*225cm	277.4*225cm
Packing Size	2-32.5*225cm	2-32.5*225cm	2-32.5*225cm	2-32.5*225cm
PC/CTN	1pc	1pc	1pc	1pc
N.W.	7.5kgs	9.3kgs	7.5kgs	9.3kgs
G.W.	10.0kgs	12.1kgs	10.0kgs	12.1kgs

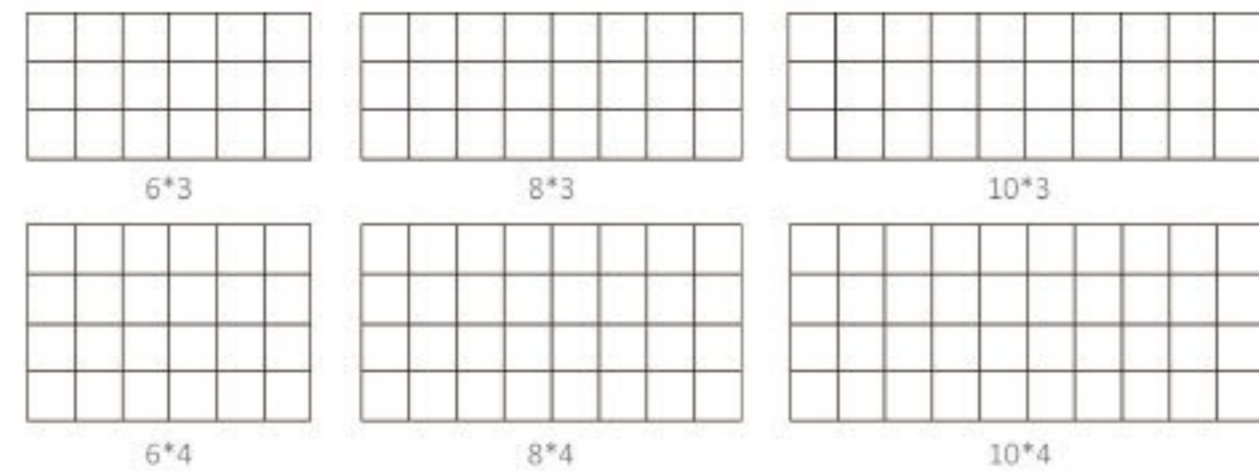

Pop Up Counter



LT-09B7-A Straight

	SEG Counter (with Shelf)	SEG Counter (with LED Backlit)
Size	105*37.8*105cm	105*37.8*105cm
Graphic Size	105.1*105.1cm 2-35.4*105.1cm	105.1*105.1cm 2-35.4*105.1cm
Packing Size	49*21.5*120cm	49*21.5*120cm
PC/CTN	1pc	1pc
N.W.	12.8kgs	11.0kgs
G.W.	14.8kgs	13.0kgs



LT-09B4

Size	70*80cm
Graphic Size	Dia70cm
PC/CTN	71*71*14cm



LT-09B7-B Curved

	SEG Counter (with Shelf)	SEG Counter (with LED Backlit)
Size	118.8*105.1cm 2-35.4*105.1cm	116.6*37.8*105cm
Graphic Size	105.1*105.1cm 2-35.4*105.1cm	118.8*105.1cm 95*105.1cm 2-35.4*105.1cm
Packing Size	49*21.5*120cm	49*21.5*120cm (with shelf)
PC/CTN	1pc	1pc
N.W.	13.3kgs	11.5kgs
G.W.	15.3kgs	13.5kgs



Tips: More color option of top board are available, white, yellow, black and so on.



Panel lock as option



LT-09B Velcro Counter(With Shelf)

Size	90*40*86cm
Graphic Size	152*85cm
Packing Size	45*21.5*93cm
PC/CTN	1pc
N.W.	7.0kgs
G.W.	9.0kgs

Pop Up Stand Accessory



YSX-001A Hard Case
Packing Size: 71*41*100cm

YSX-002A Hard Case
Packing Size: 45*40*100cm



YSX-003A Trolley Nylon Bag
Packing Size: 44*42*94cm

YSX-004A Trolley Nylon Bag
Packing Size: 42*43*95cm



150W

LT-D2 Halogen Light
Box Size: 62*18*7cm (2pcs)



9W

LT-D15 LED light
Box Size: 63*18*7cm (2pcs)



45W

LT-D19 LED Light
Box Size: 64*23*8 cm (2pcs)



12W

LT-D20 LED Light
Box Size: 53*15*6 cm (2pcs)



20W

LT-D21 LED Light
Box Size: 63*15*6 cm (2pcs)

Hot



EZ Tube Frame

Never stop designing and developing...

Fabric display usually gives people high quality impression with its fantastic version. It's light, portable and small package. Fabric system is becoming more and more popular in the market.

EZ Tube Frame



LT-24Q1



Size	10' * 8' / 8' * 8' / 20' * 8'
Graphic Size	305 * 244cm / 245 * 244cm / 611 * 244cm
Packing Size	23 * 15 * 105cm / 23 * 15 * 92cm / 35 * 17 * 105cm
PC/CTN	1pc



- Anodized aluminium tube frames
- Tubes are connected with bungee cord
- Easy assemble with snap pin structure
- with stable and sturdy aluminium feet
- Simple symbol as installation instruction
- Packs into nylon bag



Exhibit Single Backwall

Customizd sizes are available



LT-24



LT-24C



LT-24K



LT-24L

	LT-24	LT-24C	LT-24K	LT-24L	LT-24H2	LT-24H1
Size	10' * 8' Horizontal	10' * 8'	10' * 8'	10' * 8'	300 * 150cm	300 * 150cm
Graphic Size	316 * 228cm	302 * 238cm	311 * 241cm	329 * 246.8cm	461 * 152cm	468.5 * 152cm
Packing Size	30 * 18 * 96cm	30 * 23 * 103cm	38 * 23 * 108cm	38 * 23 * 93cm	23 * 23 * 108cm	23 * 23 * 108cm
PC/CTN	1pc	1pc	1pc	1pc	1pc	1pc



LT-24H2



LT-24H1

EZ Tube Frame

EZ Tube Frame

EZ Tube Frame

POWER OFF

POWER ON

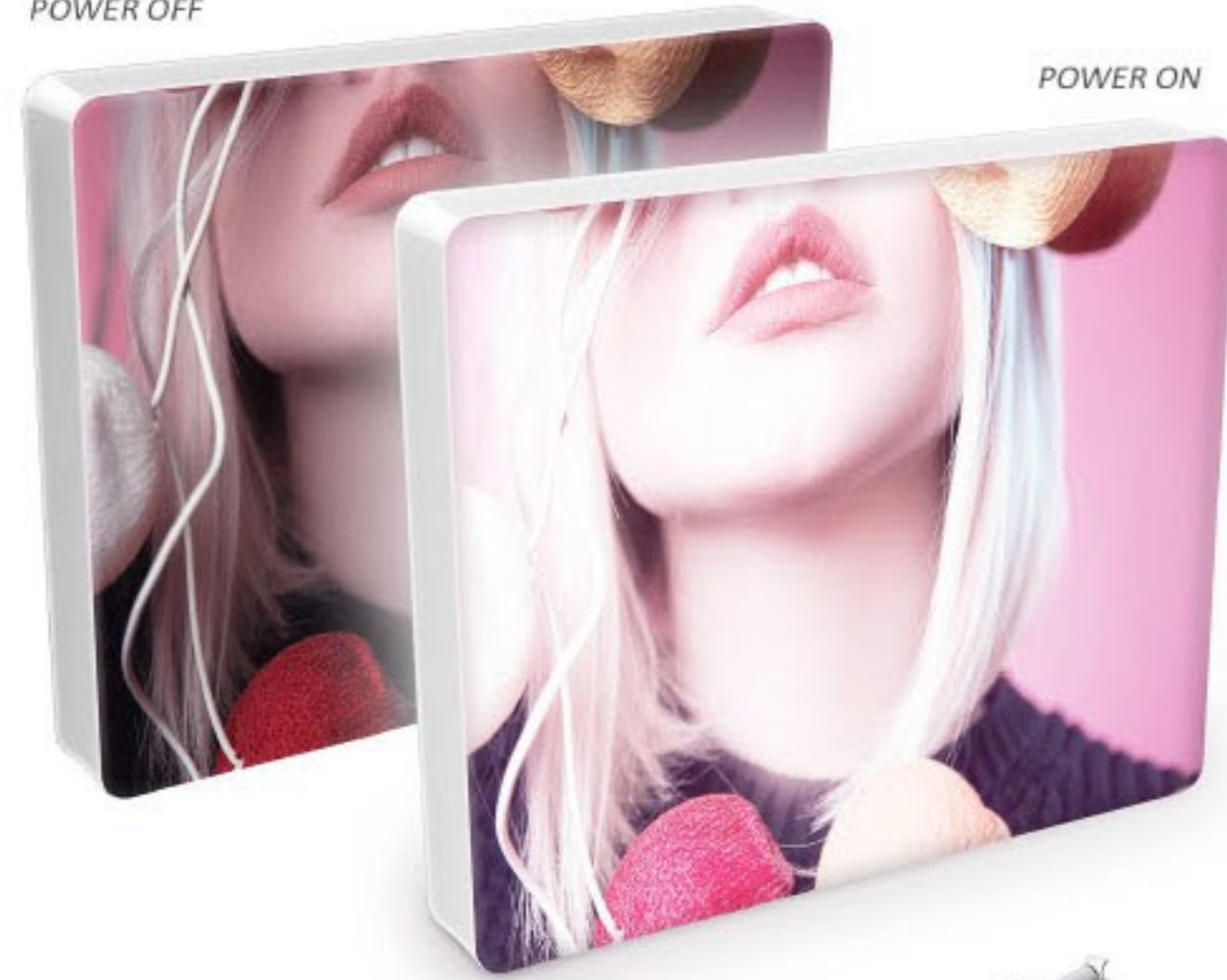

- Anodized aluminium tube frames
- Tubes are connected with bungee cord
- Easy assemble with snap pin structure
- With or without LED light inside as large backdrop design
- Simple symbol as installation instruction
- Packs into nylon bag



LT-24E



Size	10'8" *1.31'	10'10" *1.31'	15'10" *1.31'	20'10" *1.31'
Graphic Size	2-306.8*245.8cm 1-1082*42cm	2-306.8*306.8cm 1-1204*42cm	2-459.2*306.8cm 1-1509*42cm	2-611.6*306.8cm 1-1814*42cm
Packing Size	35*23*118cm	35*23*128cm	44*32*128cm	44*32*128cm
PC/CTN	1pc	1pc	1pc	1pc

EZ Tube Frame

Exhibit Multi-Backwall



LT-24Q2 25mm/32mm tube sizes are available for all standard sizes

	LT-24Q2	LT-24X2	LT-24A4	LT-24A2	LT-24A1
Size	80*200cm / 80*230cm	85*243.8cm	120*216cm	88*200cm	80*200cm
Graphic Size	82*197.2cm / 82*227.2cm	88*385cm	124*292.5cm	88*203cm	88*203cm
Packing Size	25*8*84cm / 25*8*84cm	51*23*90cm	38*13*98cm	38*13*78cm	38*13*78cm
PC/CTN	1pc / 1pc	1pc	1pc	1pc	1pc

EZ Tube Frame

Retail display system show more styles and functions in stores, shopping malls and markets, modular assembly, no tools, quick build up and nylon carry bag.

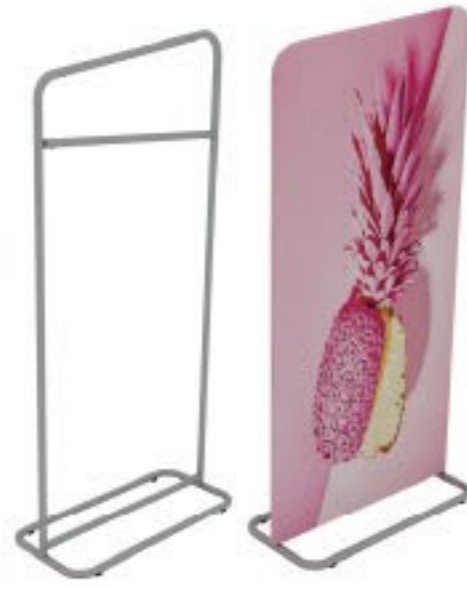

EZ Tube Frame

Arch Gate



Arches tube systems create a fantastic space for your tradeshow exhibits or events.

LT-24G1 Singular Arch

Size	400*300cm
Graphic Size	840*118cm
Packing Size	45*33*105cm
PC/CTN	1pc



- Anodized aluminium tube frames
- Tubes are connected with bungee cord
- Easy assemble with snap pin structure
- With stable and sturdy aluminium feet
- Simple symbol as installation instruction
- Fabric printing is easy to zip closed
- Packs into nylon bag

LT-24G6 Square Arch

Size	240*100*230cm
Graphic Size	700*100cm
Packing Size	27*27*112cm
PC/CTN	1pc



LT-24G5 Round Arch

Size	600*100*400cm
Graphic Size	942*100cm
Packing Size	36*25*123cm
PC/CTN	1pc

EZ Tube Frame

Counter Display



Size	97.2*40*100cm	80*33*100cm	60*60*102cm	156*50*100cm	153*64.8*100cm
Graphic Size	256.6*107cm	189.2*104cm	193*106cm	407.4*107cm	368*107cm
Packing Size	45*12*103cm	38*12*86cm	65*14*65cm	55*12*162cm	159*12*70cm
G.W.	19.6kgs	13.3kgs	12.0kgs	32.0kgs	33.2kgs
PC/CTN	1pc	1pc	1pc	1pc	1pc



Size	68*33*100cm
Graphic Size	104*176cm
Packing Size	38*12*74cm
PC/CTN	1pc



Size	6' Header Kits	6' Short Wall Kits	6' Tall Wall Kits
Graphic Size	74"W*43" or 67.5"H/74"W*18"H	74"W*43" or 67.5"H/74"W*43.25"H	74"W*67.5"H/74"W*67.75"H
Packing Size	25*8*103cm	25*8*103cm	25*8*103cm
PC/CTN	1pc	1pc	1pc
G.W.	2.1kgs	2.1kgs	2.5kgs
N.W.	1.5kgs	1.5kgs	1.9kgs

Choose one of three styles

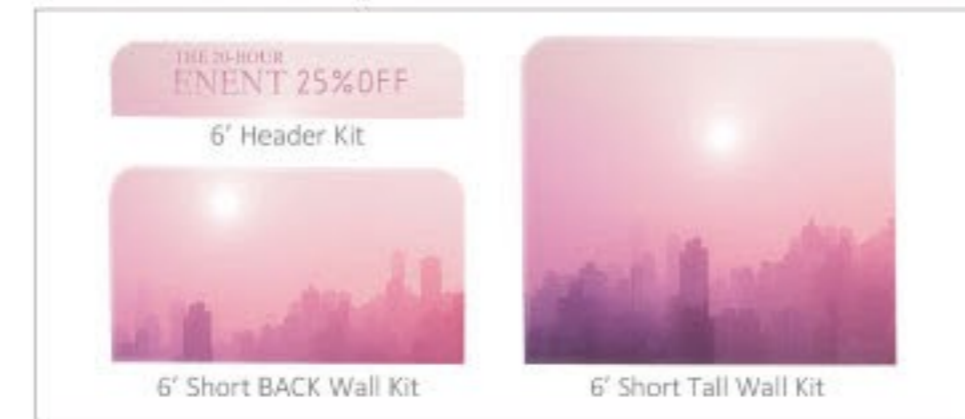

Hanging Banner

Tips: More other sizes and styles are available.

- Fabric hanging structures are economy, strong but lightweight system
- Tubes are connected with bungee cord
- Easy assemble with snap pin structure
- With many different sizes and styles for choice
- Steel eyebolts
- Nylon bag packing



LT-24D5



LT-24D10



LT-24D



LT-24D4



LT-24D7



LT-24D12

	LT-24D	LT-24D5	LT-24D10	LT-24D4	LT-24D7	LT-24D12
Size	8'2'	8'2'	8'2'	8'6'2'	8'6'2'	8'6'2'
Graphic Size	769*63cm	736.2*63cm	243.8*61cm	769*63cm	736.2*63cm	1223*63cm
Packing Size	36*26*105m	31*23*88m	31*23*89cm	36*26*105cm	31*23*88cm	35*23*88cm
G.W.	12.2kgs	10.6kgs	12.6kgs	11.7kgs	10.0kgs	15.5kgs
PC/CTN	1pc	1pc	1pc	1pc	1pc	1pc

Cube hanging banner can meet different size requirements.

EZ Tube Frame



EZ Modular

Accessories Series

EZ Modular

EZ Tube Frame

The Whole EZ Modular system included the parts as below, it can be optional to set up the whole booth as your design

- 1) A/B/C/D/G series single stand with different shape
- 2) G series in Arch shape
- 3) general use aluminum base
- 4) plastic connectors
- 5) LED arm lights
- 6) Shelves
- 7) Slot panels
- 8) TV supporting rack

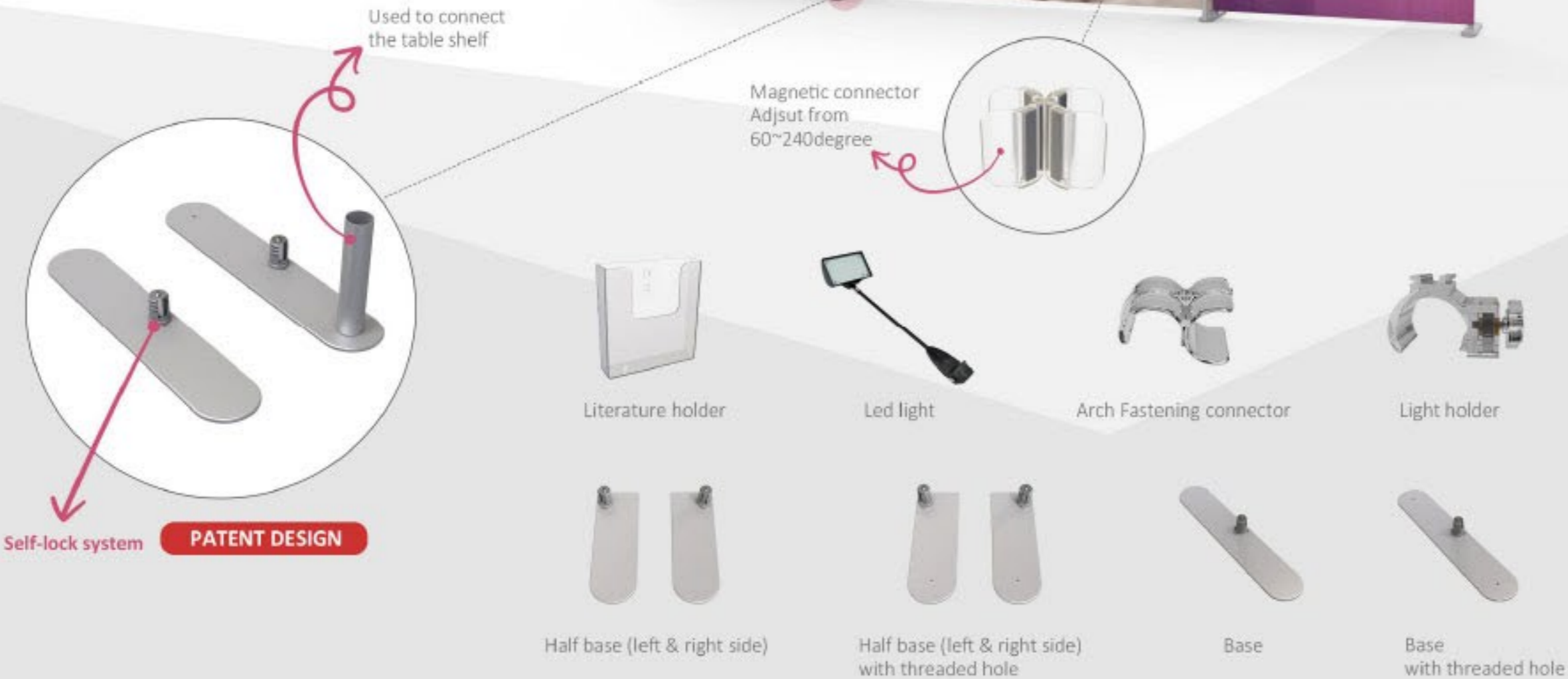

Standard size A series (size unit:mm)



Standard size B series (size unit:mm)



Standard size C series (size unit:mm)



Standard size D series (size unit:mm)



Standard size G series (size unit:mm)



EZ Modular



LT-24ZH-C4A4



LT-24ZH-C5A4C4



LT-24ZH-A2C4C4A2



LT-24ZH-B4D2B4



LT-24ZH-C5A4



LT-24ZH-C5A2G3



LT-24ZH-D2A4D2



LT-24ZH-B2A2D4



LT-24ZH-D2A6D2



LT-24ZH-C2A4



LT-24ZH-C2A2



LT-24ZH-D4D2



LT-24ZH-B2D5B2



LT-24ZH-C2C5C2G3



LT-24ZH-A2C5



LT-24ZH-B4B4



LT-24ZH-A2B5D5



LT-24ZH-A4A6C2A6A4



LT-24ZH-C5C1C5G3



LT-24ZH-C2A6



LT-24ZH-C2A2G3



LT-24ZH-A5B5D5



LT-24ZH-A5A6C5A6A5



LT-24ZH-C2C1C2G3



LT-24ZH-C5A6



LT-24ZH-C4A4D5



LT-24ZH-A6B2D2



LT-24ZH-D5A6D5



LT-24ZH-B4D1B4G3



Light Box

Never stop designing and developing...

Super shiny light boxes with graphics make your event unique and attractive. Free standing, wall mounted, ceiling mounted, dynamic, those different kinds of light boxes can meet with customized demands for every events.

120mm SEGPro Light Box

No tools / Modular style/ Double side/ Carry bag



LT-PLF120 100x200cm

Hot

Patent Design



LT-PLF120 300x250cm



LT-PLF120 Plus
300x400cm / 300x500cm

Tips: more large sizes for width are 4m, 5m, 6m

Size	100*250cm	200*250cm	300*250cm	300*400cm
Packing Size	127*16*47cm	127*21*47cm	127*25.5*47cm	47*32*107cm*3
N.W.	13.6kgs	18.7kgs	23.0kgs	51.0kgs
G.W.	16.5kgs	22.5kgs	27.5kgs	55.0kgs
PC/CTN	1pc	1pc	1pc	1/3pcs

Optional Package:



EPE Nylon Bag



Wheeled Hard Case



850+850 Combination
850+1000 Combination
1000+1000 Combination

Size	85*250cm	100*250cm
Packing Size	127*16*52cm	127*16*52mm
N.W.	12.9kgs	13.4kgs
G.W.	16.1kgs	16.6kgs
PC/CTN	1pc	1pc

LT-PLF120-A Counter

Size	100*100cm
Packing Size	107*19*42mm
N.W.	7.9kgs
G.W.	10.2kgs
PC/CTN	1pc



LT-PLF120 Curved

120mm SEGPro Light Box

Functional Accessories

Single light boxes combine into different booth styles, to meet 3*3m, 3*6m, 3*9m, 6*6m and more sizes needed, no tools, modular build up and carry bag. Easy, fast and safe!



Module Joint



Multi-Angle Part -45°/60°/90°



Brackets with shelf



Brackets with rail

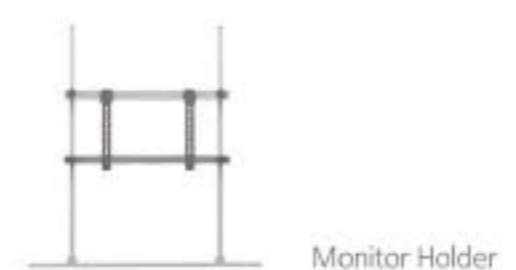

Monitor Holder



Combined Booth Style



85mm SEGPro Light Box

-The standard 60/85mm light box can be combined with magnetic .
 -It is more convenient and stable to combine the multi-single light box to be large background.
 -The joint line is extremely neat and non-visible.

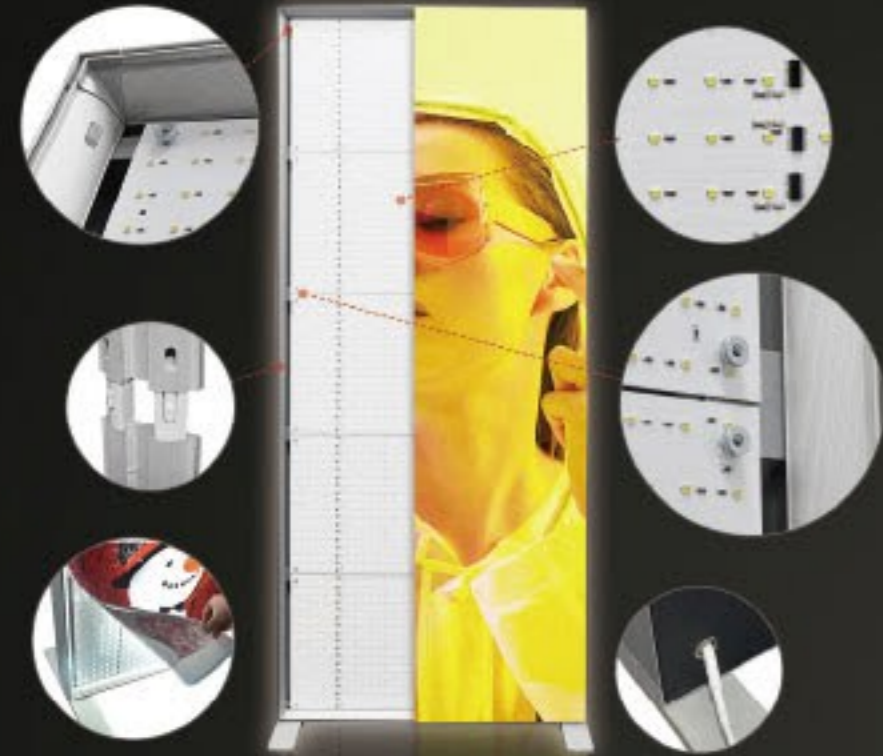

LT-ALF85 Dynamic



LT-ALF85



Power on by wireless



Rotated feet



Description :

The dynamic light box is upgrade from static display of single side backlit light to dynamic animation display . It is more vivid and easy eye catching when advertising . Animation can be programmed and replaced, internal memory card can store multiple animation programs,animation can be switched according to different scenes.

Size	85*200cm	85*161cm	85*122cm	85*83cm
Packing Size	112*47*20cm	94.5*47*20cm	94.5*47*20cm	94.5*47*20cm
N.W.	15.4kgs	12.8kgs	10.2kgs	7.6kgs
G.W.	21.7kgs	19.1kgs	16.5kgs	13.9kgs
PC/CTN	1pc	1pc	1pc	1pc



85mm SEGPro Light Box

Lightbox frame waterproofing grade: IP54
 Battery waterproofing grade: IP67



LT-ALF85-T2

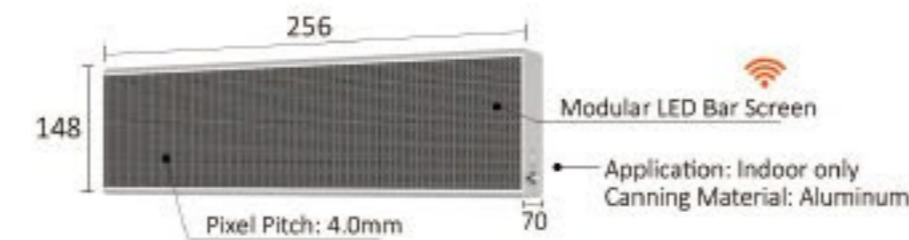

SCREEN LT-LEDPS3 LED MODULAR



LT-ALF85-T3



LT-ALF85-T4

Size	60*102.4cm	85*102.4cm	100*102.4cm
Packing Size	110*38*12cm	110*38*12cm	110*38*12cm
	80*18*50cm	98*22*63cm	98*22*63cm
N.W.	12.5kgs	15.5kgs	16.5kgs
G.W.	14kgs	17kgs	18kgs
PC/CTN	1/2pcs	1/2pcs	1/2pcs

Standard package way is cardboard, another option is nylon case.

	LT-ALF85-T2			LT-ALF85-T3		
Size	60*160cm	85*200cm	100*200cm	60*160cm	85*200cm	100*200cm
Packing Size	110*38*12cm/44*12*64cm	110*38*12cm/44*12*89cm	110*38*12cm/44*12*104cm	110*38*12cm/44*12*64cm	110*38*12cm/44*12*89cm	110*38*12cm/44*12*104cm
N.W.	7kgs	10kgs	11kgs	10kgs	17kgs	17kgs
G.W.	8kgs	11.5kgs	12.5kgs	11kgs	18.5kgs	18.5kgs
PC/CTN	1/2pcs	1/2pcs	1/2pcs	1/2pcs	1/2pcs	1/2pcs

60mm SEGPro Light Box

- The 60mm aluminum light box is single sided design .
- It can be used as wall amount design and free standing design .
- The LED lights are fixed on the backside fabric which can be folded like curtain .
- Quite easy for packing and transportation .



Ceiling light box



Wall mounted Light Box



LT-ALF60

Size	85*200cm
Packing Size	112*11.5*30cm
PC/CTN	1pc
N.W.	6.0kgs
G.W	6.84kgs



Adjustable Frame

Never stop designing and developing...

It used widely for display in tradeshow backdrop, conference backwall or space partition. Quick installment, limited area, save much more time and labor, and combined into different shapes.

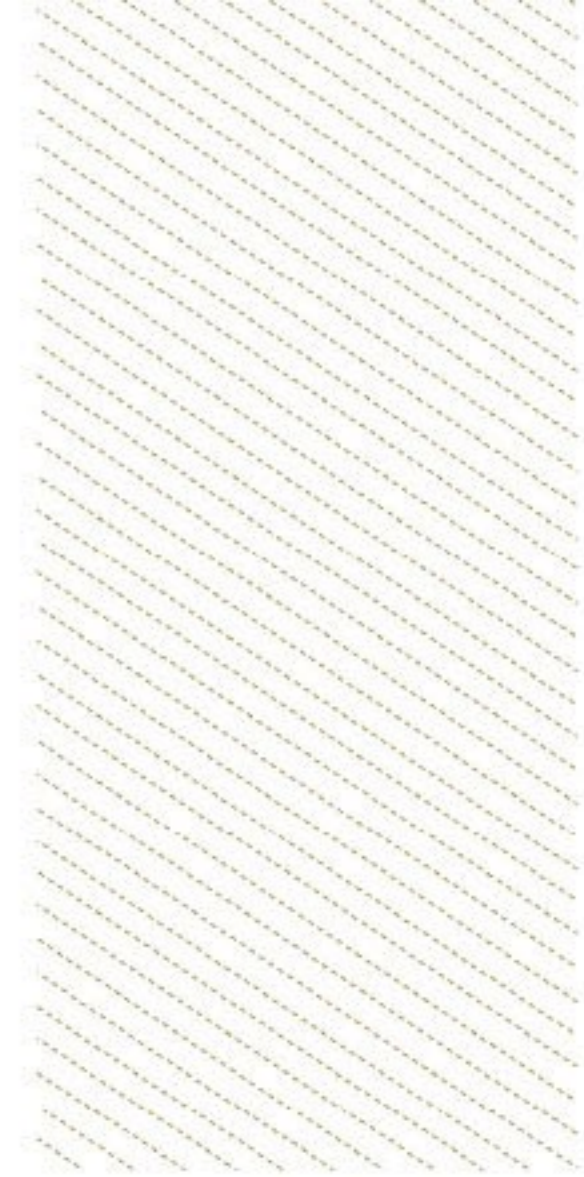

Adjustable Frame



LT-21

Anodized aluminum frame, **luxury** models
 $\varnothing 38, \varnothing 34, \varnothing 30$ as the vertical adjustable beam size
 $\varnothing 34, \varnothing 30$ as the horizontal adjustable beam size
 Zinc Alloy Bolt for locking, for large size without support pole
 Nylon padded bag for packing

	LT-21	LT-21-T1
Size	(W)140~315*(H)110~240cm	(W)147~315*(H)110~240cm
Graphic Size	(w)140~315*(H)110~240cm	(w)147~315*(H)110~240cm
Packing Size	102*10*24cm	102*10*24cm
PC/CTN	1pc	1pc
N.W.	6.3kgs	6.0kgs
G.W.	8.3kgs	7.4kgs

Upgraded Telescopic Backdrop Display Stand



LT-21-T1 Hot

-Middle of Support Pole as Accessory Option
 -Supporting pole at backside, no affect on the whole graphic version



Adjustable Frame



LT-21A

Size	(W)147~360*(H)107~360cm
Graphic Size	(w)147~360*(H)107~360cm
Packing Size	38*12*102cm
PC/CTN	1pc
N.W.	11.3kgs
G.W.	13.5kgs



Anodized aluminum frame, **economic** models
 $\varnothing 26, \varnothing 22, \varnothing 16$ as the vertical adjustable beam size
 $\varnothing 22, \varnothing 16$ as the horizontal adjustable beam size
 Zinc Alloy Bolt for locking, for large size need support pole in middle
 Nylon single bag for packing



LT-21S

Size	(W)140~315*(H)110~240cm
Graphic Size	(w)140~315*(H)110~240cm
Packing Size	102*10*20cm
N.W.	5.1kgs
G.W.	6.2kgs

Adjustable Frame



Adjustable frames with multi-angle parts has an enormous application range, such as exhibition events, activity backdrop, partition wall and so on. Typical advantage is adjustable, portable, collapsible, stable, convenient and large-format printing. Easy to install and the angle could be modulated freely.



Twister Tower

Never stop designing and developing...

This design was inspired by the movement of a spiral. Just turn the unit up with hands and there is stands, same way to tear down, very amazing and magical structure, widely used for shopping mall, store and promotion activity.

Twister Tower



LT-07-T



- Anodized aluminum frame makes it an elegant trade show display solution
- Collapsible display case with self-locking system
- Complete with PVC panels, without any magnetic tape
- Can be customised by replacing PET panels with printed graphics
- Provide a 3W or 15W LED light to attract attention and show your products



15W or 3W LED Light

Size	5-Dia50*206cm	6-Dia40*204cm
Graphic Size	16-39.5*50.6cm	20-31*40cm
Packing Size	61*23*61cm	49*27*49cm
PC/CTN	1pc	1pc
N.W.	19.0kgs	18.0kgs
G.W	21.0kgs	20.0kgs

Nylon bag
or Trolley Bag as option



Color Option



No Magnetic Stripe
1.0mm PVC Panel

Twister Tower sets up and folds up in less than a minute, without any tool



LT-07D

Size	5-Dia50*206cm
Graphic Size	16-37.0*50.5cm
Packing Size	61*23*61cm
PC/CTN	1pc
N.W.	18.3kgs
G.W	20.3kgs



Need Panels with magnetic stripe on LT-07C



Color Option

Size	5-Dia50*206cm	6-Dia40*204cm
Graphic Size	8-39.5*50.6cm; 4-60*50.6cm	10-31*40cm; 5-50*40cm
Packing Size	61*23*61cm	49*27*49cm
PC/CTN	1pc	1pc
N.W.	16.0kgs	15.0kgs
G.W	18.0kgs	17.0kgs



LT-07C

Twister Counter



LT-07B1-T

	LT-07B1-T	LT-07B2-T
Size	140*50*85.6cm	140*50*85.6cm
Graphic Size	74*80cm	12-31*40cm
Packing Size	53*30*64cm; +15*88	53*30*64cm
PC/CTN	1pc	1pc
N.W.	21.0kgs	22.3kgs
G.W	22.5kgs	25.0kgs

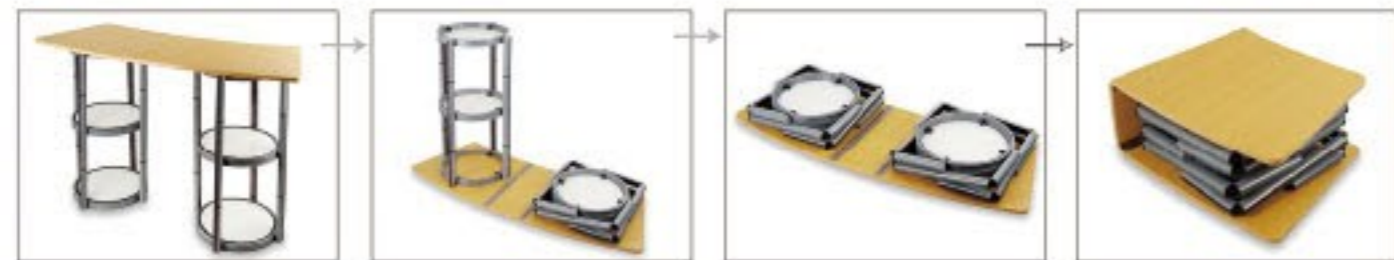

LT-07B2-T

Twister Counter sets up and folds up in less than a minute, without any tool

- Aluminum frame with powder coated finish
- Collapsible display case with self-locking system
- Complete with PVC panels, without any magnetic tape
- Can be customised by replacing PET panels with printed graphics
- Provide a top board, with many different color to choose

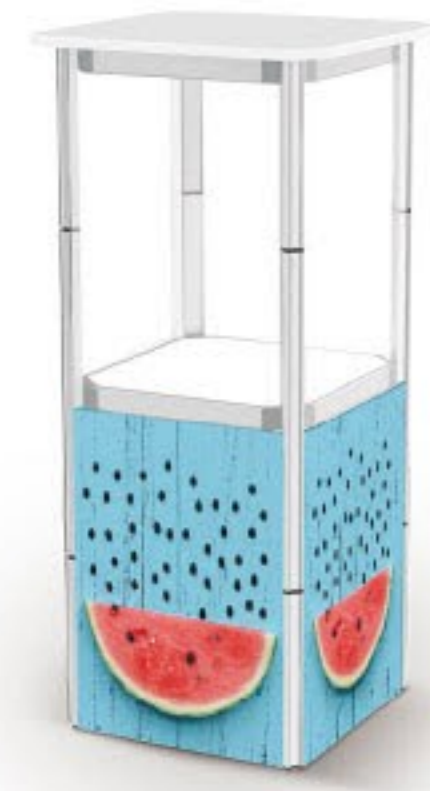

LT-07D-A



	LT-07D-A	LT-07A-T
Size	3-□50*106cm	3-Dia50*106cm
Graphic Size	6-□37.0*50.5cm	6-39.5*50.6cm
Packing Size	63*18*63cm	61*18*61cm
PC/CTN	1pc	1pc
N.W.	10.9kgs	12.5kgs
G.W	12.9kgs	14.5kgs



LT-07A-T

Twister Tower



LT-07ZH-TR-0015

Twister tower display booth solution, with twister tower and tube fabric frame as the main structure, decorated with lights, portable, convenient, stable and modular. This modular stand designs are flexible, re-configurable and re-usable. Graphics can also be updated to give your existing stand a fresh new look if required.

DIY designs based on this booth.
Buy 1 booth, to create more other different booths.

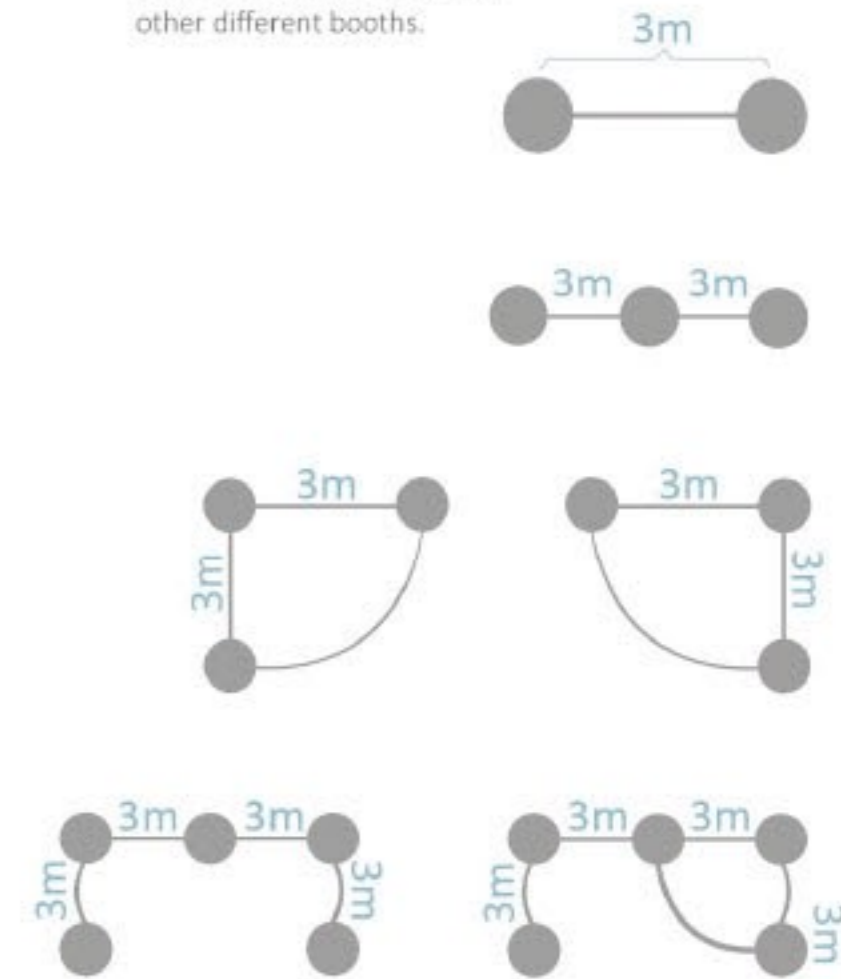

LT-07ZH-TR-012



LT-07ZH-TR-004



LT-07ZH-TR-017



LT-07ZH-TR-014



LT-07ZH-TR-019



Twister Tower Trade Show Booth

The backwall is optional with tube frames or SEG backlit light boxes

- FAST SET UP
- DOUBLE SIDE
- NO TOOLS
- SAVE SPACE
- CARRY BAG
- MODULAR STYLE

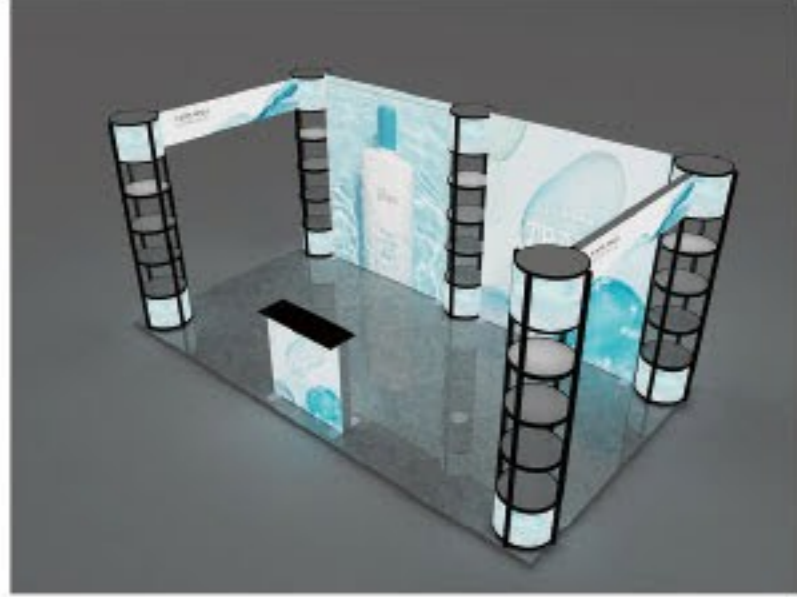

LT-07ZHP120-001

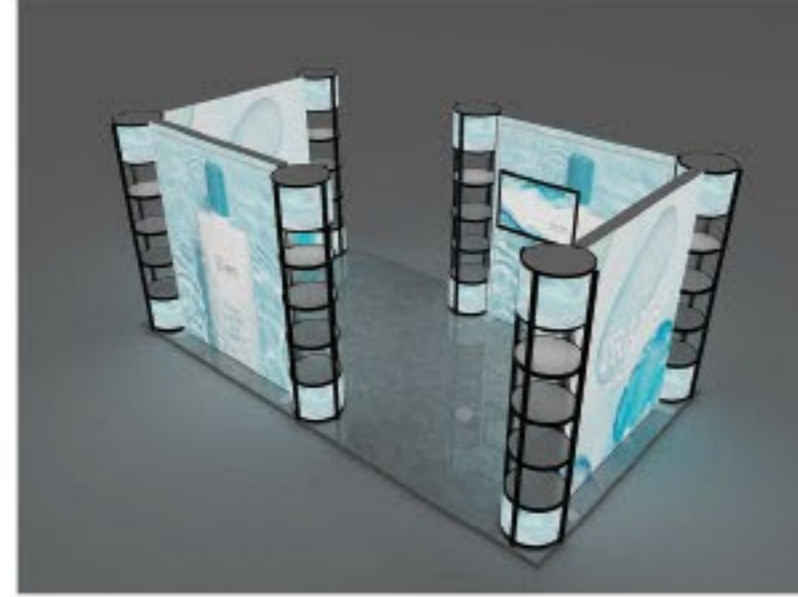

LT-07ZHP120-002



LT-07ZHP120-003

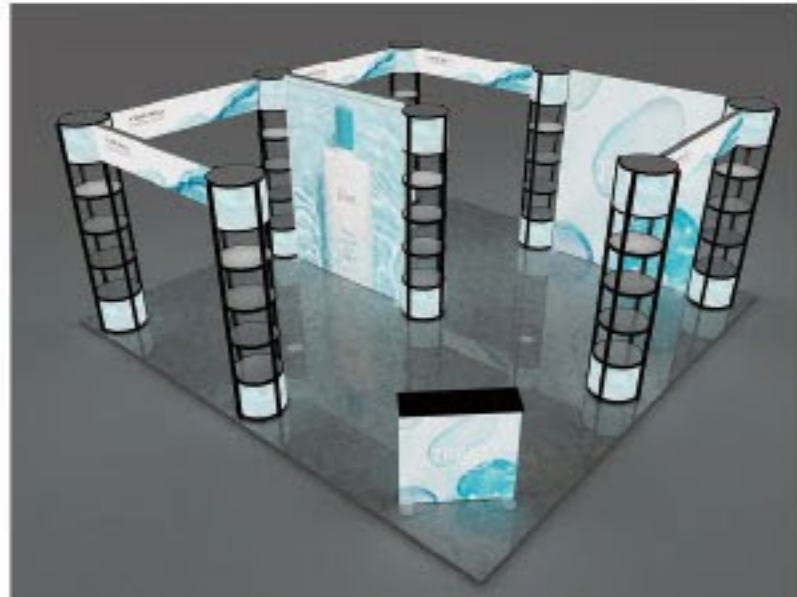

LT-07ZHP120-004

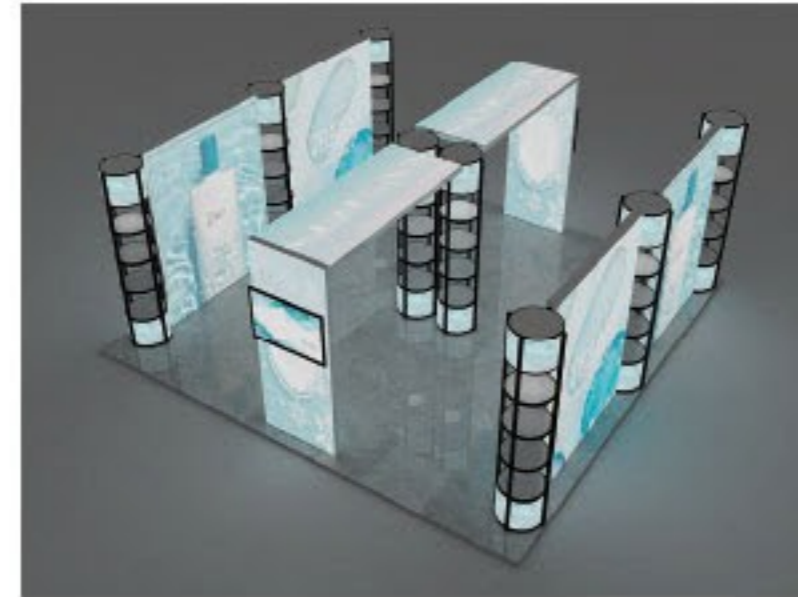

LT-07ZHP120-005

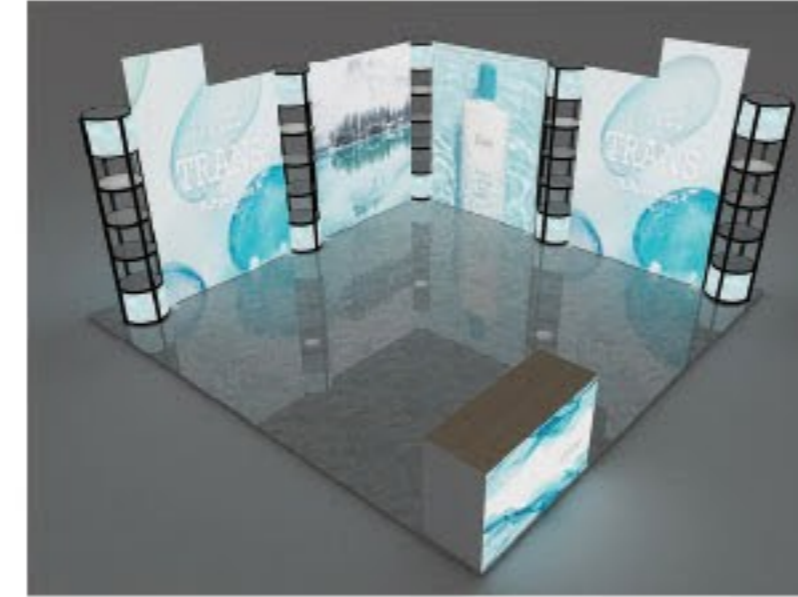

LT-07ZHP120-006



Outdoor Display

Never stop designing and developing...

Outdoor display products can let the advertising & promotion easier and widely spread. Strong and stable ability to against to the wind, it makes the advertisement perfectly.

Outdoor Display



Poster-Board LT-10G

Hot

Tips: Standard 32mm profile frame, plastic corner.

Size	A1
Graphic Size	2-59.4*84.1cm(A1)
Packing Size	104*8*67cm 80*18*50cm
PC/CTN	1/2pcs
N.W.	11.2kgs
G.W.	13.7kgs

Tube Frame Design LT-24Q4

Size	84.1*118.9cm (A0)	59.4*84.1cm (A1)
Graphic Size	84.1*118.9cm	59.4*84.1cm
Packing Size	80*18*50cm	80*18*50cm
PC/CTN	1pc	1pc
N.W.	9.0kgs	7.0kgs
G.W.	10.0kgs	8.0kgs

Clip Frame Design

- Double-sided outdoor sign
- Poster sits on two strong springs
- Wheeled moulded base with a capacity of 25L or 55L for water or sand weighting



New



LT-10J1

Hot



Poster-Board LT-10G1



Poster-Board LT-10G2

Tips: Standard 45mm profile frame, mitred corner.

	LT-10G1	LT-10G2
Size	71.12*111.76cm	71.12*111.76cm
Graphic Size	2-71.12*111.76cm	2-71.12*111.76cm
Packing Size	135*8*85cm 104*22*66cm	135*8*85cm 104*22*66cm
PC/CTN	1/2pcs	1/2pcs
N.W.	18.5kgs	17.5kgs
G.W.	24.5kgs	23.5kgs

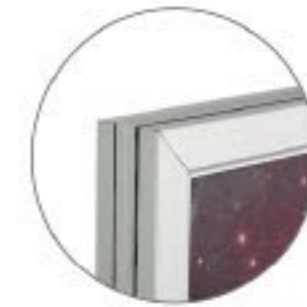

Keys to open PVC panels



Outdoor Display



Removable LED lightbox, 100% waterproof

- Double-sided LED outdoor sign
- Powered by rechargeable battery that lasts for more than 8 hours
- Poster frames could be opened to change printing
- Keys to protect LED panel or prints safety
- Wheeled base for water or sand weighting

Size	A1
Graphic Size	2-59.4*84.1cm(A1)
Packing Size	112.5*12*70cm
PC/CTN	1pc
N.W.	18.8kgs
G.W.	24.9kgs

Outdoor Display



Poster-Board LT-10H
Tips: Standard 32mm profile frame, plastic corner.



	LT-10H	LT-10H2
Size	A1	71.12*111.76cm
Graphic Size	2-59.4*84.1cm(A1)	2-71.12*111.76cm
Packing Size	77*7.5*105cm	92*8*134cm
PC/CTN	1pc	1pc
N.W.	11.7kgs	16.5kgs
G.W.	13.7kgs	19.0kgs



Poster-Board LT-10H2
Tips: Standard 45mm profile frame, mitred corner.



Size	A1	B1	A0
Graphic Size	59.4*84.1cm	70*100cm	84.1*118.9cm
Packing Size	10*10*115cm	10*10*115cm	10*10*115cm
PC/CTN	1pc	1pc	1pc
N.W.	5kgs	5.1kgs	7kgs



LT-10S



Outdoor Display

PVC Panel Design



Poster-Board LT-10K



Alu/Alu-Plastic Panel Design



LT-10K1

- Double-sided outdoor sign
- Wheeled moulded base with a capacity of 20L for water or sand weighting

Tips: More different sizes are available.

	LT-10K	LT-10K1
Size	50*75cm	57.5*85cm
Graphic Size	50*70cm	57.5*85cm
Packing Size	65*16*103cm	22*50*88cm
PC/CTN	1/2pcs	1pc
N.W.	5.4kgs	5.4kgs
G.W.	7.0kgs	6.4kgs

- New PE moulded material, color could be customized
- Waterproof for outdoor, stable and durable
- Double-sided media option
- All printings insert into the channel easily
- Packs flat for easy transportation

	LT-10N1	LT-10N2
Graphic Size	2-59.4*84.1cm(A1)	2-60.4*90cm
Packing Size	110.5*9.5*67cm	101.5*12*60cm
PC/CTN	1pc	1pc
N.W.	12.0kgs	5.1kgs(without PVC panel)
G.W.	13.0kgs	6.0kgs(without PVC panel)



LT-10N1(Could fill with water)



LT-10N2

Tips: The horizontal beams could be cut many different sizes for using.



Outdoor Display



Hot



- Handle design to move sign easily
- Moulded base for water or sand weighting
- All parts are made of PVC, no any tool

LT-10M

Size	36*36*120cm
Graphic Size	2 33*38.2cm
Packing Size	50*20*69cm
PC/CTN	1pc
N.W.	2.0kgs
G.W.	3.0kgs



LT-10N3

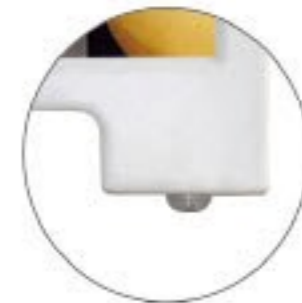

Type	LT-10N3	LT-10N4
Size	36*36*120cm	42*59.4cm
Graphic Size	2-33*38.2cm	42*55.8cm
Packing Size	50*20*69cm	62*8*46cm
PC/CTN	1pc	1pc
N.W.	2.0kgs	2.5kgs
G.W.	3.0kgs	3.0kgs



LT-10N4

Outdoor Display



LT-23

Tips: More other large sizes could be designed and produced.

Size	100*150cm	100*200cm	100*300cm
Graphic Size	100*150cm	100*200cm	100*300cm
Packing Size	22*15*161cm	22*15*111cm	22*15*114cm
PC/CTN	1pc	1pc	1pc
N.W.	4.5kgs	5.5kgs	7.0kgs
G.W.	5.5kgs	6.5kgs	8.0kgs



Outdoor Tent LT-25

Tips: More other sizes could be made.

Size	3*3m	3*4.5m	3*6m
Packing Size	160*30*28cm	160*30*37cm	162*34*58cm
PC/CTN	1pc	1pc	1pc
N.W.	18.0kgs	23.0kgs	31.0kgs

Color Option



- Anodized aluminum frame as standard style
- 1.2mm thickness material for strong structure
- Canopies, half-walls and full walls are water and UV resistant
- With sandbag, water weight or tent peg to enhance stability
- Carry bag included, trolley bag as an optional upgrade



Aluminum Material 1.2mm thickness

Outdoor Display

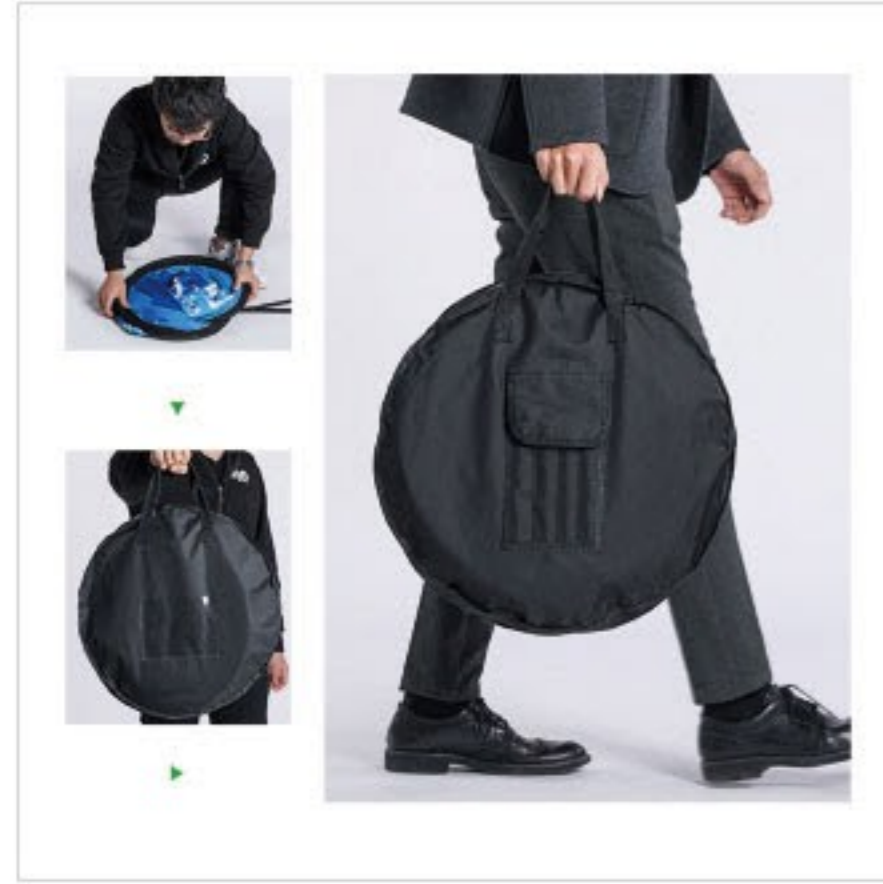

LTW-30



Outdoor Popup Banner

<p>Oval</p>	<p>Upright</p>	<p>Triangle</p>
<p>Bean type</p>		<p>Round</p>

Made of elastic steel and knitted polyester fabric printing, to be many styles.



Outdoor Display



LingTong Aluminum Tent structure apply for all kinds of event, party, exhibition, promotion, storage and so on.

Clear Span Tent

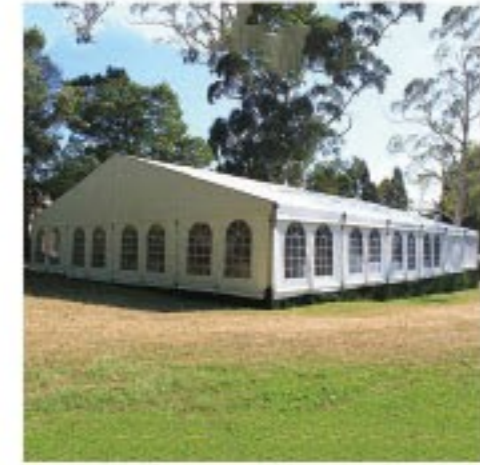

Arcum Tent



Pagoda Tent



Peach Roof Tent



Transparent Tent



Polygonal Roof Tent



Banner Flag



LT-14(4m) LT-14(5m) The style of 7m flag is same as 5m.

Tips: Nylon bag packaging.

Size	4m	5m
Graphic Size	81*315cm	110*400cm
Packing Size	13*13*160cm 66*26*66cm	13*13*166cm 90*42*42cm
PC/CTN	1/2pcs	1/2pcs
N.W.	8.3kgs	14.8kgs
G.W.	11.5kgs	18.0kgs



LT-17F LT-17G

BASE OPTIONS:



Steel Base Foot (Weighting Ring) LT-17C-19/17C-19A
Steel base LT-17C-26A/17C-26B
Steel base LT-17G-08

Tips: Steel base and alu tube pole.

Recommended graphic size:		
	2.5m-(w)650*(h)2600mm	2.5m-(w)760*(h)2370mm
	3.5m-(w)650*(h)3500mm	3.5m-(w)760*(h)3370mm
	4.5m-(w)650*(h)4300mm	4.5m-(w)900*(h)4370mm
	5.5m-(w)650*(h)5200mm	5.5m-(w)900*(h)5000mm

Banner Flag



LT-17C(ModelA) **Hot**

Tips: The flag pole is made of alu and fiberglass.

Recommended graphic size:

3.5m-(w)1100*(h)1840mm
4.5m-(w)1400*(h)2480mm
5.5m-(w)1600*(h)3690mm



LT-17C(ModelB) **Hot**

Tips: The flag pole is made of alu and fiberglass.

Recommended graphic size:

3.5m-(w)610*(h)2480mm
4.5m-(w)730*(h)3440mm
5.5m-(w)780*(h)4710mm



LT-17C(ModelC) **Hot**

Tips: The flag pole is made of alu and fiberglass.

Recommended graphic size:

3.5m-(w)600*(h)2160mm
4.5m-(w)700*(h)3100mm
5.5m-(w)750*(h)4350mm

BASE OPTIONS:



Steel Ground Stake LT-17-21A/17C-21
Steel Ground Spike 17C-20B
Steel Ground Spike LT-17-21B/17C-21C
Steel Ground Spike LT-17C-11A/17C-11B
Steel Base Foot (Weighting Ring) LT-17C-19/17C-19A
Cross Base LT-17C-25/17C-25A/17C-25B
Cross Base LT-17C-29/17C-29A
Steel base LT-17C-27A/17C-27B
Steel base LT-17C-28A/17C-28B
Steel base LT-17C-26A/17C-26B

Banner Flag

Tips: More graphic sizes could be chosen.



Standard Pole Size: 1.5'x1.6'x2.0'x2.5'

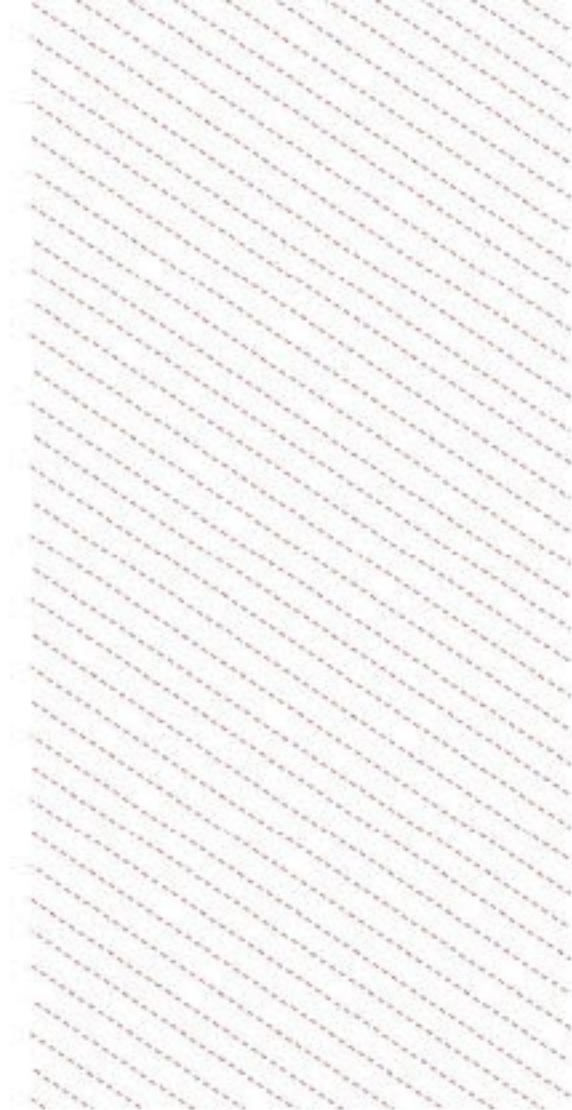
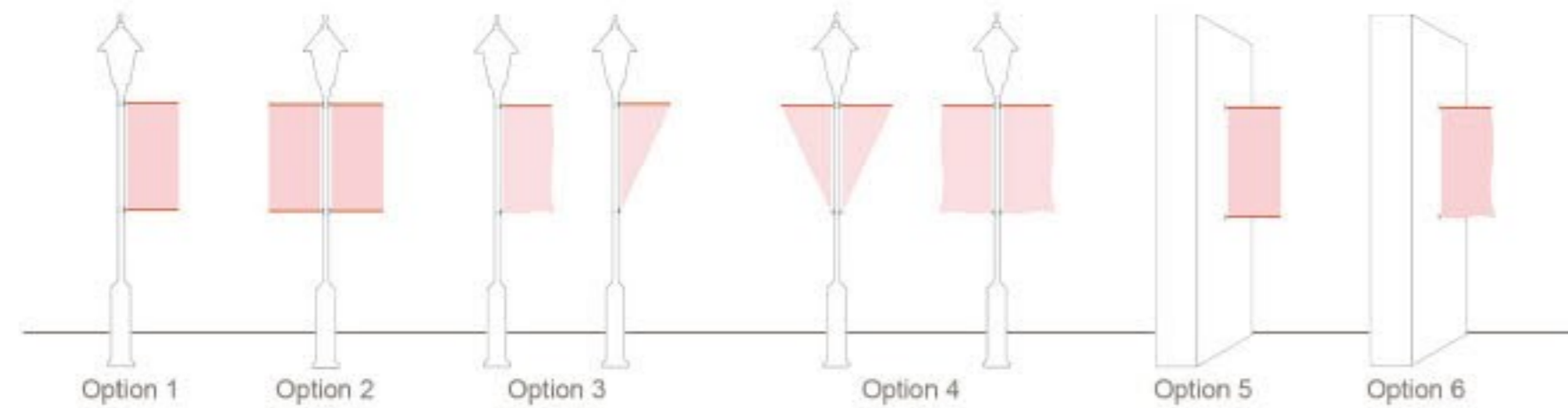

Promotion Range

Never stop designing and developing...

The promotional products are very basic products in the market and widely used in all promotional events like store, shopping mall, restaurant ect. All are in aluminum material, stable and durable.

Promotion Range



Snap Frame 20MM/25MM/32MM/45MM

SEG Fabric Frame



Standard wall mount brackets provided

Easy assembly with steel corners

Eye-hook for ceiling mount models

Snap Frame

Tips: More colors, American sizes, customized sizes for option.

25mm	Graphic Size	Packing Size	PC/CTN
A4(Rondo/Mitred)	21*29.7cm	36*25*28cm	10
A3(Rondo/Mitred)	29.7*42cm	48*25*37cm	10
A2(Rondo/Mitred)	42*59.4cm	65*25*49cm	10
A1(Rondo/Mitred)	59.4*84.1cm	90*13.5*66cm	5
A0(Rondo/Mitred)	84.1*118.9cm	125*13.5*91cm	5
B2(Rondo/Mitred)	50*70cm	76*25*57cm	10
B1(Rondo/Mitred)	70*100cm	106*13.5*77cm	5
B0(Rondo/Mitred)	100*140cm	125*13.5*91cm	5

32mm	Graphic Size	Packing Size	PC/CTN
A4(Rondo/Mitred)	21*29.7cm	37*30*29cm	10
A3(Rondo/Mitred)	29.7*42cm	49*30*38cm	10
A2(Rondo/Mitred)	42*59.4cm	67.5*30*50cm	10
A1(Rondo/Mitred)	59.4*84.1cm	91.5*16*68cm	5
A0(Rondo/Mitred)	84.1*118.9cm	126.5*10*92cm	3
B2(Rondo/Mitred)	50*70cm	77.5*30*58cm	10
B1(Rondo/Mitred)	70*100cm	107*16*78cm	5
B0(Rondo/Mitred)	100*140cm	147.5*10*108cm	3

SEG Fabric Frame

15mm width Mini Recommended Size Range

Metric Size: A3 A2 A1 B3 B2 B1

Inch Size: 14" ≤ Poster Length ≤ 48"

30mm width Recommended Size Range

Metric Size: A3 A2 A1 A0 B3 B2 B1

Inch Size: 24" ≤ Poster Length ≤ 120"

32mm width Recommended Size Range

Metric Size: A3 A2 A1 B3 B2 B1

Inch Size: 14" ≤ Poster Length ≤ 48"

Promotion Range

Clip Type Lightbox



SEG Fabric Type Lightbox



LTW-ALF60 (Backlit) / (Sided Light)

	LTW-ALF20	LTW-ALF22	LTW-ALF35	LTW-ALF16.6	LTW-ALF33	LTW-ALF40	LTW-ALF60
Visible Surface	Single	Single	Single	Single	Single	Double	Single
Suitable Size	Small&Medium	Small&Medium	Small&Medium	Small&Medium	Small&Medium	Small&Medium	All
Thickness	2cm	2.2cm	3.5cm	1.66cm	3.3cm	4cm	6cm
Structure	LGP,SMD LED light	LGP,SMD LED light	LGP,SMD LED light	LGP,SMD LED light	LGP,SMD LED light	LGP,SMD LED light	LGP,SMD LED light
Input Voltage	12V/24V	12V/24V	12V/24V	12V/24V	12V/24V	12V/24V	12V/24V
Power	12W-120W	12W-120W	12W-120W	12W-400W	12W-400W	12W-400W	12W-400W



Promotion Range

K-system standard profiles are used with plastic or aluminium end caps to create a large variety of horizontally curved double-sided suspended signs.



KC-Wall Mounted Sign



Option B:
Using self tapping screws fix to the wall.



Option A:
Sticking double adhesive tape one the back of the frame, signs stick to the wall directly.



KC-Wall Flag Sign



KC-Double Hanging Sign

Curved Style Sign

Modular Slim Sign



Slim Frame Designed way-finding Sign System

NWF SYSTEM is included 4 sides aluminium anodized silver extrusion, portrait or landscape orientation, PVC cover, steel connect corner and double-sides tape.

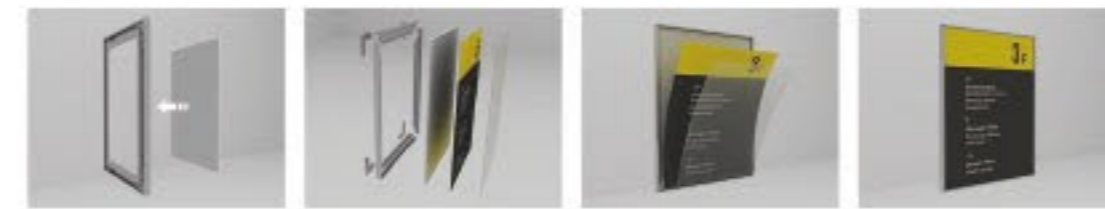

- The normal color is anodized silver
- The color painting and size can be made as per customers idea



LP-Wall Mounted Sign

Straight Style Sign



LP-Double Hanging Sign



Hanging fittings

The flat wall bracket sign uses SD10-1 and SD11 standard extrusion. Size can be made as per customer's idea.



LP-Wall Flag Sign

Promotion Range



BNL-1

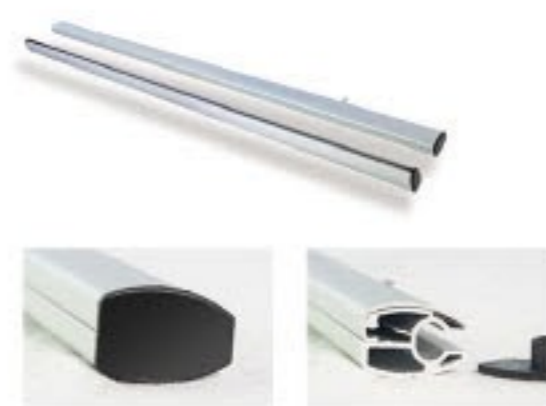

BNL-3



BNL-2



BNL-4

Hanging Banner Option

Tips: Different styles and sizes are available for choice.



Slide-In Poster Option

- Anodized aluminum profile, customized color as option
- Printings slide into channel, easy to change
- Single or double sided screen shown
- PVC soft bars fill into the channel to protect printing
- Steel rings and hanging lines included



LT-GDF25M
(Slide-in Hanging Frame)



- Anodized aluminum profile, customized color as option
- Printings slide into channel, easy to change
- Holes for horizontal or vertical wall mounting
- Top soft PVC bars used for better graphic protection
- Expansion screws included



LT-SDF23M
(Slide-in Wall Frame)



Tips: More sizes are available.

Recommended Size Range	
Metric Size	A3 A2 A1 B3 B2 B1
Inch Size	12" ≤ Poster Length ≤ 36"

Promotion Range

- Anodized aluminum profile, customized color as option
- Printings slide into channel, easy to change
- Single or double sided screen shown
- Top soft PVC bars used for better graphic protection
- Base with adhesive tapes as other style onto the desk or wall



LT-TDF25M (Slide-in Table Frame)



Tips: More sizes are available.

Size	A3	A4
Graphic Size	42*29.7cm	29.7*21cm
Packing Size	47.5*36.5*35.5cm	35*36.5*27cm
PC/CTN	1/10pcs	1/10pcs
N.W.	0.65kgs	0.45kgs
G.W.	8.5kgs	6.5kgs

Promotion Range



Economic Poster Board



LT-10-DM25-B

Size	A1
Graphic Size	59.4*84.1cm
Packing Size	107.5*67*9.5cm
PC/CTN	1pc



Slide-In Poster Board

- Anodized aluminum profile, customized color as option
- Graphic slide in structure , easy to assemble and change printing designs
- Single or double sided screen shown, very economic choice
- Top soft PVC bars used for better graphic protection
- Different sizes are available

Size	A1
Graphic Size	59.4*84.1cm
Packing Size	107.5*68*6.5cm
PC/CTN	1pc



LT-10R-D

Promotion Range

Poster-Board

Tips:25mm or 32mm for choice.

- Anodized aluminum profile, customized color as option
- Top profile could be open, strong springs to protect printing
- Single or double sided screen shown, different style for choice
- PVC panel to avoid graphics broken
- Round corner or mitred corner

	LT-10-DR32-A	LT-10-DM32-A	LT-10-SR32-A
Size	A1	A1	A1
Graphic Size	2-59.4*84.1cm(A1)	2-59.4*84.1cm(A1)	2-59.4*84.1cm(A1)
Packing Size	123*13*68cm	123*13*68cm	150*13*68cm
PC/CTN	1pc	1pc	1pc
N.W.	7.2kgs	7.2kgs	4.2kgs



LT-10-DR32-A



LT-10-DM32-A



LT-10-SR32-A



LT-10/LT-10(Header)



LT-10A



LT-10D



LT-10E



LT-10F

	A1	A1	A1	B2	B2
Size	A1	A1	A1	B2	B2
Graphic Size	2-59.4*84.1cm(A1)	2-59.4*84.1cm(A1)/60*20cm	2-59.4*84.1cm(A1)	2-50*70cm(B2)	2-50*70cm(B2)
Packing Size	123*13*68cm	150*13*68cm	110*9*80cm	165*9*71cm	165*9*71cm 35*31*48cm
PC/CTN	1pc	1pc	1pc	1pc	1/2pcs
N.W.	8.6kgs	12.4kgs	7.2kgs	11.0kgs	9.0kgs
G.W.	10.0kgs	14.0kgs	8.7kgs	12.5kgs	11.0kgs

Promotion Range



CLASSIC Wood Chalkboard Sign



Chalkboard Sign
Tips: More styles and sizes could supply



Single or double side



Table Chalkboard Frame for A3/A4



Heavy duty hinges



Smoothly edge surface



Fixed foot pad



Vintage rustic chains

Alu Chalkboard Sign



LT-13K5

Size	A3	A4
Graphic Size	29.7*42cm	21*29.7cm
Packing Size	37*6.5*98cm	37*6.5*98cm
PC/CTN	1pc	1pc
N.W.	2.8kgs	2.7kgs
G.W.	3.5kgs	3.4kgs



LT-05B(Acrylic)



LT-13B1



LT-13B2



LT-13B4



LT-13C

Tips: Hard case packaging is available.

	LT-05B	LT-13B1	LT-13B2	LT-13B4	LT-13C
Size	A4	A4	A4	A4	A4
Graphic Size	A4*6	21*29.7cm(A4)	21*29.7cm(A4)	21*29.7cm(A4)	A4*3
Packing Size	49*35*33cm	106*36*42cm	38*25*103cm	38*25*125cm	126*43*48cm
PC/CTN	2pcs	8pcs	6pcs	6pcs	8pcs
N.W.	5.2kgs	4.0kgs	3.2kgs	3.3kgs	4.3kgs
G.W.	11.0kgs	38.5kgs	21.8kgs	22.5kgs	41.5kgs

Tips: Black pocket with black foot, grey pocket with grey foot is better for your choice.

	LT-05	LT-05A	LT-05F	LT-05E
Size	27*130cm	50*130cm	50*130cm	27*130cm
Graphic Size	A4*4	A4*8	A4*8	A4*4
Packing Size	58*28*47cm	58*28*47cm	58*28*40cm	58*28*40cm
PC/CTN	8pcs	8pcs	20pcs	20pcs
N.W.	2.6kgs	3.1kgs	1.0kgs	0.8kgs
G.W.	24.0kgs	28.0kgs	25.0kgs	19.0kgs



LT-05



LT-05A

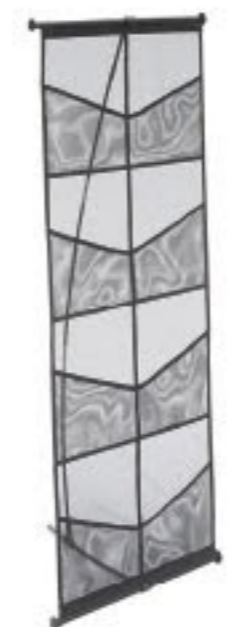

LT-05F

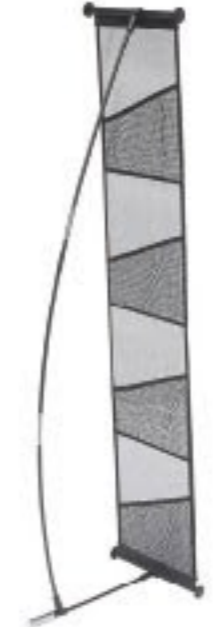

LT-05E

Promotion Range

Promotion Range

Promotion Range



LT-X1

LT-X2

LT-X3

X Banner

Tips: More large sizes are available.

Type	LT-X1	LT-X2	LT-X3
Size	60*160cm	60*160cm	60*160cm
Graphic Size	60*160cm	60*160cm	60*160cm
Packing Size	106*31*36.5cm	115*25*30cm	115*25*30cm
PC/CTN	20pcs	20pcs	20pcs
N.W.	1.0kgs	0.7kgs	0.3kgs
G.W.	21.0kgs	15.0kgs	7.0kgs

L Banner

Tips: More different sizes are available.

Type	LT-L1	LT-L2
Size	60*160cm	60*180cm
Graphic Size	60*160cm	60*180cm
Packing Size	80*26*26cm	86*26*26cm
PC/CTN	20pcs	20pcs
N.W.	0.8kgs	1.3kgs
G.W.	19.5kgs	34.0kgs

Type	LT-L5	LT-L6
Size	80*200cm	80*200cm
Graphic Size	80*200cm	80*200cm
Packing Size	39*39*88cm	55.5*38*89cm
PC/CTN	9pcs	4pcs
N.W.	2.6kgs	4.1kgs
G.W.	25.0kgs	26.8kgs



LT-L1

LT-L2

LT-L5

LT-L6

Promotional Counter

Tips: Reducing shelves/moving doors are available.

GEAR-FOLDED COUNTER



LT-11A



LT-11C

Size	105*58*90cm	115*58*90cm
Graphic Size	1-100.5*85.7cm 2-32.1*85.7cm	1-65*85.7cm 4-28.6*85.7cm
Packing Size	115*23*97cm	94*22*73cm
PC/CTN	1pc	1pc
N.W.	28.5kgs	31.0kgs
G.W.	34.5kgs	37.0kgs

TWISTER TOWER COUNTER

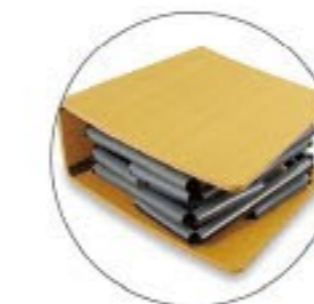

LT-07B1-T



LT-07B2-T



LT-24B4



LT-24B7



LT-24B

EZ TUBE FABRIC COUNTER



POP-UP COUNTER



LT-09B7-A Straight



LT-09B7-B Curved



LT-09B

Promotion Range

Promotion Range

Automatic Lift&Collapsible Counter

- No tool counter, pneumatic lift design
- Height could be adjustable
- No need to disassemble graphic
- Bearing the weight is 28kgs max
- LED backlit is available also



LT-09B8

Size	100*42* (80-100) cm
Graphic Size	267.7* (82-102) cm
Packing Size	46.5*11*105cm
PC/CTN	1pc
N.W.	15.6kgs
G.W.	17.0kgs



LT-09B9

Size	78*39.5* (80-100) cm
Graphic Size	194* (82-102) cm
Packing Size	44*11*83cm
PC/CTN	1pc
N.W.	11.0kgs
G.W.	13.5kgs

Laptop Stand & Standing Desk

- Simple and easy to use
- Humanization design
- Adjustable height and top board angle, locking knob
- limited storage space
- Patented stand



LT-29

Size	60*33* (24~32)cm
Angle Size	0-36°
Packing Size	65*37*6.5cm
PC/CTN	1pc
N.W.	2.2kgs
G.W.	2.8kgs

Option



Single / Double Foldable Laptop Desk



Color Option

- Gas Springs raise the desk height freely and securely
- Adjustable height range is from 13-51cm
- Easily transitioning from sitting to standing while you work
- E1 Grade environmental MDF table top and shelf

Size		
Packing Size	86*55*11cm	100*57*17cm
Gross Weight	10.5kg	15.2kg
PC/CTN	1pc	1pc

Promotion Range

Color Option
Ipap Stand Holder

The ipap holder can be rotated to display landscape portrait positions and adjusted height or at a required reading angle.



Adjustable Height: 667-1630mm
 Fit 4"-10" smartphone&Tablet
 Feature: 360° degree



- The smart desktop holder design to at three types for using.
- The ipap holder can be rotated to display portrait or landscape orientations.
- Fit 7"-10" / 10"-13" Tablet Size.

Desktop Ipap Holder

Color Option



Roll Up Stand

Never stop designing and developing...

Smart, portable and quick display in all events. Economic and luxury designs are available. All can be re-used just by changing graphic designs.

Roll Up Stand



Single bag packaging, Clip top rail, Bungee pole

	LT-OB2-T	LT-OB-T	LT-OC	LT-02
Size	80cm(More different sizes are available)	80cm(More different sizes are available)	80cm(More different sizes are available)	80cm
Graphic Size	80*200cm	80*200cm	80*220cm	80*220cm
Packing Size	31*21*86cm(no inner box)	33*23*86cm(no inner box)	36*24*87cm(no inner box)	53*29*90cm
PC/CTN	6pcs	6pcs	6pcs	4pcs
N.W.	1.9kgs	2.0kgs	2.5kgs	3.8kgs
G.W.	13.5kgs	15.6kgs	18.6kgs	19.5kgs

Roll Up Stand



Padded bag packaging, Clip rail, Bungee or Telescopic pole. More different sizes are available

	LT-02C	LT-02E	LT-0T	LT-0R
Size	80cm	80cm	80cm	80cm
Graphic Size	80*220cm	80*220cm	80*220cm	80*220cm
Packing Size	53*29*90cm	43*36*93cm	49.5*38.5*90cm	55*36*91cm
PC/CTN	4pcs	6pcs	6pcs	6pcs
N.W.	3.8kgs	3.0kgs	4.3kgs	4.1kgs
G.W.	19.5kgs	21.5kgs	33.5kgs	31.5kgs

Roll Up Stand



3M Tape Style



LT-0Q6



Clip Style



Size	80*200cm	85*200cm	100*200cm
Packing Size	10*10*88cm	10*10*93cm	10*10*108cm
PC/CTN	1pc	1pc	1pc
N.W.	1.74kgs	1.82kgs	2.0kgs
G.W.	2.45kgs	2.55kgs	2.7kgs



Patent Style



Rotating feet



Colour can be customized

COMPANY PROFILE



LINGTONG LINTEL

Changzhou Lintel Display Co., Ltd is used to know as Changzhou Lintel AD Material Co., Ltd, established in 1998. We are a subsidiary of Lingtong Group, there are Lingtong Exhibition, Lingtong Tent, Orlanton Sign and Lintel display. Adhering to the corporate vision of "Green display service the world", after 28 years of efforts, Lintel has grown into a specialized manufacturer and service provider for eco-friendly portable display stand of high quality.

Guided by the corporate culture "Quality, Service, Innovation", Lintel provided one-stop display solutions. Currently, our products has sold to cover 110 countries and regions all over the world.

By 2022, Lintel has six automated production lines, including with pop up stand, roll up banner and tube frame, to meet customers' high quality and speed inquirments. Our goal is to build an information and intelligent production plant, to upgrade the industry's simple manual processing mode.

Over two decades of exploration and development, Lintel, like a rising sun, still keeps young, vigorous and professional. In the future, We will continue to strive for a better and more vigorous business!

— Lintel All Staff

ISO14001:2004



ISO9001:2008

