

TD05 Battery Indicator

—Instruction—

● Sketch :

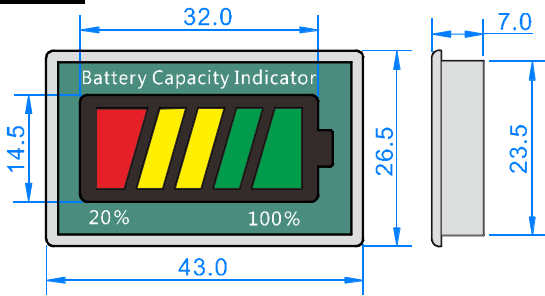

● Overviews :

★ TD05 is a kind of voltage-type battery indicator, which can test the remaining capacity of battery and display different colors of light. It is suitable for mobile and portable equipments, electromobile, balance cars, cleaning machines, instruments, measuring equipments and so on.

● Application :

★ TD05 is suitable for Lead-acid battery of 12V, 24V, 36V and 48V, as well as 3 series, 4series, 5series, 7series and 10 series of lithium battery.

● Basic parameters :

Parameter	Min	Type	Max	Unit
Working voltage	10.0		48.0	V
Working dissipation	15.0		20.0	mA
Capacity accuracy		±5.0		%
Temperature range	0		40	°C
Weight	6.5			g
Size	43×26.5×7			mm

● Connection :

★ As shown below, the red line of TD05 connect to positive, the black line connect to negative.

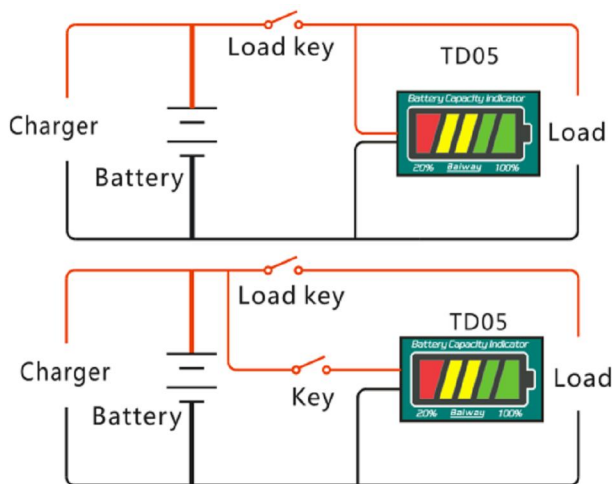

● Install :

★ First, open one rectangular orifice on the panel according to the size. Then put the TD05 into the rectangular orifice, and make sure the buckles are locked.

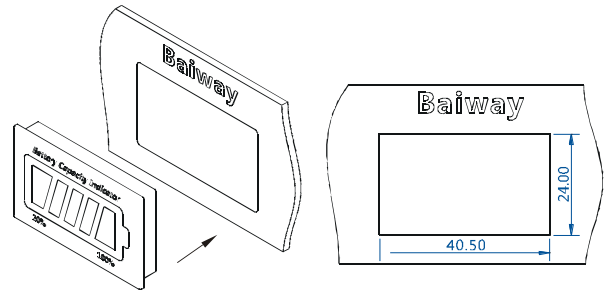

● Interface description :

★ When the TD05 is power off, as shown below.

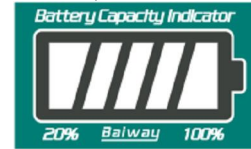

★ When the TD05 is power on, it can display different colors of LED according to the remaining capacity. As shown below.

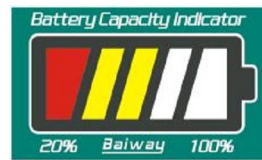

Capacity: 40%~60%



Capacity: 60%~80%

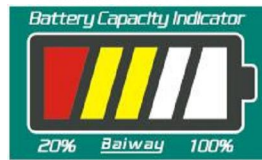

Capacity: 40%~60%

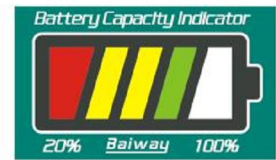

Capacity: 60%~80%

● Attention and warranty :

★ This product is non-waterproof ; Please don't use it for a long time when temperature is less than -20°C or higher than 60°C.

★ Within one year, any fault caused by non-artificial reason we should maintain it freely.

● Company info and product QR Code :

SHANGHAI BAIWAY ELECTRONIC CO., LTD

ADDR : Building A , Num99, the middle of Wangdong Road, Sijing town, Songjiang area, Shanghai, China

TEL : +021-67762158

FAX : +86-021-67762159



Scan QR Code to open product link

Our products will keep upgrading, if the product you bought is different with this instruction, please take the material object or website as the standard.