

QY-P6156



Industrial Panel PC



Product Feature:

- Support Windows / Linux system
- Support 4G / 5G / WIFI function (optional)
- Whole machine IP67 water and dust proof
- Power:DC 12V,support wide voltage power DC 12-36V
- The qty of interfaces can be modified according to demand

Specification:

QY-P6156		
CPU	J1900 i5-4260U / i5-6200U / i5-7200U / i5-8260U / i5-10210U i7-7500U / i7-10610U	
RAM	DDR III / DDR IIII	
Storage	MSATA	1*MSATA
	SATA	1*SATA
I/O	Network Interface	Most 2*RJ-45 (Aviation interface)
	USB	Most 4*USB (Aviation interface) 1*aviation interface can get 2*USB
	Serial Port	Most 6*serial port (Aviation interface) 4*RS-232+2*RS-485 / 422 / 232
	Power	DC12V (Aviation interface)
	GPIO (optional)	Aviation interface
	HDMI (optional)	Aviation interface

LCD Screen	Display port	15.6 inch TFT LED screen	
	Resolution	1920*1080	
	Brightness	350cd/m2	
	Contrast	800:1	
	Largest Colorful	16M	
Touch Screen	Type	Capacitive	Resistive
	Light transmittance	More than 95%	More than 85%
	Touch life	50 million times	35 million times
	Response time	<5ms	
	High temperature	85°C/1000hrs	
	Constant temperature and humidity	85°C/90%RH/1000hrs	
Box	Case	The casing is made of aluminum-magnesium alloy	
	Size	390mm*248mm*63.5mm	
	Installation	Flush / Wall mount	
	Weight	4kg	
Operating temperature		-20 ~ 60°C	
Storage temperature		-30 ~ 80°C	
Correlated humidity		10 ~ 95%@40°C	
Protection		Whole machine IP67 water proof	

Optional Fitting:

Model	Configuration
CPU	J1900 i5-4260U / i5-6200U / i5-7200U / i5-8260U / i5-10210U i7-7500U / i7-10610U
RAM	DDR III (4GB / 8GB)
	DDR IIII (4GB / 8GB / 16GB)
SSD	MSATA:32GB / 64GB / 128 GB / 256GB / 512GB
	SATA:120GB / 128GB / 240GB / 256GB / 480GB 512GB / 960 GB / 1TB
WIFI	7260an / 7260ac / AX 210 (with Bluetooth function)
4G module	4G+GPS
Power module	DC 12-36V

Size Drawing:

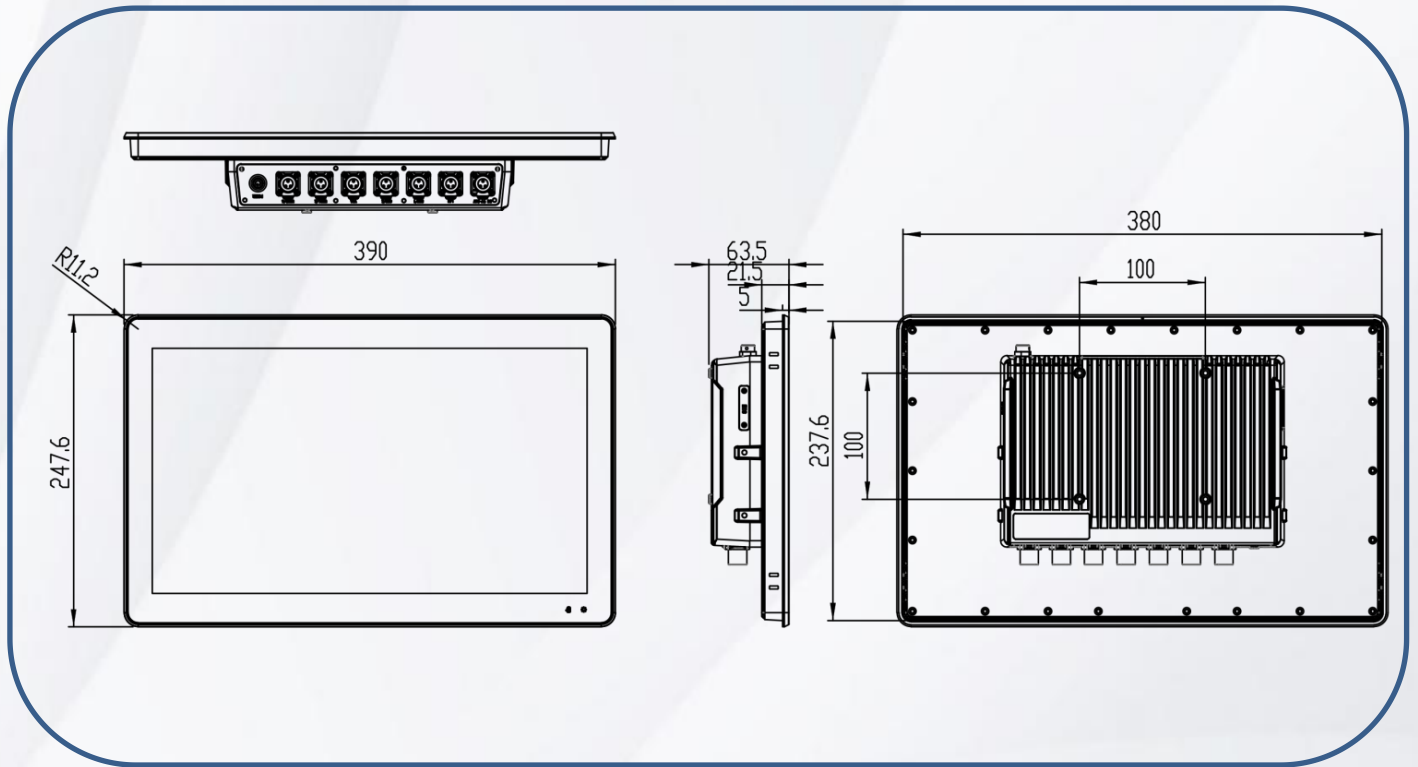

Interfaces :

A:DC 9V 36V

B:LAN

C:COM/1

D:COM/2

E:VGA

F:USB1/2

G:USB3/4

H:POWER

