

Taurus-C2
(D194/D195/D203/D204)
Parts Catalog

Parts change information sample

 **Add**

 **Update**

 **Delete**

Model	Product Code	PC Style
Pro C7100S/7110S/7100SX/7110SX	D194/D195/D203/D204	3D
Pro C7100/7110/7100X/7110X	M195/M196/M207/M208	3D
Decurl Unit DU5040	D3A4	3D
Vacuum Feed LCIT RT5100	D777	3D
Bridge Unit BU5010	D778	3D
Vacuum Feed Banner Sheet Tray Type S3	D777	3D
LCIT RT5090	D732	3D
Buffer Pass Unit Type S3	D795	3D
Multi Bypass Attachment Kit for Vacuum Feed LCIT Type S3	D777	3D
Multi Bypass Banner Sheet Tray Type S3	D517	3D
High Capacity Stacker SK5030	D776	3D
5th Station Replacement Kit Type S3	D880	3D
RPIP Interface Box Type S3	M462	Traditional
Optional Counter Interface Unit Type A	B871	Traditional
OCR Unit Type M2	D166	Traditional
Copier Model SD card for NetWare printing Type S3	D3A8	Traditional
PostScript3 Unit Type S3	D3A8	Traditional
Color Controller E-43A	M468	Traditional

Unit All

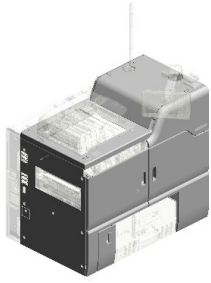

U001
EXTERIOR

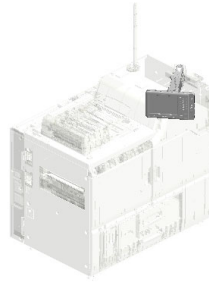

U002
OPERATION

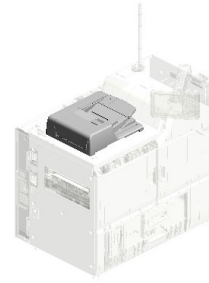

U003
ADF

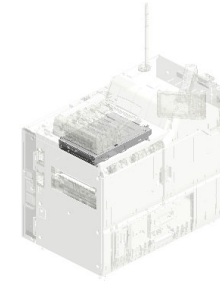

U004
SCANNER

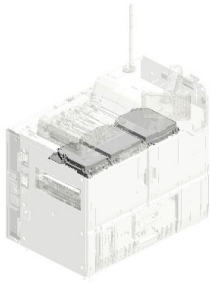

U005
LASER UNIT

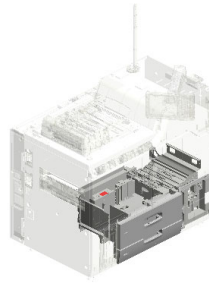

U006
PAPER BANK/PAPER FEED/VERTICAL TRANS

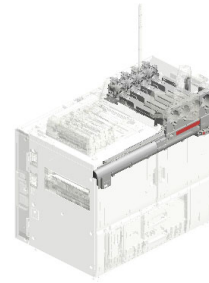

U007
TONER SUPPLY PORT

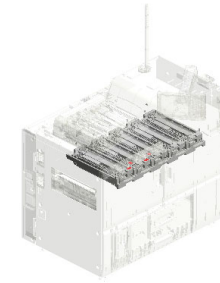

U008
PCDU

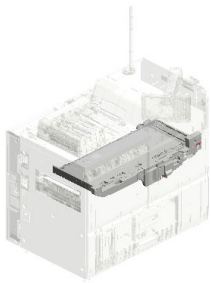

U009
ITB UNIT

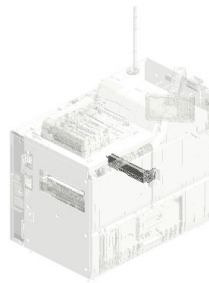

U010
ITB CLEANING

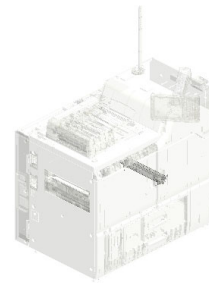

U011
TRANSFER/SEPARATION

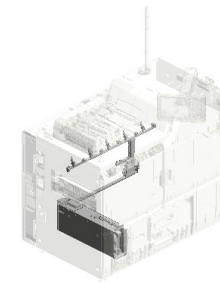

U012
USED TONER

Unit All

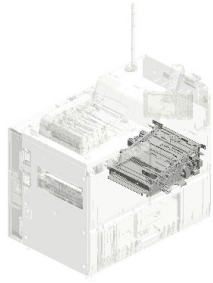

U013
PAPER FEED(MAIN)

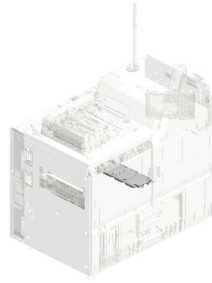

U014
SEPARATION/PAPER TRANSPORT

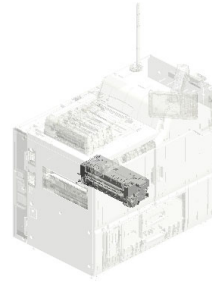

U015
FUSING

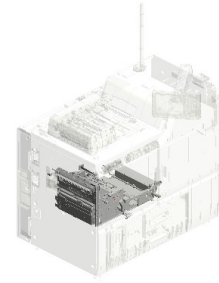

U016
PAPER EXIT

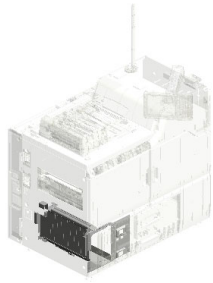

U017
DUPLEX

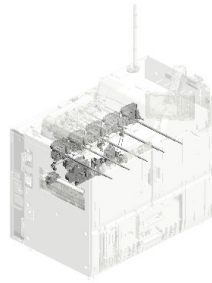

U018
MAIN DRIVE

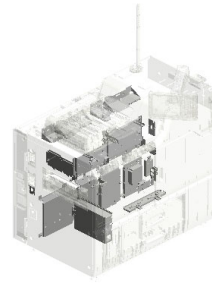

U019
ELECTRICAL

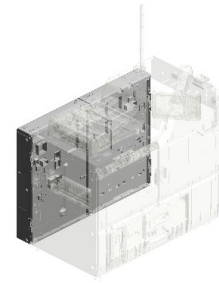

U020
CONTROLLER

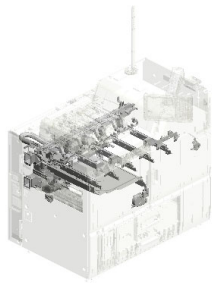

U021
AIR COOLING

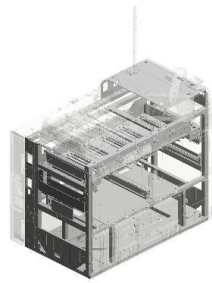

U022
MAIN FRAME

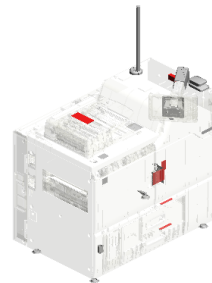

U023
ACCESSORIES

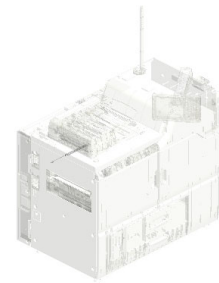

U024
HEATER

U001.EXTERIOR

U001 S001
M0EB7873
COVER:TONER SUPPLY:UPPER:ASSY

U001 S008
D0A57826
(D194-NA,CHN,AA);(D195/D203/D204);COVER:MAIN:RIGHT:ASSY

U001 S002
D0747780
DOOR:FRONT LEFT:UPPER:ASSY

U001 S005
D0747810
DOOR:FRONT RIGHT:UPPER:ASSY

U001 S007
D1947716
COVER:MAIN:LEFT:ASSY

U001 S006
D1947816
SUPPORTING PLATE:DOOR:FRONT RIGHT:ASSY

U001 S003
D0747791
DOOR:COLLECTION BOTTLE:ASSY

U001 S004
D1947801
SUPPORTING PLATE:DOOR:FRONT LEFT:ASSY

U001 EXTERIOR

4.52062684
(x2)
SHOULDER SCREW
W - M3

6.AG070512
MAGNET CATCH:
ASSY

22.D0747752
(x4)
CAP:COVER:TONE
R SUPPLY

7.AG070514
MAGNET CATCH

24.D0747762
(x2)
BRACKET:HINGE:
TONE SUPPLY

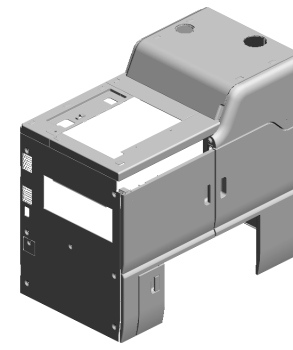

1.03604008N(x 5)
SCREW - M4X8
2.04514008N(x34)
TAPPING SCREW:4X8

11.C1012360
(x2)
SNAP RING

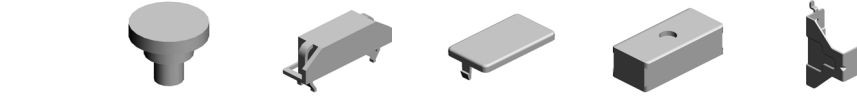

9.B1041303
(x2)
HINGE SHAFT

21.D0744557
DECAL:H-TEMP W
ARNING:EXIT

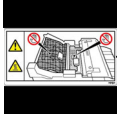

2.04514008N
(x5)
TAPPING SCREW:
4X8



20.D0744553
DECAL:PULL OUT:
LEFT:D1



14.D0742985
DECAL:PULL OUT:
RIGHT:B3

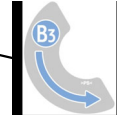

18.D0744549
DECAL:MISFEED R
EMOVAL:EXIT



13.D0742984
DECAL:PULL OUT:
RIGHT:B1

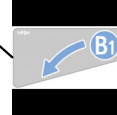

27.D0747787
HINGE:DOOR:COL
LECTION BOTTLE:
ASSY



1.03604008N
(x4)
SCREW - M4X8



3.08025324
(x47)
HEXAGON HEAD T
APPING SCREW:P
F:4X10



19.D0744551
DECAL:PULL OUT:
LEFT:Z1



16.D0742987
DECAL:PULL OUT:
RIGHT:B6



17.D0742989
DECAL:PULL OUT:
RIGHT:Z2



15.D0742986
DECAL:PULL OUT:
RIGHT:B4



U001 EXTERIOR

- 60.D1947747 COVER:UPPER REAR:SMALL
- 56.D1947741 COVER:UPPER FRONT
- 57.D1947743 COVER:UPPER RIGHT
- 58.D1947744 BRACKET:COVER:UPPER RIGHT
- 65.D7101333 SHIELDING PLATE:OPEN AND CLOSE:SENSOR:DOOR

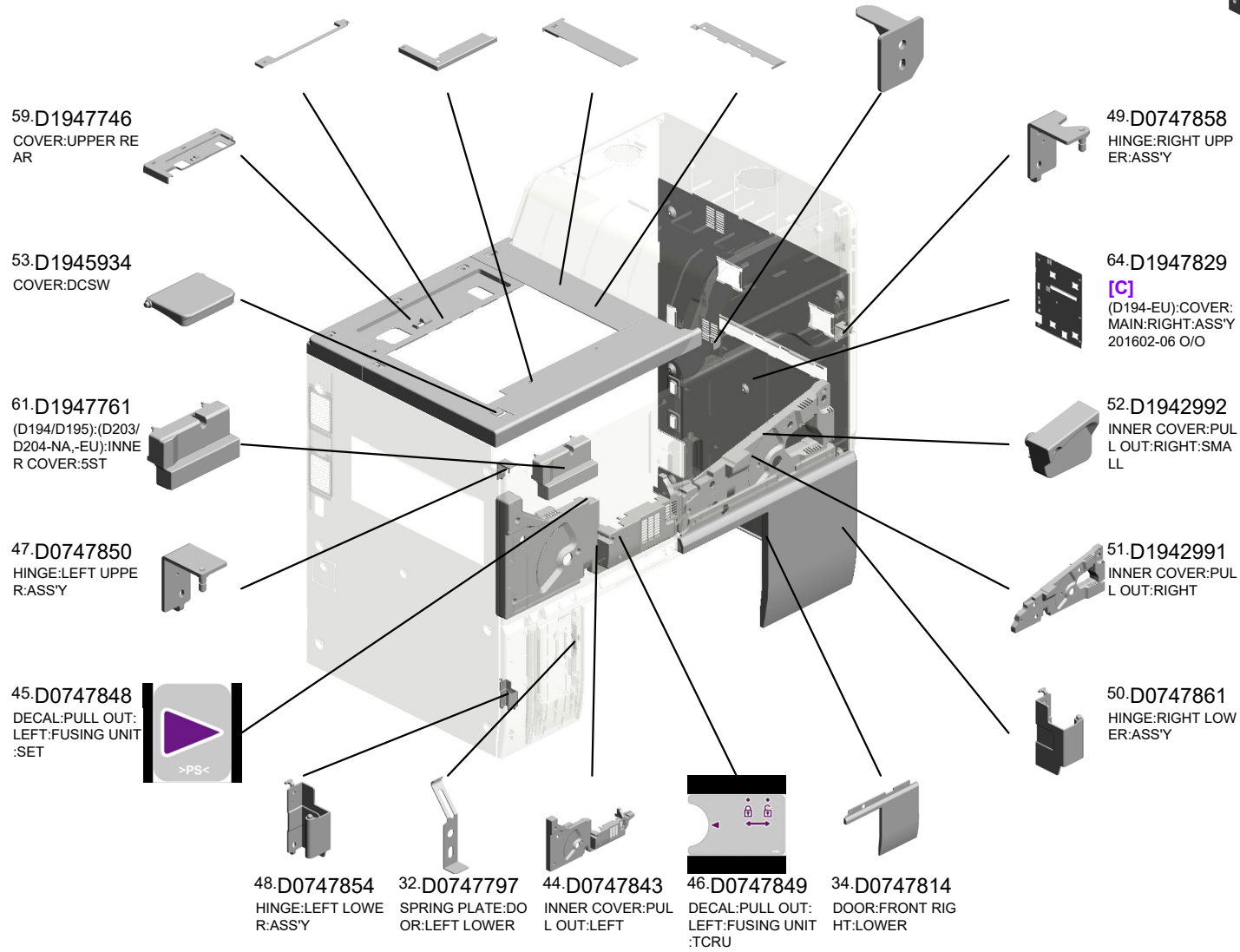
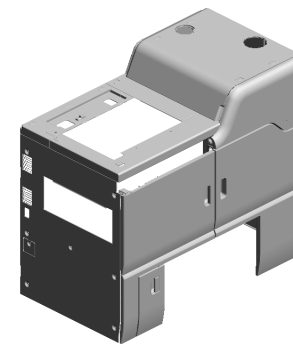

U001
EXTERIOR

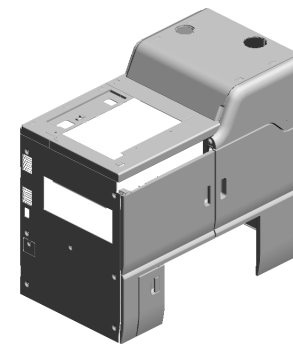

73.M0EB7960

[B]
DOOR:TONER SUP
PLY
202402-01 O/O

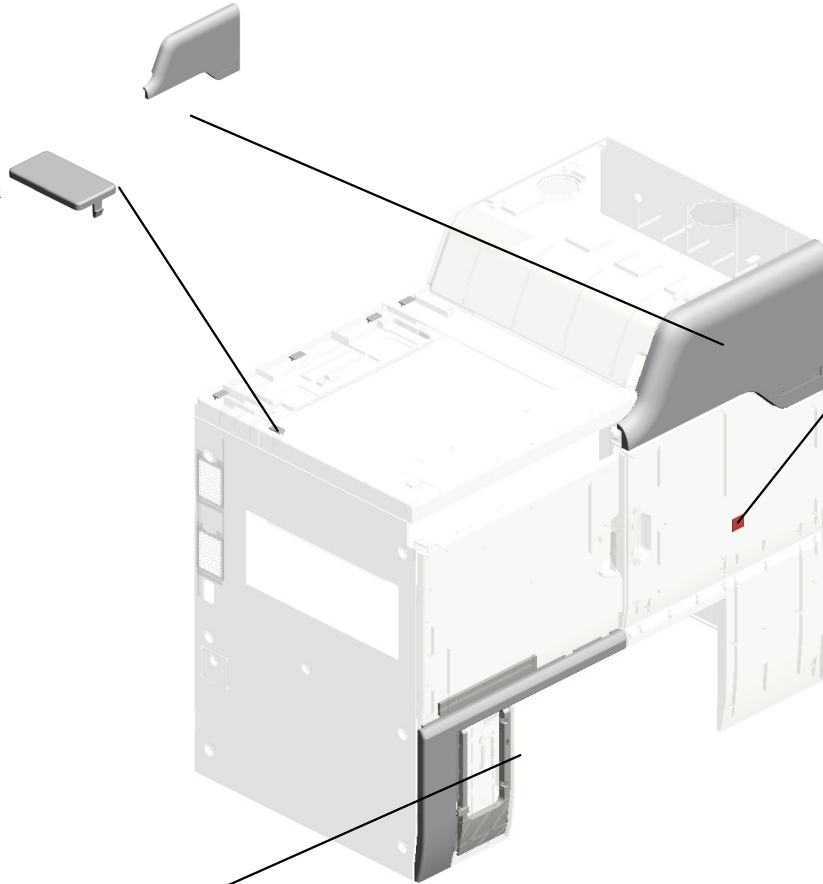

66.M0447747
(x5)
CAP:COVER:REAR



67.D1942927
STOPPER:LEVER:5
MM
201508-03

69.D0A57259

[A]
DOOR:FRONT LEF
T:LOWER
201804-01 O/O

 D0747785 [A] DOOR:FRONT LEF T:LOWER 201804-01 O/O	 D1947826 [C] (D194-NA,CHN,AA): (D195/D203/D204): COVER:MAIN:RIGH T:ASS'Y 201602-06 O/O
---	--

 M0EB7959 [B] DOOR:TONER SUP PLY 202402-01 O/O

U001_S001
COVER:TONER SUPPLY:UPPER:ASS'Y

3.08025324
(x3)
HEXAGON HEAD TAPPING SCREW:PF:4X10

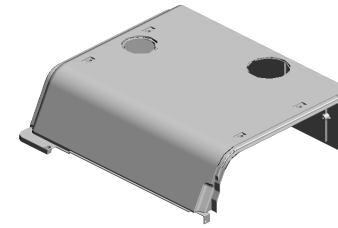

72.M0EB7873
[A]
COVER:TONER SUPPLY:UPPER:ASS'Y
202302-02 O/O



D0747753
[A]
COVER:TONER SUPPLY:UPPER:ASS'Y
202302-02 O/O

U001_S002
DOOR:FRONT LEFT:UPPER:ASS'Y

3.08025324

(x2)
HEXAGON HEAD TAPPING SCREW:PF:4X10

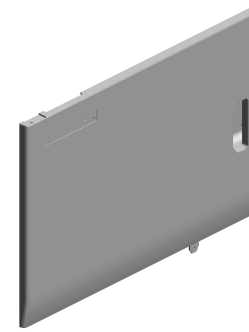
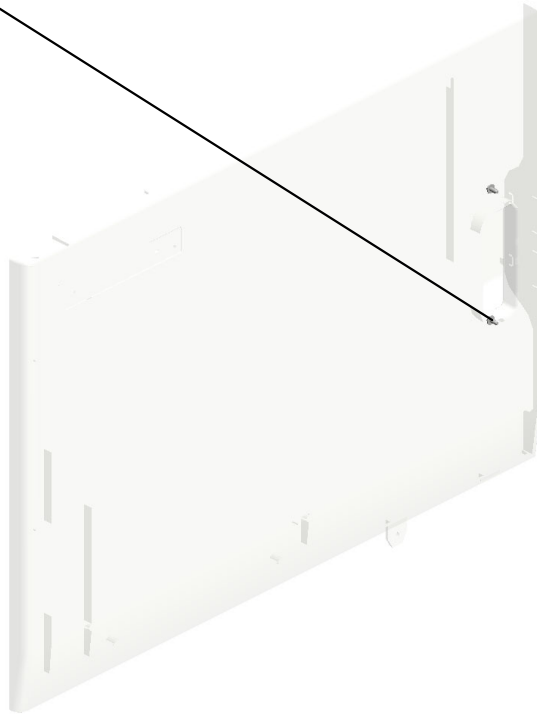

25.D0747780
DOOR:FRONT LEFT:UPPER:ASSY

U001	U002	U003	U004	U005	U006	U007	U008	U009	U010	U011	U012	U013	U014	U015	U016	U017	U018	U019	U020	U021
------	------	------	------	------	------	------	------	------	------	------	------	------	------	------	------	------	------	------	------	------

U001_S003
DOOR:COLLECTION BOTTLE:ASS'Y

10.B2341293 LEVER - SAFETY SWITCH
 3.08025324 HEXAGON HEAD TAPPING SCREW:PF:4X10
 5.54472681 (x2) SNAP RING

28.D0747791
DOOR:COLLECTION BOTTLE:ASS'Y

29.D0747793
GRIP:DOOR:COLLECTION BOTTLE

31.D0747795
SHAFT:CONTACT POINT:GRIP

12.D0146458
(x2)
SPRING:BLADE:NO .1

30.D0747794
(x2)
LEVER:RELEASE:DOOR:COLLECTION BOTTLE

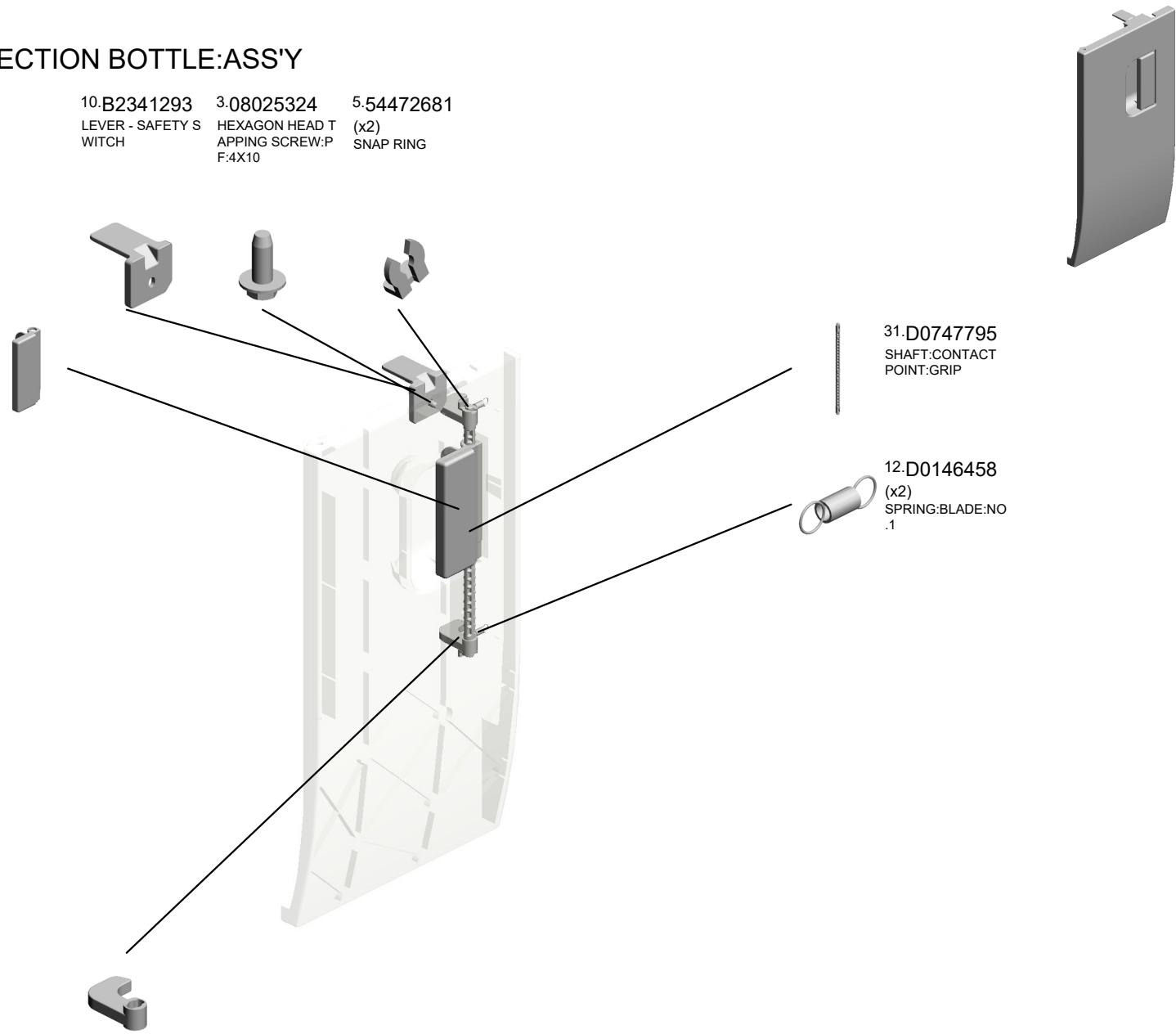

U001	U002	U003	U004	U005	U006	U007	U008	U009	U010	U011	U012	U013	U014	U015	U016	U017	U018	U019	U020	U021
------	------	------	------	------	------	------	------	------	------	------	------	------	------	------	------	------	------	------	------	------

U001_S004

SUPPORTING PLATE:DOOR:FRONT LEFT:ASS'Y

41.D1944497 5.54472681 8.AG071013
DECAL:MISFEED R (x4) (x2)
EMOVAL:DE SNAP RING MAGNET CATCH:2
201507-04 X/O 4.5N:ASS'Y

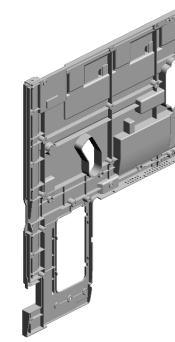

62.D1947801
[A]
SUPPORTING PLATE:DOOR:FRONT LEFT:ASS'Y
201507-06 O/O

43.D0747839
DECAL:MISFEED R
EMOVAL:Z-2

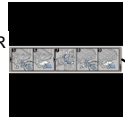

42.D0747838
DECAL:MISFEED R
EMOVAL:Z-1

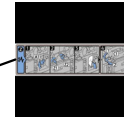

10.B2341293
LEVER - SAFETY SWITCH



3.08025324
(x6)
HEXAGON HEAD TAPPING SCREW:P
F:4X10

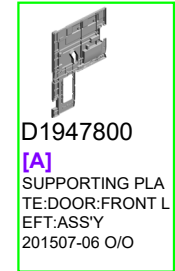

D1947800
[A]
SUPPORTING PLATE:DOOR:FRONT LEFT:ASS'Y
201507-06 O/O

U001_S005
DOOR:FRONT RIGHT:UPPER:ASS'Y

3.08025324

(x2)
HEXAGON HEAD TAPPING SCREW:P
F:4X10

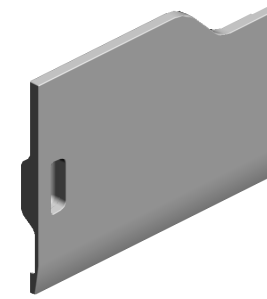

33.D0747810
DOOR:FRONT RIG
HT:UPPER:ASS'Y

U001_S006
SUPPORTING PLATE:DOOR:FRONT RIGHT:ASS'Y

5.54472681
(x4)
SNAP RING

40.D0747836
DECAL:MISFEED R
EMOVAL:AB

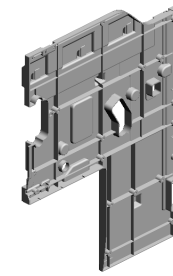

63.D1947816
SUPPORTING PLATE:DOOR:FRONT
RIGHT:ASS'Y

39.D0747835
DECAL:MISFEED R
EMOVAL:LOCATION

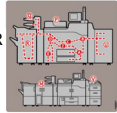

3.08025324
(x6)
HEXAGON HEAD TAPPING SCREW:PF:4X10

10.B2341293
LEVER - SAFETY SWITCH

8.AG071013
(x2)
MAGNET CATCH:2
4.5N:ASS'Y

U001_S007
COVER:MAIN:LEFT:ASS'Y

2.04514008N 55.D1947720
TAPPING SCREW:
4X8 (x4)
SEAL:EXTERIOR:ENTRANCE
XIT:GUIDE PLATE:ENTRANCE

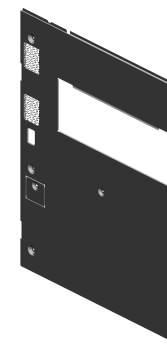
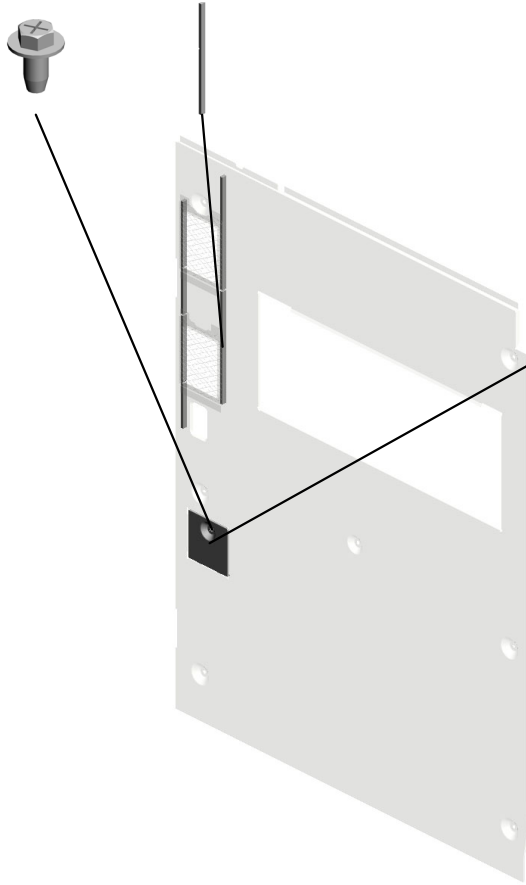

54.D1947716
COVER:MAIN:LEFT
:ASS'Y

38.D0747831
COVER:CONNECTOR:
LARGE CAPACITY TRAY

2.04514008N(x 7)
TAPPING SCREW:4X8

U001_S008
(D194-NA,CHN,AA):(D195/D203/D204):COVER:MAIN:RIGHT:ASS'Y

37.D0747830
(D194-NA,CHN,AA):
(D195/D203/D204):
COVER:LARGE CAPACI
TAY TRAY

35.D0747828
(D194-NA,CHN,AA):
(D195/D203/D204):
CAP:CONNECTOR

36.D0747829
(x4)
(D194-NA,CHN,AA):
(D195/D203/D204):
CAP:JOINT:LARGE
CAPACITY TRAY

38.D0747831
COVER:CONNECT
OR:LARGE CAPACI
TY TRAY

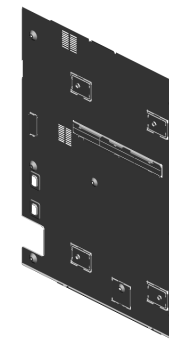

70.D0A57826
[A]
(D194-NA,CHN,AA):
(D195/D203/D204):
COVER:MAIN:RIGH
T:ASS'Y
201806-01 X/X

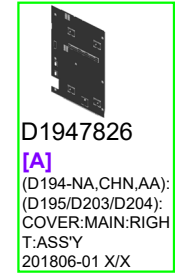

D1947826
[A]
(D194-NA,CHN,AA):
(D195/D203/D204):
COVER:MAIN:RIGH
T:ASS'Y
201806-01 X/X

U001	U002	U003	U004	U005	U006	U007	U008	U009	U010	U011	U012	U013	U014	U015	U016	U017	U018	U019	U020	U021
------	------	------	------	------	------	------	------	------	------	------	------	------	------	------	------	------	------	------	------	------

U002.OPERATION

U002 S001
D1957230
(-AA,-NA):OPERATION PANE
L:ASSY



U002 S002
D1957230
(-AA,-NA):OPERATION PANE
L:ASSY



U002 S003
D1957231
(-EU):OPERATION PANEL:AS
S'Y

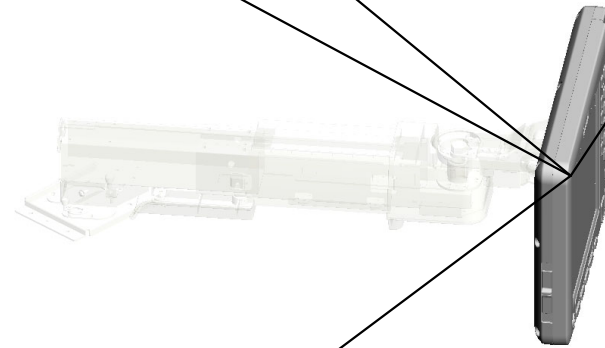

U002 S004
D1957232
(-CHN):OPERATION PANEL:A
SS'Y



U001	U002	U003	U004	U005	U006	U007	U008	U009	U010	U011	U012	U013	U014	U015	U016	U017	U018	U019	U020	U021
------	-------------	------	------	------	------	------	------	------	------	------	------	------	------	------	------	------	------	------	------	------

U002_S001.(-AA,-NA):OPERATION PANEL:ASS'Y

U002 S001 S001
D1797302
COVER:FRONT:ASS'Y



U001	U002	U003	U004	U005	U006	U007	U008	U009	U010	U011	U012	U013	U014	U015	U016	U017	U018	U019	U020	U021
------	-------------	------	------	------	------	------	------	------	------	------	------	------	------	------	------	------	------	------	------	------

U002_S002.(-AA,-NA):OPERATION PANEL:ASS'Y

U002 S002 S001
D1797302
COVER:FRONT:ASS'Y



U001	U002	U003	U004	U005	U006	U007	U008	U009	U010	U011	U012	U013	U014	U015	U016	U017	U018	U019	U020	U021
------	-------------	------	------	------	------	------	------	------	------	------	------	------	------	------	------	------	------	------	------	------

U002_S003.(-EU):OPERATION PANEL:ASS'Y

U002 S003 S001
D1797303
(-EU):COVER:FRONT:ASS'Y



U001	U002	U003	U004	U005	U006	U007	U008	U009	U010	U011	U012	U013	U014	U015	U016	U017	U018	U019	U020	U021
------	-------------	------	------	------	------	------	------	------	------	------	------	------	------	------	------	------	------	------	------	------

U002_S004.(-CHN):OPERATION PANEL:ASS'Y

U002 S004 S001
D1797304
(-CHN):COVER:FRONT:ASS'Y



U001	U002	U003	U004	U005	U006	U007	U008	U009	U010	U011	U012	U013	U014	U015	U016	U017	U018	U019	U020	U021
------	------	------	------	------	------	------	------	------	------	------	------	------	------	------	------	------	------	------	------	------

U002 OPERATION

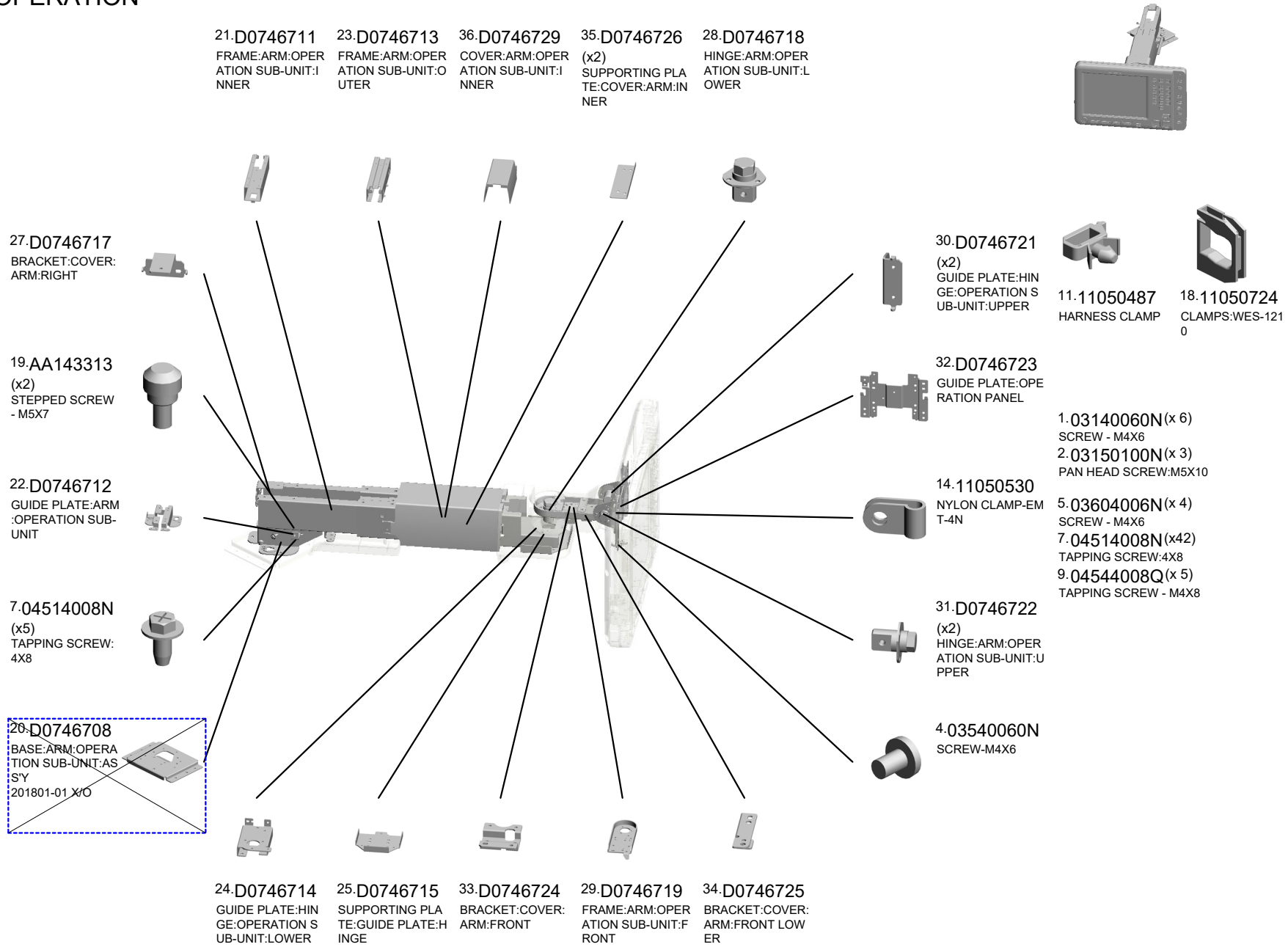

U002 OPERATION

38.D0746731 COVER:ARM:OPERATION SUB-UNIT:LEFT
 42.D1946737 CAP:COVER:ARM:FRONT
 81.D0BX1594 HOLDER:HINGE:OPERATION SUB-UNIT:LOWER



37.D0746730 COVER:ARM:OPERATION SUB-UNIT:RIGHT LOWER

79.D0746709 BASE:ARM:OPERATION SUB-UNIT

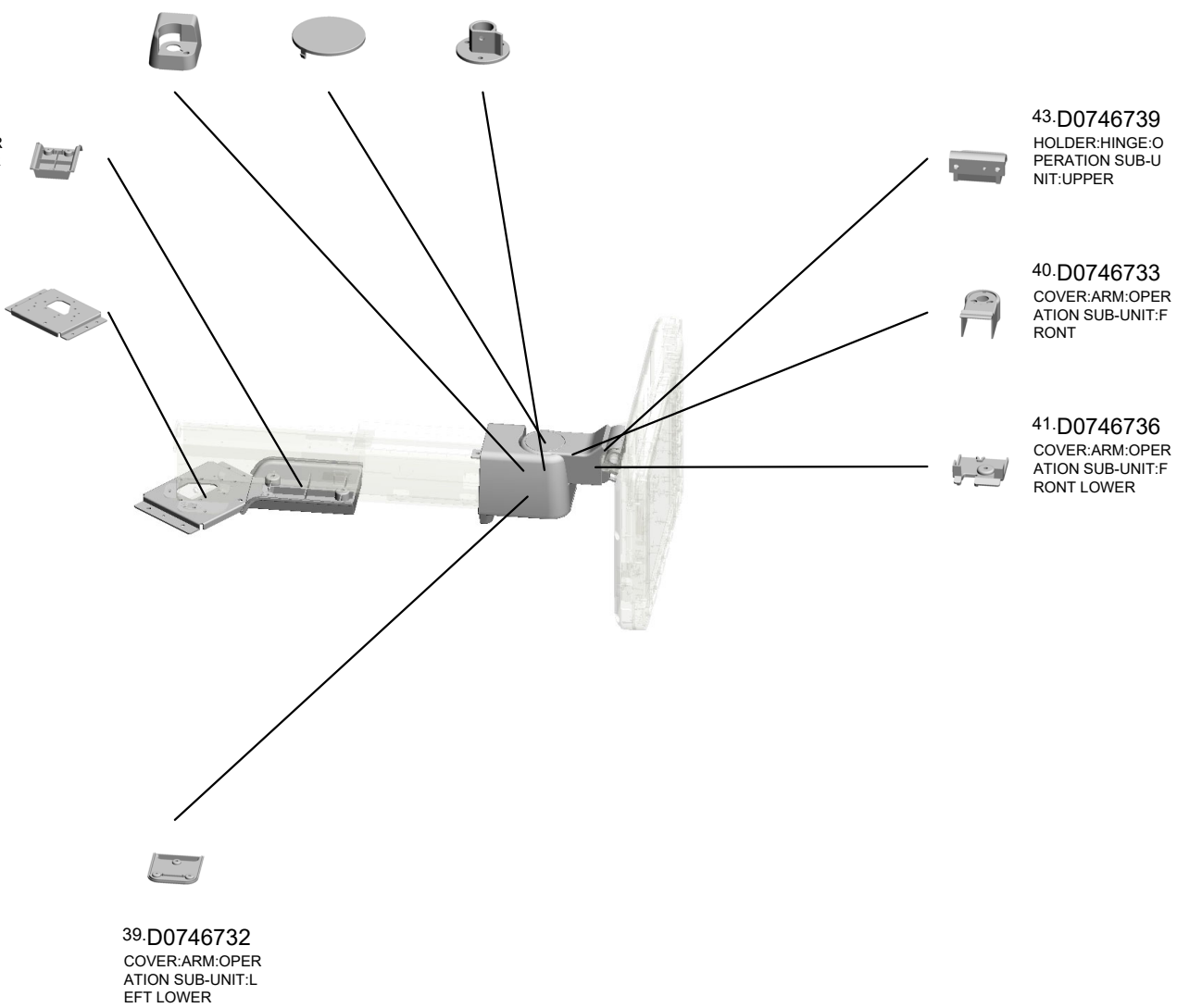

U002_S001
 (-AA,-NA):OPERATION PANEL:ASS'Y

- 47.D1797299 LCD:10.4SVGA_SH
- 55.D1797330 COVER:REAR
- 3.03530040N (x18) SCREW - M3X4
- 8.04523010P (x4) BINDING SELF-TAPPING SCREW:3X10
- 6.04503010N (x36) TAPPING SCREW - M3X10

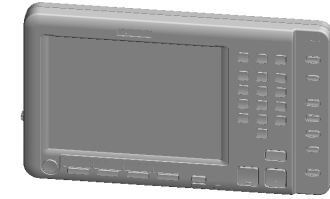

65.D1957230
 [A]
 (-AA,-NA):OPERATION PANEL:ASS'Y
 201609-04 O/O

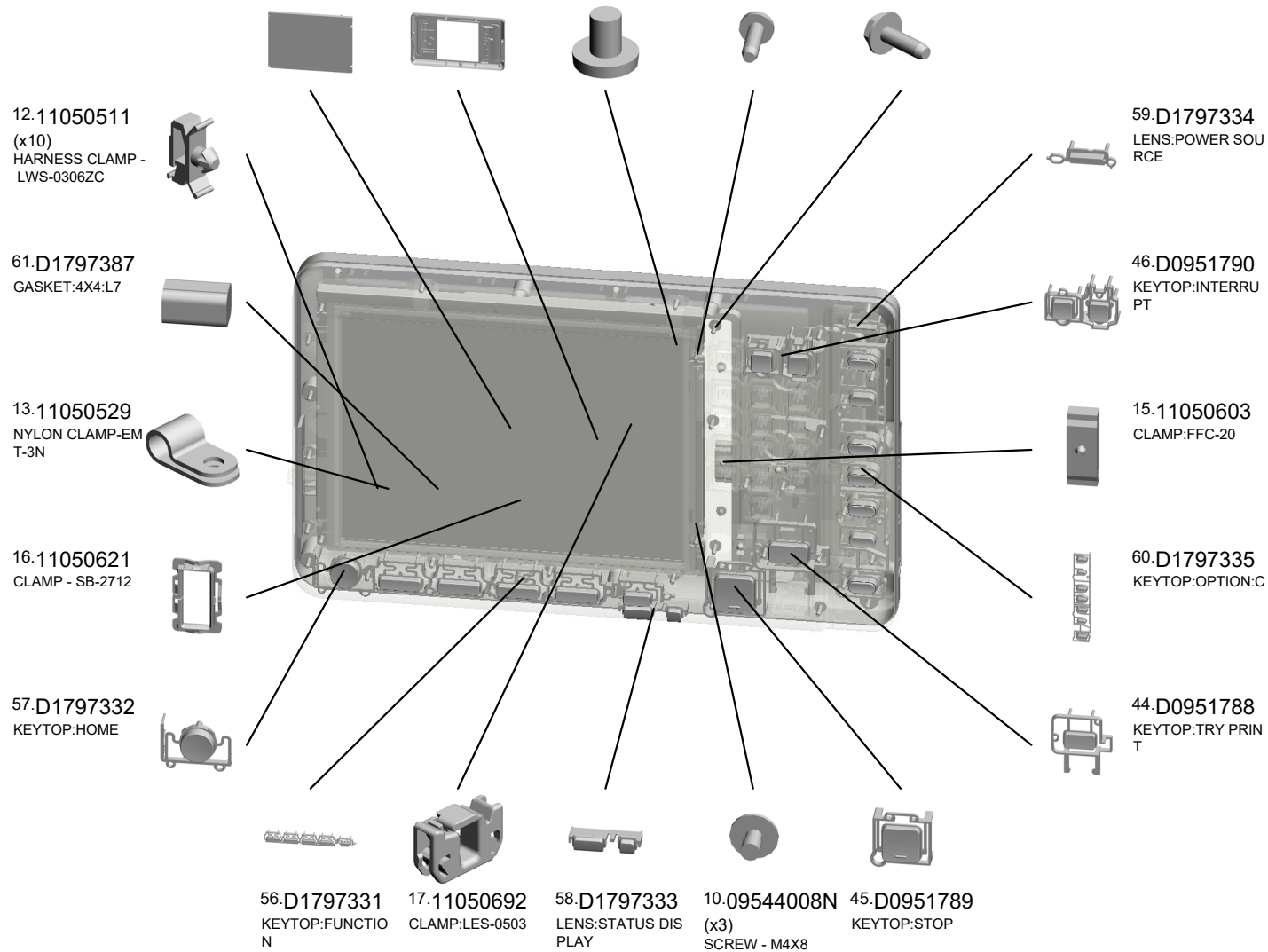

U002_S001
 (-AA,-NA):OPERATION PANEL:ASS'Y

76.M0771800 80.D1957238 64.D1797390 75.M0771769
 TOUCH PANEL:10. PCB:IOKEY:ASS'Y (x2) GASKET:10X10:L38 KEYTOP:RESET SWITCH

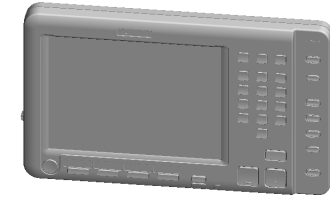

65.D1957230
 [A]
 (-AA,-NA):OPERATION PANEL:ASS'Y
 201609-04 O/O

69.D1957250
 PCB:LCD CAR2FT:ASS'Y

72.M0771766
 KNOB:VARIABLE RESISTOR

68.D1957245
 ABSORPTION SHEET:LCD

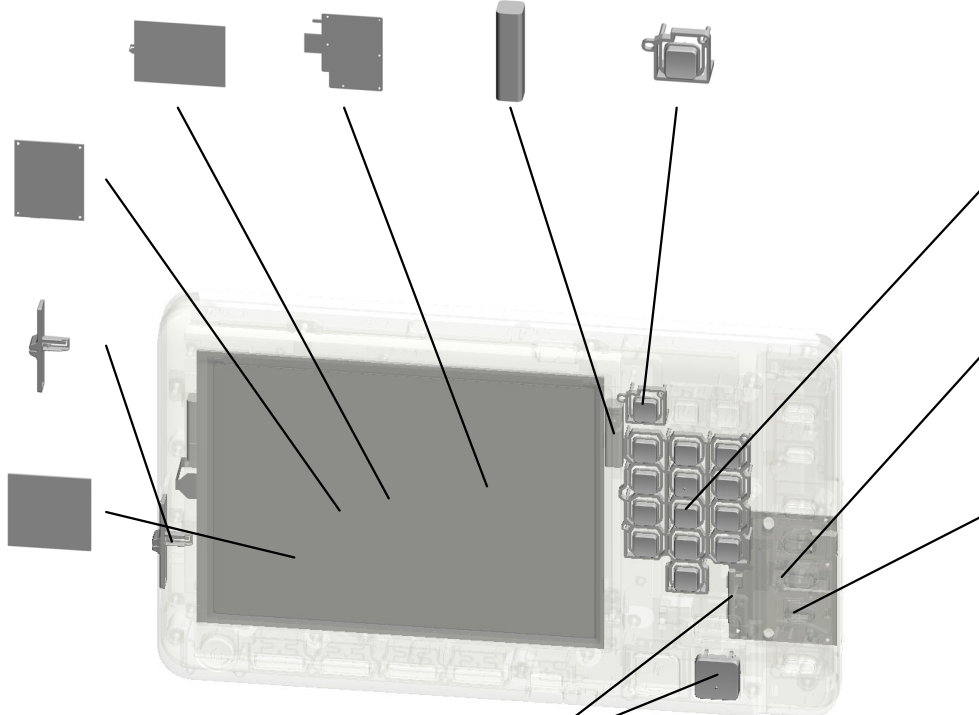

74.M0771768
 KEYTOP:10KEY

70.D1957254
 PCB:SVGA:SDUSB:ASS'Y

63.D1797389
 GASKET:7X2:L15

73.M0771767
 KEYTOP:START

62.D1797388
 GASKET:4X4:L33

D1957211
 [A]
 (-AA,-NA):OPERATION PANEL:ASS'Y
 201609-04 O/O

U002_S001_S001
COVER:FRONT:ASS'Y

6.04503010N
(x2)
TAPPING SCREW -
M3X10

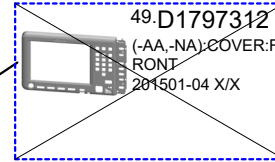
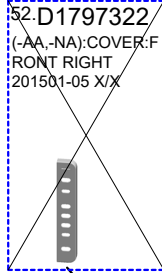

77.D1797302
COVER:FRONT:AS
SY



U002_S002
 (-AA,-NA):OPERATION PANEL:ASS'Y

- 47.D1797299 LCD:10.4SVGA_SH
- 55.D1797330 COVER:REAR
- 3.03530040N (x18) SCREW - M3X4
- 8.04523010P (x4) BINDING SELF-TAPPING SCREW:3X10
- 6.04503010N (x36) TAPPING SCREW - M3X10

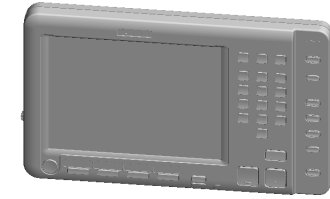

65.D1957230
 [A]
 (-AA,-NA):OPERATION PANEL:ASS'Y
 201609-04 O/O

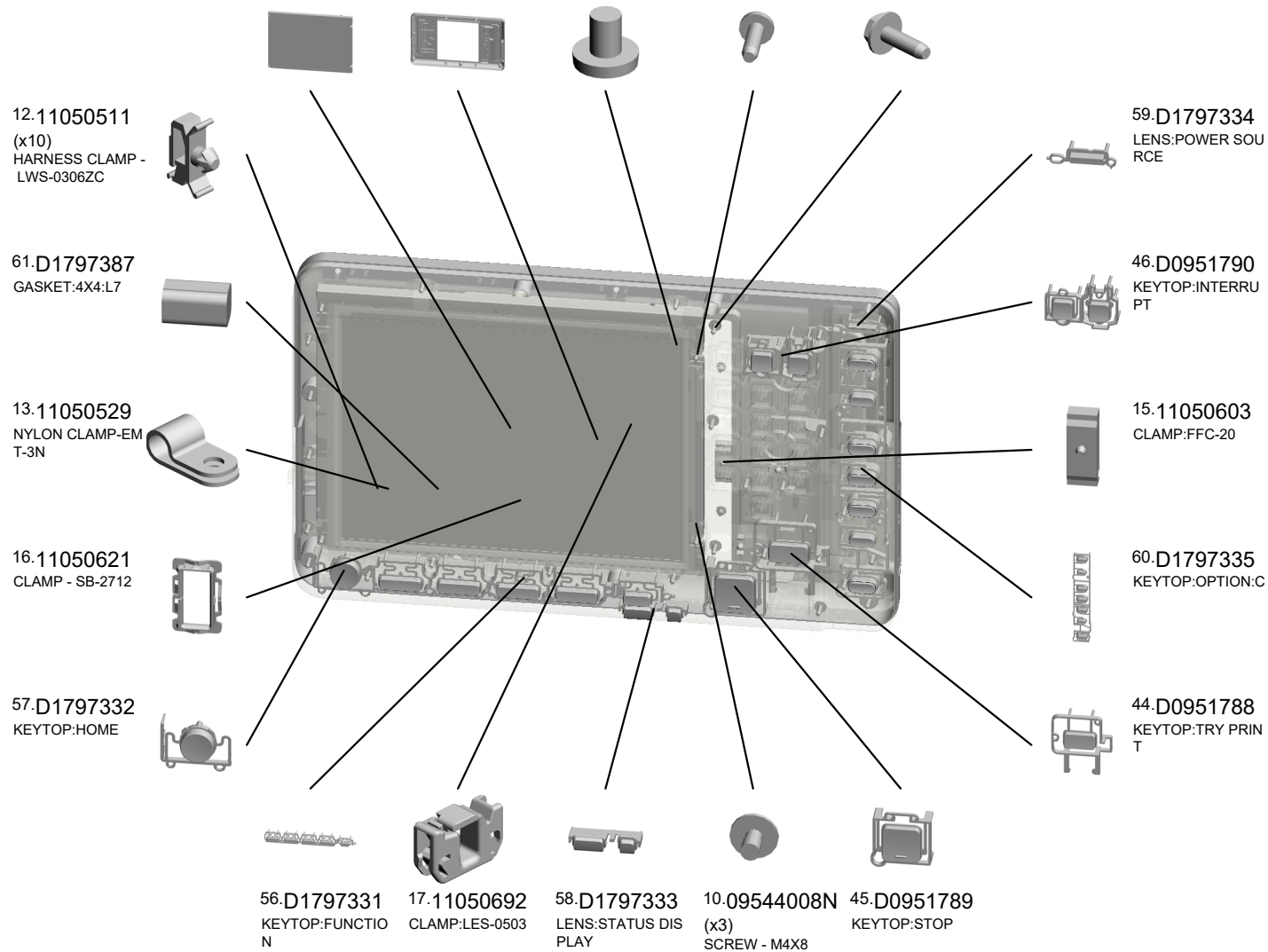

U002_S002
 (-AA,-NA):OPERATION PANEL:ASS'Y

69.D1957250 80.D1957238 64.D1797390 75.M0771769
 PCB:LCD CAR2FT:A PCB:IOKEY:ASS'Y (x2) KEYTOP:RESET SWITCH
 SS'Y GASKET:10X10:L38

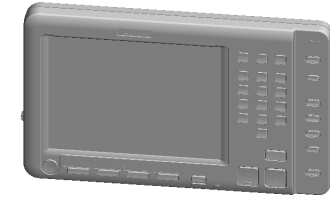

65.D1957230
 [A]
 (-AA,-NA):OPERATION PANEL:ASS'Y
 201609-04 O/O

76.M0771800
 TOUCH PANEL:10.4INCH

72.M0771766
 KNOB:VARIABLE RESISTOR

68.D1957245
 ABSORPTION SHEET:LCD

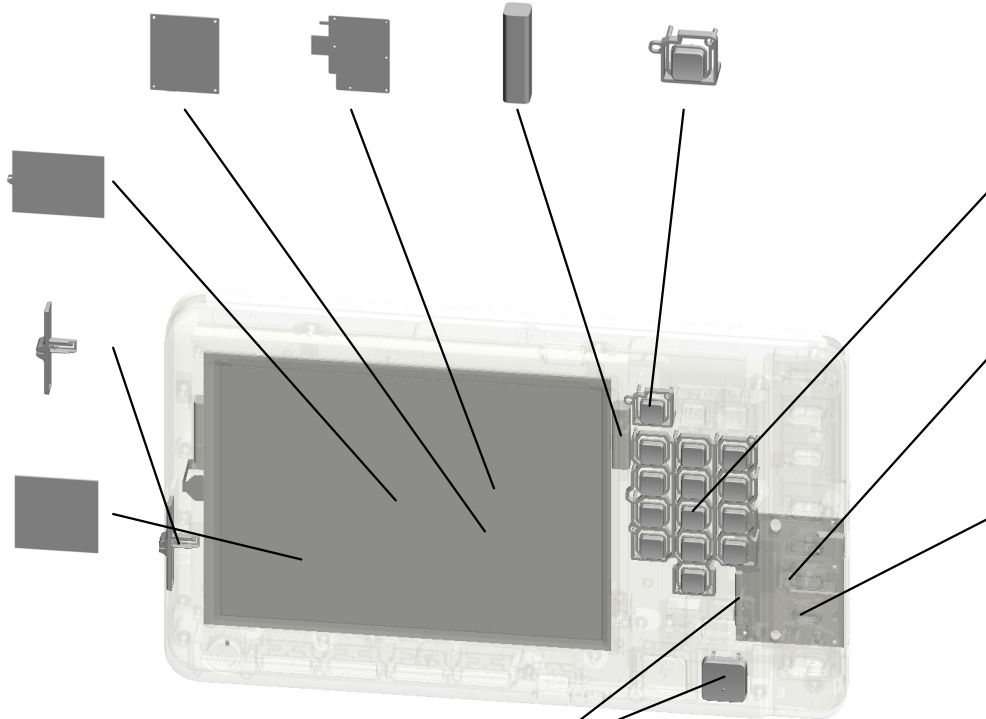

74.M0771768
 KEYTOP:10KEY

70.D1957254
 PCB:SVGA:SDUSB:ASS'Y

63.D1797389
 GASKET:7X2:L15

73.M0771767
 KEYTOP:START

62.D1797388
 GASKET:4X4:L33

D1957211
 [A]
 (-AA,-NA):OPERATION PANEL:ASS'Y
 201609-04 O/O

U002_S002_S001
COVER:FRONT:ASS'Y

6.04503010N 52.D1797322
(x2) (-AA,-NA):COVER:F
TAPPING SCREW - RONT RIGHT
M3X10



77.D1797302
COVER:FRONT:AS
SY

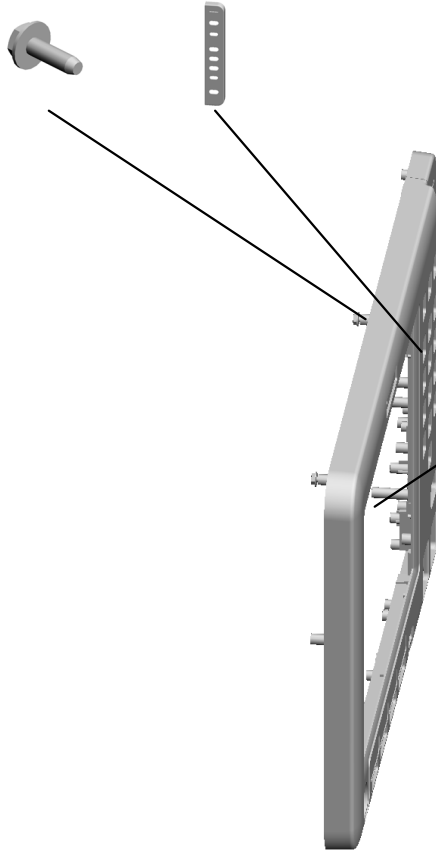

49.D1797312
(-AA,-NA):COVER:F
RONT

U002_S003
(-EU):OPERATION PANEL:ASS'Y

- 47.D1797299 LCD:10.4SVGA_SH
- 55.D1797330 COVER:REAR
- 3.03530040N (x18) SCREW - M3X4
- 8.04523010P (x4) BINDING SELF-TAPPING SCREW:3X10
- 6.04503010N (x36) TAPPING SCREW - M3X10

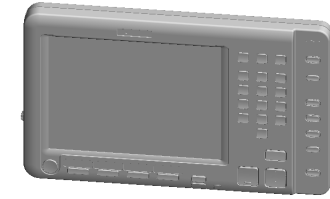

66.D1957231
[A]
(-EU):OPERATION
PANEL:ASS'Y
201609-05 O/O

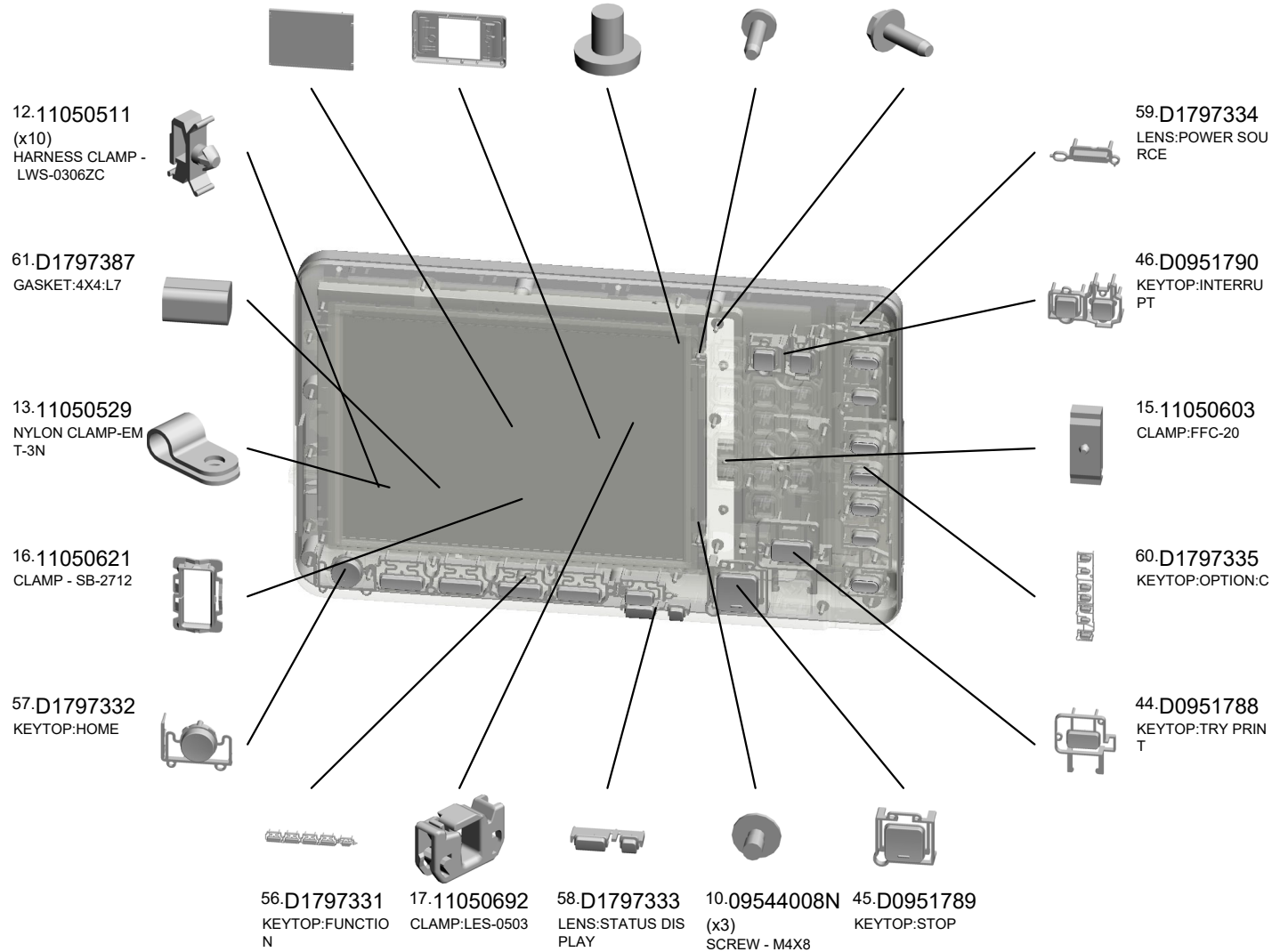

U002_S003
(-EU):OPERATION PANEL:ASS'Y

76.M0771800 TOUCH PANEL:10.4INCH
80.D1957238 PCB:IOKEY:ASS'Y
64.D1797390 (x2) GASKET:10X10:L38
75.M0771769 KEYTOP:RESET SWITCH

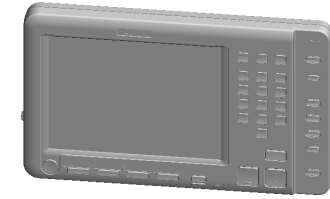

66.D1957231
[A]
(-EU):OPERATION
PANEL:ASS'Y
201609-05 O/O

69.D1957250
PCB:LCD CAR2FT:ASS'Y

72.M0771766
KNOB:VARIABLE RESISTOR

68.D1957245
ABSORPTION SHEET:LCD

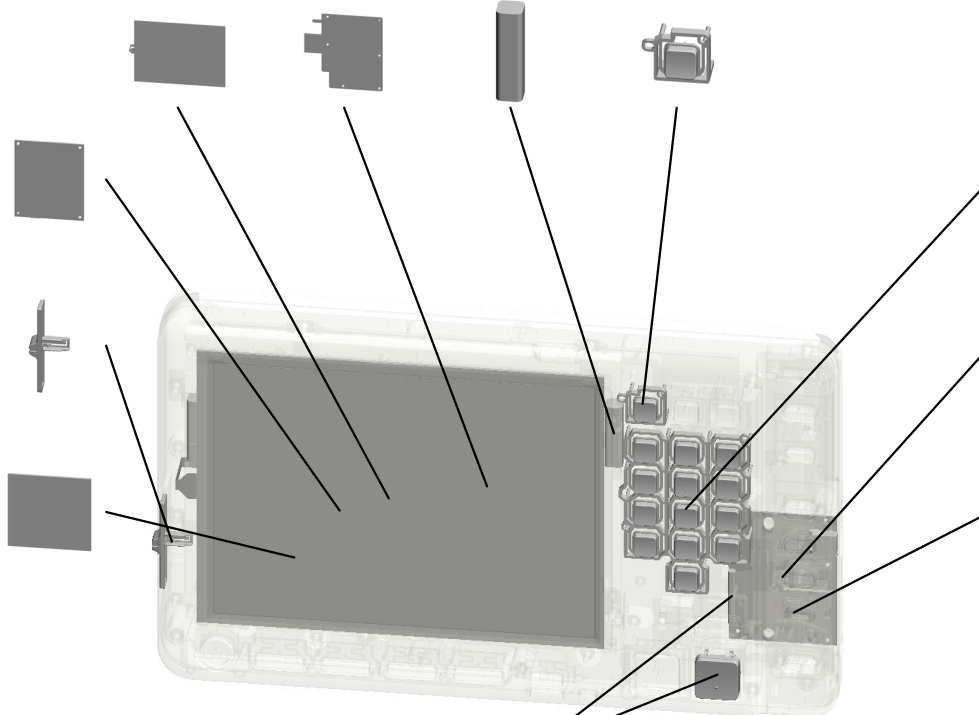

74.M0771768
KEYTOP:10KEY

70.D1957254
PCB:SVGA:SDUSB:ASS'Y

63.D1797389
GASKET:7X2:L15

73.M0771767
KEYTOP:START

62.D1797388
GASKET:4X4:L33

D1957212
[A]
(-EU):OPERATION
PANEL:ASS'Y
201609-05 O/O

U002_S003_S001
(-EU):COVER:FRONT:ASS'Y

6.04503010N
(x2)
TAPPING SCREW -
M3X10



78.D1797303
(-EU):COVER:FRO
NT:ASS'Y

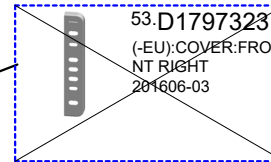
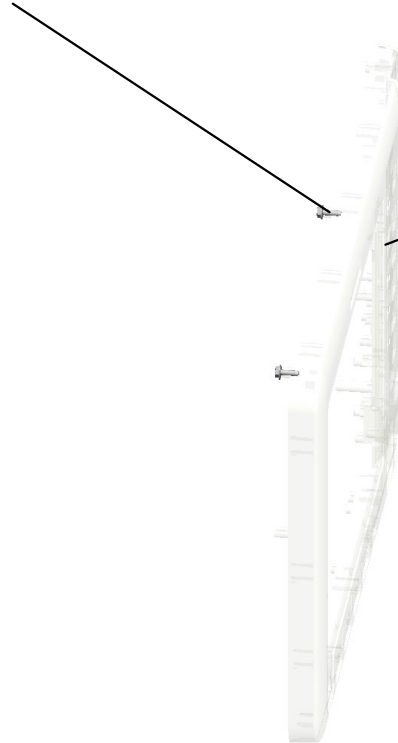

U002_S004
(-CHN):OPERATION PANEL:ASS'Y

- 47.D1797299 LCD:10.4SVGA_SH
- 55.D1797330 COVER:REAR
- 3.03530040N (x18) SCREW - M3X4
- 8.04523010P (x4) BINDING SELF-TAPPING SCREW:3X10
- 6.04503010N (x36) TAPPING SCREW - M3X10

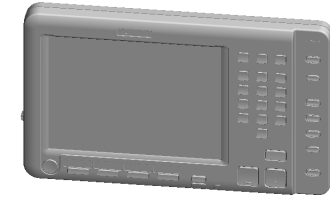

67.D1957232
[A]
(-CHN):OPERATION PANEL:ASS'Y
201609-06 O/O

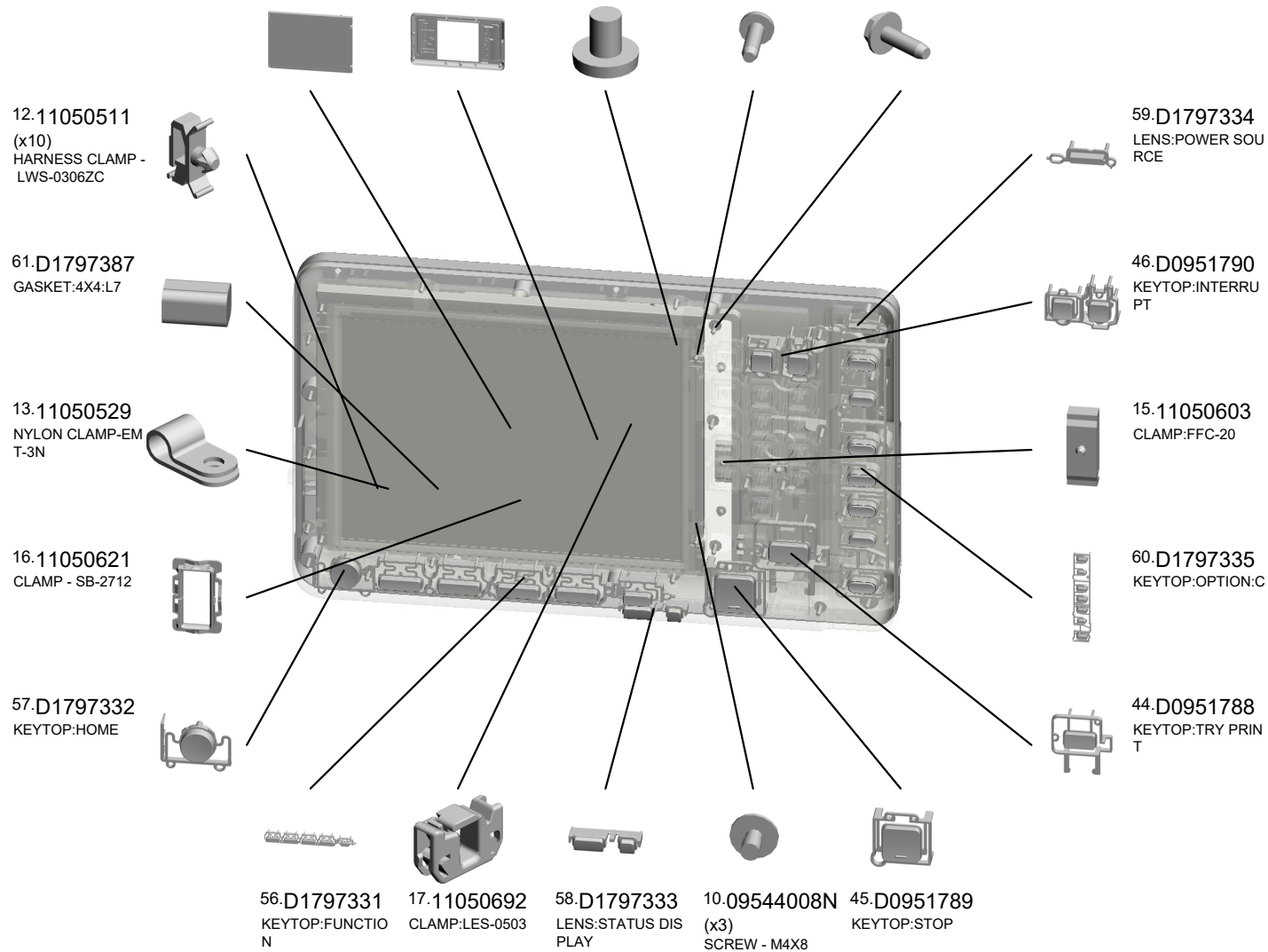

U002_S004
 (-CHN):OPERATION PANEL:ASS'Y

76.M0771800 TOUCH PANEL:10.4INCH
 80.D1957238 PCB:IOKEY:ASS'Y
 64.D1797390 (x2) GASKET:10X10:L38
 75.M0771769 KEYTOP:RESET SWITCH

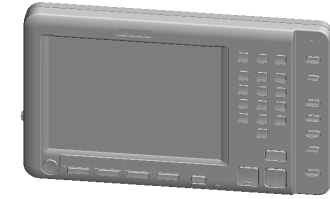

67.D1957232
 [A]
 (-CHN):OPERATION PANEL:ASS'Y
 201609-06 O/O

69.D1957250
 PCB:LCD CAR2FT:ASS'Y

72.M0771766
 KNOB:VARIABLE RESISTOR

68.D1957245
 ABSORPTION SHEET:LCD

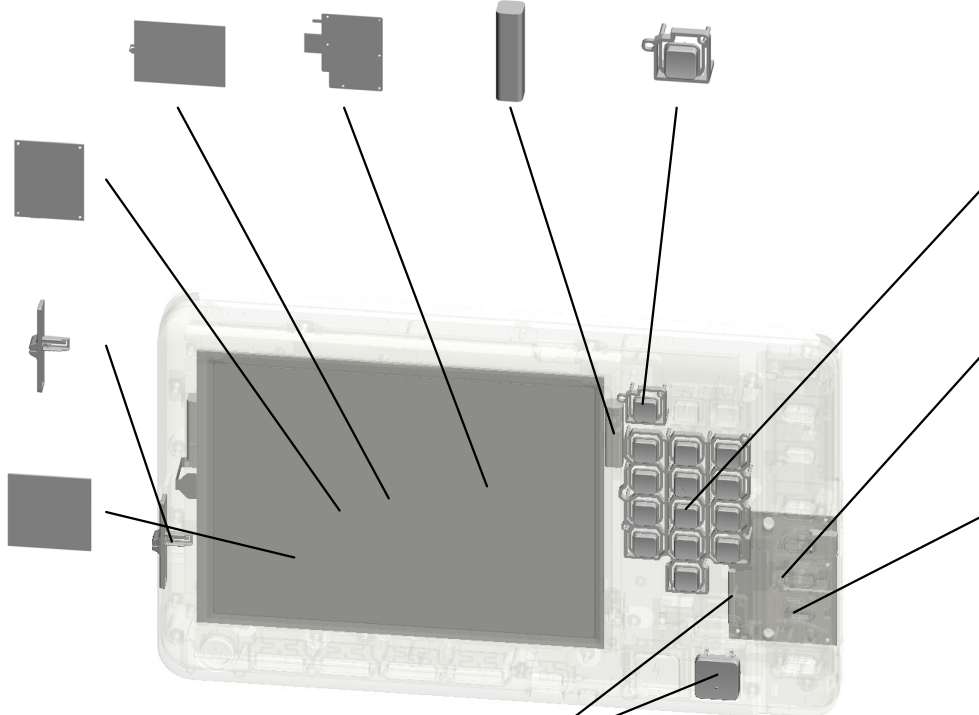

74.M0771768
 KEYTOP:10KEY

70.D1957254
 PCB:SVGA:SDUSB:ASS'Y

63.D1797389
 GASKET:7X2:L15

73.M0771767
 KEYTOP:START

62.D1797388
 GASKET:4X4:L33

D1957213
 [A]
 (-CHN):OPERATION PANEL:ASS'Y
 201609-06 O/O

U002_S004_S001
(-CHN):COVER:FRONT:ASS'Y

6.04503010N 54.D1797324
(x2) (-CHN):COVER:FR
TAPPING SCREW - ONT RIGHT
M3X10



48.D1797304
(-CHN):COVER:FR
ONT:ASS'Y

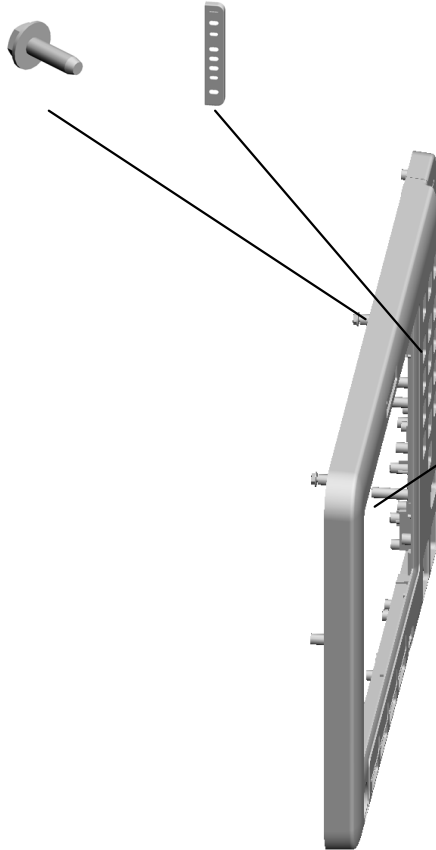

51.D1797314
(-CHN):COVER:FR
ONT

U001	U002	U003	U004	U005	U006	U007	U008	U009	U010	U011	U012	U013	U014	U015	U016	U017	U018	U019	U020	U021
------	------	------	------	------	------	------	------	------	------	------	------	------	------	------	------	------	------	------	------	------

U003.ADF

U003 S001
D1941202
ADF: SINAI-B: ASS'Y

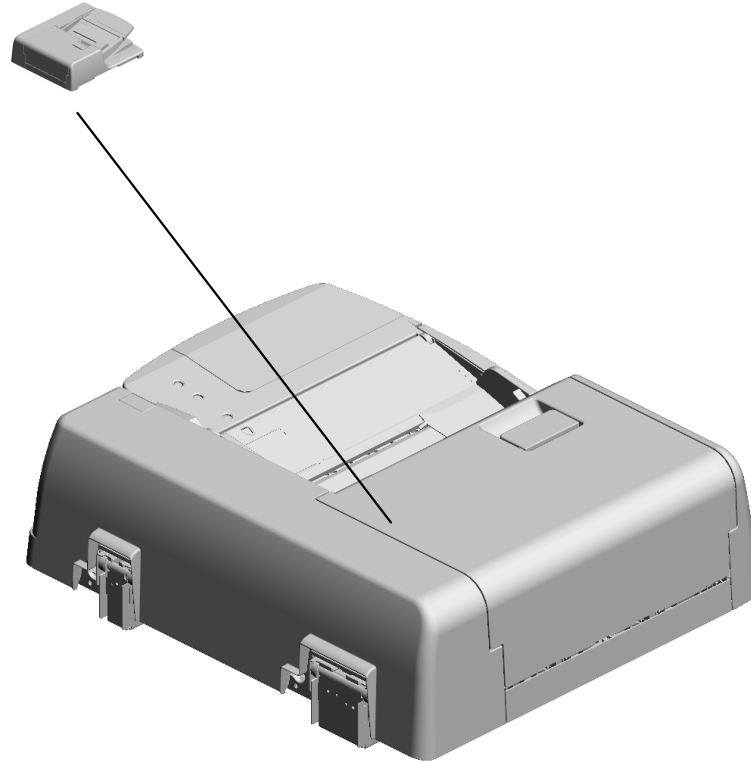

U001	U002	U003	U004	U005	U006	U007	U008	U009	U010	U011	U012	U013	U014	U015	U016	U017	U018	U019	U020	U021
------	------	------	------	------	------	------	------	------	------	------	------	------	------	------	------	------	------	------	------	------

U003_S001.ADF:SINAI-B:ASS'Y

U003 S001 S002
D6831632
SHAFT:REVERSE ROLLER:S
UB-ASS'Y

U003 S001 S005
AX040254
DC MOTOR:RISING TRAY:AS
S'Y:1.007W:BRUSH

U003 S001 S004
D7312202
SHAFT:SEPARATION:ASS'Y

U003 S001 S001
D6831620
SHAFT:SEPARATION:DRIVE:
INPUT:SUB-ASS'Y

U003 S001 S011
D3B04730
PRESSURE PLATE:ASS'Y

U003 S001 S003
D6831640
SHAFT:INPUT:PAPER FEED:
SUB-ASS'Y

U003 S001 S008
D6833646
GUIDE:CONTACT IMAGE SE
NSOR:EXIT:LOWER:ASS'Y

U003 S001 S012
D7314311
GUIDE:PAPER FEED:UPPER:
SUB-ASS'Y

U003 S001 S007
D5433631
ROLLER:SCANNING:BEHIND
:ASS'Y

U003 S001 S010
D6833411
GUIDE:SCANNING:ENTRANC
E:LOWER:SUB-ASS'Y

U003 S001 S006
D6833150
ROLLER:SCANNING:EXIT:DR
IVE:ASS'Y

U003 S001 S009
D6833662
GUIDE PLATE:CONTACT IMA
GE SENSOR:ENTRANCE:AS
S'Y

U001	U002	U003	U004	U005	U006	U007	U008	U009	U010	U011	U012	U013	U014	U015	U016	U017	U018	U019	U020	U021
------	------	------	------	------	------	------	------	------	------	------	------	------	------	------	------	------	------	------	------	------

U003_S001.ADF:SINAI-B:ASS'Y

U003 S001 S013
D7314370
COVER:PAPER FEED:ASS'Y

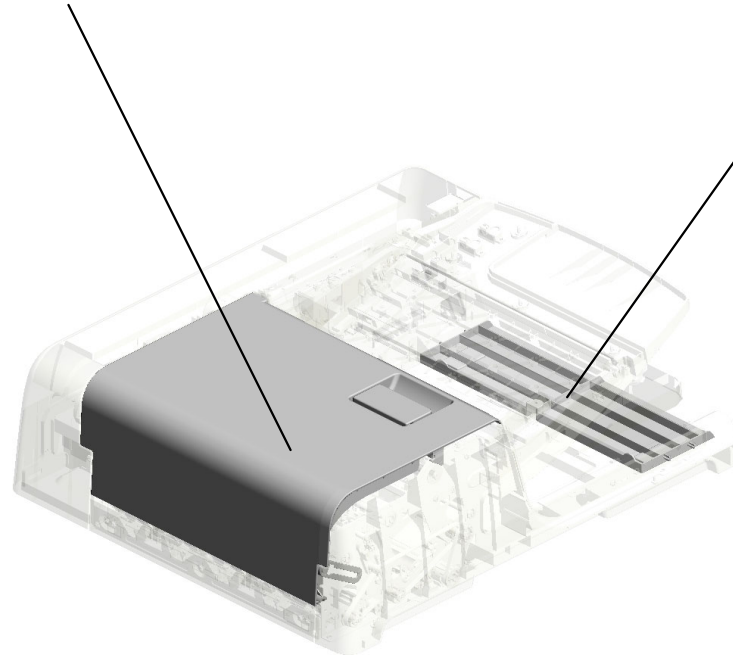
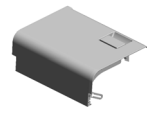

U003 S001 S014
D7314510
COVER:LOWER:ASS'Y



U001	U002	U003	U004	U005	U006	U007	U008	U009	U010	U011	U012	U013	U014	U015	U016	U017	U018	U019	U020	U021
------	------	------	------	------	------	------	------	------	------	------	------	------	------	------	------	------	------	------	------	------

U003_S001_S004.SHAFT:SEPARATION:ASS'Y

U003 S001 S004 S001
D6832240
GUIDE:PAPER FEED:ENTRA
NCE:INNER BACK:ASSY



U001	U002	U003	U004	U005	U006	U007	U008	U009	U010	U011	U012	U013	U014	U015	U016	U017	U018	U019	U020	U021
------	------	------	------	------	------	------	------	------	------	------	------	------	------	------	------	------	------	------	------	------

U003
ADF



36.A8597211
(x2)
STEPPED SCREW

4.04514008N(x 2)
TAPPING SCREW:4X8
17.09514010N(x 2)
SCREW:POLISHED ROUND:M4X10

U003_S001
ADF:SINAI-B:ASS'Y

- 7.04543014Q (x4) TAPPING SCREW: 3X14
- 20.11050692 (x5) CLAMP:LES-0503
- 25.12042612 (x2) MICRO SWITCH:D3 V-16506-3C25
- 15.08050104 (x10) RETAINING RINGS -E:SILENCER:DIA4
- 26.52062686 (x2) SNAP RING



296.D1941202
[A]
ADF:SINAI-B:ASS'Y
202302-04 O/O

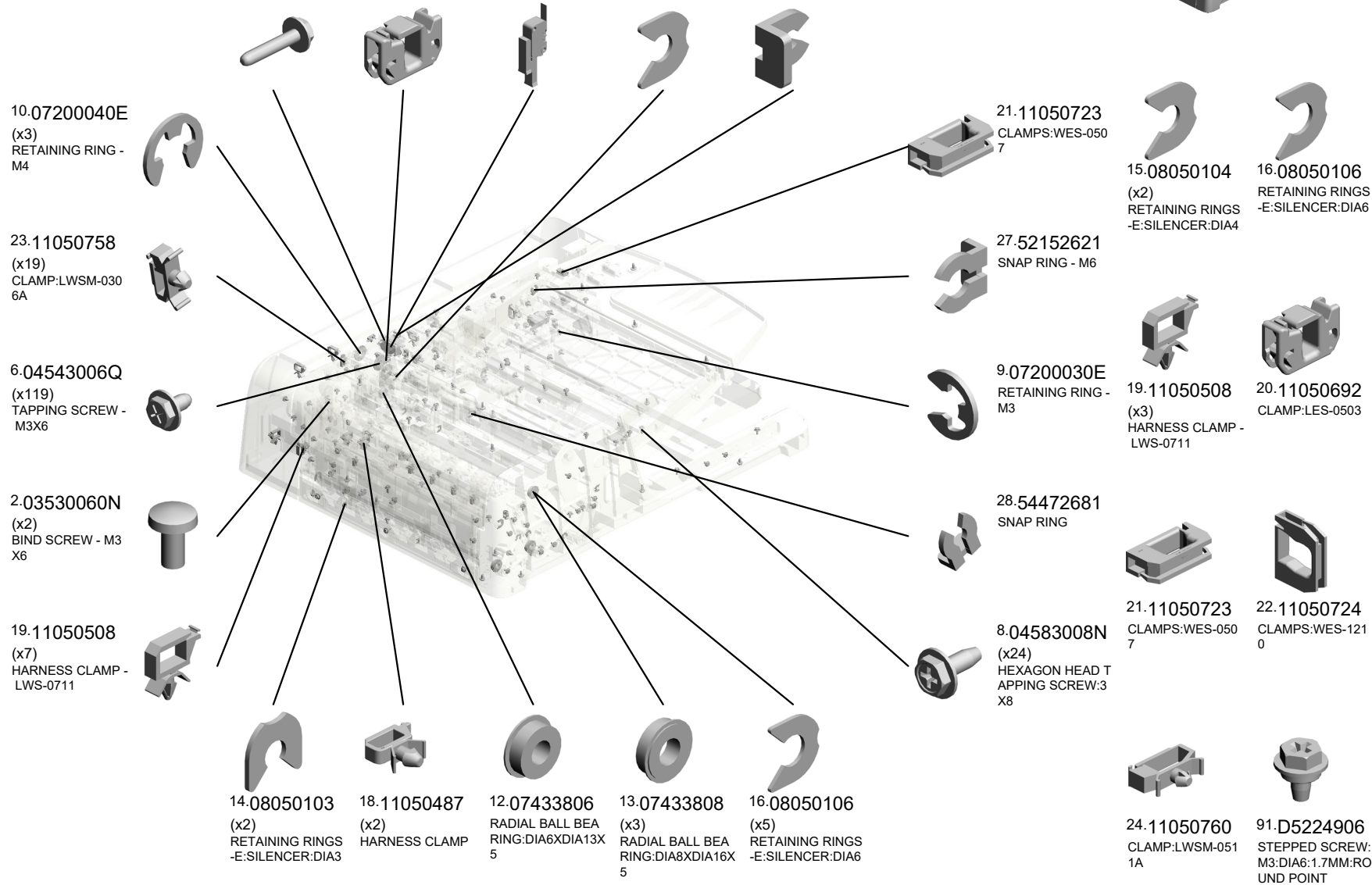

U001	U002	U003	U004	U005	U006	U007	U008	U009	U010	U011	U012	U013	U014	U015	U016	U017	U018	U019	U020	U021
------	------	------	------	------	------	------	------	------	------	------	------	------	------	------	------	------	------	------	------	------

U003_S001
ADF:SINAI-B:ASS'Y

- 52.AA082101 (x6) BUSHING - 6X10X6
- 47.AA043698 SYNCHRONOUS B ELT:40S1.5M300
- 43.AA043683 SYNCHRONOUS B ELT:60S1.5M204
- 42.AA043682 SYNCHRONOUS B ELT:60S1.5M150
- 51.AA080347 BUSHING - 8MM



296.D1941202
[A]
ADF:SINAI-B:ASS'Y
202302-04 O/O

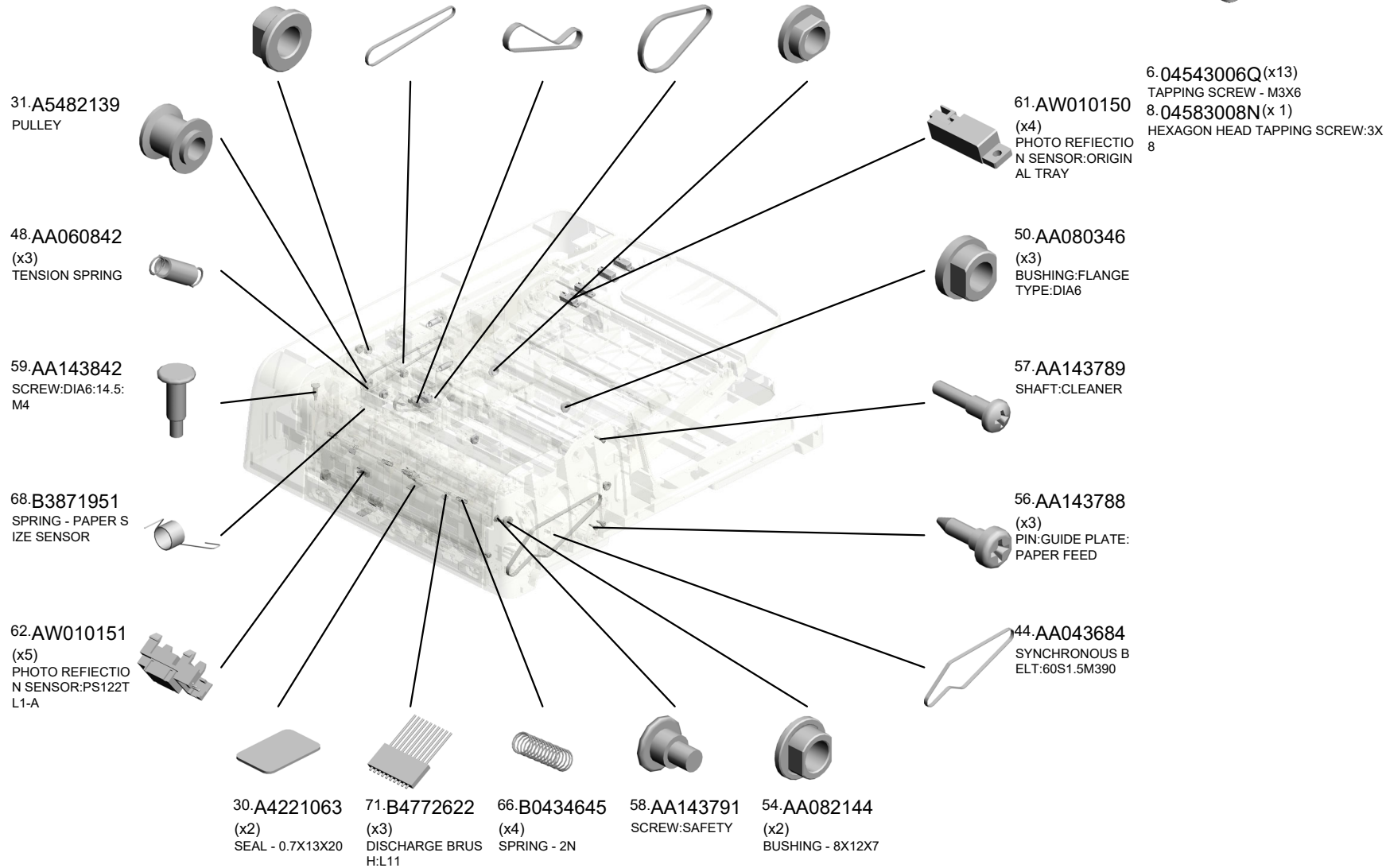

U003_S001
ADF:SINAI-B:ASS'Y

76.B6523174 TENSION SPRING
79.B7061859 SCREW:SLIDER:LOCK
85.B8722524 SPACER:DIA9
84.B8301135 SCREW
86.D0951260 CAP:COVER:SCA



296.D1941202
[A]
ADF:SINAI-B:ASS'Y
202302-04 O/O

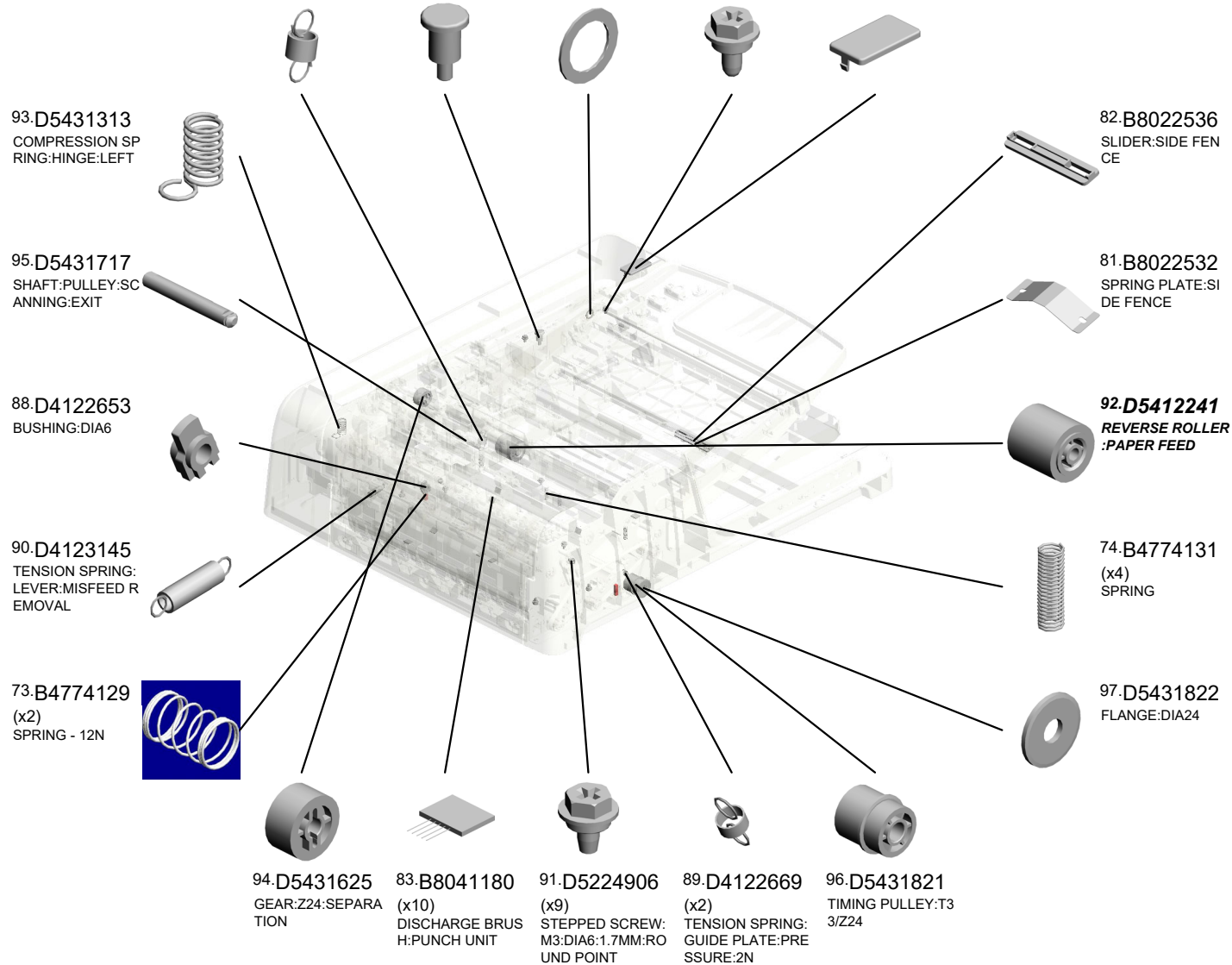

U003_S001
ADF:SINAI-B:ASS'Y



296.D1941202
[A]
ADF:SINAI-B:ASS'Y
202302-04 O/O

- 118.D6831617 DC MOTOR:ASS'Y: 20W:BRUSHLESS
- 108.D6831385 BRACKET:SAFETY SWITCH:PAPER FEED
- 109.D6831386 SHAFT:CONTACT POINT:ON OFF DETECTOR:PAPER FEED
- 121.D6831635 GEAR:REVERSE ROLLER:DRIVE
- 110.D6831387 TENSION SPRING: ON OFF DETECTOR:PAPER FEED

125.D6831644 SPACER:SHAFT:INPUT:PAPER FEED

126.D6831671 BRACKET:MOTOR: PICK UP

117.D6831615 STAY:MOTOR:PAPER FEED

123.D6831642 TIMING PULLEY:IDLER:PULL OUT

104.D6421454 FEELER:APS

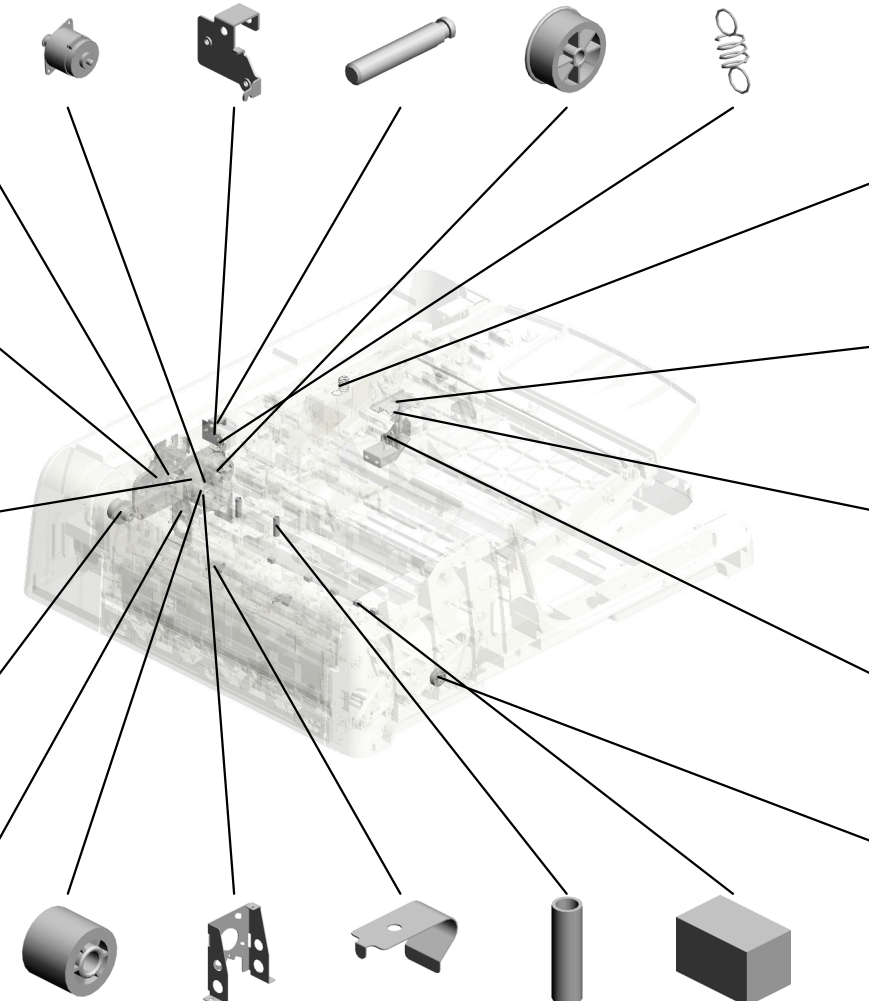

107.D6831362 COMPRESSION SPRING:HINGE:RIGHT

111.D6831413 BRACKET:SAFETY SWITCH

112.D6831414 SPRING PLATE:SAFETY SWITCH

113.D6831415 FEELER:SENSOR: ON OFF DETECTOR

100.D5433635 GEAR:ROLLER:SCANNING:BEHIND

- 124.D6831643 GEAR:INPUT:PAPER FEED
- 116.D6831614 BRACKET:MOTOR: PAPER FEED
- 103.D5435125 (x2) SPRING PLATE:CONTACT IMAGE SENSOR
- 101.D5434382 (x2) COMPRESSION SPRING:PULL OUT
- 102.D5434393 (x6) CUSHION:GUIDE PLATE:ENTRANCE: PAPER FEED:INNER BACK

U001	U002	U003	U004	U005	U006	U007	U008	U009	U010	U011	U012	U013	U014	U015	U016	U017	U018	U019	U020	U021
------	------	------	------	------	------	------	------	------	------	------	------	------	------	------	------	------	------	------	------	------

U003_S001
ADF:SINAI-B:ASS'Y

- 129.D6831682 TIMING PULLEY:PI
CKUP:DRIVE
- 128.D6831680 CAM:PICKUP
- 138.D6831822 (x2)
DC MOTOR:20W:S
CANNING:20W:BR
USHLESS
- 131.D6831711 BRACKET:MOTOR:
PULL OUT
- 132.D6831718 (x2)
STAY:MOTOR:PUL
L OUT



296.D1941202
[A]
ADF:SINAI-B:ASS'Y
202302-04 O/O

130.D6831691
GEAR:PAPER FEE
D:COUPLING



127.D6831675
DC STEPPER MOT
OR: DIA42:T15:S2M:
ASS'Y



146.D6832112
(x2)
TIMING PULLEY:R
OLLER:PULL OUT:
DRIVE



134.D6831766
(x2)
DC MOTOR:10W:B
RUSHLESS



133.D6831762
BRACKET:MOTOR:
MIDDLE

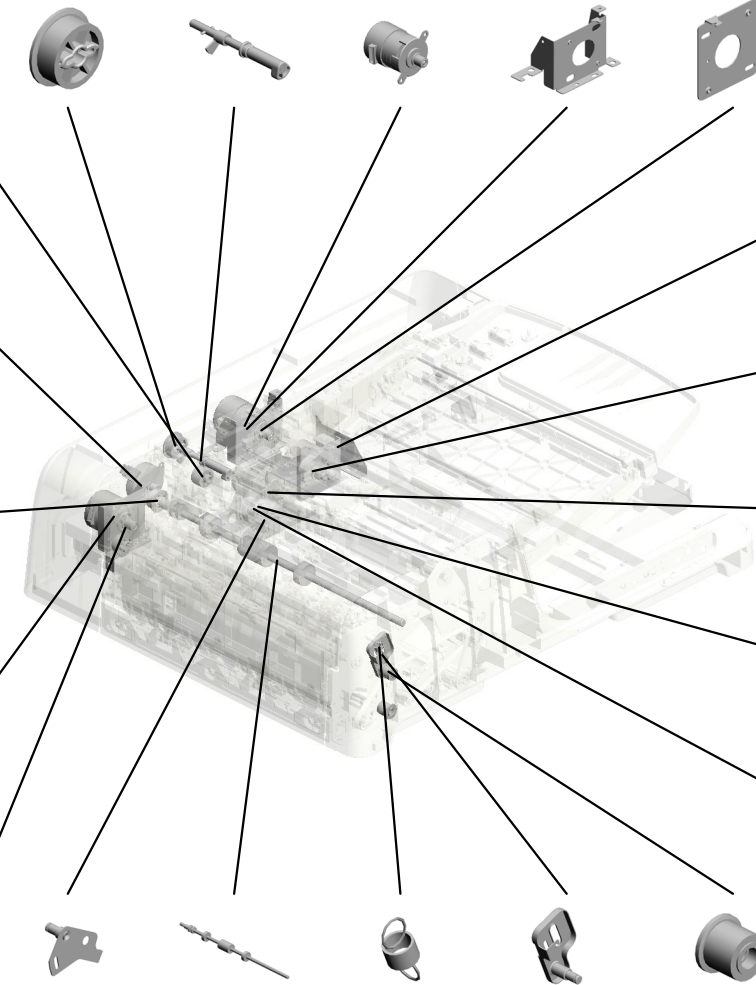

144.D6831912
BRACKET:HINGE:R
IGHT

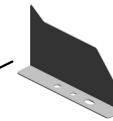

137.D6831814
TIMING PULLEY:C
OUPLING:EXIT

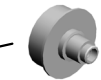

135.D6831811
BRACKET:MOTOR:
SCANNING:EXIT



136.D6831813
TIMING PULLEY:C
OUPLING:SCANNI
NG:INNER BACK

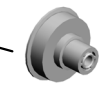

140.D6831845
(x2)
PULLEY:IDLER:DIA
14



- 139.D6831841 BRACKET:TENSIO
NER:SCANNING:IN
NER BACK
- 145.D6832110 ROLLER:PULL OUT
:DRIVE
- 143.D6831856 TENSION SPRING:
TENSION:SCANNI
NG:FRONT
- 141.D6831851 BRACKET:TENSIO
NER:SCANNING:F
RONT
- 142.D6831855 TIMING PULLEY:TE
NSIONER:SCANNI
NG:FRONT

U003_S001
ADF:SINAI-B:ASS'Y

- 163.D6832417 SHEET:ENTRANCE :SEPARATION PAD
- 166.D6832729 JOINT:RISING TRAY:AUXILIARY
- 165.D6832728 STOPPER:RELEASE:SHAFT:BASE
- 169.D6832743 (x2) SHEET:CUSHION:STOPPER PAWL
- 162.D6832393 HOLDER:ORIGINAL TABLE



296.D1941202
[A]
ADF:SINAI-B:ASS'Y
202302-04 O/O

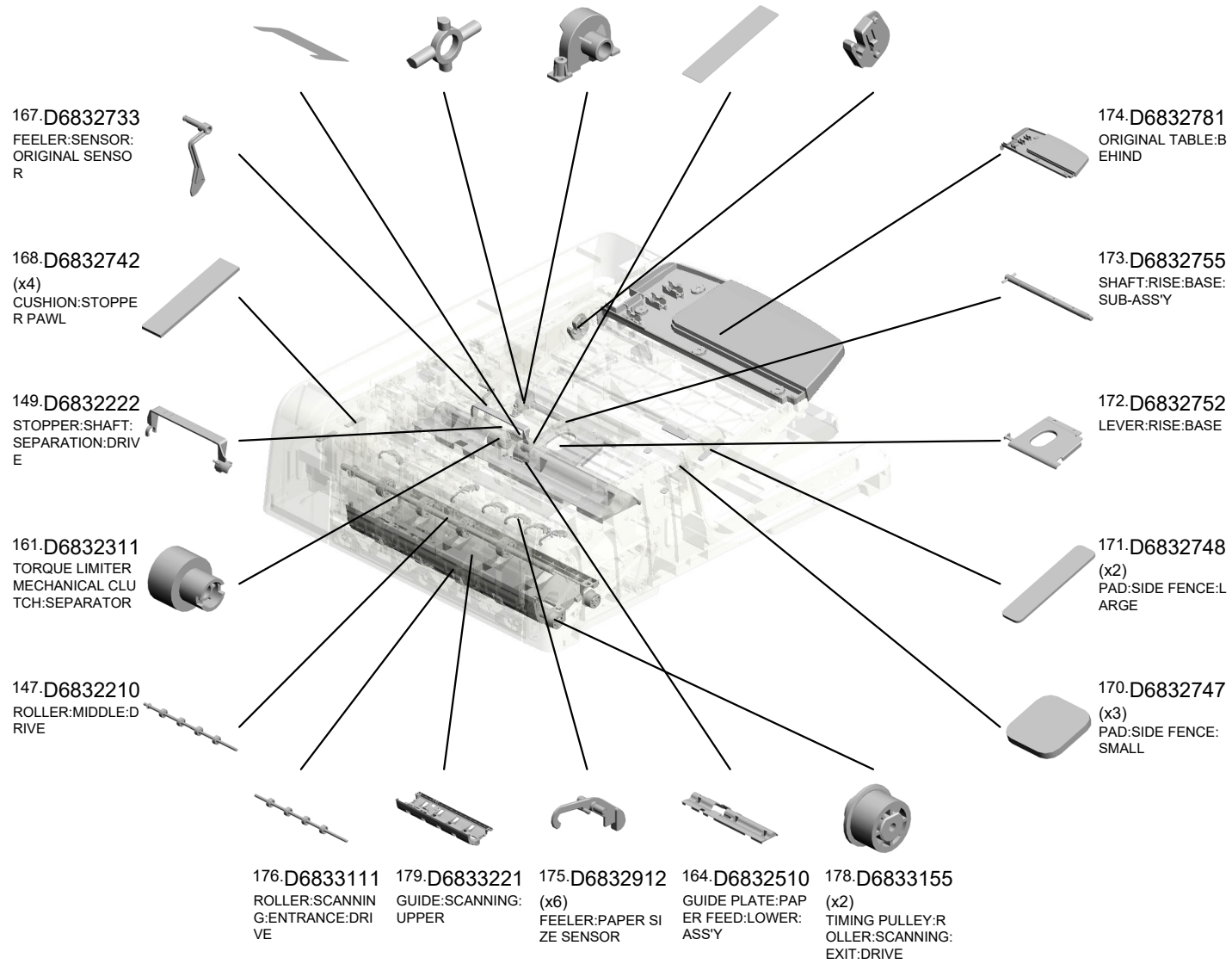

U003_S001
ADF:SINAI-B:ASS'Y

- 200.D6833714 TIMING PULLEY:R
OLLER:CIS:EXIT:D
RIVE
- 205.D6833915 TIMING PULLEY:R
OLLER:EXIT:DRIVE
- 194.D6833645 (x2)
ROLLER:MIDDLE:D
RIVEN
- 188.D6833510 SHAFT:LEVER:MIS
FEED REMOVAL:A
SS'Y
- 189.D6833616 (x2)
BRACKET:DISCHA
RGE BRUSH



296.D1941202
[A]
ADF:SINAI-B:ASS'Y
202302-04 O/O

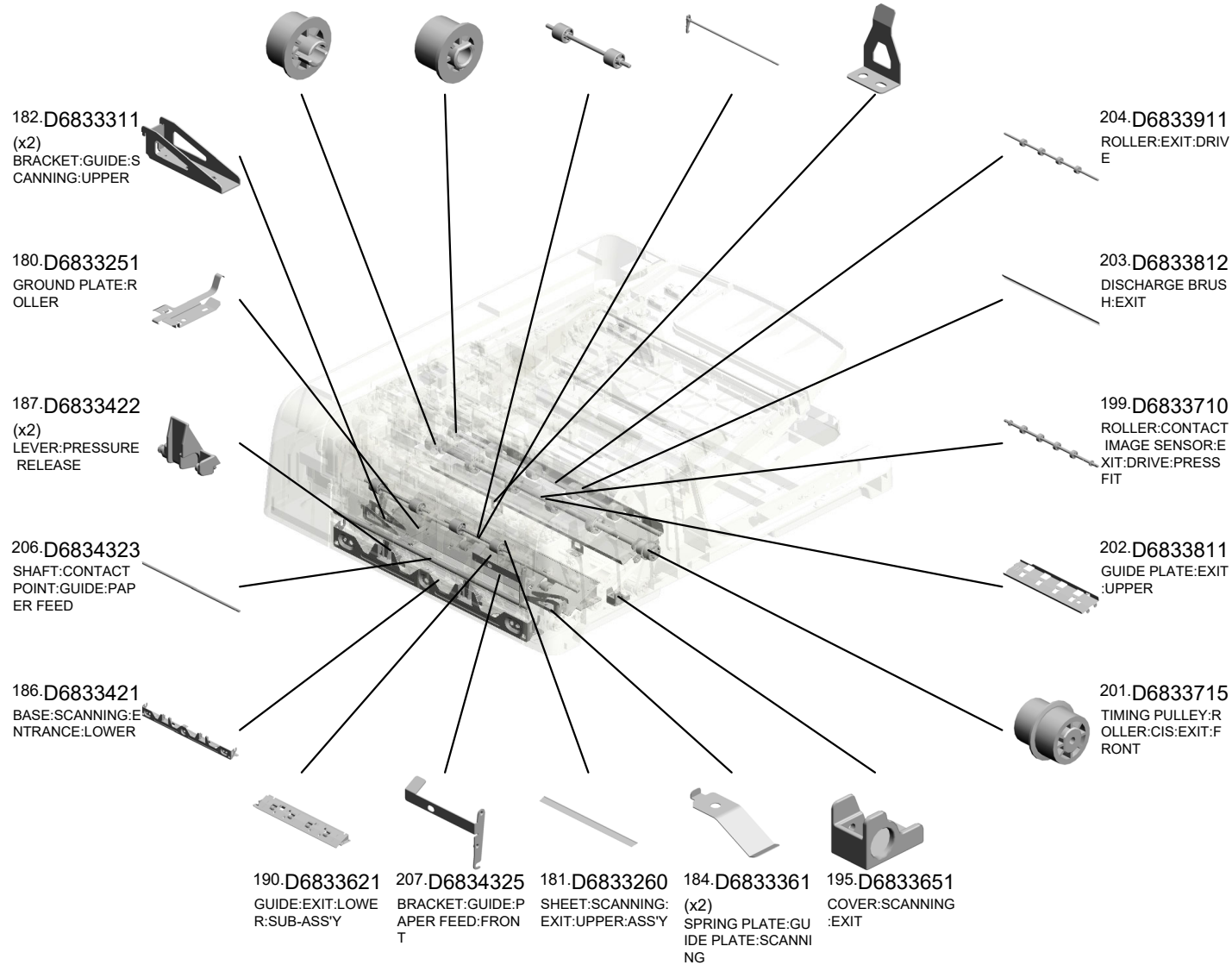

U003_S001
ADF:SINAI-B:ASS'Y



296.D1941202
[A]
ADF:SINAI-B:ASS'Y
202302-04 O/O

229.D6835121 GUIDE:HARNES:
SUB
213.D6834350 DRIVEN ROLLER:P
ULL OUT
232.D6902425 DISCHARGE BRUS
H:SHORT:FRONT
212.D6834345 DISCHARGE BRUS
H:EXIT:L37
219.D6834421 (x2)
SHAFT:EXIT:DRIVE
N

228.D6835111
GUIDE:HARNES:
MAIN

209.D6834341
BRACKET:PULL O
UT:DRIVEN

240.D7312912
GUIDE PLATE:PUL
L OUT:LOWER:DO
UBLE FEED SENS
OR

208.D6834328
BRACKET:GUIDE:P
APER FEED:INNER
BACK

239.D7312913
GUIDE PLATE:PUL
L OUT:LOWER
201610-04 O/O

230.D6835863
CONTACT IMAGE
SENSOR:ASS'Y
201610-03 O/O

220.D6834430 (x4)
ROLLER:EXIT:DRIV
EN

241.D7313511
HOOK:OPTICAL RE
ADING UNIT:FRON
T

235.D7312734
COVER:LOWER:BA
SE

221.D6834441 (x2)
HOLDER:CUSHION
:PRESSURE PLAT
E

238.D7312771
ORIGINAL TABLE:F
ACE FRONT

222.D6834442 (x8)
TAPE:PRESSURE
PLATE

237.D7312751
RAIL:SIDE FENCE

236.D7312746
SIDE FENCE:ORIGI
NAL TABLE

242.D7314112
COVER:FRONT RI
GHT

U003_S001
ADF:SINAI-B:ASS'Y

- 274.D3FF2851 SENSOR COVER:PHOTOINTERRUPTOR
- 244.D7314211 COVER:REAR
- 259.D7316041 DECAL:BASE:ORIGINAL
- 271.D3B01350 HINGE:RIGHT:ASS'Y
201902-05 X/O
- 256.D7315530 PCB:MAIN CONTROL BOARD:DOCUMENT FEEDER:ASS'Y



- 296.D1941202 [A] ADF:SINAI-B:ASS'Y
202302-04 O/O

- 273.AW020234 (x10) PHOTOINTERRUPTOR:GP1A173LCS5F
201904-01 O/O

- 261.D7316241 DECAL:STOPPER:SEPARATION UNIT

- 265.D6832913 (x2) SHEET:SENSOR:SEPARATION

- 267.D7314315 GUIDE:PAPER FEED:UPPER:DOUBLE FEED SENSOR
201707-01 O/O

- 270.D3B01320 HINGE:LEFT:ASS'Y
201812-09 X/O

- 255.D7314611 COVER:LEFT LOWER

- 262.G0602652 (x4) BUSHING - M4

- 260.D7316051 DECAL:DESIGN SKETCH:MISFEED REMOVAL:P

- 266.D7312731 BASE:ORIGINAL TABLE

- 243.D7314113 COVER:FRONT

- 258.D7316031 DECAL:SET:ORIGINAL TABLE

- 253.D7314413 TRAY:EXIT:AUXILIARY:SMALL

- 257.D7316011 DECAL:SIZE:ORIGINAL

- 252.D7314412 TRAY:EXIT:AUXILIARY:LARGE

- 251.D7314418 TRAY:EXIT
201512-01 X/O

U003_S001
ADF:SINAI-B:ASS'Y

290.07922101C 291.07922076C 289.07922080C
 SYNCHRONOUS B SYNCHRONOUS B SYNCHRONOUS B
 ELT:40S2M202:CR ELT:40S2M152:CR ELT:40S2M160:CR
 202105-04 O/O 202106-01 O/O 202105-06 O/O



296.D1941202
 [A]
 ADF:SINAI-B:ASS'Y
 202302-04 O/O

294.D3FF1451
 HOLDER:FEELER:
 APS
 202212-02 O/O



285.07922054C
 SYNCHRONOUS B
 ELT:40S2M108:CR
 202105-03 O/O



286.07922061C
 SYNCHRONOUS B
 ELT:40S2M122:CR
 202105-01 O/O

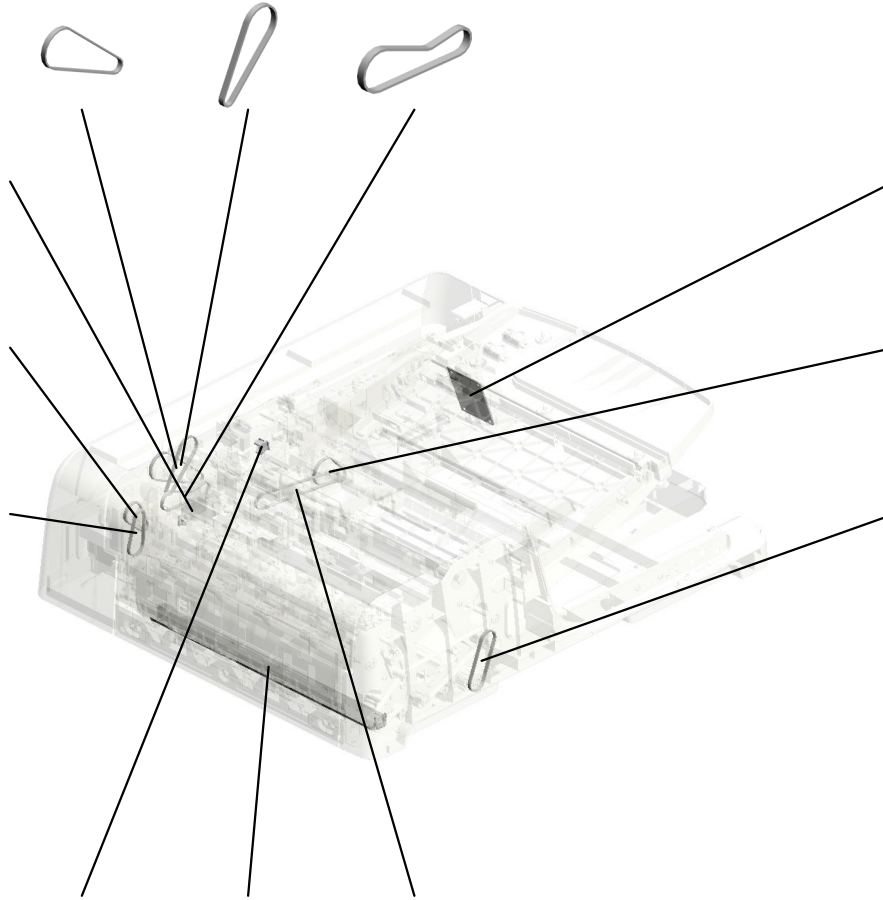

297.D7315415
 PCB:URB:DF:ASS'Y
 202306-04



287.07922063C
 SYNCHRONOUS B
 ELT:40S2M126:CR
 202105-02 O/O



288.07922079C
 SYNCHRONOUS B
 ELT:40S2M158:CR
 202105-05 O/O



275.D3FF2852
 COVER:SENSOR



280.D7313390
 GUIDE PLATE:SCA
 NNING:CONTACT:0
 .6MM:PEEN
 202006-03 X/O



292.07922129C
 SYNCHRONOUS B
 ELT:40S2M258:CR
 202210-02 O/O



D1941200
 [A]
 ADF:ASS'Y
 202302-04 O/O

U003_S001_S001
SHAFT:SEPARATION:DRIVE:INPUT:SUB-ASS'Y

52-AA082101
BUSHING - 6X10X6

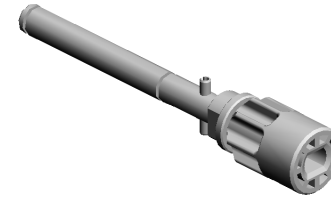
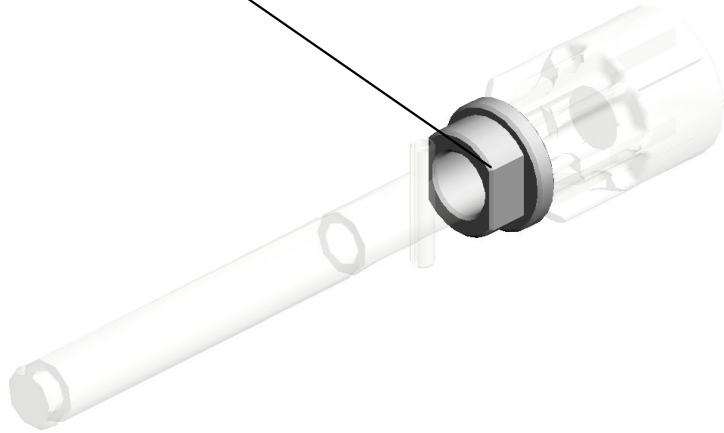

119-D6831620
SHAFT:SEPARATI
ON:DRIVE:INPUT:S
UB-ASS'Y

U001	U002	U003	U004	U005	U006	U007	U008	U009	U010	U011	U012	U013	U014	U015	U016	U017	U018	U019	U020	U021
------	------	------	------	------	------	------	------	------	------	------	------	------	------	------	------	------	------	------	------	------

U003_S001_S002
SHAFT:REVERSE ROLLER:SUB-ASS'Y

10.07200040E
RETAINING RING -
M4

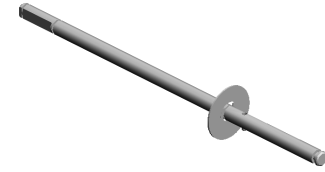
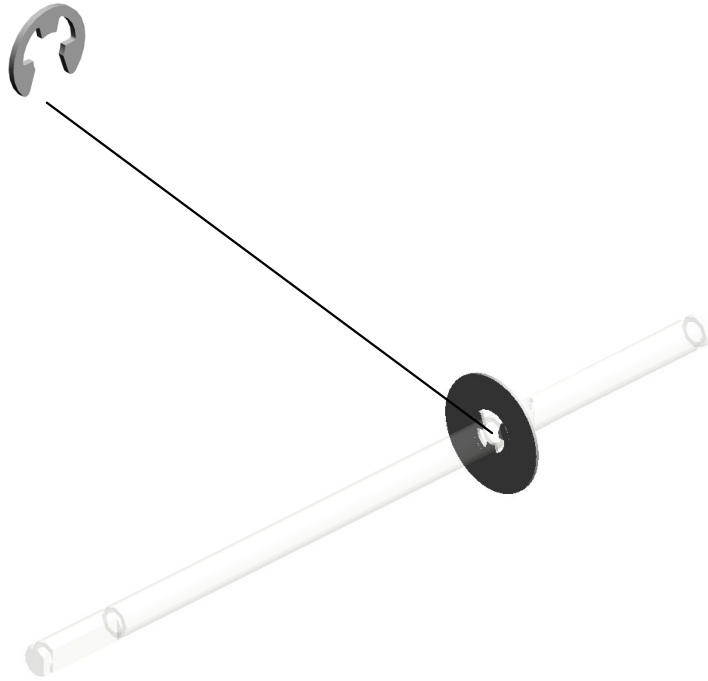

120.D6831632
SHAFT:REVERSE
ROLLER:SUB-ASS'
Y

U001	U002	U003	U004	U005	U006	U007	U008	U009	U010	U011	U012	U013	U014	U015	U016	U017	U018	U019	U020	U021
------	------	------	------	------	------	------	------	------	------	------	------	------	------	------	------	------	------	------	------	------

U003_S001_S003
SHAFT:INPUT:PAPER FEED:SUB-ASS'Y

12.07433806
RADIAL BALL BEA
RING:DIA6XDIA13X
5

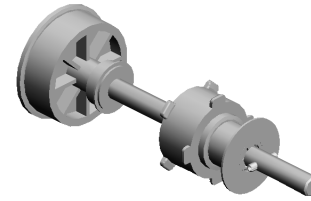

122.D6831640
SHAFT:INPUT:PAP
ER FEED:SUB-ASS'
Y

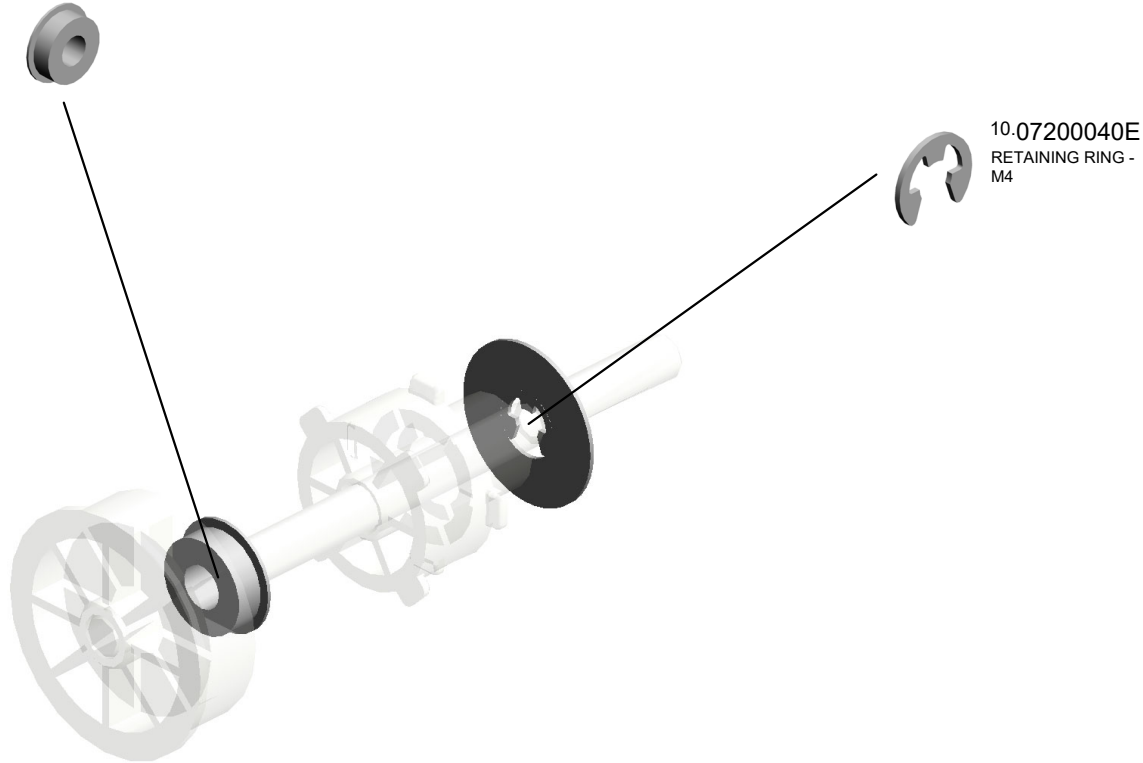

U001	U002	U003	U004	U005	U006	U007	U008	U009	U010	U011	U012	U013	U014	U015	U016	U017	U018	U019	U020	U021
------	------	------	------	------	------	------	------	------	------	------	------	------	------	------	------	------	------	------	------	------

U003_S001_S004
SHAFT:SEPARATION:ASS'Y

- 152.D6832229 TIMING PULLEY:GEAR:T19/Z23
- 34.A8592112 DRIVE SHAFT - PAPER FEED BELT
- 69.B3872113 ROLLER - PAPER FEED BELT
- 67.B3863320 (x2) SPRING:BELT: PAPER FEED:8N
- 151.D6832228 PICKUP ROLLER**

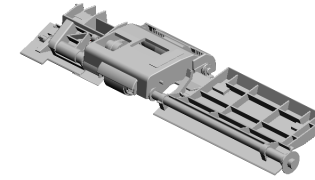

277.D7312202
[A]
SHAFT:SEPARATION:ASS'Y
202003-02 O/O

35.A8592319
BASE CUSHION



16.08050106
(x2)
RETAINING RINGS - SILENCER: DIA6



148.D6832221
GEAR:IDLER:Z18



80.B7892114
PAPER FEED BELT ROLLER



32.A6281225
(x4)
BUSHING - 8MM



150.D6832224
GUIDE: PAPER FEED ENTRANCE: FRONT



11.07200060E
RETAINING RING - M6



55.AA132013
SPACER

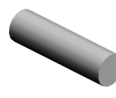

49.AA063435
COMPRESSION SPRING: PAPER FEED JOINT



29.A4181158
SPACER - M6.5X1



70.B4772227
PICKUP ROLLER: COUPLING

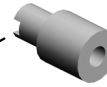

28.54472681
(x2)
SNAP RING



33.A8061163
(x2)
GUIDE PLATE CUSHION

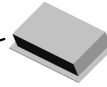

52.AA082101
BUSHING - 6X10X6



10.07200040E
RETAINING RING - M4



U003_S001_S004
SHAFT:SEPARATION:ASS'Y

295.07922065C 153.D6832231 154.D6832232
SYNCHRONOUS B BRACKET:PICKUP TIMING PULLEY:PI
ELT:40S2M130:CR CKUP:T21
202301-04 O/O

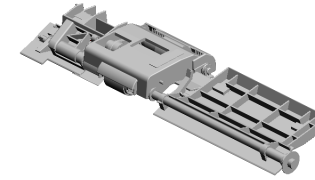

277.D7312202
[A]
SHAFT:SEPARATI
ON:ASS'Y
202003-02 O/O

157.D6832236
SHEET:BRACKET:
PICKUP:INNER BA
CK



160.D6832272
LEVER:PICKUP RO
LLER:RISE



279.D3FF2233
BRACKET:PAPER
FEED BELT
202006-01 X/O

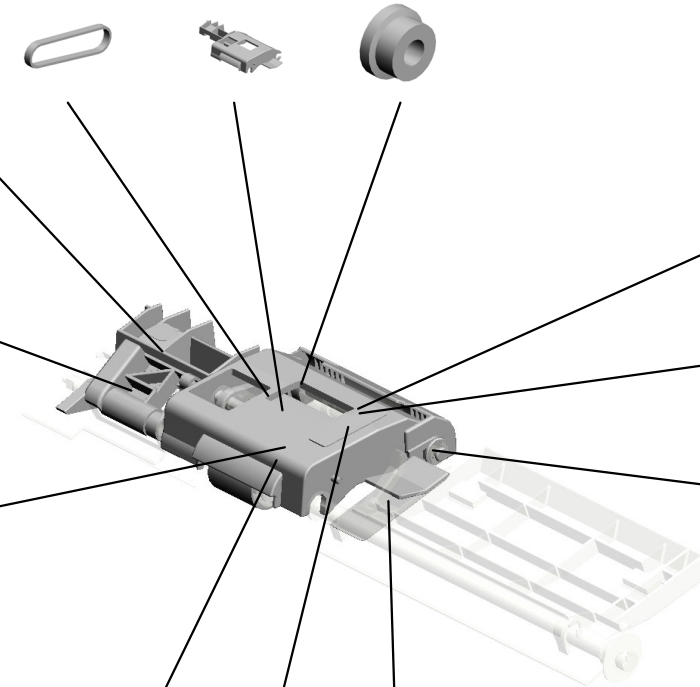

234.D7312239
COVER:PICKUP R
OLLER



156.D6832235
SHAFT:PICKUP:SU
B-ASSY



263.H0602126
(x2)
BUSHING - M6X7



231.D6842171
PAPER FEED BELT

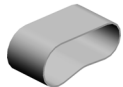

276.D3FF6071
DECAL:CAUTION:O
RIGINAL:PICK-UP
PAPER JAM
201911-02



272.D3FF2219
GUIDE:PAPER FEE
D BELT:FRONT
201902-04 O/O



D7312200
[A]
SHAFT:SEPARATI
ON:ASS'Y
202003-02 O/O

U003_S001_S004_S001
GUIDE:PAPER FEED:ENTRANCE:INNER BACK:ASS'Y

33.A8061163
(x2)
GUIDE PLATE CUS
HION

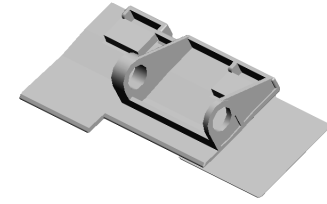

158.D6832240
GUIDE:PAPER FEE
D:ENTRANCE:INNE
R BACK:ASS'Y

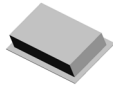

159.D6832242
SHEET:GUIDE:PAP
ER FEED:INNER B
ACK

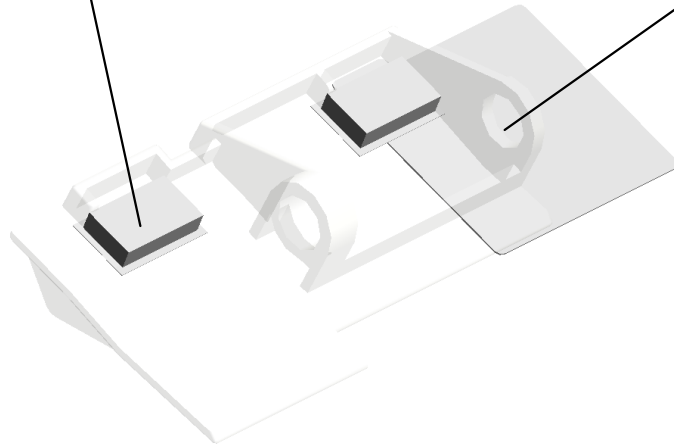

U001	U002	U003	U004	U005	U006	U007	U008	U009	U010	U011	U012	U013	U014	U015	U016	U017	U018	U019	U020	U021
------	------	------	------	------	------	------	------	------	------	------	------	------	------	------	------	------	------	------	------	------

U003_S001_S005
DC MOTOR:RISING TRAY:ASS'Y:1.007W:BRUSH

1-03530030N
(x2)
SCREW:M3X3

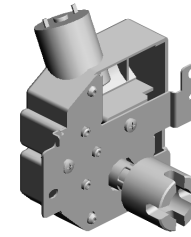

65.AX040254
DC MOTOR:RISING
TRAY:ASS'Y:1.007
W:BRUSH

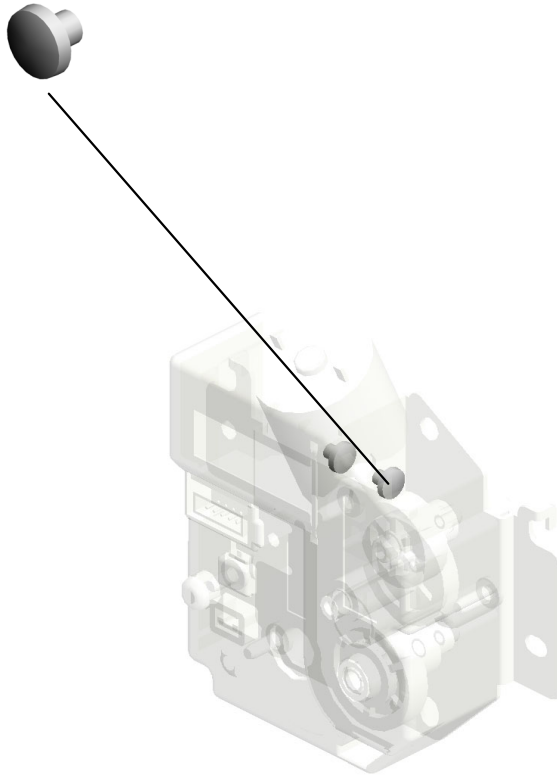

U001	U002	U003	U004	U005	U006	U007	U008	U009	U010	U011	U012	U013	U014	U015	U016	U017	U018	U019	U020	U021
------	------	------	------	------	------	------	------	------	------	------	------	------	------	------	------	------	------	------	------	------

U003_S001_S006
ROLLER:SCANNING:EXIT:DRIVE:ASS'Y

11.07200060E
RETAINING RING -
M6

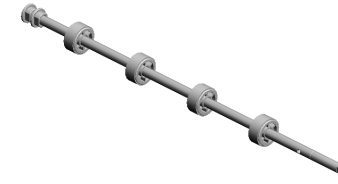

177.D6833150
ROLLER:SCANNIN
G:EXIT:DRIVE:ASS'
Y



53.AA082104
(x2)
BUSHING - 8X12X7

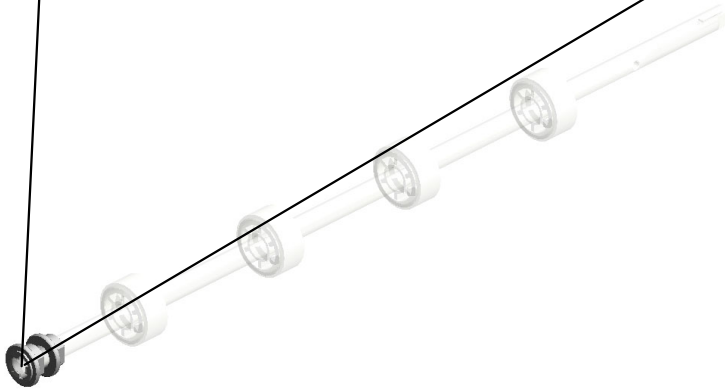

U001	U002	U003	U004	U005	U006	U007	U008	U009	U010	U011	U012	U013	U014	U015	U016	U017	U018	U019	U020	U021
------	------	------	------	------	------	------	------	------	------	------	------	------	------	------	------	------	------	------	------	------

U003_S001_S007
ROLLER:SCANNING:BEHIND:ASS'Y

88.D4122653
BUSHING:DIA6

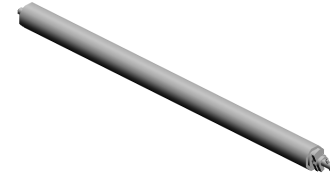

99.D5433631
ROLLER:SCANNING
G:BEHIND:ASS'Y

U001	U002	U003	U004	U005	U006	U007	U008	U009	U010	U011	U012	U013	U014	U015	U016	U017	U018	U019	U020	U021
------	------	------	------	------	------	------	------	------	------	------	------	------	------	------	------	------	------	------	------	------

U003_S001_S008
 GUIDE:CONTACT IMAGE SENSOR:EXIT:LOWER:ASS'Y

194.D6833645
 (x2)
 ROLLER:MIDDLE:DI
 RIVEN

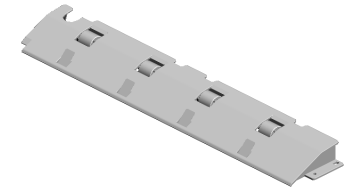

278.D6833646
 [A]
 GUIDE:CONTACT I
 MAGE SENSOR:EX
 IT:LOWER:ASS'Y
 202004-01 X/O

193.D6833644
 (x4)
 SHEET:GUIDE:CO
 NTACT IMAGE SEN
 SOR:EXIT:LOWER



262.G0602652
 (x4)
 BUSHING - M4

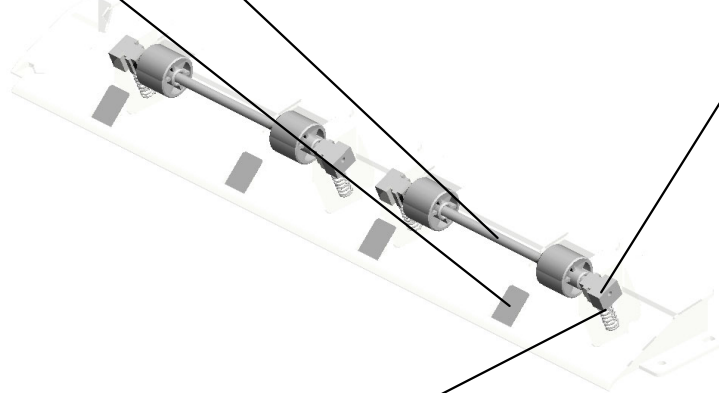

192.D6833643
 (x4)
 COMPRESSION SP
 RING:CONTACT IM
 AGE SENSOR:EXIT



D6833641
 [A]
 GUIDE:CONTACT I
 MAGE SENSOR:EX
 IT:LOWER:ASS'Y
 202004-01 X/O

U001	U002	U003	U004	U005	U006	U007	U008	U009	U010	U011	U012	U013	U014	U015	U016	U017	U018	U019	U020	U021
------	------	------	------	------	------	------	------	------	------	------	------	------	------	------	------	------	------	------	------	------

U003_S001_S009
 GUIDE PLATE:CONTACT IMAGE SENSOR:ENTRANCE:ASS'Y

203.D6833812
 DISCHARGE BRUSH
 H:EXIT

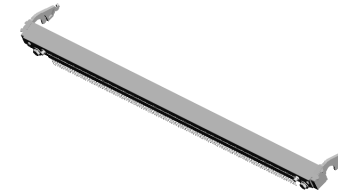

196.D6833662
 [A]
 GUIDE PLATE:CON
 TACT IMAGE SENS
 OR:ENTRANCE:AS
 S'Y
 201506-15 X/O

198.D6833667
 LEVER:GUIDE PLA
 TE:CONTACT IMA
 GE SENSOR:REAR



197.D6833666
 LEVER:GUIDE PLA
 TE:CONTACT IMA
 GE SENSOR:FRON
 T



3.03603006N
 (x4)
 SCREW - M3X6



D6833661
 [A]
 GUIDE PLATE:CON
 TACT IMAGE SENS
 OR:ENTRANCE:AS
 S'Y
 201506-15 X/O

U003_S001_S010
GUIDE:SCANNING:ENTRANCE:LOWER:SUB-ASS'Y

98.D5433314
(x4)
SHEET:SCANNING:
ENTRANCE:MIDDL
E

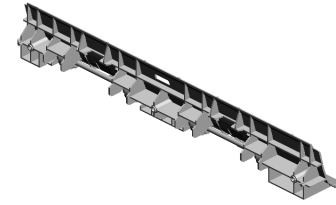

185.D6833411
GUIDE:SCANNING:
ENTRANCE:LOWE
R:SUB-ASS'Y



U001	U002	U003	U004	U005	U006	U007	U008	U009	U010	U011	U012	U013	U014	U015	U016	U017	U018	U019	U020	U021
------	------	------	------	------	------	------	------	------	------	------	------	------	------	------	------	------	------	------	------	------

U003_S001_S011
PRESSURE PLATE:ASS'Y

225.D6834722 (x4)
CUSHION:TAPE:SMALL

283.D3B04724
CUSHION:PRESSURE PLATE:LARGE
202012-02 O/O

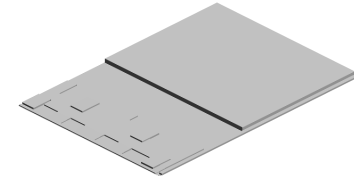

293.D3B04730
[A]
PRESSURE PLATE :ASS'Y
202212-03 O/O

282.D3B04711
GUIDE PLATE:PRESSURE PLATE:LEFT:ASS'Y
202012-01 O/O

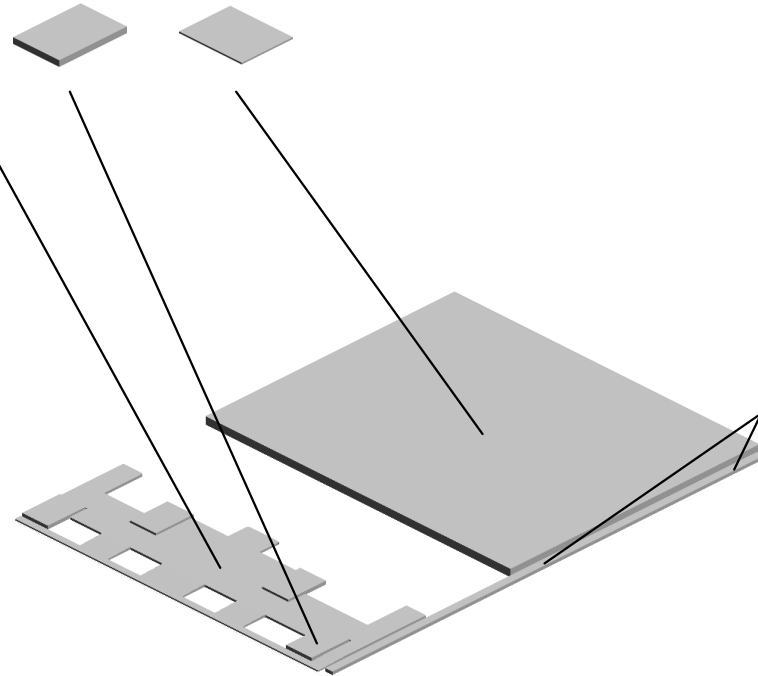

269.D0A46099
SHEET:PRESSURE PLATE:SMALL
201807-04 O/O



281.D3B04725
CUSHION:PRESSURE PLATE:SMALL
202011-01 O/O



D3B04720
[A]
PRESSURE PLATE :ASS'Y
202212-03 O/O

U003_S001_S012
GUIDE:PAPER FEED:UPPER:SUB-ASS'Y

98.D5433314
(x4)
SHEET:SCANNING:
ENTRANCE:MIDDL
E

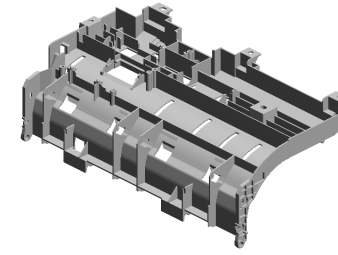

268.D7314311
[A]
GUIDE:PAPER FEE
D:UPPER:SUB-ASS
'Y
201709-01 O/O

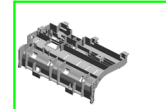
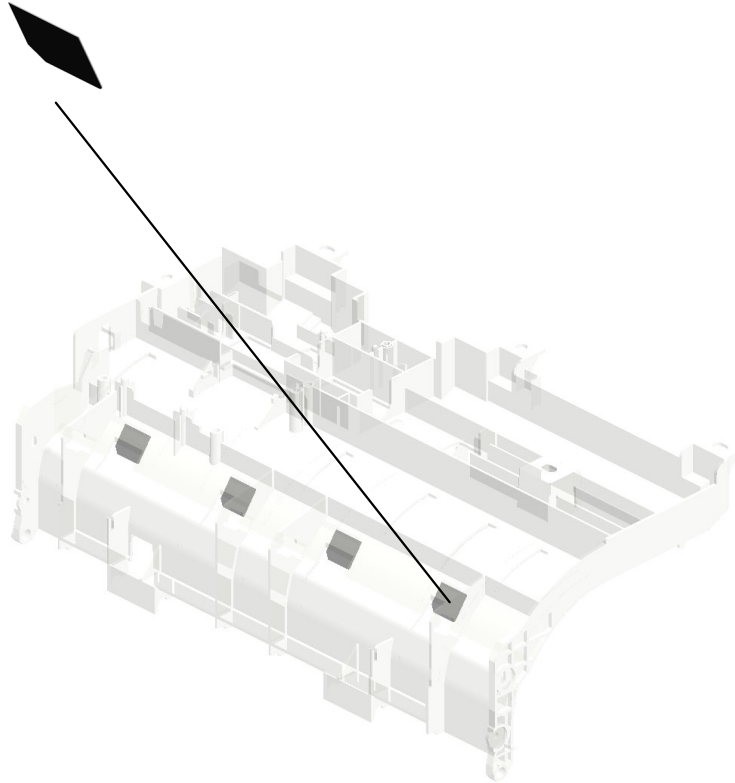

D7314310
[A]
GUIDE:PAPER FEE
D:UPPER:SUB-ASS
'Y
201709-01 O/O

U001	U002	U003	U004	U005	U006	U007	U008	U009	U010	U011	U012	U013	U014	U015	U016	U017	U018	U019	U020	U021
------	------	------	------	------	------	------	------	------	------	------	------	------	------	------	------	------	------	------	------	------

U003_S001_S013
COVER:PAPER FEED:ASS'Y

248.D7314352 BRACKET:PRESSURE PICKUP
 210.D6834343 PRESSURE PLATE PICKUP
 211.D6834344 COMPRESSION SPRING:RING PICKUP:2.1N
 215.D6834361 SHAFT:CONTACT POINT:GRIP

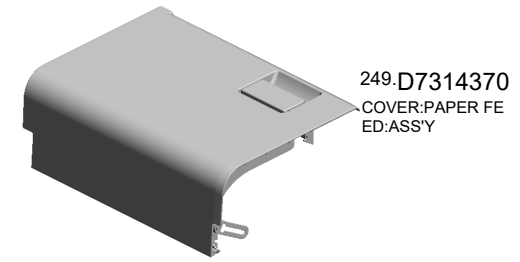

249.D7314370
COVER:PAPER FEED:ASS'Y

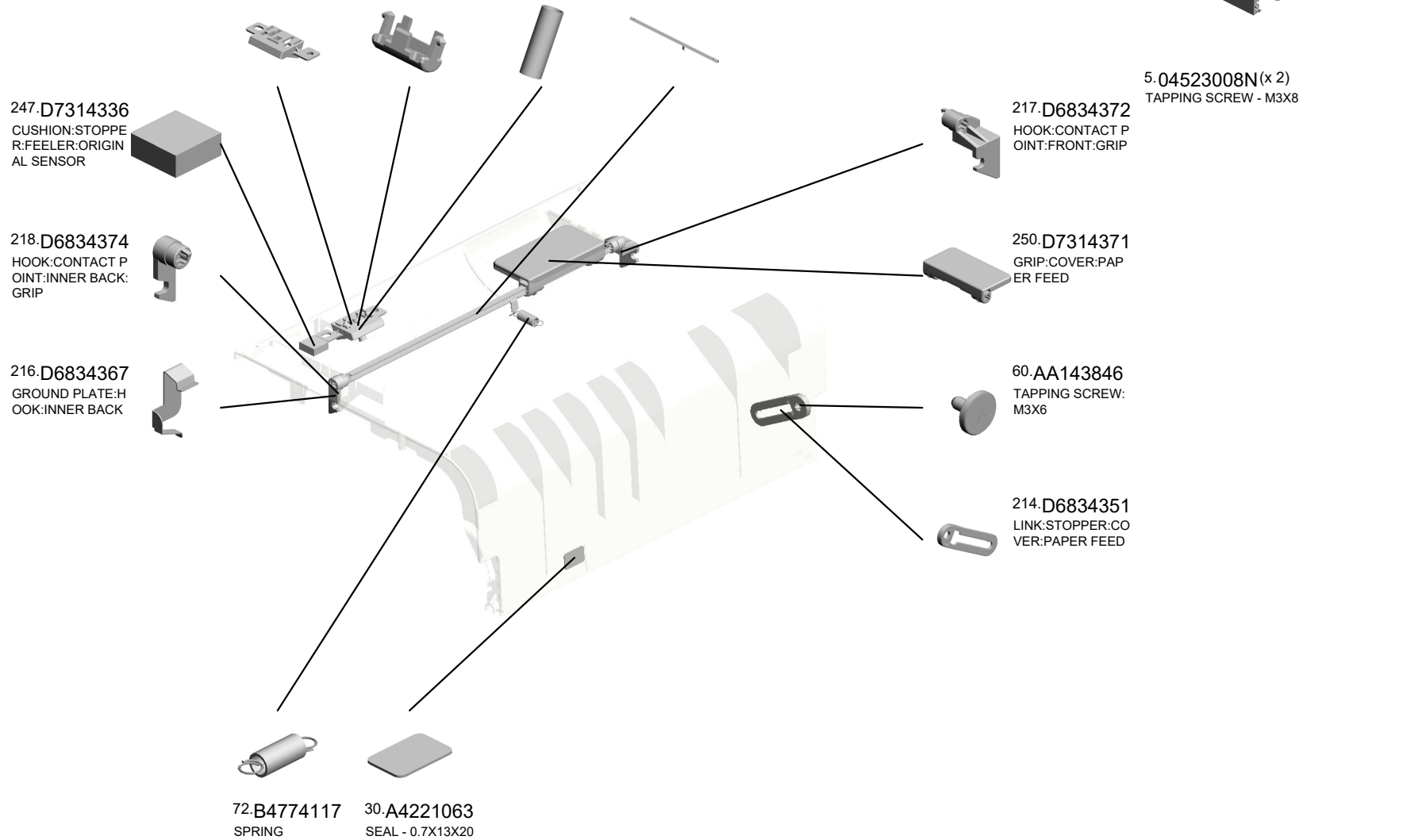

U003_S001_S014
COVER:LOWER:ASS'Y

222.D6834442
(x2)
TAPE:PRESSURE
PLATE

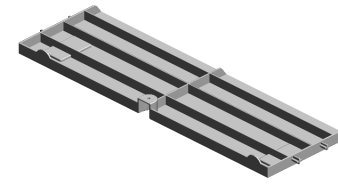
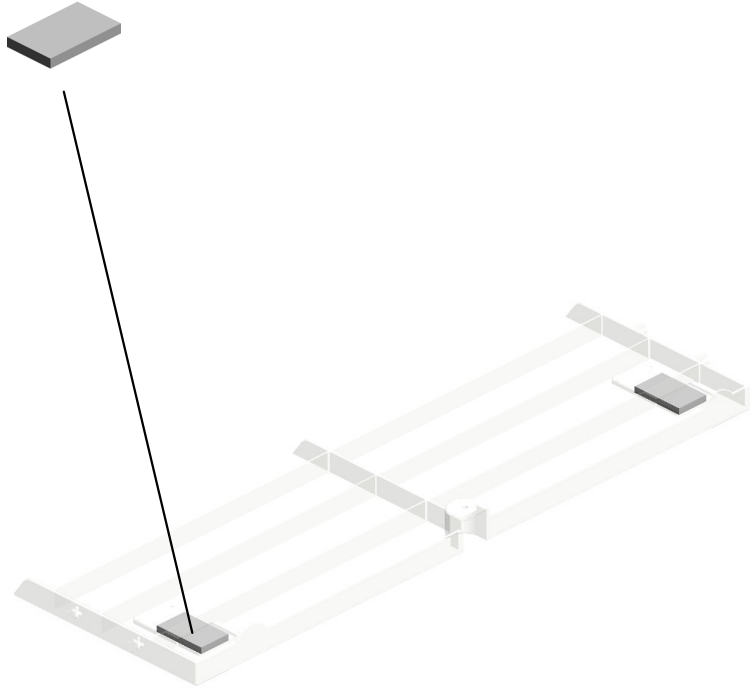

254.D7314510
COVER:LOWER:AS
SY

U001	U002	U003	U004	U005	U006	U007	U008	U009	U010	U011	U012	U013	U014	U015	U016	U017	U018	U019	U020	U021
------	------	------	------	------	------	------	------	------	------	------	------	------	------	------	------	------	------	------	------	------

U004.SCANNER

U004 S002
D1361751
CARRIAGE:NO.1:ASS'Y

U004 S003
D1491721
ILLUMINATION UNIT:LED-B:A
SS'Y

U004 S005
D1361817
BRACKET:EXPOSURE GLAS
S:DOCUMENT FEEDER:SUB-
ASS'Y

U004 S001
D1381731
LENSBLOCK SMD:SERVICE
PARTS:ASS'Y

U004 S004
D1361776
CARRIAGE:NO.2:ASS'Y

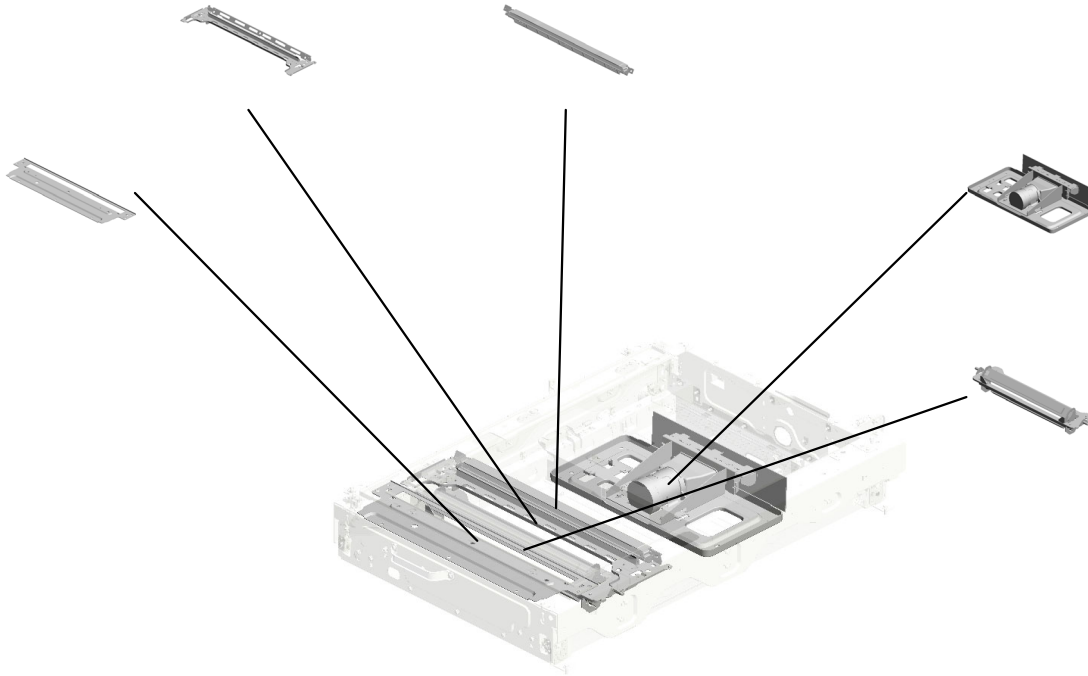

U001	U002	U003	U004	U005	U006	U007	U008	U009	U010	U011	U012	U013	U014	U015	U016	U017	U018	U019	U020	U021
------	------	------	------	------	------	------	------	------	------	------	------	------	------	------	------	------	------	------	------	------

U004 SCANNER

- 12.11050559 CLAMP:EMT-5N
- 13.11050723 CLAMPS:WES-0507
- 20.AW010134 (x2) ORIGINAL SENSOR - 48MM
- 10.08025312 (x3) TAPPING SCREW: WASHER:3X10
- 9.07433808 (x2) RADIAL BALL BEARING: DIA8XDIA16X5



2.03530060N
(x14)
BIND SCREW - M3X6

4.03604010N
(x4)
SCREW:M4X10

7.07074050N
(x2)
BUSHING - 4X5

18.AA161104
(x2)
CUSHION - MOTOR

21.AW020198
PHOTOINTERRUPTOR:LG2A14NL1

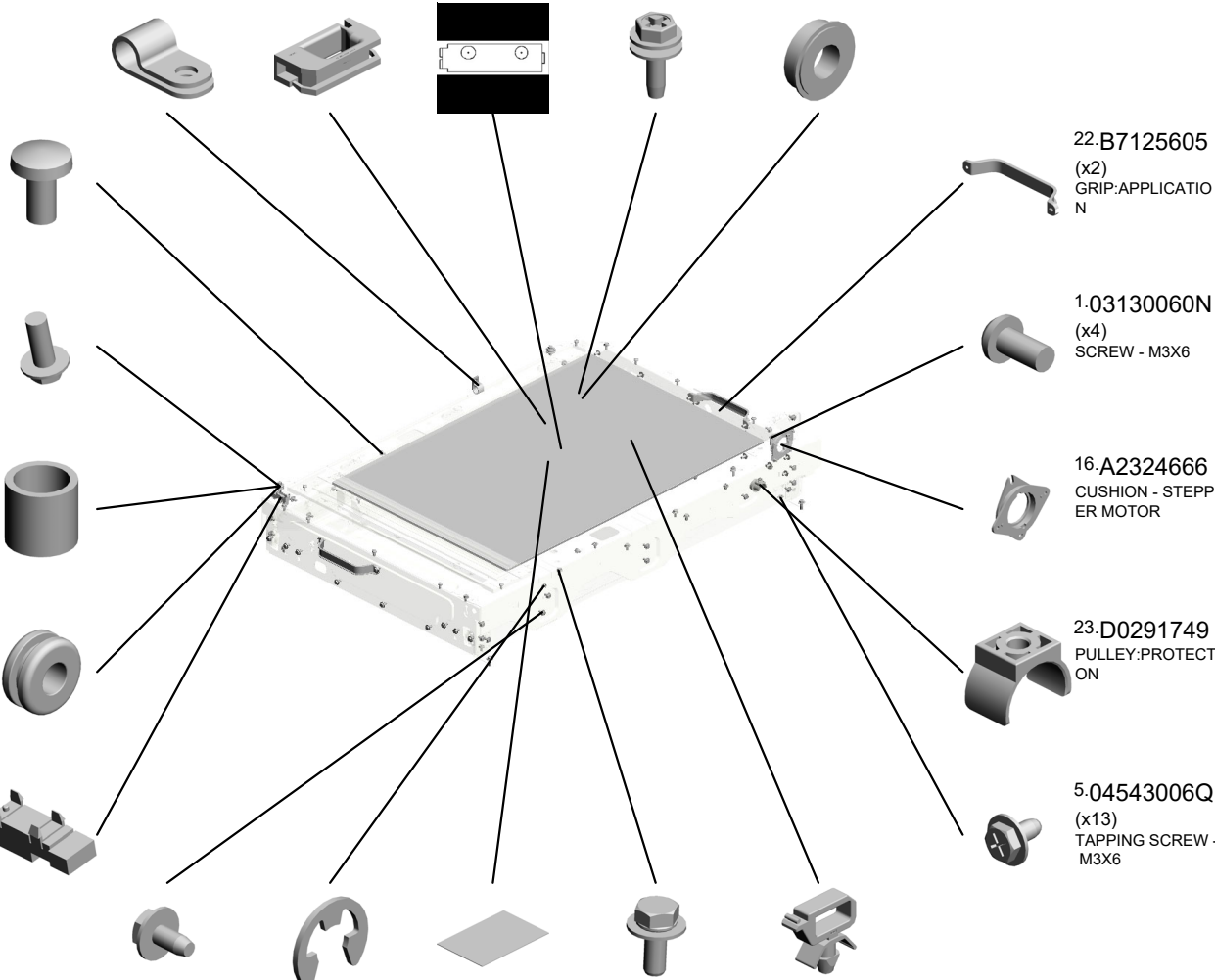

3.03603006N
(x67)
SCREW - M3X6

8.07200040E
(x2)
RETAINING RING - M4

17.A2501752
EXPOSURE GLASS

11.08046123
(x7)
HEXAGONAL BOLT:WASHER:M3X8

15.11050761
(x2)
CLAMP:LWS-0511A

22.B7125605
(x2)
GRIP:APPLICATION

1.03130060N
(x4)
SCREW - M3X6

16.A2324666
CUSHION - STEPPER MOTOR

23.D0291749
PULLEY:PROTECTION

5.04543006Q
(x13)
TAPPING SCREW - M3X6

6.04543008Q(x 1)
TAPPING SCREW:3X8

U004 SCANNER

24.D1361715 GUIDE:HARNESS:LEAD
 26.D1361727 INNER COVER:SCANNER
 51.D1365696 PCB:SIO
 25.D1361717 COVER:SHAFT:SCANNER
 41.D1361801 SHAFT:DRIVE:SCANNER

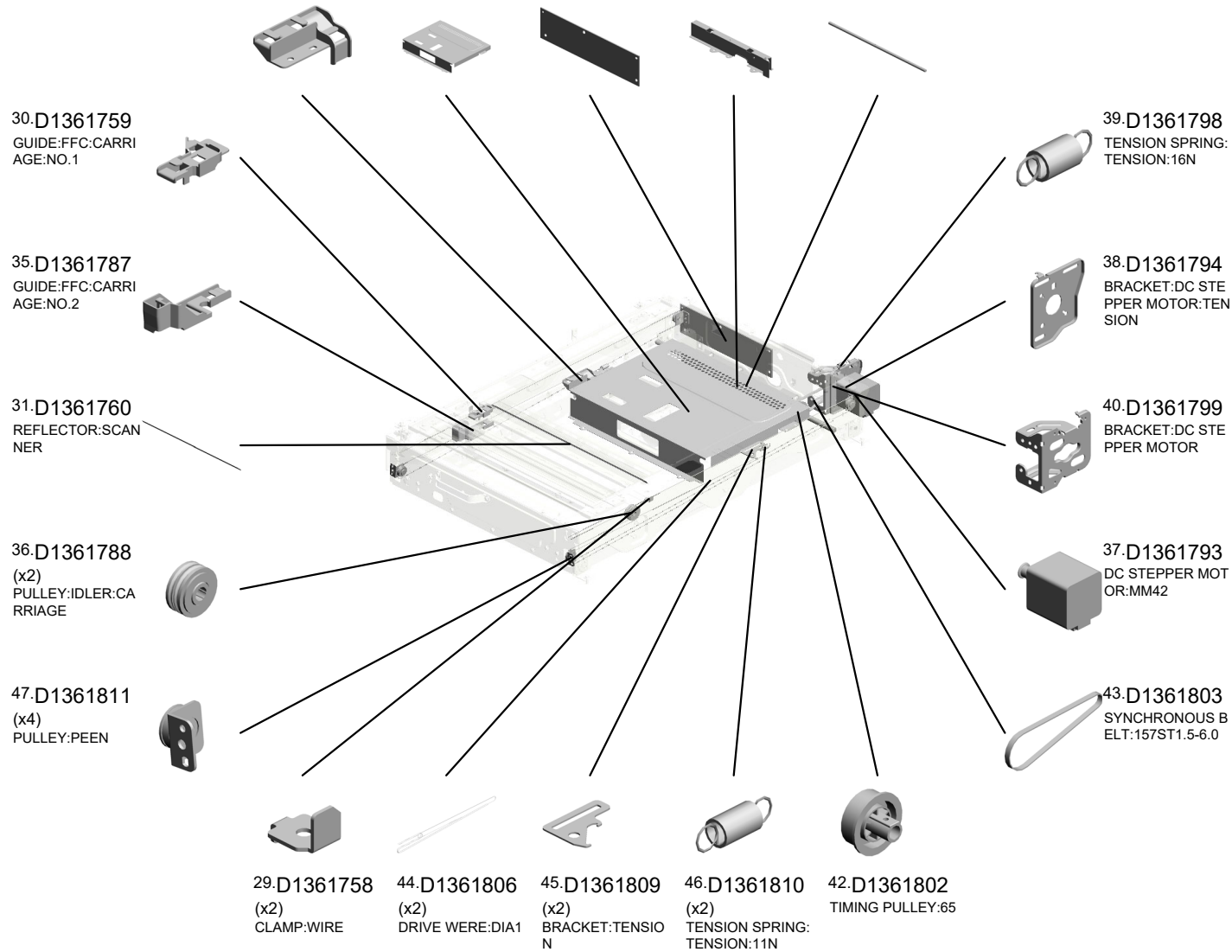

U004 SCANNER

- 70.11050511 (x17) HARNESS CLAMP - LWS-0306ZC 201904-06 X/O
- 60.D1791768 EXPOSURE GLASS :DOCUMENT FEEDER
- 58.D1791763 (x3) (-AA,-EU,-CHN):SCALE:LEFT:ASS'Y
- 62.D1791789 SCALE:REAR:PRINTING
- 57.D1491805 (x4) HOLDER:EXPOSURE GLASS

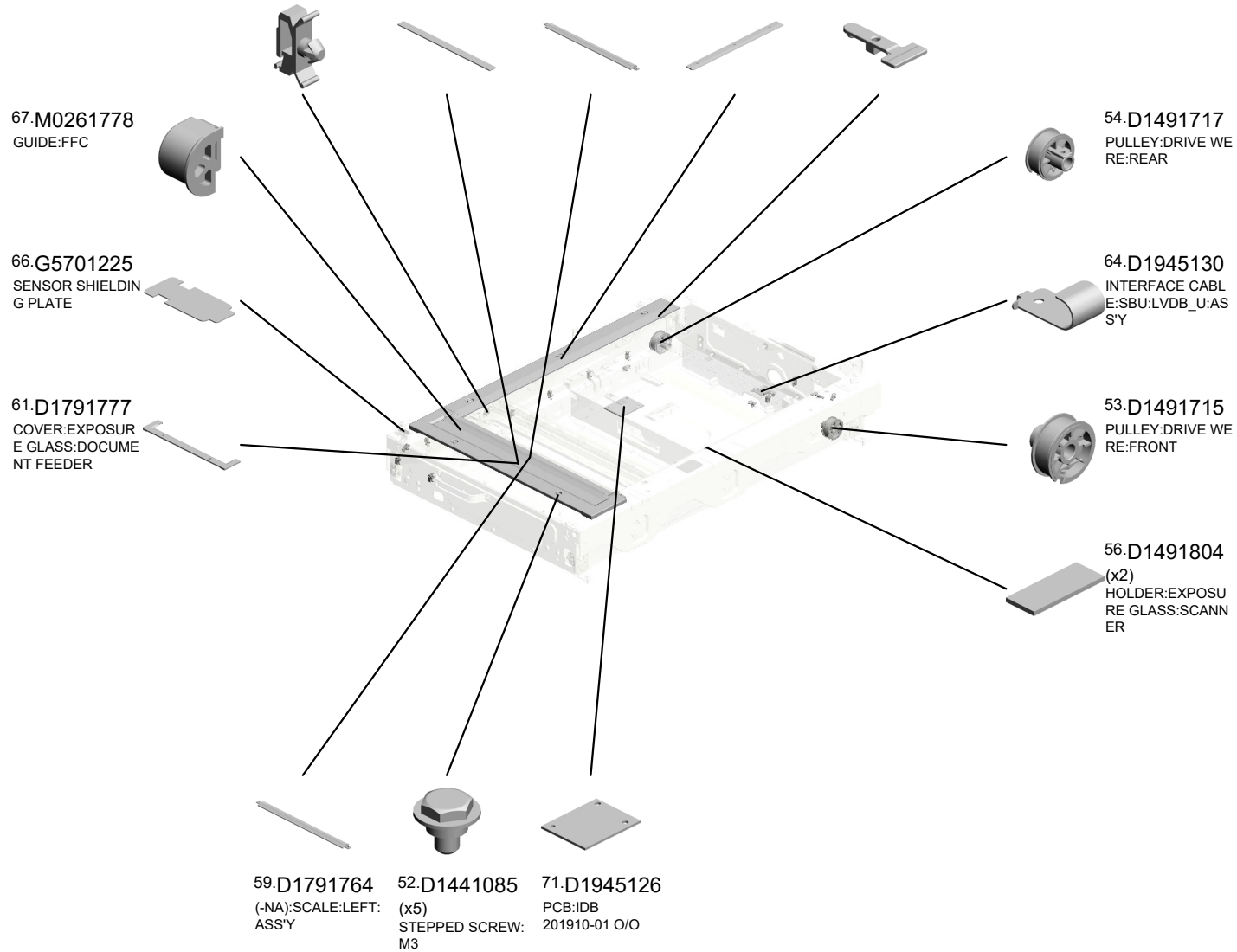

U004_S001
LENSBLOCK SMD:SERVICE PARTS:ASS'Y

11.08046123
(x8)
HEXAGONAL BOLT
:W/WASHER:M3X8

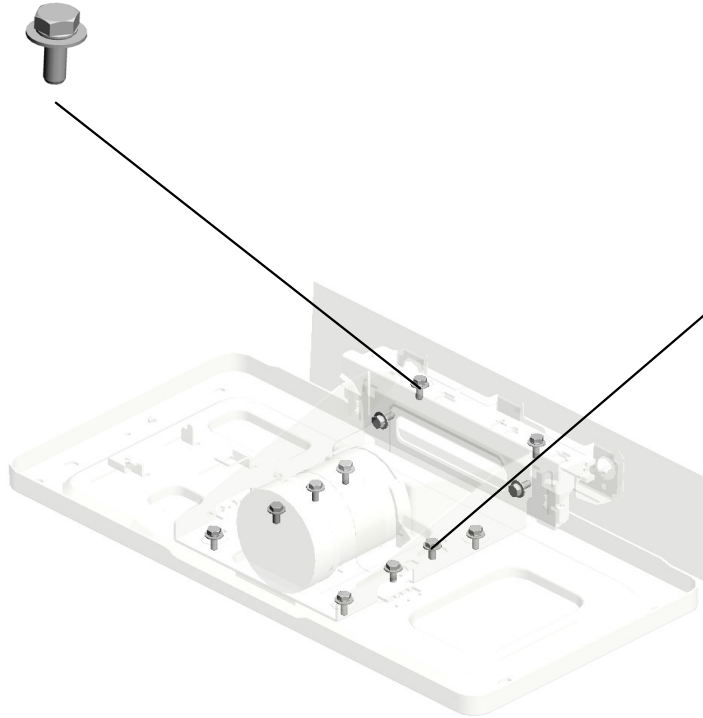

3.03603006N
(x4)
SCREW - M3X6

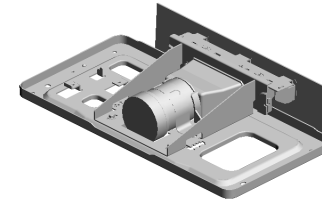

69.D1381731
[A]
LENSBLOCK SMD:
SERVICE PARTS:A
SS'Y
201807-08 O/O

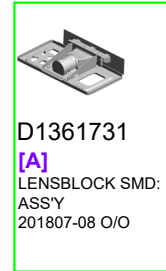

D1361731
[A]
LENSBLOCK SMD:
ASS'Y
201807-08 O/O

U001	U002	U003	U004	U005	U006	U007	U008	U009	U010	U011	U012	U013	U014	U015	U016	U017	U018	U019	U020	U021
------	------	------	------	------	------	------	------	------	------	------	------	------	------	------	------	------	------	------	------	------

U004_S002
CARRIAGE:NO.1:ASS'Y

19.AC030211
MIRROR:NO.1

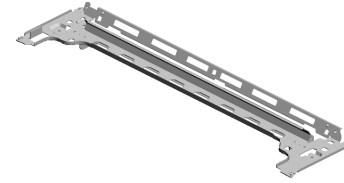

28.D1361751
CARRIAGE:NO.1:A
SS'Y

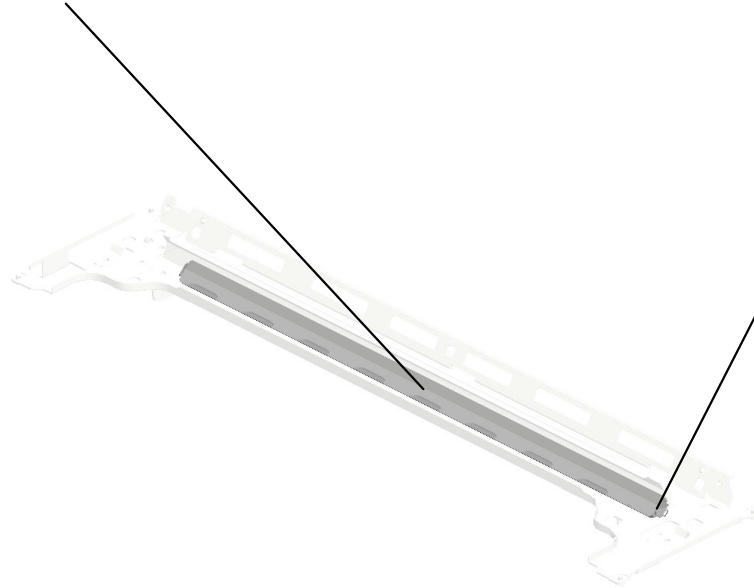

68.M0261815
(x2)
CLAMP:MIRROR:N
O.1

U001	U002	U003	U004	U005	U006	U007	U008	U009	U010	U011	U012	U013	U014	U015	U016	U017	U018	U019	U020	U021
------	------	------	------	------	------	------	------	------	------	------	------	------	------	------	------	------	------	------	------	------

U004_S003
ILLUMINATION UNIT:LED-B:ASS'Y

2.03530060N
(x3)
BIND SCREW - M3
X6



55.D1491721
ILLUMINATION UNI
T:LED-B:ASS'Y



U001	U002	U003	U004	U005	U006	U007	U008	U009	U010	U011	U012	U013	U014	U015	U016	U017	U018	U019	U020	U021
------	------	------	------	------	------	------	------	------	------	------	------	------	------	------	------	------	------	------	------	------

U004_S004
CARRIAGE:NO.2:ASS'Y

65.G4042810 33.D1361784
(x4) MIRROR:NO.2:ASS'
SPRING PLATE - 2 Y
ND MIRROR

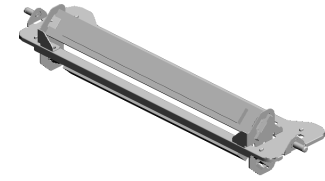

32.D1361776
CARRIAGE:NO.2:A
SS'Y

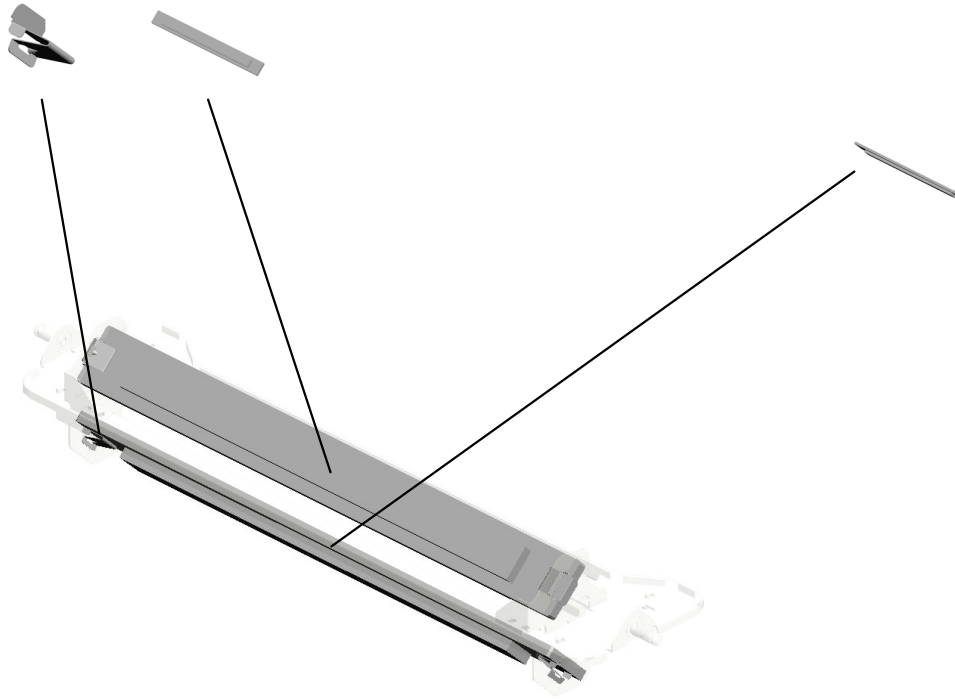

34.D1361785
MIRROR:NO.3:ASS'
Y

U001	U002	U003	U004	U005	U006	U007	U008	U009	U010	U011	U012	U013	U014	U015	U016	U017	U018	U019	U020	U021
------	------	------	------	------	------	------	------	------	------	------	------	------	------	------	------	------	------	------	------	------

U004_S005
BRACKET:EXPOSURE GLASS:DOCUMENT FEEDER:SUB-ASS'Y

50.D1361820
SHEET:BRACKET:
EXPOSURE GLASS
:DOCUMENT FEED
ER

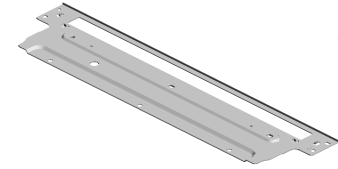

48.D1361817
BRACKET:EXPOSU
RE GLASS:DOCUM
ENT FEEDER:SUB-
ASS'Y

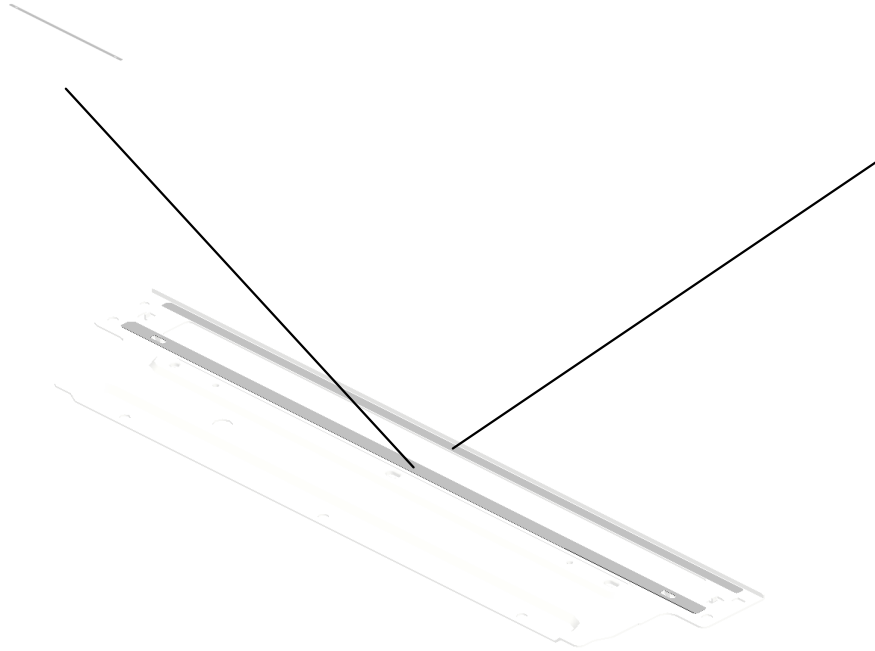

49.D1361819
SEAL:BRACKET:EX
POSURE GLASS:DOCUM
ENT FEEDER:SUB-
ASS'Y

U001	U002	U003	U004	U005	U006	U007	U008	U009	U010	U011	U012	U013	U014	U015	U016	U017	U018	U019	U020	U021
------	------	------	------	------	------	------	------	------	------	------	------	------	------	------	------	------	------	------	------	------

U005.LASER UNIT

U005 S001
D1941803
OPTICAL WRITING UNIT:4ST
:ASS'Y

U005 S002
D1941803
OPTICAL WRITING UNIT:4ST
:ASS'Y

U005 S003
D1941807
(D203/D204):OPTICAL WRITING UNIT:SST:ASS'Y

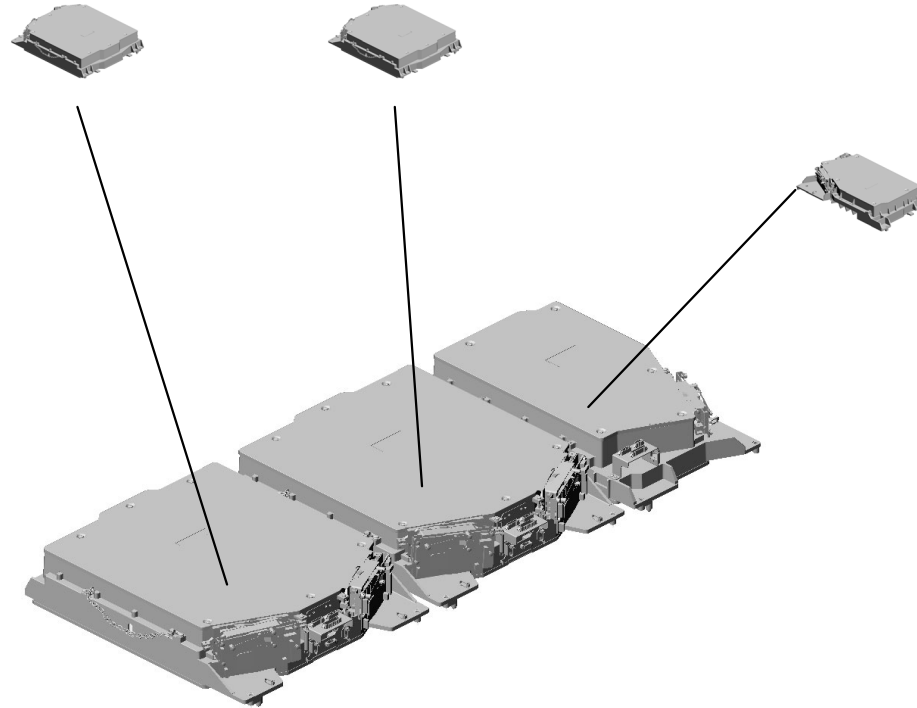

U001	U002	U003	U004	U005	U006	U007	U008	U009	U010	U011	U012	U013	U014	U015	U016	U017	U018	U019	U020	U021
------	------	------	------	------	------	------	------	------	------	------	------	------	------	------	------	------	------	------	------	------

U005
LASER UNIT

2.03604020N
(x8)
SCREW:M4X20

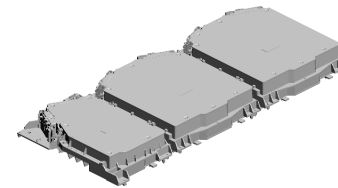

2.03604020N(x 4)
SCREW:M4X20

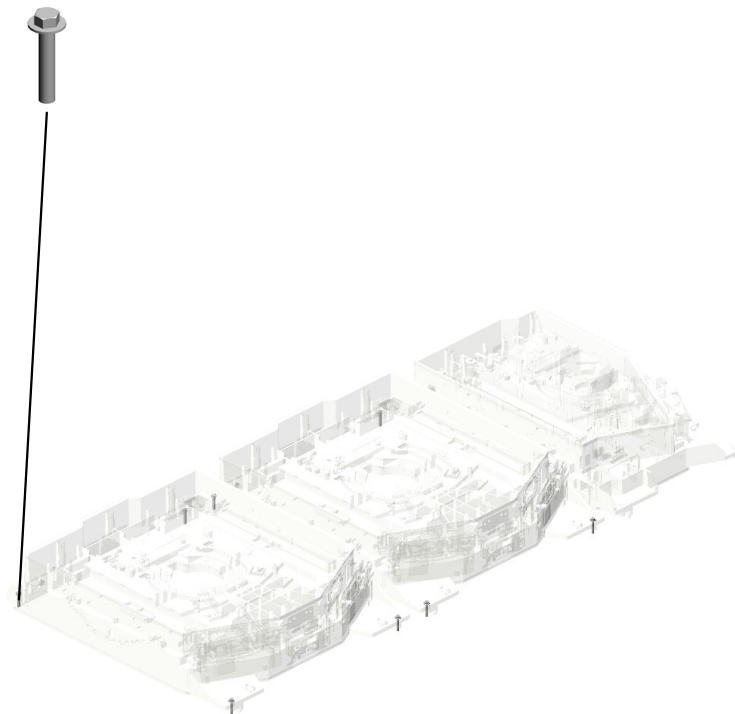

U001	U002	U003	U004	U005	U006	U007	U008	U009	U010	U011	U012	U013	U014	U015	U016	U017	U018	U019	U020	U021
------	------	------	------	------	------	------	------	------	------	------	------	------	------	------	------	------	------	------	------	------

U005_S001
OPTICAL WRITING UNIT:4ST:ASS'Y

3.04523008N (x4) TAPPING SCREW - M3X8
6.11050516 (x6) CLAMP

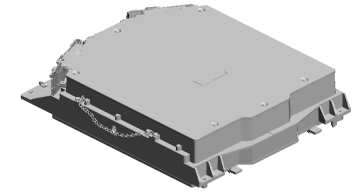

13.D1941803
[A]
OPTICAL WRITING
UNIT:4ST:ASS'Y
201803-01 O/O

1.03530060N
(x89)
BIND SCREW - M3
X6

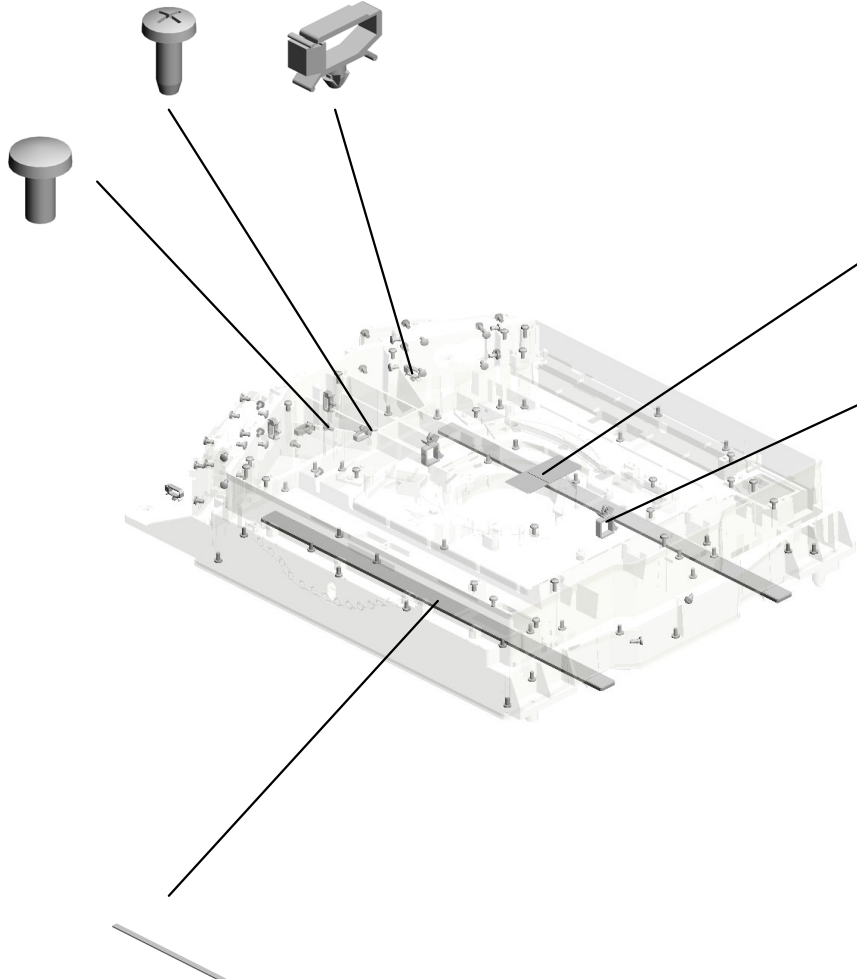

12.G0291980
DECAL - LD
CAUTION
LASER RADIATION
ATTENTION

4.11050042
(x13)
WIRE BAND

7.11050534
(x4)
CLAMP

5.11050488
(x2)
HARNESS CLAMP

1.03530060N(x 2)
BIND SCREW - M3X6

9.D0742020
(x2)
SHIELD GLASS:AS
S'Y



D1941802
[A]
OPTICAL WRITING
UNIT:4ST:ASS'Y
201803-01 O/O

U005_S002
OPTICAL WRITING UNIT:4ST:ASS'Y

3.04523008N (x4)
TAPPING SCREW - M3X8

6.11050516 (x6)
CLAMP

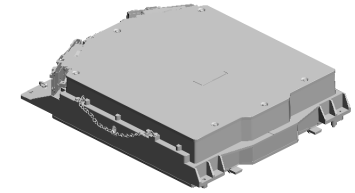

13.D1941803
[A]
OPTICAL WRITING
UNIT:4ST:ASS'Y
201803-01 O/O

1.03530060N
(x95)
BIND SCREW - M3
X6

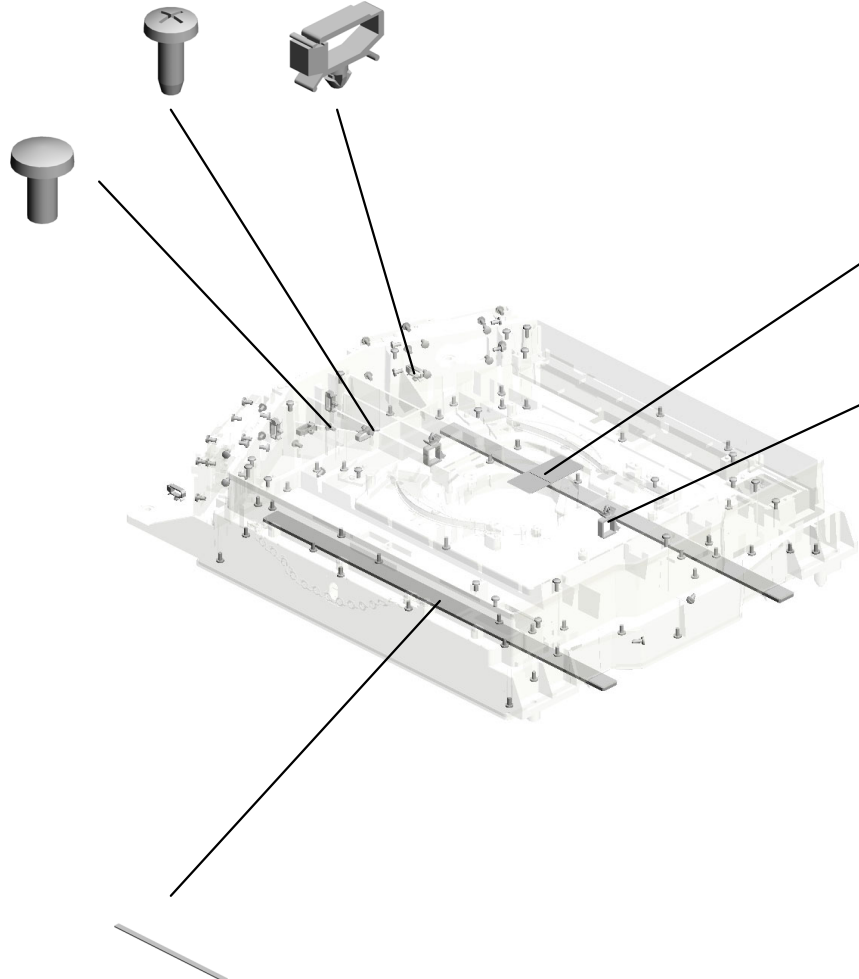

12.G0291980
DECAL - LD



4.11050042
(x13)
WIRE BAND

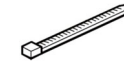

7.11050534
(x4)
CLAMP



5.11050488
(x2)
HARNESS CLAMP



1.03530060N (x 8)
BIND SCREW - M3X6

9.D0742020
(x2)
SHIELD GLASS:AS
S'Y



D1941802
[A]
OPTICAL WRITING
UNIT:4ST:ASS'Y
201803-01 O/O

U005_S003
 (D203/D204):OPTICAL WRITING UNIT:SST:ASS'Y

3.04523008N (x2) TAPPING SCREW - M3X8
 8.11050724 CLAMPS:WES-121
 12.G0291980 DECAL - LD

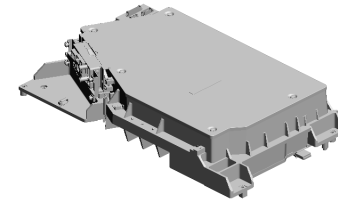

14.D1941807
 [A]
 (D203/D204):OPTICAL WRITING UNIT:
 SST:ASS'Y
 201904-02 O/O

6.11050516
 (x4)
 CLAMP

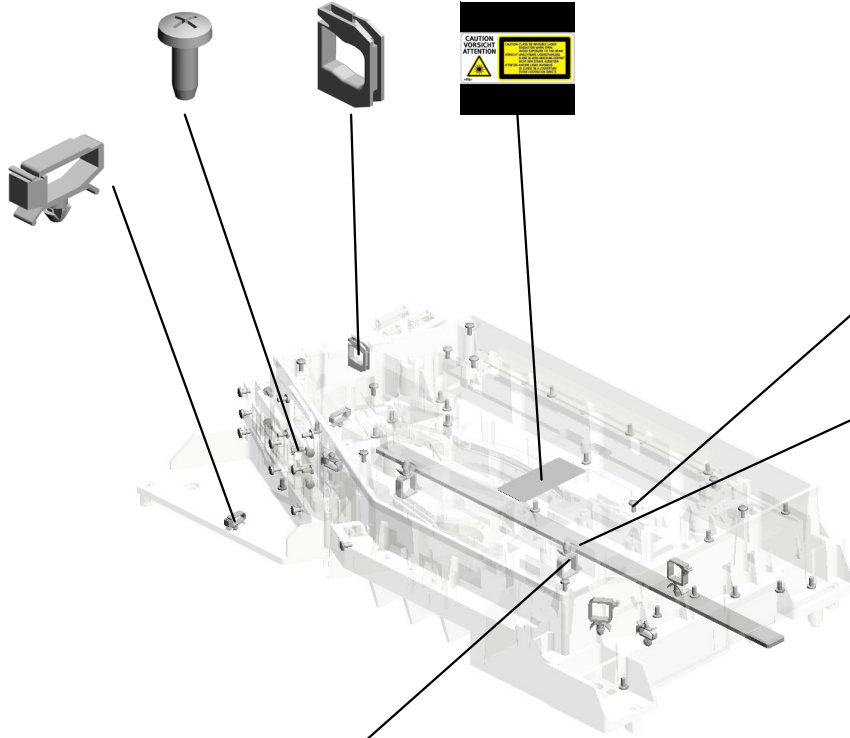

5.11050488
 (x4)
 HARNESS CLAMP



1.03530060N
 (x46)
 BIND SCREW - M3 X6

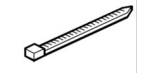

4.11050042
 (x14)
 WIRE BAND

9.D0742020
 SHIELD GLASS:AS
 S'Y



1.03530060N(x12)
 BIND SCREW - M3X6



D1941806
 [A]
 (D203/D204):OPTICAL WRITING UNIT:
 SST:ASS'Y
 201904-02 O/O

U006.PAPER BANK/PAPER FEED/VERTICAL TRANSPORT

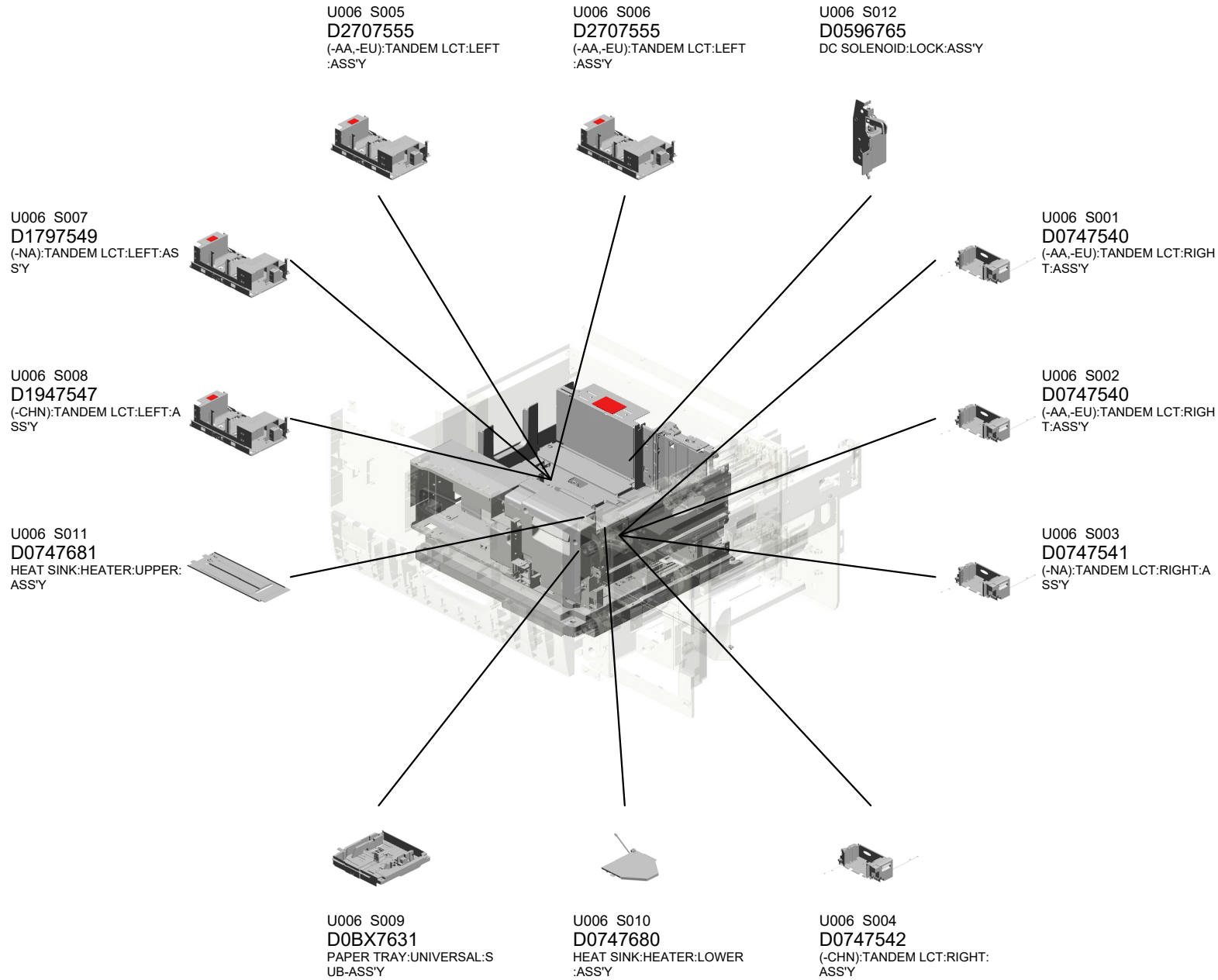

U001	U002	U003	U004	U005	U006	U007	U008	U009	U010	U011	U012	U013	U014	U015	U016	U017	U018	U019	U020	U021
------	------	------	------	------	------	------	------	------	------	------	------	------	------	------	------	------	------	------	------	------

U006.PAPER BANK/PAPER FEED/VERTICAL TRANSPORT

U006 S018
D1947500
PAPER FEED UNIT:PAPER B
ANK:ASS'Y

U006 S013
B1326762
DC SOLENOID:COUPLING:A
SS'Y

U006 S015
D1947469
GUIDE PLATE:FEED PAPER
AGAIN:ASS'Y

U006 S017
D3553840
BRACKET:DETENT:ASS'Y

U006 S016
D3553810
BRACKET:DETENT:RIGHT:A
SS'Y

U006 S014
AX040254
DC MOTOR:RISING TRAY:AS
S'Y:1.007W:BRUSH

U006 S019
D1947500
PAPER FEED UNIT:PAPER B
ANK:ASS'Y

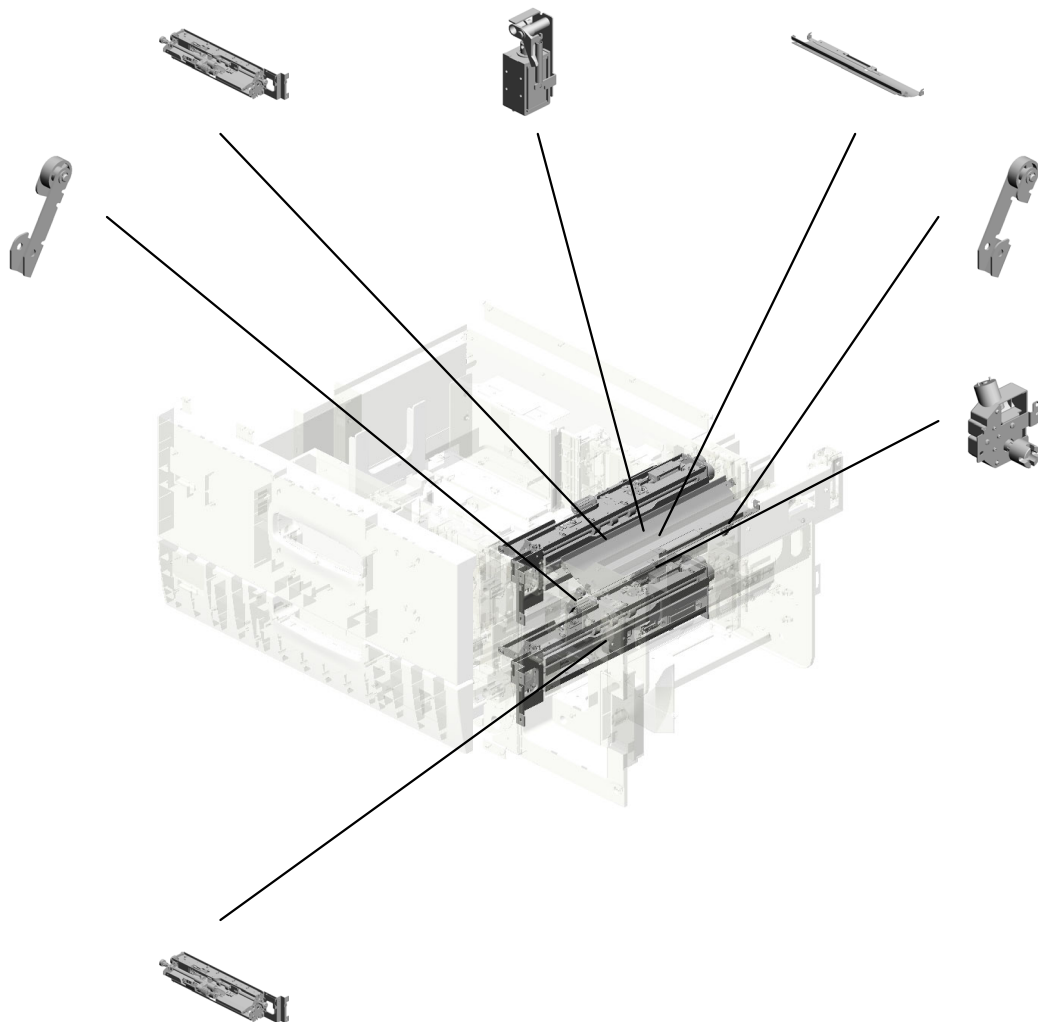

U001	U002	U003	U004	U005	U006	U007	U008	U009	U010	U011	U012	U013	U014	U015	U016	U017	U018	U019	U020	U021
------	------	------	------	------	-------------	------	------	------	------	------	------	------	------	------	------	------	------	------	------	------

U006_S001.(-AA,-EU):TANDEM LCT:RIGHT:ASS'Y

U006 S001 S003
B2346686
SIDE FENCE - RIGHT FRONT

U006 S001 S001
B1327547
DC SOLENOID:END FENCE:F
RONT:ASS'Y

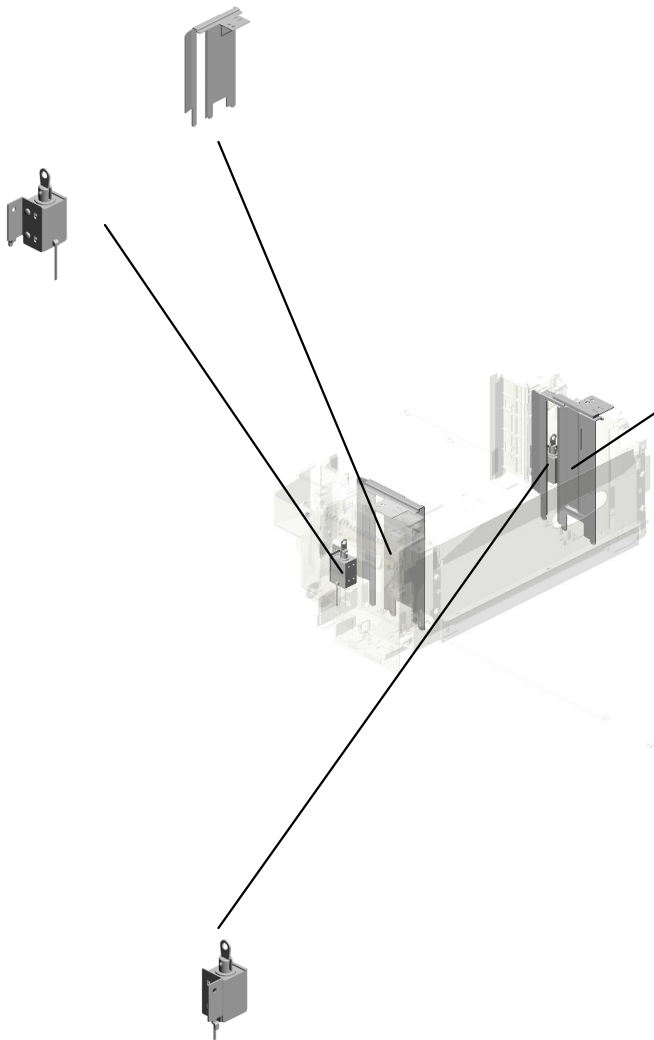

U006 S001 S004
B2346691
SIDE FENCE:TANDEM LCT:R
IGHT:ASS'Y

U006 S001 S002
B1327571
DC SOLENOID:END FENCE:
REAR:ASS'Y

U001	U002	U003	U004	U005	U006	U007	U008	U009	U010	U011	U012	U013	U014	U015	U016	U017	U018	U019	U020	U021
------	------	------	------	------	-------------	------	------	------	------	------	------	------	------	------	------	------	------	------	------	------

U006_S002.(-AA,-EU):TANDEM LCT:RIGHT:ASS'Y

U006 S002 S003
B2346686
SIDE FENCE - RIGHT FRONT

U006 S002 S001
B1327547
DC SOLENOID:END FENCE:F
RONT:ASS'Y

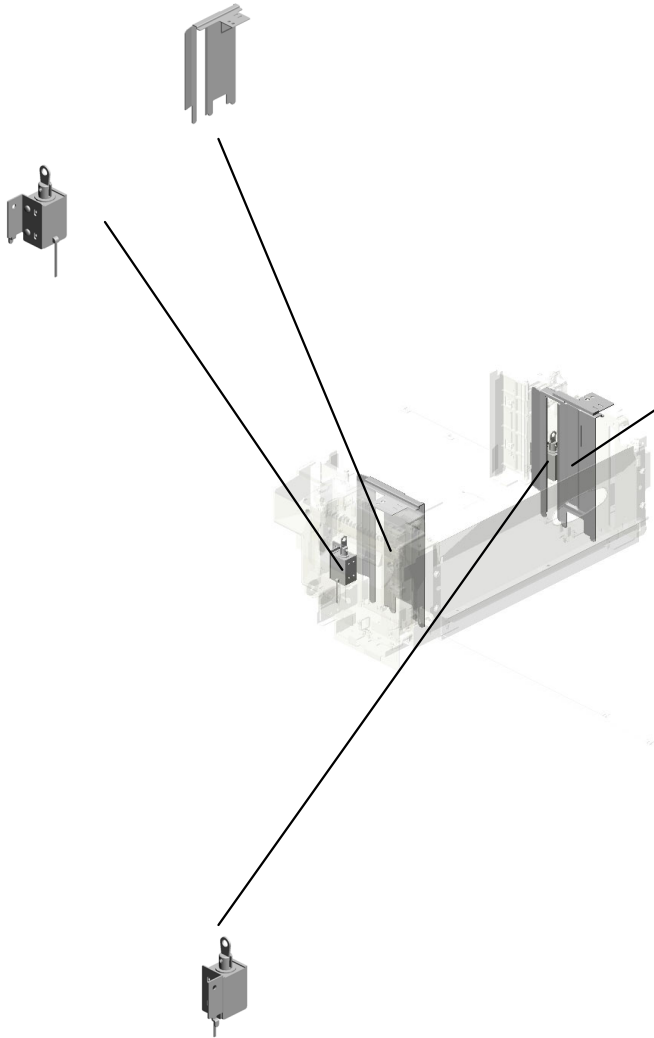

U006 S002 S004
B2346691
SIDE FENCE:TANDEM LCT:R
IGHT:ASS'Y

U006 S002 S002
B1327571
DC SOLENOID:END FENCE:
REAR:ASS'Y

U001	U002	U003	U004	U005	U006	U007	U008	U009	U010	U011	U012	U013	U014	U015	U016	U017	U018	U019	U020	U021
------	------	------	------	------	-------------	------	------	------	------	------	------	------	------	------	------	------	------	------	------	------

U006_S003.(-NA):TANDEM LCT:RIGHT:ASS'Y

U006 S003 S003
B2346686
SIDE FENCE - RIGHT FRONT

U006 S003 S001
B1327547
DC SOLENOID:END FENCE:F
RONT:ASS'Y

U006 S003 S004
B2346691
SIDE FENCE:TANDEM LCT:R
IGHT:ASS'Y

U006 S003 S002
B1327571
DC SOLENOID:END FENCE:
REAR:ASS'Y

U001	U002	U003	U004	U005	U006	U007	U008	U009	U010	U011	U012	U013	U014	U015	U016	U017	U018	U019	U020	U021
------	------	------	------	------	-------------	------	------	------	------	------	------	------	------	------	------	------	------	------	------	------

U006_S004.(-CHN):TANDEM LCT:RIGHT:ASS'Y

U006 S004 S003
B2346686
SIDE FENCE - RIGHT FRONT

U006 S004 S001
B1327547
DC SOLENOID:END FENCE:F
RONT:ASS'Y

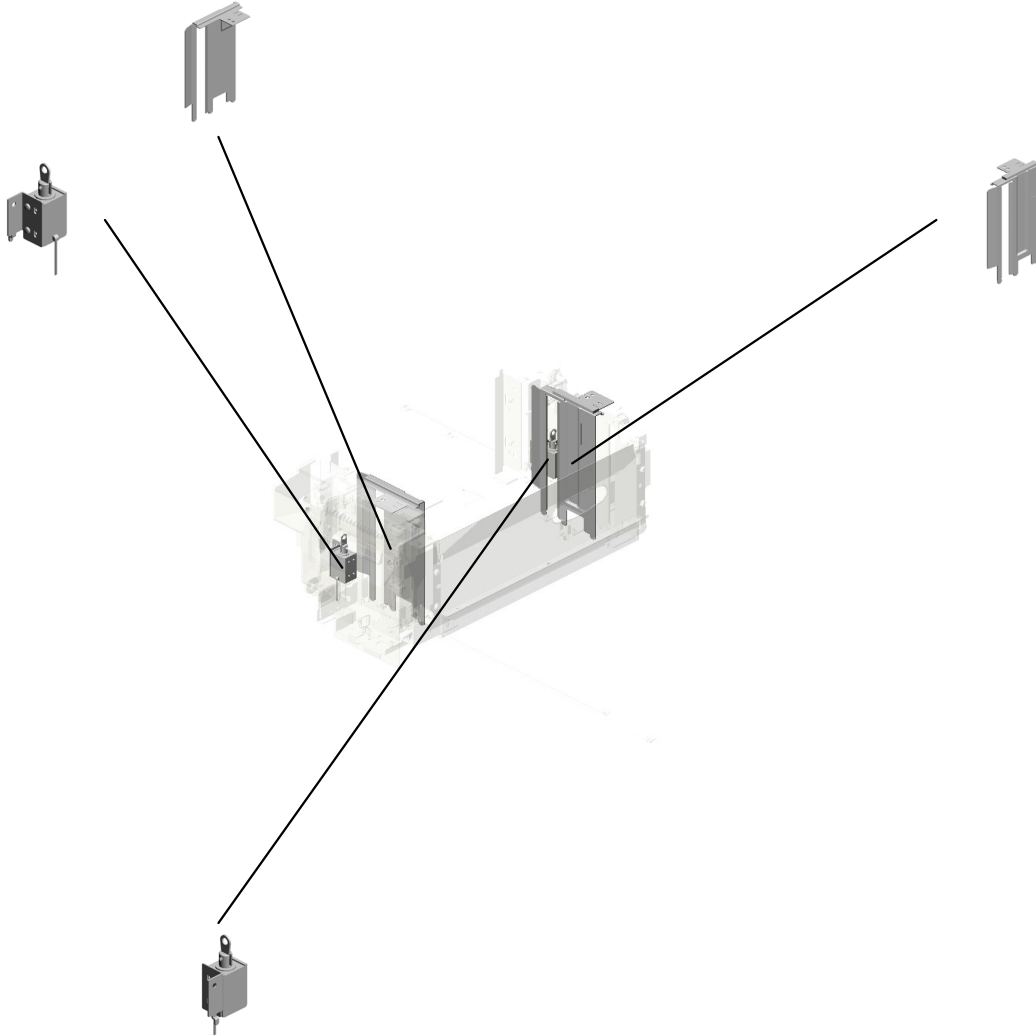

U006 S004 S004
B2346691
SIDE FENCE:TANDEM LCT:R
IGHT:ASS'Y

U006 S004 S002
B1327571
DC SOLENOID:END FENCE:
REAR:ASS'Y

U001	U002	U003	U004	U005	U006	U007	U008	U009	U010	U011	U012	U013	U014	U015	U016	U017	U018	U019	U020	U021
------	------	------	------	------	-------------	------	------	------	------	------	------	------	------	------	------	------	------	------	------	------

U006_S005.(-AA,-EU):TANDEM LCT:LEFT:ASS'Y

U006 S005 S001
D0A57144
SIDE FENCE:TANDEM LCT:L
LEFT REAR:ASS'Y

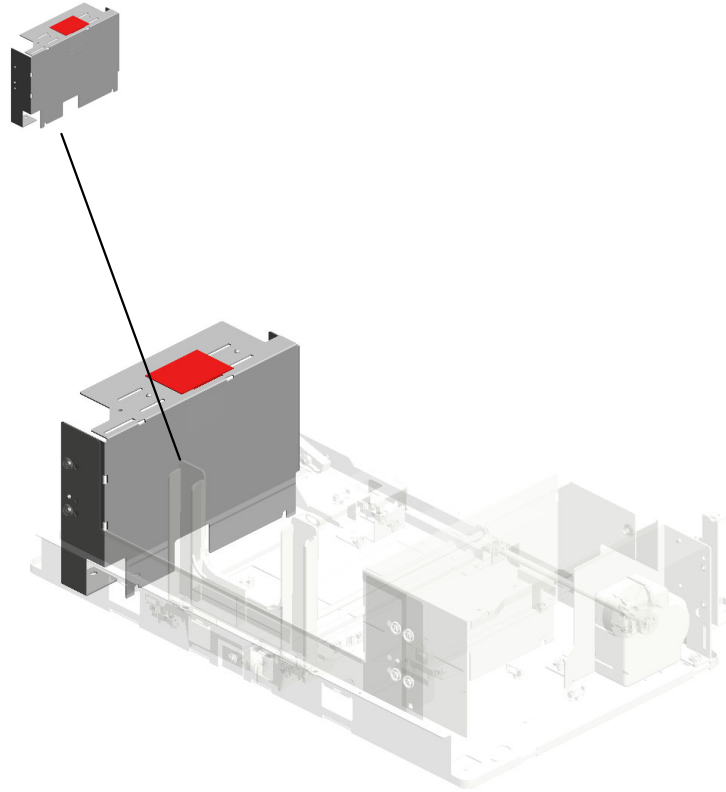

U001	U002	U003	U004	U005	U006	U007	U008	U009	U010	U011	U012	U013	U014	U015	U016	U017	U018	U019	U020	U021
------	------	------	------	------	-------------	------	------	------	------	------	------	------	------	------	------	------	------	------	------	------

U006_S006.(-AA,-EU):TANDEM LCT:LEFT:ASS'Y

U006 S006 S001
D0A57144
SIDE FENCE:TANDEM LCT:L
LEFT REAR:ASS'Y

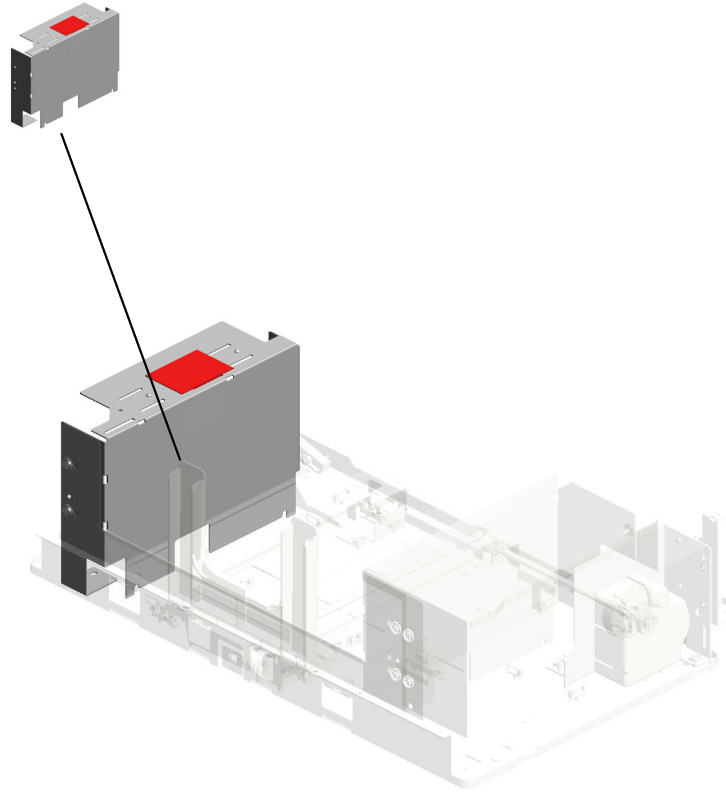

U001	U002	U003	U004	U005	U006	U007	U008	U009	U010	U011	U012	U013	U014	U015	U016	U017	U018	U019	U020	U021
------	------	------	------	------	-------------	------	------	------	------	------	------	------	------	------	------	------	------	------	------	------

U006_S007.(-NA):TANDEM LCT:LEFT:ASS'Y

U006 S007 S001
D0A57144
SIDE FENCE:TANDEM LCT:L
LEFT REAR:ASS'Y

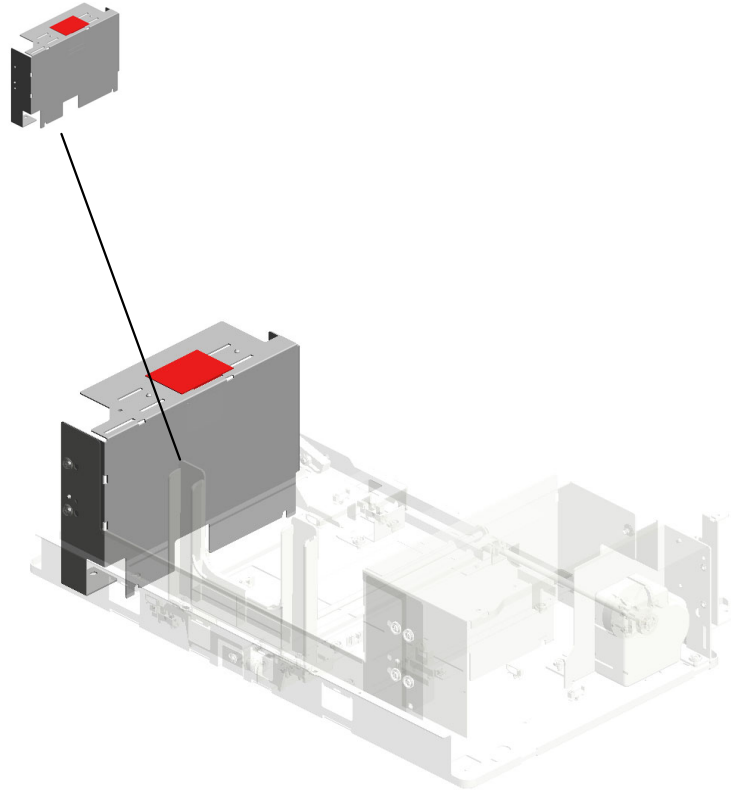

U001	U002	U003	U004	U005	U006	U007	U008	U009	U010	U011	U012	U013	U014	U015	U016	U017	U018	U019	U020	U021
------	------	------	------	------	-------------	------	------	------	------	------	------	------	------	------	------	------	------	------	------	------

U006_S008.(-CHN):TANDEM LCT:LEFT:ASS'Y

U006 S008 S001
D0A57144
SIDE FENCE:TANDEM LCT:L
LEFT REAR:ASS'Y

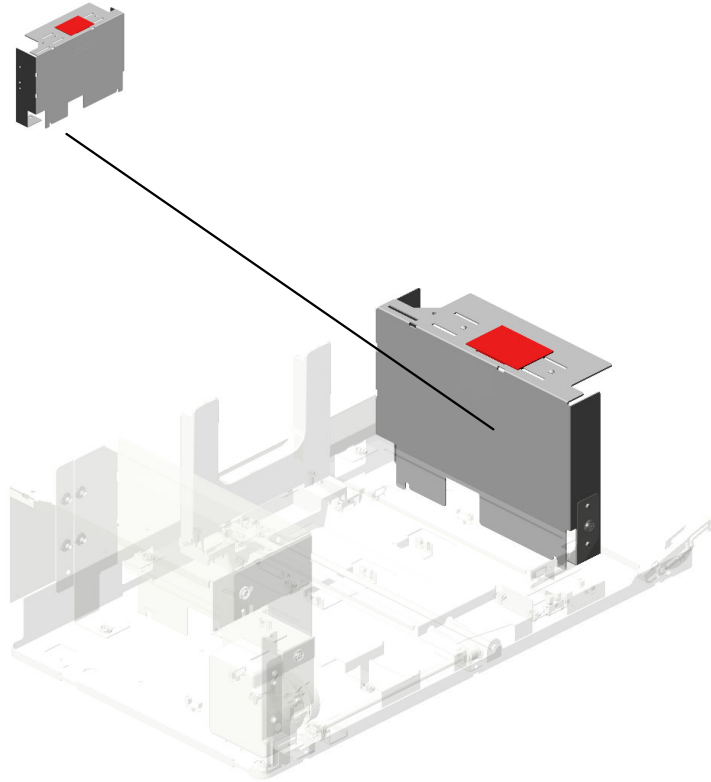

U001	U002	U003	U004	U005	U006	U007	U008	U009	U010	U011	U012	U013	U014	U015	U016	U017	U018	U019	U020	U021
------	------	------	------	------	-------------	------	------	------	------	------	------	------	------	------	------	------	------	------	------	------

U006_S009.PAPER TRAY:UNIVERSAL:SUB-ASS'Y

U006 S009 S001
D1316775
SIDE FENCE:REAR:ASS'Y

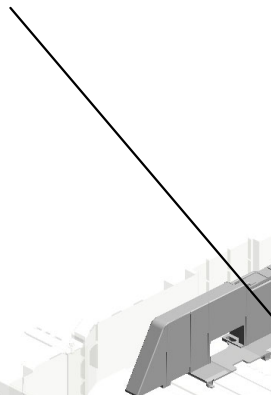

U006 S009 S002
D1316777
SIDE FENCE:FRONT:ASS'Y

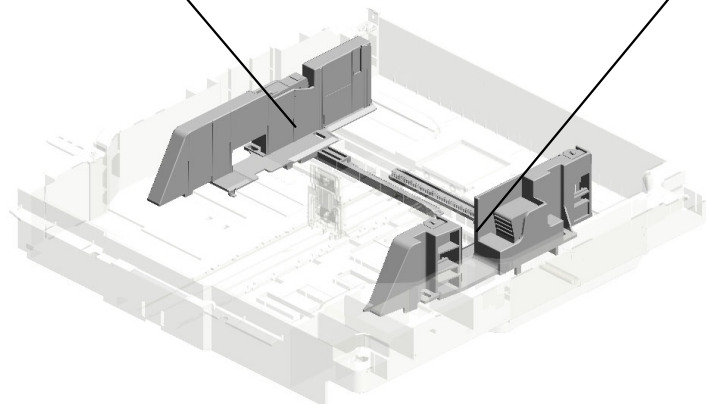
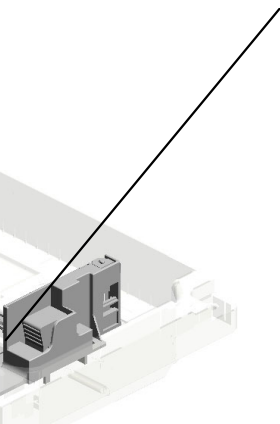

U001	U002	U003	U004	U005	U006	U007	U008	U009	U010	U011	U012	U013	U014	U015	U016	U017	U018	U019	U020	U021
------	------	------	------	------	-------------	------	------	------	------	------	------	------	------	------	------	------	------	------	------	------

U006_S018.PAPER FEED UNIT:PAPER BANK:ASS'Y

U006 S018 S001
D0747527
SHAFT:FEED:ASS'Y

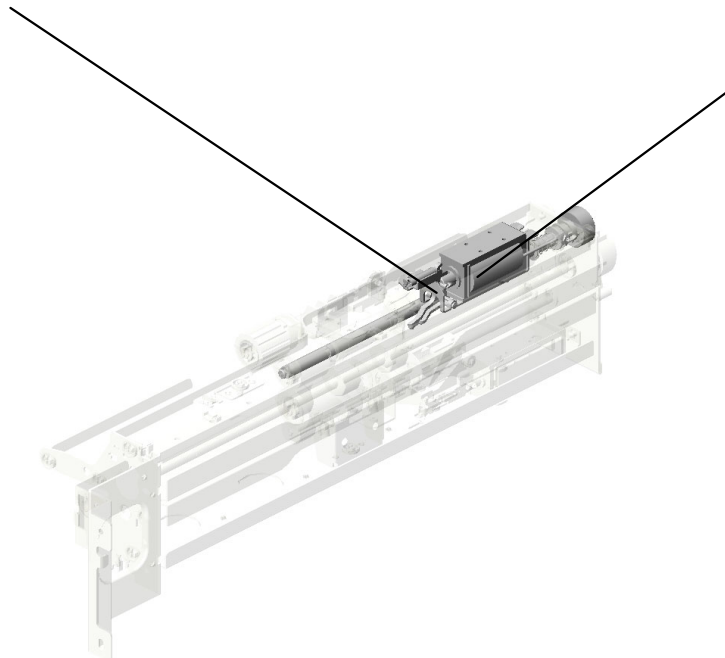

U006 S018 S002
B2346282
PICKUP DC SOLENOID

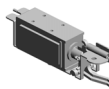

U001	U002	U003	U004	U005	U006	U007	U008	U009	U010	U011	U012	U013	U014	U015	U016	U017	U018	U019	U020	U021
------	------	------	------	------	-------------	------	------	------	------	------	------	------	------	------	------	------	------	------	------	------

U006_S019.PAPER FEED UNIT:PAPER BANK:ASS'Y

U006 S019 S001
D0747527
SHAFT:FEED:ASS'Y

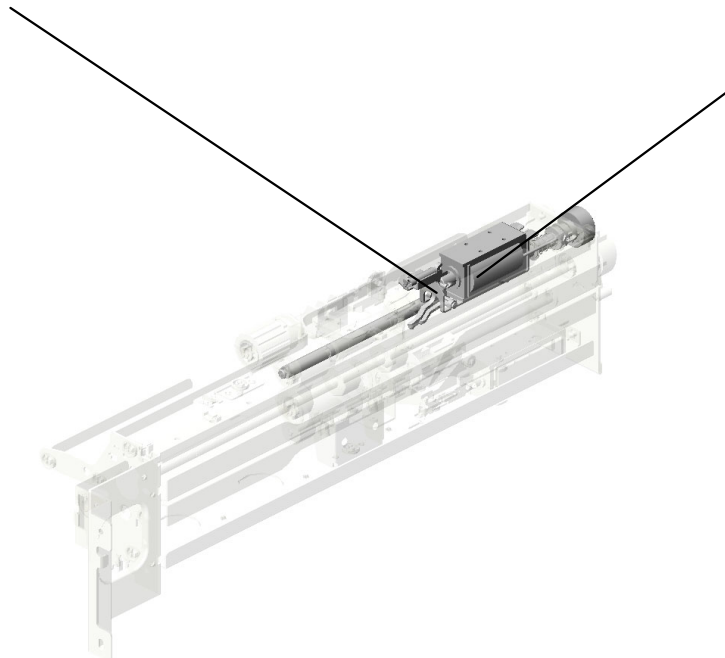

U006 S019 S002
B2346282
PICKUP DC SOLENOID

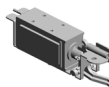

U001	U002	U003	U004	U005	U006	U007	U008	U009	U010	U011	U012	U013	U014	U015	U016	U017	U018	U019	U020	U021
------	------	------	------	------	-------------	------	------	------	------	------	------	------	------	------	------	------	------	------	------	------

U006 PAPER BANK/PAPER FEED/VERTICAL TRANSPORT

18.04514006N (x14) TAPPING SCREW - 4X6
 25.04543006Q (x3) TAPPING SCREW - M3X6
 12.03604008N (x4) SCREW - M4X8
 8.03540040N (x2) SCREW-M4X4
 32.07200040E (x18) RETAINING RING - M4

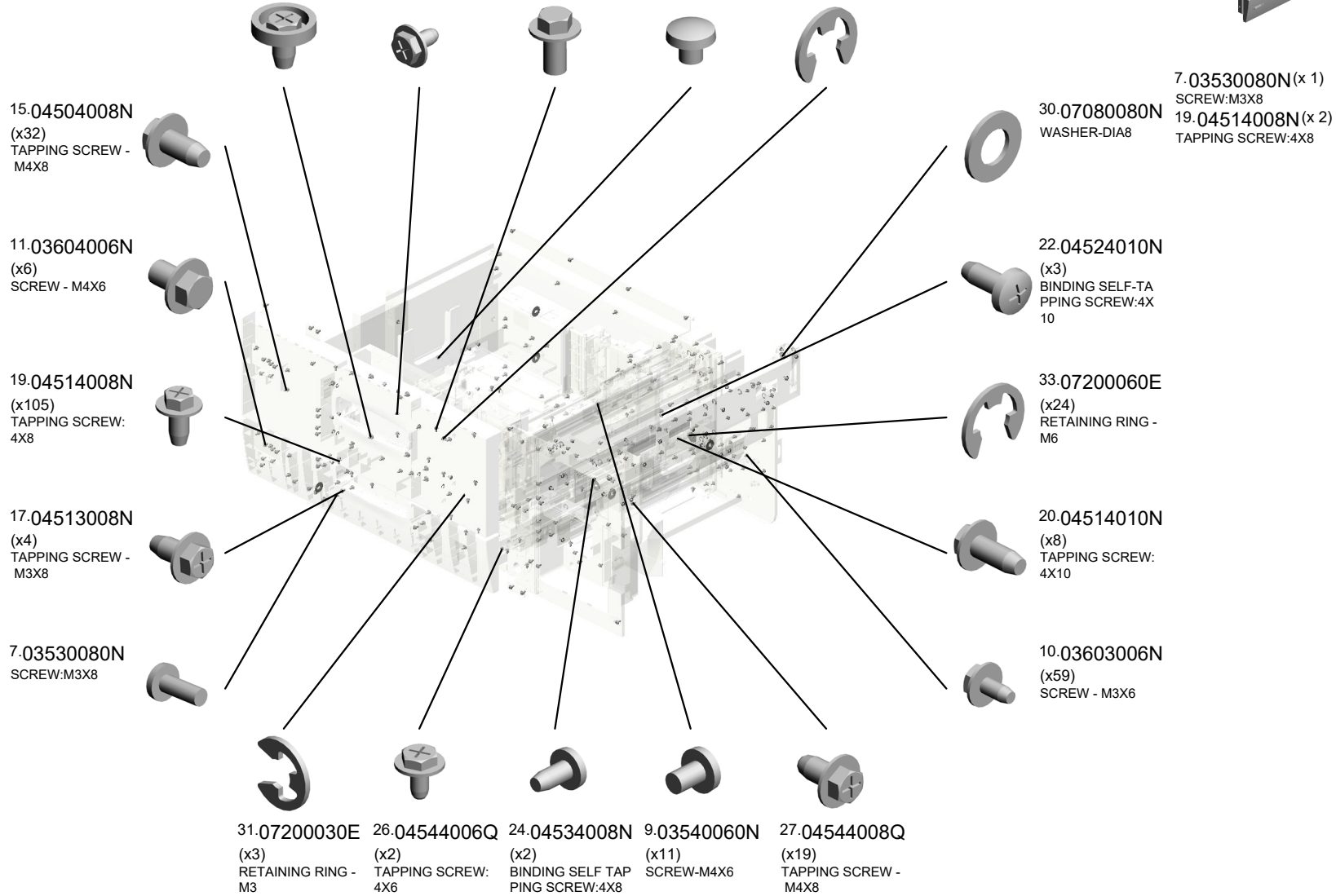
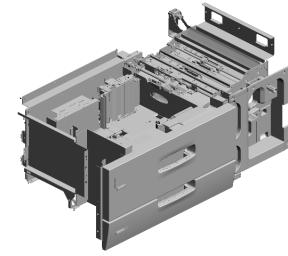

U006 PAPER BANK/PAPER FEED/VERTICAL TRANSPORT

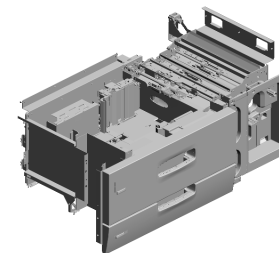

38.08025220 (x2) TAPPING SCREW - M4X8
 40.08046123 HEXAGONAL BOLT :WASHER:M3X8
 62.67542866 (x2) ROLLER - POSITIONING GUIDE
 54.11050692 (x2) CLAMP:LES-0503
 51.11050518 EDGE SADDLE - LES-1010

56.12042570 (x2) ROCKER SWITCH: SDDJE13200

42.08050089 (x10) RETAINING RING - M4

48.11050488 (x2) HARNESS CLAMP

50.11050516 (x13) CLAMP

41.08050088 (x3) RETAINING RING - M6

37.08010237 (x4) HEXAGONAL BOLT :DOUBLE SCREW: M4X12

59.52152621 SNAP RING - M6

47.11050487 (x6) HARNESS CLAMP

44.09514006N (x12) SCREW:POLISHED ROUND:M4X6

60.54472681 (x4) SNAP RING

49.11050511 (x27) HARNESS CLAMP - LWS-0306ZC

53.11050551 (x3) CLAMP:LES-0505

52.11050534 (x2) CLAMP

35.07413708 (x4) BALL BEARING - 8 X12X3.5MM

36.07423808 (x12) BALL BEARING - 8 X16X5

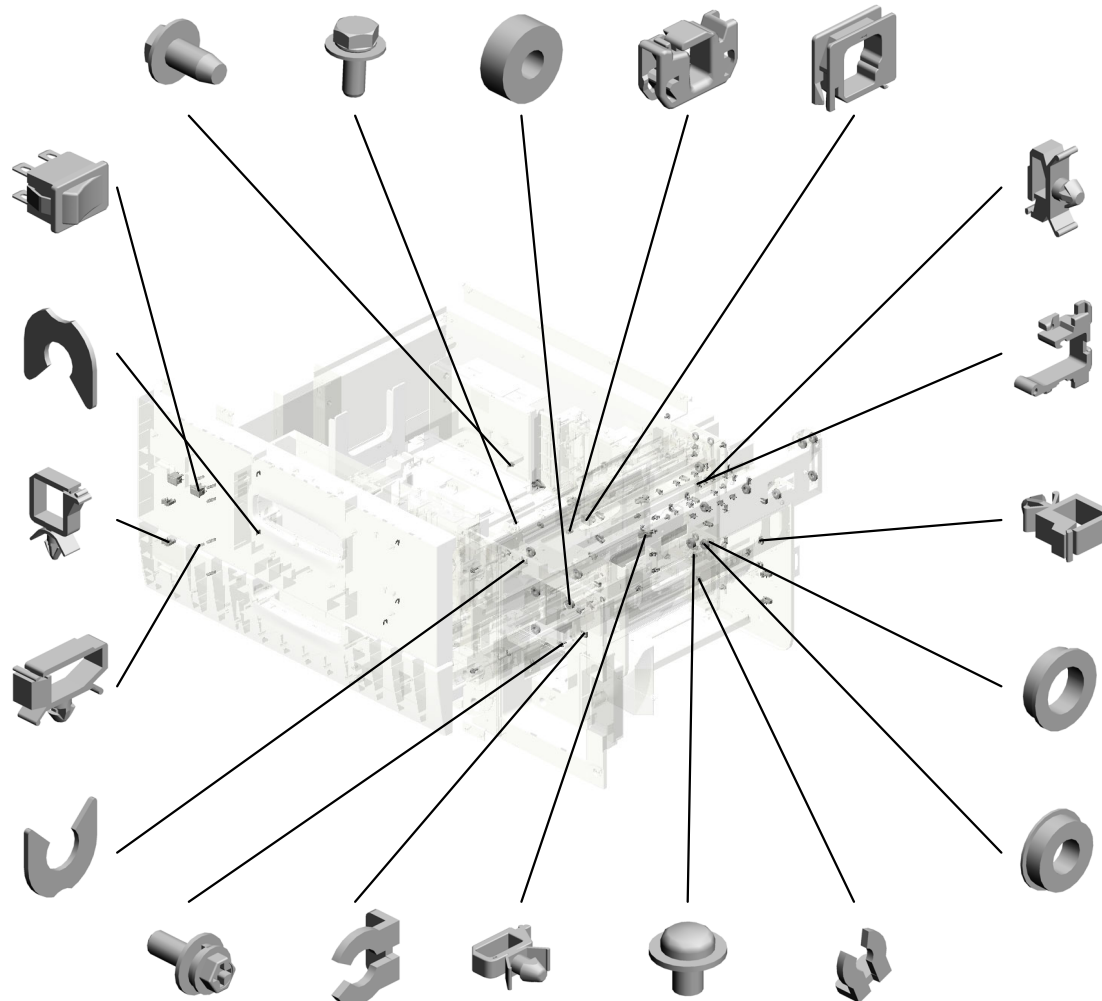

U006 PAPER BANK/PAPER FEED/VERTICAL TRANSPORT

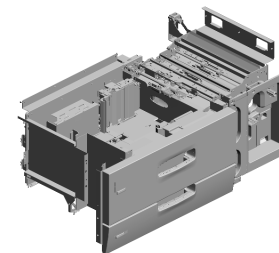

100.AA143585 85.AA063268 90.AA080265 96.AA140912 94.AA132203
 SHAFT:MISFEED R (x2) CONNECTOR SPRING BUSHING:6X8X5 SCREW - 8X14X2.8 SPACER - 6MM
 EMOVAL:UPPER

104.AA143872
(x8)
SCREW:DIA6:M4

89.AA063695
(x4)
COMPRESSION SPRING:GRIP

97.AA140937
SHAFT:GRIP:LOWER

105.AA143883
SHAFT:STOPPER:PAPER TRAY

103.AA143718
STEPPED SCREW - M4

101.AA143586
SHAFT:MISFEED R EMOVAL:LOWER

99.AA143569
(x2)
SCREW

87.AA063693
(x6)
COMPRESSION SPRING:PRESSURE:DRIVEN ROLLER

93.AA084059
(x8)
BALL BEARING HOLDER

102.AA143587
SHAFT:MISFEED R EMOVAL:VERTICAL TRANSPORT

98.AA143550
(x2)
SCREW:DIA4:M3

106.AA148776
SHAFT:DRIVE

91.AA080346
(x2)
BUSHING:FLANGE TYPE:DIA6

86.AA063471
(x2)
COMPRESSION SPRING:PRESSURE:8N

88.AA063694
(x2)
COMPRESSION SPRING:HANDLE

U006 PAPER BANK/PAPER FEED/VERTICAL TRANSPORT

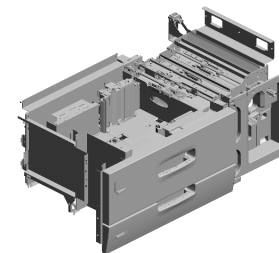

- 151.B0656136 (x2) TRAY LOCK ARM
- 118.AB017725 (x2) GEAR/TIMING PULLEY - 20Z/20T
- 143.AW500010 PUSH SWITCH
- 158.B0656769 LOCK ARM
- 170.B1326726 BRACKET:ARM:ASY

108.AA148778
SHAFT:ARM:PLATE

107.AA148777
SHAFT:ARM:LINK

119.AB017726
GEAR/TIMING PULLEY - 20Z/20T

138.AG050101
(x2)
KNOB - MISFEED REMOVAL

156.B0656591
PAPER TRAY HOLDER BASE

149.B0042995
(x2)
CAP - POSITIONING

144.AW500023
PUSH SWITCH

137.AG050100
KNOB - TRANSPORT ROLLER

133.AF022165
(x3)
TRANSPORT ROLLER - DRIVEN

127.AF020740
(x2)
TRANSPORT ROLLER:VERTICAL TRANSPORT:DRIVE

128.AF020741
TRANSPORT ROLLER:GRIP:DRIVE

112.AA161172
CUSHION:GUIDE PLATE

131.AF020786
TRANSPORT ROLLER:EXIT:PAPER BANK:DRIVE

146.AX040157
(x4)
STEPPER MOTOR
DC1.68V 6.7W

109.AA161122
(x4)
MOTOR CUSHION

U006 PAPER BANK/PAPER FEED/VERTICAL TRANSPORT

222.B2476753 LOCK SPRING - LARGE
 223.B2476754 LOCK SPRING - SMALL
 192.B2346141 POSITIONING SLIDE - INNER BACK
 174.B1326764 BRACKET:CONNECTOR:RIGHT
 171.B1326738 BRACKET:LIFT MOTOR:TANDEM LEFT

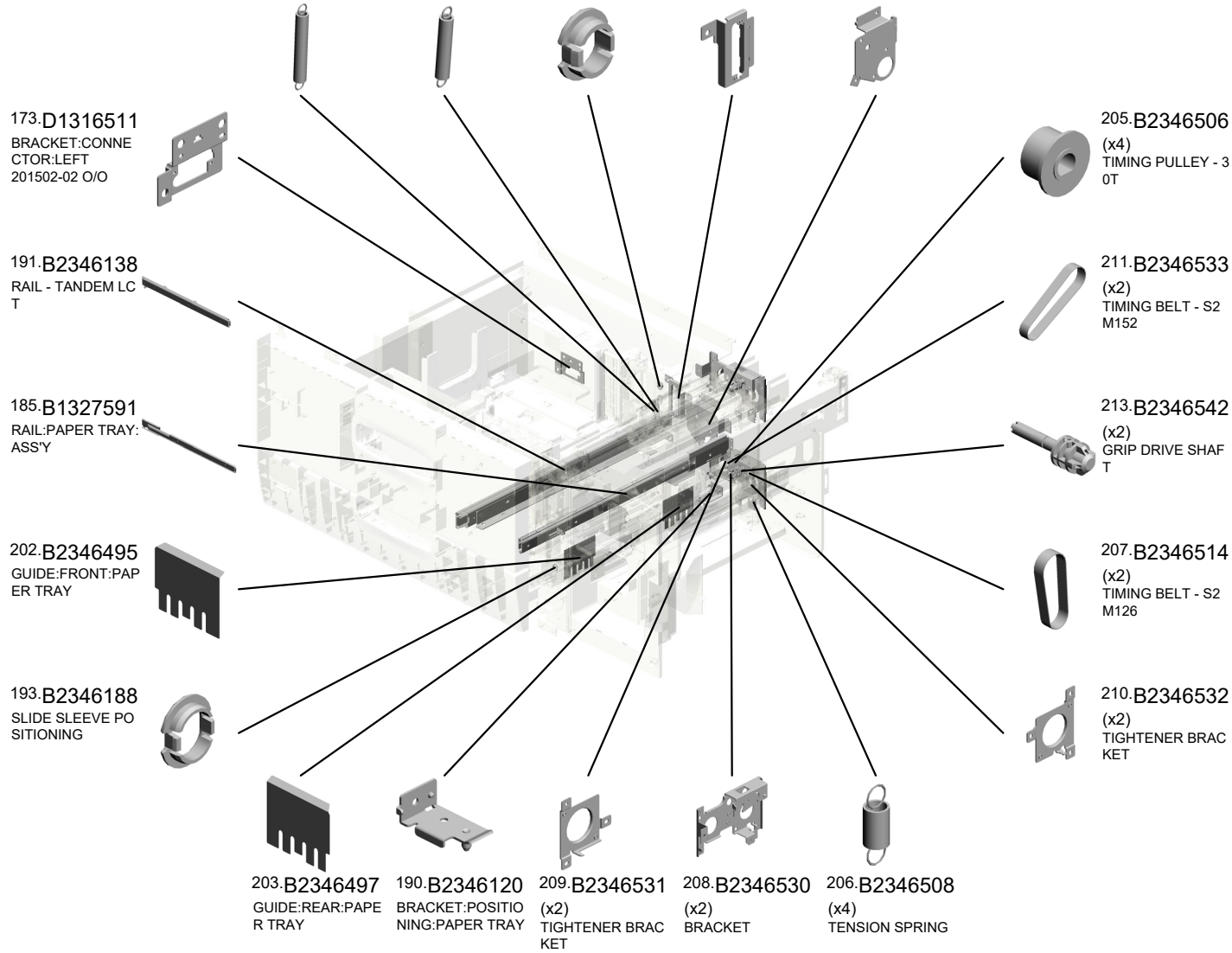
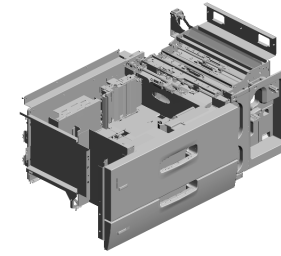

U006 PAPER BANK/PAPER FEED/VERTICAL TRANSPORT

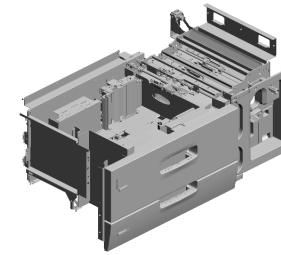

233.BA146065 243.D0590761 253.D0596591 237.C2693566 248.D0596172
 SHAFT:STOPPER: SPRING:TANDEM SPRING:PAPER TR BUSHING:MM8:PR PAPER TRAY STO
 TANDEM LCT TRAY:LOCK AY:LOCK (x4) ESSURE:DRIVE PPER

232.B8343312
(x4)
COLLAR

247.D0596170
BRACKET:SLIDE R
AIL:PAPER TRAY:2
:ASS'Y

262.D0596721
STOPPER:PAPER
TRAY

264.D0596728
(x2)
COMPRESSION SP
RING:GRIP:PAPER
TRAY

263.D0596725
BRACKET:STOPPE
R:PAPER TRAY:RI
GHT:PEEN



246.D0596121
(x2)
SPRING:CONNECT
OR:TANDEM LCT

257.D0596664
GUIDE:MIDDLE:PA
PER TRAY

244.D0592399
(x2)
FLANGED HEXAG
ONAL HEAD BOLT:
M3*4

230.B7004428
TIMING BELT:B40S
2M158

231.B8323909
(x3)
BRACKET CUSHIO
N

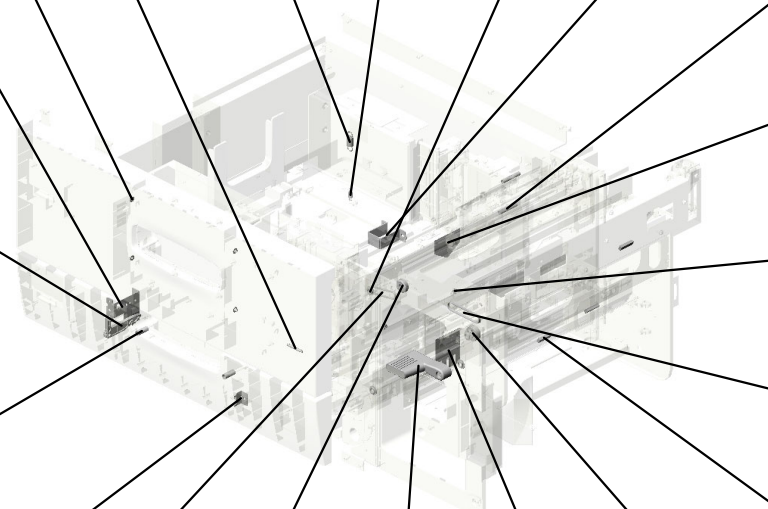

229.B7001802
TIMING BELT:B40S
2M134

234.BB013007
GEAR - 20Z

227.B3033682
MISFEED REMOVA
L KNOB

252.D0596496
GUIDE:MIDDLE:PA
PER TRAY

236.BB013011
GEAR - 22Z



U006 PAPER BANK/PAPER FEED/VERTICAL TRANSPORT

- 269.D0626692 SLIDE RAIL:PAPER TRAY:LEFT:SUB-ASSY
- 277.D0747330 SLIDE RAIL:LEFT:NO.1
- 278.D0747331 STAY:SLIDE RAIL:LEFT INNER REAR:NO.1:PEEN
- 280.D0747335 STAY:SLIDE RAIL:LEFT:NO.2
- 281.D0747349 (x2) COMPRESSION SPRING:BRACKET:SENSOR:PAPER SIZE SENSOR

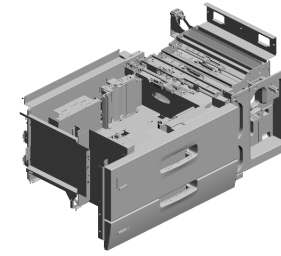

291.D0747392
DECAL:PAPER TRAY:NO.1



279.D0747333
STAY:SLIDE RAIL:LEFT FRONT:NO.1

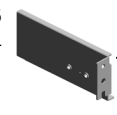

292.D0747393
DECAL:PAPER TRAY:NO.2



274.D0744854
(x2)
INNER COVER:RECEIVING SUB-UNIT:LEFT LOWER:LED

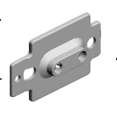

282.D0747367
BRACKET:STOPPER:TANDEM LCT



270.D0741387
SHAFT:JOINT:PAPER FEED UNIT:ASSY



271.D0741389
COMPRESSION SPRING:JOINT:TRANSPORT



272.D0743173
(x11)
TIMING PULLEY:S2M:25T



286.D0747384
DECAL:VERTICAL TRANSPORT:B2



273.D0743490
FUNNEL:DEVELOPER

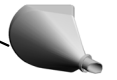

265.D0596731
SHIELD:GUIDE:MISFEED REMOVAL

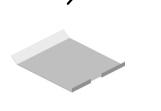

284.D0747382
DECAL:VERTICAL TRANSPORT:A2

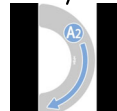

285.D0747383
DECAL:VERTICAL TRANSPORT:A3

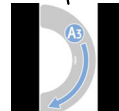

283.D0747381
DECAL:VERTICAL TRANSPORT:A1



276.D0747326
SLIDE RAIL:RIGHT:NO.2:ASSY



U006

PAPER BANK/PAPER FEED/VERTICAL TRANSPORT

310.D0747558 COVER:GRIP:INNER BACK
 311.D0747561 GRIP:UPPER
 317.D0747570 BASE:LINK:PAPER TRAY:ASS'Y
 316.D0747568 BRACKET:FIX:AUXILIARY:COVER
 314.D0747566 (x2) BRACKET:ARM:LINK

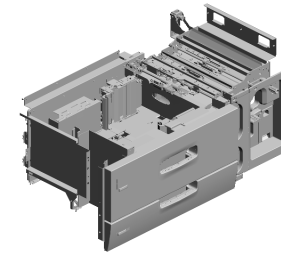

318.D0747573 BRACKET:ARM:PLATE

309.D0747551 COVER:PAPER TRAY:NO.1

315.D0747567 (x2) BRACKET:ARM:LINK:LEFT

312.D0747562 GRIP:LOWER

313.D0747565 STAY:COVER:PAPER TRAY

298.D0747461 GUIDE PLATE:GRIP:LOWER

301.D0747476 GUIDE PLATE:OPEN AND CLOSE:ASS'Y

296.D0747450 GUIDE PLATE:VERTICAL TRANSPORT:DRIVE

297.D0747455 GUIDE PLATE:GRIP:UPPER

293.D0747431 STAY:HANDLE:ASS'Y

295.D0747446 (x2) BRACKET:DC STEPPER MOTOR:TRANSPORT UNIT

299.D0747470 GUIDE PLATE:CONNECTING:UPPER

300.D0747474 GUIDE PLATE:CONNECTING:RIGHT

302.D0747481 GUIDE PLATE:OPEN AND CLOSE:CONNECTING:ASS'Y

294.D0747433 (x2) STUD:HANDLE:RELEASE:ASS'Y

U006 PAPER BANK/PAPER FEED/VERTICAL TRANSPORT

354.D5161261 (x2) COVER:LED
 328.D0747609 (x2) PROTECTION:COVER:LED
 356.D5165200 (x4) PCB:LED:ASS'Y
 319.D0747575 LINK:UPPER LOWER:LEFT:ASS'Y
 338.D1945941 STAY:SLIDE RAIL:LEFT FRONT

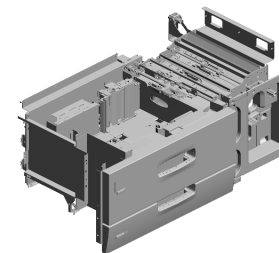

355.D5161453 (x2) DIFFUSION PLATE:LED

325.D0747603 PLATE:GRIP:PAPER TRAY:NO.2

324.D0747601 COVER:PAPER TRAY:NO.2

326.D0747606 GRIP:PAPER TRAY:NO.2

327.D0747607 ARM:PAPER TRAY:GRIP

320.D0747577 LINK:UPPER LOWER:ASS'Y

321.D0747579 STOPPER:TANDEM LCT

329.D0747654 INNER COVER:VERTICAL TRANSPORT:LEFT

357.G1785029 GEAR:DECURAZZ0/M1

331.D0747659 COVER:FUNNEL DEVELOPER

339.D1947346 DC MOTOR:RISE:TANDEM LCT:ASS'Y:19.2W:BRUSH

353.D3553858 (x2) TORSION SPRING:GUIDE PLATE:16N

337.D1942999 (x2) DC STEPPER MOTOR:PAPER TRANSPORT MD:MM42:ASS'Y

350.D3553828 (x2) HOLDER:STAY:GUIDE PLATE

352.D3553844 (x4) SHOE:HANDLE:RELEASE

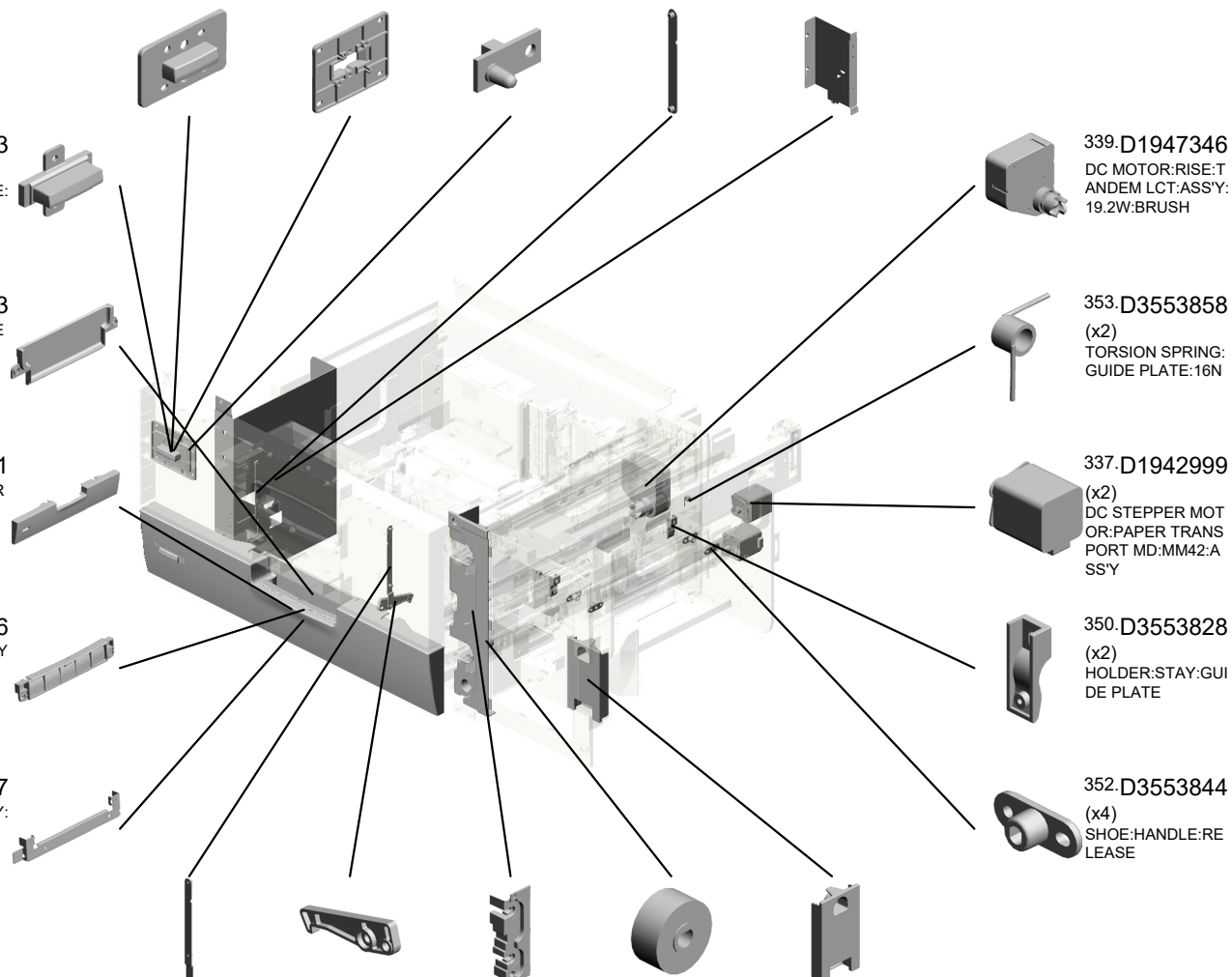

U006 PAPER BANK/PAPER FEED/VERTICAL TRANSPORT

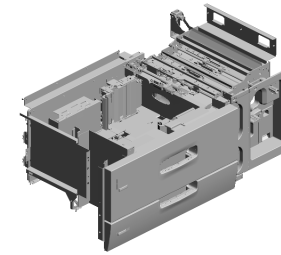

360.AA143797 (x2) CONNECTOR GUI DE PIN 201502-03 X/O
 358.GW010007 (x5) PHOTO REFLECTI ON SENSOR:EXIT
 359.M0774862 TRANSPORT ROLL ER:DRIVEN:DUPLER:DIA18X2
 369.D2706541 (x2) SHAFT:DRIVE:FEE D:ASSY 201904-05 O/O

362.B1325996
 DECAL:TOTAL CO UNTER 201705-01



363.D1947657
 INNER COVER:VE RTICAL TRANSPOR T:RIGHT:DECAL: SUB-ASS'Y 201710-05 O/O



364.AA043737 (x2) TIMING BELT:60S2 M188 202005-01 O/O



364.AA043737 (x4) TIMING BELT:60S2 M188 201805-04 O/O

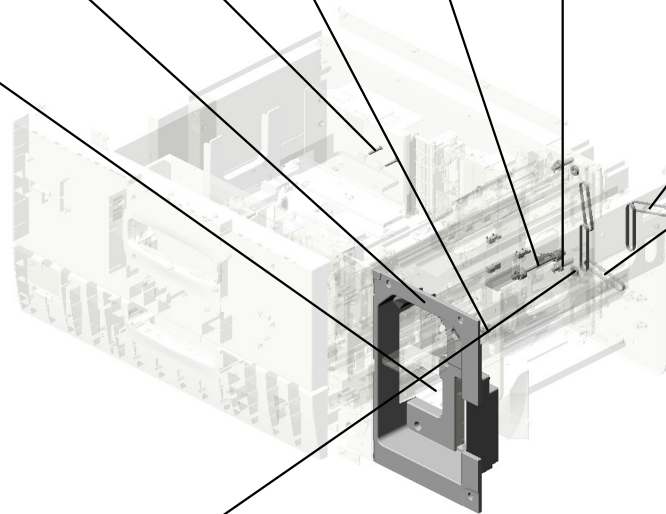

365.07433808 (x4) RADIAL BALL BEA RING:DIA8XDIA16X 5 201807-01 O/O



U006_S001
 (-AA,-EU):TANDEM LCT:RIGHT:ASS'Y

27.04544008Q (x15) TAPPING SCREW - M4X8
 67.A2486713 (x2) HOOK - TENSION SPRING
 21.04523006N (x4) BINDING SELF-TAPPING SCREW:3X6
 32.07200040E (x8) RETAINING RING - M4
 66.A2486695 (x4) GUIDE - PULLEY

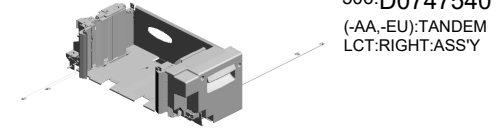

306.D0747540
 (-AA,-EU):TANDEM LCT:RIGHT:ASSY

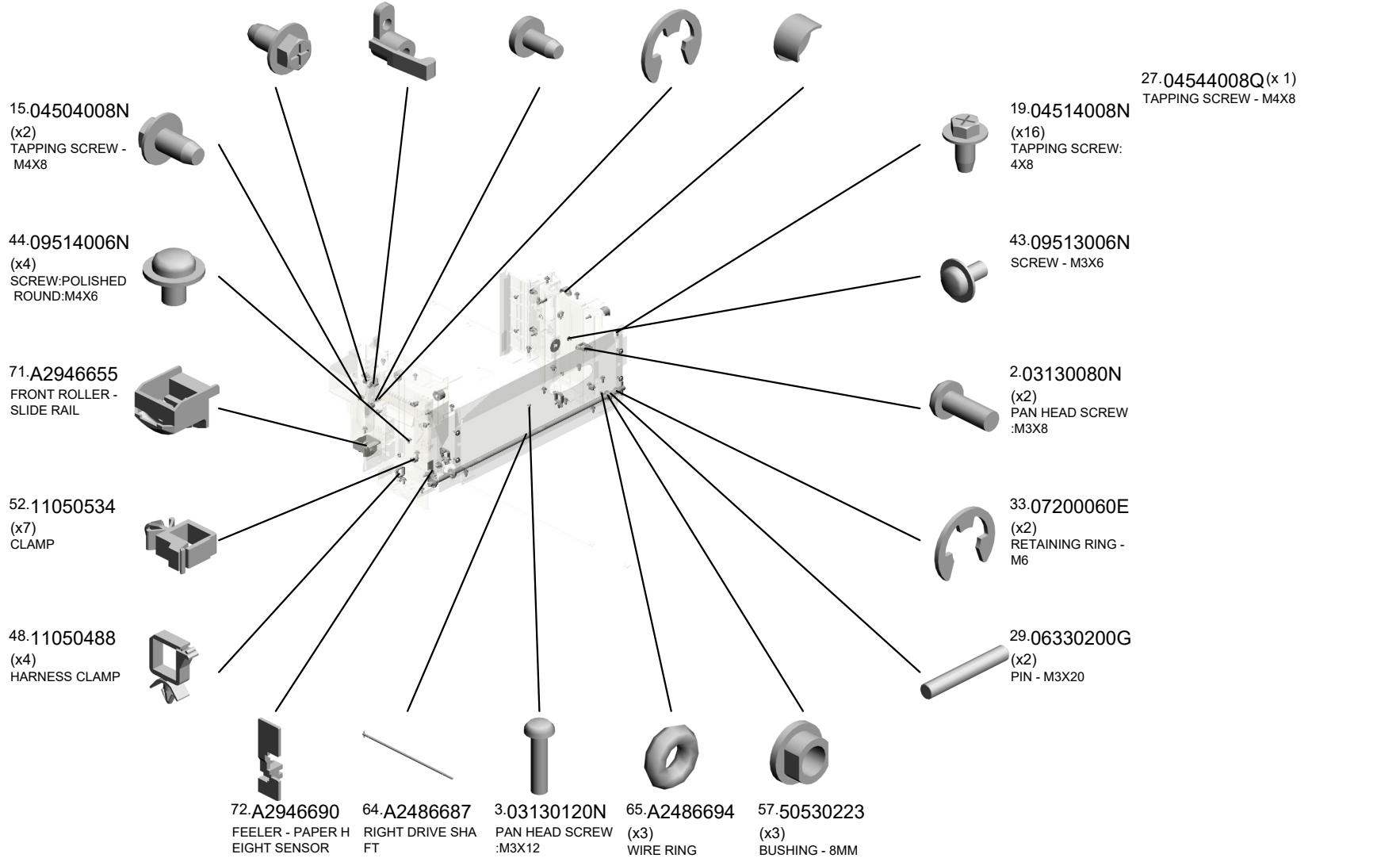

U001	U002	U003	U004	U005	U006	U007	U008	U009	U010	U011	U012	U013	U014	U015	U016	U017	U018	U019	U020	U021
------	------	------	------	------	-------------	------	------	------	------	------	------	------	------	------	------	------	------	------	------	------

U006_S001
 (-AA,-EU):TANDEM LCT:RIGHT:ASS'Y

- 79.AA060757 (x2) TENSION SPRING - LONG
- 122.AB032058 (x2) WIRE PULLEY - M10
- 123.AB032719 (x2) PULLEY - M10
- 180.B1327550 (x2) COVER:PULLEY:DRIVE WERE
- 169.B0706684 LEVER:RELEASE:RIGHT EAR

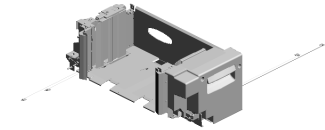

306.D0747540
 (-AA,-EU):TANDEM LCT:RIGHT:ASSY

140.AW020145 (x9) PHOTOINTERRUPTOR:FLAT



80.AA060758 (x2) TENSION SPRING - SHORT



168.B0706683 LEVER:RELEASE:FRONT



166.B0656875 PROTECTION -INNER COVER

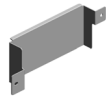

167.B0706667 END FENCE COVER FRONT



157.B0656717 PAPER VOLUME SHIELD PLATE



165.B0656872 OIL DAMPER BRACKET



116.AB013781 GEAR - 30Z



164.B0656870 (x2) STAY -RIGHTBASE



139.AW010113 SENSOR

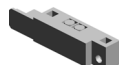

163.B0656864 SMALL LEVER



94.AA132203 SPACER - 6MM



184.B1327575 BRACKET:CONNECTOR:TANDEM LCT



132.AF022105 ROLLER - SLIDERAIL



162.B0656862 LARGE LEVER



U001	U002	U003	U004	U005	U006	U007	U008	U009	U010	U011	U012	U013	U014	U015	U016	U017	U018	U019	U020	U021
------	------	------	------	------	------	------	------	------	------	------	------	------	------	------	------	------	------	------	------	------

U006_S001

(-AA,-EU):TANDEM LCT:RIGHT:ASS'Y

- 238.D0146626 BRACKET:ON OFF DETECTOR:FRONT
- 217.B2346630 (x2) (-AA,-EU,-CHN):GUIDE PLATE - END FENCE
- 288.D0747388 DECAL:PAPER SE T DIRECTION:TANDEM LCT:RIGHT
- 216.B2346625 END FENCE - REAR
- 239.D0146627 BRACKET:ON OFF DETECTOR:REAR

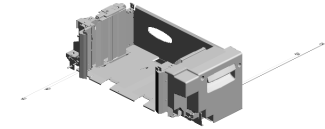

306.D0747540
(-AA,-EU):TANDEM LCT:RIGHT:ASSY

215.B2346612
END FENCE - FRONT



261.D0596712
INNER COVER:TANDEM LCT



287.D0747385
DECAL:CAUTION CHART:TANDEM LCT

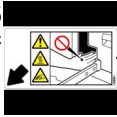

214.B2346606
SENSOR BRACKET



224.B2476901
OIL DAMPER:FALL



192.B2346141
POSITIONING SLEEVE - INNER BACK



275.D0746497 (x2)
DECAL:POSITIONING DISPLAY:TCRU



221.B2476695
GUIDE:MISFEED REMOVAL:PAPER TRAY

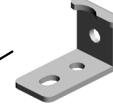

368.AA161178 (x2)
CUSHION:BASE:TANDEM LCT:SMALL 201812-08 O/O

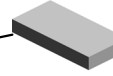

259.D0596668
SIDE PLATE:SIDE:TANDEM LCT

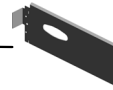

322.D0747595 (-AA,-NA,-EU):BASE:TANDEM LCT:RIGHT:ADHESION

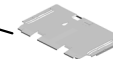

367.AA161177
CUSHION:BASE:TANDEM LCT:LARGE 201812-07 O/O

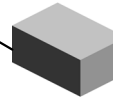

U006_S001_S001
DC SOLENOID:END FENCE:FRONT:ASS'Y

1-03130040N
(x2)
SCREW:M3X4

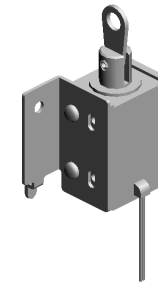

179-B1327547
DC SOLENOID:EN
D FENCE:FRONT:A
SS'Y

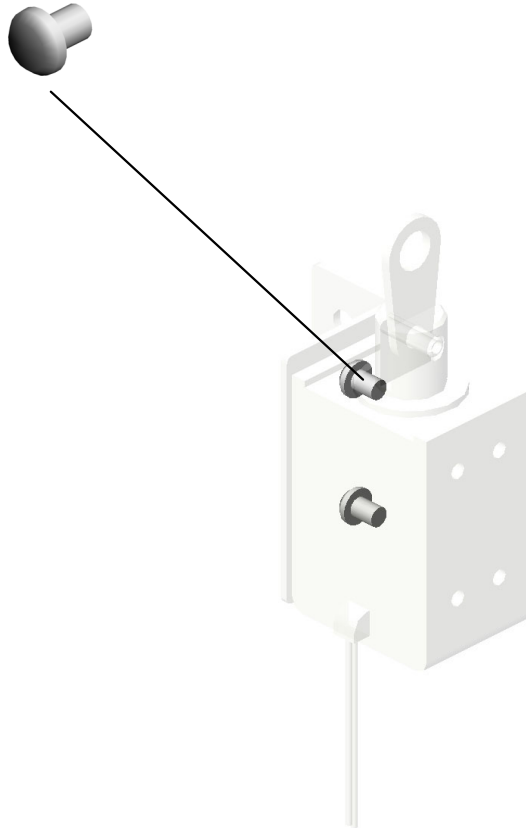

U001	U002	U003	U004	U005	U006	U007	U008	U009	U010	U011	U012	U013	U014	U015	U016	U017	U018	U019	U020	U021
------	------	------	------	------	-------------	------	------	------	------	------	------	------	------	------	------	------	------	------	------	------

U006_S001_S002
DC SOLENOID:END FENCE:REAR:ASS'Y

1-03130040N
(x2)
SCREW:M3X4



183-B1327571
DC SOLENOID:EN
D FENCE:REAR:AS
SY

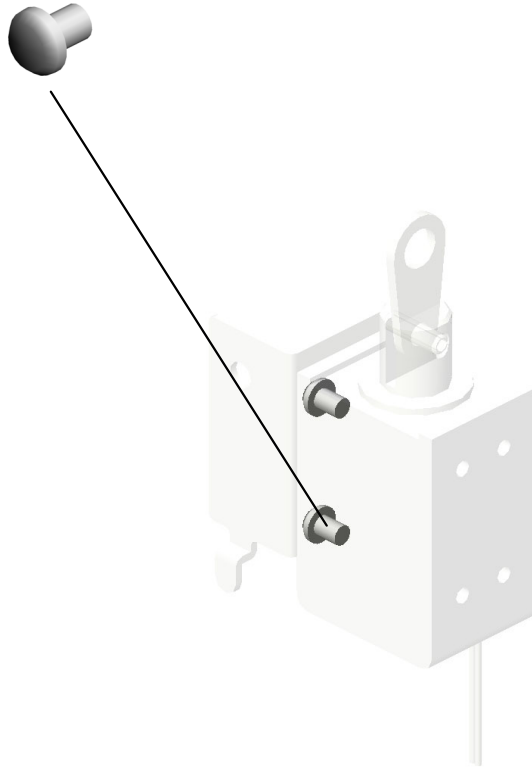

U001	U002	U003	U004	U005	U006	U007	U008	U009	U010	U011	U012	U013	U014	U015	U016	U017	U018	U019	U020	U021
------	------	------	------	------	-------------	------	------	------	------	------	------	------	------	------	------	------	------	------	------	------

U006_S001_S003
SIDE FENCE - RIGHT FRONT

260.D0596690
PLATE:PAPER:ASS
Y

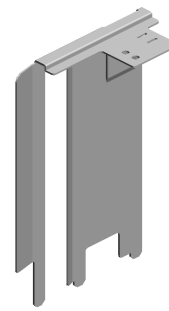
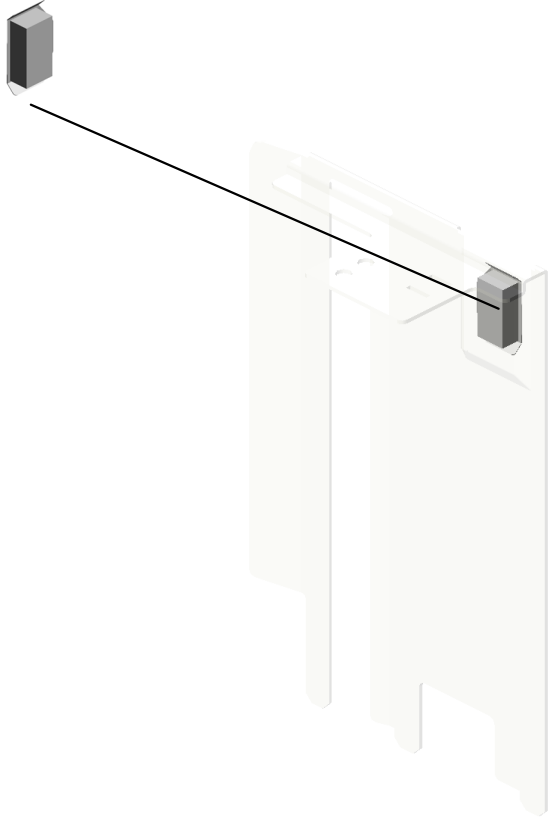

218.B2346686
SIDE FENCE - RIG
HT FRONT

U001	U002	U003	U004	U005	U006	U007	U008	U009	U010	U011	U012	U013	U014	U015	U016	U017	U018	U019	U020	U021
------	------	------	------	------	------	------	------	------	------	------	------	------	------	------	------	------	------	------	------	------

U006_S001_S004
SIDE FENCE:TANDEM LCT:RIGHT:ASS'Y

228.B4756855
SHIELD:TANDEM L
CT:REAR RIGHT

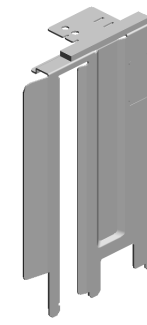

219.B2346691
SIDE FENCE:TAND
EM LCT:RIGHT:AS
SY

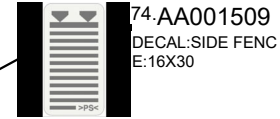
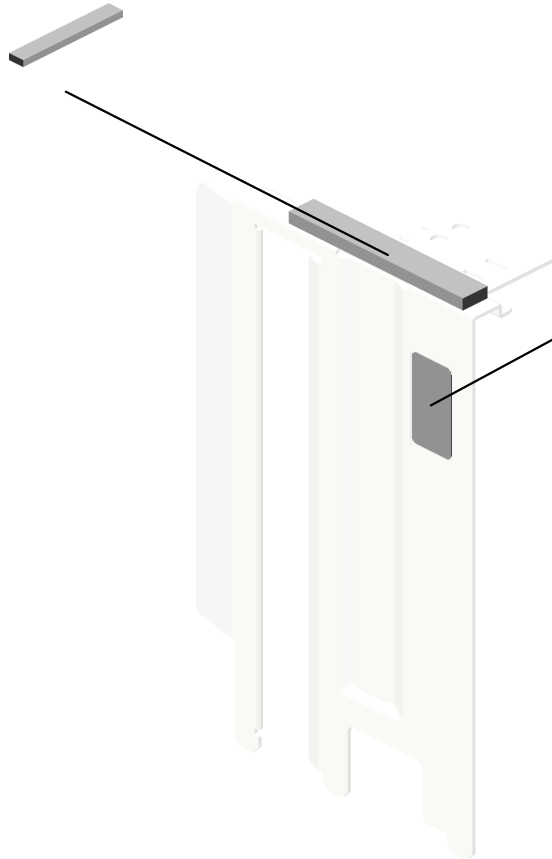

U001	U002	U003	U004	U005	U006	U007	U008	U009	U010	U011	U012	U013	U014	U015	U016	U017	U018	U019	U020	U021
------	------	------	------	------	-------------	------	------	------	------	------	------	------	------	------	------	------	------	------	------	------

U006_S002
 (-AA,-EU):TANDEM LCT:RIGHT:ASS'Y

- 27.04544008Q (x15) TAPPING SCREW - M4X8
- 67.A2486713 (x2) HOOK - TENSION SPRING
- 21.04523006N (x4) BINDING SELF-TAPPING SCREW:3X6
- 32.07200040E (x8) RETAINING RING - M4
- 66.A2486695 (x4) GUIDE - PULLEY

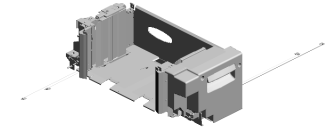

306.D0747540
 (-AA,-EU):TANDEM LCT:RIGHT:ASSY

15.04504008N
 (x2)
 TAPPING SCREW - M4X8

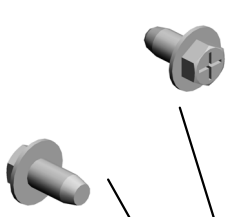

44.09514006N
 (x4)
 SCREW:POLISHED ROUND:M4X6

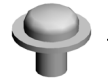

71.A2946655
 FRONT ROLLER - SLIDE RAIL



52.11050534
 (x7)
 CLAMP



48.11050488
 (x4)
 HARNESS CLAMP



72.A2946690
 FEELER - PAPER HEIGHT SENSOR



64.A2486687
 RIGHT DRIVE SHAFT



3.03130120N
 PAN HEAD SCREW :M3X12



65.A2486694 (x3)
 WIRE RING



57.50530223 (x3)
 BUSHING - 8MM



27.04544008Q(x 1)
 TAPPING SCREW - M4X8



19.04514008N
 (x16)
 TAPPING SCREW: 4X8



43.09513006N
 SCREW - M3X6



2.03130080N
 (x2)
 PAN HEAD SCREW :M3X8



33.07200060E
 (x2)
 RETAINING RING - M6



29.06330200G
 (x2)
 PIN - M3X20



U006_S002

(-AA,-EU):TANDEM LCT:RIGHT:ASS'Y

- 79.AA060757 (x2) TENSION SPRING - LONG
- 122.AB032058 (x2) WIRE PULLEY - M10
- 123.AB032719 (x2) PULLEY - M10
- 180.B1327550 (x2) COVER:PULLEY:DRIVE WERE
- 169.B0706684 LEVER:RELEASE:RIGHT EAR

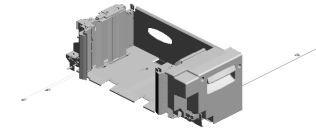

306.D0747540
(-AA,-EU):TANDEM LCT:RIGHT:ASSY

140.AW020145 (x9) PHOTOINTERRUPTOR:FLAT

80.AA060758 (x2) TENSION SPRING - SHORT

168.B0706683 LEVER:RELEASE:FRONT

166.B0656875 PROTECTION -INNER COVER

167.B0706667 END FENCE COVER FRONT

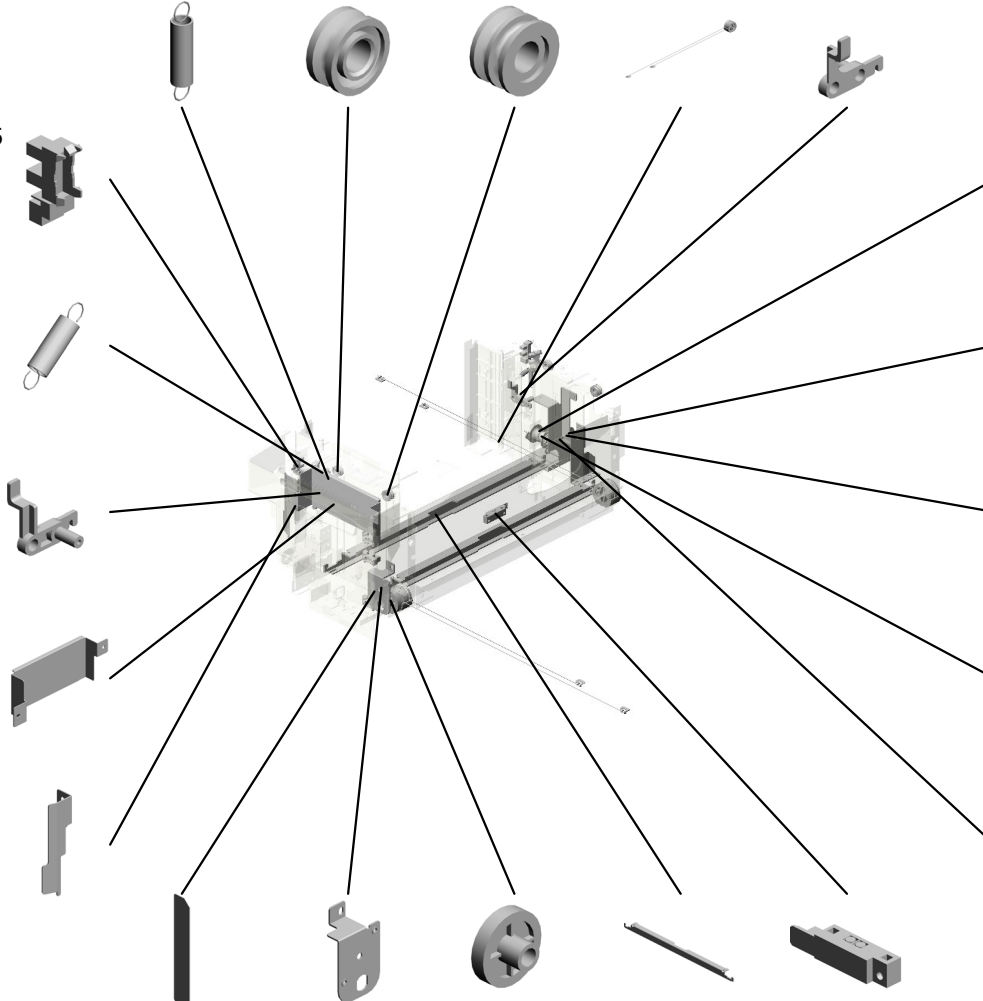

- 157.B0656717 PAPER VOLUME SHIELD PLATE
- 165.B0656872 OIL DAMPER BRACKET
- 116.AB013781 GEAR - 30Z
- 164.B0656870 (x2) STAY -RIGHTBASE
- 139.AW010113 SENSOR

163.B0656864 SMALL LEVER

94.AA132203 SPACER - 6MM

184.B1327575 BRACKET:CONNECTOR:TANDEM LCT

132.AF022105 ROLLER - SLIDER RAIL

162.B0656862 LARGE LEVER

U006_S002
 (-AA,-EU):TANDEM LCT:RIGHT:ASS'Y

238.D0146626 BRACKET:ON OFF
 DETECTOR:FRONT

217.B2346630 (x2)
 (-AA,-EU,-CHN):GUI
 DE PLATE - END F
 ENCE

288.D0747388 DECAL:PAPER SE
 T DIRECTION:TAN
 DEM LCT:RIGHT

216.B2346625 END FENCE - REA
 R

239.D0146627 BRACKET:ON OFF
 DETECTOR:REAR

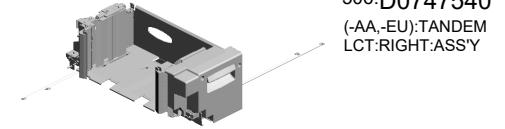

215.B2346612
 END FENCE - FRO
 NT

261.D0596712
 INNER COVER:TA
 NDEM LCT

287.D0747385
 DECAL:CAUTION C
 HART:TANDEM LC
 T

214.B2346606
 SENSOR BRACKE
 T

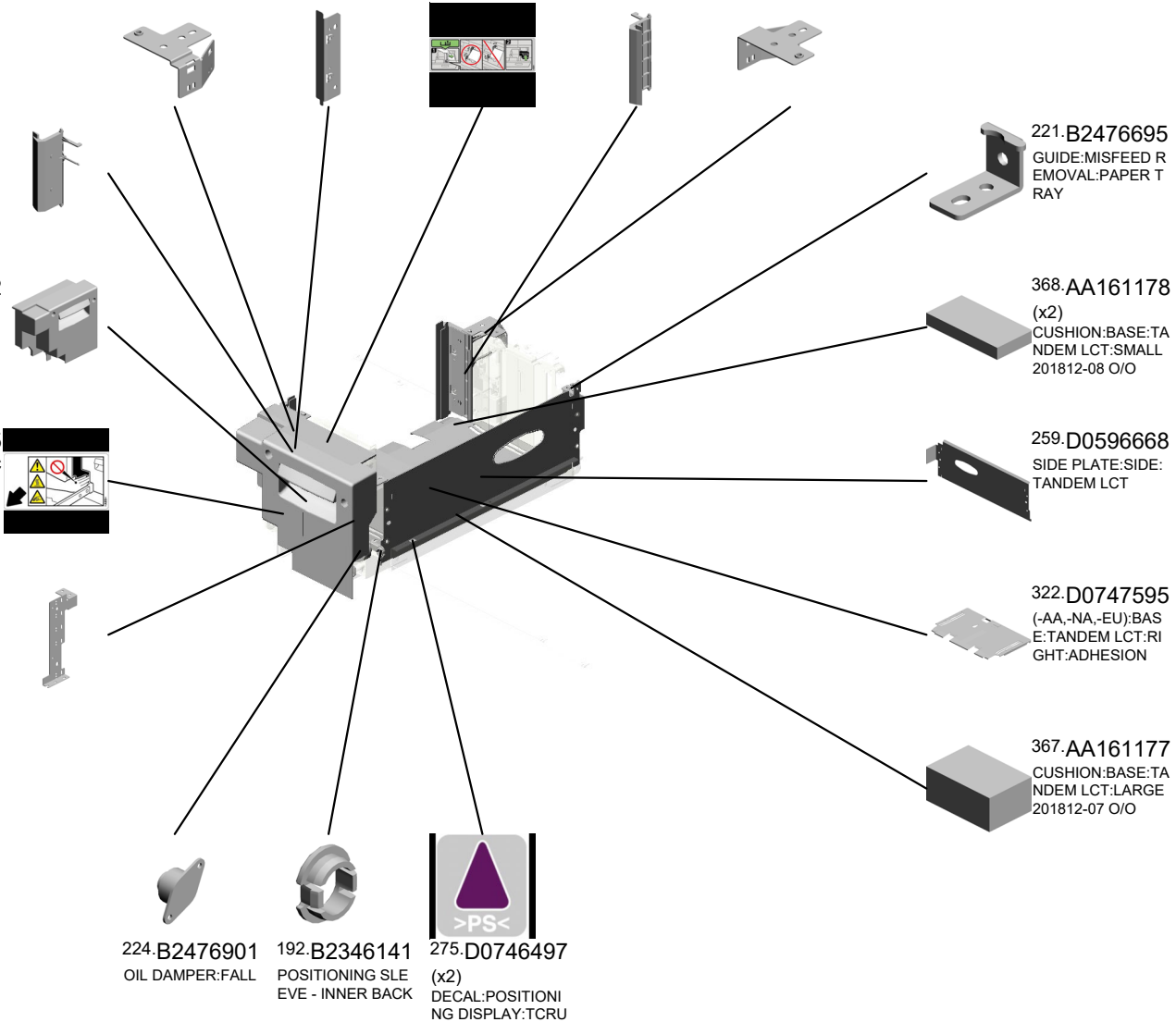

306.D0747540
 (-AA,-EU):TANDEM
 LCT:RIGHT:ASS'Y

U001	U002	U003	U004	U005	U006	U007	U008	U009	U010	U011	U012	U013	U014	U015	U016	U017	U018	U019	U020	U021
------	------	------	------	------	-------------	------	------	------	------	------	------	------	------	------	------	------	------	------	------	------

U006_S002_S001
DC SOLENOID:END FENCE:FRONT:ASS'Y

1-03130040N
(x2)
SCREW:M3X4

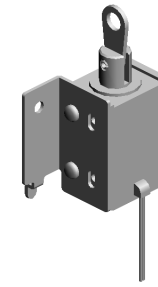

179-B1327547
DC SOLENOID:EN
D FENCE:FRONT:A
SS'Y

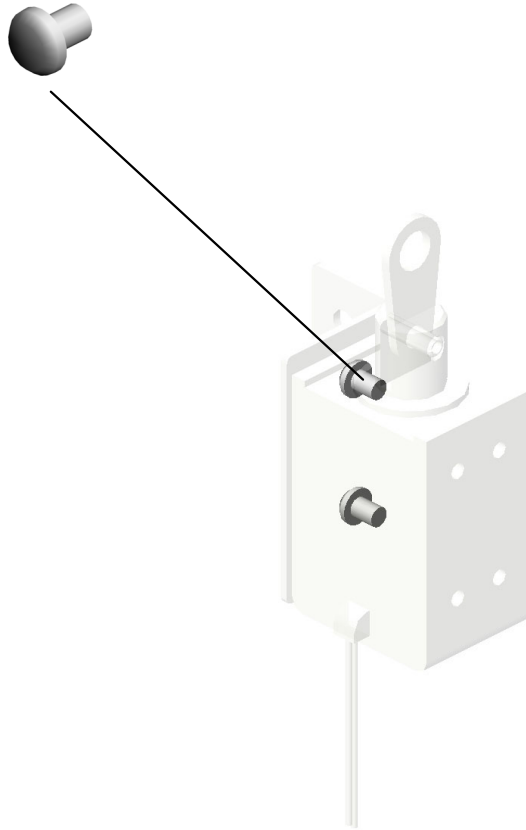

U001	U002	U003	U004	U005	U006	U007	U008	U009	U010	U011	U012	U013	U014	U015	U016	U017	U018	U019	U020	U021
------	------	------	------	------	-------------	------	------	------	------	------	------	------	------	------	------	------	------	------	------	------

U006_S002_S002
DC SOLENOID:END FENCE:REAR:ASS'Y

1-03130040N
(x2)
SCREW:M3X4

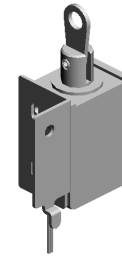

183-B1327571
DC SOLENOID:EN
D FENCE:REAR:AS
SY

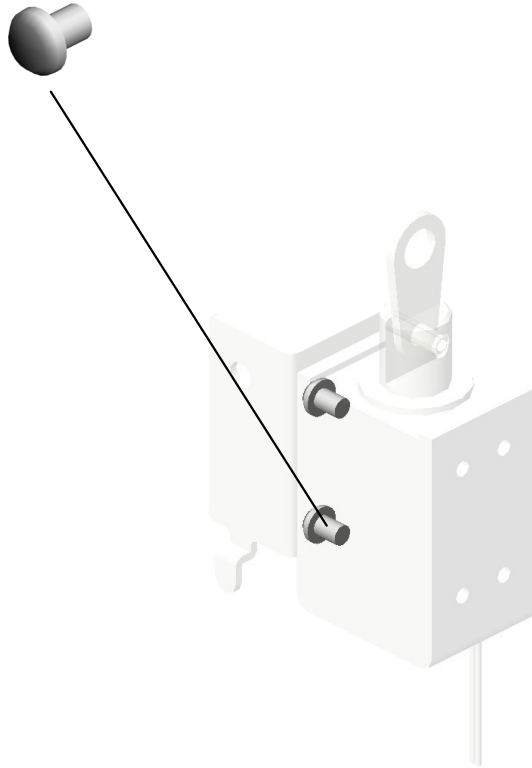

U001	U002	U003	U004	U005	U006	U007	U008	U009	U010	U011	U012	U013	U014	U015	U016	U017	U018	U019	U020	U021
------	------	------	------	------	-------------	------	------	------	------	------	------	------	------	------	------	------	------	------	------	------

U006_S002_S003
SIDE FENCE - RIGHT FRONT

260.D0596690
PLATE:PAPER:ASS
Y

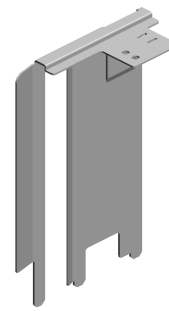
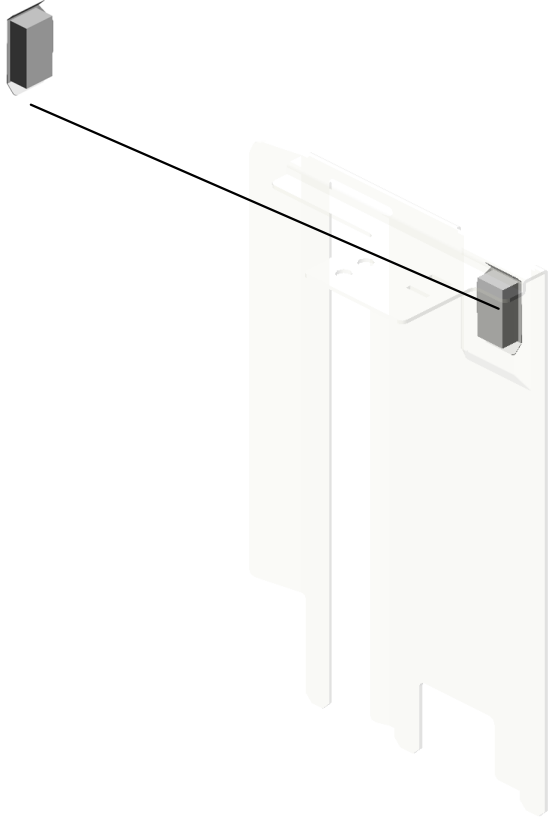

218.B2346686
SIDE FENCE - RIG
HT FRONT

U001	U002	U003	U004	U005	U006	U007	U008	U009	U010	U011	U012	U013	U014	U015	U016	U017	U018	U019	U020	U021
------	------	------	------	------	-------------	------	------	------	------	------	------	------	------	------	------	------	------	------	------	------

U006_S002_S004
SIDE FENCE:TANDEM LCT:RIGHT:ASS'Y

228.B4756855
SHIELD:TANDEM L
CT:REAR RIGHT

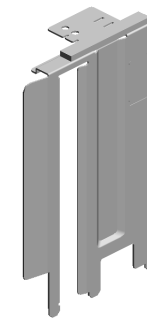

219.B2346691
SIDE FENCE:TAND
EM LCT:RIGHT:AS
SY

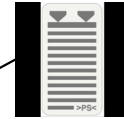
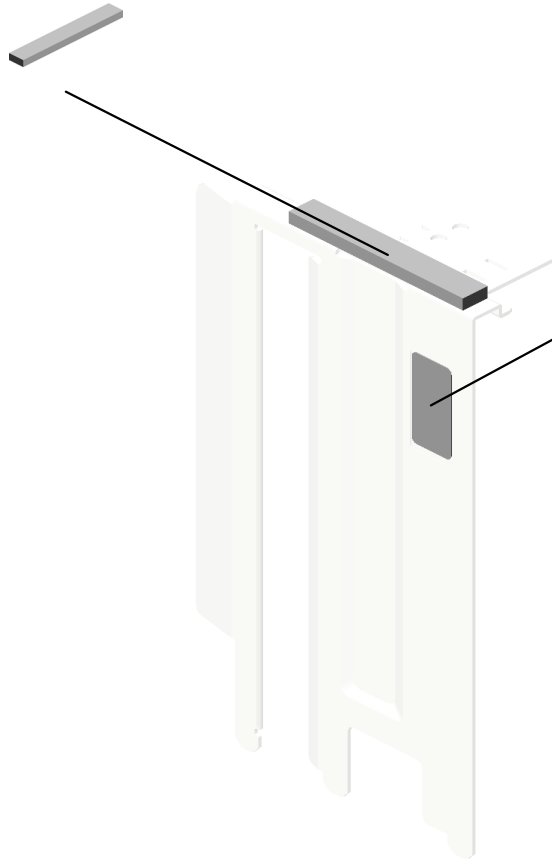

74.AA001509
DECAL:SIDE FENC
E:16X30

U001	U002	U003	U004	U005	U006	U007	U008	U009	U010	U011	U012	U013	U014	U015	U016	U017	U018	U019	U020	U021
------	------	------	------	------	-------------	------	------	------	------	------	------	------	------	------	------	------	------	------	------	------

U006_S003
(-NA):TANDEM LCT:RIGHT:ASS'Y

27.04544008Q (x15) TAPPING SCREW - M4X8
 67.A2486713 (x2) HOOK - TENSION SPRING
 21.04523006N (x4) BINDING SELF-TAPPING SCREW:3X6
 32.07200040E (x8) RETAINING RING - M4
 66.A2486695 (x4) GUIDE - PULLEY

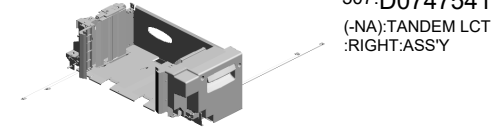

307.D0747541
(-NA):TANDEM LCT
:RIGHT:ASS'Y

15.04504008N
(x2)
TAPPING SCREW - M4X8

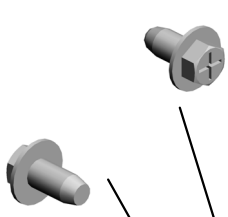

44.09514006N
(x4)
SCREW:POLISHED ROUND:M4X6



71.A2946655
FRONT ROLLER - SLIDE RAIL



52.11050534
(x7)
CLAMP



48.11050488
(x4)
HARNES CLAMP



72.A2946690
FEELER - PAPER HEIGHT SENSOR



64.A2486687
RIGHT DRIVE SHAFT



3.03130120N
PAN HEAD SCREW :M3X12



65.A2486694 (x3)
WIRE RING



57.50530223 (x3)
BUSHING - 8MM



27.04544008Q(x 1)
TAPPING SCREW - M4X8



19.04514008N
(x16)
TAPPING SCREW: 4X8



43.09513006N
SCREW - M3X6



2.03130080N
(x2)
PAN HEAD SCREW :M3X8



33.07200060E
(x2)
RETAINING RING - M6



29.06330200G
(x2)
PIN - M3X20



U006_S003
 (-NA):TANDEM LCT:RIGHT:ASS'Y

- 79.AA060757 (x2) TENSION SPRING - LONG
- 122.AB032058 (x2) WIRE PULLEY - M10
- 123.AB032719 (x2) PULLEY - M10
- 180.B1327550 (x2) COVER:PULLEY:DRIVE WERE
- 169.B0706684 LEVER:RELEASE:RIGHT EAR

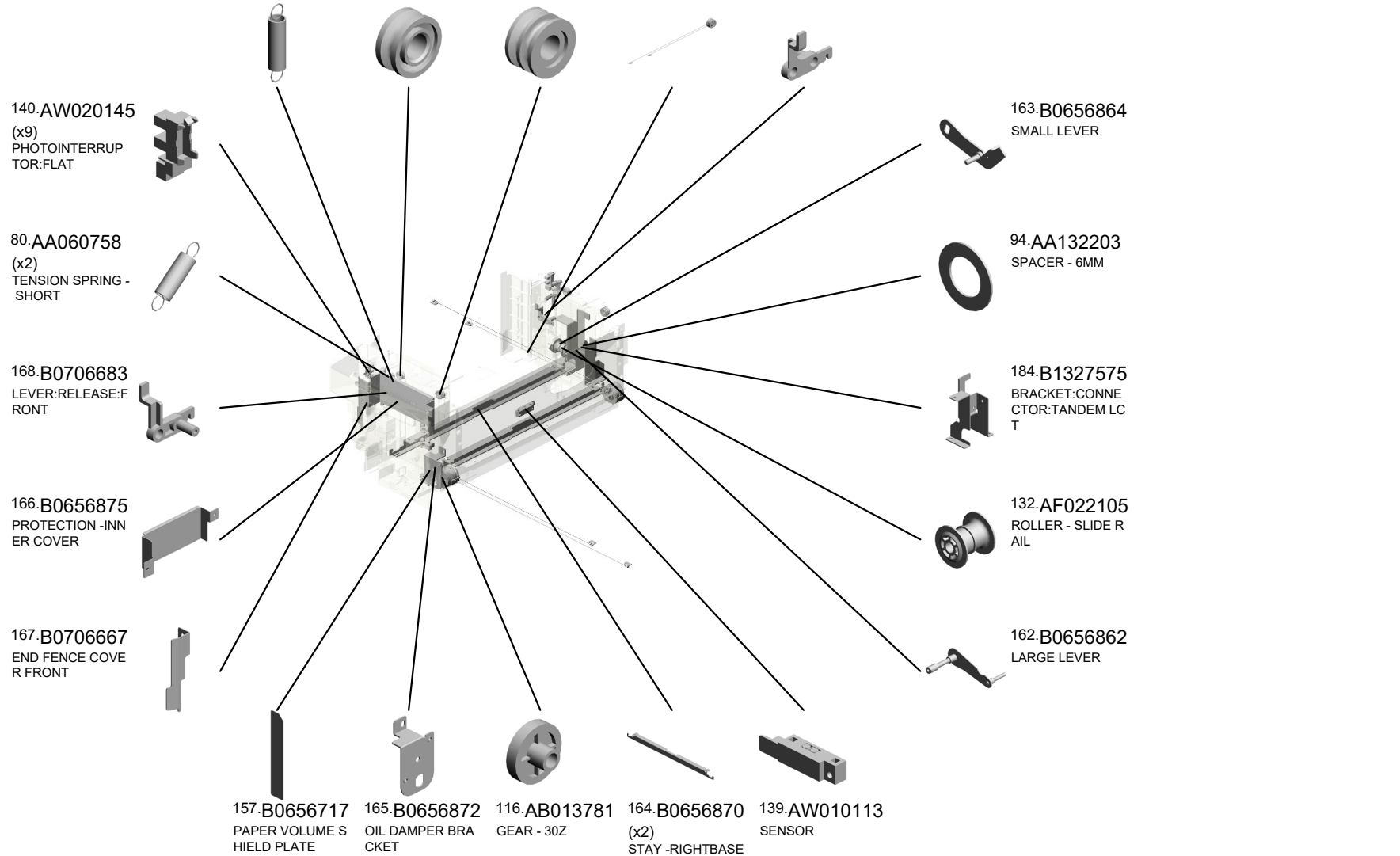
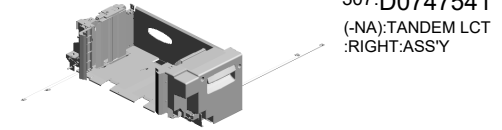

U001	U002	U003	U004	U005	U006	U007	U008	U009	U010	U011	U012	U013	U014	U015	U016	U017	U018	U019	U020	U021
------	------	------	------	------	------	------	------	------	------	------	------	------	------	------	------	------	------	------	------	------

U006_S003
 (-NA):TANDEM LCT:RIGHT:ASS'Y

238.D0146626 BRACKET:ON OFF
 DETECTOR:FRONT

288.D0747388 DECAL:PAPER SE
 T DIRECTION:TAN
 DEM LCT:RIGHT

216.B2346625 END FENCE - REA
 R

239.D0146627 BRACKET:ON OFF
 DETECTOR:REAR

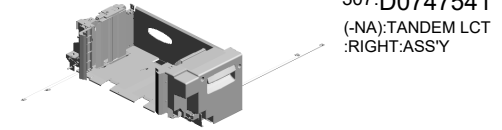

215.B2346612
 END FENCE - FRO
 NT

261.D0596712
 INNER COVER:TA
 NDEM LCT

287.D0747385
 DECAL:CAUTION C
 HART:TANDEM LC
 T

214.B2346606
 SENSOR BRACKE
 T

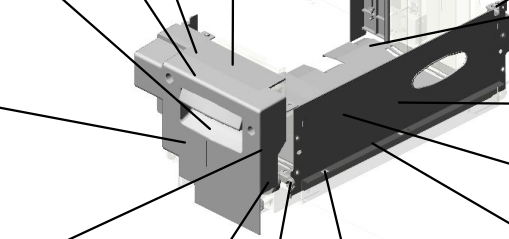
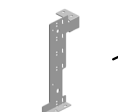
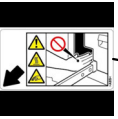
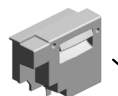

221.B2476695
 GUIDE:MISFEED R
 EMOVAL:PAPER T
 RAY

368.AA161178
 (x2)
 CUSHION:BASE:TA
 NDEM LCT:SMALL
 201812-08 O/O

259.D0596668
 SIDE PLATE:SIDE:
 TANDEM LCT

322.D0747595
 (-AA,-NA,-EU):BAS
 E:TANDEM LCT:RI
 GHT:ADHESION

367.AA161177
 CUSHION:BASE:TA
 NDEM LCT:LARGE
 201812-07 O/O

224.B2476901
 OIL DAMPER:FALL

192.B2346141
 POSITIONING SLE
 EVE - INNER BACK

275.D0746497
 (x2)
 DECAL:POSITIONI
 NG DISPLAY:TCRU



U001	U002	U003	U004	U005	U006	U007	U008	U009	U010	U011	U012	U013	U014	U015	U016	U017	U018	U019	U020	U021
------	------	------	------	------	------	------	------	------	------	------	------	------	------	------	------	------	------	------	------	------

U006_S003_S001
DC SOLENOID:END FENCE:FRONT:ASS'Y

1-03130040N
(x2)
SCREW:M3X4

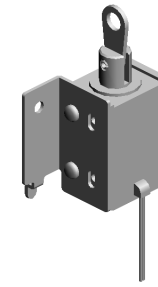

179-B1327547
DC SOLENOID:EN
D FENCE:FRONT:A
SS'Y

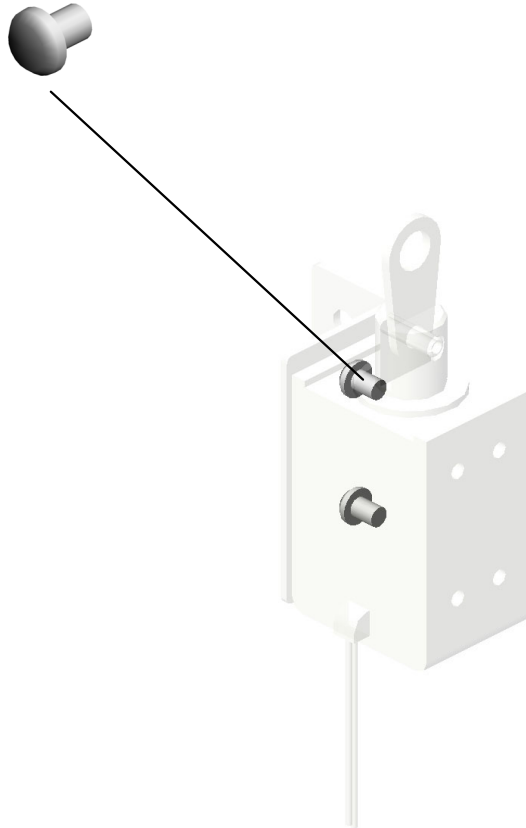

U001	U002	U003	U004	U005	U006	U007	U008	U009	U010	U011	U012	U013	U014	U015	U016	U017	U018	U019	U020	U021
------	------	------	------	------	-------------	------	------	------	------	------	------	------	------	------	------	------	------	------	------	------

U006_S003_S002
DC SOLENOID:END FENCE:REAR:ASS'Y

1-03130040N
(x2)
SCREW:M3X4



183-B1327571
DC SOLENOID:EN
D FENCE:REAR:AS
SY

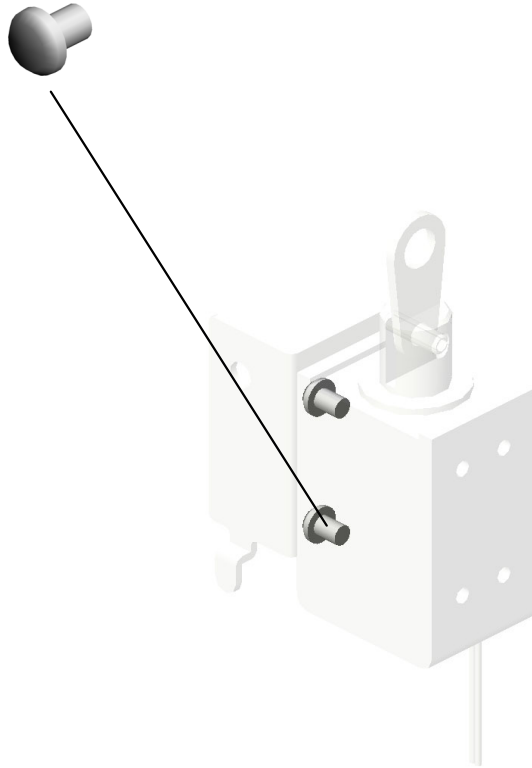

U001	U002	U003	U004	U005	U006	U007	U008	U009	U010	U011	U012	U013	U014	U015	U016	U017	U018	U019	U020	U021
------	------	------	------	------	-------------	------	------	------	------	------	------	------	------	------	------	------	------	------	------	------

U006_S003_S003
SIDE FENCE - RIGHT FRONT

260.D0596690
PLATE:PAPER:ASS
Y

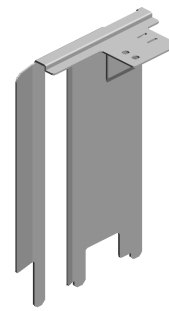
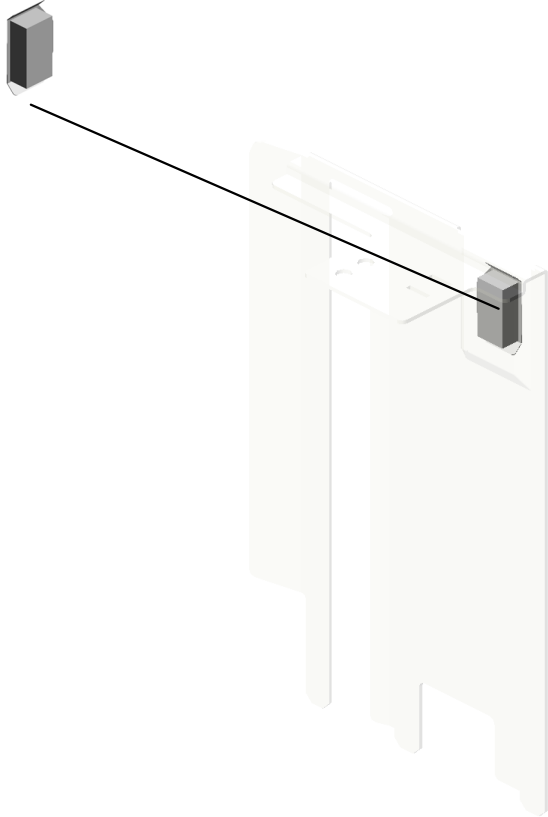

218.B2346686
SIDE FENCE - RIG
HT FRONT

U001	U002	U003	U004	U005	U006	U007	U008	U009	U010	U011	U012	U013	U014	U015	U016	U017	U018	U019	U020	U021
------	------	------	------	------	-------------	------	------	------	------	------	------	------	------	------	------	------	------	------	------	------

U006_S003_S004
SIDE FENCE:TANDEM LCT:RIGHT:ASS'Y

228.B4756855
SHIELD:TANDEM L
CT:REAR RIGHT

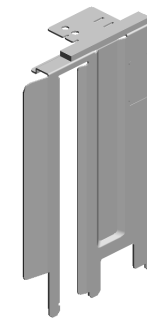

219.B2346691
SIDE FENCE:TAND
EM LCT:RIGHT:AS
SY

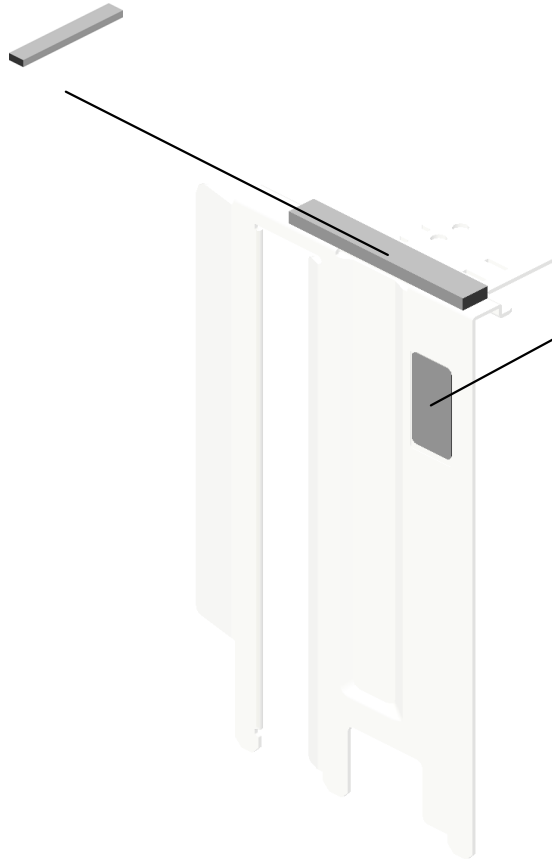

U001	U002	U003	U004	U005	U006	U007	U008	U009	U010	U011	U012	U013	U014	U015	U016	U017	U018	U019	U020	U021
------	------	------	------	------	-------------	------	------	------	------	------	------	------	------	------	------	------	------	------	------	------

U006_S004
(-CHN):TANDEM LCT:RIGHT:ASS'Y

27.04544008Q (x15) TAPPING SCREW - M4X8
 67.A2486713 (x2) HOOK - TENSION SPRING
 21.04523006N (x4) BINDING SELF-TAPPING SCREW:3X6
 32.07200040E (x8) RETAINING RING - M4
 66.A2486695 (x4) GUIDE - PULLEY

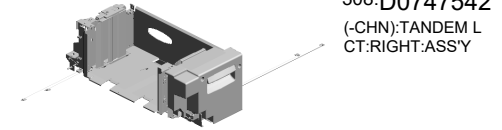

308.D0747542
(-CHN):TANDEM LCT:RIGHT:ASS'Y

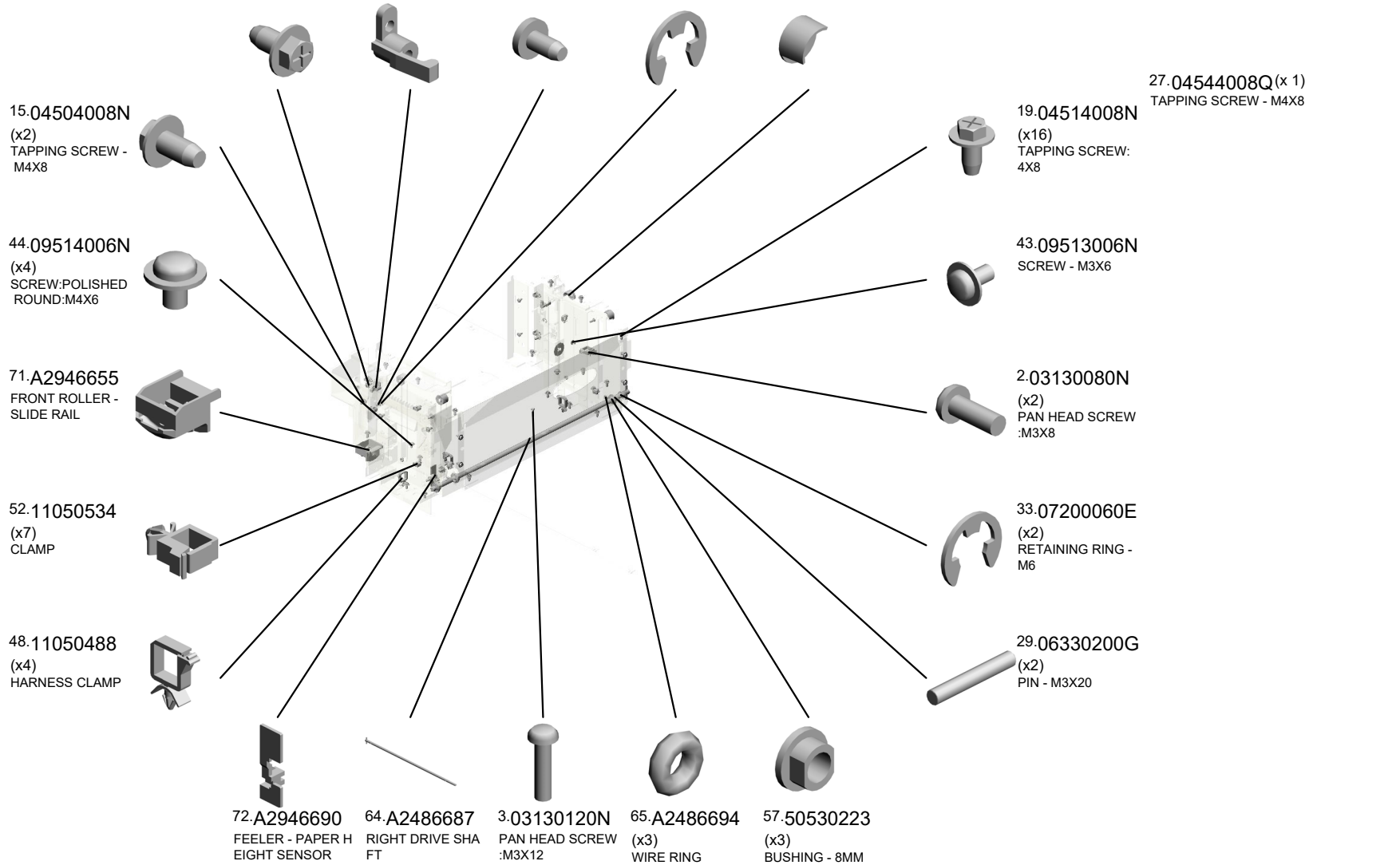

U001	U002	U003	U004	U005	U006	U007	U008	U009	U010	U011	U012	U013	U014	U015	U016	U017	U018	U019	U020	U021
------	------	------	------	------	------	------	------	------	------	------	------	------	------	------	------	------	------	------	------	------

U006_S004
(-CHN):TANDEM LCT:RIGHT:ASS'Y

79.AA060757 (x2) TENSION SPRING - LONG
 122.AB032058 (x2) WIRE PULLEY - M10
 123.AB032719 (x2) PULLEY - M10
 180.B1327550 (x2) COVER:PULLEY:DRIVE WERE
 169.B0706684 LEVER:RELEASE:RIGHT EAR

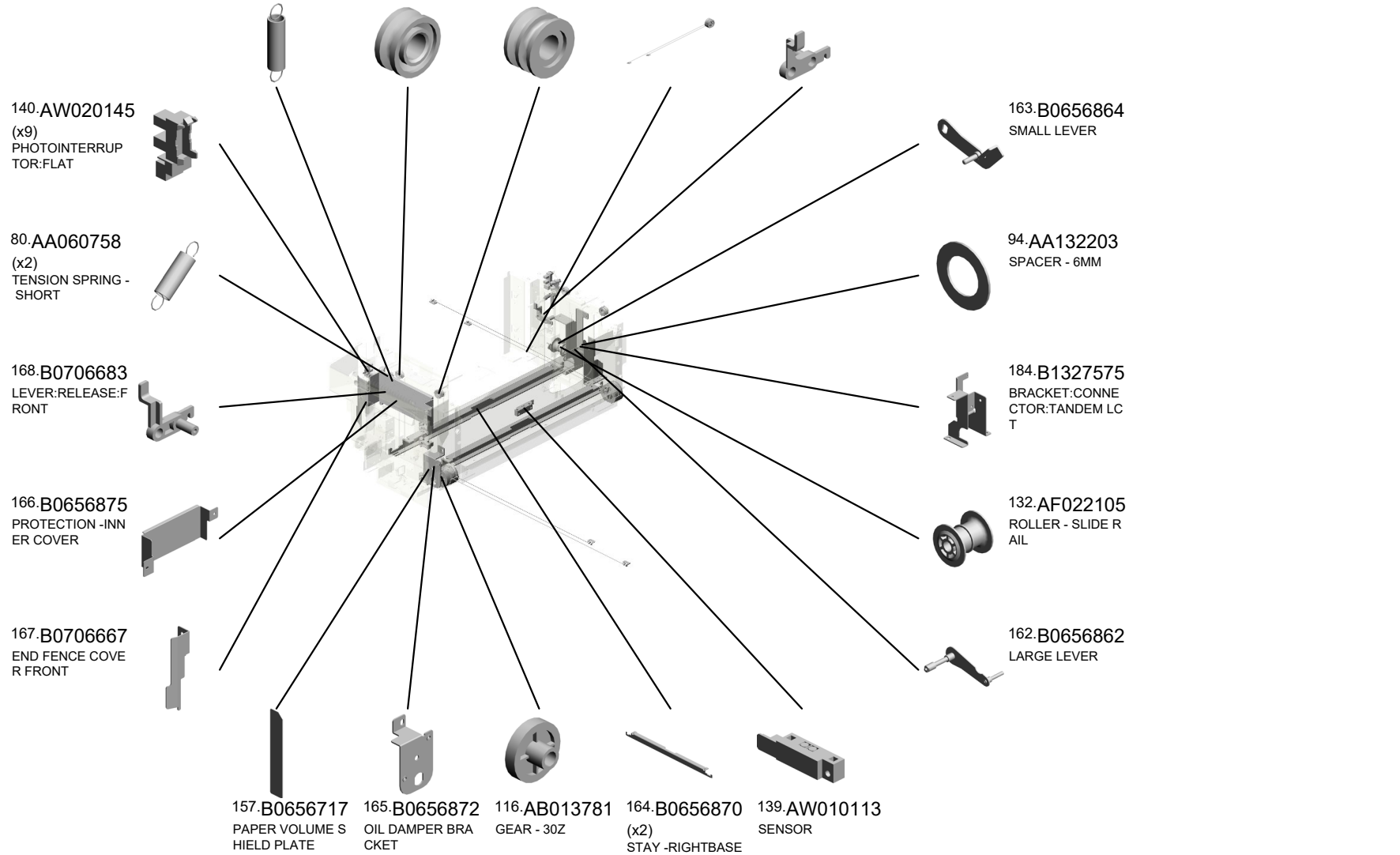
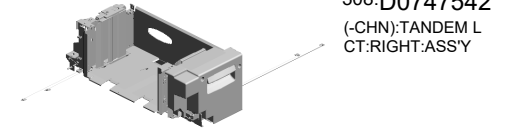

U006_S004
(-CHN):TANDEM LCT:RIGHT:ASS'Y

238.D0146626 BRACKET:ON OFF
DETECTOR:FRONT

217.B2346630 (x2)
(-AA,-EU,-CHN):GUI
DE PLATE - END F
ENCE

288.D0747388 DECAL:PAPER SE
T DIRECTION:TAN
DEM LCT:RIGHT

216.B2346625 END FENCE - REA
R

239.D0146627 BRACKET:ON OFF
DETECTOR:REAR

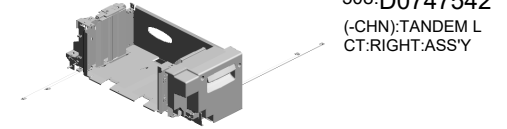

215.B2346612
END FENCE - FRO
NT



261.D0596712
INNER COVER:TA
NDEM LCT



287.D0747385
DECAL:CAUTION C
HART:TANDEM LC
T

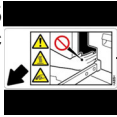

214.B2346606
SENSOR BRACKE
T



224.B2476901
OIL DAMPER:FALL



192.B2346141
POSITIONING SLE
EVE - INNER BACK



275.D0746497
(x2)
DECAL:POSITIONI
NG DISPLAY:TCRU



221.B2476695
GUIDE:MISFEED R
EMOVAL:PAPER T
RAY

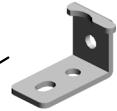

368.AA161178
(x2)
CUSHION:BASE:TA
NDEM LCT:SMALL
201812-08 O/O

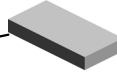

259.D0596668
SIDE PLATE:SIDE:
TANDEM LCT



268.D0606680
(-CHN):BASE:TAND
EM LCT:RIGHT:AD
HESION



367.AA161177
CUSHION:BASE:TA
NDEM LCT:LARGE
201812-07 O/O



U006_S004_S001
DC SOLENOID:END FENCE:FRONT:ASS'Y

1-03130040N
(x2)
SCREW:M3X4

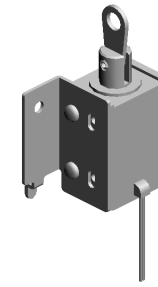

179-B1327547
DC SOLENOID:EN
D FENCE:FRONT:A
SS'Y

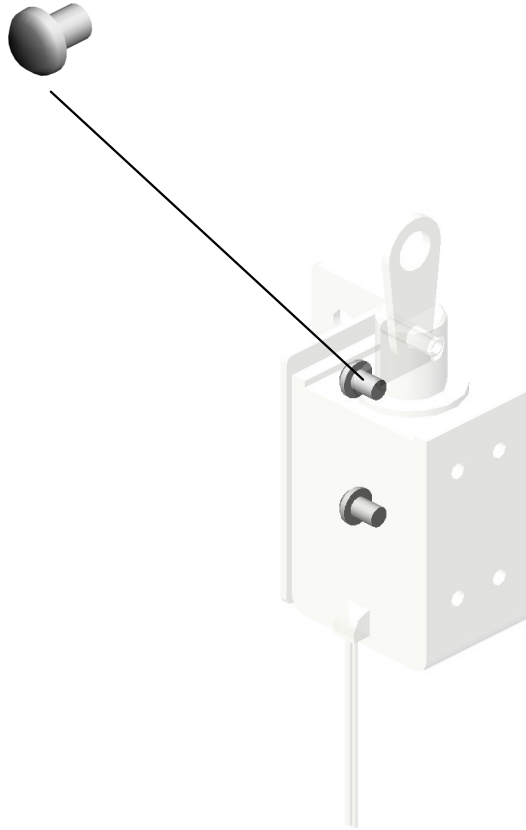

U001	U002	U003	U004	U005	U006	U007	U008	U009	U010	U011	U012	U013	U014	U015	U016	U017	U018	U019	U020	U021
------	------	------	------	------	-------------	------	------	------	------	------	------	------	------	------	------	------	------	------	------	------

U006_S004_S002
DC SOLENOID:END FENCE:REAR:ASS'Y

1-03130040N
(x2)
SCREW:M3X4

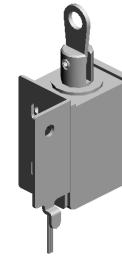

183-B1327571
DC SOLENOID:EN
D FENCE:REAR:AS
SY

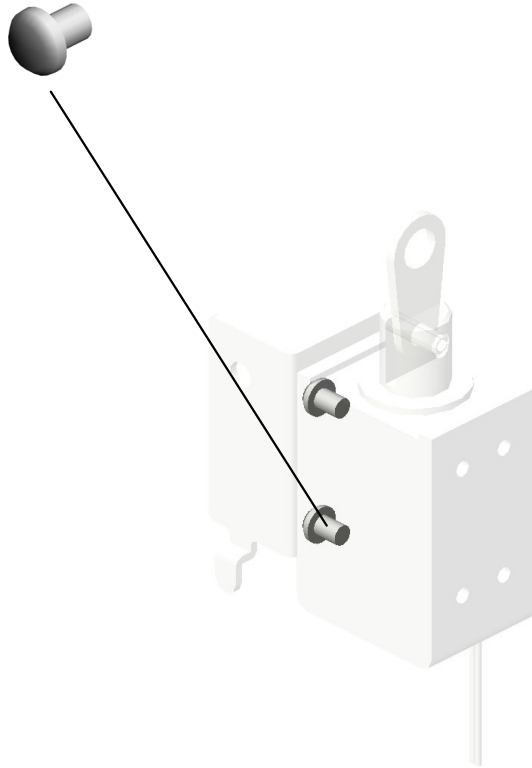

U001	U002	U003	U004	U005	U006	U007	U008	U009	U010	U011	U012	U013	U014	U015	U016	U017	U018	U019	U020	U021
------	------	------	------	------	-------------	------	------	------	------	------	------	------	------	------	------	------	------	------	------	------

U006_S004_S003
SIDE FENCE - RIGHT FRONT

260.D0596690
PLATE:PAPER:ASS
Y

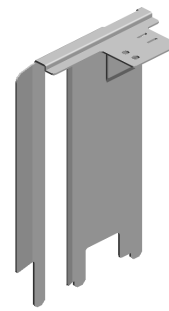
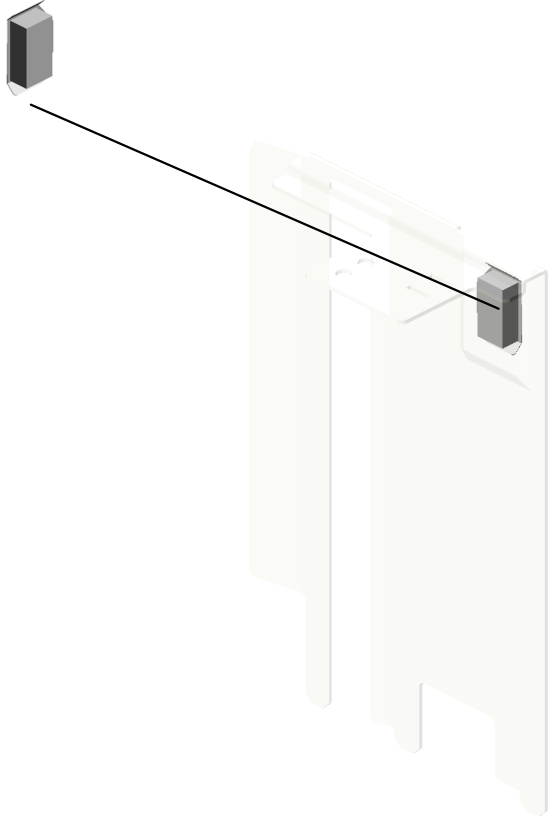

218.B2346686
SIDE FENCE - RIG
HT FRONT

U001	U002	U003	U004	U005	U006	U007	U008	U009	U010	U011	U012	U013	U014	U015	U016	U017	U018	U019	U020	U021
------	------	------	------	------	------	------	------	------	------	------	------	------	------	------	------	------	------	------	------	------

U006_S004_S004
SIDE FENCE:TANDEM LCT:RIGHT:ASS'Y

228.B4756855
SHIELD:TANDEM L
CT:REAR RIGHT

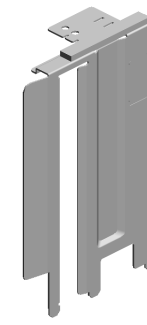

219.B2346691
SIDE FENCE:TAND
EM LCT:RIGHT:AS
SY

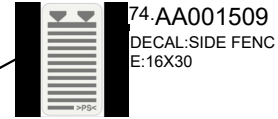
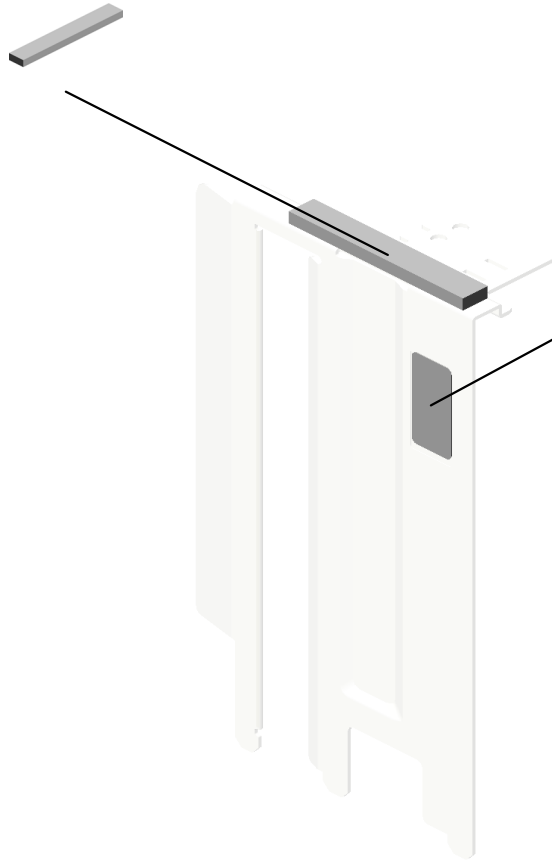

U001	U002	U003	U004	U005	U006	U007	U008	U009	U010	U011	U012	U013	U014	U015	U016	U017	U018	U019	U020	U021
------	------	------	------	------	-------------	------	------	------	------	------	------	------	------	------	------	------	------	------	------	------

U006_S005
 (-AA,-EU):TANDEM LCT:LEFT:ASS'Y

- 46.11050328 (x4) HARNESS CLAMP - ES-0505
- 16.04504010N (x2) TAPPING SCREW: M4X10
- 50.11050516 (x6) CLAMP
- 18.04514006N (x25) TAPPING SCREW - 4X6
- 140.AW020145 (x2) PHOTOINTERRUP TOR:FLAT

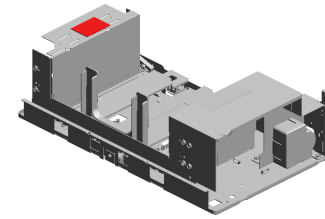

374-D2707555
 [A]
 (-AA,-EU):TANDEM
 LCT:LEFT:ASS'Y
 202108-02 O/O

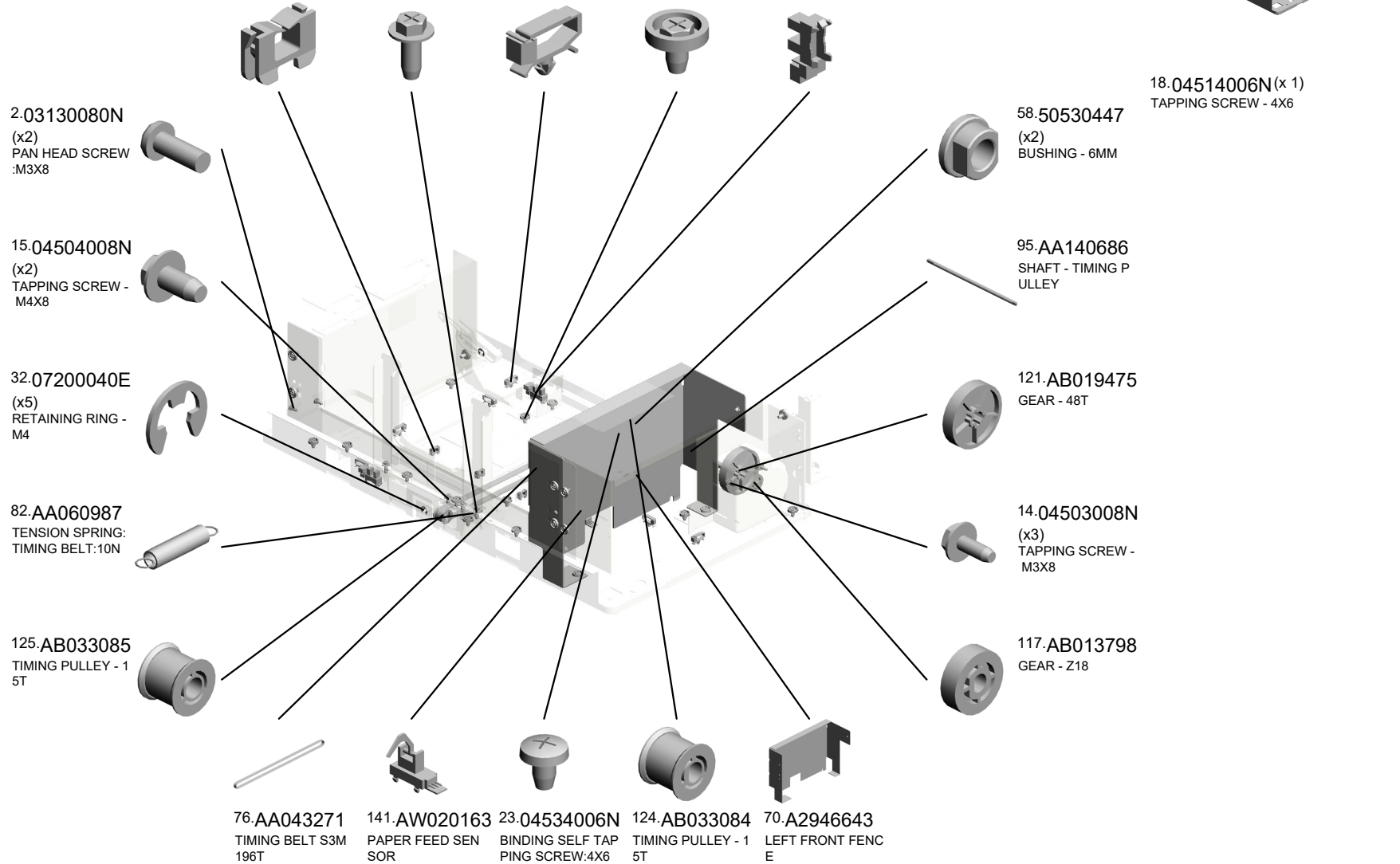

U006_S005
 (-AA,-EU):TANDEM LCT:LEFT:ASS'Y

- 178.B1327541 TRAY BOTTOM PLATE:LEFT REAR
- 254.D0596620 LEVER:COUPLING:LEFT
- 256.D0596659 SUPPORTING PLATE:SIDE FENCE:LEFT
- 323.D0747596 (-AA,-NA,-EU):TRAY BOTTOM PLATE:LEFT MIDDLE:ASS'Y
- 161.B0656831 SENSOR BRACKET

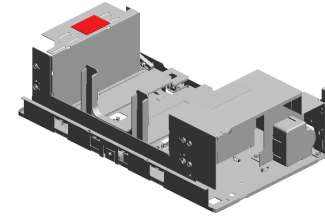

374.D2707555
 [A]
 (-AA,-EU):TANDEM LCT:LEFT:ASS'Y
 202108-02 O/O

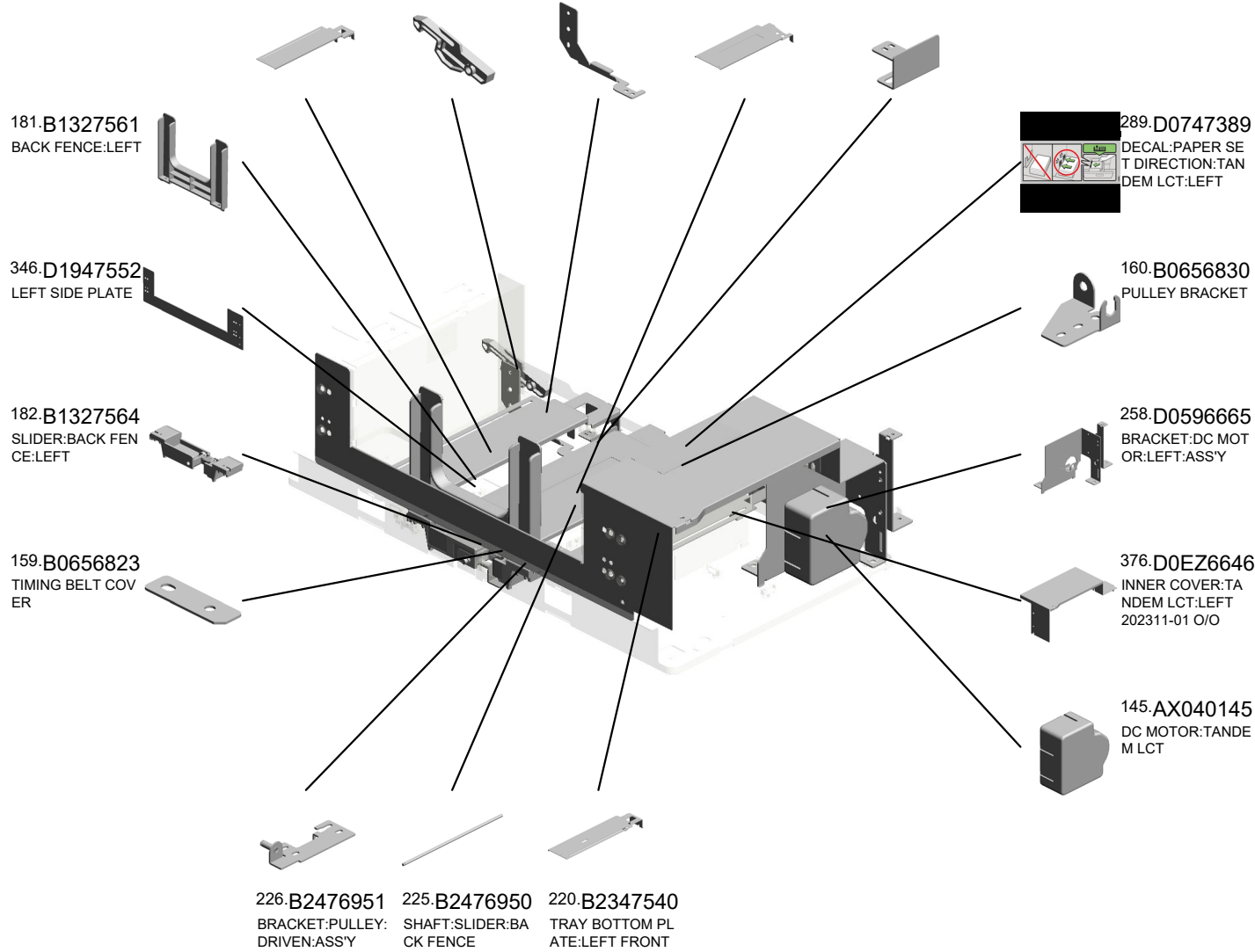

D1947545
 [A]
 (-AA,-EU):TANDEM LCT:LEFT:ASS'Y
 202108-02 O/O

U006_S005_S001
SIDE FENCE:TANDEM LCT:LEFT REAR:ASS'Y

361.AA000313
DECAL:CAUTION:INSERT:PAPER FEED SUB-UNIT
201504-01

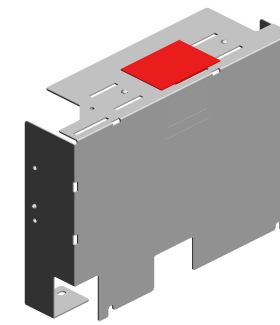
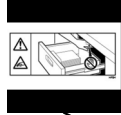

373.D0A57144
[A]
SIDE FENCE:TANDEM LCT:LEFT REAR:ASS'Y
201911-03 X/O

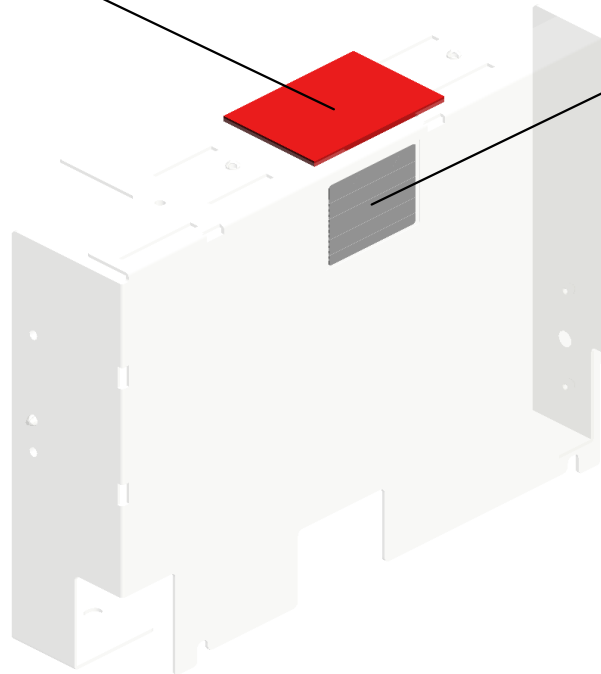

73.AA001508
DECAL:SIDE FENCE:40X30

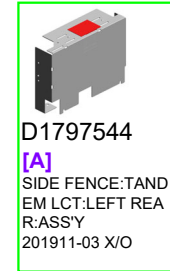

D1797544
[A]
SIDE FENCE:TANDEM LCT:LEFT REAR:ASS'Y
201911-03 X/O

U001	U002	U003	U004	U005	U006	U007	U008	U009	U010	U011	U012	U013	U014	U015	U016	U017	U018	U019	U020	U021
------	------	------	------	------	-------------	------	------	------	------	------	------	------	------	------	------	------	------	------	------	------

U006_S006
 (-AA,-EU):TANDEM LCT:LEFT:ASS'Y

- 46.11050328 (x4) HARNESS CLAMP - ES-0505
- 16.04504010N (x2) TAPPING SCREW: M4X10
- 50.11050516 (x6) CLAMP
- 18.04514006N (x25) TAPPING SCREW - 4X6
- 140.AW020145 (x2) PHOTOINTERRUP TOR:FLAT

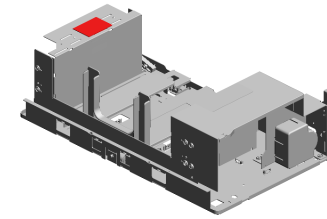

374-D2707555
 [A]
 (-AA,-EU):TANDEM LCT:LEFT:ASS'Y
 202108-02 O/O

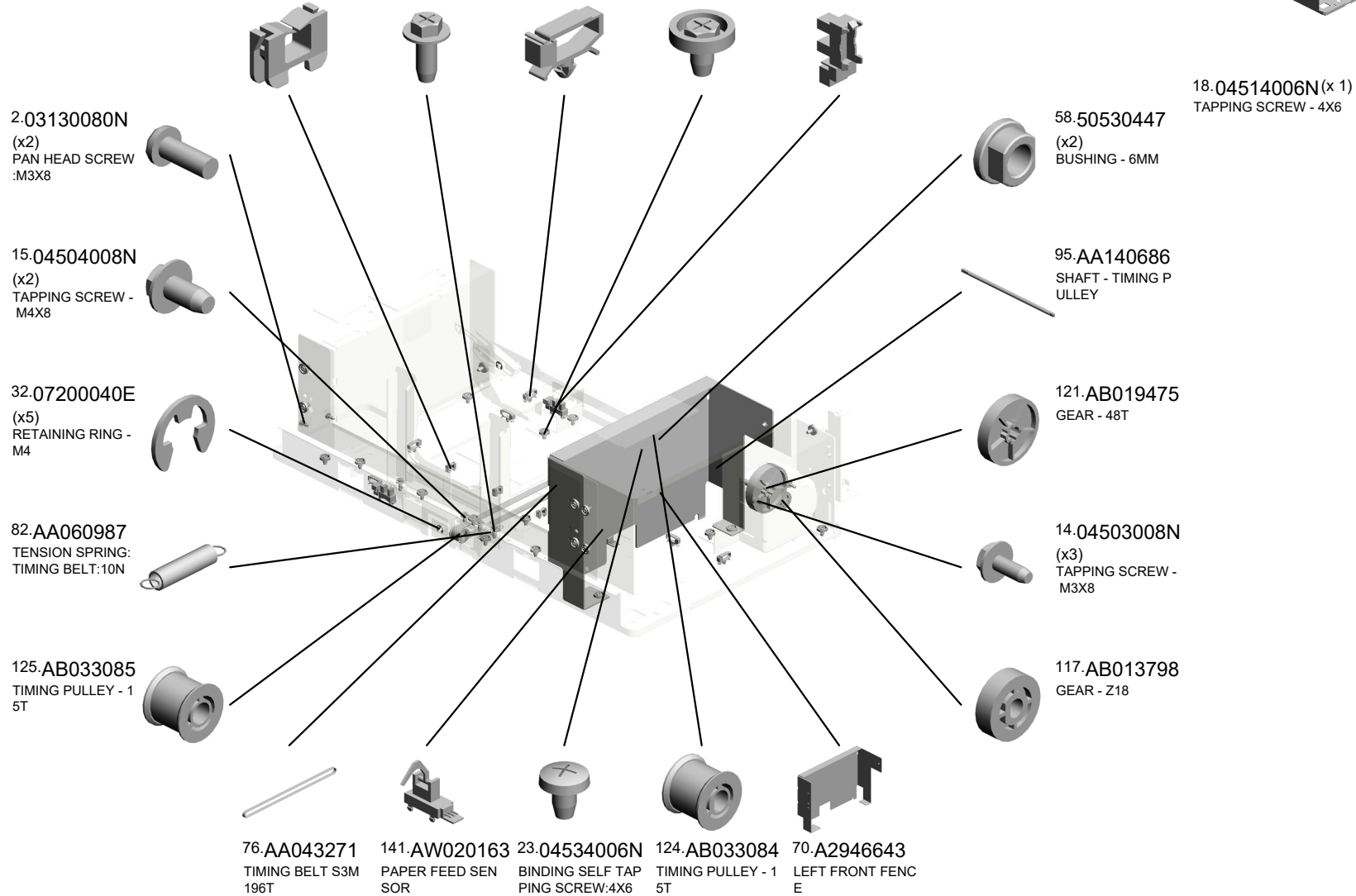

U006_S006
 (-AA,-EU):TANDEM LCT:LEFT:ASS'Y

- 178.B1327541 TRAY BOTTOM PLATE:LEFT REAR
- 254.D0596620 LEVER:COUPLING:LEFT
- 256.D0596659 SUPPORTING PLATE:SIDE FENCE:LEFT
- 323.D0747596 (-AA,-NA,-EU):TRAY BOTTOM PLATE:LEFT MIDDLE:ASS'Y
- 161.B0656831 SENSOR BRACKET

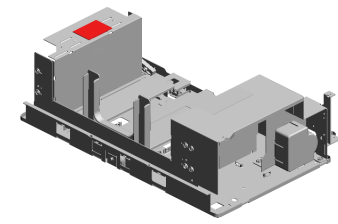

374.D2707555
 [A]
 (-AA,-EU):TANDEM LCT:LEFT:ASS'Y
 202108-02 O/O

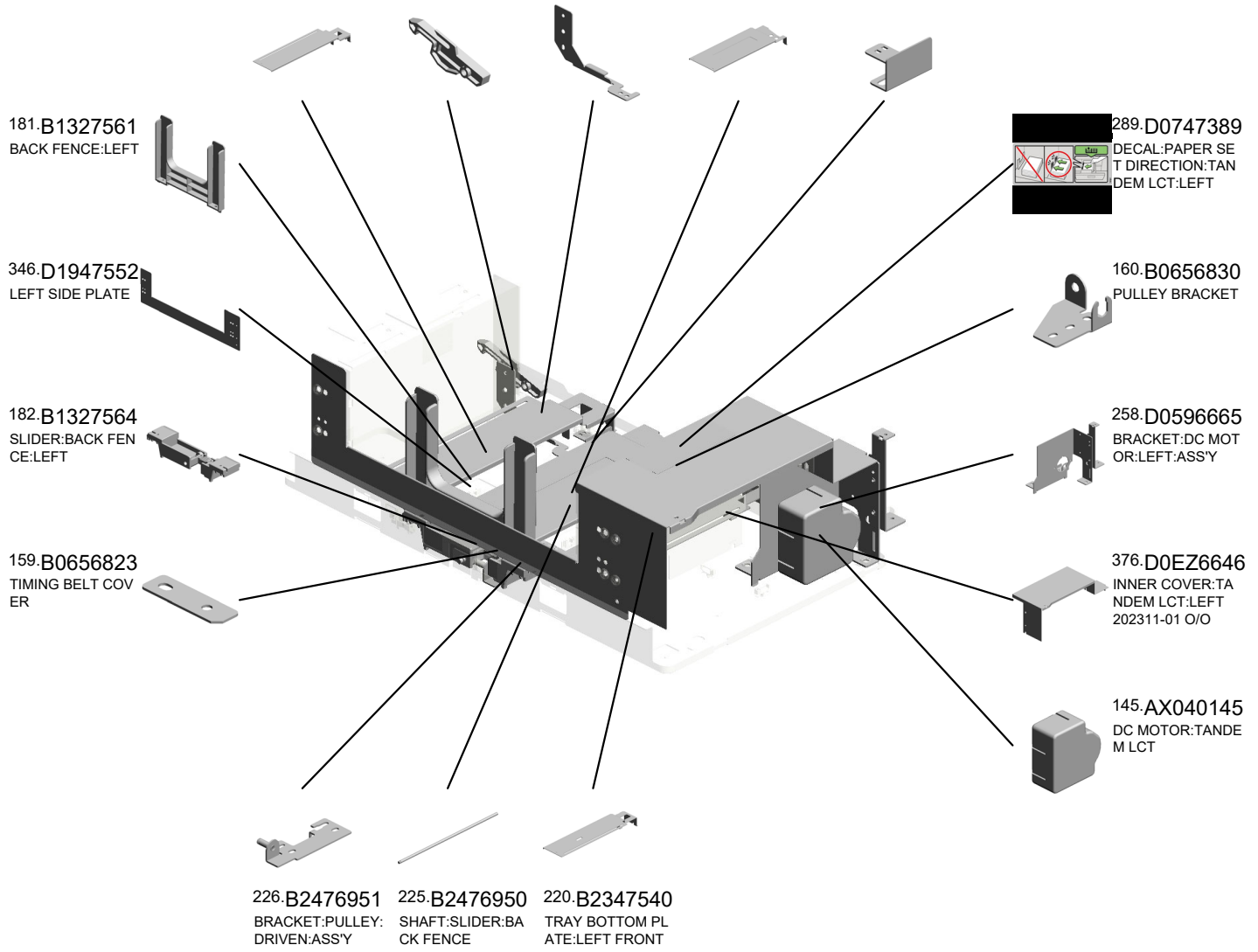

U001	U002	U003	U004	U005	U006	U007	U008	U009	U010	U011	U012	U013	U014	U015	U016	U017	U018	U019	U020	U021
------	------	------	------	------	------	------	------	------	------	------	------	------	------	------	------	------	------	------	------	------

U006_S006_S001
SIDE FENCE:TANDEM LCT:LEFT REAR:ASS'Y

361.AA000313
DECAL:CAUTION:INSERT:PAPER FEED SUB-UNIT
201504-01

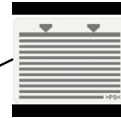
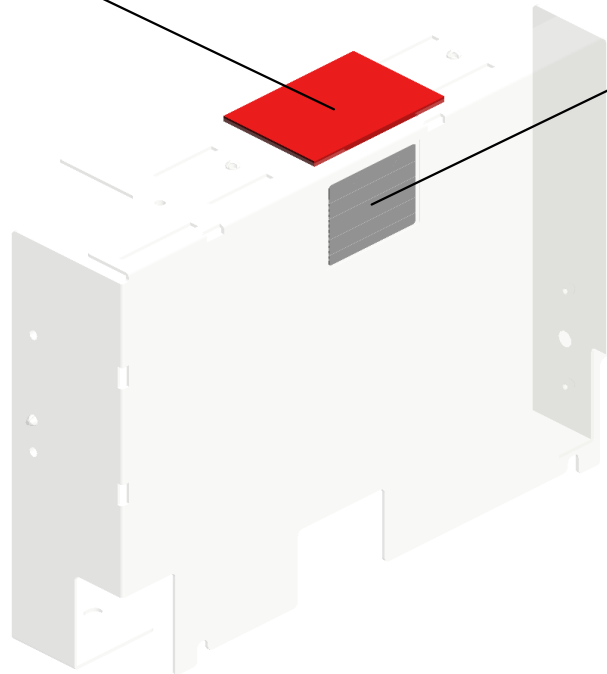
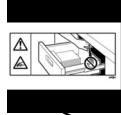

73.AA001508
DECAL:SIDE FENCE:40X30

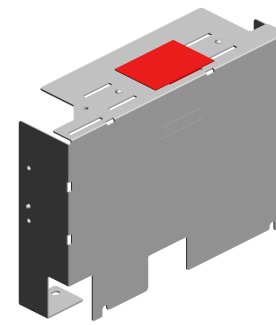

373.D0A57144
[A]
SIDE FENCE:TANDEM LCT:LEFT REAR:ASS'Y
201911-03 X/O

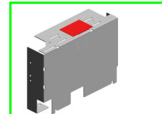

D1797544
[A]
SIDE FENCE:TANDEM LCT:LEFT REAR:ASS'Y
201911-03 X/O

U001	U002	U003	U004	U005	U006	U007	U008	U009	U010	U011	U012	U013	U014	U015	U016	U017	U018	U019	U020	U021
------	------	------	------	------	-------------	------	------	------	------	------	------	------	------	------	------	------	------	------	------	------

U006_S007
 (-NA):TANDEM LCT:LEFT:ASS'Y

- 46.11050328 (x4) HARNESS CLAMP - ES-0505
- 16.04504010N (x2) TAPPING SCREW: M4X10
- 50.11050516 (x6) CLAMP
- 18.04514006N (x25) TAPPING SCREW - 4X6
- 140.AW020145 (x2) PHOTOINTERRUP TOR:FLAT

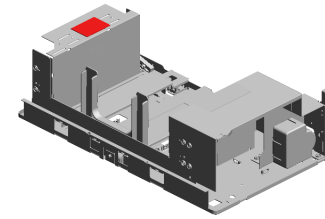

366.D1797549
 [A]
 (-NA):TANDEM LCT
 :LEFT:ASS'Y
 201808-02 O/O

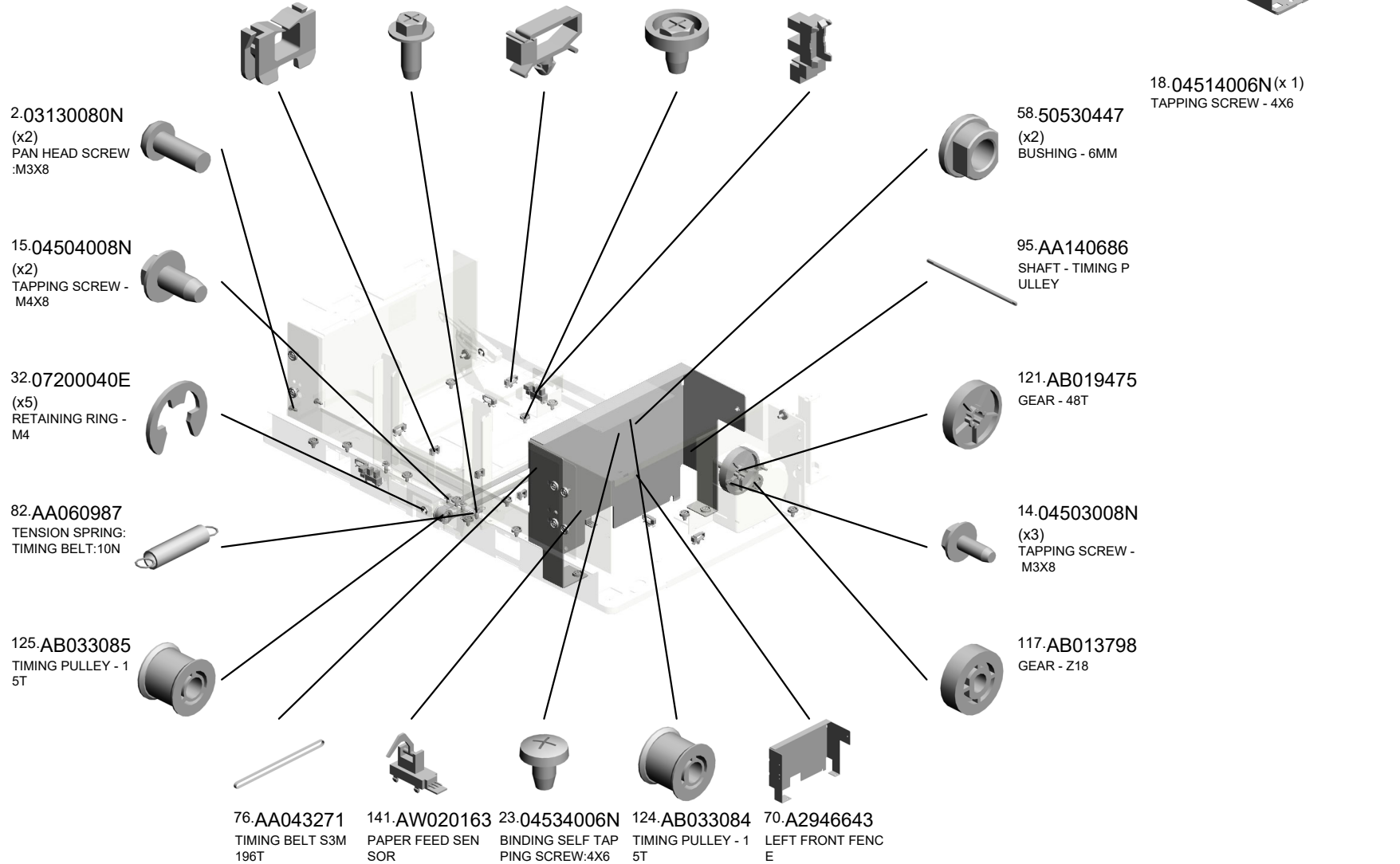

U006_S007
(-NA):TANDEM LCT:LEFT:ASS'Y

178.B1327541 TRAY BOTTOM PLATE:LEFT REAR
 254.D0596620 LEVER:COUPLING:LEFT
 256.D0596659 SUPPORTING PLATE:SIDE FENCE:LEFT
 323.D0747596 (-AA,-NA,-EU):TRAY BOTTOM PLATE:LEFT MIDDLE:ASS'Y
 161.B0656831 SENSOR BRACKET

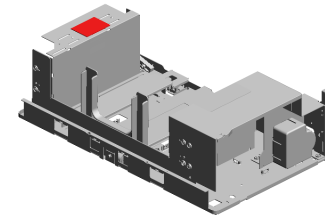

366.D1797549
 [A]
 (-NA):TANDEM LCT:LEFT:ASS'Y
 201808-02 O/O

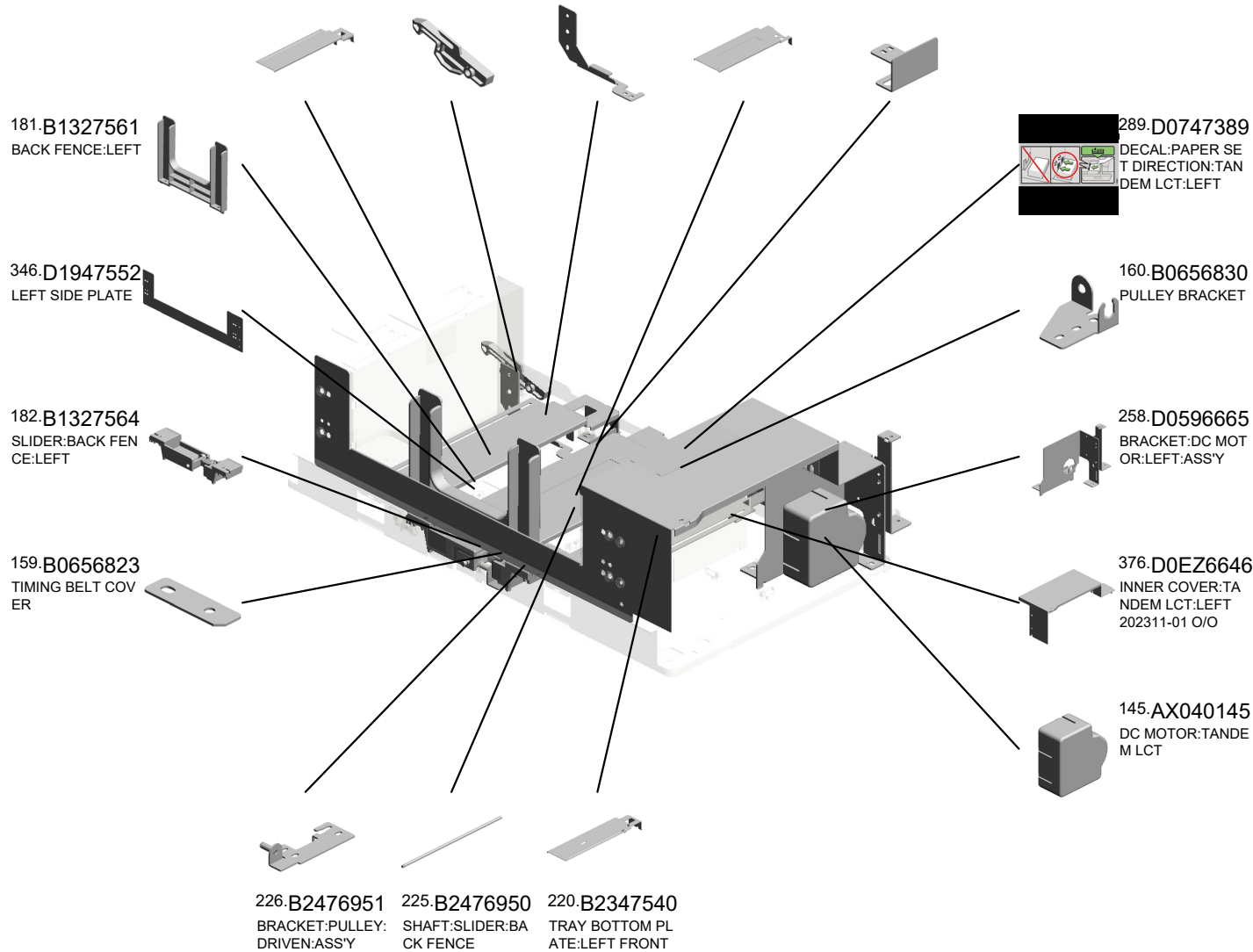

U006_S007_S001
SIDE FENCE:TANDEM LCT:LEFT REAR:ASS'Y

361.AA000313
DECAL:CAUTION:INSERT:PAPER FEED SUB-UNIT
201504-01

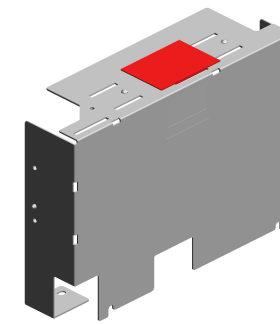
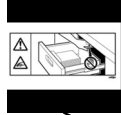

373.D0A57144
[A]
SIDE FENCE:TANDEM LCT:LEFT REAR:ASS'Y
201911-03 X/O

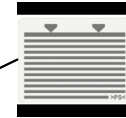
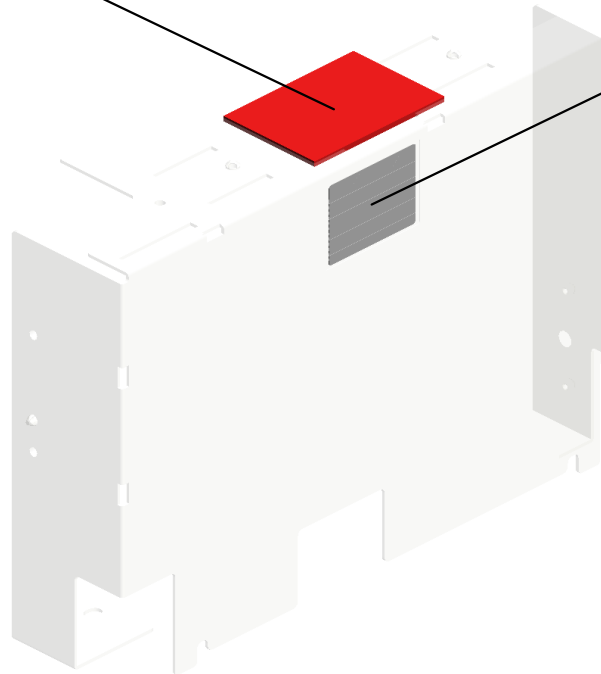

73.AA001508
DECAL:SIDE FENCE:40X30

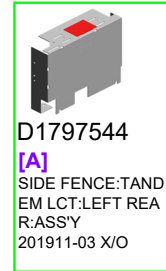

D1797544
[A]
SIDE FENCE:TANDEM LCT:LEFT REAR:ASS'Y
201911-03 X/O

U001	U002	U003	U004	U005	U006	U007	U008	U009	U010	U011	U012	U013	U014	U015	U016	U017	U018	U019	U020	U021
------	------	------	------	------	-------------	------	------	------	------	------	------	------	------	------	------	------	------	------	------	------

U006_S008
(-CHN):TANDEM LCT:LEFT:ASS'Y

- 32.07200040E (x5) RETAINING RING - M4
- 15.04504008N (x2) TAPPING SCREW - M4X8
- 82.AA060987 TENSION SPRING: TIMING BELT:10N
- 76.AA043271 TIMING BELT S3M 196T
- 2.03130080N (x2) PAN HEAD SCREW :M3X8

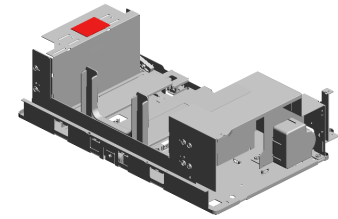

344.D1947547
(-CHN):TANDEM L
CT:LEFT:ASS'Y

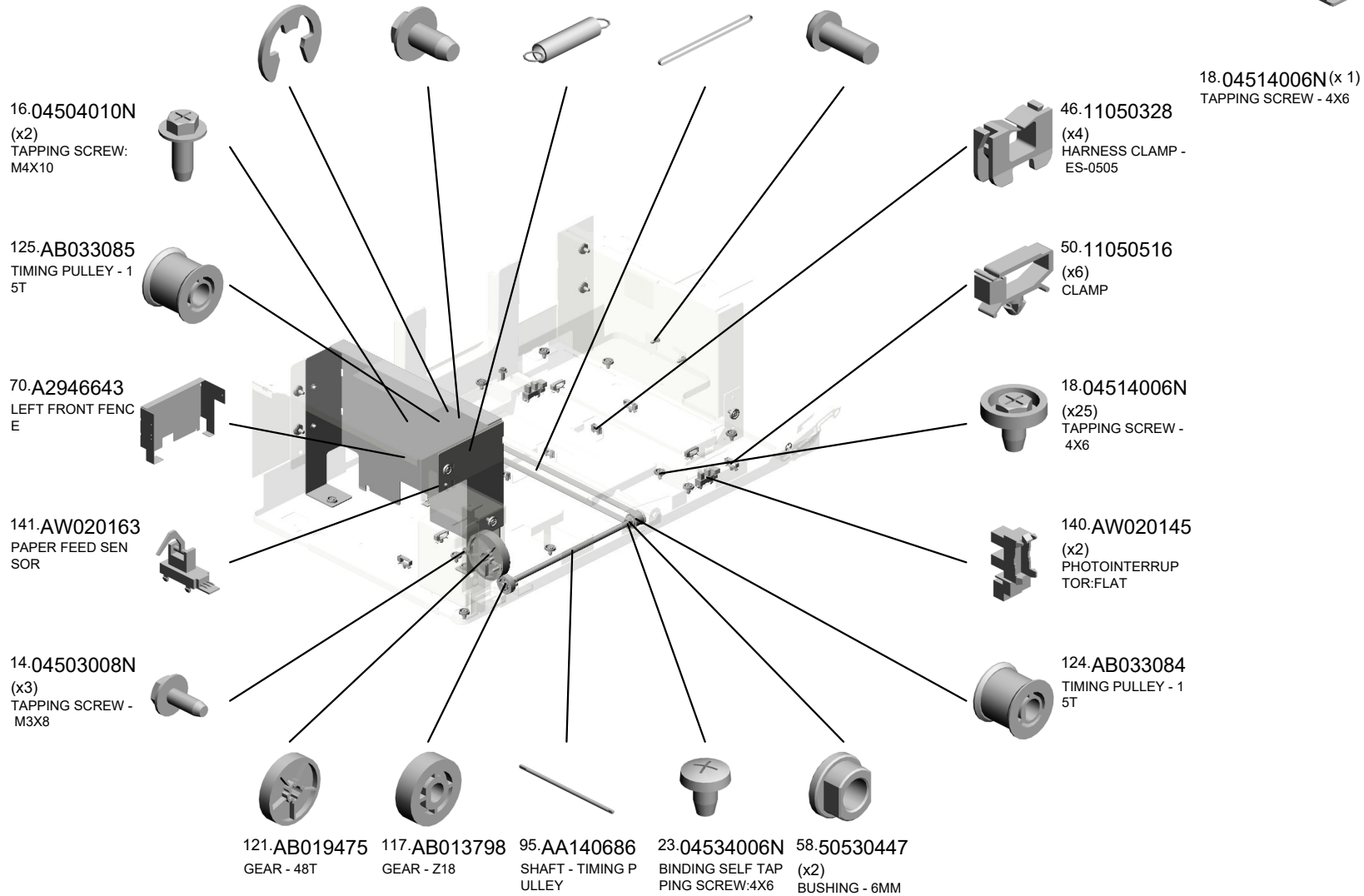

U001	U002	U003	U004	U005	U006	U007	U008	U009	U010	U011	U012	U013	U014	U015	U016	U017	U018	U019	U020	U021
------	------	------	------	------	------	------	------	------	------	------	------	------	------	------	------	------	------	------	------	------

U006_S008
(-CHN):TANDEM LCT:LEFT:ASS'Y

- 346.D1947552 LEFT SIDE PLATE
- 181.B1327561 BACK FENCE:LEFT
- 182.B1327564 SLIDER:BACK FENCE:LEFT
- 225.B2476950 SHAFT:SLIDER:BACK FENCE
- 267.D0606639 (-CHN):TRAY BOTTOM PLATE:LEFT MIDDLE:ASS'Y

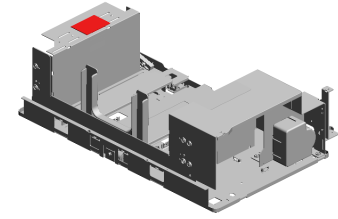

- 344.D1947547 (-CHN):TANDEM LCT:LEFT:ASS'Y

- 289.D0747389 DECAL:PAPER SECT DIRECTION:TANDEM LCT:LEFT



- 376.D0EZ6646 INNER COVER:TANDEM LCT:LEFT 202311-01 O/O



- 226.B2476951 BRACKET:PULLEY:DRIVEN:ASS'Y



- 220.B2347540 TRAY BOTTOM PLATE:LEFT FRONT

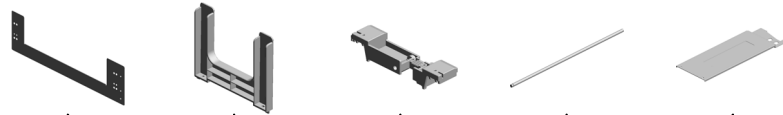

- 178.B1327541 TRAY BOTTOM PLATE:LEFT REAR



- 254.D0596620 LEVER:COUPLING:LEFT



- 256.D0596659 SUPPORTING PLATE:SIDE FENCE:LEFT



- 161.B0656831 SENSOR BRACKET



- 159.B0656823 TIMING BELT COVER
- 145.AX040145 DC MOTOR:TANDEM LCT
- 258.D0596665 BRACKET:DC MOTOR:LEFT:ASS'Y
- 160.B0656830 PULLEY BRACKET



U006_S008_S001
SIDE FENCE:TANDEM LCT:LEFT REAR:ASS'Y

361.AA000313
DECAL:CAUTION:INSERT:PAPER FEED SUB-UNIT
201504-01

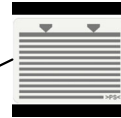
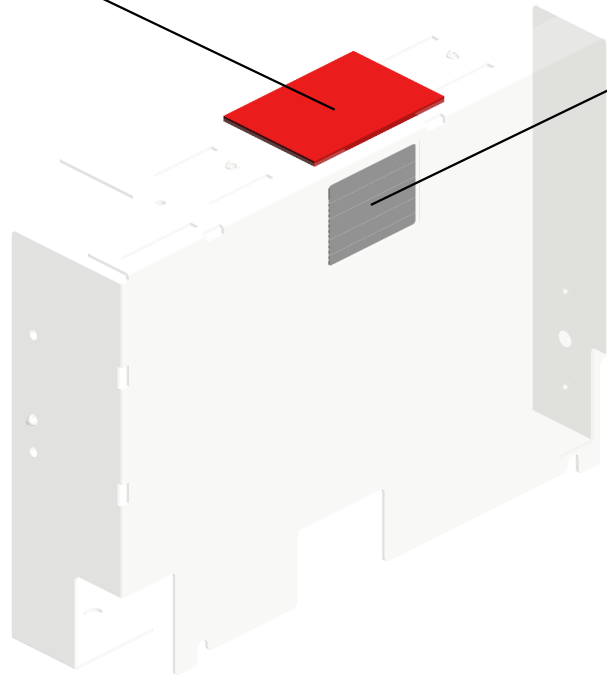
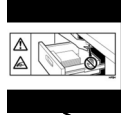

73.AA001508
DECAL:SIDE FENCE:40X30

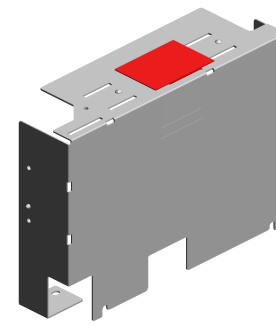

373.D0A57144
[A]
SIDE FENCE:TANDEM LCT:LEFT REAR:ASS'Y
201911-03 X/O

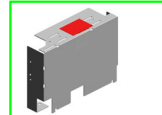

D1797544
[A]
SIDE FENCE:TANDEM LCT:LEFT REAR:ASS'Y
201911-03 X/O

U001	U002	U003	U004	U005	U006	U007	U008	U009	U010	U011	U012	U013	U014	U015	U016	U017	U018	U019	U020	U021
------	------	------	------	------	------	------	------	------	------	------	------	------	------	------	------	------	------	------	------	------

U006_S009
PAPER TRAY:UNIVERSAL:SUB-ASS'Y

242.D0146785 348.D1947635 126.AF017033 221.B2476695 153.B0656524
 SPRING PLATE:AR M:END FENCE:LO CK ARM:END FENCE:L OCK END FENCE GUIDE:MISFEED R EMOVAL:PAPER T RAY BOTTOM PLATE LI FT SHAFT

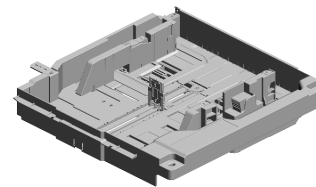

372.D0BX7631
 [A] PAPER TRAY:UNIV ERSAL:SUB-ASS'Y 201909-01 O/O

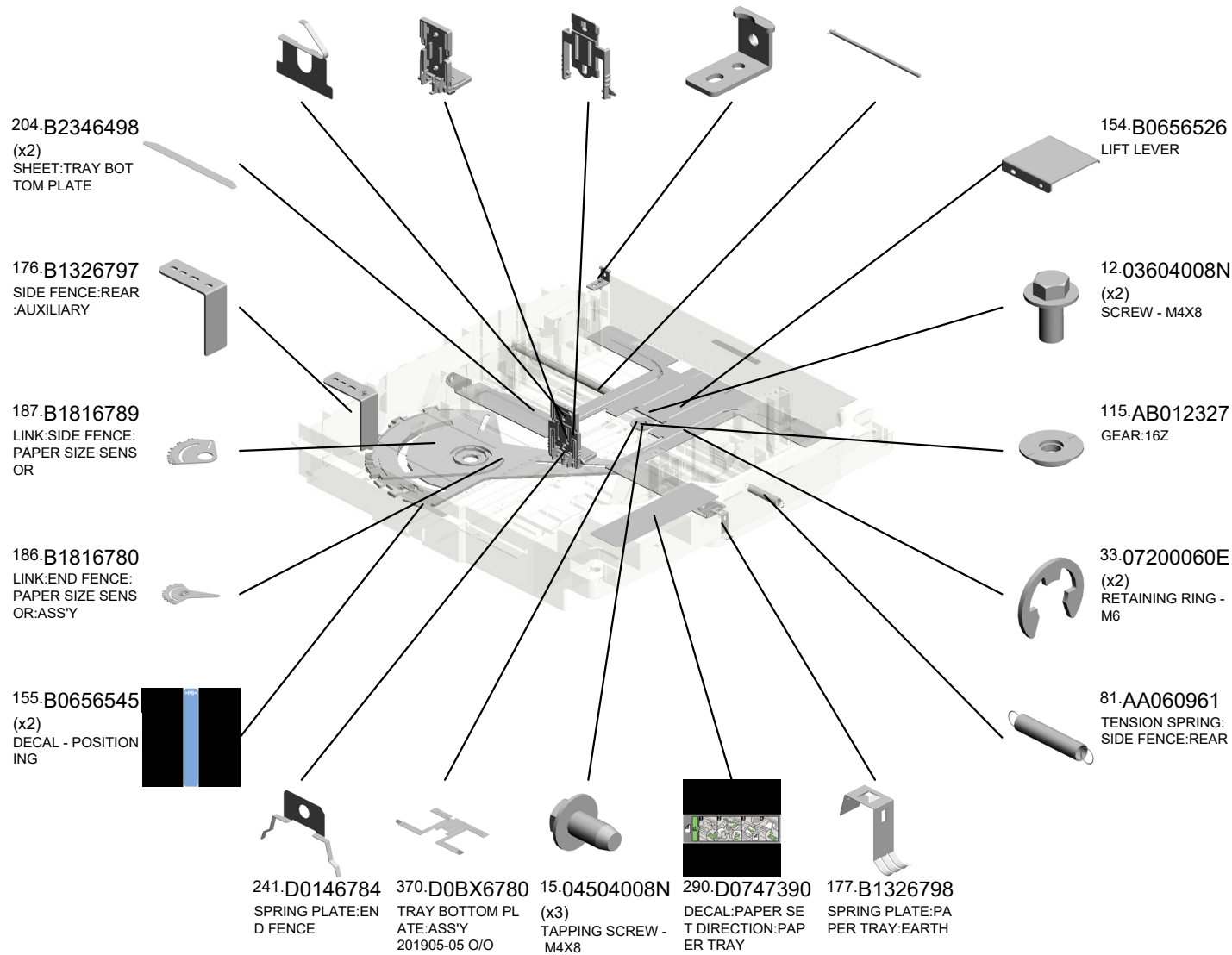

D1947631
 [A] PAPER TRAY:UNIV ERSAL:SUB-ASS'Y 201909-01 O/O

U006_S009_S001
SIDE FENCE:REAR:ASS'Y

68.A2672857 75.AA001597
SPRING PLATE - SI
DE FENCE DECAL:SIDE FENC
E:REAR

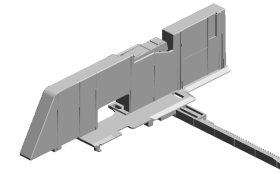

335.D1316775
SIDE FENCE:REAR
:ASS'Y

69.A2672859
SIDE FENCE STOP
PER

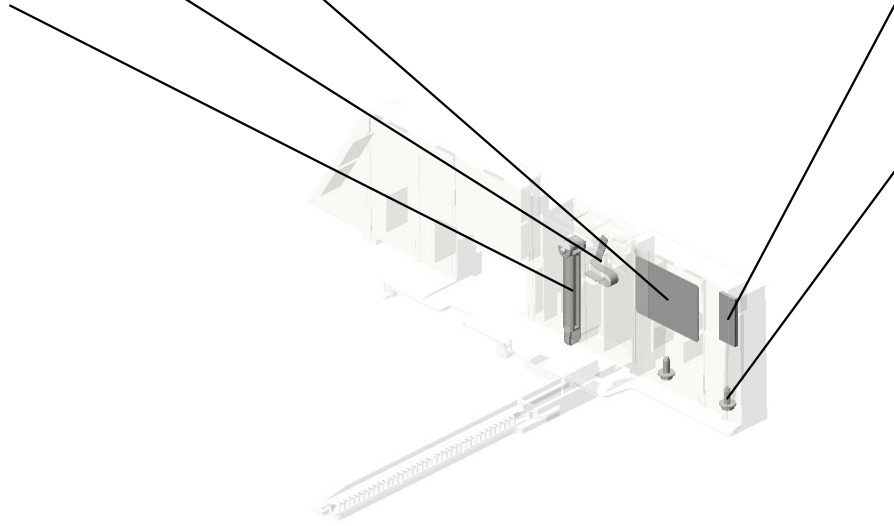
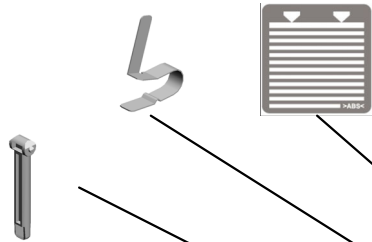

189.B2342864
PAD:CLEANER



14.04503008N
(x2)
TAPPING SCREW -
M3X8

U001	U002	U003	U004	U005	U006	U007	U008	U009	U010	U011	U012	U013	U014	U015	U016	U017	U018	U019	U020	U021
------	------	------	------	------	-------------	------	------	------	------	------	------	------	------	------	------	------	------	------	------	------

U006_S009_S002
SIDE FENCE:FRONT:ASS'Y

175.B1326791 (x2)
PLATE:SIDE FENCE

63.A1342978
SPRING PLATE

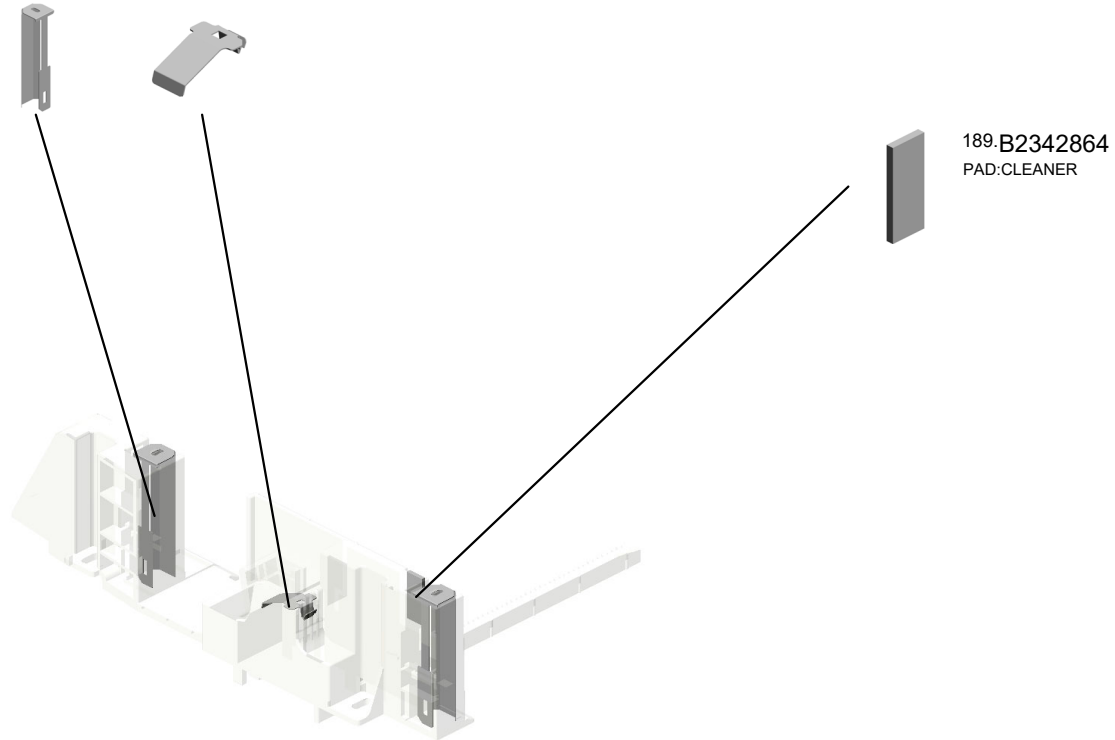
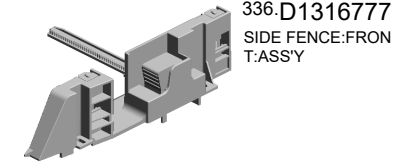

U001	U002	U003	U004	U005	U006	U007	U008	U009	U010	U011	U012	U013	U014	U015	U016	U017	U018	U019	U020	U021
------	------	------	------	------	-------------	------	------	------	------	------	------	------	------	------	------	------	------	------	------	------

U006_S010
HEAT SINK:HEATER:LOWER:ASS'Y

55.11050723
CLAMPS:WES-050
7

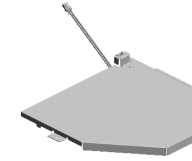

332.D0747680
HEAT SINK:HEATE
R:LOWER:ASS'Y

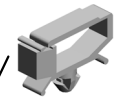

50.11050516
CLAMP



U001	U002	U003	U004	U005	U006	U007	U008	U009	U010	U011	U012	U013	U014	U015	U016	U017	U018	U019	U020	U021
------	------	------	------	------	-------------	------	------	------	------	------	------	------	------	------	------	------	------	------	------	------

U006_S011
HEAT SINK:HEATER:UPPER:ASS'Y

150.B0656118 148.AX400178
GUIDE PLATE:HEA HEATER:240V:18W
T SINK:UPPER:FIB :UPPER
ER

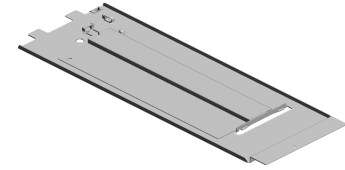

333.D0747681
HEAT SINK:HEATE
R:UPPER:ASSY

334.D0747684
HEAT SINK:HEATE
R:UPPER:FIBER

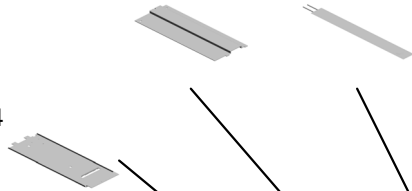

55.11050723
CLAMPS:WES-050
7



50.11050516
(x2)
CLAMP

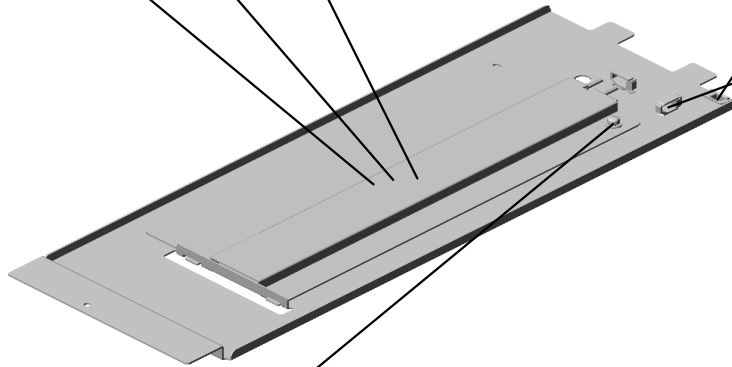
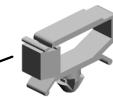

45.09544006N
SCREW:POLISHED
ROUND/SPRING:M
4X6



U001	U002	U003	U004	U005	U006	U007	U008	U009	U010	U011	U012	U013	U014	U015	U016	U017	U018	U019	U020	U021
------	------	------	------	------	-------------	------	------	------	------	------	------	------	------	------	------	------	------	------	------	------

U006_S012
DC SOLENOID:LOCK:ASS'Y

14.04503008N 1.03130040N
TAPPING SCREW - (x2)
M3X8 SCREW:M3X4



266.D0596765
DC SOLENOID:LO
CK:ASS'Y

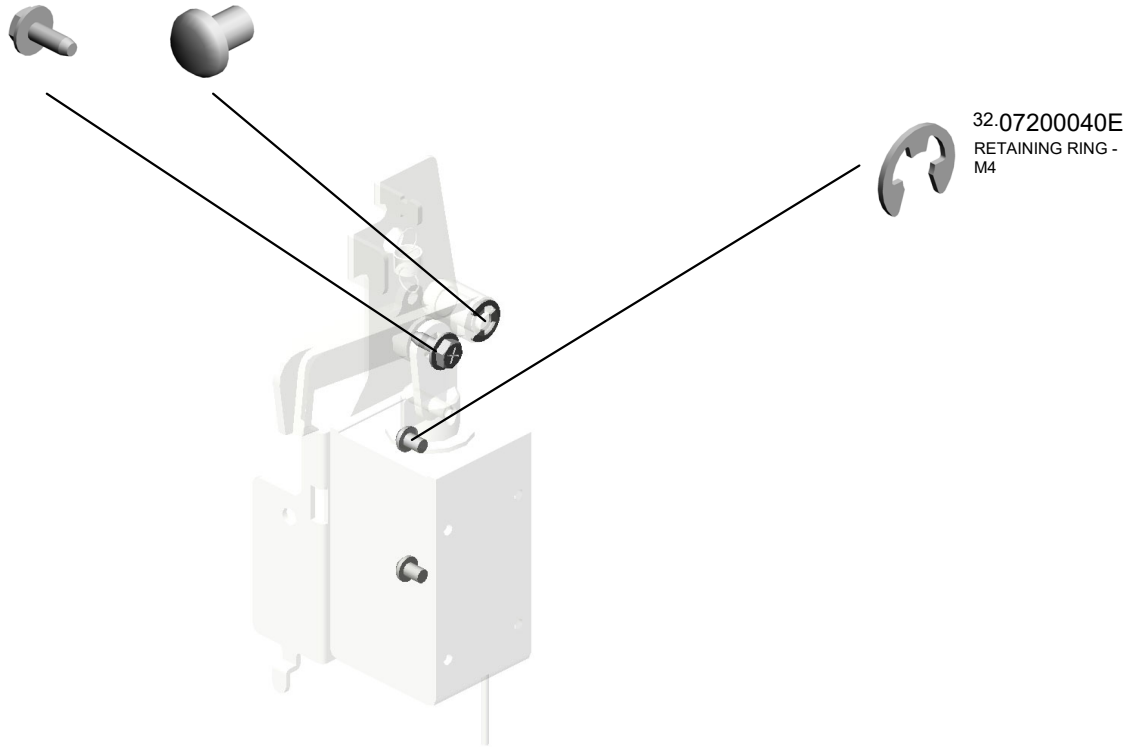

U001	U002	U003	U004	U005	U006	U007	U008	U009	U010	U011	U012	U013	U014	U015	U016	U017	U018	U019	U020	U021
------	------	------	------	------	-------------	------	------	------	------	------	------	------	------	------	------	------	------	------	------	------

U006_S013
DC SOLENOID:COUPLING:ASS'Y

32.07200040E
RETAINING RING -
M4

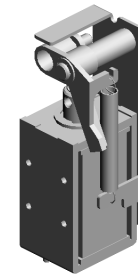

172-B1326762
DC SOLENOID:CO
UPLING:ASS'Y

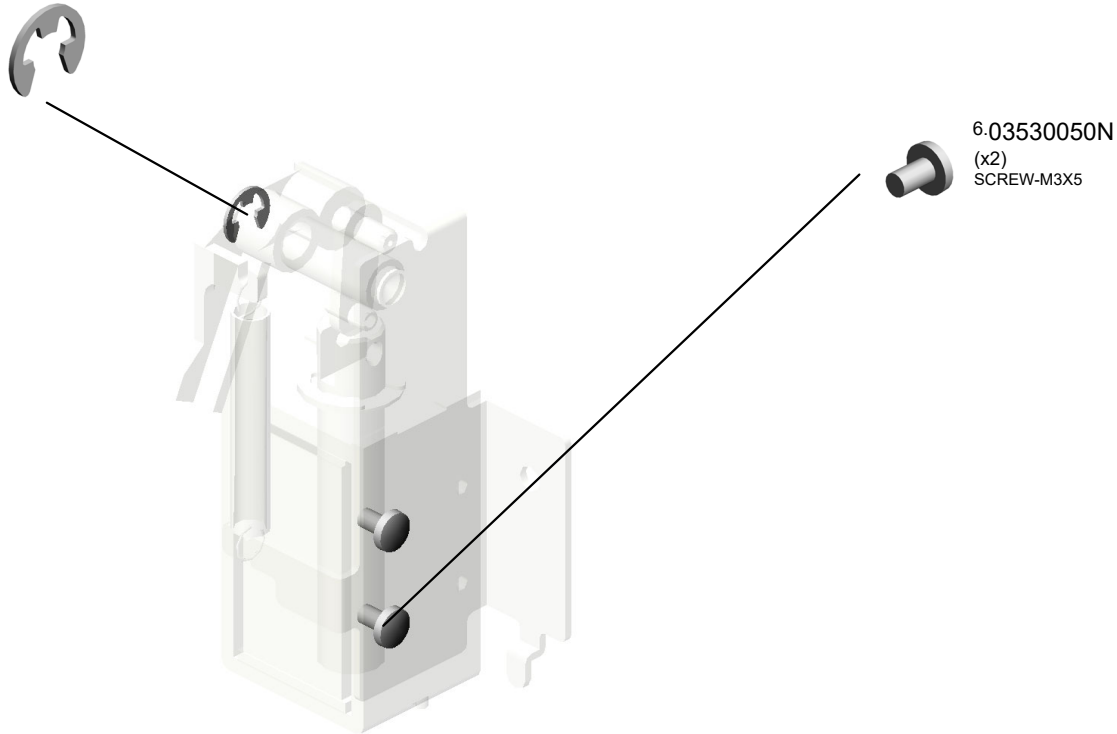

U001	U002	U003	U004	U005	U006	U007	U008	U009	U010	U011	U012	U013	U014	U015	U016	U017	U018	U019	U020	U021
------	------	------	------	------	-------------	------	------	------	------	------	------	------	------	------	------	------	------	------	------	------

U006_S014
DC MOTOR:RISING TRAY:ASS'Y:1.007W:BRUSH

4-03530030N
(x2)
SCREW:M3X3

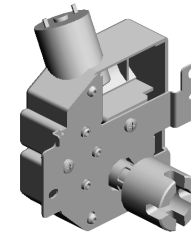

147:AX040254
DC MOTOR:RISING
TRAY:ASS'Y:1.007
W:BRUSH

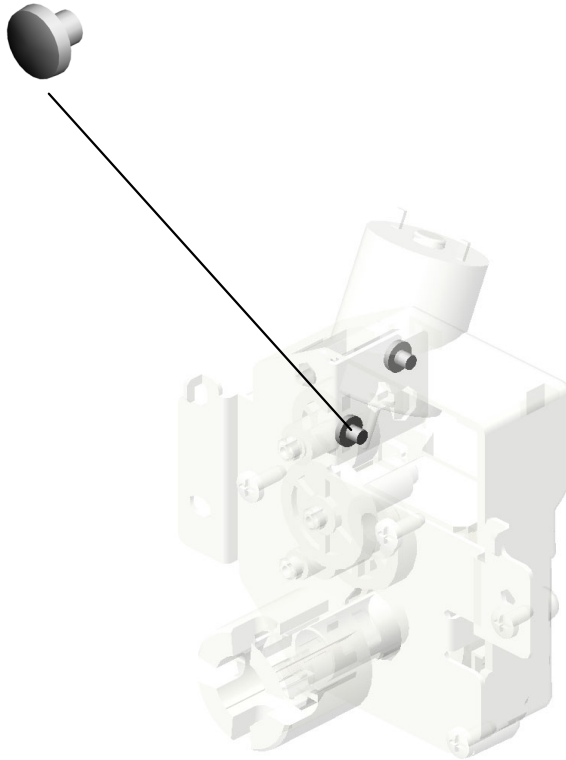

U001	U002	U003	U004	U005	U006	U007	U008	U009	U010	U011	U012	U013	U014	U015	U016	U017	U018	U019	U020	U021
------	------	------	------	------	-------------	------	------	------	------	------	------	------	------	------	------	------	------	------	------	------

U006_S015
GUIDE PLATE:FEED PAPER AGAIN:ASS'Y



340.D1947469
[A]
GUIDE PLATE:FEED
D PAPER AGAIN:A
SS'Y
201506-12 X/O

10.03603006N(x 2)
SCREW - M3X6



D1947464
[A]
GUIDE PLATE:FEED
D PAPER AGAIN:A
SS'Y
201506-12 X/O

U001	U002	U003	U004	U005	U006	U007	U008	U009	U010	U011	U012	U013	U014	U015	U016	U017	U018	U019	U020	U021
------	------	------	------	------	------	------	------	------	------	------	------	------	------	------	------	------	------	------	------	------

U006_S016
BRACKET:DETENT:RIGHT:ASS'Y

31.07200030E
(x2)
RETAINING RING -
M3

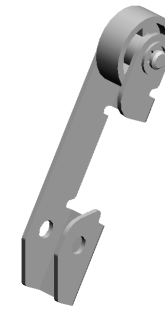

349.D3553810
BRACKET:DETENT
:RIGHT:ASS'Y

U001	U002	U003	U004	U005	U006	U007	U008	U009	U010	U011	U012	U013	U014	U015	U016	U017	U018	U019	U020	U021
------	------	------	------	------	-------------	------	------	------	------	------	------	------	------	------	------	------	------	------	------	------

U006_S017
BRACKET:DETENT:ASS'Y

31.07200030E
(x2)
RETAINING RING -
M3



351.D3553840
BRACKET:DETENT
:ASS'Y

U001	U002	U003	U004	U005	U006	U007	U008	U009	U010	U011	U012	U013	U014	U015	U016	U017	U018	U019	U020	U021
------	------	------	------	------	-------------	------	------	------	------	------	------	------	------	------	------	------	------	------	------	------

U006_S018
PAPER FEED UNIT:PAPER BANK:ASS'Y

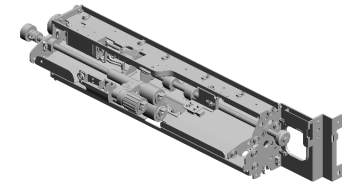

341.D1947500
PAPER FEED UNIT
:PAPER BANK:ASS'
Y

34.07413506 (x4) BALL BEARING - 6 X12X4 MM
13.04340060N (x3) PAN SELF-TAPPING SCREW:M4X6
41.08050088 (x2) RETAINING RING - M6
78.AA060523 PICK-UP PRESSURE SPRING
28.05730030E HEXAGON HEADLESS SET SCREW - M3X3

53.11050551 (x3) CLAMP:LES-0505



49.11050511 (x18) HARNESS CLAMP - LWS-0306ZC



87.AA063693 (x2) COMPRESSION SPRING:PRESSURE-DRIVEN ROLLER

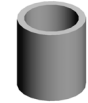

33.07200060E (x4) RETAINING RING - M6



26.04544006Q (x13) TAPPING SCREW: 4X6



92.AA083009 CLUTCH ROLLER - 8X18X11



49.11050511 (x4) HARNESS CLAMP - LWS-0306ZC



32.07200040E (x7) RETAINING RING - M4



114.AB011591 GEAR:REVERSE



113.AB011392 DRIVE REVERSE GEAR - 24Z

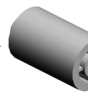

5.03530040N (x2) SCREW - M3X4



61.54472706 GEAR - 15T



93.AA084059 (x2) BALL BEARING HOLDER



18.04514006N (x6) TAPPING SCREW - 4X6



83.AA061000 SPRING - 1.42N



84.AA061001 RELEASE SPRING



U006_S018

PAPER FEED UNIT:PAPER BANK:ASS'Y

- 250.D0596277 COVER:GEAR:PAPER FEED ROLLER
- 188.B2342624 BALL BEARING - 8 X12X5
- 198.B2346275 PICKUP ARM
- 152.B0656345 PAPER END SENSOR BRACKET
- 200.B2346288 BSENSOR BRACKET - SENSOR

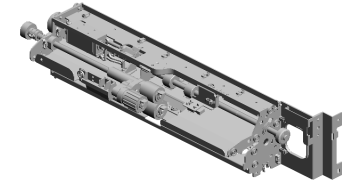

- 341.D1947500 PAPER FEED UNIT :PAPER BANK:ASS'Y

- 135.AF031080 PAPER FEED ROLLER:FEED



- 201.B2346301 TORQUE LIMITER: 75MN M

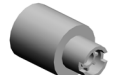

- 136.AF032080 PAPER FEED ROLLER:SEPARATE

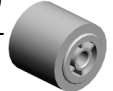

- 245.D0592620 (x3) RETAINING RINGS -C



- 234.BB013007 GEAR - 20Z



- 129.AF020743 TRANSPORT ROLLER:DRIVE:PAPER FEED UNIT
- 130.AF020744 TRANSPORT ROLLER:DRIVEN:PAPER FEED UNIT
- 197.B2346242 GUIDE - ROLLER:DRIVEN PRESSURE
- 249.D0596212 LEVER:PRESSURE :REVERSE
- 251.D0596278 COVER:GEAR:REVERSE

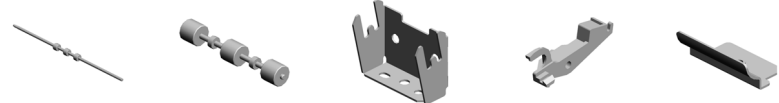

- 120.AB017771 GEAR:TRANSPORT ROLLER:INPUT:Z 23/Z28



- 235.BB013008 GEAR - 31Z



- 194.B2346222 REVERSE DRIVE SHAFT



- 195.B2346223 DRIVEN REVERSE SHAFT



- 196.B2346233 DC SOLENOID:REVERSE:SUB-ASS'Y



U006_S018
 PAPER FEED UNIT:PAPER BANK:ASS'Y

303.D0747521 358.GW010007
 GUIDE PLATE:UPP (x2)
 ER:PAPER FEED U PHOTO REFLECTI
 NIT ON SENSOR:EXIT

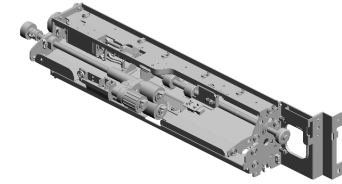

341.D1947500
 PAPER FEED UNIT
 :PAPER BANK:ASS'
 Y

375.AF030173
 PAPER FEED ROL
 LER:PICKUP
 202208-01 O/O



365.07433808
 (x2)
 RADIAL BALL BEA
 RING:DIA8XDIA16X
 5
 201807-01 O/O



371.GW020024
 PHOTOINTERRUP
 TOR:LG2A24BL1:G
 F
 201906-01 O/O

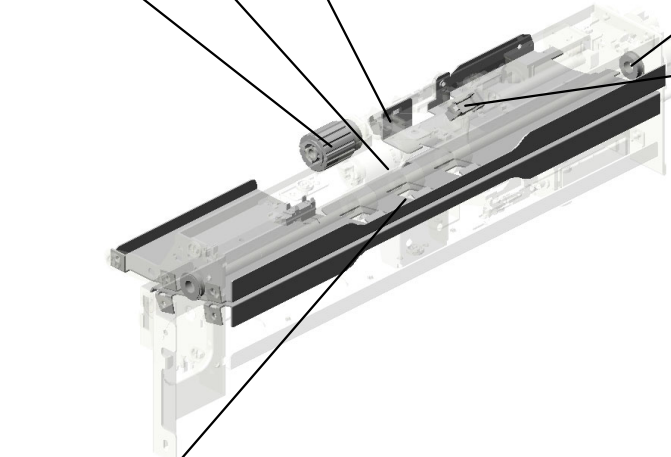

304.D0747522
 GUIDE PLATE:LO
 WER:PAPER FEED
 UNIT



U001	U002	U003	U004	U005	U006	U007	U008	U009	U010	U011	U012	U013	U014	U015	U016	U017	U018	U019	U020	U021
------	------	------	------	------	------	------	------	------	------	------	------	------	------	------	------	------	------	------	------	------

U006_S018_S001
SHAFT:FEED:ASS'Y

33.07200060E
RETAINING RING -
M6



305.D0747527
SHAFT:FEED:ASS'
Y

U001	U002	U003	U004	U005	U006	U007	U008	U009	U010	U011	U012	U013	U014	U015	U016	U017	U018	U019	U020	U021
------	------	------	------	------	-------------	------	------	------	------	------	------	------	------	------	------	------	------	------	------	------

U006_S018_S002
PICKUP DC SOLENOID

5.03530040N
(x2)
SCREW - M3X4

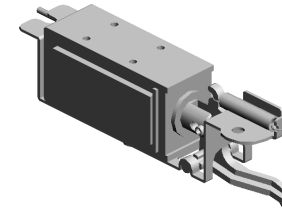

199-B2346282
PICKUP DC SOLENOID

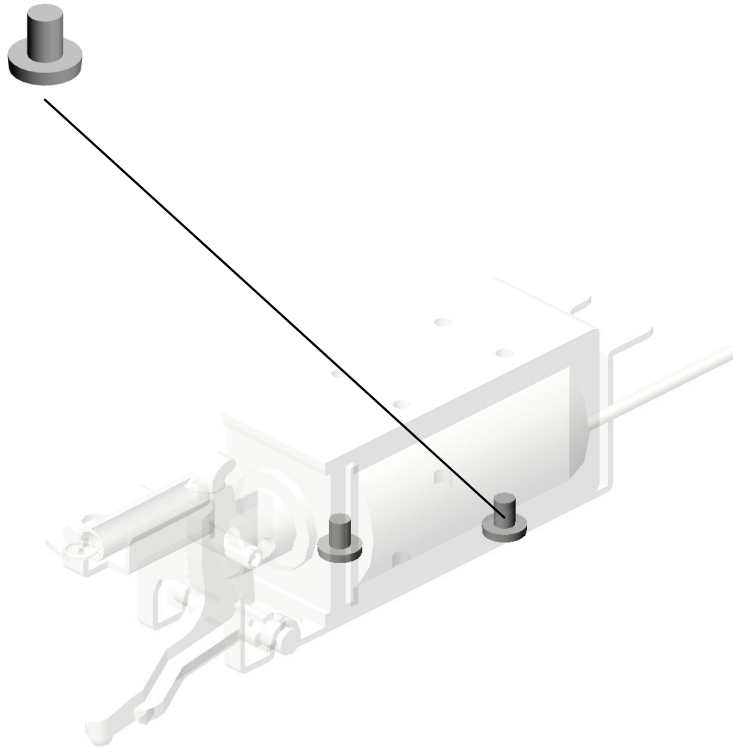

U001	U002	U003	U004	U005	U006	U007	U008	U009	U010	U011	U012	U013	U014	U015	U016	U017	U018	U019	U020	U021
------	------	------	------	------	-------------	------	------	------	------	------	------	------	------	------	------	------	------	------	------	------

U006_S019
PAPER FEED UNIT:PAPER BANK:ASS'Y

- 34.07413506 (x4) BALL BEARING - 6 X12X4 MM
- 13.04340060N (x3) PAN SELF-TAPPING SCREW:M4X6
- 41.08050088 (x2) RETAINING RING - M6
- 78.AA060523 PICK-UP PRESSURE SPRING
- 28.05730030E HEXAGON HEADLESS SET SCREW - M3X3

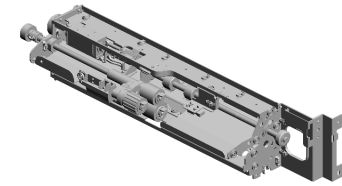

341.D1947500
PAPER FEED UNIT
:PAPER BANK:ASS'
Y

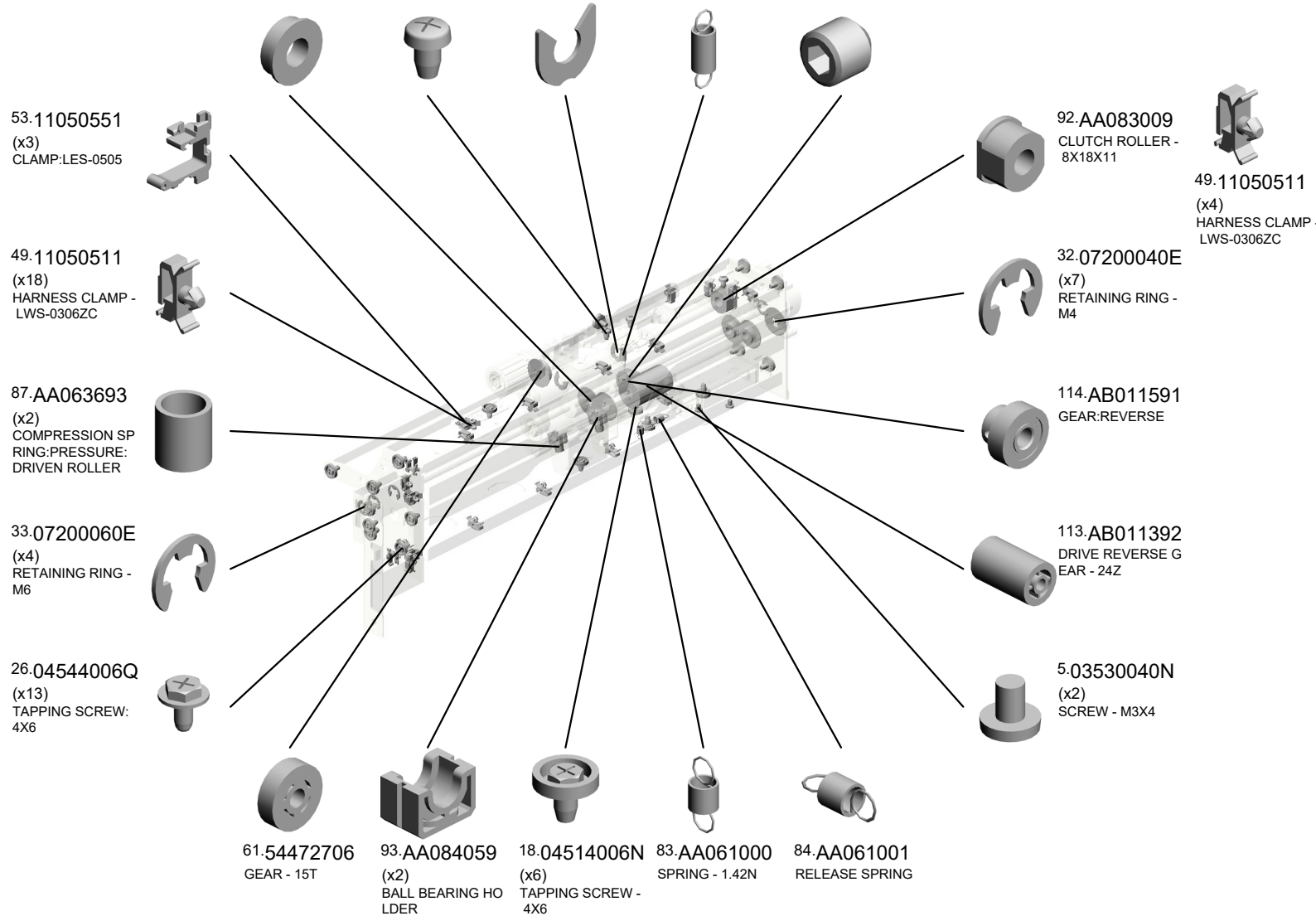

U006_S019
 PAPER FEED UNIT:PAPER BANK:ASS'Y

250.D0596277 COVER:GEAR:PAPER FEED ROLLER
 188.B2342624 BALL BEARING - 8 X12X5
 198.B2346275 PICKUP ARM
 152.B0656345 PAPER END SENSOR BRACKET
 200.B2346288 BSENSOR BRACKET - SENSOR

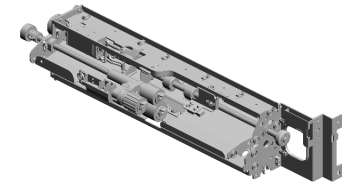

341.D1947500 PAPER FEED UNIT :PAPER BANK:ASS'Y

135.AF031080 PAPER FEED ROLLER:FEED



201.B2346301 TORQUE LIMITER: 75MN M



136.AF032080 PAPER FEED ROLLER:SEPARATE

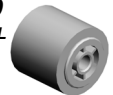

245.D0592620 (x3) RETAINING RINGS -C



234.BB013007 GEAR - 20Z

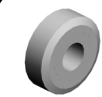

129.AF020743 TRANSPORT ROLLER:DRIVE:PAPER FEED UNIT

130.AF020744 TRANSPORT ROLLER:DRIVEN:PAPER FEED UNIT

197.B2346242 GUIDE - ROLLER:DRIVEN PRESSURE

249.D0596212 LEVER:PRESSURE :REVERSE

251.D0596278 COVER:GEAR:REVERSE

120.AB017771 GEAR:TRANSPORT ROLLER:INPUT:Z 23/Z28



235.BB013008 GEAR - 31Z



194.B2346222 REVERSE DRIVE SHAFT



195.B2346223 DRIVEN REVERSE SHAFT



196.B2346233 DC SOLENOID:REVERSE:SUB-ASS'Y



U001	U002	U003	U004	U005	U006	U007	U008	U009	U010	U011	U012	U013	U014	U015	U016	U017	U018	U019	U020	U021
------	------	------	------	------	------	------	------	------	------	------	------	------	------	------	------	------	------	------	------	------

U006_S019
 PAPER FEED UNIT:PAPER BANK:ASS'Y

303.D0747521 358.GW010007
 GUIDE PLATE:UPP (x2)
 ER:PAPER FEED U PHOTO REFLECTI
 NIT ON SENSOR:EXIT

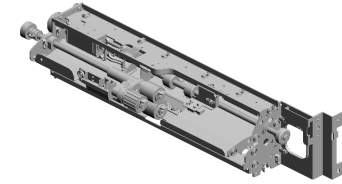

341.D1947500
 PAPER FEED UNIT
 :PAPER BANK:ASS'
 Y

375.AF030173
 PAPER FEED ROL
 LER:PICKUP
 202208-01 O/O



365.07433808
 (x2)
 RADIAL BALL BEA
 RING:DIA8XDIA16X
 5
 201807-01 O/O



371.GW020024
 PHOTOINTERRUP
 TOR:LG2A24BL1:G
 F
 201906-01 O/O

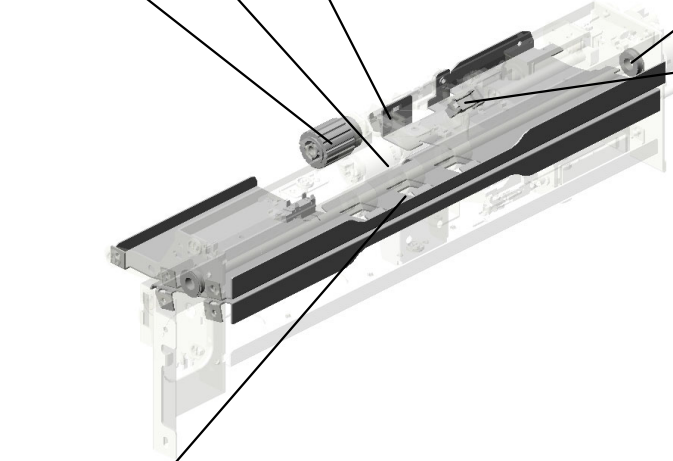

304.D0747522
 GUIDE PLATE:LO
 WER:PAPER FEED
 UNIT



U001	U002	U003	U004	U005	U006	U007	U008	U009	U010	U011	U012	U013	U014	U015	U016	U017	U018	U019	U020	U021
------	------	------	------	------	------	------	------	------	------	------	------	------	------	------	------	------	------	------	------	------

U006_S019_S001
SHAFT:FEED:ASS'Y

33.07200060E
RETAINING RING -
M6



305.D0747527
SHAFT:FEED:ASS'
Y

U001	U002	U003	U004	U005	U006	U007	U008	U009	U010	U011	U012	U013	U014	U015	U016	U017	U018	U019	U020	U021
------	------	------	------	------	-------------	------	------	------	------	------	------	------	------	------	------	------	------	------	------	------

U006_S019_S002
PICKUP DC SOLENOID

5.03530040N
(x2)
SCREW - M3X4

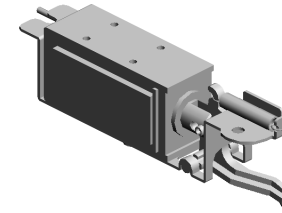

199-B2346282
PICKUP DC SOLENOID

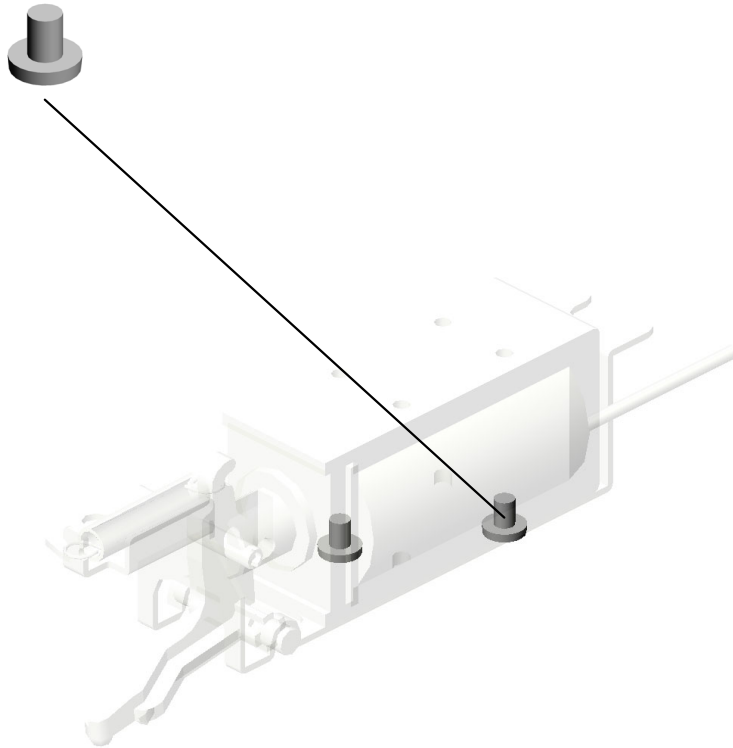

U001	U002	U003	U004	U005	U006	U007	U008	U009	U010	U011	U012	U013	U014	U015	U016	U017	U018	U019	U020	U021
------	------	------	------	------	-------------	------	------	------	------	------	------	------	------	------	------	------	------	------	------	------

U007.TONER SUPPLY

U007 S001
D0743533
ELECTROMAGNETIC CLUTC
H:DRIVE:TRANSPORT SCRE
W:ASS'Y

U007 S006
D1943450
PUMP UNIT:TONER SUPPLY:
ASS'Y

U007 S004
D0743533
ELECTROMAGNETIC CLUTC
H:DRIVE:TRANSPORT SCRE
W:ASS'Y

U007 S003
D1943450
PUMP UNIT:TONER SUPPLY:
ASS'Y

U007 S007
D0743533
ELECTROMAGNETIC CLUTC
H:DRIVE:TRANSPORT SCRE
W:ASS'Y

U007 S002
D1943441
CASE:TONER HOPPER:TON
ER SUPPLY:FRONT:ASS'Y

U007 S010
D0743533
ELECTROMAGNETIC CLUTC
H:DRIVE:TRANSPORT SCRE
W:ASS'Y

U007 S005
D1943441
CASE:TONER HOPPER:TON
ER SUPPLY:FRONT:ASS'Y

U007 S012
D1943450
PUMP UNIT:TONER SUPPLY:
ASS'Y

U007 S009
D1943450
PUMP UNIT:TONER SUPPLY:
ASS'Y

U007 S008
D1943441
CASE:TONER HOPPER:TON
ER SUPPLY:FRONT:ASS'Y

U007 S011
D1943441
CASE:TONER HOPPER:TON
ER SUPPLY:FRONT:ASS'Y

U001	U002	U003	U004	U005	U006	U007	U008	U009	U010	U011	U012	U013	U014	U015	U016	U017	U018	U019	U020	U021
------	------	------	------	------	------	------	------	------	------	------	------	------	------	------	------	------	------	------	------	------

U007.TONER SUPPLY

U007 S013
D1943546
TONER BANK:ASS'Y

U007 S022
D1943216
COVER:HARNES:OPERATI
ON SUB-UNIT:TONER BOTTL
E:ASS'Y

U007 S015
D1943546
TONER BANK:ASS'Y

U007 S014
D1943677
COVER:GEAR:TONER BOTTL
E:ASS'Y

U007 S021
D1943655
INNER COVER:TONER BANK
:ASS'Y

U007 S016
D1943677
COVER:GEAR:TONER BOTTL
E:ASS'Y

U007 S024
D2033500
(D203/D204):HOLDER:FRON
T:TONER BOTTLE:5ST:ASS'Y

U007 S018
D1943677
COVER:GEAR:TONER BOTTL
E:ASS'Y

U007 S023
D2033429
(D203/D204):TONER HOPPE
R:TONER SUPPLY:5ST:ASS'
Y

U007 S020
D1943677
COVER:GEAR:TONER BOTTL
E:ASS'Y

U007 S017
D1943546
TONER BANK:ASS'Y

U007 S019
D1943546
TONER BANK:ASS'Y

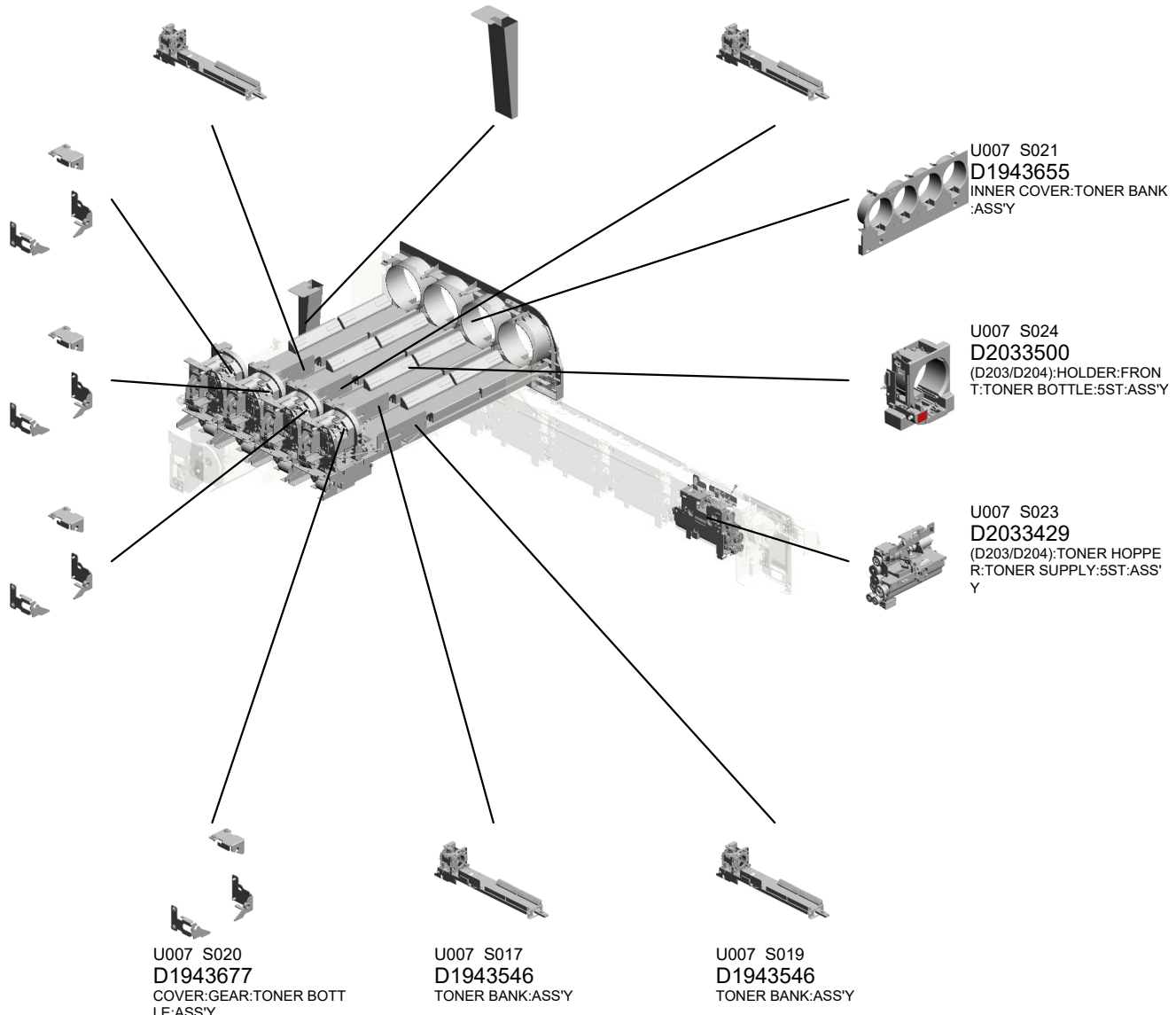

U001	U002	U003	U004	U005	U006	U007	U008	U009	U010	U011	U012	U013	U014	U015	U016	U017	U018	U019	U020	U021
------	------	------	------	------	------	------	------	------	------	------	------	------	------	------	------	------	------	------	------	------

U007.TONER SUPPLY

U007 S025
D2033521
(D203/D204):DRIVE UNIT:TO
NER BOTTLE:5ST:ASSY

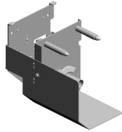

U007 S026
D0A53760
(D194/D195):INNER COVER:
DUMMY:5ST:TONER SUPPLY
:ASSY

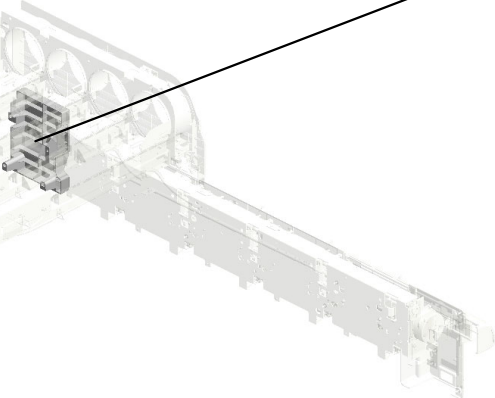
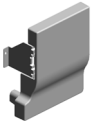

U001	U002	U003	U004	U005	U006	U007	U008	U009	U010	U011	U012	U013	U014	U015	U016	U017	U018	U019	U020	U021
------	------	------	------	------	------	------	------	------	------	------	------	------	------	------	------	------	------	------	------	------

U007_S023.(D203/D204):TONER HOPPER:TONER SUPPLY:5ST:ASS'Y

U007 S023 S002
D1943450
PUMP UNIT:TONER SUPPLY:
ASS'Y

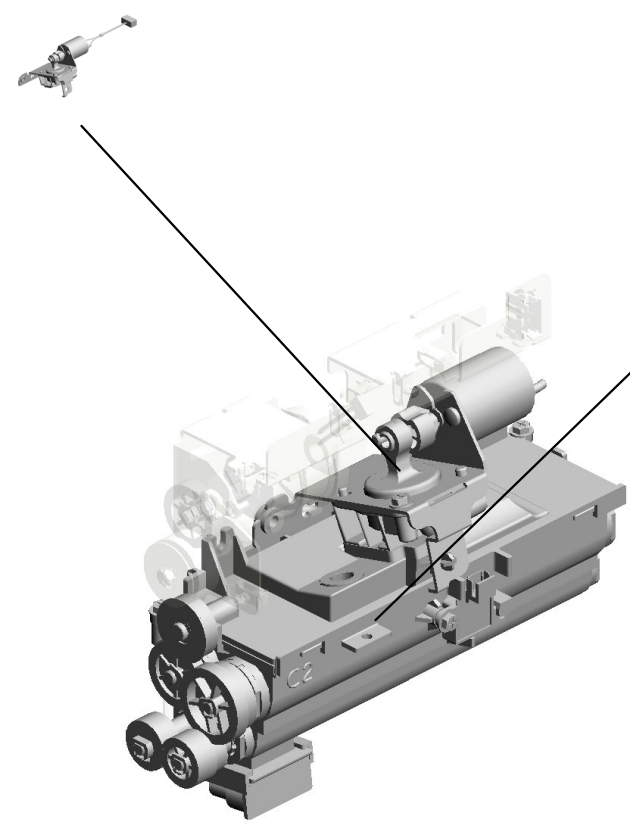

U007 S023 S001
D1943441
CASE:TONER HOPPER:TON
ER SUPPLY:FRONT:ASS'Y

U001	U002	U003	U004	U005	U006	U007	U008	U009	U010	U011	U012	U013	U014	U015	U016	U017	U018	U019	U020	U021
------	------	------	------	------	------	------	------	------	------	------	------	------	------	------	------	------	------	------	------	------

U007 TONER SUPPLY

- 31.52152621 (x5) SNAP RING - M6
- 38.AA082101 (x4) BUSHING - 6X10X6
- 13.04543006Q (x8) TAPPING SCREW - M3X6
- 18.07200040E (x12) RETAINING RING - M4
- 23.11050516 (x14) CLAMP

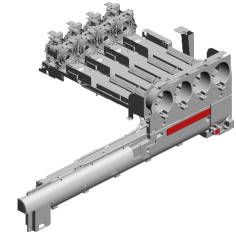

- 21.11050508 (x8) HARNESS CLAMP - LWS-0711

- 10.04514008N (x64) TAPPING SCREW: 4X8

- 20.11050488 (x2) HARNESS CLAMP

- 40.AA143544 (x8) SCREW - M3

- 42.AA143828 (x4) SCREW:FLY WHE EL

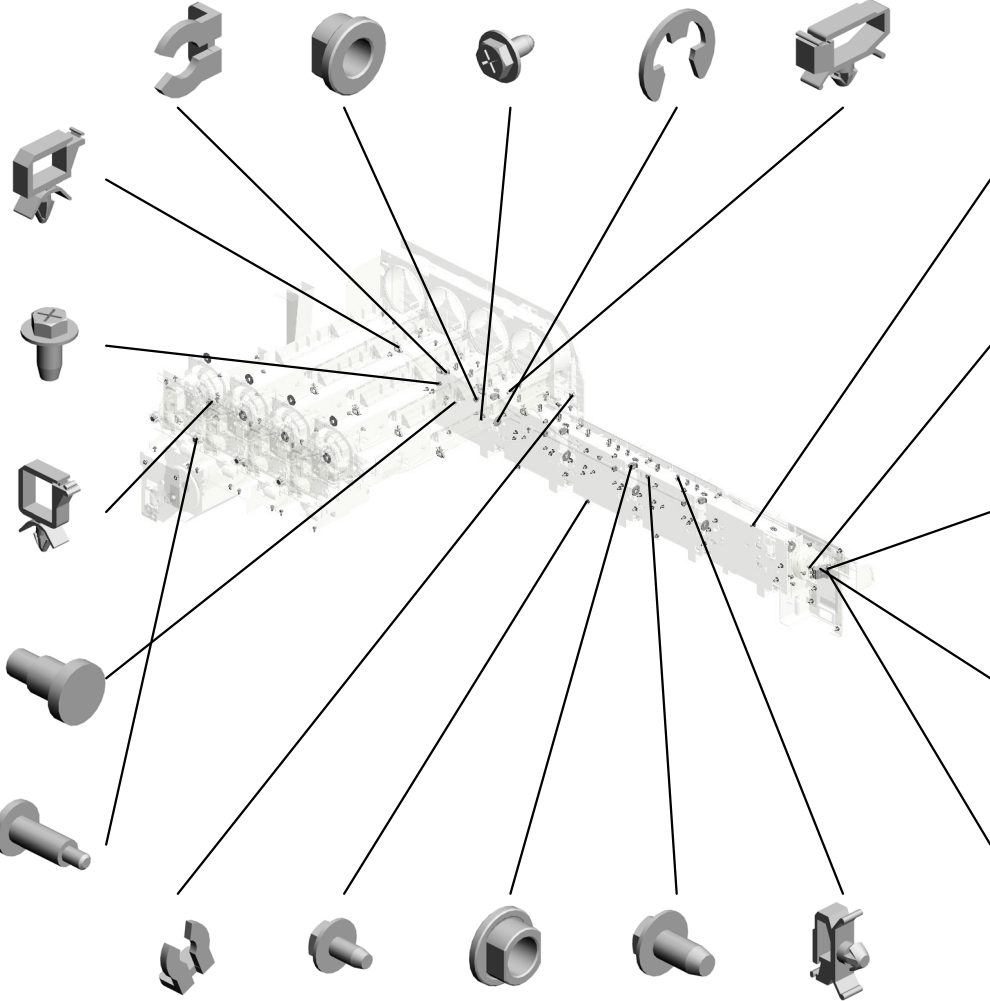

- 32.54472681 SNAP RING
- 3.03603006N (x16) SCREW - M3X6
- 39.AA082144 (x4) BUSHING - 8X12X7
- 7.04504008N (x2) TAPPING SCREW - M4X8
- 22.11050511 (x11) HARNESS CLAMP - LWS-0306ZC

- 4.03604008N (x5) SCREW - M4X8

- 15.04544008Q (x6) TAPPING SCREW - M4X8

- 19.08050092 RETAINING RING - 3M

- 30.12042612 (x2) MICRO SWITCH:D3 V-16506-3C25

- 11.04514025N TAPPING SCREW: M4X25

- 23.11050516 (x3) CLAMP
- 26.11050600 (x4) CLAMP:LWSM-030 6-2M

- 55.B2342390 (x2) FLANGED HEXAG ONAL HEAD BOLT: M4X8

- 7.04504008N (x 1) TAPPING SCREW - M4X8
- 8.04504012N (x 1) TAPPING SCREW:4X12
- 10.04514008N (x 1) TAPPING SCREW:4X8
- 13.04543006Q (x 1) TAPPING SCREW - M3X6
- 18.07200040E (x 1) RETAINING RING - M4

U007 TONER SUPPLY

- 100.D1943628 TUBE:TONER:M:R
EAR
- 81.D1943424 (x4)
BRACKET:DRIVE:T
ONER HOPPER:AS
S'Y
- 59.D0743548 (x4)
GEAR:IDLER:TRAN
SPORT SCREW:LA
RGE
- 48.AW020198 PHOTOINTERRUP
TOR:LG2A14NL1
- 70.D0743756 SEAL:BLOCK LIGH
T:LEVER

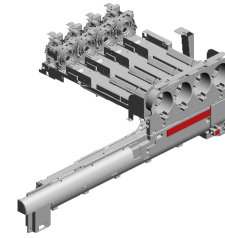

- 44.AB012005
(x4)
GEAR - 13Z

- 94.D1943603
(x4)
GEAR:DRIVE:TON
ER BOTTLE:Z14

- 99.D1943627
TUBE:TONER:C

- 90.D1943567
(x4)
GUIDE:BASE:TONE
R BANK

- 91.D1943587
(x4)
GEAR:TORQUE LI
MITER MECHANIC
AL CLUTCH:DRIVE:
TONER BOTTLE

- 98.D1943626
TUBE:BK

- 86.D1943495
(x4)
STAND:INNER CO
VER:TONER SUPP
LY

- 55.B2342390
(x4)
FLANGED HEXAG
ONAL HEAD BOLT:
M4X8

- 52.B1323223
(x5)
GEAR:21/32Z

- 57.D0591273
DECAL:MAIN SWIT
CH

- 85.D1943485
GEAR:IDLER:DRIV
E:TONER SUPPLY
UNIT:ASS'Y

- 75.D0743829
(x2)
DECAL:POSITIONI
NG DISPLAY:TCRU

- 84.D1943482
BRACKET:DRIVE:T
ONER SUPPLY UNI
T:ASS'Y

- 78.D1793376
LEVER:SAFETY S
WITCH:TONER SU
PLY UNIT:ASS'Y

- 49.AX060376
BRUSHLESS MOT
OR:DEVELOPMEN
T:COLOR

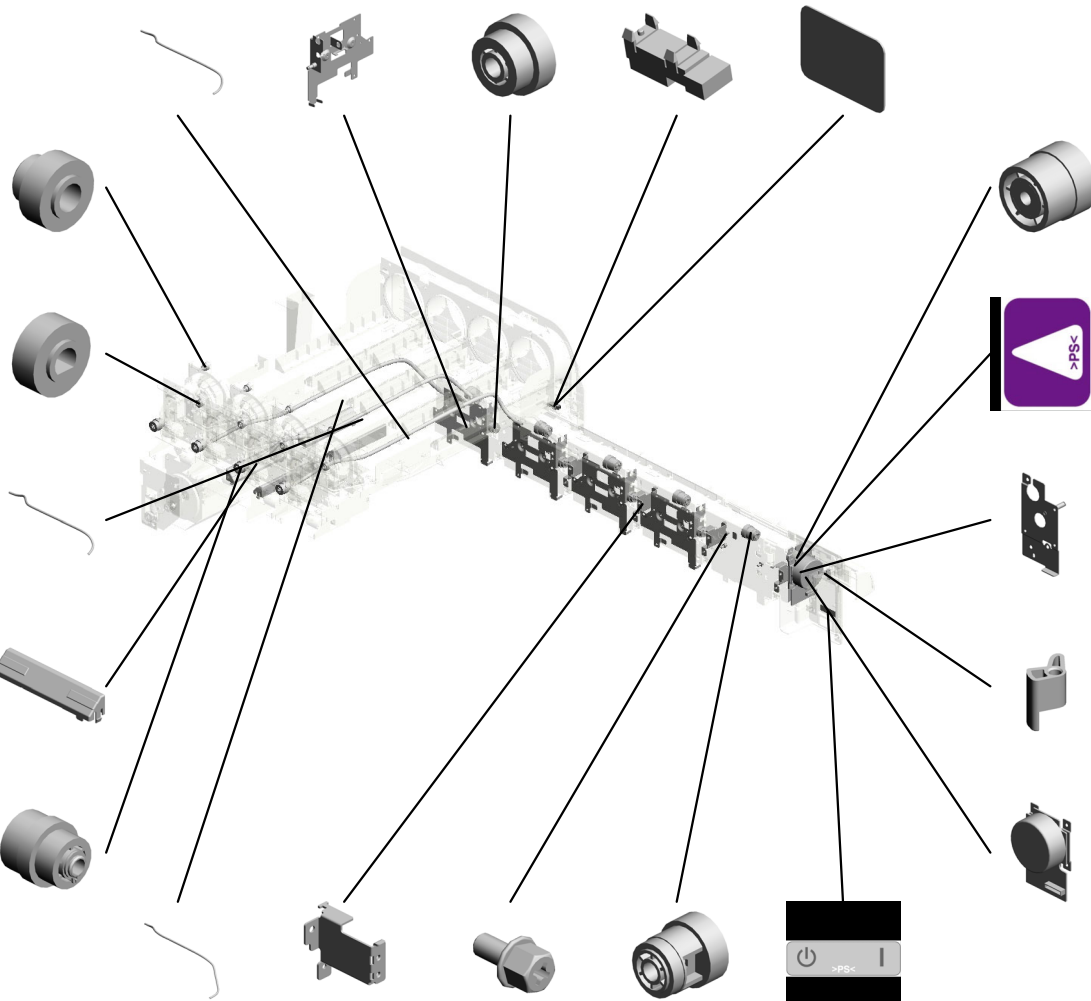

U007 TONER SUPPLY

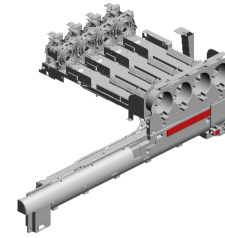

- 115.D1943742 GEAR:TONER BAN
K:RIC:M:ASSY
- 139.D2033516 (D203/D204):GUIDE
:UPPER:TONER B
OTTLE:5ST
- 116.D1943747 GEAR:TONER BAN
K:RIC:Y:ASSY
- 138.D2033515 (D203/D204):GUIDE
:FRONT:TONER B
OTTLE:5ST
- 122.D1943760 (D203/D204-NA,-EU
):INNER COVER:D
UMMY:5ST:TONER
SUPPLY

113.D1943732
GEAR:TONER BAN
K:RIC:K:ASSY

129.D1945426
PCB:TSB:ASSY

112.D1943726
(x4)
SEAL:GEAR:DRIVE
:TONER BOTTLE

114.D1943737
GEAR:TONER BAN
K:RIC:C:ASSY

137.D2033512
(D203/D204):GUIDE
:TONER BOTTLE:5
ST

101.D1943629
TUBE:TONER:Y:RE
AR

143.D2033531
(D203/D204):DECA
L:OPERATE:TONER
BOTTLE:5ST

145.D2033625
TUBE:TONER:S

123.D1943762
INNER COVER:TO
NER HOPPER:TON
ER SUPPLY

127.D1943767
MAGNET CATCH P
LEET:FRONT UPP
ER

104.D1943642
SHAFT:FEELER:SE
NSOR:ON OFF DE
TECTOR:TONER B
ANK

124.D1943764
INNER COVER:TO
NER HOPPER:5ST:
TONER SUPPLY

125.D1943765
TORSION SPRING:
SAFETY SWITCH:T
ONER SUPPLY UNI
T

126.D1943776
INNER COVER:MO
TOR:TONER HOPP
ER:TONER SUPPL
Y
201507-01 X/O

128.D1943768
BRACKET:SAFETY
SWITCH:INNER CO
VER:TONER SUPP
LY

U007 TONER SUPPLY

151.D1943496 153.D2033493
 STAND:INNER CO HOLDER:RECEPTA
 VER:RECEPTACLE:TONER SUPP
 :TONER SUPPLY LY UNIT:5ST:ASS'Y

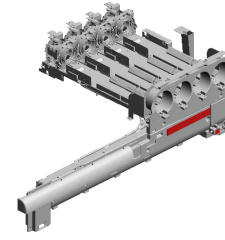

175.D1943653
 BRACKET:INNER C
 OVER:TONER BAN
 K:PEEN

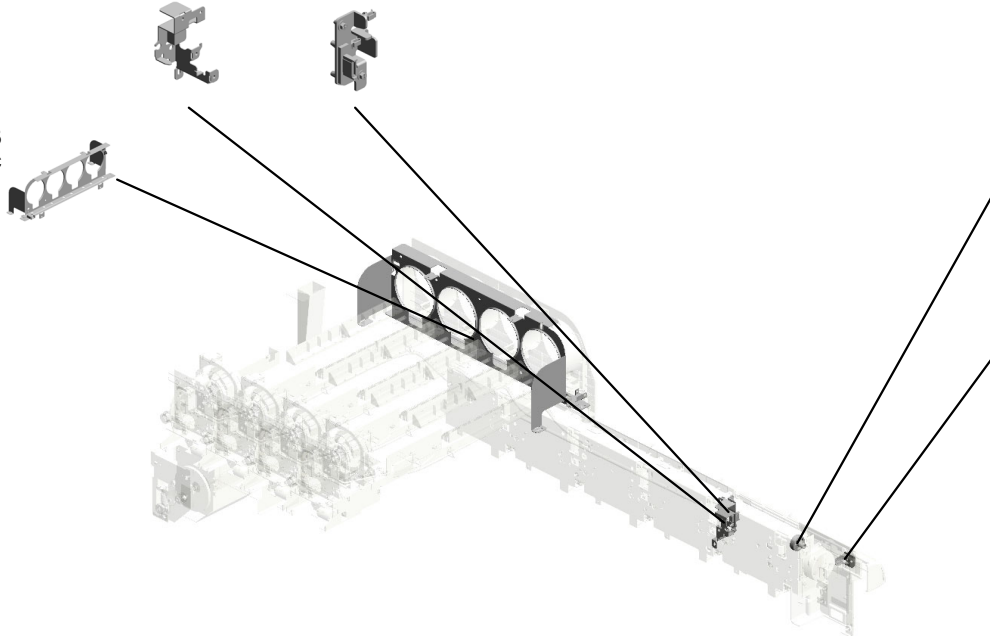

164.D1943409
 GEAR-DRIVE:TON
 ER SUPPLY

148.D3551333
 SHIELDING PLATE:
 SAFETY SWITCH:D
 OOR

U001	U002	U003	U004	U005	U006	U007	U008	U009	U010	U011	U012	U013	U014	U015	U016	U017	U018	U019	U020	U021
------	------	------	------	------	------	------	------	------	------	------	------	------	------	------	------	------	------	------	------	------

U007_S001
ELECTROMAGNETIC CLUTCH:DRIVE:TRANSPORT SCREW:ASS'Y

50.AX200323
ELECTROMAGNET
IC CLUTCH:025NM:
Z31:DIA6

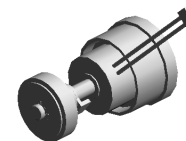

58.D0743533
ELECTROMAGNET
IC CLUTCH:DRIVE:
TRANSPORT SCR
EW:ASS'Y

32.54472681
SNAP RING

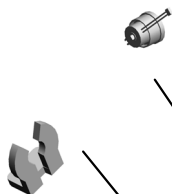

18.07200040E
RETAINING RING -
M4



38.AA082101
BUSHING - 6X10X6



U001	U002	U003	U004	U005	U006	U007	U008	U009	U010	U011	U012	U013	U014	U015	U016	U017	U018	U019	U020	U021
------	------	------	------	------	------	------	------	------	------	------	------	------	------	------	------	------	------	------	------	------

U007_S002
CASE:TONER HOPPER:TONER SUPPLY:FRONT:ASS'Y

149.GW230008 5.04503008N
TONER END SENS TAPPING SCREW -
OR M3X8

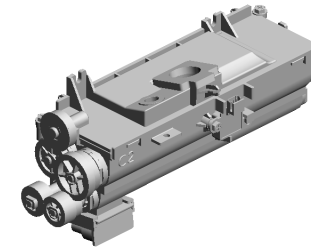

82.D1943441
CASE:TONER HOP
PER:TONER SUPP
LY:FRONT:ASS'Y

19.08050092
(x5)
RETAINING RING -
3M

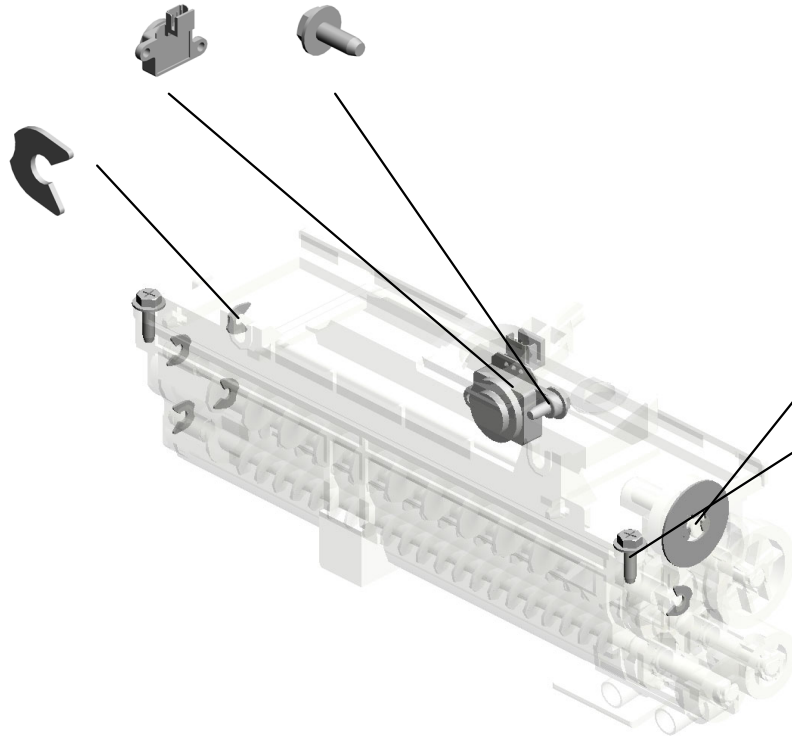

18.07200040E
RETAINING RING -
M4

6.04503010N
(x2)
TAPPING SCREW -
M3X10

U001	U002	U003	U004	U005	U006	U007	U008	U009	U010	U011	U012	U013	U014	U015	U016	U017	U018	U019	U020	U021
------	------	------	------	------	------	------	------	------	------	------	------	------	------	------	------	------	------	------	------	------

U007_S003
PUMP UNIT:TONER SUPPLY:ASS'Y

1.03530030N
(x2)
SCREW:M3X3

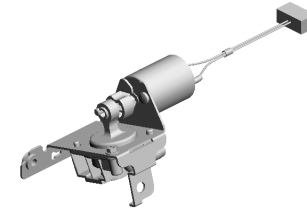

83.D1943450
PUMP UNIT:TONER
SUPPLY:ASS'Y

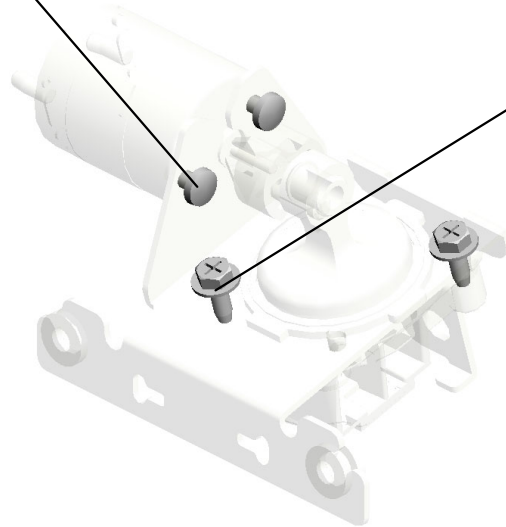

6.04503010N
(x2)
TAPPING SCREW -
M3X10

U001	U002	U003	U004	U005	U006	U007	U008	U009	U010	U011	U012	U013	U014	U015	U016	U017	U018	U019	U020	U021
------	------	------	------	------	------	------	------	------	------	------	------	------	------	------	------	------	------	------	------	------

U007_S004

ELECTROMAGNETIC CLUTCH:DRIVE:TRANSPORT SCREW:ASS'Y

50.AX200323
ELECTROMAGNET
IC CLUTCH:025NM:
Z31:DIA6

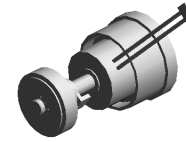

58.D0743533
ELECTROMAGNET
IC CLUTCH:DRIVE:
TRANSPORT SCR
EW:ASS'Y

32.54472681
SNAP RING

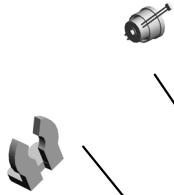

18.07200040E
RETAINING RING -
M4



38.AA082101
BUSHING - 6X10X6



U001	U002	U003	U004	U005	U006	U007	U008	U009	U010	U011	U012	U013	U014	U015	U016	U017	U018	U019	U020	U021
------	------	------	------	------	------	------	------	------	------	------	------	------	------	------	------	------	------	------	------	------

U007_S005
CASE:TONER HOPPER:TONER SUPPLY:FRONT:ASS'Y

149.GW230008 5.04503008N
TONER END SENS TAPPING SCREW -
OR M3X8

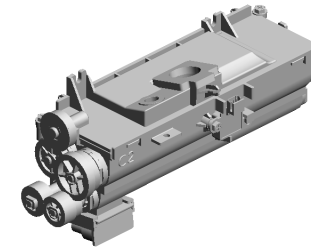

82.D1943441
CASE:TONER HOP
PER:TONER SUPP
LY:FRONT:ASS'Y

19.08050092
(x5)
RETAINING RING -
3M

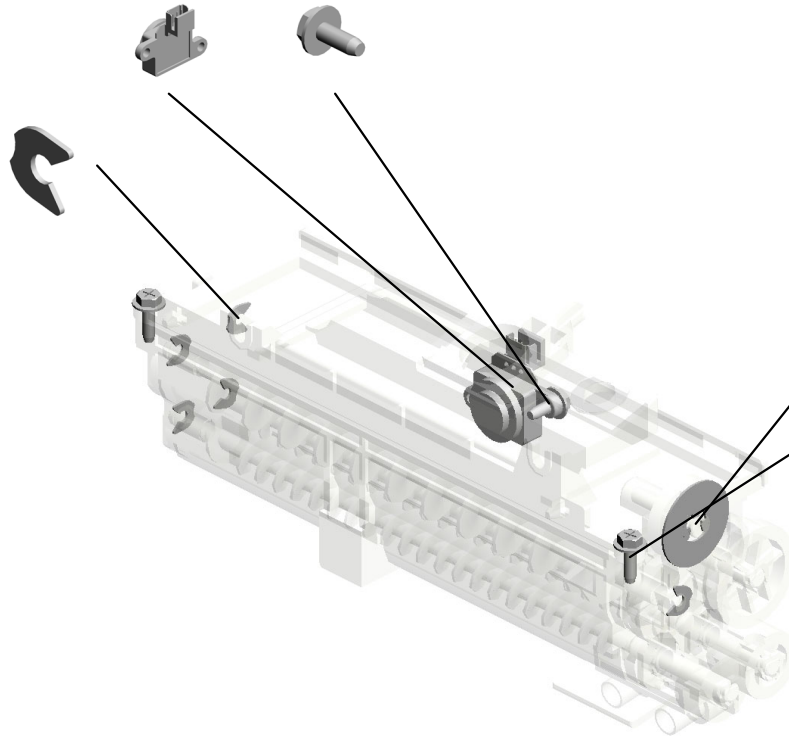

18.07200040E
RETAINING RING -
M4

6.04503010N
(x2)
TAPPING SCREW -
M3X10

U001	U002	U003	U004	U005	U006	U007	U008	U009	U010	U011	U012	U013	U014	U015	U016	U017	U018	U019	U020	U021
------	------	------	------	------	------	------	------	------	------	------	------	------	------	------	------	------	------	------	------	------

U007_S006
PUMP UNIT:TONER SUPPLY:ASS'Y

1.03530030N
(x2)
SCREW:M3X3

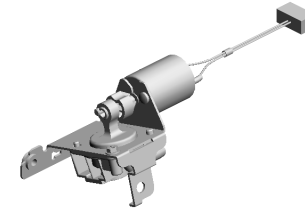

83.D1943450
PUMP UNIT:TONER
SUPPLY:ASS'Y

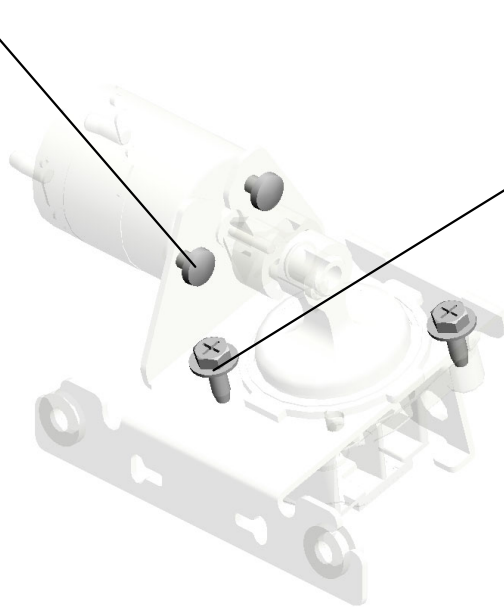

6.04503010N
(x2)
TAPPING SCREW -
M3X10

U001	U002	U003	U004	U005	U006	U007	U008	U009	U010	U011	U012	U013	U014	U015	U016	U017	U018	U019	U020	U021
------	------	------	------	------	------	------	------	------	------	------	------	------	------	------	------	------	------	------	------	------

U007_S007

ELECTROMAGNETIC CLUTCH:DRIVE:TRANSPORT SCREW:ASS'Y

50.AX200323
ELECTROMAGNET
IC CLUTCH:025NM:
Z31:DIA6



58.D0743533
ELECTROMAGNET
IC CLUTCH:DRIVE:
TRANSPORT SCR
EW:ASS'Y

32.54472681
SNAP RING

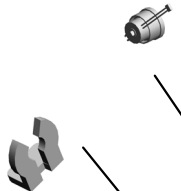

18.07200040E
RETAINING RING -
M4



38.AA082101
BUSHING - 6X10X6



U001	U002	U003	U004	U005	U006	U007	U008	U009	U010	U011	U012	U013	U014	U015	U016	U017	U018	U019	U020	U021
------	------	------	------	------	------	------	------	------	------	------	------	------	------	------	------	------	------	------	------	------

U007_S008
CASE:TONER HOPPER:TONER SUPPLY:FRONT:ASS'Y

149.GW230008 5.04503008N
TONER END SENS TAPPING SCREW -
OR M3X8

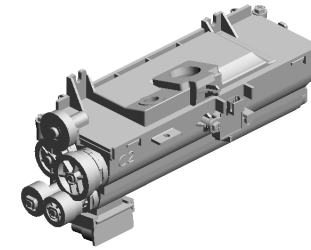

82.D1943441
CASE:TONER HOP
PER:TONER SUPP
LY:FRONT:ASS'Y

19.08050092
(x5)
RETAINING RING -
3M

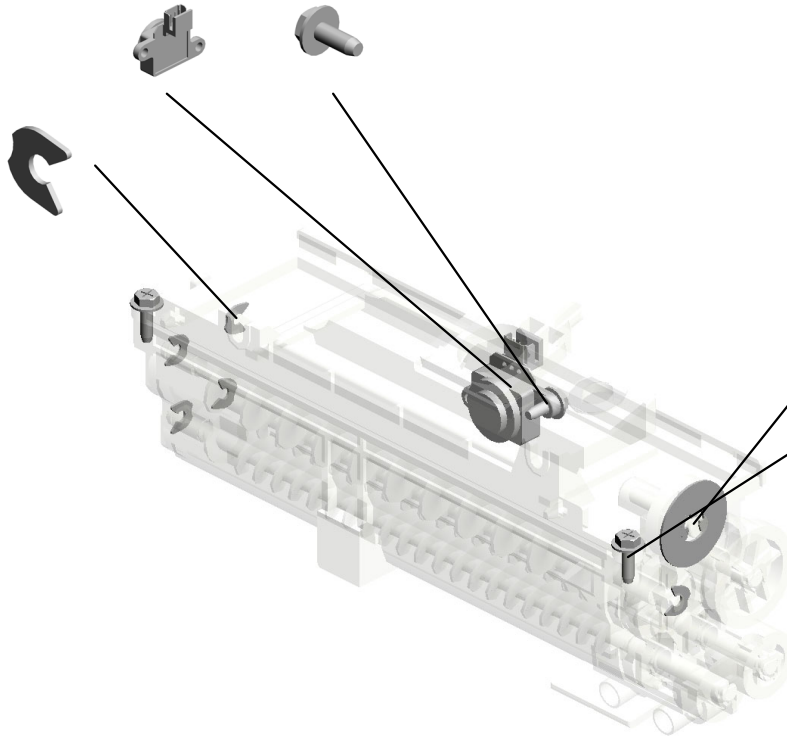

18.07200040E
RETAINING RING -
M4

6.04503010N
(x2)
TAPPING SCREW -
M3X10

U001	U002	U003	U004	U005	U006	U007	U008	U009	U010	U011	U012	U013	U014	U015	U016	U017	U018	U019	U020	U021
------	------	------	------	------	------	------	------	------	------	------	------	------	------	------	------	------	------	------	------	------

U007_S009
PUMP UNIT:TONER SUPPLY:ASS'Y

1.03530030N
(x2)
SCREW:M3X3

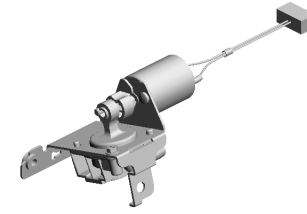

83.D1943450
PUMP UNIT:TONER
SUPPLY:ASS'Y

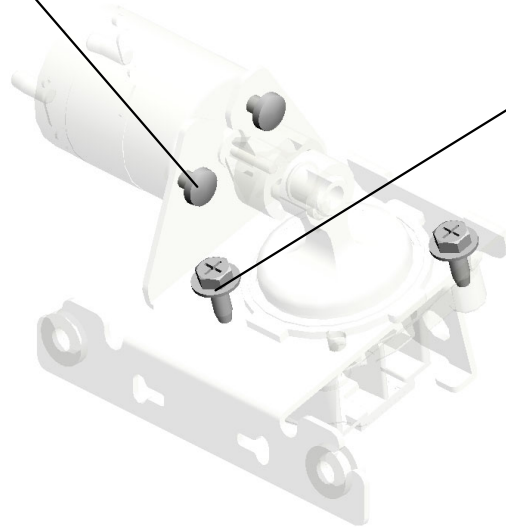

6.04503010N
(x2)
TAPPING SCREW -
M3X10

U001	U002	U003	U004	U005	U006	U007	U008	U009	U010	U011	U012	U013	U014	U015	U016	U017	U018	U019	U020	U021
------	------	------	------	------	------	------	------	------	------	------	------	------	------	------	------	------	------	------	------	------

U007_S010
ELECTROMAGNETIC CLUTCH:DRIVE:TRANSPORT SCREW:ASS'Y

50.AX200323
ELECTROMAGNET
IC CLUTCH:025NM:
Z31:DIA6

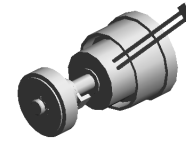

58.D0743533
ELECTROMAGNET
IC CLUTCH:DRIVE:
TRANSPORT SCR
EW:ASS'Y

32.54472681
SNAP RING

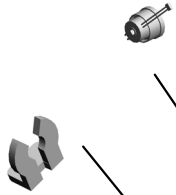

18.07200040E
RETAINING RING -
M4



38.AA082101
BUSHING - 6X10X6



U001	U002	U003	U004	U005	U006	U007	U008	U009	U010	U011	U012	U013	U014	U015	U016	U017	U018	U019	U020	U021
------	------	------	------	------	------	------	------	------	------	------	------	------	------	------	------	------	------	------	------	------

U007_S011
CASE:TONER HOPPER:TONER SUPPLY:FRONT:ASS'Y

149.GW230008 5.04503008N
TONER END SENS TAPPING SCREW -
OR M3X8

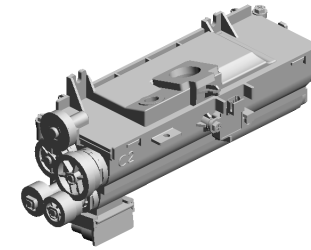

82.D1943441
CASE:TONER HOP
PER:TONER SUPP
LY:FRONT:ASS'Y

19.08050092
(x5)
RETAINING RING -
3M

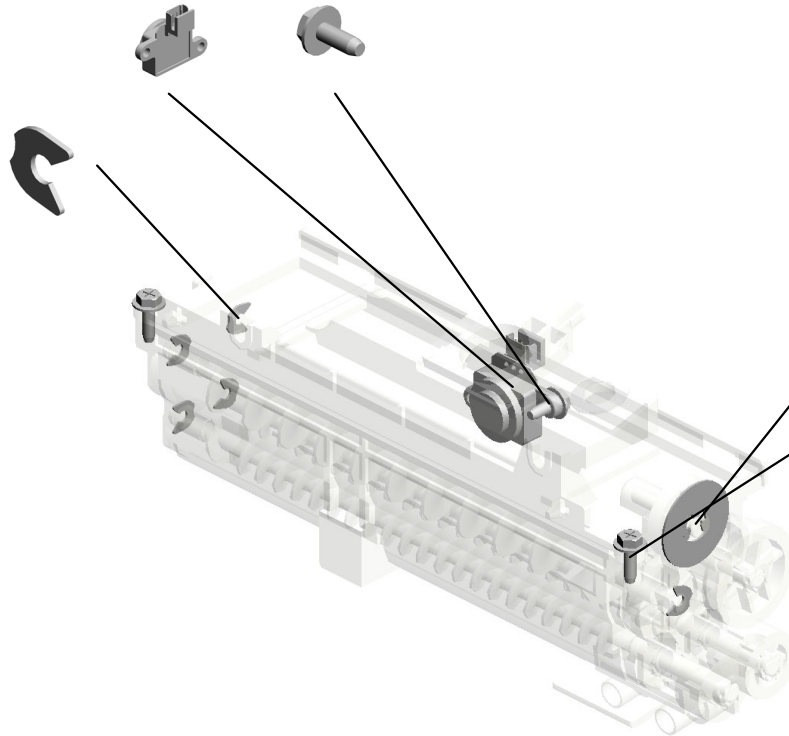

18.07200040E
RETAINING RING -
M4

6.04503010N
(x2)
TAPPING SCREW -
M3X10

U001	U002	U003	U004	U005	U006	U007	U008	U009	U010	U011	U012	U013	U014	U015	U016	U017	U018	U019	U020	U021
------	------	------	------	------	------	------	------	------	------	------	------	------	------	------	------	------	------	------	------	------

U007_S012
PUMP UNIT:TONER SUPPLY:ASS'Y

1.03530030N
(x2)
SCREW:M3X3

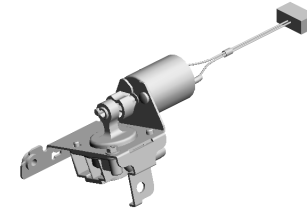

83.D1943450
PUMP UNIT:TONER
SUPPLY:ASS'Y

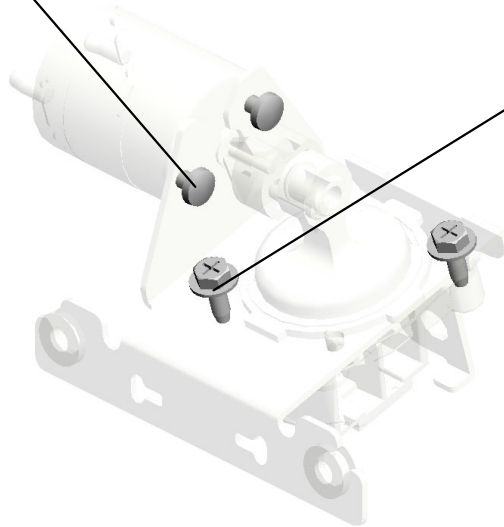

6.04503010N
(x2)
TAPPING SCREW -
M3X10

U001	U002	U003	U004	U005	U006	U007	U008	U009	U010	U011	U012	U013	U014	U015	U016	U017	U018	U019	U020	U021
------	------	------	------	------	------	------	------	------	------	------	------	------	------	------	------	------	------	------	------	------

U007_S013
TONER BANK:ASS'Y

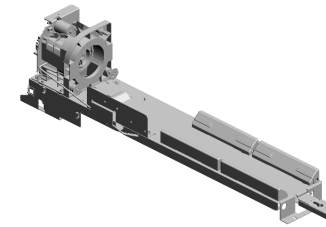

174-D1943546

[A]
TONER BANK:ASS'
Y
201909-03 O/O

- 25.11050551 CLAMP:LES-0505
- 29.11050760 (x3) CLAMP:LWSM-051A
- 17.04583010N (x6) HEXAGON HEAD TAPPING SCREW:3X10
- 1.03530030N (x2) SCREW:M3X3
- 2.03530080N SCREW:M3X8

27.11050723
CLAMPS:WES-0507

9.04513008N
(x8) TAPPING SCREW - M3X8

28.11050758
(x3) CLAMP:LWSM-0306A

24.11050518
EDGE SADDLE - LES-1010

16.04583008N
(x3) HEXAGON HEAD TAPPING SCREW:3X8

18.07200040E
(x8) RETAINING RING - M4

35.AA060811
TENSION SPRING - STOPPER

37.AA066320
FEELER TORTION SPRING

14.04544006Q
(x3) TAPPING SCREW: 4X6

34.A2943454
LEVER STOPPER

38.AA082101
(x2) BUSHING - 6X10X6

10.04514008N
(x4) TAPPING SCREW: 4X8

33.A2943447
TONER BOTTLE SET FEELER

36.AA060812
LEVER TENSION SPRING

12.04524008N
TAPPING SCREW: M4X8

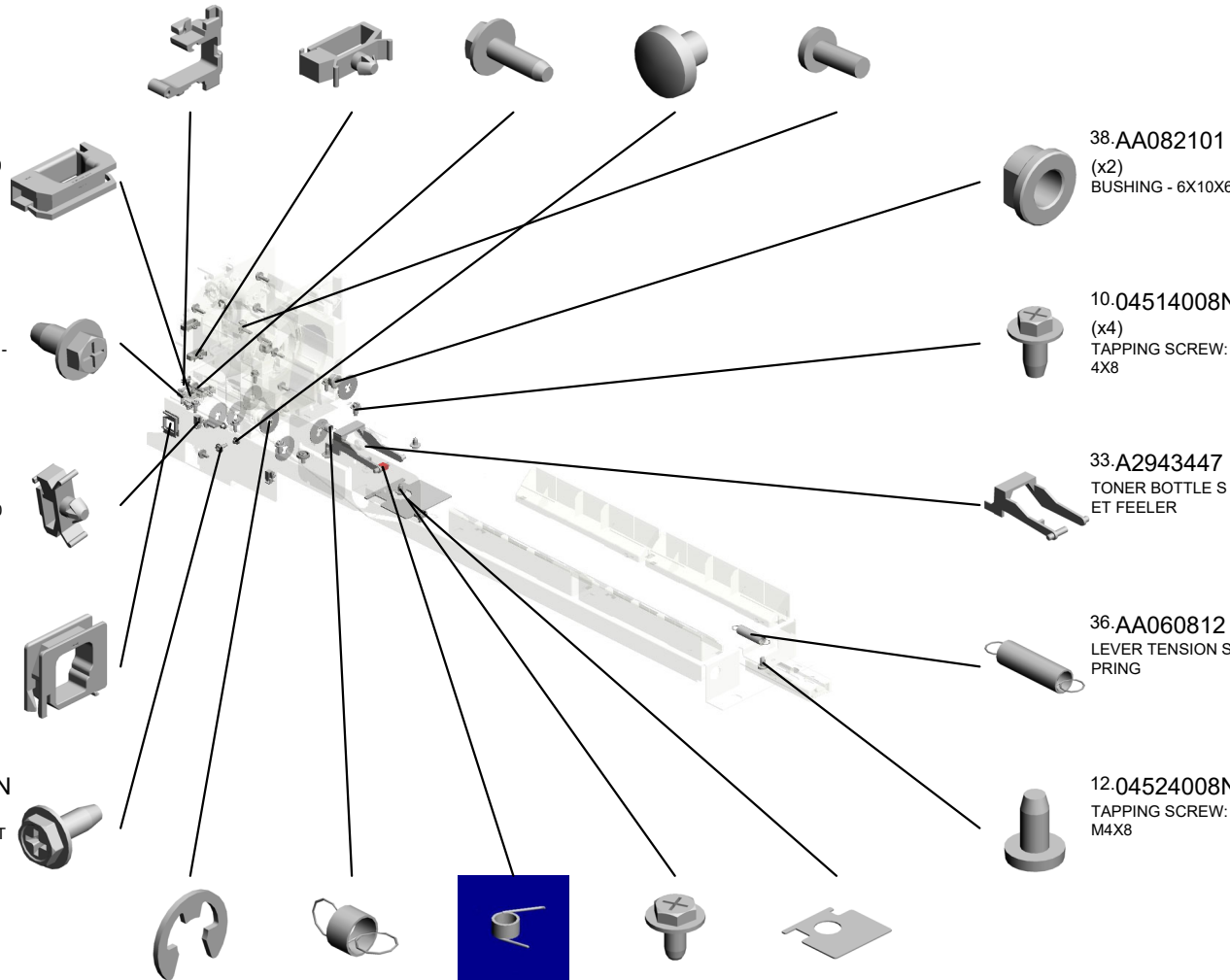

U007_S013
TONER BANK:ASS'Y

- 47.AB017515 DOUBLE GEAR - 1 2/23Z
- 93.D1943599 GEAR:RACK:Z12:Z 35
- 56.D0393368 (x2) SCREW:M3X3.5
- 157.B2343356 JOINT:CHUCK:TON ER BOTTLE
- 103.D1943632 DC MOTOR:SLIDE R:TONER BANK:AS S'Y:4.2W:BRUSH

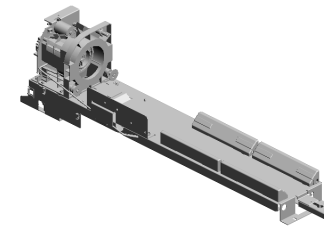

- 174.D1943546
- [A] TONER BANK:ASS' Y
- 201909-03 O/O

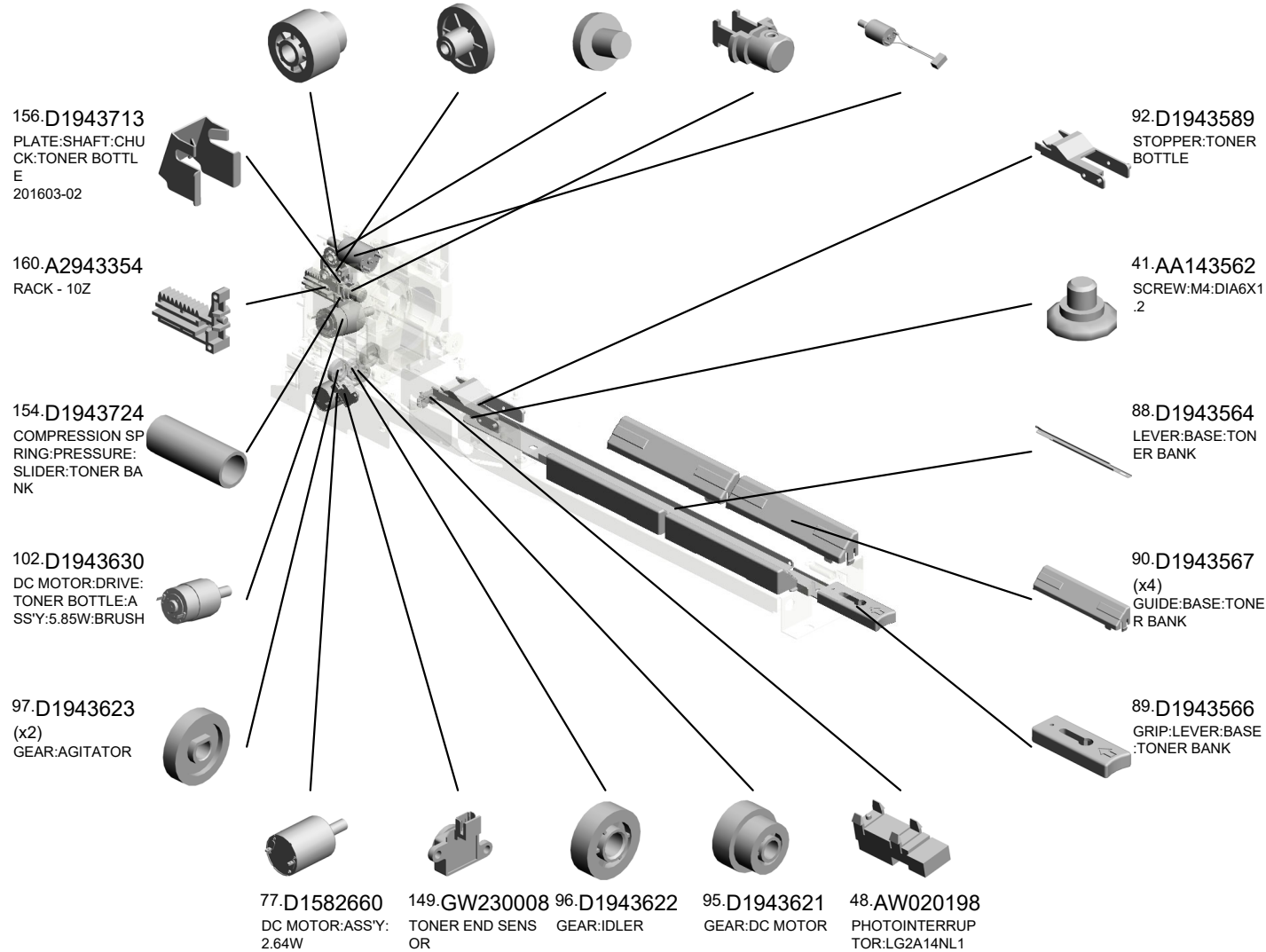

U007_S013
 TONER BANK:ASS'Y

165.D1943712 170.D1943707
 HOLDER:HOOK:CA SLIDER:TONER BA
 P:TONER BOTTLE NK

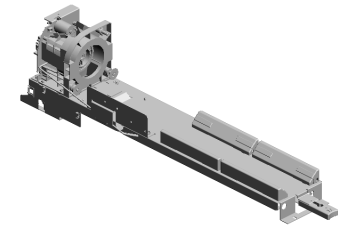

174.D1943546
 [A]
 TONER BANK:ASS'
 Y
 201909-03 O/O

169.D0A53588
 BRACKET:RACK:S
 TOPPER
 201812-12

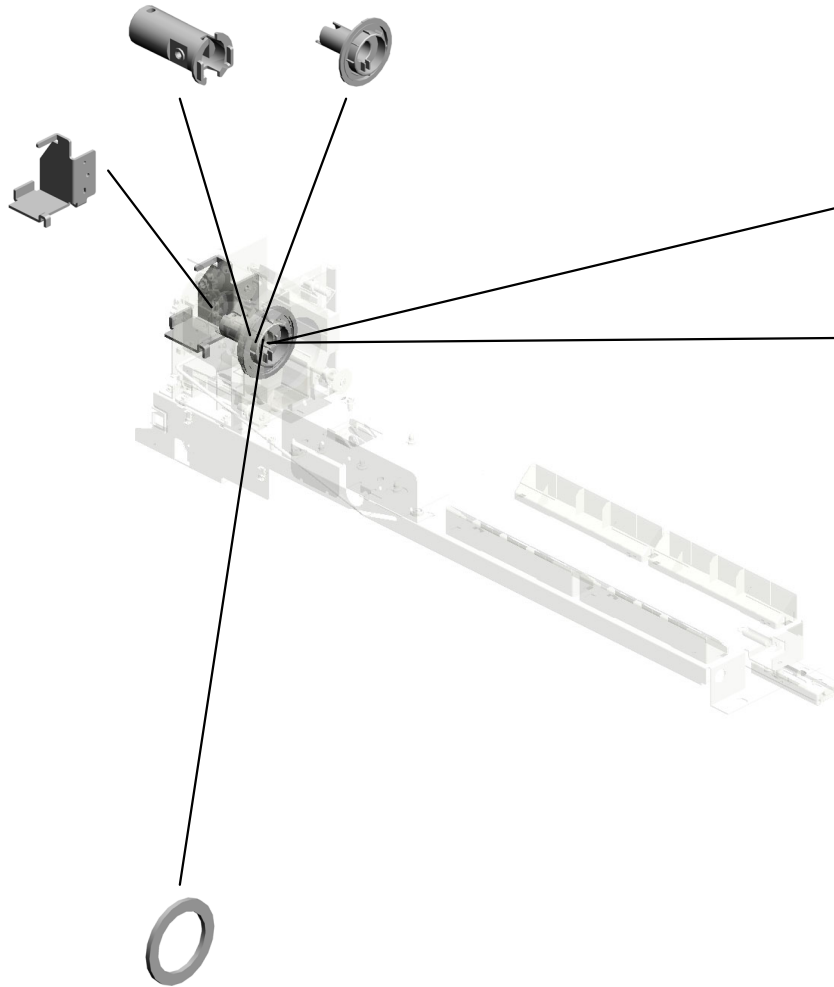

172.D1943709
 SEAL:OUTER:SLID
 ER:TONER BANK

171.D1943708
 SEAL:INNER:SLIDE
 R:TONER BANK

173.D0A53710
 SEAL:REAR:SLIDE
 R:TONER BANK:T6

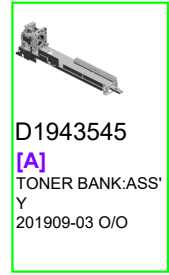

D1943545
 [A]
 TONER BANK:ASS'
 Y
 201909-03 O/O

U001	U002	U003	U004	U005	U006	U007	U008	U009	U010	U011	U012	U013	U014	U015	U016	U017	U018	U019	U020	U021
------	------	------	------	------	------	------	------	------	------	------	------	------	------	------	------	------	------	------	------	------

U007_S014
COVER:GEAR:TONER BOTTLE:ASS'Y

13.04543006Q (x6)
TAPPING SCREW - M3X6

117.D1943752
COVER:GEAR:TONER BOTTLE:RIGHT UPPER

111.D1943677
COVER:GEAR:TONER BOTTLE:ASS'Y

118.D1943753
COVER:GEAR:TONER BOTTLE:RIGHT LOWER

51.B0044438
BUSHING

119.D1943754
COVER:GEAR:TONER BOTTLE:LEFT LOWER

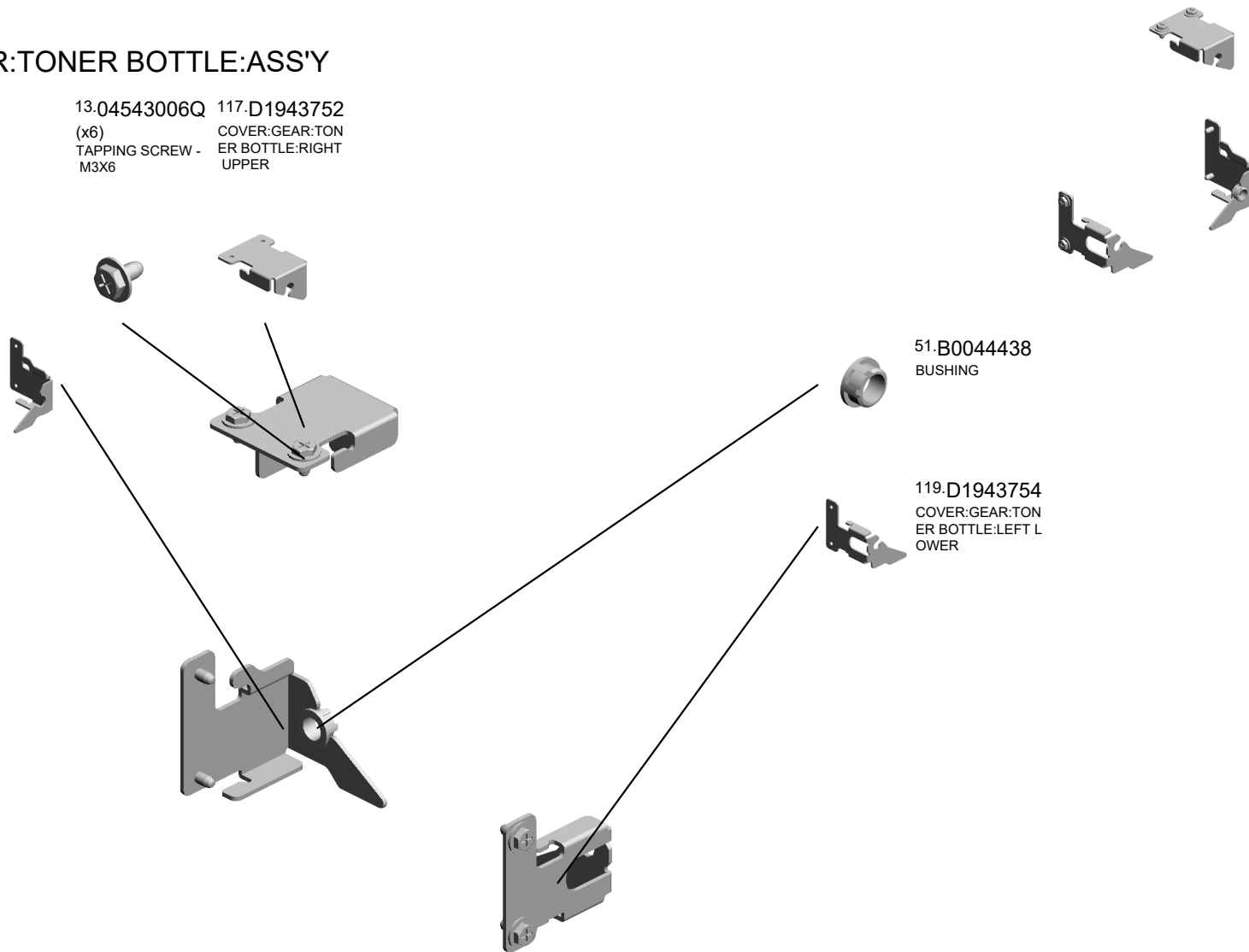

U001	U002	U003	U004	U005	U006	U007	U008	U009	U010	U011	U012	U013	U014	U015	U016	U017	U018	U019	U020	U021
------	------	------	------	------	------	------	------	------	------	------	------	------	------	------	------	------	------	------	------	------

U007_S015
TONER BANK:ASS'Y

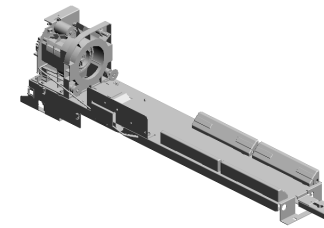

174-D1943546

[A]
TONER BANK:ASS'
Y
201909-03 O/O

- 25.11050551 CLAMP:LES-0505
- 29.11050760 (x3) CLAMP:LWSM-051A
- 17.04583010N (x6) HEXAGON HEAD TAPPING SCREW:3X10
- 1.03530030N (x2) SCREW:M3X3
- 2.03530080N SCREW:M3X8

27.11050723
CLAMPS:WES-0507

9.04513008N
(x8) TAPPING SCREW - M3X8

28.11050758
(x3) CLAMP:LWSM-0306A

24.11050518
EDGE SADDLE - LES-1010

16.04583008N
(x3) HEXAGON HEAD TAPPING SCREW:3X8

18.07200040E
(x8) RETAINING RING - M4

35.AA060811
TENSION SPRING - STOPPER

37.AA066320
FEELER TORTION SPRING

14.04544006Q
(x3) TAPPING SCREW: 4X6

34.A2943454
LEVER STOPPER

38.AA082101
(x2) BUSHING - 6X10X6

10.04514008N
(x4) TAPPING SCREW: 4X8

33.A2943447
TONER BOTTLE SET FEELER

36.AA060812
LEVER TENSION SPRING

12.04524008N
TAPPING SCREW: M4X8

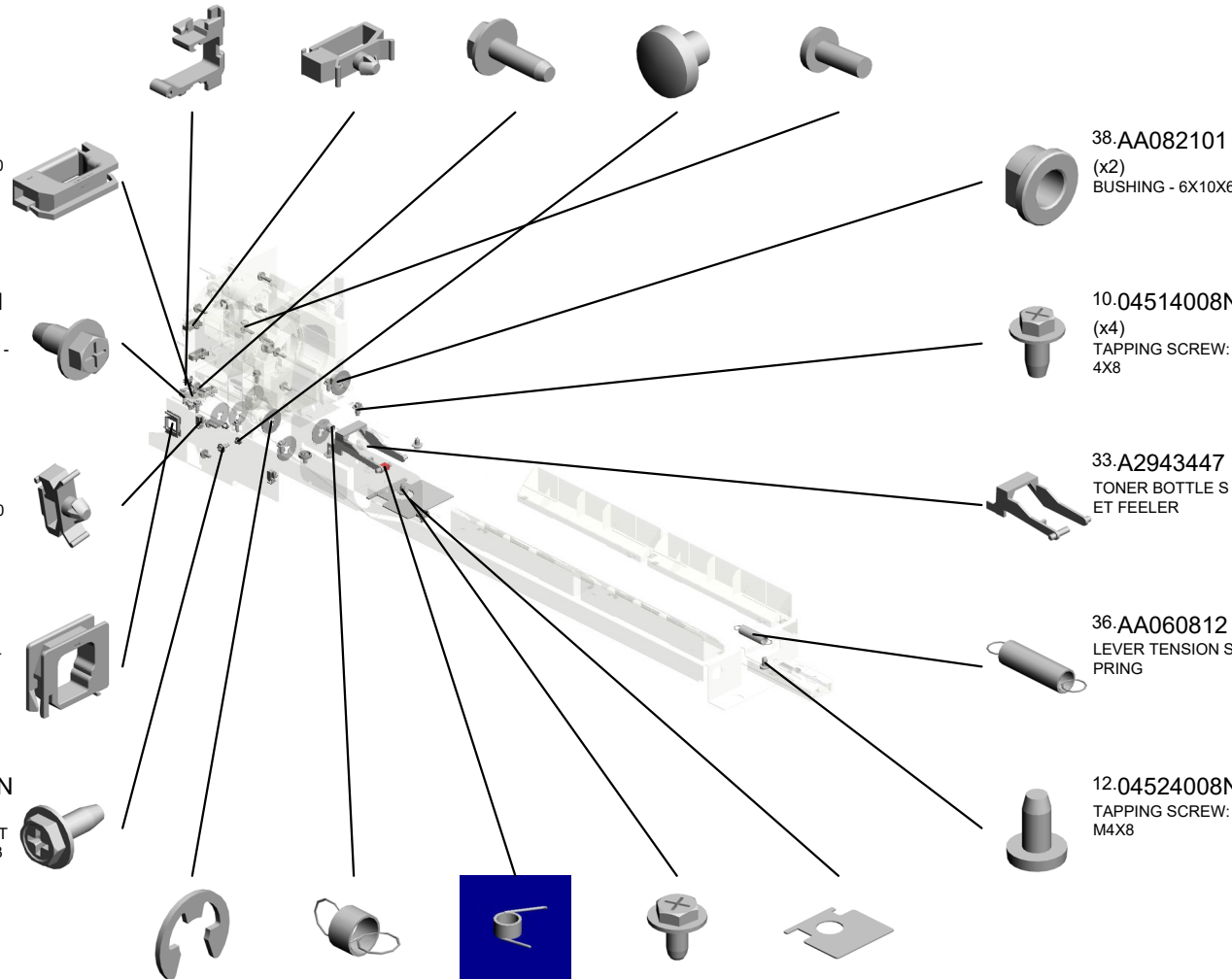

U007_S015
TONER BANK:ASS'Y

- 47.AB017515 DOUBLE GEAR - 1 2/23Z
- 93.D1943599 GEAR:RACK:Z12:Z 35
- 56.D0393368 (x2) SCREW:M3X3.5
- 157.B2343356 JOINT:CHUCK:TON ER BOTTLE
- 103.D1943632 DC MOTOR:SLIDE R:TONER BANK:AS S'Y:4.2W:BRUSH

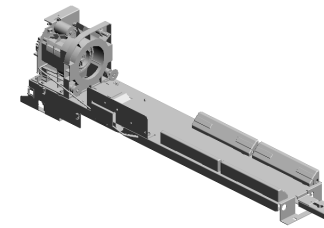

- 174.D1943546
- [A] TONER BANK:ASS' Y
- 201909-03 O/O

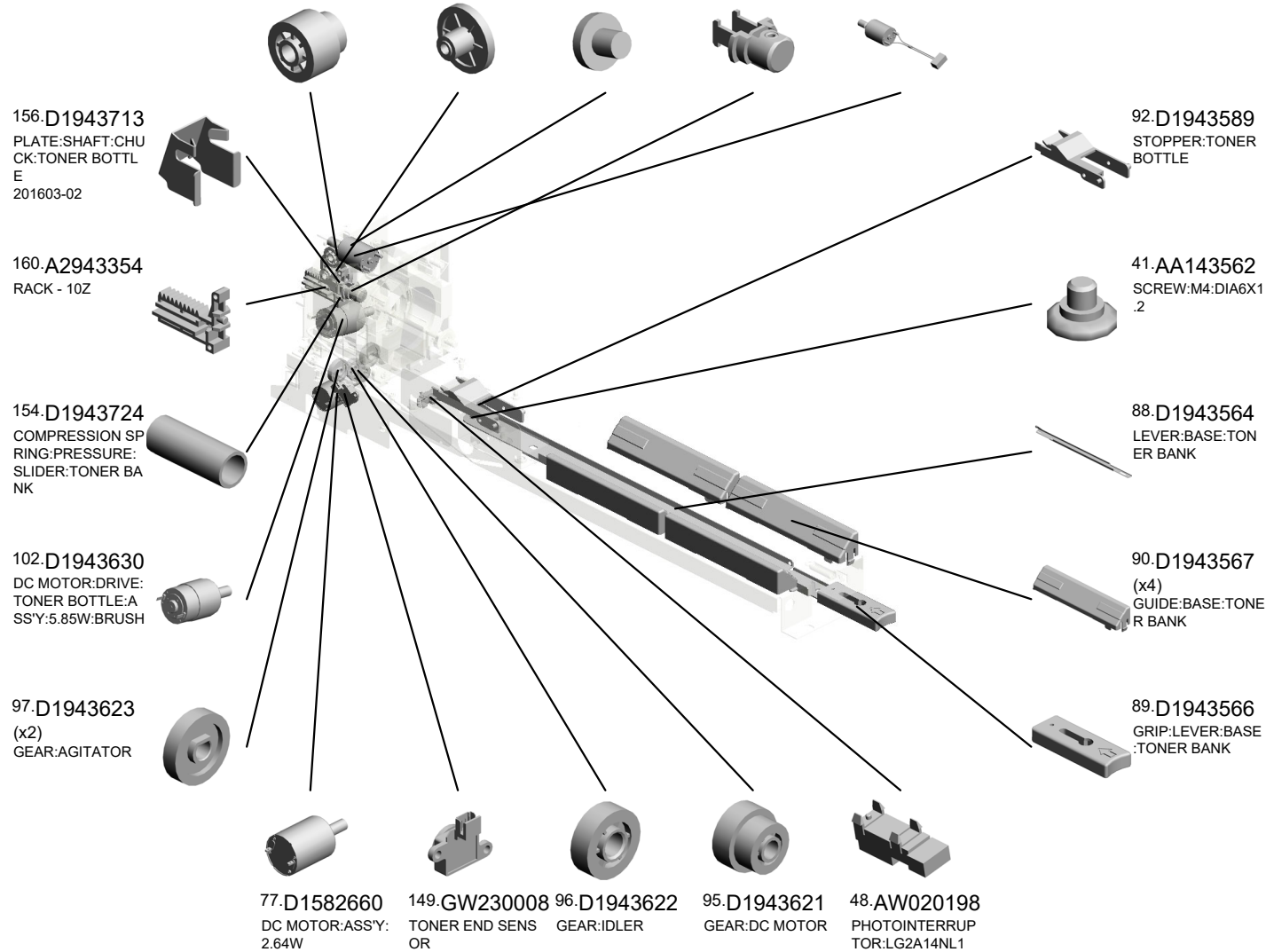

U007_S015
 TONER BANK:ASS'Y

165.D1943712 170.D1943707
 HOLDER:HOOK:CA SLIDER:TONER BA
 P:TONER BOTTLE NK

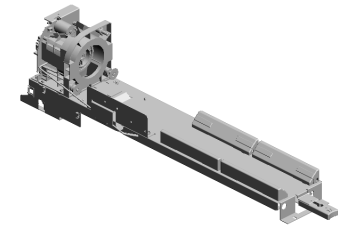

174.D1943546
 [A]
 TONER BANK:ASS'
 Y
 201909-03 O/O

169.D0A53588
 BRACKET:RACK:S
 TOPPER
 201812-12

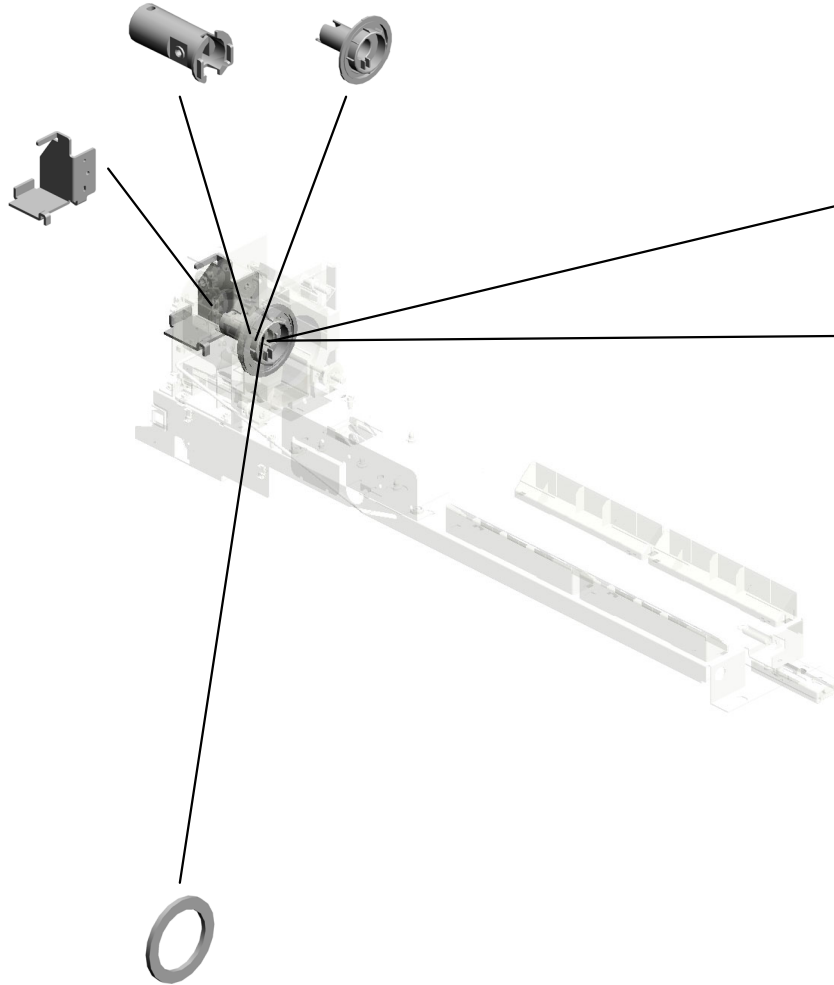

172.D1943709
 SEAL:OUTER:SLID
 ER:TONER BANK

171.D1943708
 SEAL:INNER:SLIDE
 R:TONER BANK

173.D0A53710
 SEAL:REAR:SLIDE
 R:TONER BANK:T6

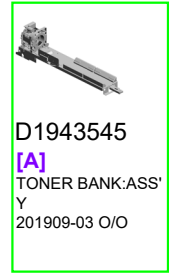

D1943545
 [A]
 TONER BANK:ASS'
 Y
 201909-03 O/O

U001	U002	U003	U004	U005	U006	U007	U008	U009	U010	U011	U012	U013	U014	U015	U016	U017	U018	U019	U020	U021
------	------	------	------	------	------	------	------	------	------	------	------	------	------	------	------	------	------	------	------	------

U007_S016
COVER:GEAR:TONER BOTTLE:ASS'Y

13.04543006Q (x6)
TAPPING SCREW - M3X6

117.D1943752
COVER:GEAR:TONER BOTTLE:RIGHT UPPER

111.D1943677
COVER:GEAR:TONER BOTTLE:ASS'Y

118.D1943753
COVER:GEAR:TONER BOTTLE:RIGHT LOWER

51.B0044438
BUSHING

119.D1943754
COVER:GEAR:TONER BOTTLE:LEFT LOWER

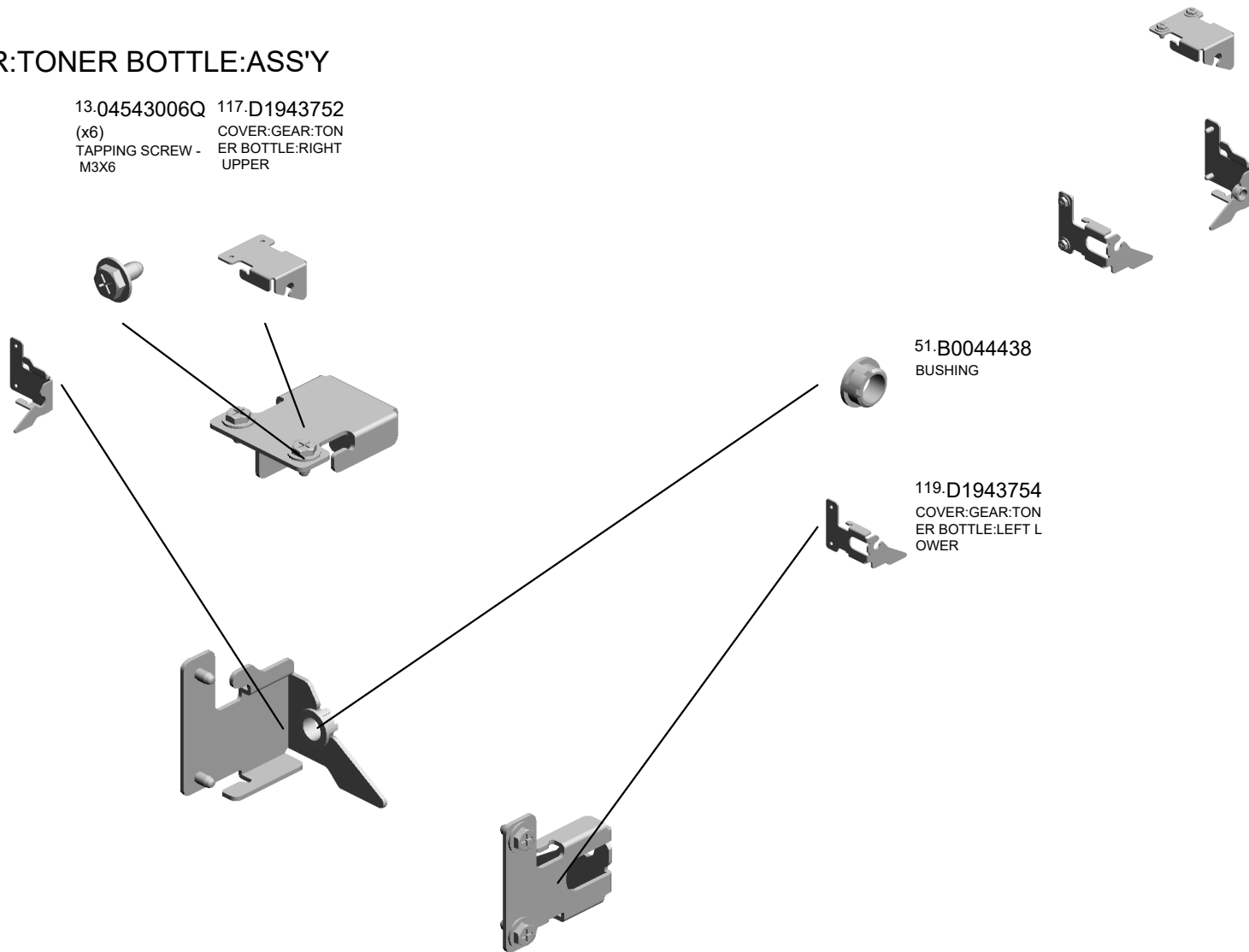

U001	U002	U003	U004	U005	U006	U007	U008	U009	U010	U011	U012	U013	U014	U015	U016	U017	U018	U019	U020	U021
------	------	------	------	------	------	------	------	------	------	------	------	------	------	------	------	------	------	------	------	------

U007_S017
TONER BANK:ASS'Y

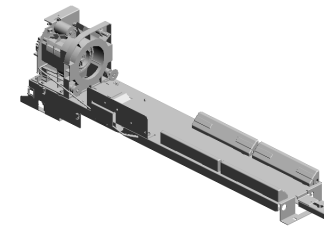

174-D1943546

[A]
TONER BANK:ASS'
Y
201909-03 O/O

- 25.11050551 CLAMP:LES-0505
- 29.11050760 (x3) CLAMP:LWSM-051A
- 17.04583010N (x6) HEXAGON HEAD TAPPING SCREW:3X10
- 1.03530030N (x2) SCREW:M3X3
- 2.03530080N SCREW:M3X8

27.11050723
CLAMPS:WES-0507

9.04513008N
(x8) TAPPING SCREW - M3X8

28.11050758
(x3) CLAMP:LWSM-0306A

24.11050518
EDGE SADDLE - LES-1010

16.04583008N
(x3) HEXAGON HEAD TAPPING SCREW:3X8

18.07200040E
(x8) RETAINING RING - M4

35.AA060811
TENSION SPRING - STOPPER

37.AA066320
FEELER TORTION SPRING

14.04544006Q
(x3) TAPPING SCREW: 4X6

34.A2943454
LEVER STOPPER

38.AA082101
(x2) BUSHING - 6X10X6

10.04514008N
(x4) TAPPING SCREW: 4X8

33.A2943447
TONER BOTTLE SET FEELER

36.AA060812
LEVER TENSION SPRING

12.04524008N
TAPPING SCREW: M4X8

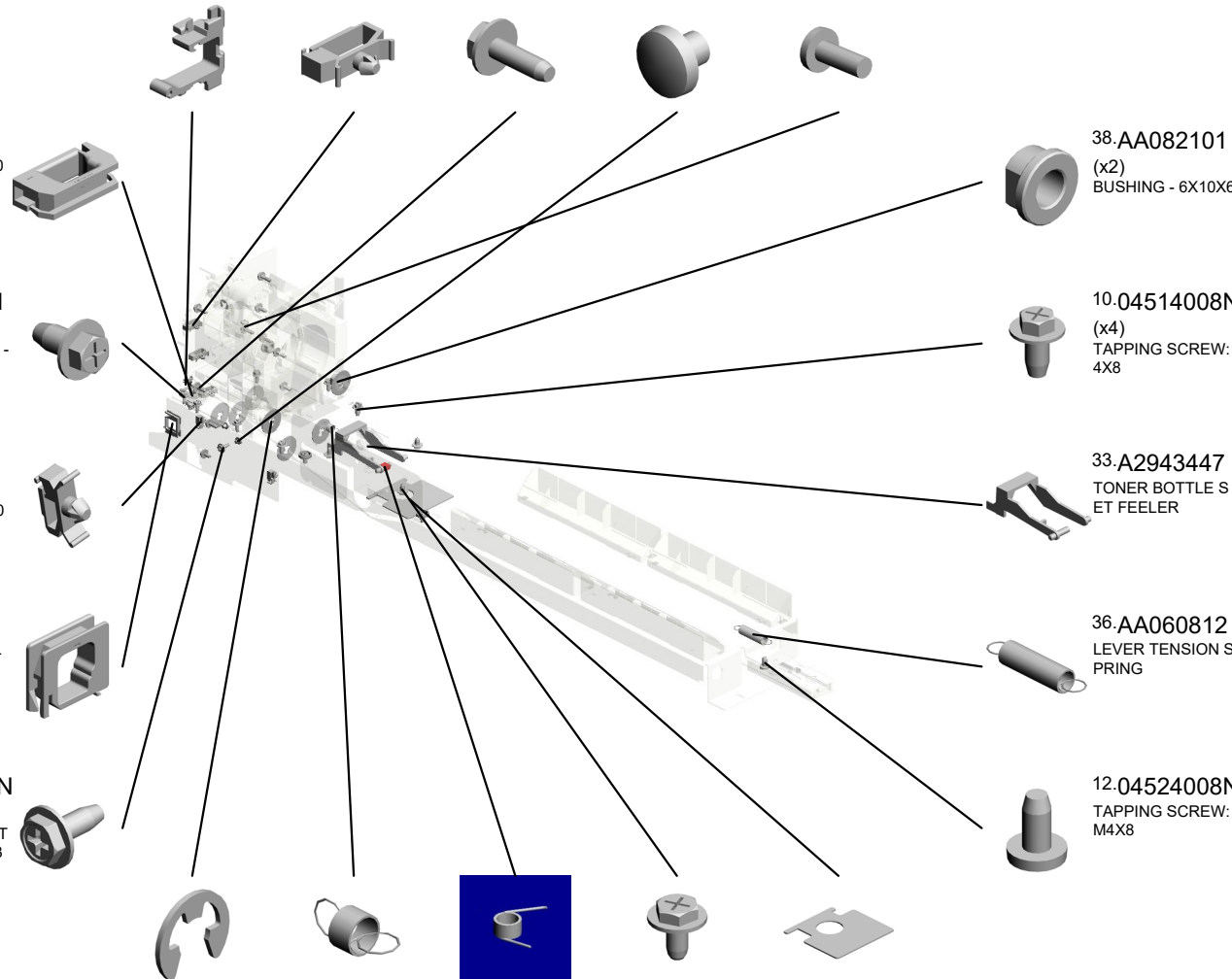

U007_S017
TONER BANK:ASS'Y

- 47.AB017515 DOUBLE GEAR - 1 2/23Z
- 93.D1943599 GEAR:RACK:Z12:Z 35
- 56.D0393368 (x2) SCREW:M3X3.5
- 157.B2343356 JOINT:CHUCK:TON ER BOTTLE
- 103.D1943632 DC MOTOR:SLIDE R:TONER BANK:AS S'Y:4.2W:BRUSH

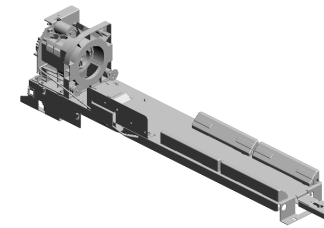

- 174.D1943546 [A] TONER BANK:ASS' Y 201909-03 O/O

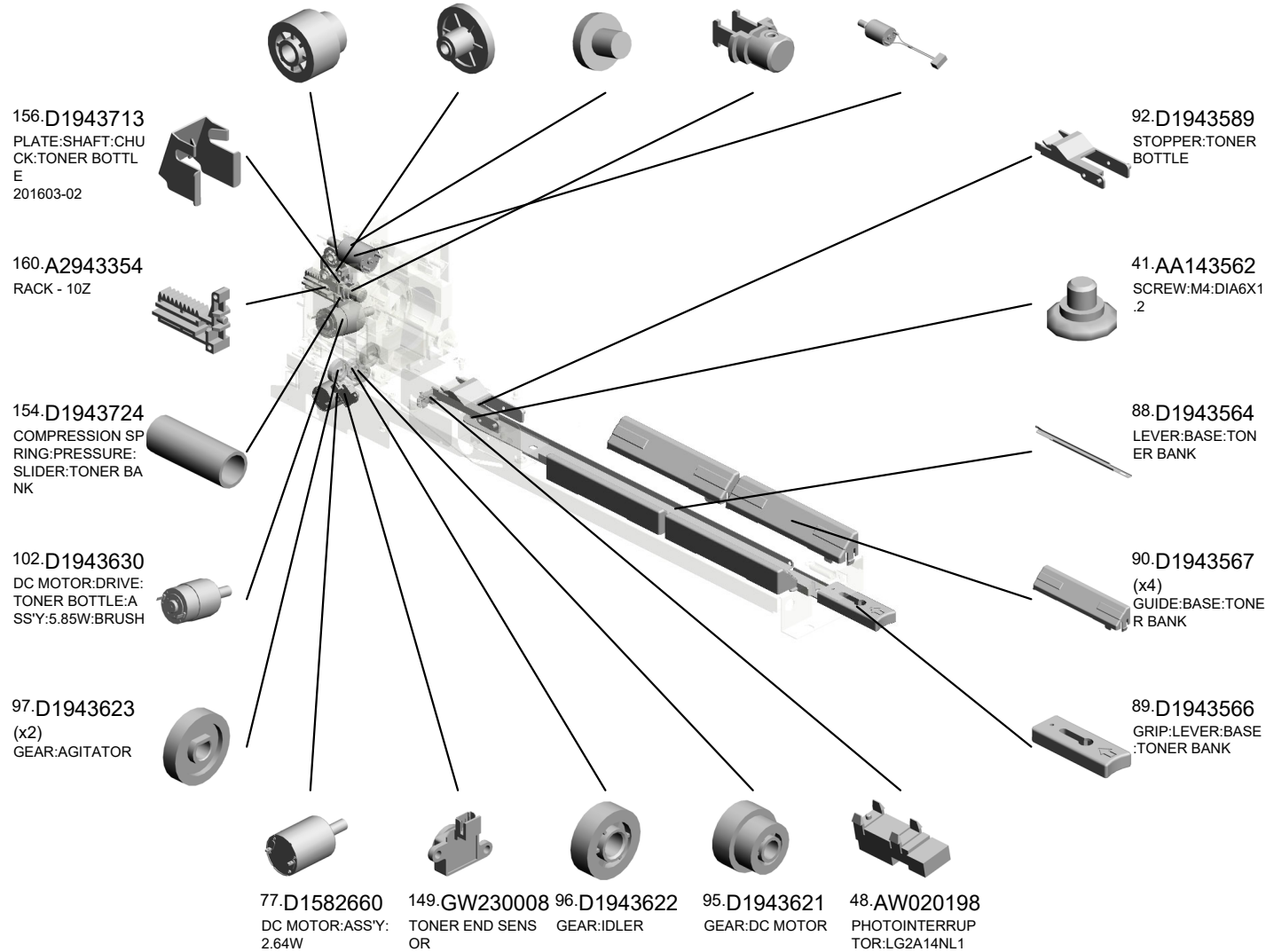

U007_S017
 TONER BANK:ASS'Y

165.D1943712 170.D1943707
 HOLDER:HOOK:CA SLIDER:TONER BA
 P:TONER BOTTLE NK

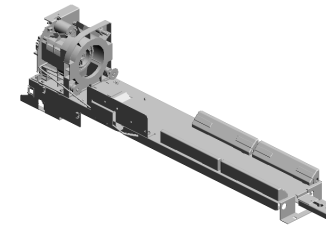

174.D1943546
 [A]
 TONER BANK:ASS'
 Y
 201909-03 O/O

169.D0A53588
 BRACKET:RACK:S
 TOPPER
 201812-12

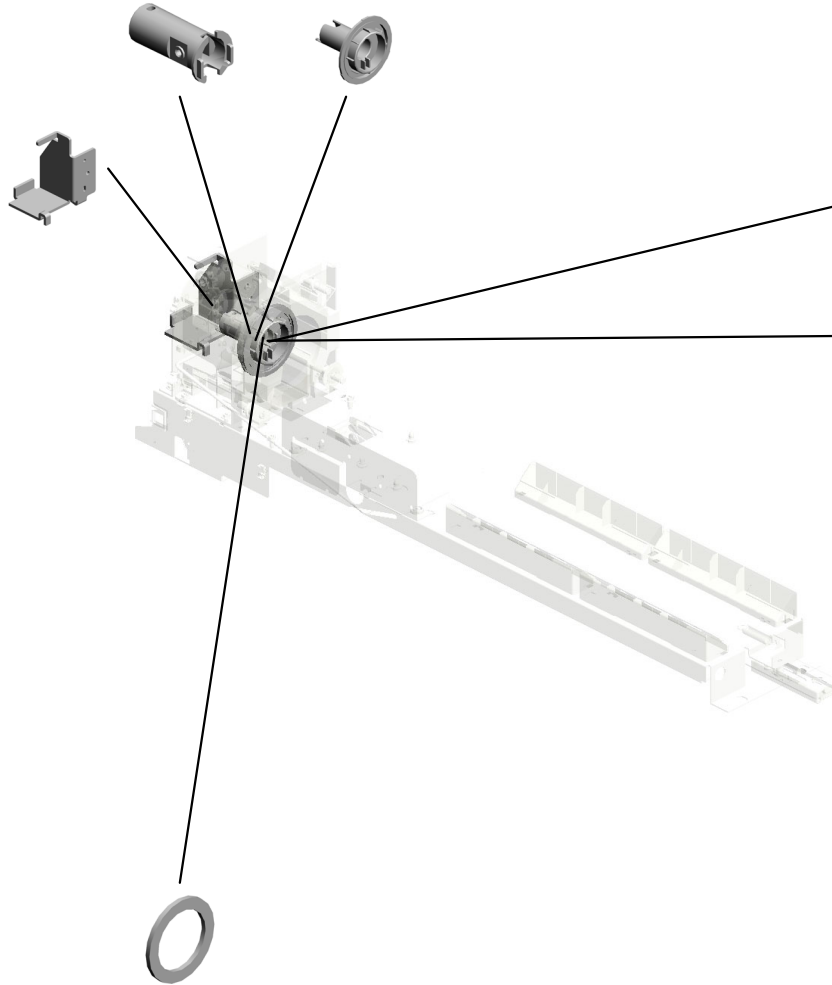

172.D1943709
 SEAL:OUTER:SLID
 ER:TONER BANK

171.D1943708
 SEAL:INNER:SLIDE
 R:TONER BANK

173.D0A53710
 SEAL:REAR:SLIDE
 R:TONER BANK:T6



D1943545
 [A]
 TONER BANK:ASS'
 Y
 201909-03 O/O

U007_S018
COVER:GEAR:TONER BOTTLE:ASS'Y

13.04543006Q (x6)
TAPPING SCREW - M3X6
117.D1943752
COVER:GEAR:TONER BOTTLE:RIGHT UPPER

111.D1943677
COVER:GEAR:TONER BOTTLE:ASS'Y

118.D1943753
COVER:GEAR:TONER BOTTLE:RIGHT LOWER

51.B0044438
BUSHING

119.D1943754
COVER:GEAR:TONER BOTTLE:LEFT LOWER

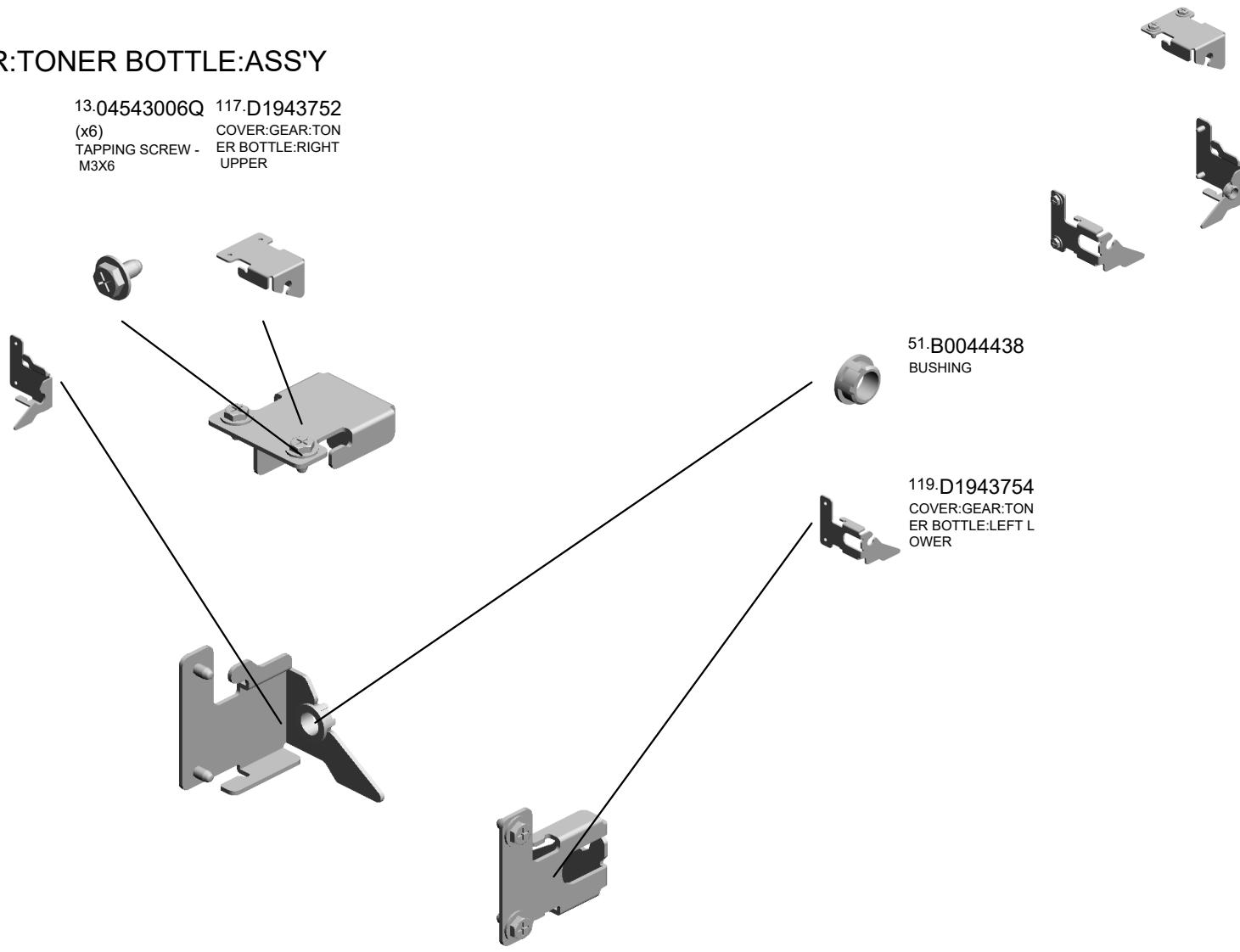

U001	U002	U003	U004	U005	U006	U007	U008	U009	U010	U011	U012	U013	U014	U015	U016	U017	U018	U019	U020	U021
------	------	------	------	------	------	------	------	------	------	------	------	------	------	------	------	------	------	------	------	------

U007_S019
TONER BANK:ASS'Y

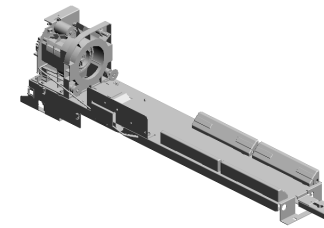

174-D1943546

[A]
TONER BANK:ASS'
Y
201909-03 O/O

- 25.11050551 CLAMP:LES-0505
- 29.11050760 (x3) CLAMP:LWSM-051A
- 17.04583010N (x6) HEXAGON HEAD TAPPING SCREW:3X10
- 1.03530030N (x2) SCREW:M3X3
- 2.03530080N SCREW:M3X8

27.11050723
CLAMPS:WES-0507

9.04513008N
(x8) TAPPING SCREW - M3X8

28.11050758
(x3) CLAMP:LWSM-0306A

24.11050518
EDGE SADDLE - LES-1010

16.04583008N
(x3) HEXAGON HEAD TAPPING SCREW:3X8

18.07200040E
(x8) RETAINING RING - M4

35.AA060811
TENSION SPRING - STOPPER

37.AA066320
FEELER TORTION SPRING

14.04544006Q
(x3) TAPPING SCREW: 4X6

34.A2943454
LEVER STOPPER

38.AA082101
(x2) BUSHING - 6X10X6

10.04514008N
(x4) TAPPING SCREW: 4X8

33.A2943447
TONER BOTTLE SET FEELER

36.AA060812
LEVER TENSION SPRING

12.04524008N
TAPPING SCREW: M4X8

U007_S019
TONER BANK:ASS'Y

- 47.AB017515 DOUBLE GEAR - 1 2/23Z
- 93.D1943599 GEAR:RACK:Z12:Z 35
- 56.D0393368 (x2) SCREW:M3X3.5
- 157.B2343356 JOINT:CHUCK:TON ER BOTTLE
- 103.D1943632 DC MOTOR:SLIDE R:TONER BANK:AS S'Y:4.2W:BRUSH

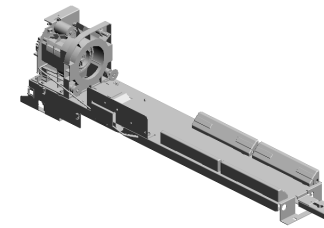

- 174.D1943546
- [A] TONER BANK:ASS' Y
- 201909-03 O/O

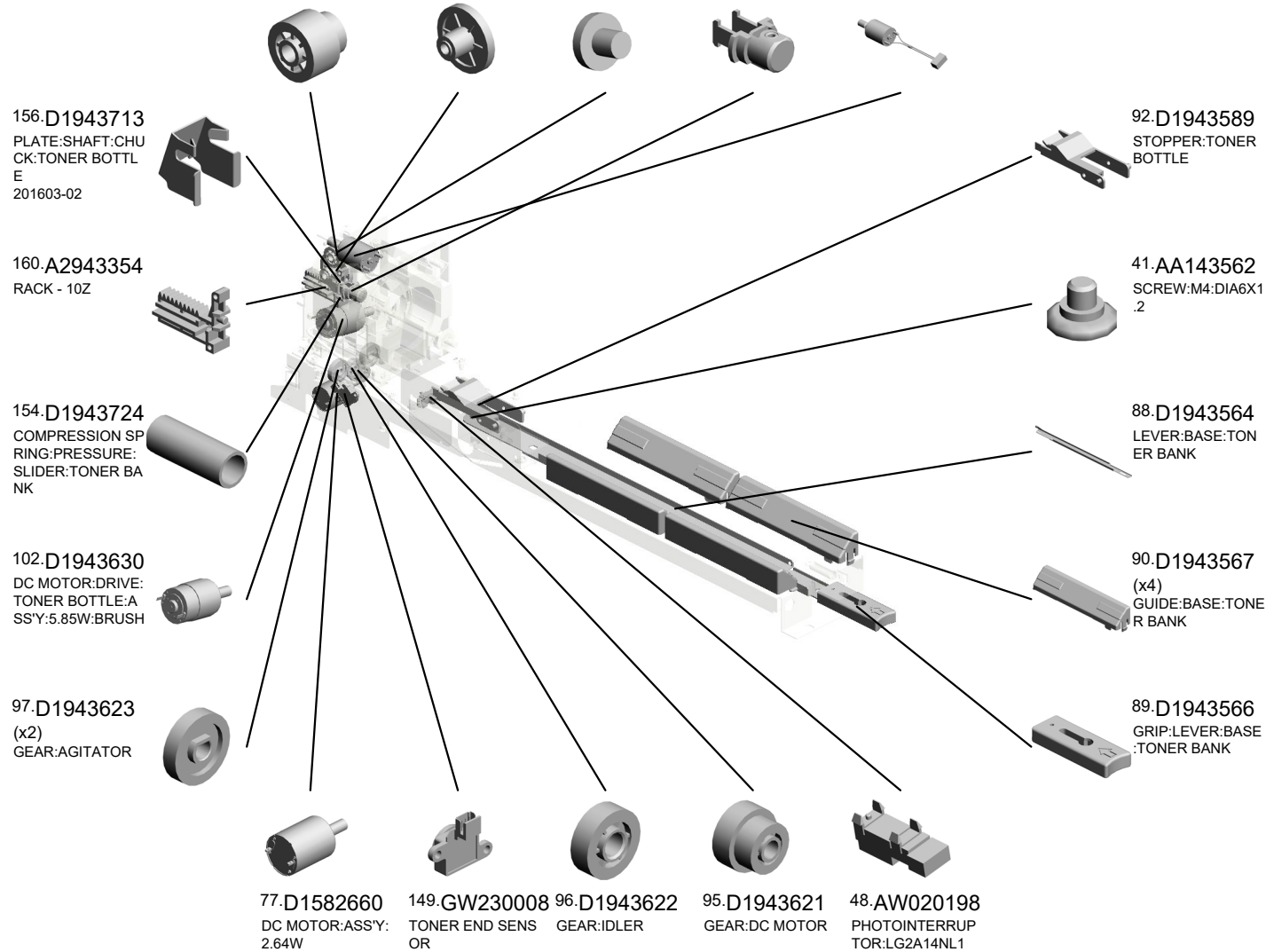

U007_S019
TONER BANK:ASS'Y

165.D1943712 170.D1943707
HOLDER:HOOK:CA SLIDER:TONER BA
P:TONER BOTTLE NK

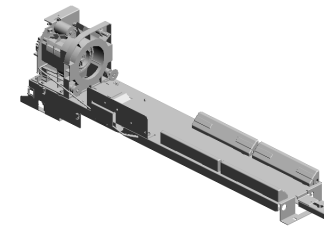

174.D1943546
[A]
TONER BANK:ASS'
Y
201909-03 O/O

169.D0A53588
BRACKET:RACK:S
TOPPER
201812-12

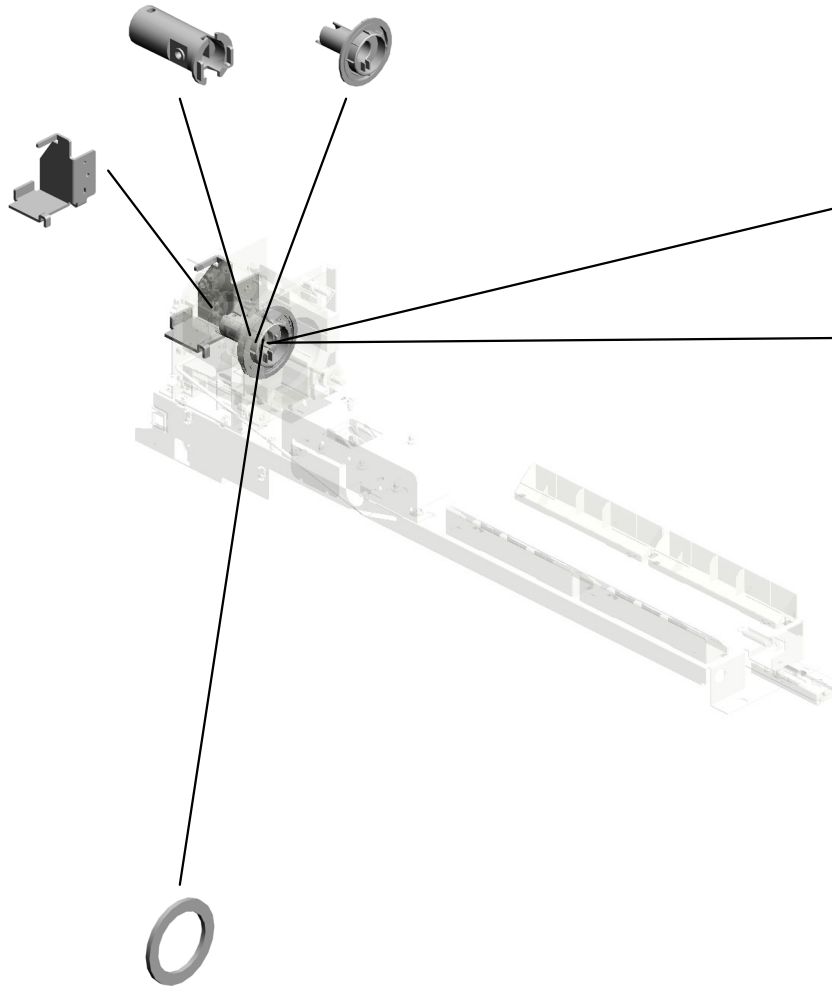

173.D0A53710
SEAL:REAR:SLIDE
R:TONER BANK:T6

172.D1943709
SEAL:OUTER:SLID
ER:TONER BANK

171.D1943708
SEAL:INNER:SLIDE
R:TONER BANK

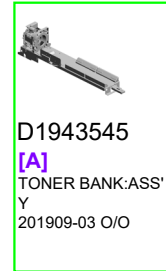

D1943545
[A]
TONER BANK:ASS'
Y
201909-03 O/O

U007_S020
COVER:GEAR:TONER BOTTLE:ASS'Y

13.04543006Q (x6)
TAPPING SCREW - M3X6
117.D1943752
COVER:GEAR:TONER BOTTLE:RIGHT UPPER

111.D1943677
COVER:GEAR:TONER BOTTLE:ASS'Y

118.D1943753
COVER:GEAR:TONER BOTTLE:RIGHT LOWER

51.B0044438
BUSHING

119.D1943754
COVER:GEAR:TONER BOTTLE:LEFT LOWER

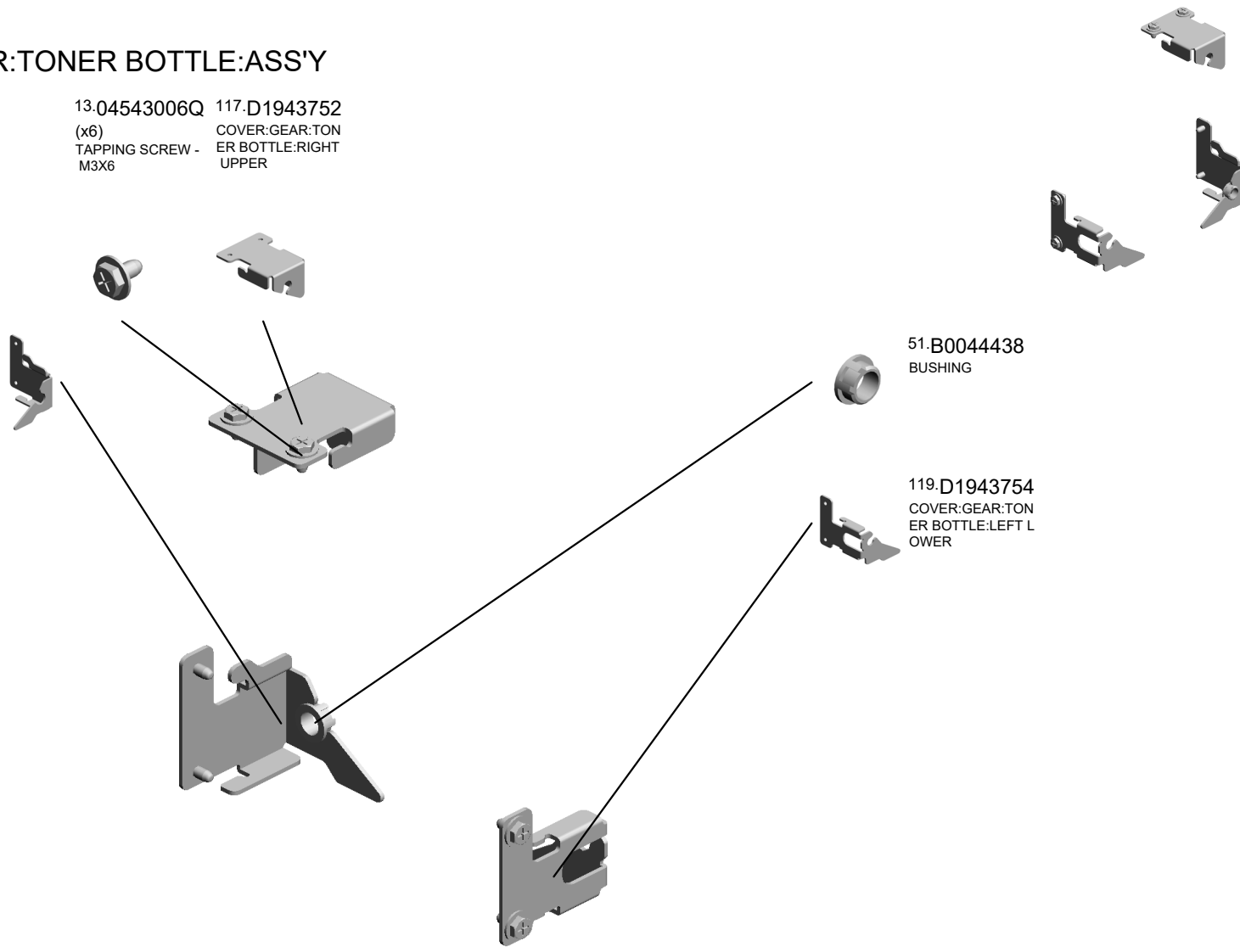

U001	U002	U003	U004	U005	U006	U007	U008	U009	U010	U011	U012	U013	U014	U015	U016	U017	U018	U019	U020	U021
------	------	------	------	------	------	------	------	------	------	------	------	------	------	------	------	------	------	------	------	------

U007_S021
 INNER COVER:TONER BANK:ASS'Y

107.D1943661 7.04504008N 71.D0743757
 DECAL:COLORED TAPPING SCREW - MAGNET CATCH P
 DISPLAY:TONER B M4X8 LEET:TONER SUP
 ANK:C PLY SUB-UNIT:UP
 PER

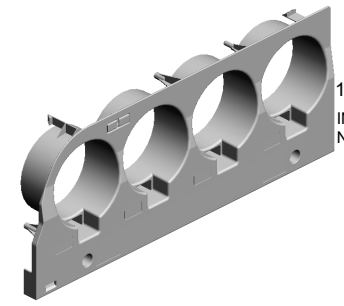

105.D1943655
 INNER COVER:TO
 NER BANK:ASS'Y

106.D1943660
 DECAL:COLORED
 DISPLAY:TONER B
 ANK:K

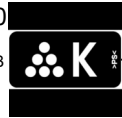

108.D1943662
 DECAL:COLORED
 DISPLAY:TONER B
 ANK:M



109.D1943663
 DECAL:COLORED
 DISPLAY:TONER B
 ANK:Y

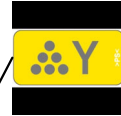

110.D1943664
 DECAL:OPERATE:
 TONER BOTTLE:4
 C

U001	U002	U003	U004	U005	U006	U007	U008	U009	U010	U011	U012	U013	U014	U015	U016	U017	U018	U019	U020	U021
------	------	------	------	------	------	------	------	------	------	------	------	------	------	------	------	------	------	------	------	------

U007_S022
COVER:HARNES:OPERATION SUB-UNIT:TONER BOTTLE:ASS'Y

166.D0A51160
SHEET:TONER SU
PPLY:OPERATION
SUB-UNIT
201807-03 X/X

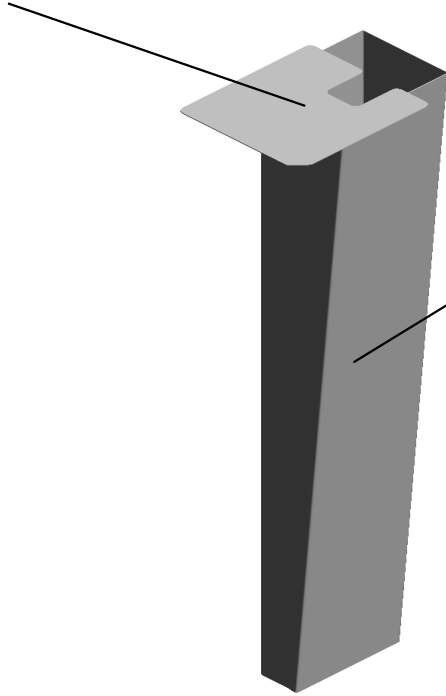

120.D1943755
COVER:HARNES:
OPERATION SUB-
UNIT:TONER BOTT
LE:RIGHT



80.D1943216
COVER:HARNES:
OPERATION SUB-
UNIT:TONER BOTT
LE:ASS'Y

U001	U002	U003	U004	U005	U006	U007	U008	U009	U010	U011	U012	U013	U014	U015	U016	U017	U018	U019	U020	U021
------	------	------	------	------	------	------	------	------	------	------	------	------	------	------	------	------	------	------	------	------

U007_S023
 (D203/D204):TONER HOPPER:TONER SUPPLY:5ST:ASS'Y

53.B1323373 (D203/D204):GEAR: TRANSPORT SCR
 EW:SUPPLY:LOWE
 R

32.54472681 SNAP RING

130.D2033471 (D203/D204)SHAFT: ELECTROMAGNET
 ELECTROMAGNET
 IC CLUTCH:DRIVE:
 TRANSPORT SCR
 EW:5ST

50.AX200323 ELECTROMAGNET
 IC CLUTCH:025NM:
 Z31:DIA6

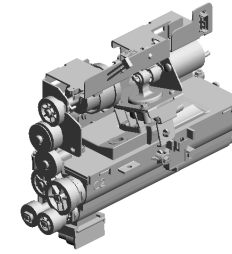

159.D2033429 (D203/D204):TONE
 R HOPPER:TONER
 SUPPLY:5ST:ASS'
 Y
 201701-06 X/X

13.04543006Q
 (x2)
 TAPPING SCREW -
 M3X6

43.AB011463
 (D203/D204):CONN
 ECTING GEAR

18.07200040E
 RETAINING RING -
 M4

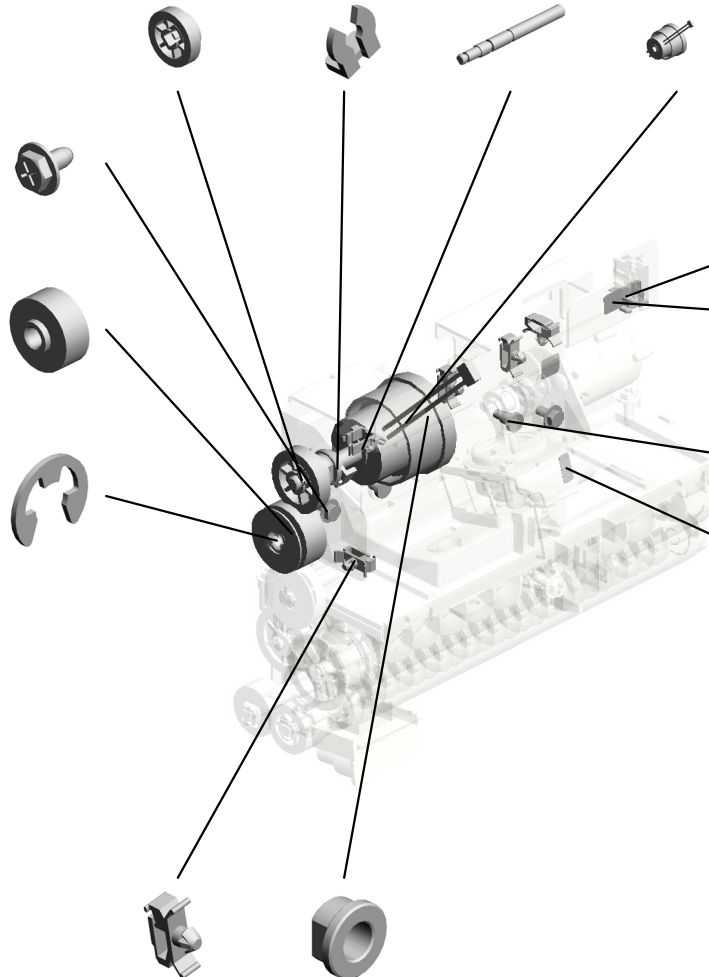

25.11050551
 (x2)
 CLAMP:LES-0505

26.11050600
 CLAMP:LWSM-030
 6-2M

76.D0746497
 (x3)
 DECAL:POSITIONI
 NG DISPLAY:TCRU

40.AA143544
 (x2)
 SCREW - M3

146.D2033710
 (x2)
 (D203/D204):DECA
 L:TCRU:PUMP:5ST

28.11050758
 (x4)
 CLAMP:LWSM-030
 6A

38.AA082101
 (x2)
 BUSHING - 6X10X6

U007_S023_S001
CASE:TONER HOPPER:TONER SUPPLY:FRONT:ASS'Y

149.GW230008 5.04503008N
TONER END SENS TAPPING SCREW -
OR M3X8

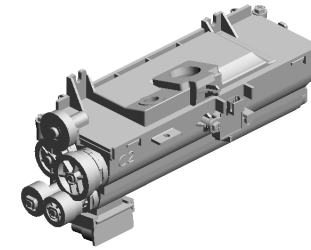

82.D1943441
CASE:TONER HOP
PER:TONER SUPP
LY:FRONT:ASS'Y

19.08050092
(x5)
RETAINING RING -
3M

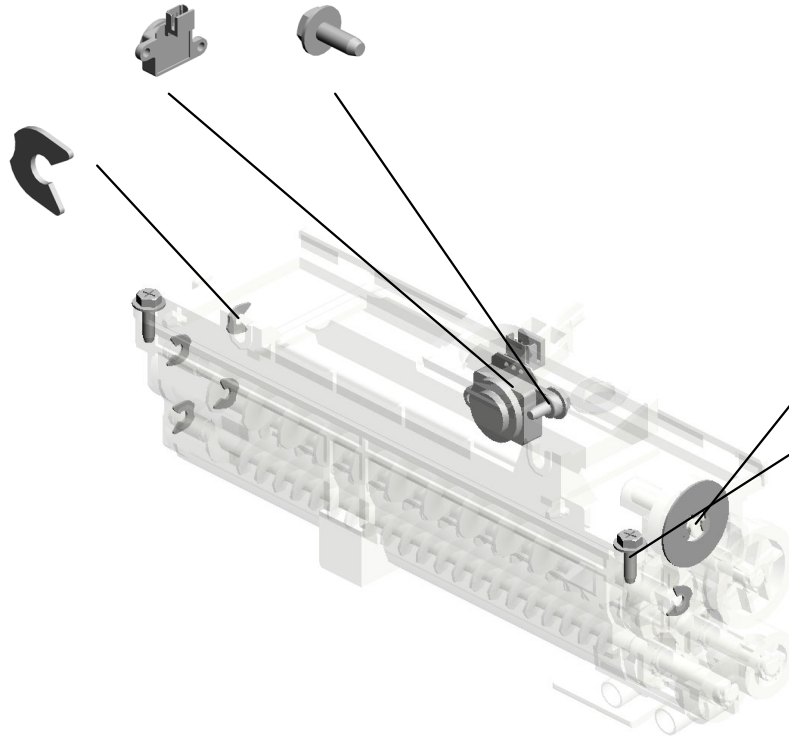

18.07200040E
RETAINING RING -
M4

6.04503010N
(x2)
TAPPING SCREW -
M3X10

U001	U002	U003	U004	U005	U006	U007	U008	U009	U010	U011	U012	U013	U014	U015	U016	U017	U018	U019	U020	U021
------	------	------	------	------	------	------	------	------	------	------	------	------	------	------	------	------	------	------	------	------

U007_S023_S002
PUMP UNIT:TONER SUPPLY:ASS'Y

1.03530030N
(x2)
SCREW:M3X3

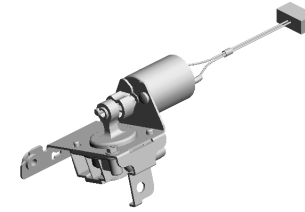

83.D1943450
PUMP UNIT:TONER
SUPPLY:ASS'Y

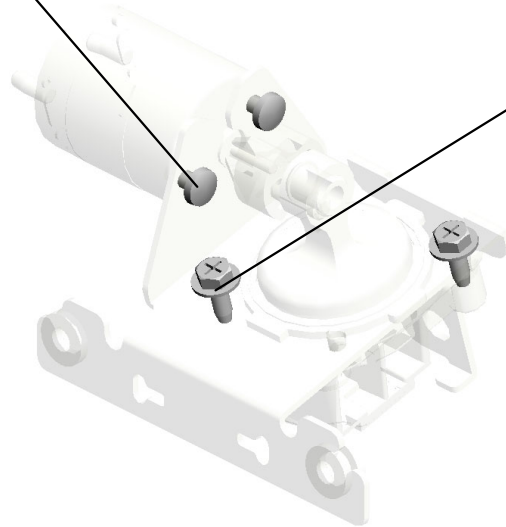

6.04503010N
(x2)
TAPPING SCREW -
M3X10

U001	U002	U003	U004	U005	U006	U007	U008	U009	U010	U011	U012	U013	U014	U015	U016	U017	U018	U019	U020	U021
------	------	------	------	------	------	------	------	------	------	------	------	------	------	------	------	------	------	------	------	------

U007_S024
(D203/D204):HOLDER:FRONT:TONER BOTTLE:5ST:ASS'Y

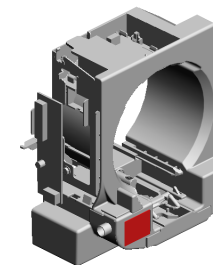

131.D2033500
(D203/D204):HOLD
ER:FRONT:TONER
BOTTLE:5ST:ASS'Y

68.D0743745 (D203/D204):SEAL:
HOLDER:STOPPE
R:RIGHT
6.04503010N (x8)
TAPPING SCREW -
M3X10
65.D0743741 (D203/D204):STOP
PER:SHUTTER:TO
NER CARTRIDGE:T
YPE A
67.D0743743 (D203/D204):SPRIN
G PLATE:STOPPE
R:SHUTTER:TYPE
B
25.11050551
CLAMP:LES-0505

74.D0743768
(x2)
(D203/D204):TENSIO
N SPRING:SHUT
TER:TONER SUPPL
Y UNIT

134.D2033507
(D203/D204):NOZZ
LE:TONER SUPPL
Y

64.D0743736
SEAL:NOZZLE:NOZ
ZLE COVER

54.B2233485
(D203/D204):SEAL:
HOLDER:STOPPE
R:SHUTTER:1

72.D0743763
(D203/D204):NOZZ
LE COVER:TONER
SUPPLY SUB-UNIT

135.D2033508 (D203/D204):COVE
R:HOLDER:FRONT:
TONER BOTTLE:5S
T
66.D0743742 (D203/D204):HOLD
ER:STOPPER:SHU
TTER:TYPE A
22.11050511 (x3)
HARNES CLAMP -
LWS-0306ZC
69.D0743746 (D203/D204):SEAL:
HOLDER:STOPPE
R:LEFT
3.03603006N
SCREW - M3X6

79.D1915150
(D203/D204):PCB:R
FID-CPU

133.D2033505
(D203/D204):LEVE
R:TONER BOTTLE:
5ST

48.AW020198
PHOTOINTERRUP
TOR:LG2A14NL1

73.D0743766
(D203/D204):PLATE
:COIL SPRING

70.D0743756
SEAL:BLOCK LIGH
T:LEVER

U007_S024
 (D203/D204):HOLDER:FRONT:TONER BOTTLE:5ST:ASS'Y

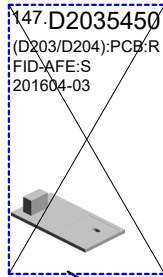

147.D2035450
 (D203/D204):PCB:R
 FID-AFE:S
 201604-03

150.D2035453
 (D203/D204):PCB:R
 FID-AFE:S
 201505-01

136.D2033509
 (D203/D204):INSUL
 ATING SHEET:PCB
 :RFID:CPU

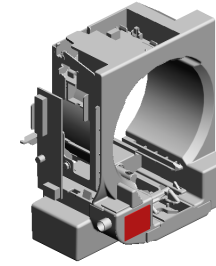

131.D2033500
 (D203/D204):HOLD
 ER:FRONT:TONER
 BOTTLE:5ST:ASS'Y

161.D0AL3502
 (D203/D204):HOLD
 ER:FRONT:TONER
 BOTTLE:5ST

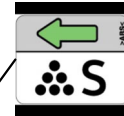

142.D2033530
 (D203/D204):DECA
 L:COLORED DISPL
 AY:TONER BANK:S

144.D2033540
 (D203/D204):COIL
 SPRING:LEVER:TO
 NER SUPPLY UNIT

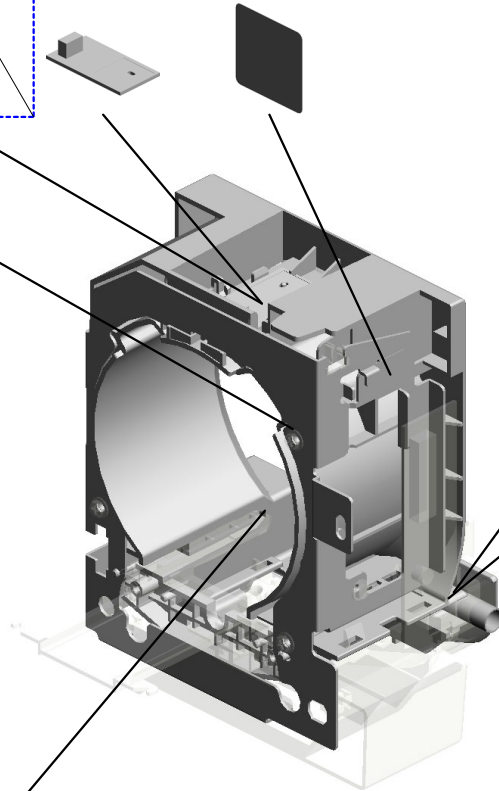

168.D0AL3503
 (D203/D204):BRAC
 KET:HOLDER:FRO
 NT:TONER BOTTL
 E
 201807-07 O/O

U001	U002	U003	U004	U005	U006	U007	U008	U009	U010	U011	U012	U013	U014	U015	U016	U017	U018	U019	U020	U021
------	------	------	------	------	------	------	------	------	------	------	------	------	------	------	------	------	------	------	------	------

U007_S025
(D203/D204):DRIVE UNIT:TONER BOTTLE:5ST:ASS'Y

22.11050511 (x2) HARNESS CLAMP - LWS-0306ZC
 102.D1943630 DC MOTOR:DRIVE: TONER BOTTLE:A SS'Y:5.85W:BRUSH
 60.D0743703 (D203/D204):GEAR: TONER BOTTLE:DI A92

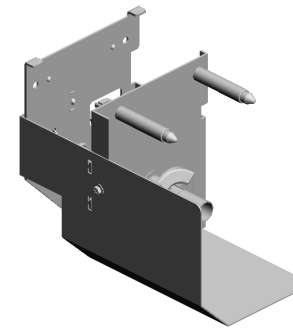

140.D2033521
 [A]
 (D203/D204):DRIVE UNIT:TONER BOT TLE:5ST:ASS'Y 201505-03 X/O

18.07200040E (x6) RETAINING RING - M4

46.AB012008 (D203/D204):GEAR - 23Z

15.04544008Q (x3) TAPPING SCREW - M4X8

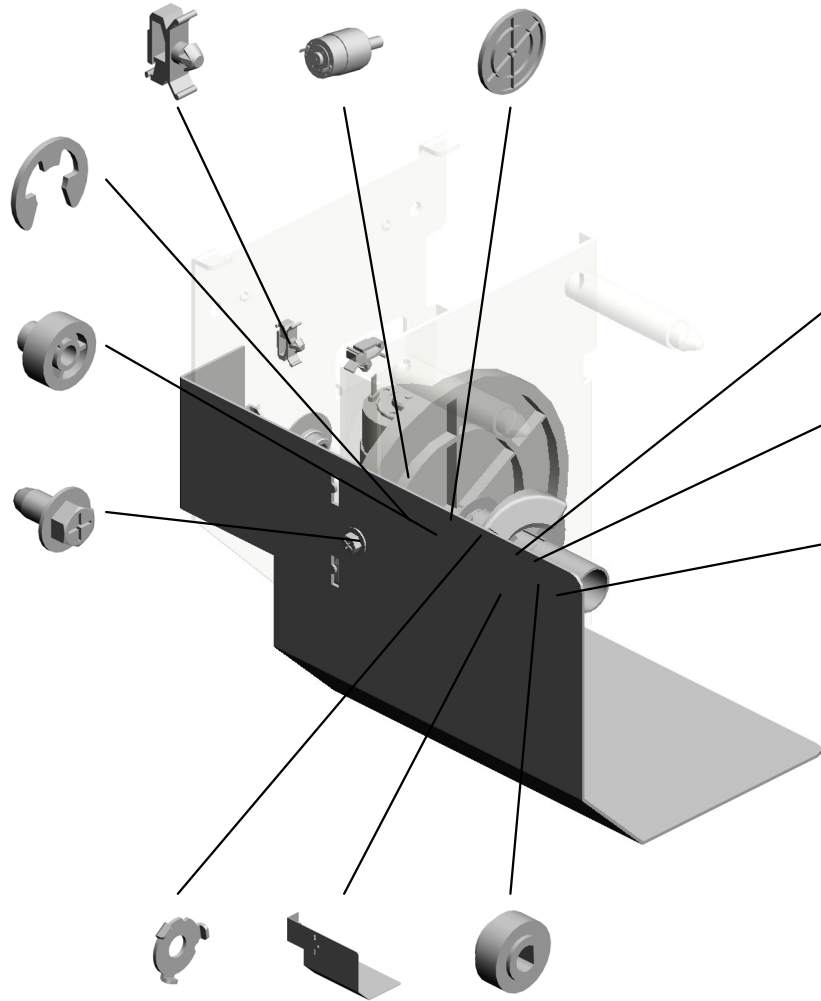

62.D0743721 (D203/D204):JOINT: DRIVE:TONER SUP PLY UNIT

63.D2033528 (D203/D204):COIL SPRING:DRIVE SUB-UNIT:TONER SUPPLY UNIT 201505-02 X/O

38.AA082101 (x4) BUSHING - 6X10X6

61.D0743708 (D203/D204):SPRING LOCK WASHER: DRIVE SUB-UNIT:TONER BOTTLE
 141.D2033525 (D203/D204):COVER:DRIVE UNIT:TONER BOTTLE:5ST
 45.AB012007 (D203/D204):GEAR - 14Z

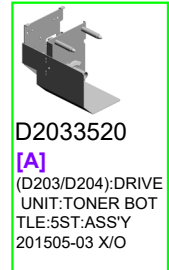

D2033520
 [A]
 (D203/D204):DRIVE UNIT:TONER BOT TLE:5ST:ASS'Y 201505-03 X/O

U007_S026
(D194/D195):INNER COVER:DUMMY:5ST:TONER SUPPLY:ASS'Y

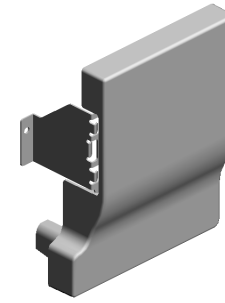

167.D0A53760
(D194/D195):INNER
COVER:DUMMY:5
ST:TONER SUPPL
Y:ASS'Y

U001	U002	U003	U004	U005	U006	U007	U008	U009	U010	U011	U012	U013	U014	U015	U016	U017	U018	U019	U020	U021
------	------	------	------	------	------	------	------	------	------	------	------	------	------	------	------	------	------	------	------	------

U008.PCDU

U008 S010
D1942330
CLEANING UNIT:ASS'Y

U008 S011
D1942307
PCU:FC:ASS'Y

U008 S009
D1942150
CHARGE UNIT:ASS'Y

U008 S008
D1942304
PCU:ASS'Y

U008 S001
D0743446
RECEPTACLE:DEVELOPME
T BIAS:ASS'Y

U008 S006
D1942150
CHARGE UNIT:ASS'Y

U008 S002
D0743446
RECEPTACLE:DEVELOPME
T BIAS:ASS'Y

U008 S007
D1942330
CLEANING UNIT:ASS'Y

U008 S003
D0743446
RECEPTACLE:DEVELOPME
T BIAS:ASS'Y

U008 S005
D0743446
RECEPTACLE:DEVELOPME
T BIAS:ASS'Y

U008 S012
D1942150
CHARGE UNIT:ASS'Y

U008 S004
D0743446
RECEPTACLE:DEVELOPME
T BIAS:ASS'Y

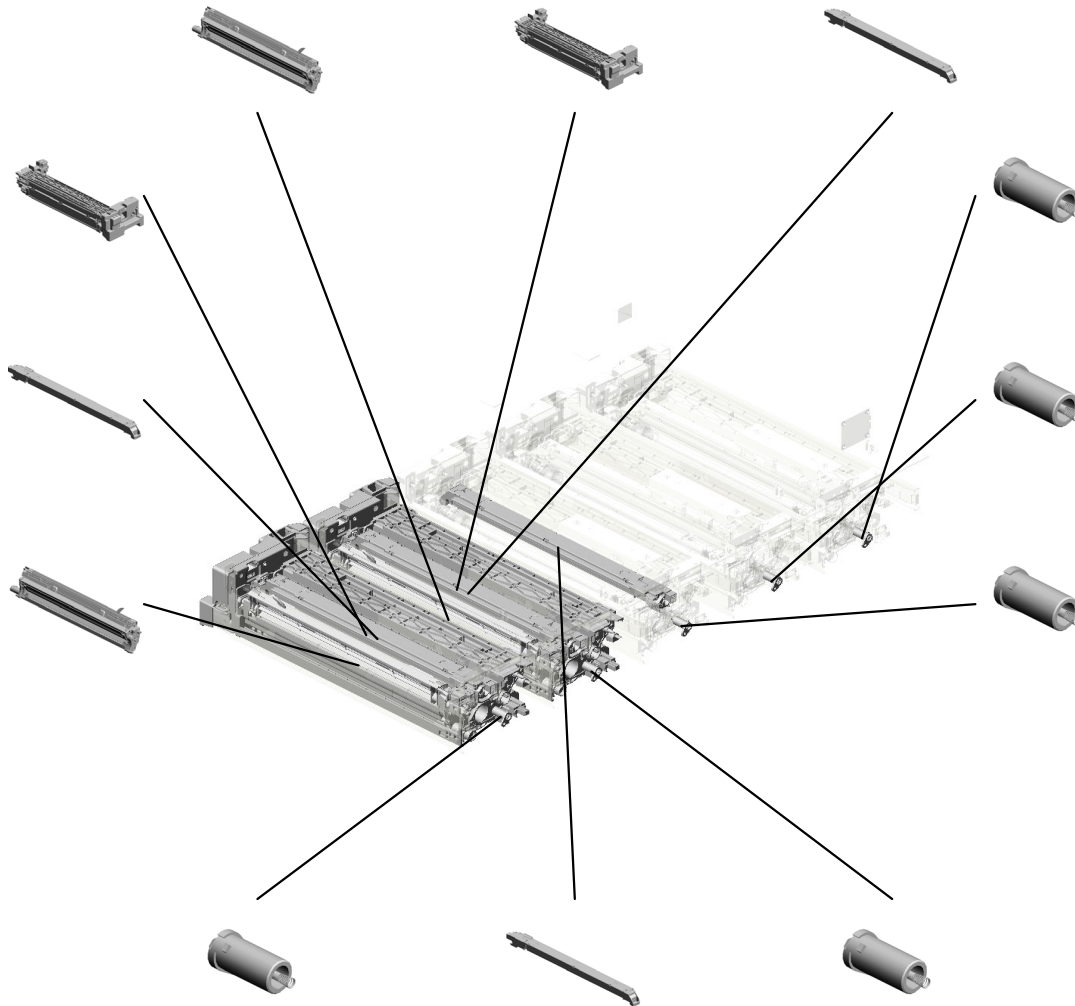

U008.PCDU

U008 S017
D1942307
PCU:FC:ASS'Y

U008 S015
D1942150
CHARGE UNIT:ASS'Y

U008 S014
D1942307
PCU:FC:ASS'Y

U008 S020
D1942304
PCU:ASS'Y

U008 S013
D1942330
CLEANING UNIT:ASS'Y

U008 S018
D1942150
CHARGE UNIT:ASS'Y

U008 S016
D1942330
CLEANING UNIT:ASS'Y

U008 S019
D1942330
CLEANING UNIT:ASS'Y

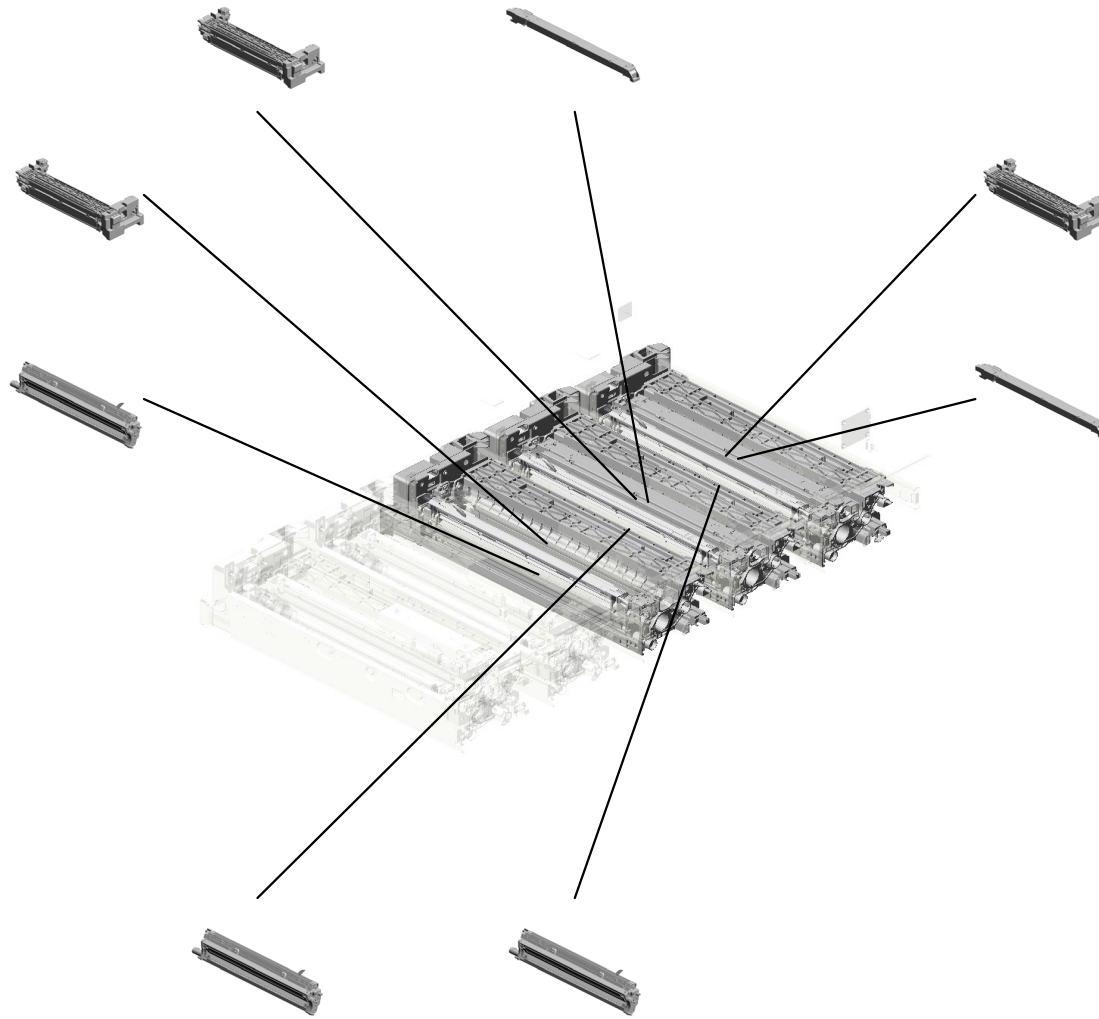

U001	U002	U003	U004	U005	U006	U007	U008	U009	U010	U011	U012	U013	U014	U015	U016	U017	U018	U019	U020	U021
------	------	------	------	------	------	------	-------------	------	------	------	------	------	------	------	------	------	------	------	------	------

U008_S007.CLEANING UNIT:ASS'Y

U008 S007 S002
D1942550
GEAR:CLEANING:DRUM:SER
VICE



U001	U002	U003	U004	U005	U006	U007	U008	U009	U010	U011	U012	U013	U014	U015	U016	U017	U018	U019	U020	U021
------	------	------	------	------	------	------	-------------	------	------	------	------	------	------	------	------	------	------	------	------	------

U008_S008.PCU:ASS'Y

U008 S008 S002
D0743216
GUIDE:TONER SUPPLY:ASS'
Y

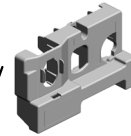

U008 S008 S001
D0742392
COVER:PCU:FRONT:ASS'Y

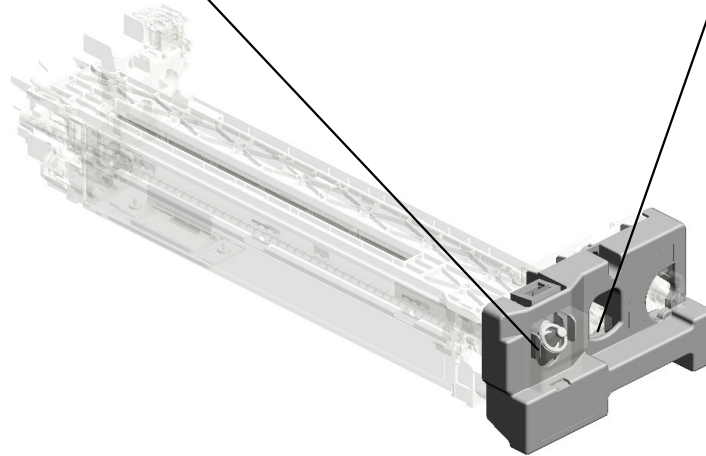

U001	U002	U003	U004	U005	U006	U007	U008	U009	U010	U011	U012	U013	U014	U015	U016	U017	U018	U019	U020	U021
------	------	------	------	------	------	------	-------------	------	------	------	------	------	------	------	------	------	------	------	------	------

U008_S010.CLEANING UNIT:ASS'Y

U008 S010 S002
D1942550
GEAR:CLEANING:DRUM:SER
VICE



U008 S010 S001
D1942475
STAY:APPLY:ASS'Y

U001	U002	U003	U004	U005	U006	U007	U008	U009	U010	U011	U012	U013	U014	U015	U016	U017	U018	U019	U020	U021
------	------	------	------	------	------	------	-------------	------	------	------	------	------	------	------	------	------	------	------	------	------

U008_S011.PCU:FC:ASS'Y

U008 S011 S002
D0743216
GUIDE:TONER SUPPLY:ASS'
Y



U008 S011 S001
D0742392
COVER:PCU:FRONT:ASS'Y

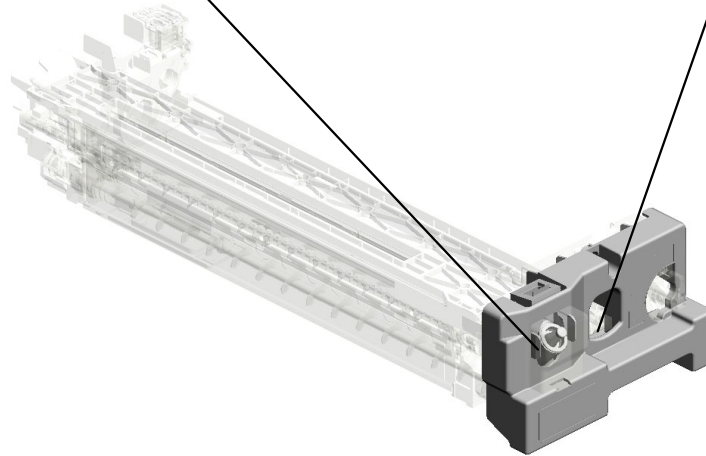

U001	U002	U003	U004	U005	U006	U007	U008	U009	U010	U011	U012	U013	U014	U015	U016	U017	U018	U019	U020	U021
------	------	------	------	------	------	------	-------------	------	------	------	------	------	------	------	------	------	------	------	------	------

U008_S013.CLEANING UNIT:ASS'Y

U008 S013 S002
D1942550
GEAR:CLEANING:DRUM:SER
VICE



U001	U002	U003	U004	U005	U006	U007	U008	U009	U010	U011	U012	U013	U014	U015	U016	U017	U018	U019	U020	U021
------	------	------	------	------	------	------	-------------	------	------	------	------	------	------	------	------	------	------	------	------	------

U008_S014.PCU:FC:ASS'Y

U008 S014 S002
D0743216
GUIDE:TONER SUPPLY:ASS'
Y

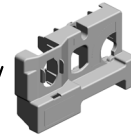

U008 S014 S001
D0742392
COVER:PCU:FRONT:ASS'Y

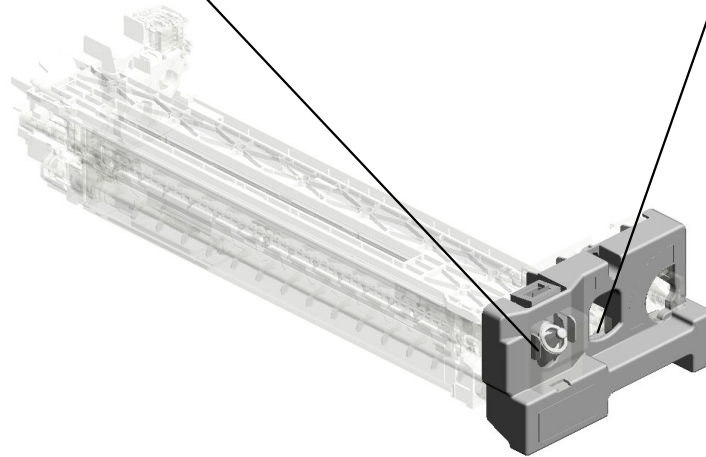

U001	U002	U003	U004	U005	U006	U007	U008	U009	U010	U011	U012	U013	U014	U015	U016	U017	U018	U019	U020	U021
------	------	------	------	------	------	------	-------------	------	------	------	------	------	------	------	------	------	------	------	------	------

U008_S016.CLEANING UNIT:ASS'Y

U008 S016 S002
D1942550
GEAR:CLEANING:DRUM:SER
VICE



U001	U002	U003	U004	U005	U006	U007	U008	U009	U010	U011	U012	U013	U014	U015	U016	U017	U018	U019	U020	U021
------	------	------	------	------	------	------	-------------	------	------	------	------	------	------	------	------	------	------	------	------	------

U008_S017.PCU:FC:ASS'Y

U008 S017 S002
D0743216
GUIDE:TONER SUPPLY:ASS'
Y

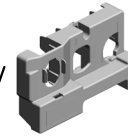

U008 S017 S001
D0742392
COVER:PCU:FRONT:ASS'Y

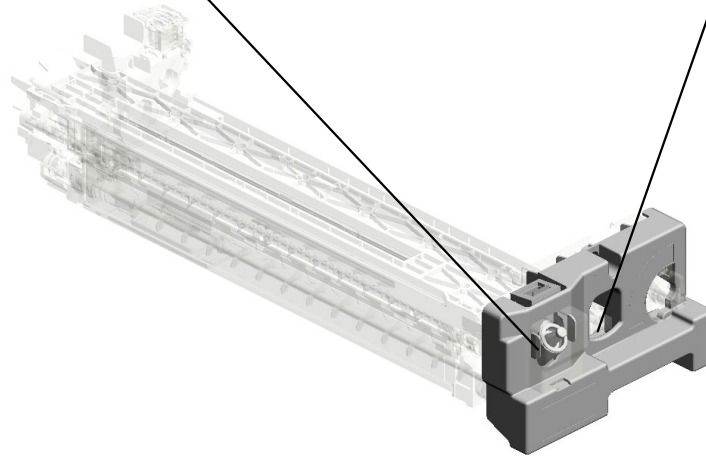

U001	U002	U003	U004	U005	U006	U007	U008	U009	U010	U011	U012	U013	U014	U015	U016	U017	U018	U019	U020	U021
------	------	------	------	------	------	------	-------------	------	------	------	------	------	------	------	------	------	------	------	------	------

U008_S019.CLEANING UNIT:ASS'Y

U008 S019 S002
D1942550
GEAR:CLEANING:DRUM:SER
VICE



U001	U002	U003	U004	U005	U006	U007	U008	U009	U010	U011	U012	U013	U014	U015	U016	U017	U018	U019	U020	U021
------	------	------	------	------	------	------	-------------	------	------	------	------	------	------	------	------	------	------	------	------	------

U008_S020.PCU:ASS'Y

U008 S020 S002
D0743216
GUIDE:TONER SUPPLY:ASS'
Y



U008 S020 S001
D0742392
COVER:PCU:FRONT:ASS'Y

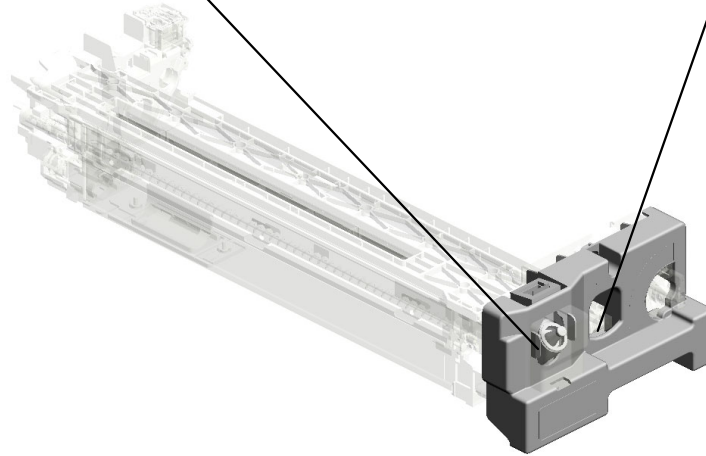

U001	U002	U003	U004	U005	U006	U007	U008	U009	U010	U011	U012	U013	U014	U015	U016	U017	U018	U019	U020	U021
------	------	------	------	------	------	------	-------------	------	------	------	------	------	------	------	------	------	------	------	------	------

U008
PCDU

- 8.04543006Q (x12) TAPPING SCREW - M3X6
- 17.AW140015 TEMPERATURE & HUMIDITY SENSOR
- 20.B2591131 (x4) SCREW:PCU
- 19.B2342390 (x5) FLANGED HEXAGONAL HEAD BOLT: M4X8
- 2.03530050N (x35) SCREW-M3X5

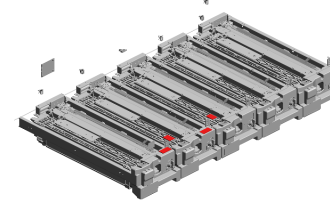

21.D0142380
(x5)
COMPRESSION SPRING - DRUM



23.D0143656
(x5)
HOLDER: ELECTRIC POTENTIAL SENSOR



22.D0143655
(x4)
ELECTRIC POTENTIAL SENSOR



24.D0143657
(x4)
SHIELDING PLATE



14.11050516
(x10)
CLAMP



26.D0742178
(x5)
TENSION SPRING: SOLENOID: ON-OFF



9.07200030E
(x5)
RETAINING RING - M3



25.D0742172
(x5)
BRACKET: SOLENOID: ON-OFF



1.03530030N
(x10)
SCREW: M3X3



5.03603006N
(x19)
SCREW - M3X6



13.11050508
(x11)
HARNESS CLAMP - LWS-0711



15.11050724
(x5)
CLAMPS: WES-1210



27.D0742181
(x5)
CONNECTOR: 1P0 LE



18.AW500023
(x5)
PUSH SWITCH



7.04514008N
(x15)
TAPPING SCREW: 4X8



20.B2591131
(x10)
SCREW:PCU



109.D1949640
DEVELOPER BLACK

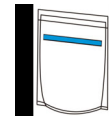

110.D1949660
DEVELOPER CYAN

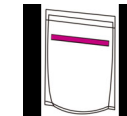

111.D1949670
DEVELOPER MAGENTA

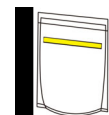

112.D1949680
DEVELOPER YELLOW

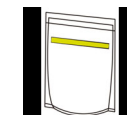

138.D0A59705
DEVELOPER NEON YELLOW
202002-01 O/O

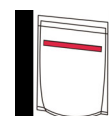

139.D0A59725
DEVELOPER INVISIBLE-RED
202002-02 O/O

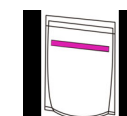

140.D0A59715
(D203/D204): DEVELOPER NEON-PINK
202005-02 O/O

U008
PCDU

- 31.D0742274 (x4) BRACKET:ELECTRIC POTENTIAL SENSOR
- 30.D0742272 BRACKET:TEMPERATURE & HUMIDITY SENSOR
- 121.D1948520 SERVICE PARTS:DECAL:NEON_Y:ASSY
- 105.D1942558 (x5) SLIDE RAIL:PCU:LEFT
- 106.D1942562 (D203/D204):DECAL:PCU:TCRUS:5ST

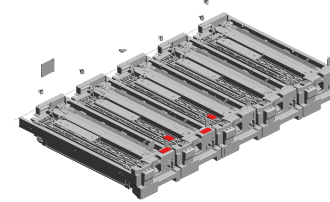

- 58.D0742542 (x10) DECAL:GRIP



- 62.D0742561 (x5) LOCK:SLIDE RAIL:PCU:RIGHT



- 29.D0742252 (x5) FRAME:PHOTOCOILDUCTOR



- 108.D1949510 (x5) OPC DRUM DIA60

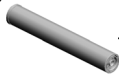

- 61.D0742553 (x4) SLIDE RAIL:PCU:RIGHT



- 57.D0742541 (x10) DECAL:ARROW LABEL



- 104.D1942553 SLIDE RAIL:PCU:RIGHT



- 107.D1942566 GUIDE PLATE:SLIDE RAIL:PCU:S:PEEN



- 86.D1942175 (x4) DC SOLENOID:ON-OFF:ASSY



- 65.D0742576 (x5) HOLDER:SET SENSOR:PCU



- 121.D1948520 SERVICE PARTS:DECAL:NEON_Y:ASSY

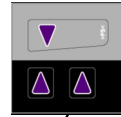

- 106.D1942562 (D203/D204):DECAL:PCU:TCRUS:5ST

- 88.D1942277 (D203/D204):ELECTRIC POTENTIAL SENSOR



- 141.D0A59735 (D203/D204):DEVELOPER CLEAR 202011-05 O/O



- 144.D0A59695 (D203/D204):DEVELOPER WHITE 202012-03 O/O

- 89.D1942290 (D203/D204):DC SOLENOID:ON-OFF:ASSY



- 7.04514008N(x 5) TAPPING SCREW:4X8

- 66.D0742577 (x5) CONNECTOR:DRAWER:4POLE:REC

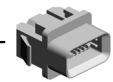

- 64.D0742575 (x5) ARM:SET SENSOR:PCU



- 63.D0742572 (x5) STAY:SET SENSOR:PCU



U008
PCDU

132.D0A52592 DECAL:PCDU_HOP
PER:W
202002-07

133.D0A52593 DECAL:PCDU_HOP
PER:CLR
202002-08

134.D0A52595 DECAL:PCDU_HOP
PER:NEON-Y
202002-09

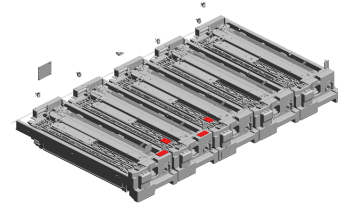

123.D1948523
SERVICE PARTS:DECAL:NEON-P:ASSY
201710-11



127.D1948524
SERVICE PARTS:DECAL:IV-R:ASSY
201805-07



129.D0A57285
(x4)
SHEET:GUIDE PLATE:SLIDE RAIL:PCU
201806-07

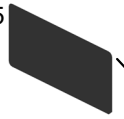

135.D0A52596
DECAL:PCDU_HOP
PER:NEON-P
202002-10



136.D0A52597
DECAL:PCDU_HOP
PER:IV-R
202002-11



137.D0A52598
(CHN):DECAL:PCDU_HOPPER:CU-R
202002-12

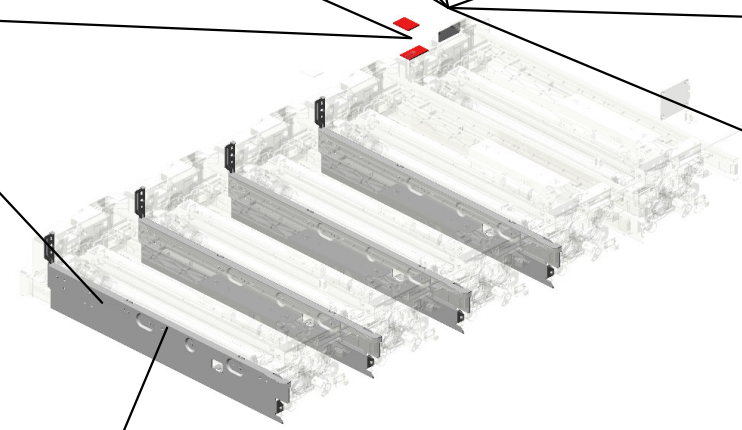

149.M0EB2524
(x4)
GUIDE PLATE:SLIDE RAIL:PCU
202303-01 O/O

U008_S001
RECEPTACLE:DEVELOPMENT BIAS:ASS'Y

16-AA063371
SPRING

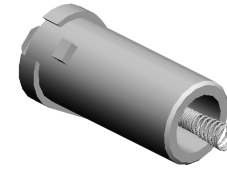

75.D0743446
RECEPTACLE:DEV
ELOPMENT BIAS:A
SS'Y



U001	U002	U003	U004	U005	U006	U007	U008	U009	U010	U011	U012	U013	U014	U015	U016	U017	U018	U019	U020	U021
------	------	------	------	------	------	------	-------------	------	------	------	------	------	------	------	------	------	------	------	------	------

U008_S002
RECEPTACLE:DEVELOPMENT BIAS:ASS'Y

16-AA063371
SPRING

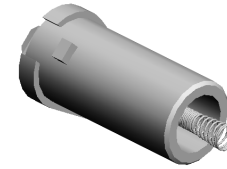

75.D0743446
RECEPTACLE:DEV
ELOPMENT BIAS:A
SS'Y

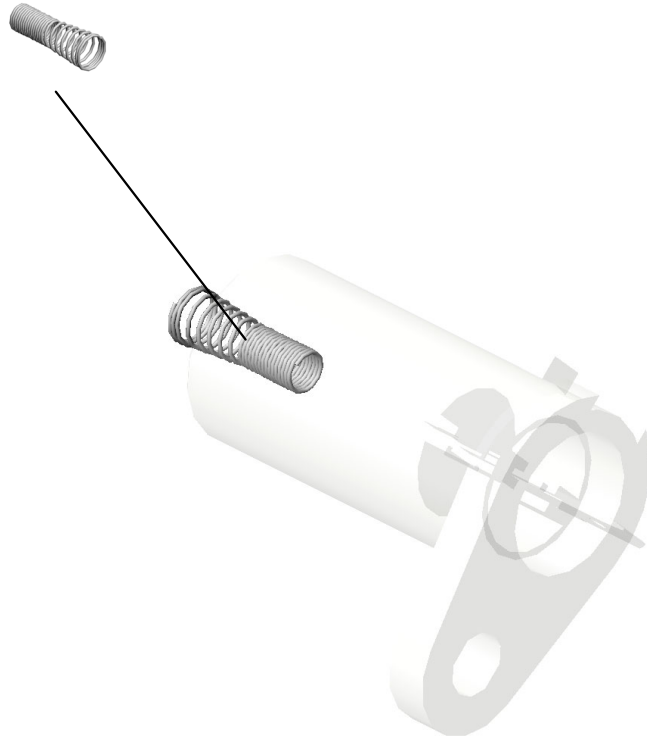

U001	U002	U003	U004	U005	U006	U007	U008	U009	U010	U011	U012	U013	U014	U015	U016	U017	U018	U019	U020	U021
------	------	------	------	------	------	------	-------------	------	------	------	------	------	------	------	------	------	------	------	------	------

U008_S003
RECEPTACLE:DEVELOPMENT BIAS:ASS'Y

16-AA063371
SPRING

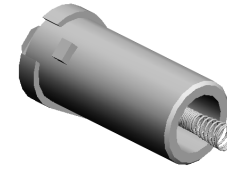

75.D0743446
RECEPTACLE:DEV
ELOPMENT BIAS:A
SS'Y

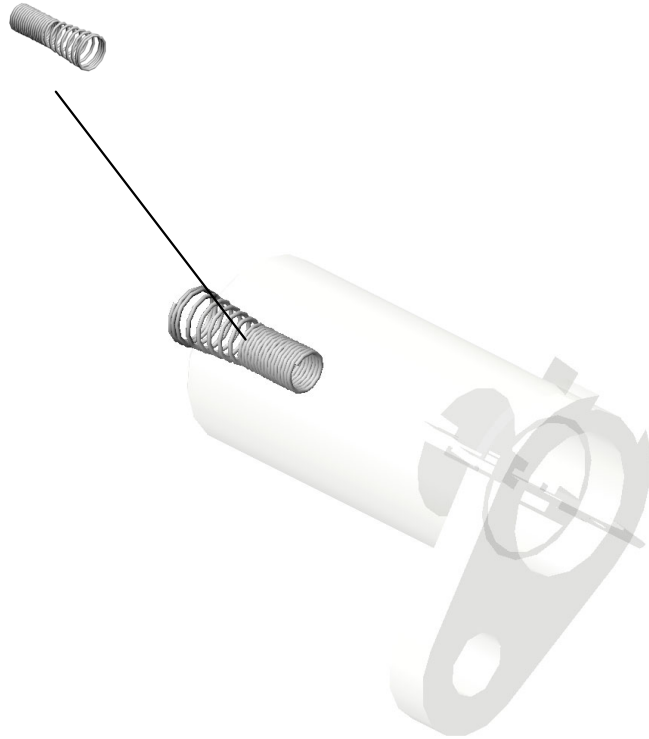

U001	U002	U003	U004	U005	U006	U007	U008	U009	U010	U011	U012	U013	U014	U015	U016	U017	U018	U019	U020	U021
------	------	------	------	------	------	------	-------------	------	------	------	------	------	------	------	------	------	------	------	------	------

U008_S004
RECEPTACLE:DEVELOPMENT BIAS:ASS'Y

16-AA063371
SPRING

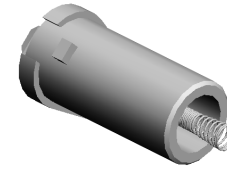

75.D0743446
RECEPTACLE:DEV
ELOPMENT BIAS:A
SS'Y

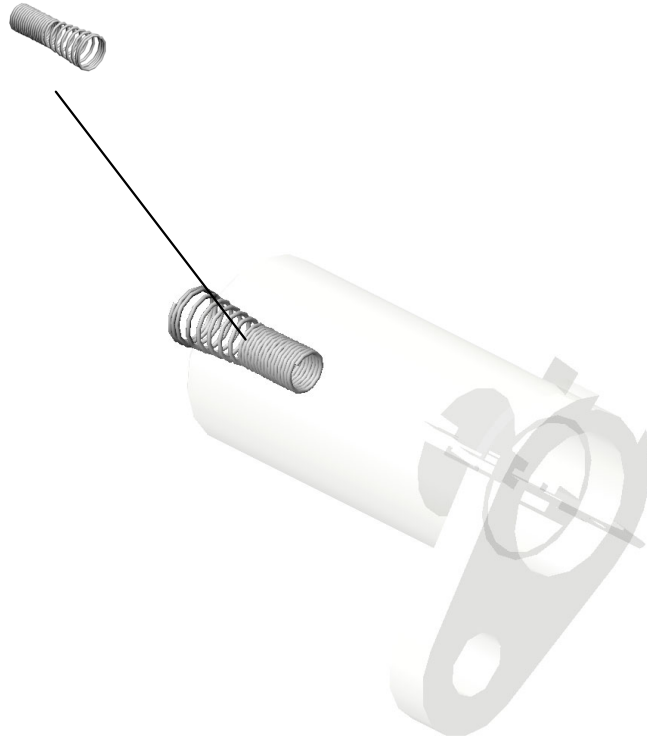

U001	U002	U003	U004	U005	U006	U007	U008	U009	U010	U011	U012	U013	U014	U015	U016	U017	U018	U019	U020	U021
------	------	------	------	------	------	------	-------------	------	------	------	------	------	------	------	------	------	------	------	------	------

U008_S005
RECEPTACLE:DEVELOPMENT BIAS:ASS'Y

16-AA063371
SPRING

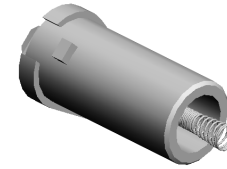
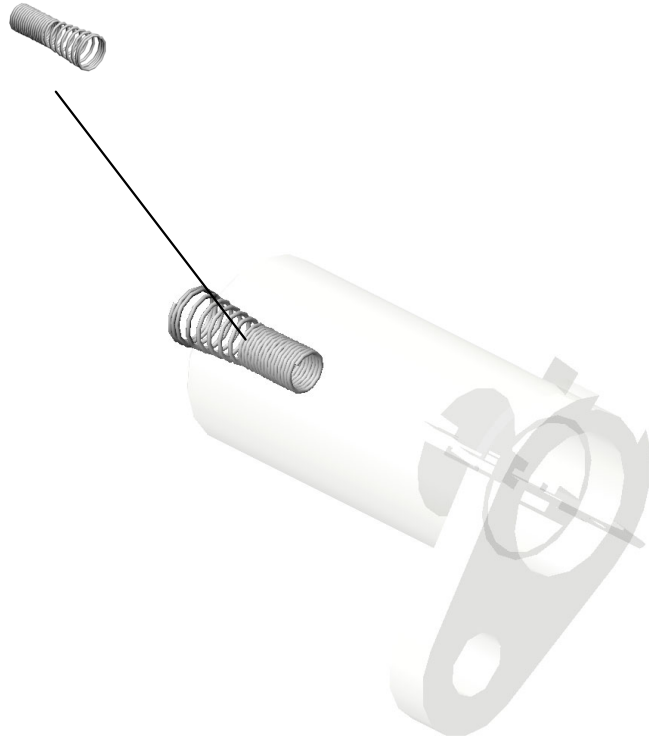

75.D0743446
RECEPTACLE:DEV
ELOPMENT BIAS:A
SS'Y

U001	U002	U003	U004	U005	U006	U007	U008	U009	U010	U011	U012	U013	U014	U015	U016	U017	U018	U019	U020	U021
------	------	------	------	------	------	------	-------------	------	------	------	------	------	------	------	------	------	------	------	------	------

U008_S006
CHARGE UNIT:ASS'Y

85.D1942165
DECAL:GRIP

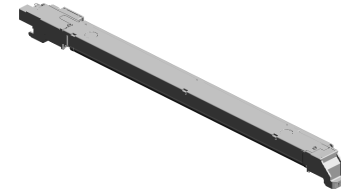
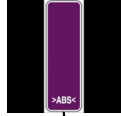

84.D1942150
CHARGE UNIT:ASS
'Y

U001	U002	U003	U004	U005	U006	U007	U008	U009	U010	U011	U012	U013	U014	U015	U016	U017	U018	U019	U020	U021
------	------	------	------	------	------	------	------	------	------	------	------	------	------	------	------	------	------	------	------	------

U008_S007
CLEANING UNIT:ASS'Y

5.03603006N
(x4)
SCREW - M3X6

48.D0742448
TRANSPORT SCR
EW:APPLY:ASS'Y

79.D1362411
COATING BAR:AS
S'Y

78.D2582402
OIL SUPPLY ROLL
ER:ASS'Y
201608-02 O/O

82.D1362441
BLADE:APPLY:AS
S'Y



92.D1942330
CLEANING UNIT:AS
SS'Y

58.D0742542
(x2)
DECAL:GRIP



93.D1942457
COVER:BEARING:
OIL SUPPLY ROLL
ER:FRONT



10.07200040E
(x2)
RETAINING RING -
M4



46.D0742424
SEAL:BLADE:CLE
ANING:FRONT



45.D0742419
(x2)
PLAIN SHAFT BEA
RING:TRANSPORT
SCREW



77.D1362365
CLEANING BLADE:
ASS'Y

44.D0742414
TRANSPORT SCR
EW:BASE:ASS'Y

81.D1362418
TENSION SPRING:
COATING BAR:18N

3.03530060N
(x4)
BIND SCREW - M3
X6

11.08025320
HEXAGON HEAD T
APPING SCREW:E
S:3X10

5.03603006N(x 3)
SCREW - M3X6

80.D1362417
(x2)
ARM:COATING BA
R



49.D0742459
JOINT:CLEANING
UNIT



52.D0742497
VIBRATING PLATE:
TONER OUTLET S
UB-UNIT



47.D0742425
SEAL:BLADE:CLE
ANING:REAR



51.D0742491
COVER:TONER OU
TLET SUB-UNIT:CL
EANING UNIT:ASS'
Y



U008_S007
CLEANING UNIT:ASS'Y

146.D1942441 **97.D1942485**
SEAL:FRAME:COATING BAR:FRONT SIDE (x2)
SEAL:BLADE:APPLY



92.D1942330
CLEANING UNIT:ASS'Y

99.D1942507
GROUND PLATE:OIL SUPPLY ROLLER:ASS'Y



98.D1942506
DRUM STAY:CLEANING UNIT



147.D1942442
SEAL:FRAME:COATING BAR:REAR SIDE



145.D1942440
SEAL:FRAME:APPLY:REAR SIDE



148.D1942443 94.D1942458
SEAL:FRAME:COATING BAR:UPPER COVER:BEARING:OIL SUPPLY ROLLER:REAR



U001	U002	U003	U004	U005	U006	U007	U008	U009	U010	U011	U012	U013	U014	U015	U016	U017	U018	U019	U020	U021
------	------	------	------	------	------	------	------	------	------	------	------	------	------	------	------	------	------	------	------	------

U008_S007_S001
STAY:APPLY:ASS'Y

50.D0742477
(x2)
SHEET:STAY:APPL
Y

96.D1942475
STAY:APPLY:ASS'Y



5.03603006N
(x2)
SCREW - M3X6

U001	U002	U003	U004	U005	U006	U007	U008	U009	U010	U011	U012	U013	U014	U015	U016	U017	U018	U019	U020	U021
------	------	------	------	------	------	------	-------------	------	------	------	------	------	------	------	------	------	------	------	------	------

U008_S007_S002
GEAR:CLEANING:DRUM:SERVICE

54.D0742502
GEAR:IDLER:20Z:L
EFT



103.D1942550
GEAR:CLEANING:
DRUM:SERVICE

95.D1942460
GEAR:19Z:RIGHT

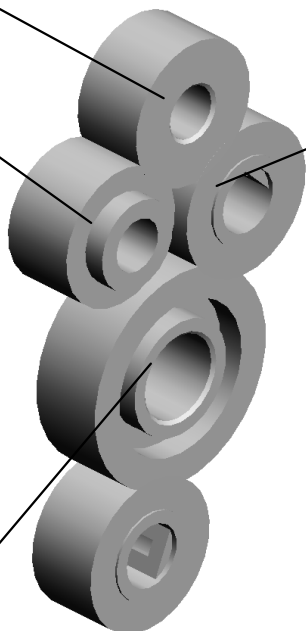

53.D0742501
(x2)
GEAR:21Z:RIGHT



55.D0742503
GEAR:IDLER:31Z:L
EFT

U001	U002	U003	U004	U005	U006	U007	U008	U009	U010	U011	U012	U013	U014	U015	U016	U017	U018	U019	U020	U021
------	------	------	------	------	------	------	-------------	------	------	------	------	------	------	------	------	------	------	------	------	------

U008_S008
PCU:ASS'Y

- 40.D0742386 HOLDER:LOCK:CLEANING UNIT:REAR
- 28.D0742192 SHEET:DISCHARGE LAMP
- 9.07200030E RETAINING RING - M3
- 10.07200040E (x6) RETAINING RING - M4
- 32.D0742366 LEVER:LOCK:CHARGE UNIT

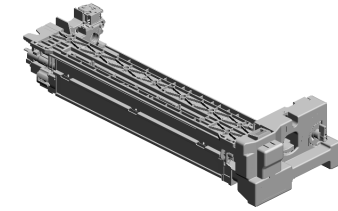

130.D1942304
[A]
PCU:ASS'Y
201905-08 X/O

59.D0742544
DECAL:POSITIONING DISPLAY



57.D0742541
(x4)
DECAL:ARROW LABEL



3.03530060N
(x2)
BIND SCREW - M3 X6



6.04503010N
(x4)
TAPPING SCREW - M3X10



2.03530050N
(x2)
SCREW-M3X5



4.03530080N
(x4)
SCREW:M3X8



5.03603006N
(x18)
SCREW - M3X6



33.D0742367
HOLDER:LOCK:CHARGE UNIT



34.D0742368
COMPRESSION SPRING:LOCK:CHARGE UNIT



12.08046128
(x8)
HEXAGONAL BOLT:DOUBLE SCREW: M3X10



36.D0742377
TENSION SPRING: LOCK:PCU



37.D0742381
(x2)
COMPRESSION SPRING:LOCK:CLEANING UNIT



38.D0742382
HOLDER:LOCK:CLEANING UNIT:FRONT



39.D0742383
LEVER:LOCK:CLEANING UNIT:FRONT

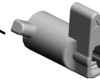

35.D0742376
LEVER:LOCK:PCU



U008_S008
PCU:ASS'Y

118.D1363407 SEAL:DEVELOPME
NT ROLLER:REAR
116.J0155505 DRAWER:CONNEC
TOR:USED DEVEL
PER:PLUG
67.D0743321 PLATE:FILTER
83.D1363431
**FILTER:DEVELOP
MENT**

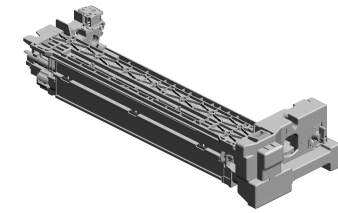

130.D1942304
[A]
PCU:ASS'Y
201905-08 X/O

71.D0743367
ELECTRODE PLAT
E:DEVELOPMENT
BIAS:REAR UPPER

72.D0743368
ELECTRODE PLAT
E:DEVELOPMENT
BIAS:REAR LOWE
R

73.D0743427
RADIAL BALL BEA
RING:DIAXDIA16X
5

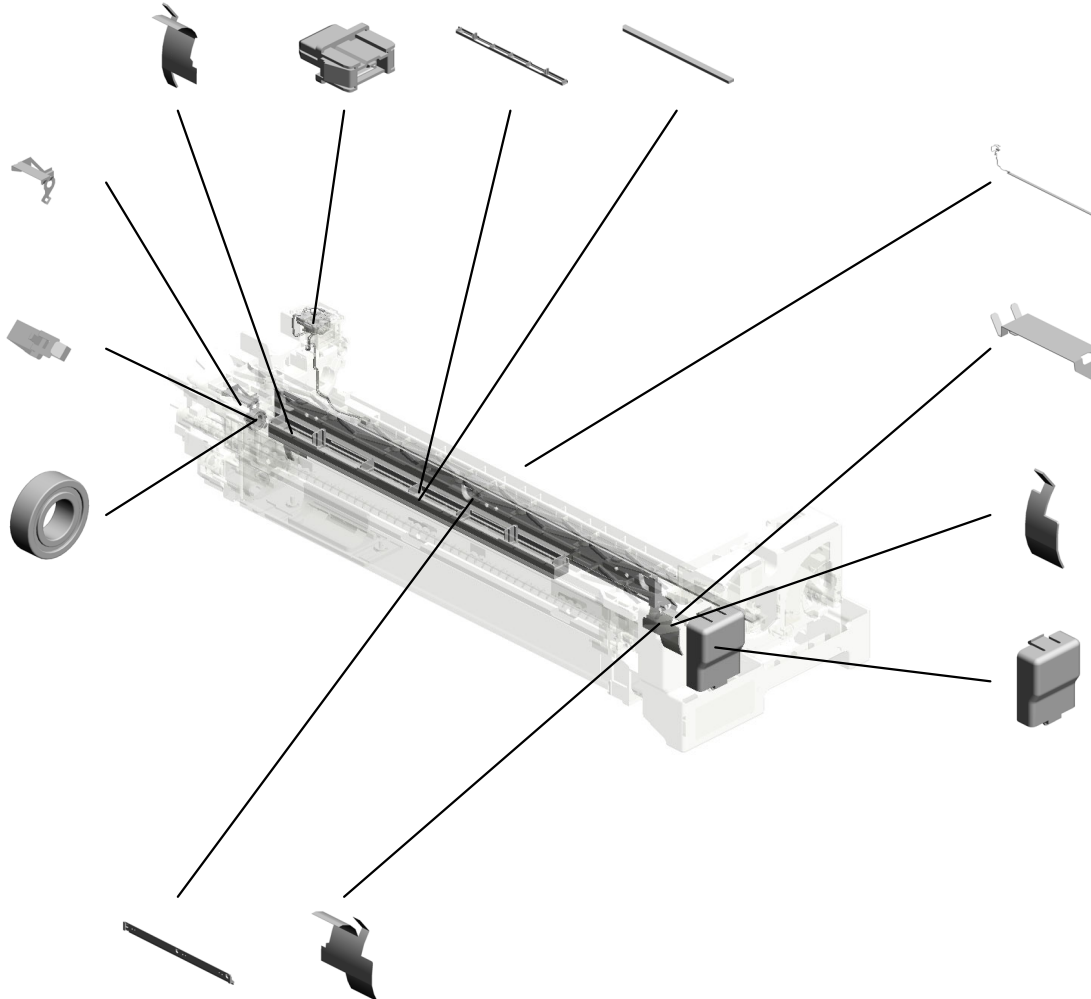

87.D1942191
DISCHARGE LAMP
:LED ARRAY

70.D0743362
ELECTRODE PLAT
E:DEVELOPMENT
BIAS:FRONT

142.D0A53456
SEAL:DEVELOPME
NT ROLLER:FRON
T:2
202011-03

74.D0743440
COVER:INSERT:DE
VELOPER

120.D1943330 ENTRANCE SEAL:
DEVELOPMENT:AS
S'Y
201608-04
143.D0A53457 SEAL:DEVELOPME
NT ROLLER:FRON
T:1
202011-04 O/O

D1942303
[A]
PCU:ASS'Y
201905-08 X/O

U008_S008_S001
COVER:PCU:FRONT:ASS'Y

76.D0743829 42.D0742393
DECAL:POSITIONI COVER:PCU:FRON
NG DISPLAY:TCRU T

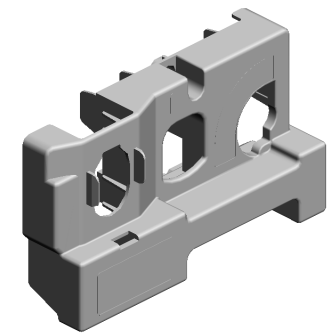

41.D0742392
COVER:PCU:FRON
T:ASS'Y

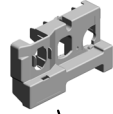

56.D0742540
DECAL:LOCK:CLE
ANING UNIT



115.G0291980
DECAL - LD



43.D0742395
GROUND PLATE:P
CU:ASS'Y

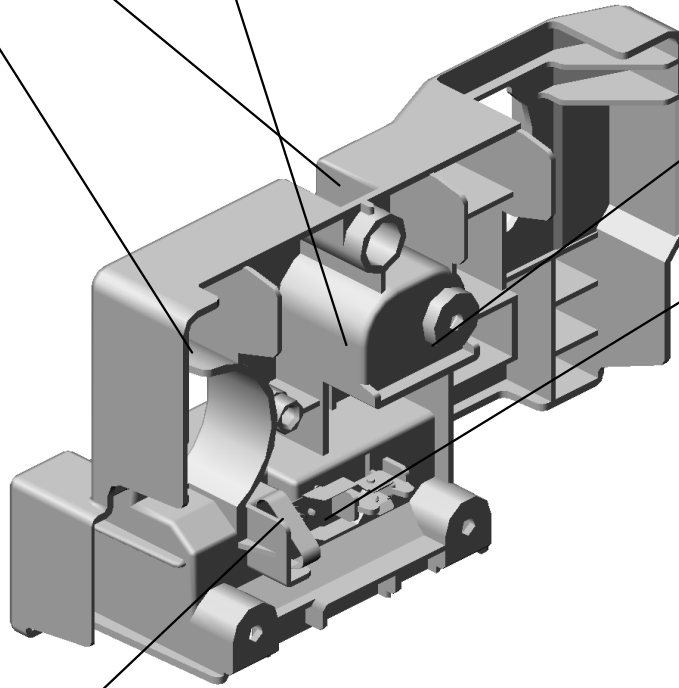

11.08025320
HEXAGON HEAD T
APPING SCREW:E
S:3X10

U001	U002	U003	U004	U005	U006	U007	U008	U009	U010	U011	U012	U013	U014	U015	U016	U017	U018	U019	U020	U021
------	------	------	------	------	------	------	------	------	------	------	------	------	------	------	------	------	------	------	------	------

U008_S008_S002
GUIDE:TONER SUPPLY:ASS'Y

69.D0743352
SEAL:GUIDE:TONE
R SUPPLY:UPPER

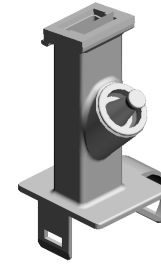

119.D0743216
GUIDE:TONER SU
PLY:ASSY



U001	U002	U003	U004	U005	U006	U007	U008	U009	U010	U011	U012	U013	U014	U015	U016	U017	U018	U019	U020	U021
------	------	------	------	------	------	------	-------------	------	------	------	------	------	------	------	------	------	------	------	------	------

U008_S009
CHARGE UNIT:ASS'Y

85.D1942165
DECAL:GRIP

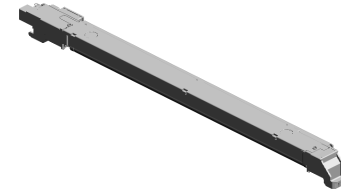

84.D1942150
CHARGE UNIT:ASS
'Y

U001	U002	U003	U004	U005	U006	U007	U008	U009	U010	U011	U012	U013	U014	U015	U016	U017	U018	U019	U020	U021
------	------	------	------	------	------	------	------	------	------	------	------	------	------	------	------	------	------	------	------	------

U008_S010
CLEANING UNIT:ASS'Y

- 48.D0742448 TRANSPORT SCR
EW:APPLY:ASS'Y
- 79.D1362411 COATING BAR:AS
S'Y
- 78.D2582402 OIL SUPPLY ROLL
ER:ASS'Y
201608-02 O/O
- 82.D1362441 BLADE:APPLY:AS
S'Y
- 81.D1362418 TENSION SPRING:
COATING BAR:18N



92.D1942330
CLEANING UNIT:AS
SS'Y

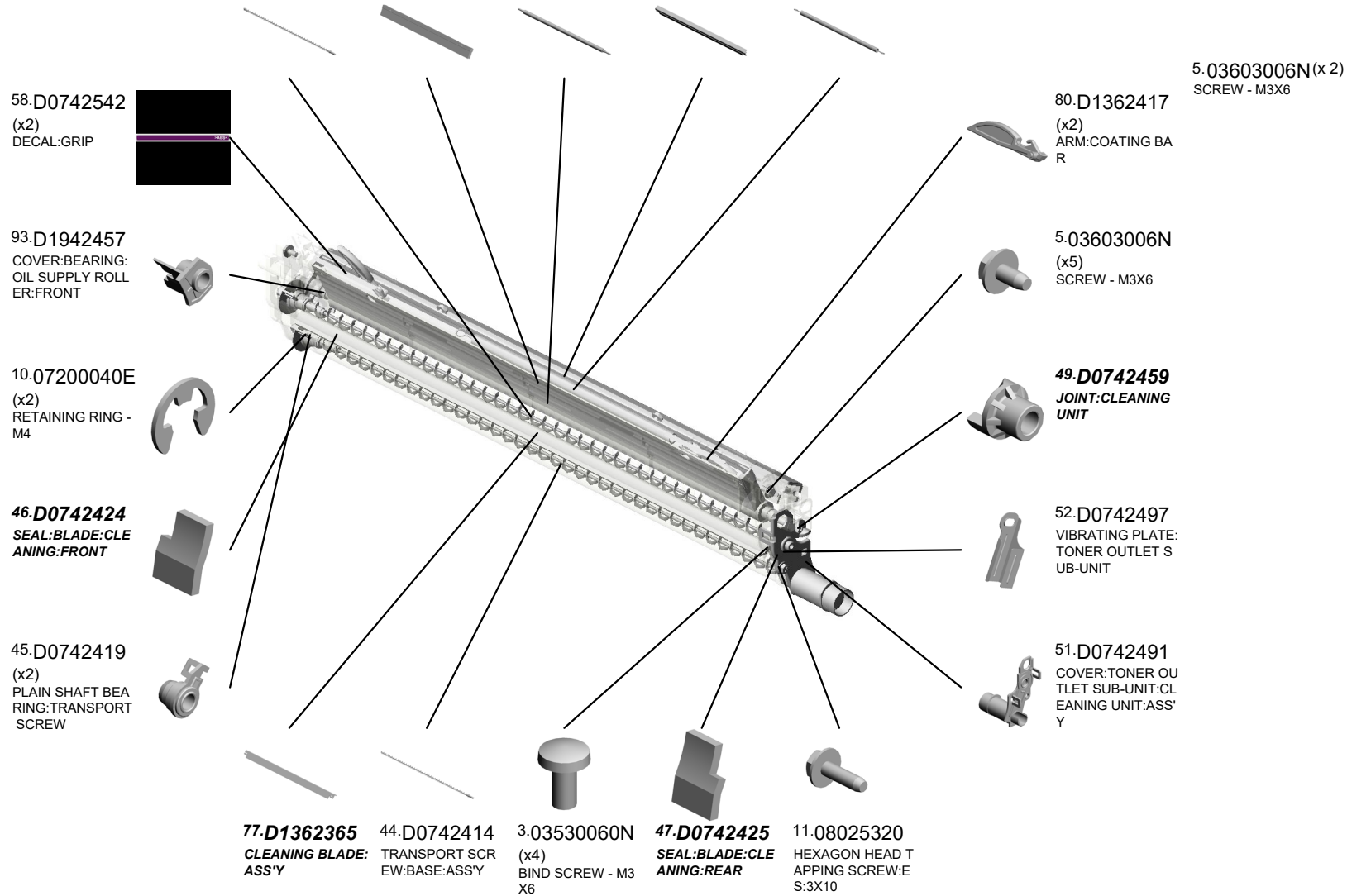

58.D0742542
(x2)
DECAL:GRIP

93.D1942457
COVER:BEARING:
OIL SUPPLY ROLL
ER:FRONT

10.07200040E
(x2)
RETAINING RING -
M4

46.D0742424
SEAL:BLADE:CLE
ANING:FRONT

45.D0742419
(x2)
PLAIN SHAFT BEA
RING:TRANSPORT
SCREW

77.D1362365
CLEANING BLADE:
ASS'Y

44.D0742414
TRANSPORT SCR
EW:BASE:ASS'Y

3.03530060N
(x4)
BIND SCREW - M3
X6

47.D0742425
SEAL:BLADE:CLE
ANING:REAR

11.08025320
HEXAGON HEAD T
APPING SCREW:E
S:3X10

5.03603006N(x 2)
SCREW - M3X6

80.D1362417
(x2)
ARM:COATING BA
R

5.03603006N
(x5)
SCREW - M3X6

49.D0742459
JOINT:CLEANING
UNIT

52.D0742497
VIBRATING PLATE:
TONER OUTLET S
UB-UNIT

51.D0742491
COVER:TONER OU
TLET SUB-UNIT:CL
EANING UNIT:ASS'
Y

U008_S010
CLEANING UNIT:ASS'Y

146.D1942441 **97.D1942485**
SEAL:FRAME:COA
TING BAR:FRONT
SIDE (x2)
**SEAL:BLADE:APP
LY**



92.D1942330
CLEANING UNIT:A
SS'Y

99.D1942507
GROUND PLATE:O
IL SUPPLY ROLLE
R:ASS'Y



98.D1942506
DRUM STAY:CLEA
NING UNIT



147.D1942442
SEAL:FRAME:COA
TING BAR:REAR SI
DE



145.D1942440
SEAL:FRAME:APPL
Y:REAR SIDE



148.D1942443 94.D1942458
SEAL:FRAME:COA
TING BAR:UPPER COVER:BEARING:
OIL SUPPLY ROLL
ER:REAR



U001	U002	U003	U004	U005	U006	U007	U008	U009	U010	U011	U012	U013	U014	U015	U016	U017	U018	U019	U020	U021
------	------	------	------	------	------	------	------	------	------	------	------	------	------	------	------	------	------	------	------	------

U008_S010_S001
STAY:APPLY:ASS'Y

50.D0742477
(x2)
SHEET:STAY:APPL
Y

96.D1942475
STAY:APPLY:ASS'Y



5.03603006N
(x2)
SCREW - M3X6

U001	U002	U003	U004	U005	U006	U007	U008	U009	U010	U011	U012	U013	U014	U015	U016	U017	U018	U019	U020	U021
------	------	------	------	------	------	------	-------------	------	------	------	------	------	------	------	------	------	------	------	------	------

U008_S010_S002
GEAR:CLEANING:DRUM:SERVICE

54.D0742502
GEAR:IDLER:20Z:L
EFT



103.D1942550
GEAR:CLEANING:
DRUM:SERVICE

95.D1942460
GEAR:19Z:RIGHT

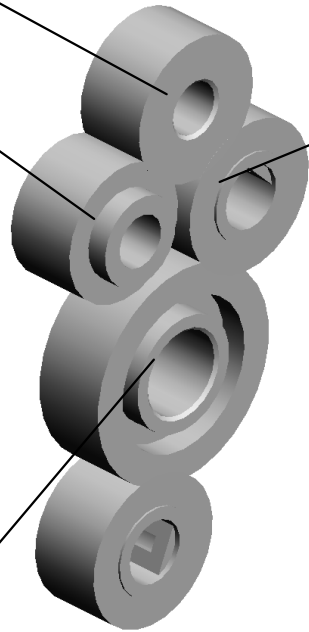

53.D0742501
(x2)
GEAR:21Z:RIGHT



55.D0742503
GEAR:IDLER:31Z:L
EFT



U001	U002	U003	U004	U005	U006	U007	U008	U009	U010	U011	U012	U013	U014	U015	U016	U017	U018	U019	U020	U021
------	------	------	------	------	------	------	-------------	------	------	------	------	------	------	------	------	------	------	------	------	------

U008_S011
PCU:FC:ASS'Y

- 28.D0742192 SHEET:DISCHARGE LAMP
- 9.07200030E RETAINING RING - M3
- 10.07200040E (x6) RETAINING RING - M4
- 5.03603006N (x18) SCREW - M3X6
- 32.D0742366 LEVER:LOCK:CHARGE UNIT

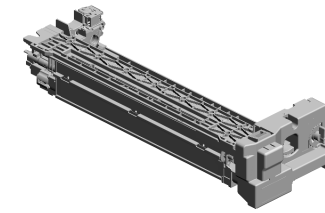

131.D1942307
[A]
PCU:FC:ASS'Y
201905-09 X/O

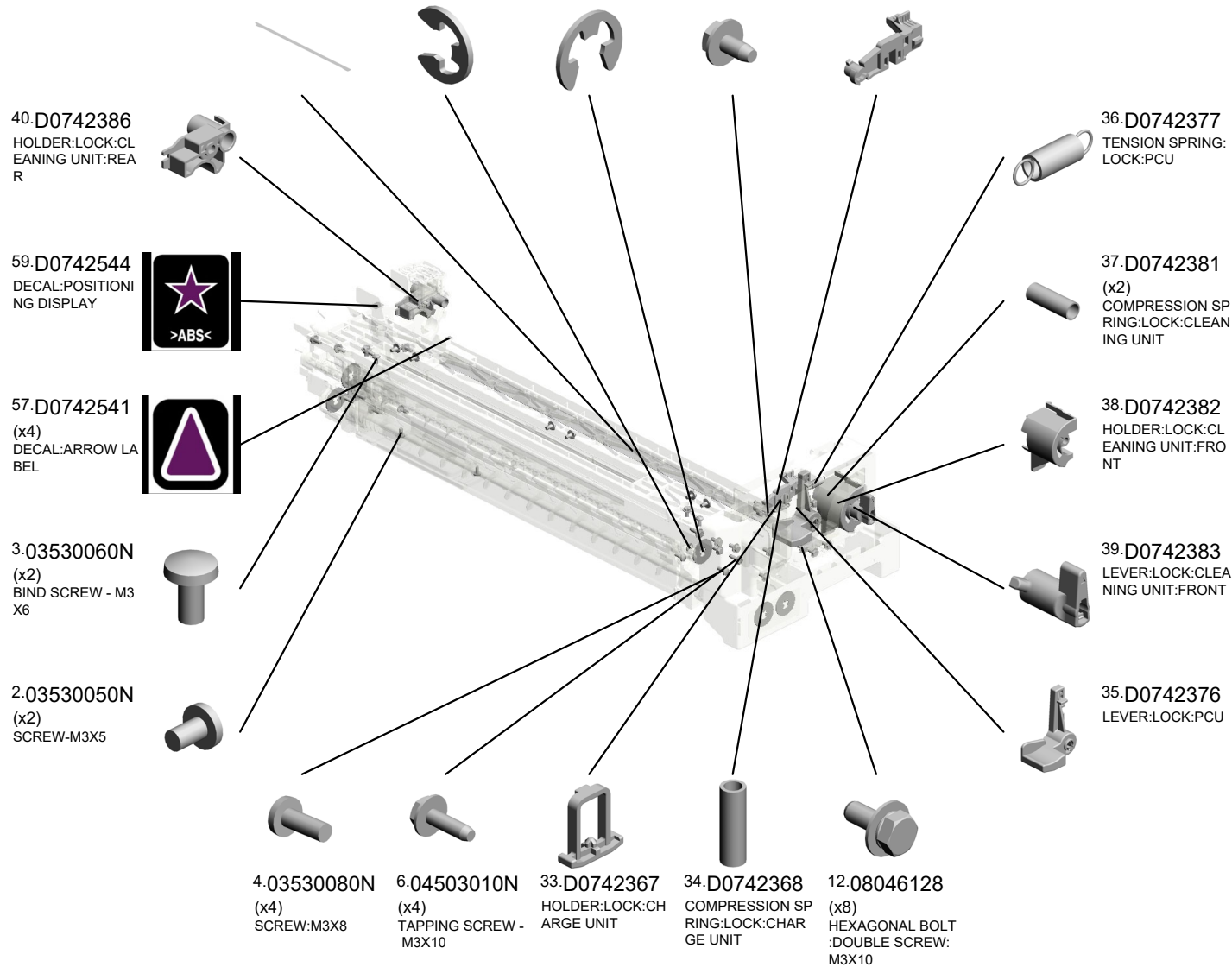

U008_S011
PCU:FC:ASS'Y

118.D1363407 SEAL:DEVELOPME
NT ROLLER:REAR
116.J0155505 DRAWER:CONNEC
TOR:USED DEVEL
PER:PLUG
67.D0743321 PLATE:FILTER
83.D1363431
**FILTER:DEVELOP
MENT**

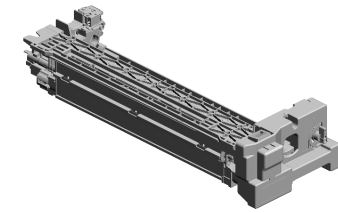

131.D1942307
[A]
PCU:FC:ASS'Y
201905-09 X/O

71.D0743367
ELECTRODE PLAT
E:DEVELOPMENT
BIAS:REAR UPPER

72.D0743368
ELECTRODE PLAT
E:DEVELOPMENT
BIAS:REAR LOWE
R

73.D0743427
RADIAL BALL BEA
RING:DIA8XDIA16X
5

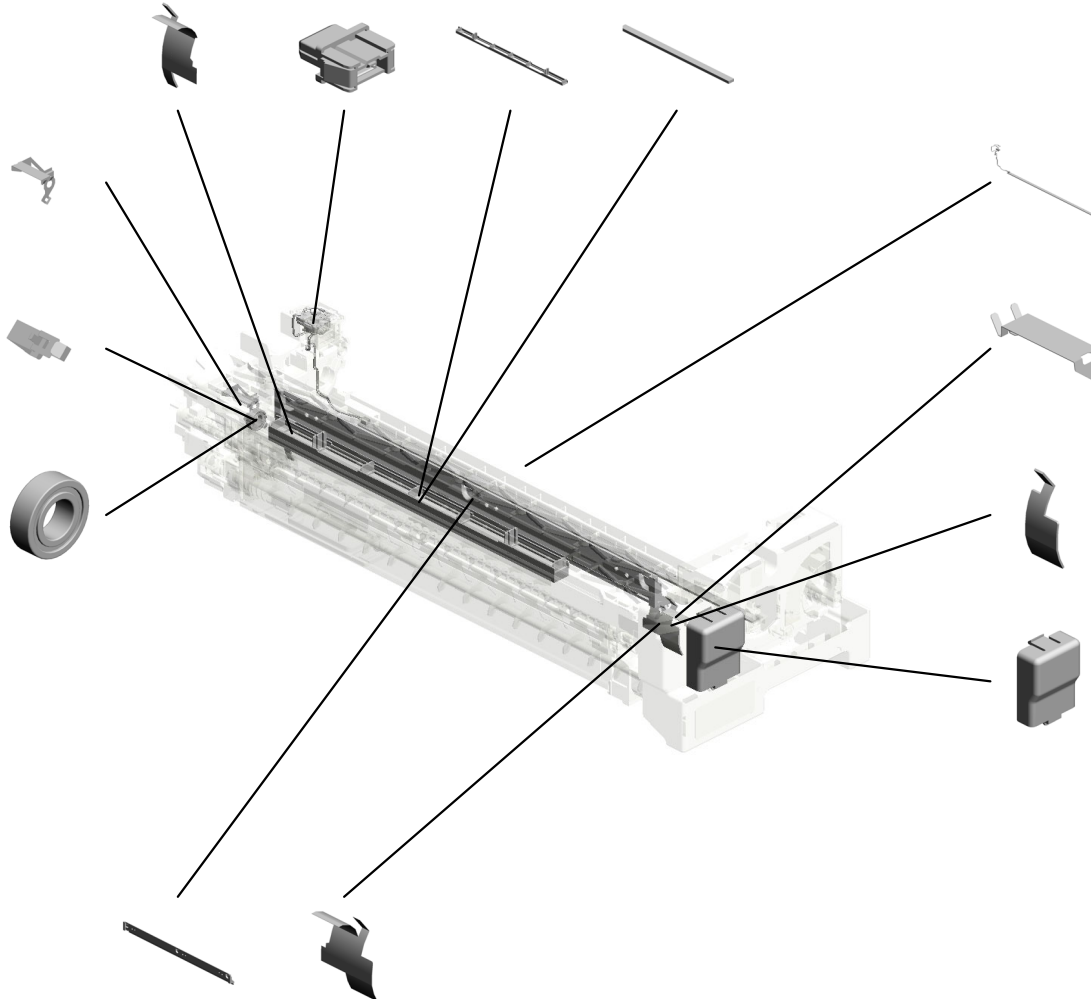

87.D1942191
DISCHARGE LAMP
:LED ARRAY

70.D0743362
ELECTRODE PLAT
E:DEVELOPMENT
BIAS:FRONT

142.D0A53456
SEAL:DEVELOPME
NT ROLLER:FRON
T:2
202011-03

74.D0743440
COVER:INSERT:DE
VELOPER

120.D1943330 ENTRANCE SEAL:
DEVELOPMENT:AS
S'Y
201608-04
143.D0A53457 SEAL:DEVELOPME
NT ROLLER:FRON
T:1
202011-04 O/O

D1942306
[A]
PCU:FC:ASS'Y
201905-09 X/O

U008_S011_S001
COVER:PCU:FRONT:ASS'Y

76.D0743829 42.D0742393
DECAL:POSITIONI COVER:PCU:FRON
NG DISPLAY:TCRU T

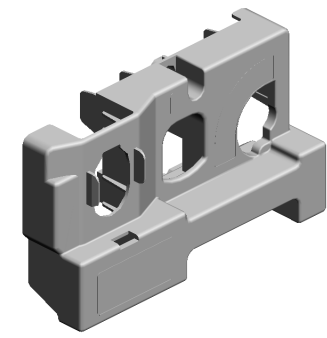

41.D0742392
COVER:PCU:FRON
T:ASS'Y

56.D0742540
DECAL:LOCK:CLE
ANING UNIT

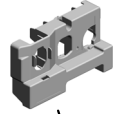

115.G0291980
DECAL - LD



43.D0742395
GROUND PLATE:P
CU:ASS'Y

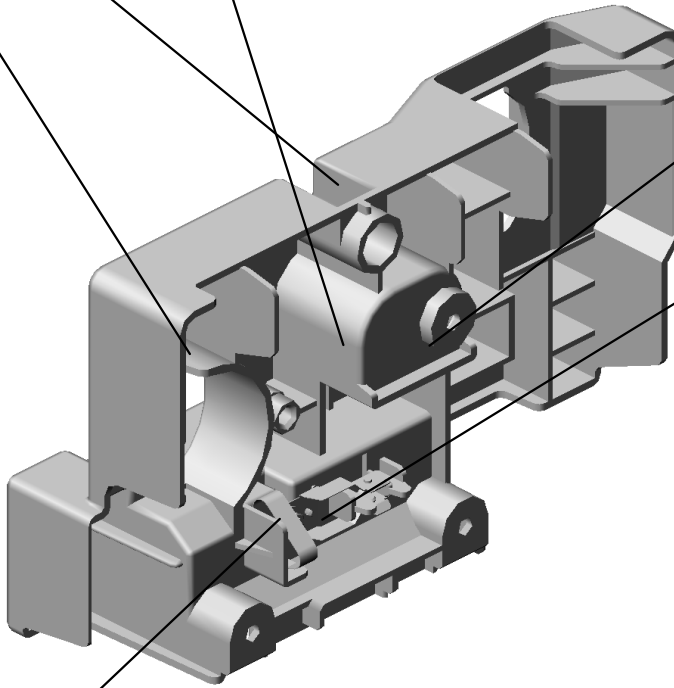

11.08025320
HEXAGON HEAD T
APPING SCREW:E
S:3X10

U001	U002	U003	U004	U005	U006	U007	U008	U009	U010	U011	U012	U013	U014	U015	U016	U017	U018	U019	U020	U021
------	------	------	------	------	------	------	------	------	------	------	------	------	------	------	------	------	------	------	------	------

U008_S011_S002
GUIDE:TONER SUPPLY:ASS'Y

69.D0743352
SEAL:GUIDE:TONE
R SUPPLY:UPPER

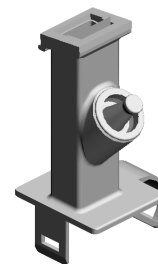

119.D0743216
GUIDE:TONER SU
PLY:ASSY

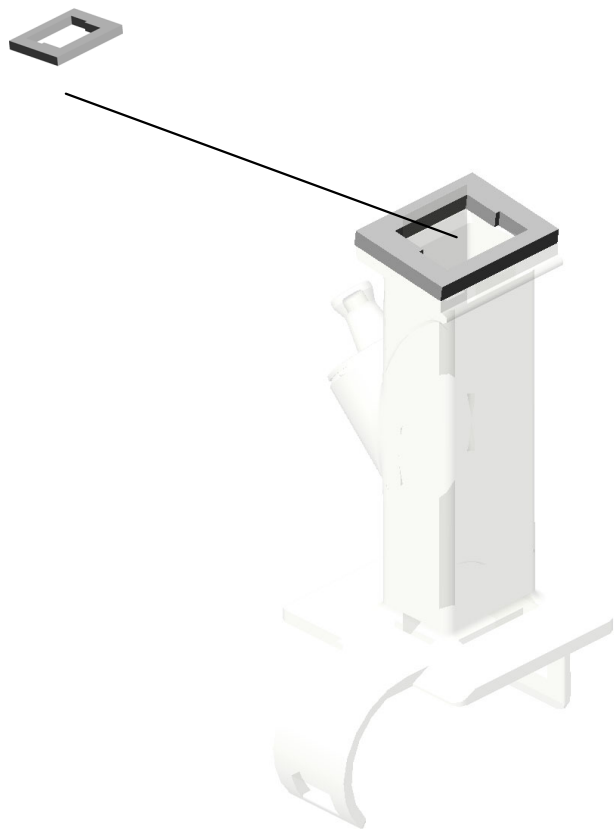

U001	U002	U003	U004	U005	U006	U007	U008	U009	U010	U011	U012	U013	U014	U015	U016	U017	U018	U019	U020	U021
------	------	------	------	------	------	------	-------------	------	------	------	------	------	------	------	------	------	------	------	------	------

U008_S012
CHARGE UNIT:ASS'Y

85.D1942165
DECAL:GRIP

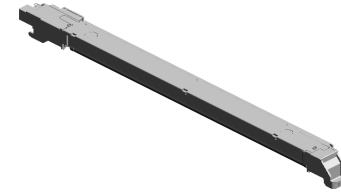

84.D1942150
CHARGE UNIT:ASS
'Y

U001	U002	U003	U004	U005	U006	U007	U008	U009	U010	U011	U012	U013	U014	U015	U016	U017	U018	U019	U020	U021
------	------	------	------	------	------	------	------	------	------	------	------	------	------	------	------	------	------	------	------	------

U008_S013
CLEANING UNIT:ASS'Y

- 48.D0742448 TRANSPORT SCR
EW:APPLY:ASS'Y
- 79.D1362411 COATING BAR:AS
S'Y
- 78.D2582402 OIL SUPPLY ROLL
ER:ASS'Y
201608-02 O/O
- 82.D1362441 BLADE:APPLY:AS
S'Y
- 81.D1362418 TENSION SPRING:
COATING BAR:18N



92.D1942330
CLEANING UNIT:AS
SS'Y

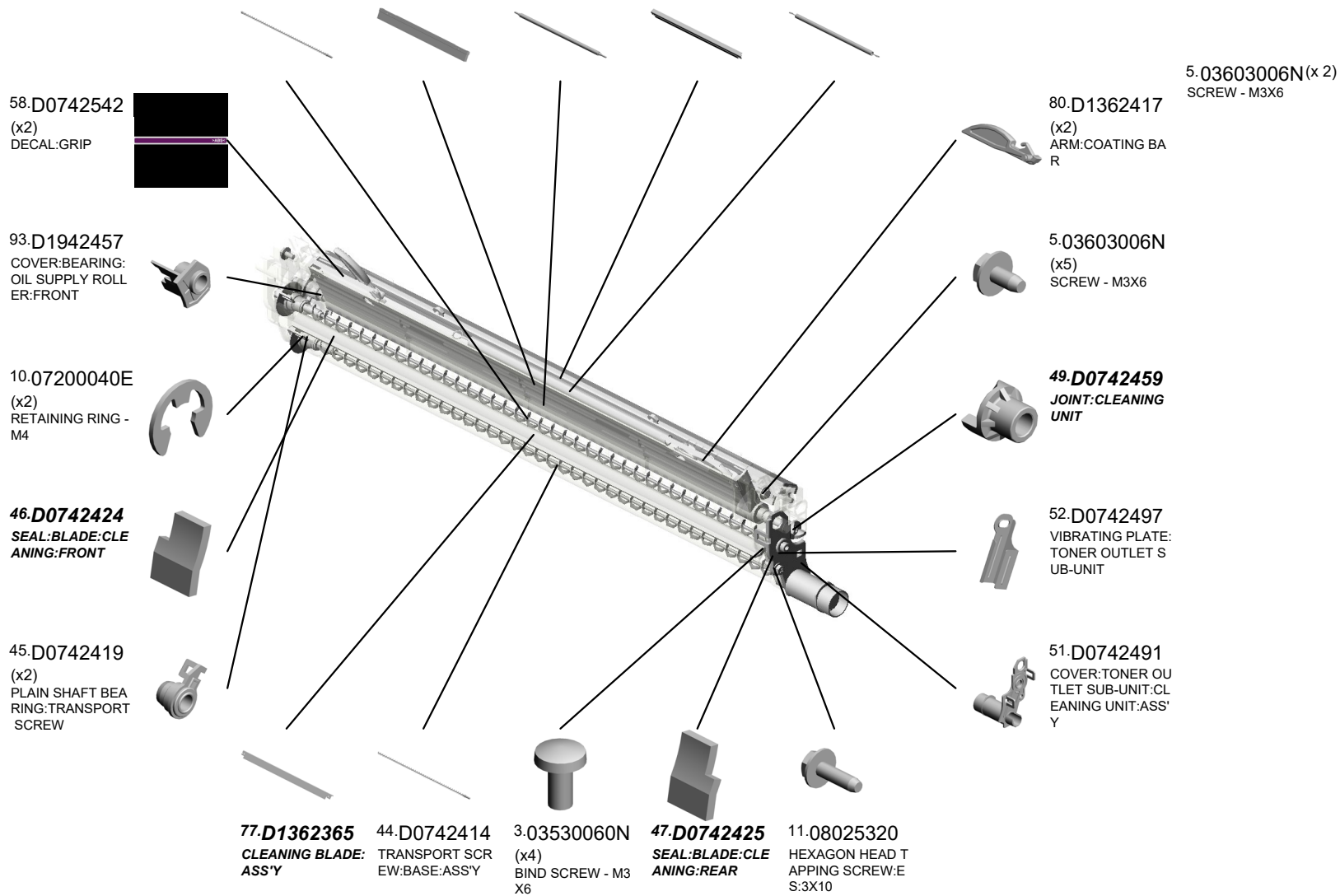

U008_S013
CLEANING UNIT:ASS'Y

146.D1942441 **97.D1942485**
SEAL:FRAME:COA
TING BAR:FRONT
SIDE (x2)
**SEAL:BLADE:APP
LY**



92.D1942330
CLEANING UNIT:A
SS'Y

99.D1942507
GROUND PLATE:O
IL SUPPLY ROLLE
R:ASS'Y



98.D1942506
DRUM STAY:CLEA
NING UNIT



147.D1942442
SEAL:FRAME:COA
TING BAR:REAR SI
DE



145.D1942440
SEAL:FRAME:APPL
Y:REAR SIDE



148.D1942443 94.D1942458
SEAL:FRAME:COA
TING BAR:UPPER COVER:BEARING:
OIL SUPPLY ROLL
ER:REAR



U001	U002	U003	U004	U005	U006	U007	U008	U009	U010	U011	U012	U013	U014	U015	U016	U017	U018	U019	U020	U021
------	------	------	------	------	------	------	-------------	------	------	------	------	------	------	------	------	------	------	------	------	------

U008_S013_S001
STAY:APPLY:ASS'Y

50.D0742477
(x2)
SHEET:STAY:APPL
Y

96.D1942475
STAY:APPLY:ASS'Y



5.03603006N
(x2)
SCREW - M3X6

U001	U002	U003	U004	U005	U006	U007	U008	U009	U010	U011	U012	U013	U014	U015	U016	U017	U018	U019	U020	U021
------	------	------	------	------	------	------	-------------	------	------	------	------	------	------	------	------	------	------	------	------	------

U008_S013_S002
GEAR:CLEANING:DRUM:SERVICE

54.D0742502
GEAR:IDLER:20Z:L
EFT



103.D1942550
GEAR:CLEANING:
DRUM:SERVICE

95.D1942460
GEAR:19Z:RIGHT

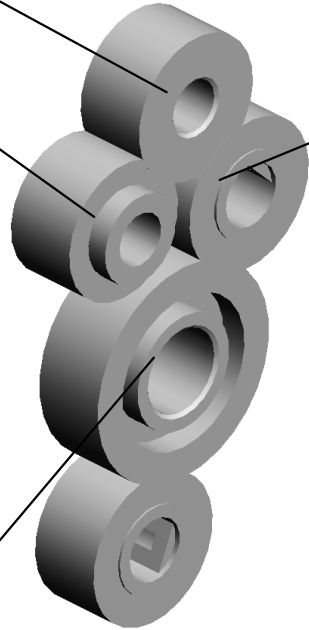

53.D0742501
(x2)
GEAR:21Z:RIGHT



55.D0742503
GEAR:IDLER:31Z:L
EFT



U001	U002	U003	U004	U005	U006	U007	U008	U009	U010	U011	U012	U013	U014	U015	U016	U017	U018	U019	U020	U021
------	------	------	------	------	------	------	-------------	------	------	------	------	------	------	------	------	------	------	------	------	------

U008_S014
PCU:FC:ASS'Y

- 40.D0742386 HOLDER:LOCK:CLEANING UNIT:REAR
- 28.D0742192 SHEET:DISCHARGE LAMP
- 9.07200030E RETAINING RING - M3
- 10.07200040E (x6) RETAINING RING - M4
- 32.D0742366 LEVER:LOCK:CHARGE UNIT

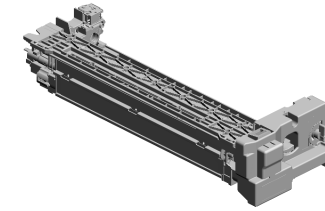

131.D1942307
[A]
PCU:FC:ASS'Y
201905-09 X/O

59.D0742544
DECAL:POSITIONING DISPLAY



57.D0742541
(x4)
DECAL:ARROW LABEL



3.03530060N
(x2)
BIND SCREW - M3 X6



6.04503010N
(x4)
TAPPING SCREW - M3X10



2.03530050N
(x2)
SCREW-M3X5



4.03530080N
(x4)
SCREW:M3X8



12.08046128
(x8)
HEXAGONAL BOLT :DOUBLE SCREW: M3X10



5.03603006N
(x18)
SCREW - M3X6



33.D0742367
HOLDER:LOCK:CHARGE UNIT



34.D0742368
COMPRESSION SPRING:LOCK:CHARGE UNIT



36.D0742377
TENSION SPRING: LOCK:PCU



37.D0742381
(x2)
COMPRESSION SPRING:LOCK:CLEANING UNIT



38.D0742382
HOLDER:LOCK:CLEANING UNIT:FRONT



39.D0742383
LEVER:LOCK:CLEANING UNIT:FRONT

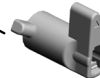

35.D0742376
LEVER:LOCK:PCU



U008_S014
PCU:FC:ASS'Y

118.D1363407 SEAL:DEVELOPMENT ROLLER:REAR
116.J0155505 DRAWER:CONNECTOR:USED DEVELOPER:PLUG
67.D0743321 PLATE:FILTER
83.D1363431
FILTER:DEVELOPMENT

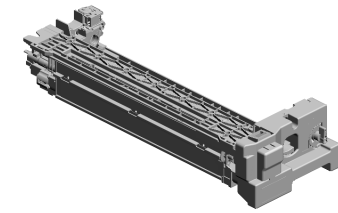

131.D1942307
[A]
PCU:FC:ASS'Y
201905-09 X/O

71.D0743367
ELECTRODE PLATE:DEVELOPMENT BIAS:REAR UPPER

72.D0743368
ELECTRODE PLATE:DEVELOPMENT BIAS:REAR LOWER

73.D0743427
RADIAL BALL BEARING:RING:DIAXDIA16X5

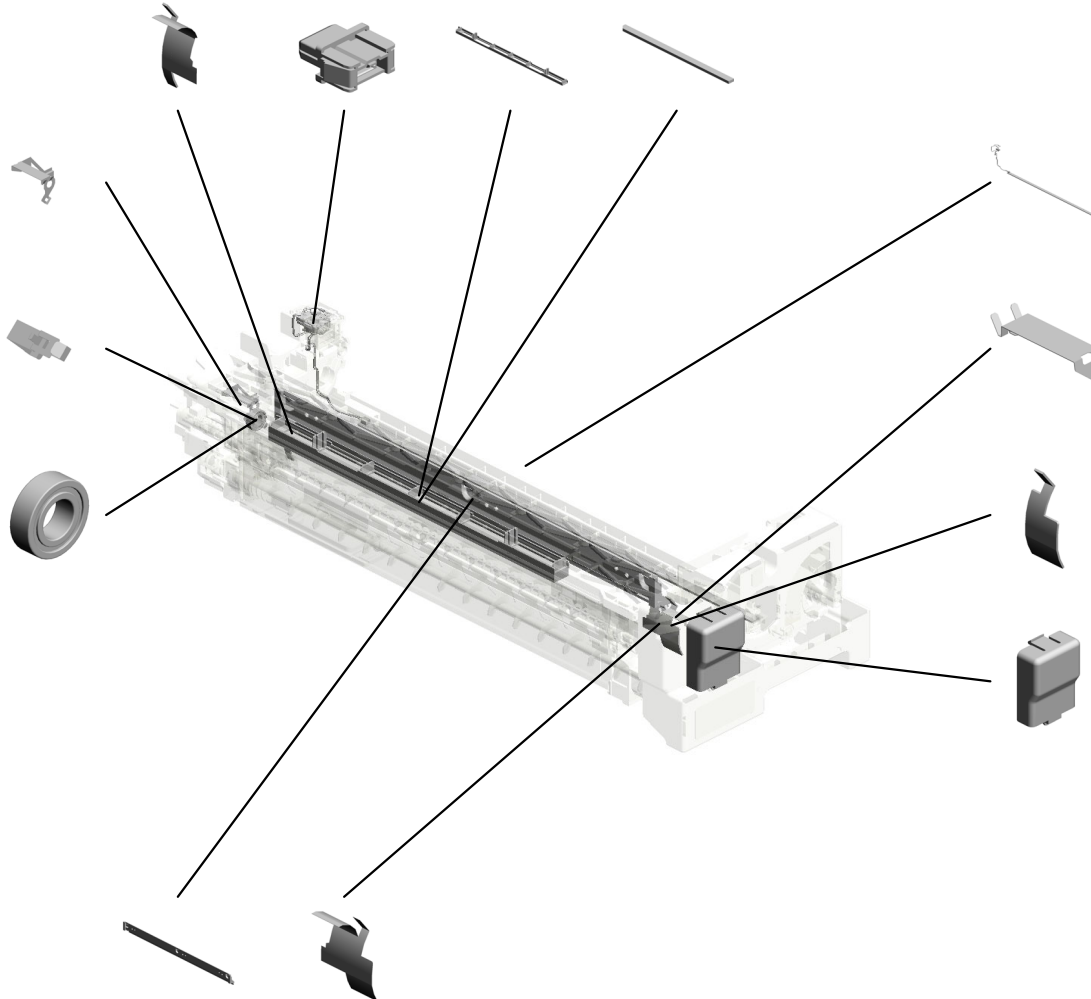

87.D1942191
DISCHARGE LAMP:LED ARRAY

70.D0743362
ELECTRODE PLATE:DEVELOPMENT BIAS:FRONT

142.D0A53456
SEAL:DEVELOPMENT ROLLER:FRONT:2
202011-03

74.D0743440
COVER:INSERT:DEVELOPER

120.D1943330 ENTRANCE SEAL:DEVELOPMENT:ASSY
201608-04
143.D0A53457 SEAL:DEVELOPMENT ROLLER:FRONT:1
202011-04 O/O

D1942306
[A]
PCU:FC:ASS'Y
201905-09 X/O

U008_S014_S001
COVER:PCU:FRONT:ASS'Y

76.D0743829 42.D0742393
DECAL:POSITIONI COVER:PCU:FRON
NG DISPLAY:TCRU T

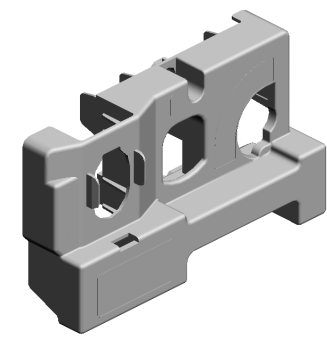

41.D0742392
COVER:PCU:FRON
T:ASS'Y

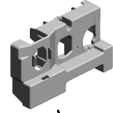

56.D0742540
DECAL:LOCK:CLE
ANING UNIT



115.G0291980
DECAL - LD



43.D0742395
GROUND PLATE:P
CU:ASS'Y

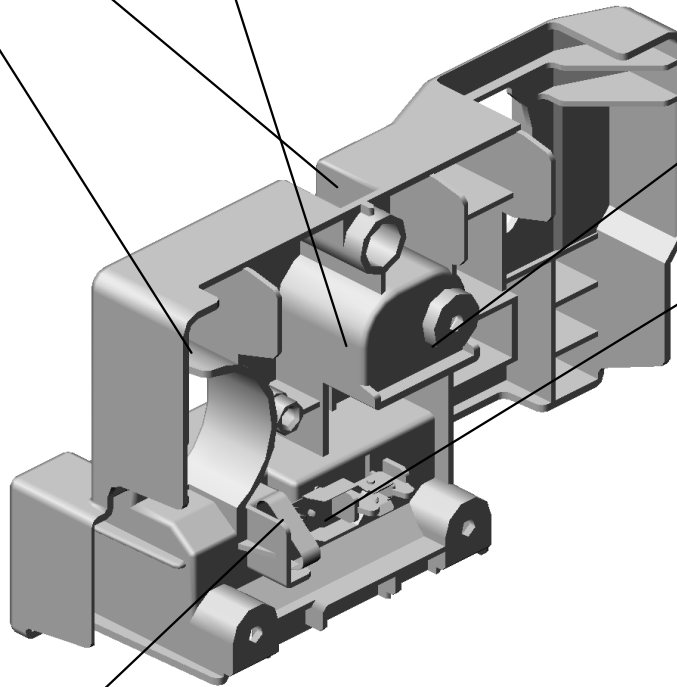

11.08025320
HEXAGON HEAD T
APPING SCREW:E
S:3X10

U001	U002	U003	U004	U005	U006	U007	U008	U009	U010	U011	U012	U013	U014	U015	U016	U017	U018	U019	U020	U021
------	------	------	------	------	------	------	------	------	------	------	------	------	------	------	------	------	------	------	------	------

U008_S014_S002
GUIDE:TONER SUPPLY:ASS'Y

69.D0743352
SEAL:GUIDE:TONE
R SUPPLY:UPPER

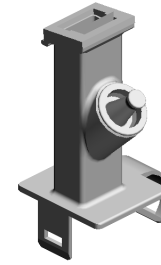

119.D0743216
GUIDE:TONER SU
PLY:ASSY



U001	U002	U003	U004	U005	U006	U007	U008	U009	U010	U011	U012	U013	U014	U015	U016	U017	U018	U019	U020	U021
------	------	------	------	------	------	------	-------------	------	------	------	------	------	------	------	------	------	------	------	------	------

U008_S015
CHARGE UNIT:ASS'Y

85.D1942165
DECAL:GRIP

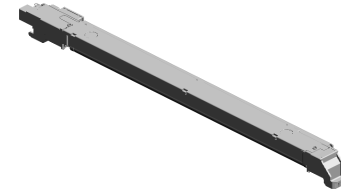

84.D1942150
CHARGE UNIT:ASS
'Y

U001	U002	U003	U004	U005	U006	U007	U008	U009	U010	U011	U012	U013	U014	U015	U016	U017	U018	U019	U020	U021
------	------	------	------	------	------	------	------	------	------	------	------	------	------	------	------	------	------	------	------	------

U008_S016
CLEANING UNIT:ASS'Y

- 48.D0742448 TRANSPORT SCR
EW:APPLY:ASS'Y
- 79.D1362411 COATING BAR:AS
S'Y
- 78.D2582402 OIL SUPPLY ROLL
ER:ASS'Y
201608-02 O/O
- 82.D1362441 BLADE:APPLY:AS
S'Y
- 81.D1362418 TENSION SPRING:
COATING BAR:18N



92.D1942330
CLEANING UNIT:AS
SS'Y

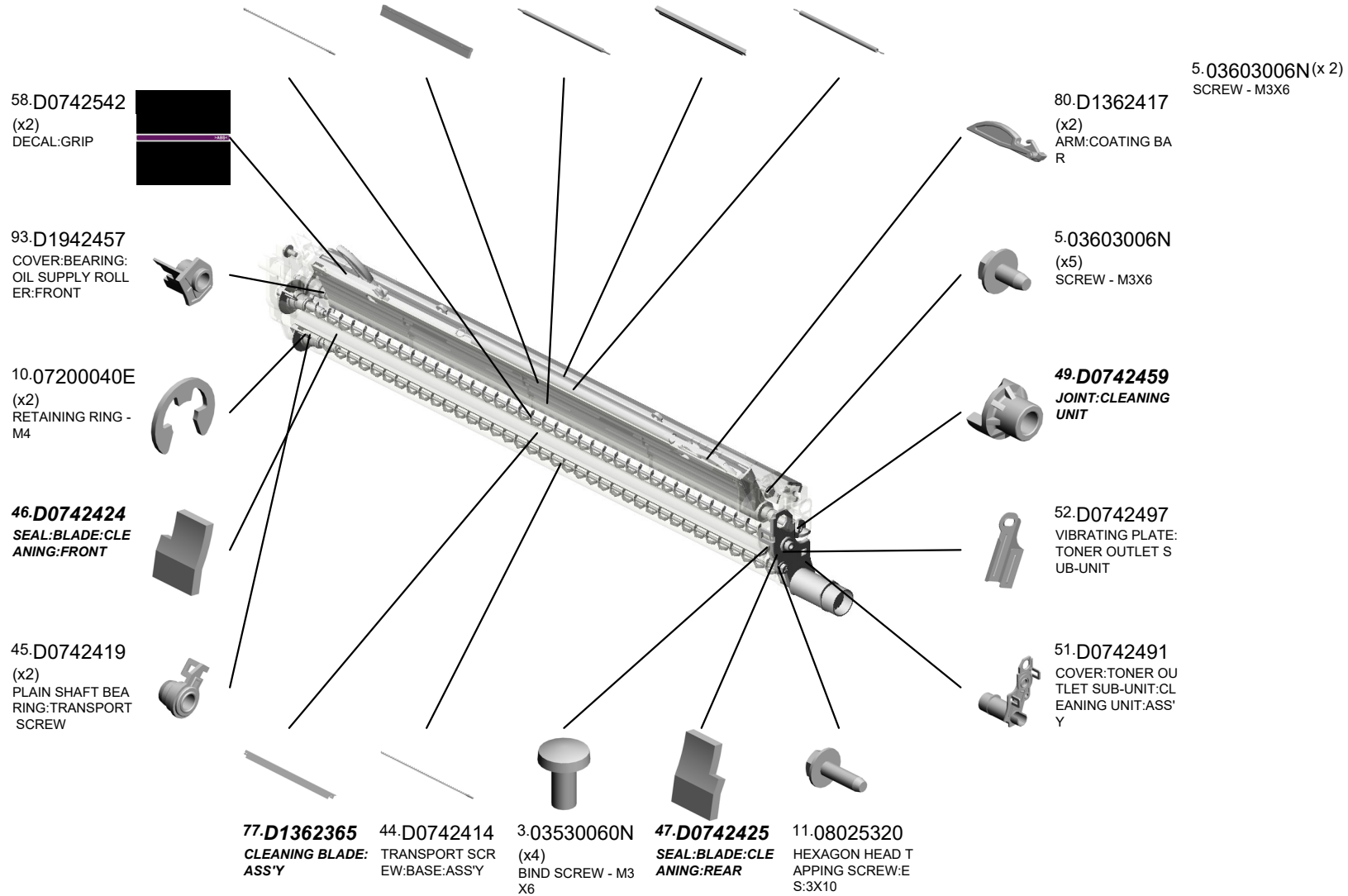

58.D0742542
(x2)
DECAL:GRIP



93.D1942457
COVER:BEARING:
OIL SUPPLY ROLL
ER:FRONT



10.07200040E
(x2)
RETAINING RING -
M4



46.D0742424
SEAL:BLADE:CLE
ANING:FRONT



45.D0742419
(x2)
PLAIN SHAFT BEA
RING:TRANSPORT
SCREW



77.D1362365
CLEANING BLADE:
ASS'Y

44.D0742414
TRANSPORT SCR
EW:BASE:ASS'Y

3.03530060N
(x4)
BIND SCREW - M3
X6

47.D0742425
SEAL:BLADE:CLE
ANING:REAR

11.08025320
HEXAGON HEAD T
APPING SCREW:E
S:3X10

80.D1362417
(x2)
ARM:COATING BA
R



5.03603006N
(x5)
SCREW - M3X6



49.D0742459
JOINT:CLEANING
UNIT



52.D0742497
VIBRATING PLATE:
TONER OUTLET S
UB-UNIT



51.D0742491
COVER:TONER OU
TLET SUB-UNIT:CL
EANING UNIT:ASS'
Y



5.03603006N(x 2)
SCREW - M3X6

U008_S016
CLEANING UNIT:ASS'Y

146.D1942441 **97.D1942485**
SEAL:FRAME:COA
TING BAR:FRONT
SIDE (x2)
**SEAL:BLADE:APP
LY**



92.D1942330
CLEANING UNIT:A
SS'Y

99.D1942507
GROUND PLATE:O
IL SUPPLY ROLLE
R:ASS'Y



98.D1942506
DRUM STAY:CLEA
NING UNIT



147.D1942442
SEAL:FRAME:COA
TING BAR:REAR SI
DE



145.D1942440
SEAL:FRAME:APPL
Y:REAR SIDE



148.D1942443 94.D1942458
SEAL:FRAME:COA
TING BAR:UPPER COVER:BEARING:
OIL SUPPLY ROLL
ER:REAR



U001	U002	U003	U004	U005	U006	U007	U008	U009	U010	U011	U012	U013	U014	U015	U016	U017	U018	U019	U020	U021
------	------	------	------	------	------	------	-------------	------	------	------	------	------	------	------	------	------	------	------	------	------

U008_S016_S001
STAY:APPLY:ASS'Y

50.D0742477
(x2)
SHEET:STAY:APPL
Y

96.D1942475
STAY:APPLY:ASS'Y



5.03603006N
(x2)
SCREW - M3X6

U001	U002	U003	U004	U005	U006	U007	U008	U009	U010	U011	U012	U013	U014	U015	U016	U017	U018	U019	U020	U021
------	------	------	------	------	------	------	-------------	------	------	------	------	------	------	------	------	------	------	------	------	------

U008_S016_S002
GEAR:CLEANING:DRUM:SERVICE

54.D0742502
GEAR:IDLER:20Z:L
EFT



103.D1942550
GEAR:CLEANING:
DRUM:SERVICE

95.D1942460
GEAR:19Z:RIGHT

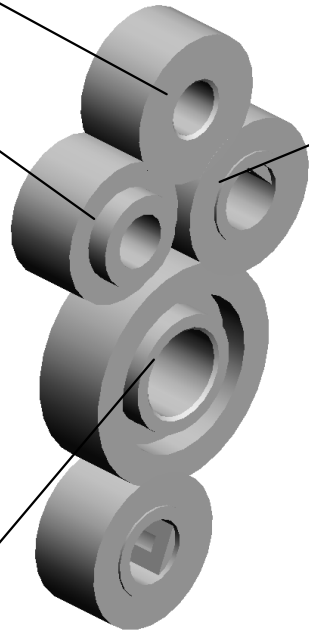

53.D0742501
(x2)
GEAR:21Z:RIGHT



55.D0742503
GEAR:IDLER:31Z:L
EFT



U001	U002	U003	U004	U005	U006	U007	U008	U009	U010	U011	U012	U013	U014	U015	U016	U017	U018	U019	U020	U021
------	------	------	------	------	------	------	-------------	------	------	------	------	------	------	------	------	------	------	------	------	------

U008_S017
PCU:FC:ASS'Y

- 28.D0742192 SHEET:DISCHARGE LAMP
- 9.07200030E RETAINING RING - M3
- 10.07200040E (x6) RETAINING RING - M4
- 5.03603006N (x18) SCREW - M3X6
- 32.D0742366 LEVER:LOCK:CHARGE UNIT

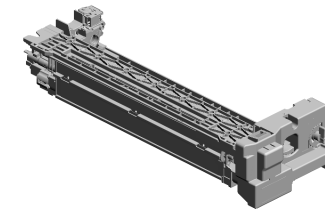

131.D1942307
[A]
PCU:FC:ASS'Y
201905-09 X/O

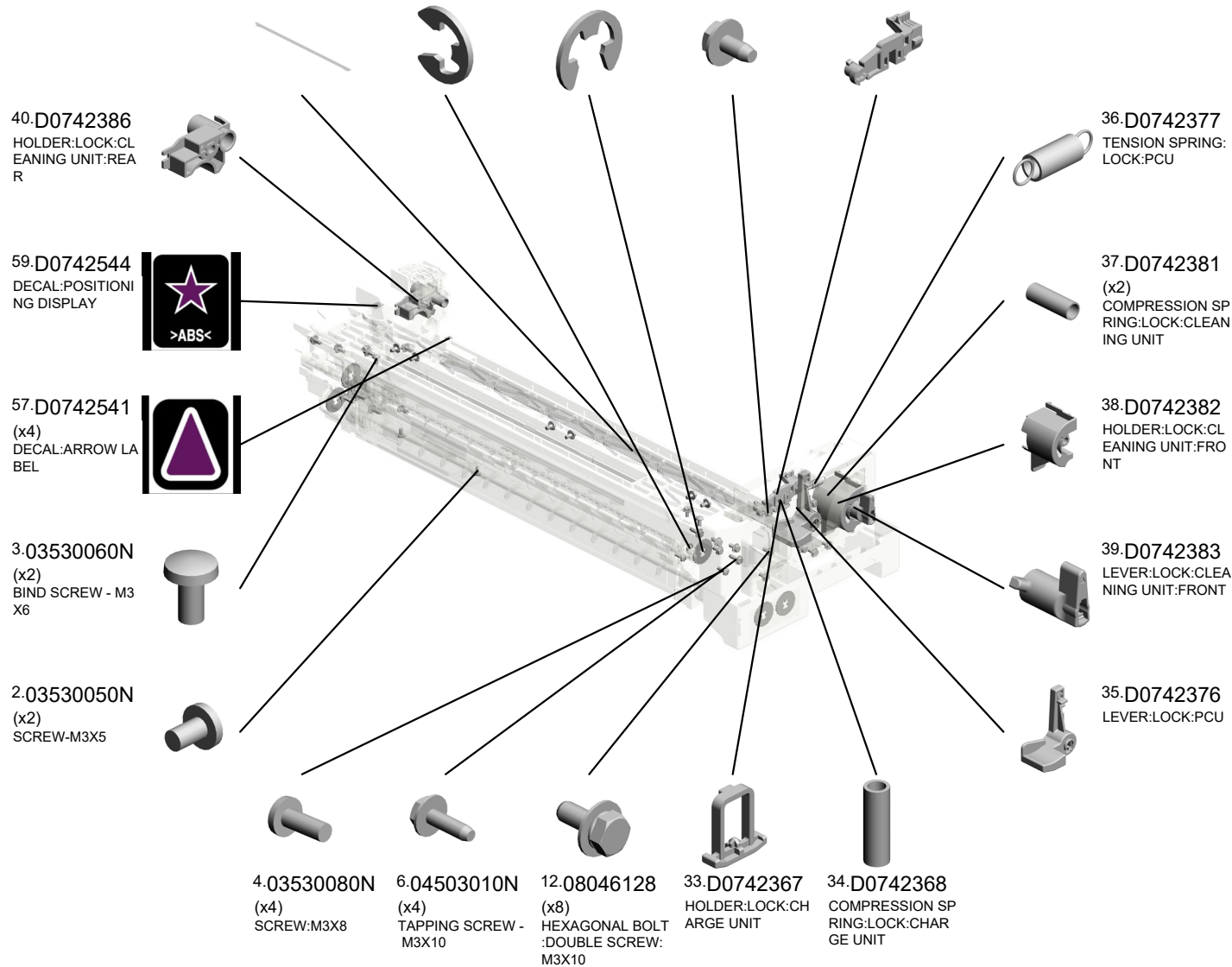

U008_S017
PCU:FC:ASS'Y

118.D1363407 SEAL:DEVELOPME
NT ROLLER:REAR
116.J0155505 DRAWER:CONNEC
TOR:USED DEVEL
PER:PLUG
67.D0743321 PLATE:FILTER
83.D1363431
**FILTER:DEVELOP
MENT**

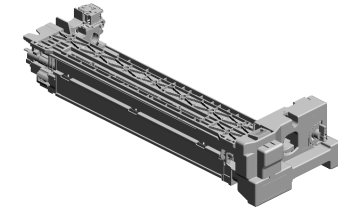

131.D1942307
[A]
PCU:FC:ASS'Y
201905-09 X/O

71.D0743367
ELECTRODE PLAT
E:DEVELOPMENT
BIAS:REAR UPPER

72.D0743368
ELECTRODE PLAT
E:DEVELOPMENT
BIAS:REAR LOWE
R

73.D0743427
RADIAL BALL BEA
RING:DIA8XDIA16X
5

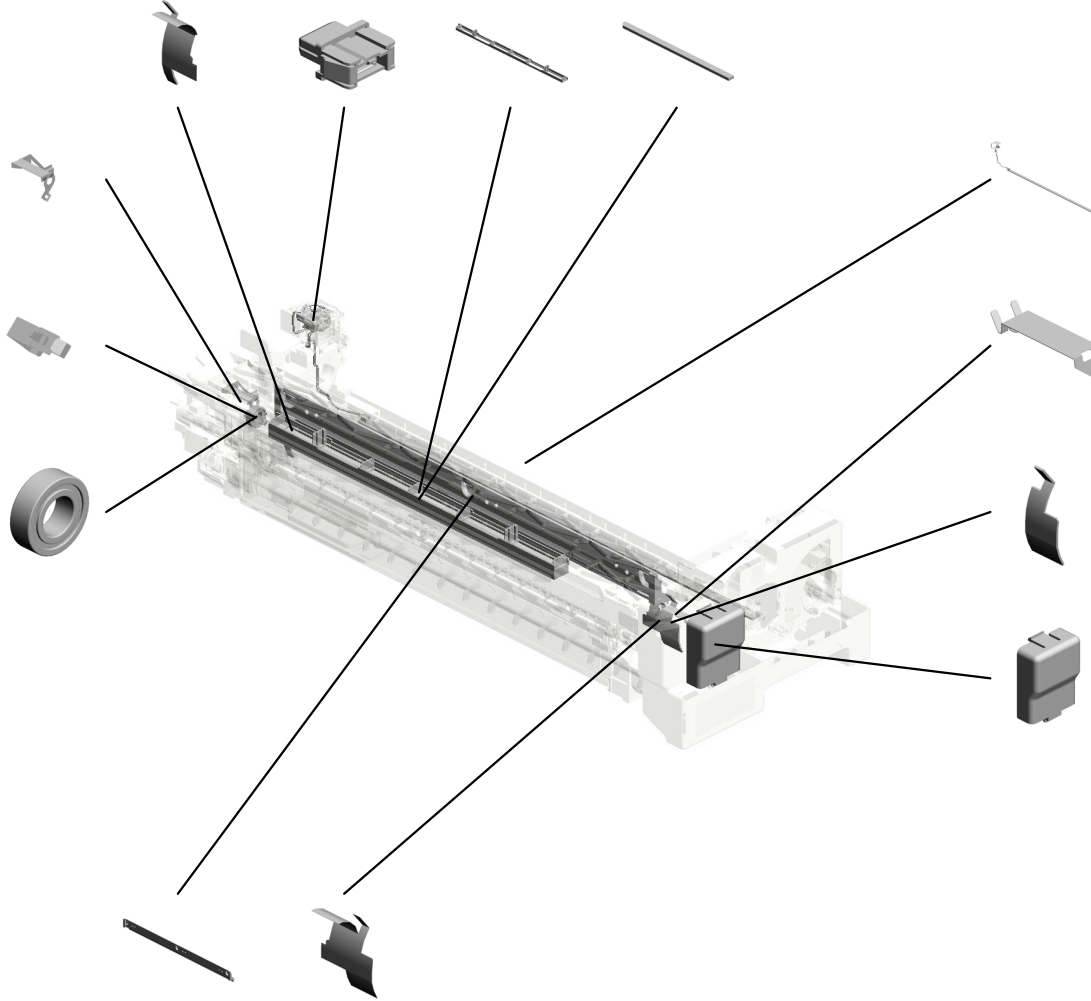

87.D1942191
DISCHARGE LAMP
:LED ARRAY

70.D0743362
ELECTRODE PLAT
E:DEVELOPMENT
BIAS:FRONT

142.D0A53456
SEAL:DEVELOPME
NT ROLLER:FRON
T:2
202011-03

74.D0743440
COVER:INSERT:DE
VELOPER

120.D1943330 ENTRANCE SEAL:
DEVELOPMENT:AS
S'Y
201608-04
143.D0A53457 SEAL:DEVELOPME
NT ROLLER:FRON
T:1
202011-04 O/O

D1942306
[A]
PCU:FC:ASS'Y
201905-09 X/O

U008_S017_S001
COVER:PCU:FRONT:ASS'Y

76.D0743829 42.D0742393
DECAL:POSITIONI COVER:PCU:FRON
NG DISPLAY:TCRU T

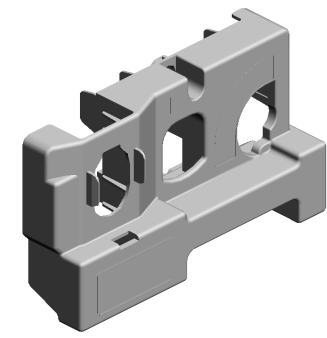

41.D0742392
COVER:PCU:FRON
T:ASS'Y

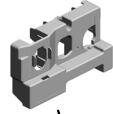

56.D0742540
DECAL:LOCK:CLE
ANING UNIT



115.G0291980
DECAL - LD



43.D0742395
GROUND PLATE:P
CU:ASS'Y

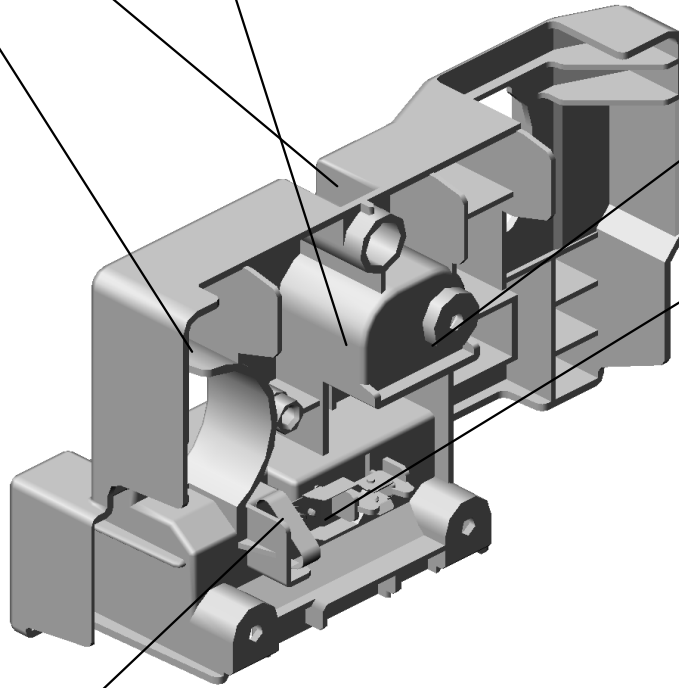

11.08025320
HEXAGON HEAD T
APPING SCREW:E
S:3X10

U001	U002	U003	U004	U005	U006	U007	U008	U009	U010	U011	U012	U013	U014	U015	U016	U017	U018	U019	U020	U021
------	------	------	------	------	------	------	------	------	------	------	------	------	------	------	------	------	------	------	------	------

U008_S017_S002
GUIDE:TONER SUPPLY:ASS'Y

69.D0743352
SEAL:GUIDE:TONE
R SUPPLY:UPPER

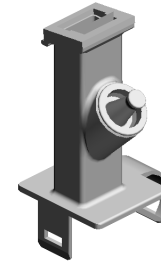

119.D0743216
GUIDE:TONER SU
PLY:ASSY



U001	U002	U003	U004	U005	U006	U007	U008	U009	U010	U011	U012	U013	U014	U015	U016	U017	U018	U019	U020	U021
------	------	------	------	------	------	------	-------------	------	------	------	------	------	------	------	------	------	------	------	------	------

U008_S018
CHARGE UNIT:ASS'Y

85.D1942165
DECAL:GRIP

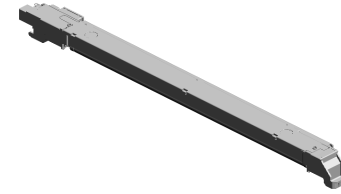
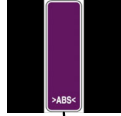

84.D1942150
CHARGE UNIT:ASS
'Y

U001	U002	U003	U004	U005	U006	U007	U008	U009	U010	U011	U012	U013	U014	U015	U016	U017	U018	U019	U020	U021
------	------	------	------	------	------	------	------	------	------	------	------	------	------	------	------	------	------	------	------	------

U008_S019
CLEANING UNIT:ASS'Y

48.D0742448 TRANSPORT SCR
EW:APPLY:ASS'Y

79.D1362411 COATING BAR:AS
S'Y

78.D2582402 OIL SUPPLY ROLL
ER:ASS'Y
201608-02 O/O

82.D1362441 BLADE:APPLY:AS
S'Y

81.D1362418 TENSION SPRING:
COATING BAR:18N



92.D1942330
CLEANING UNIT:AS
SS'Y

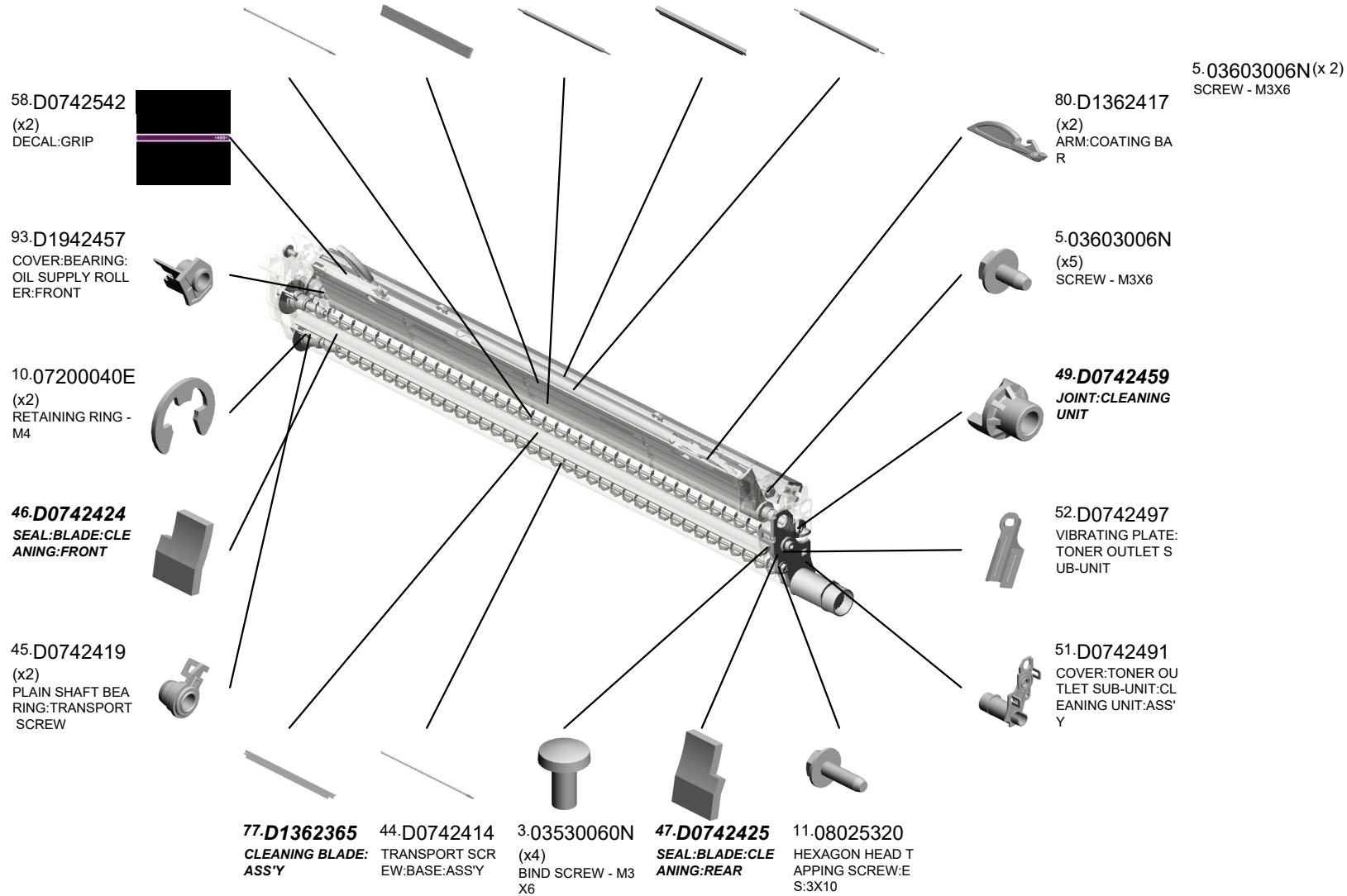

U008_S019
CLEANING UNIT:ASS'Y

146.D1942441 **97.D1942485**
SEAL:FRAME:COA
TING BAR:FRONT
SIDE (x2)
**SEAL:BLADE:APP
LY**



92.D1942330
CLEANING UNIT:A
SS'Y

99.D1942507
GROUND PLATE:O
IL SUPPLY ROLLE
R:ASS'Y



98.D1942506
DRUM STAY:CLEA
NING UNIT



147.D1942442
SEAL:FRAME:COA
TING BAR:REAR SI
DE



145.D1942440
SEAL:FRAME:APPL
Y:REAR SIDE



148.D1942443 94.D1942458
SEAL:FRAME:COA
TING BAR:UPPER COVER:BEARING:
OIL SUPPLY ROLL
ER:REAR



U008_S019_S001
STAY:APPLY:ASS'Y

50.D0742477
(x2)
SHEET:STAY:APPL
Y

96.D1942475
STAY:APPLY:ASS'Y



5.03603006N
(x2)
SCREW - M3X6



U001	U002	U003	U004	U005	U006	U007	U008	U009	U010	U011	U012	U013	U014	U015	U016	U017	U018	U019	U020	U021
------	------	------	------	------	------	------	-------------	------	------	------	------	------	------	------	------	------	------	------	------	------

U008_S019_S002
GEAR:CLEANING:DRUM:SERVICE

54.D0742502
GEAR:IDLER:20Z:L
EFT



103.D1942550
GEAR:CLEANING:
DRUM:SERVICE

95.D1942460
GEAR:19Z:RIGHT

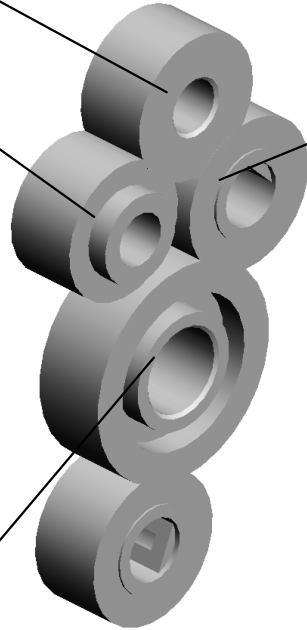

53.D0742501
(x2)
GEAR:21Z:RIGHT



55.D0742503
GEAR:IDLER:31Z:L
EFT



U001	U002	U003	U004	U005	U006	U007	U008	U009	U010	U011	U012	U013	U014	U015	U016	U017	U018	U019	U020	U021
------	------	------	------	------	------	------	-------------	------	------	------	------	------	------	------	------	------	------	------	------	------

U008_S020
PCU:ASS'Y

- 40.D0742386 HOLDER:LOCK:CLEANING UNIT:REAR
- 28.D0742192 SHEET:DISCHARGE LAMP
- 9.07200030E RETAINING RING - M3
- 10.07200040E (x6) RETAINING RING - M4
- 32.D0742366 LEVER:LOCK:CHARGE UNIT

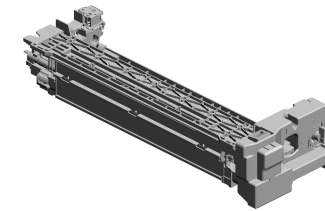

130.D1942304
[A]
PCU:ASS'Y
201905-08 X/O

59.D0742544
DECAL:POSITIONING DISPLAY



57.D0742541
(x4)
DECAL:ARROW LABEL



3.03530060N
(x2)
BIND SCREW - M3 X6



6.04503010N
(x4)
TAPPING SCREW - M3X10



2.03530050N
(x2)
SCREW-M3X5



4.03530080N
(x4)
SCREW:M3X8



5.03603006N
(x18)
SCREW - M3X6



33.D0742367
HOLDER:LOCK:CHARGE UNIT



34.D0742368
COMPRESSION SPRING:LOCK:CHARGE UNIT



12.08046128
(x8)
HEXAGONAL BOLT:DOUBLE SCREW: M3X10



36.D0742377
TENSION SPRING:LOCK:PCU



37.D0742381
(x2)
COMPRESSION SPRING:LOCK:CLEANING UNIT



38.D0742382
HOLDER:LOCK:CLEANING UNIT:FRONT



35.D0742376
LEVER:LOCK:PCU



39.D0742383
LEVER:LOCK:CLEANING UNIT:FRONT



U008_S020
PCU:ASS'Y

118.D1363407 SEAL:DEVELOPMENT ROLLER:REAR
116.J0155505 DRAWER:CONNECTOR:USED DEVELOPER:PLUG
67.D0743321 PLATE:FILTER
83.D1363431
FILTER:DEVELOPMENT

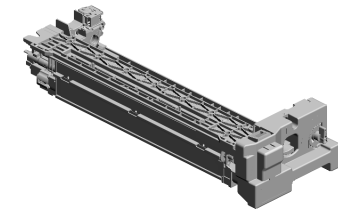

130.D1942304
[A]
PCU:ASS'Y
201905-08 X/O

71.D0743367
ELECTRODE PLATE:DEVELOPMENT BIAS:REAR UPPER

73.D0743427
RADIAL BALL BEARING:Ø16X5

72.D0743368
ELECTRODE PLATE:DEVELOPMENT BIAS:REAR LOWER

87.D1942191
DISCHARGE LAMP:LED ARRAY

70.D0743362
ELECTRODE PLATE:DEVELOPMENT BIAS:FRONT

142.D0A53456
SEAL:DEVELOPMENT ROLLER:FRONT:2
202011-03

74.D0743440
COVER:INSERT:DEVELOPER

120.D1943330 ENTRANCE SEAL:DEVELOPMENT:ASSY
201608-04
143.D0A53457 SEAL:DEVELOPMENT ROLLER:FRONT:1
202011-04 O/O

D1942303
[A]
PCU:ASS'Y
201905-08 X/O

U008_S020_S001
COVER:PCU:FRONT:ASS'Y

76.D0743829 42.D0742393
DECAL:POSITIONI COVER:PCU:FRON
NG DISPLAY:TCRU T

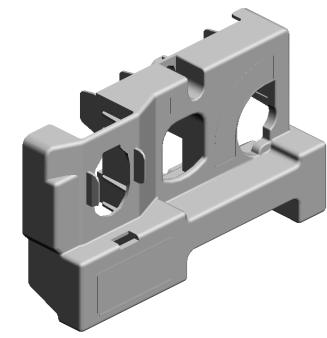

41.D0742392
COVER:PCU:FRON
T:ASS'Y

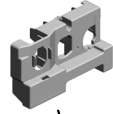

56.D0742540
DECAL:LOCK:CLE
ANING UNIT



115.G0291980
DECAL - LD



43.D0742395
GROUND PLATE:P
CU:ASS'Y

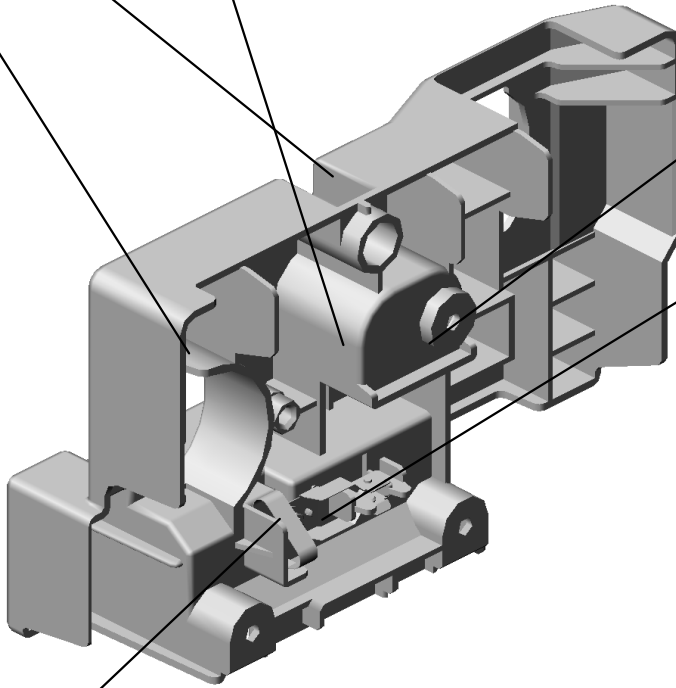

11.08025320
HEXAGON HEAD T
APPING SCREW:E
S:3X10

U001	U002	U003	U004	U005	U006	U007	U008	U009	U010	U011	U012	U013	U014	U015	U016	U017	U018	U019	U020	U021
------	------	------	------	------	------	------	------	------	------	------	------	------	------	------	------	------	------	------	------	------

U008_S020_S002
GUIDE:TONER SUPPLY:ASS'Y

69.D0743352
SEAL:GUIDE:TONE
R SUPPLY:UPPER

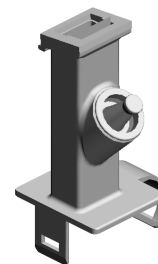

119.D0743216
GUIDE:TONER SU
PLY:ASSY

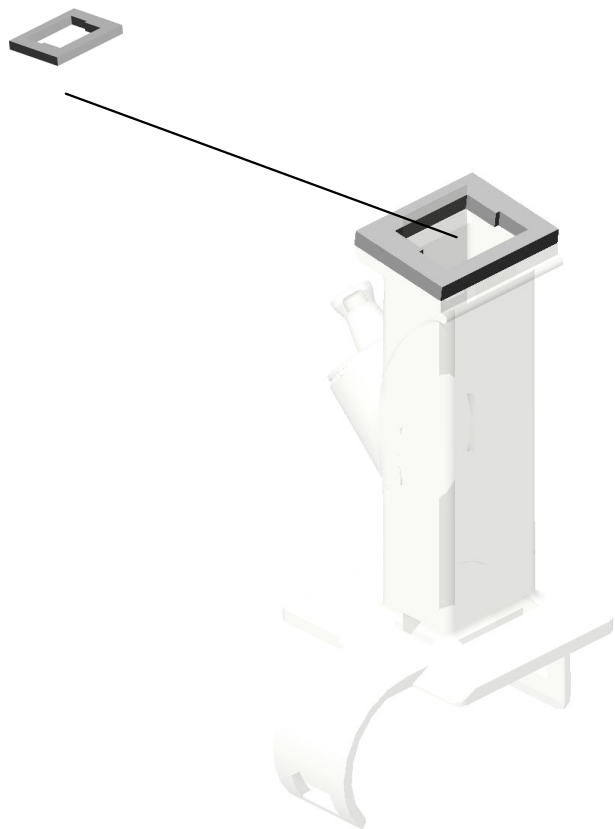

U001	U002	U003	U004	U005	U006	U007	U008	U009	U010	U011	U012	U013	U014	U015	U016	U017	U018	U019	U020	U021
------	------	------	------	------	------	------	-------------	------	------	------	------	------	------	------	------	------	------	------	------	------

U009.ITB UNIT

U009 S002
D1946262
SERVICE PARTS:COIL SPRI
NG:TRANSFER ROLLER:EXC
HANGEABLE:20N

U009 S003
D1946262
SERVICE PARTS:COIL SPRI
NG:TRANSFER ROLLER:EXC
HANGEABLE:20N

U009 S004
D1946263
SERVICE PARTS:COIL SPRI
NG:TRANSFER ROLLER:EXC
HANGEABLE:30N

U009 S001
D0743808
CASE:TENSION:ROLLER:AS
S'Y

U009 S008
D1946231
ROLLER:OPPOSED:TRANSF
ER:PAPER:ASS'Y

U009 S005
D1946263
SERVICE PARTS:COIL SPRI
NG:TRANSFER ROLLER:EXC
HANGEABLE:30N

U009 S006
D1946266
SERVICE PARTS:COIL SPRI
NG:TRANSFER ROLLER:EXC
HANGEABLE:60N

U009 S007
D1946266
SERVICE PARTS:COIL SPRI
NG:TRANSFER ROLLER:EXC
HANGEABLE:60N

U009 S009
D1946420
POSITIONING SENSOR:SCA
LE:INTERMEDIATE TRANSFE
R:ASSY

U009 S010
D1946210
GUIDE:TRANSPORT:INTERM
EDIATE TRANSFER:ASS'Y

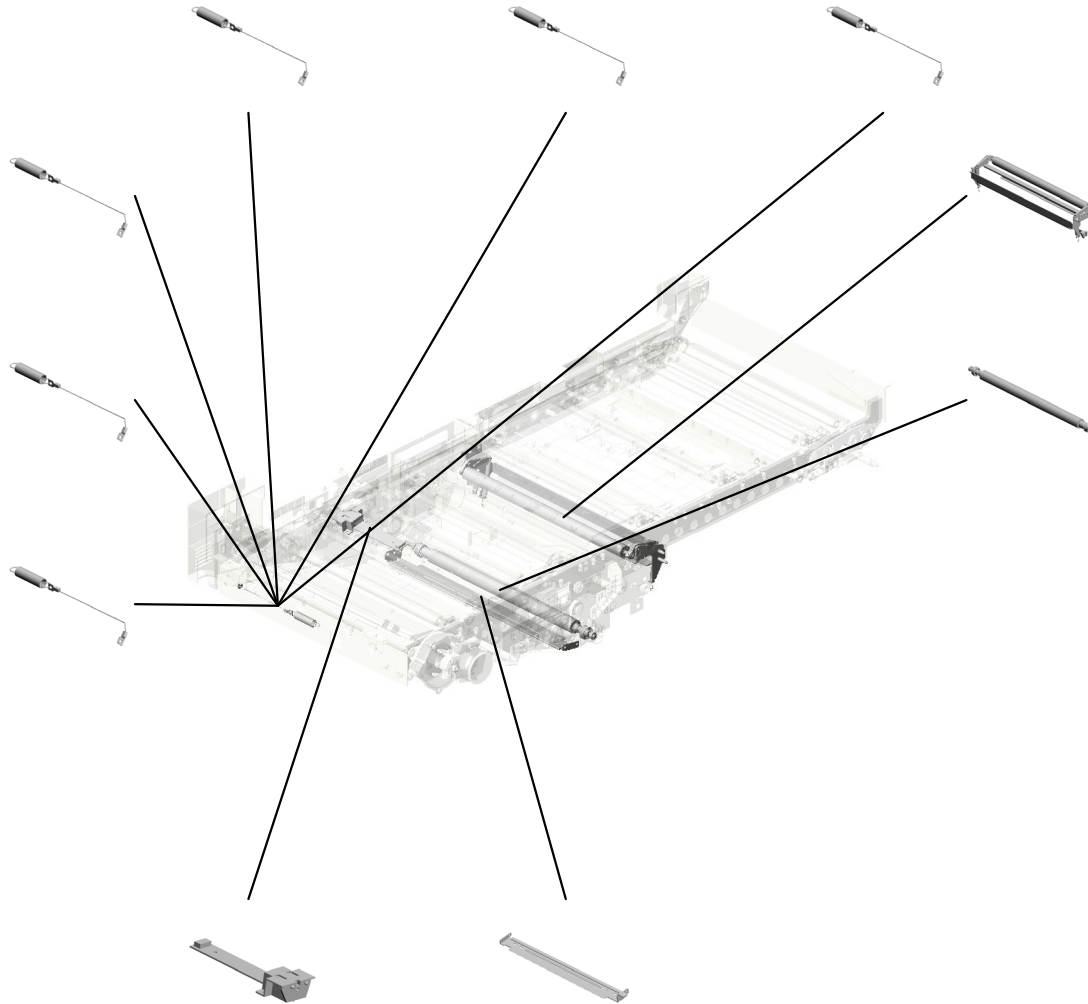

U001	U002	U003	U004	U005	U006	U007	U008	U009	U010	U011	U012	U013	U014	U015	U016	U017	U018	U019	U020	U021
------	------	------	------	------	------	------	------	------	------	------	------	------	------	------	------	------	------	------	------	------

U009_S001.CASE:TENSION:ROLLER:ASS'Y

U009 S001 S001
D0746379
ROLLER:TENSION:ASS'Y



U001	U002	U003	U004	U005	U006	U007	U008	U009	U010	U011	U012	U013	U014	U015	U016	U017	U018	U019	U020	U021
------	------	------	------	------	------	------	------	------	------	------	------	------	------	------	------	------	------	------	------	------

U009 ITB UNIT

- 11.04523008N TAPPING SCREW - M3X8
- 2.03530060N (x27) BIND SCREW - M3 X6
- 20.09544008N (x3) SCREW - M4X8
- 8.03604008N (x18) SCREW - M4X8
- 8.D1946236 (x2) HEXAGON HEAD SCREW:WASHER:M 4X10:ASSY 201502-07 X/O

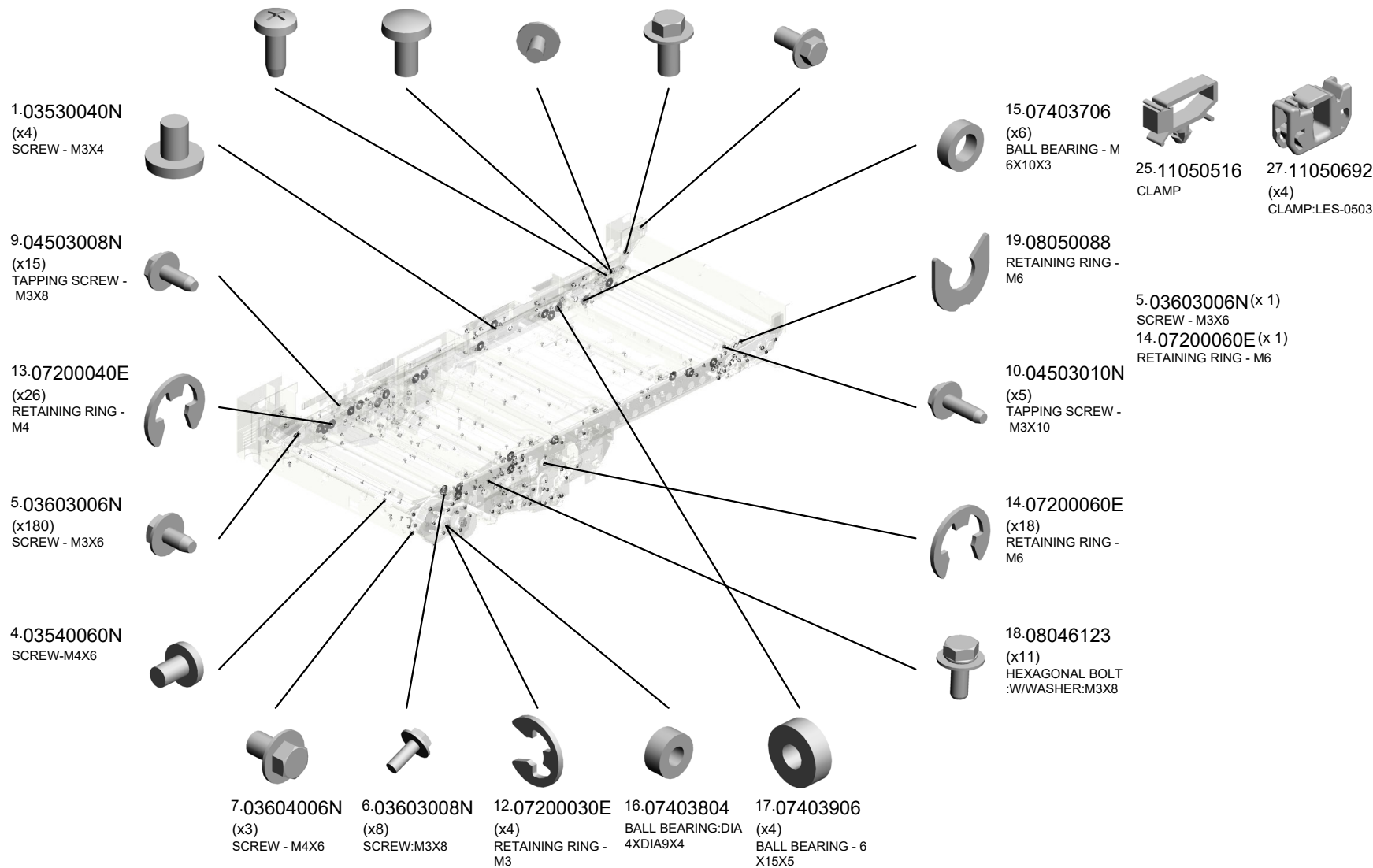
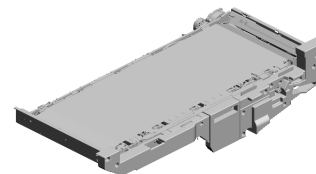

U001	U002	U003	U004	U005	U006	U007	U008	U009	U010	U011	U012	U013	U014	U015	U016	U017	U018	U019	U020	U021
------	------	------	------	------	------	------	------	------	------	------	------	------	------	------	------	------	------	------	------	------

U009 ITB UNIT

- 21.11050409 (x10) CARD SPACER- 6.4MM
- 26.11050534 (x3) CLAMP
- 23.11050508 HARNESS CLAMP - LWS-0711
- 38.AA082144 (x8) BUSHING - 8X12X7
- 40.AA143744 (x2) STEPPED SCREW

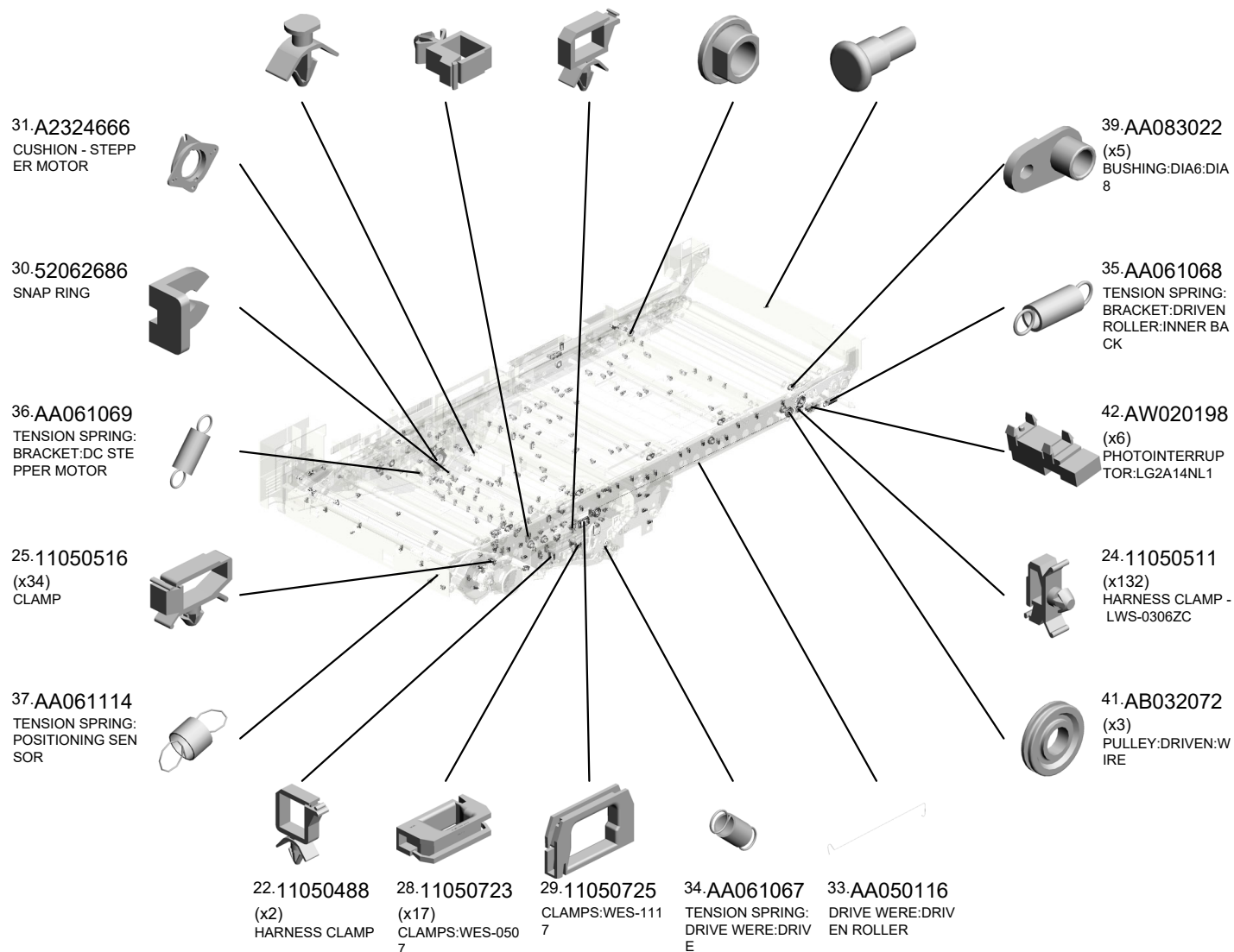
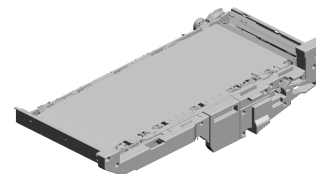

U009
ITB UNIT

- 51.AZ300065 (x5) POWER PACK
- 48.AX060394 DC STEPPER MOTOR:MM42:1.2A:3.60V
- 56.B2342390 (x3) FLANGED HEXAGONAL HEAD BOLT:M4X8
- 52.AZ300066 POWER PACK
- 63.D0743821 (x9) TENSION SPRING:PRESSURE:INTERMEDIATE TRANSFER:COLLAR

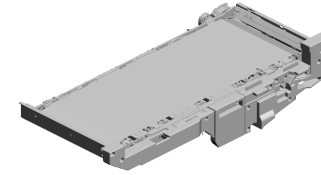

- 65.D0743829 (x3) DECAL:POSITIONING DISPLAY:TCRUI



- 57.C2363237 (x4) COLLAR 6X11.2X1.5



- 54.B1326114 CAM:ON-OFF:BLACK



- 59.D0396327 (x6) SPACER:SENSOR:TM



- 44.AW020218 POSITIONING SENSOR:FLAT BELT-TRANSFER



- 43.AW020217 (x2) OPTICS SENSOR:ENCODER:300LPI
- 60.D0741369 COVER:ENCODER
- 61.D0741382 SHAFT:DRIVE:INTERMEDIATE TRANSFER:ENCODER:ADHESION
- 55.B2236171 RUBBER BUSHING:ENCODER
- 49.AX060458 DC MOTOR:DIA56:16.5W:BRUSHLESS



- 64.D0743822 (x2) ROLLER:OPPOSED:BELT CLEANING:PRESS FIT



- 53.AZ310039 POWER PACK:TRANSFER:1500PF

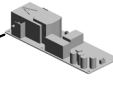

- 46.AW500023 (x2) PUSH SWITCH



- 47.AX060393 DC STEPPER MOTOR:MM42:1.3A:4.42V



- 45.AW020219 (x2) PHOTOINTERRUPTOR:ACTUATOR:2.9.2MM



U001	U002	U003	U004	U005	U006	U007	U008	U009	U010	U011	U012	U013	U014	U015	U016	U017	U018	U019	U020	U021
------	------	------	------	------	------	------	------	------	------	------	------	------	------	------	------	------	------	------	------	------

U009
ITB UNIT

- 66.D0743830 DECAL:OPERATE:LEVER:INTERMEDIATE TRANSFER
- 78.D0743887 BRACKET:ON-OFF:TRANSFER ROLLER
- 69.D0743845 (x2) FLAT NUT:INNER COVER:INTERMEDIATE TRANSFER
- 70.D0743846 INNER COVER:BELT CLEANING
- 87.D0746075 (x2) GRIP:INTERMEDIATE TRANSFER:LEFT

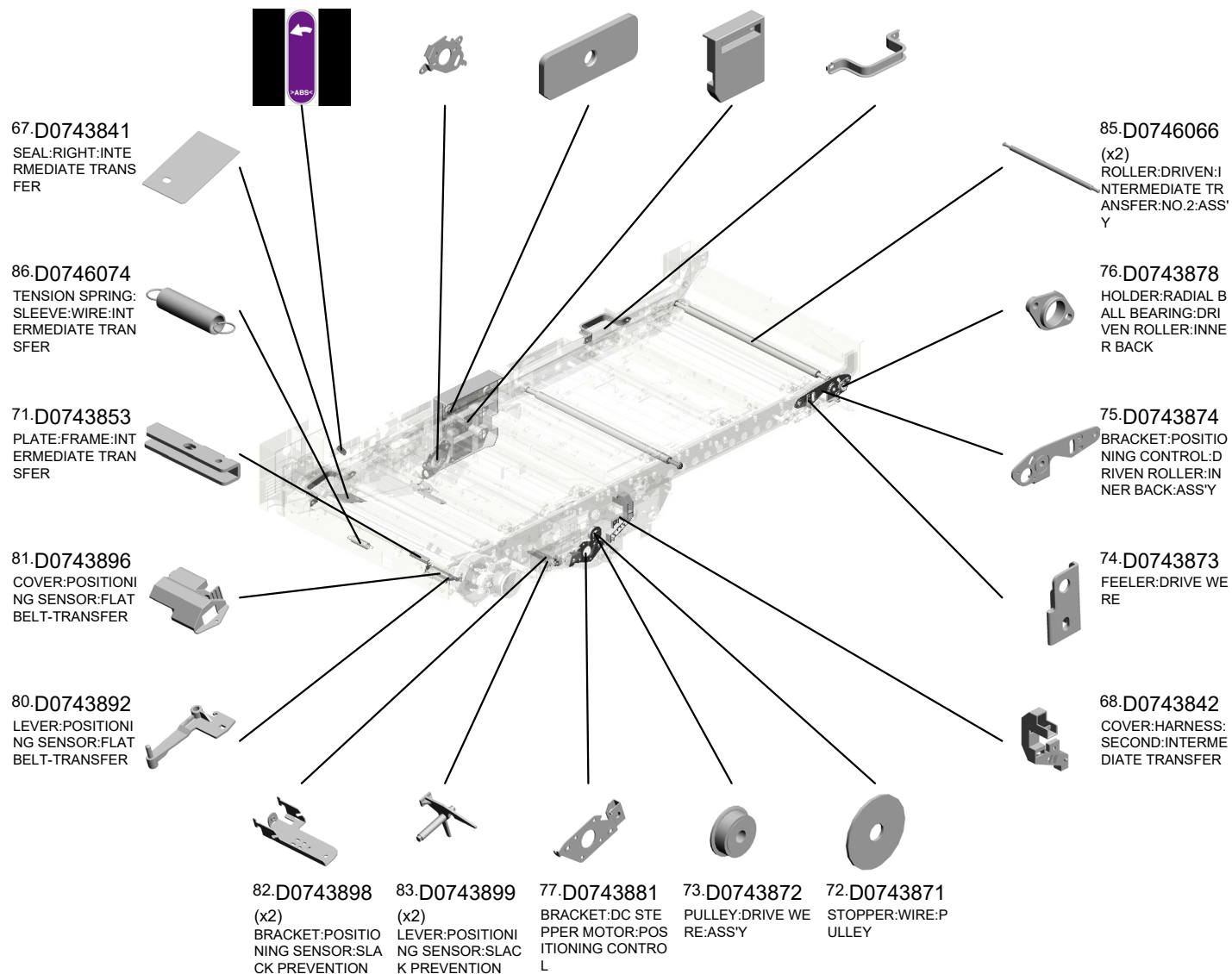
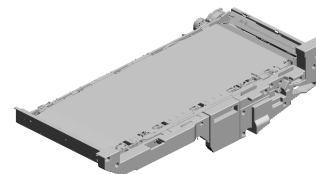

U009 ITB UNIT

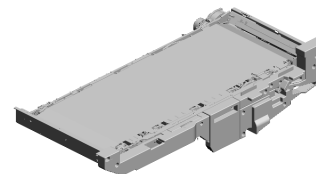

- 104.D0746153 SLIDE RAIL:ON-OFF:INTERMEDIATE TRANSFER:FRONT:ASSY
- 111.D0746164 SYNCHRONOUS BELT:ON-OFF:INTERMEDIATE TRANSFER
- 109.D0746162 TIMING PULLEY:CAM:ON-OFF:INTERMEDIATE TRANSFER
- 95.D0746130 SPRING PLATE:EA RTH:INTERMEDIATE TRANSFER:ASSY
- 94.D0746125 FEELER:ON-OFF:INTERMEDIATE TRANSFER:BLACK

110.D0746163
(x2)
GEAR:TIMING PULLEY:IDLER:INTERMEDIATE TRANSFER

92.D0746109
(x2)
PLATE:BLADE:BELT CLEANING

93.D0746121
BRACKET:SENSOR:ON-OFF:TRANSFER ROLLER

97.D0746142
(x2)
CAM:INTERMEDIATE TRANSFER:BLACK

88.D0746076
DUCT:TM SENSOR:INTERMEDIATE TRANSFER

91.D0746097
THERMOSTAT:INTERMEDIATE TRANSFER

100.D0746146
(x3)
BRACKET:BIAS:INTERMEDIATE TRANSFER

101.D0746147
(x3)
TERMINAL:INTERMEDIATE TRANSFER

90.D0746092
(x2)
BRACKET:HEATER:INTERMEDIATE TRANSFER

106.D0746156
(x2)
TENSION SPRING:ON-OFF:SLIDE RAIL

96.D0746134
(x5)
PLAIN SHAFT BEARING:INSULATE

108.D0746161
(x5)
COVER:BIAS:INTERMEDIATE TRANSFER

102.D0746148
SHAFT:CAM:INTERMEDIATE TRANSFER:COLLAR

103.D0746149
(x4)
CAM:INTERMEDIATE TRANSFER:COLLAR

105.D0746155
SLIDE RAIL:ON-OFF:INTERMEDIATE TRANSFER:REAR:ASSY

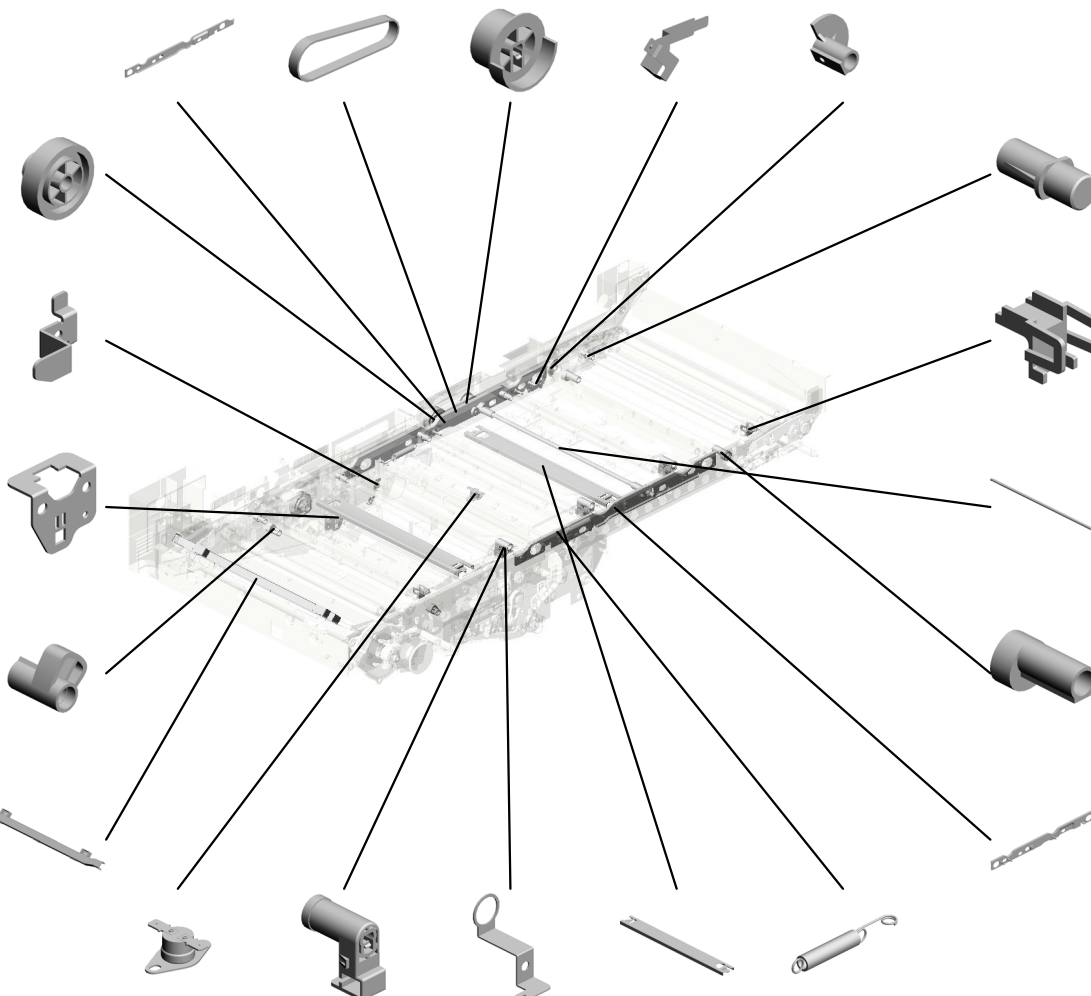

U009
ITB UNIT

- 119.D0746179 (x2) GEAR:IDLER:INTERMEDIATE TRANSFER:Z17:Z53
- 113.D0746168 TIGHTENER:INTERMEDIATE TRANSFER:ASSY
- 117.D0746172 (x2) COLLAR:ON-OFF:INTERMEDIATE TRANSFER
- 112.D0746165 (x2) PULLEY:ON-OFF:BELT TENSIONER
- 118.D0746175 (x4) PLAIN SHAFT BEARING:SLIDE RAIL:ON-OFF

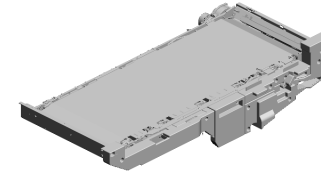

115.D0746170 (x2) COIL SPRING:PRESSURE:TIGHTENER



116.D0746171 (x2) GUIDE PLATE:COIL SPRING:PRESSURE:TIGHTENER



125.D1366499 SHEET:GUIDE:BELT CLEANING



124.D1366100 DENSITY SENSOR:PTM



131.D1941470 DRIVE ROLLER:INTERMEDIATE TRANSFER:ASSY

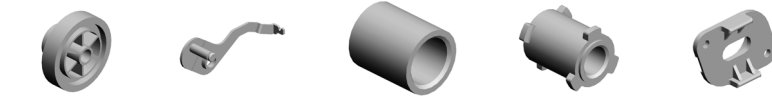

133.D1941481 STOPPER:DRIVEN ROLLER:FRONT LEFT



132.D1941480 HOLDER:DRIVEN ROLLER:FRONT



134.D1941482 BRACKET:DRIVEN ROLLER:FRONT



120.D0746180 (x5) COMPRESSION SPRING:BIAS:INTERMEDIATE TRANSFER



121.D0746197 (x5) TERMINAL:CONNECTING:BIAS:INTERMEDIATE TRANSFER



127.D1941461 BOSS:INTERMEDIATE TRANSFER:GEAR



126.D1941460 HOUSING:DRIVE:INTERMEDIATE TRANSFER:2



128.D1941462 (x5) HEXAGON HEAD BOLT:DOUBLE SCREW:M4X10



129.D1941466 DRUM STAY:DC MOTOR:DRIVE:PRESS FIT 201506-13 X/O



114.D0746169 ROLLER:FRONT:INTERMEDIATE TRANSFER:LEFT

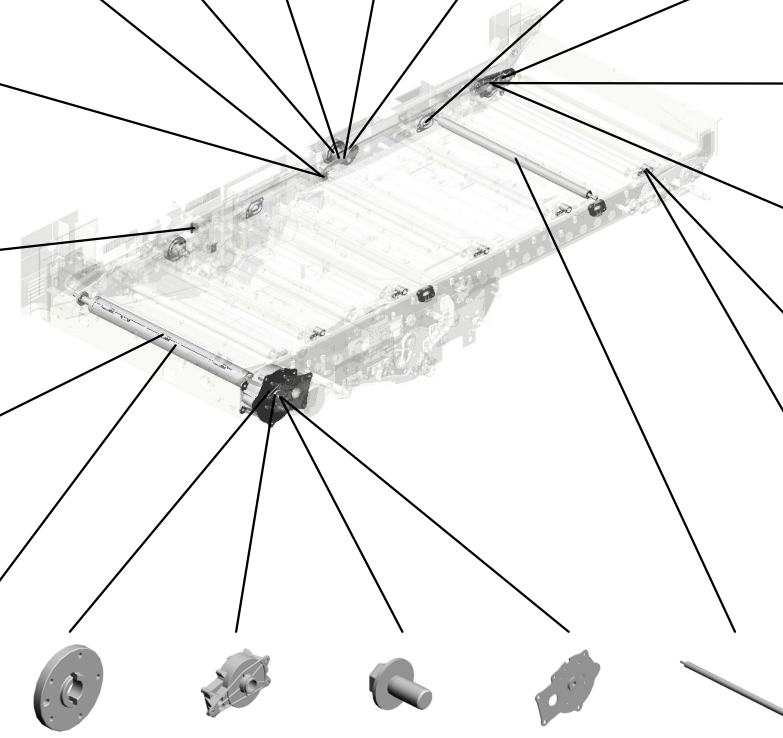

U009
ITB UNIT

- 139.D1943860 INNER COVER:INTERMEDIATE TRANSFER:LEFT 201502-01 X/O
- 143.D1946031 (x2) TENSION SPRING:ROLLER:DRIVEN:NO.5:RIGHT
- 145.D1946033 (x2) TENSION SPRING:SLIDER:SHAFT:NO.5
- 150.D1946055 (x2) PLAIN SHAFT BEARING:SHAFT:ON-OFF:NO.5:LEFT
- 144.D1946032 (x2) TENSION SPRING:ROLLER:DRIVEN:NO.5:LEFT

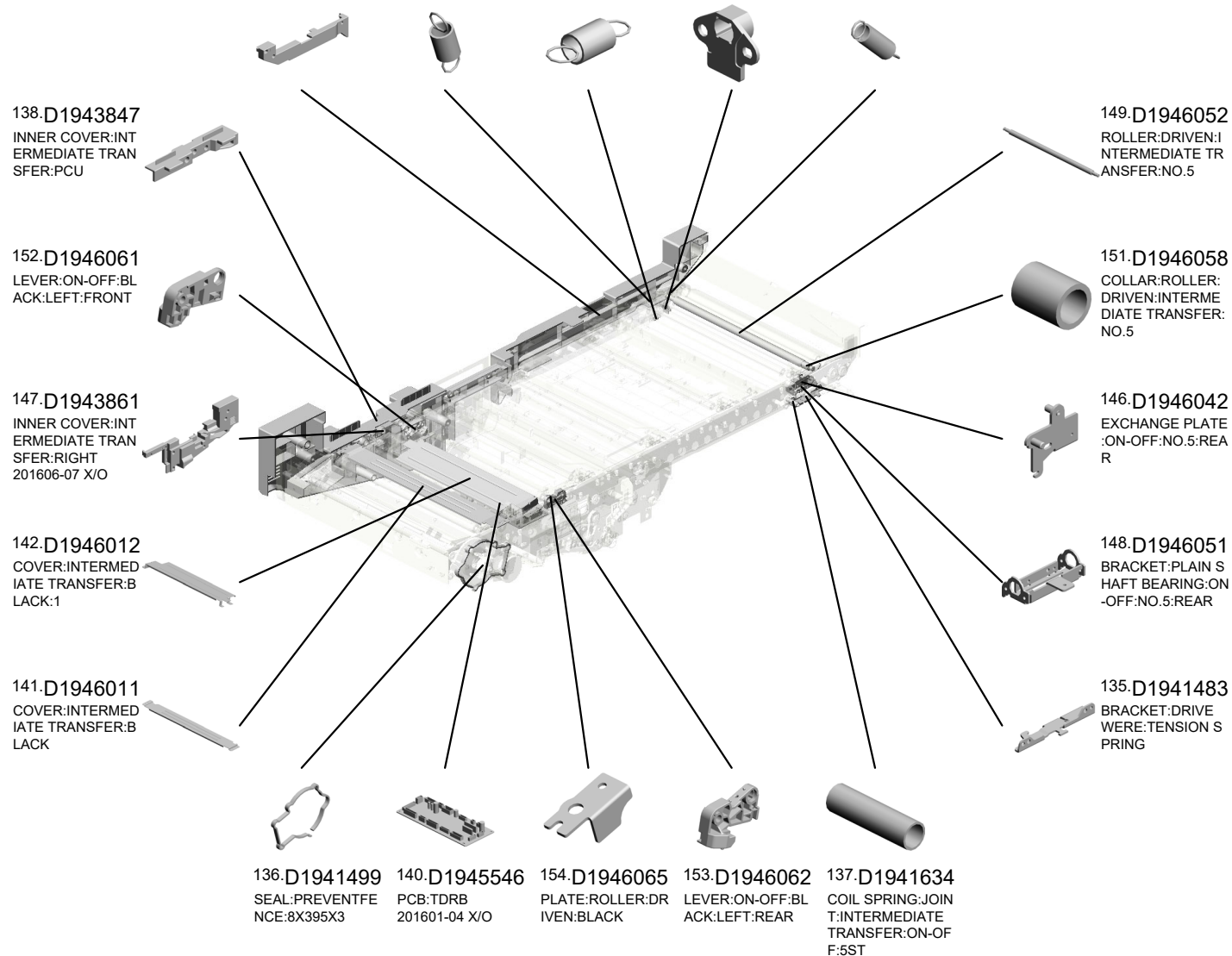
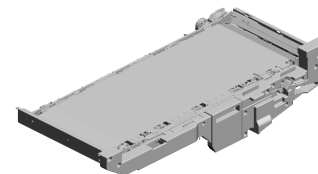

U009
ITB UNIT

- 167.D1946115 COVER:INTERMEDIATE TRANSFER:NO.2
- 164.D1946103 BRACKET:MOTOR:ON-OFF:INTERMEDIATE TRANSFER
- 159.D1946091 (x2) PLAIN SHAFT BEARING:SHAFT:ON-OFF:NO.5:RIGHT
- 160.D1946092 (x2) SHAFT:SLIDE:ON-OFF:INTERMEDIATE TRANSFER:NO.5
- 171.D1946144 BRACKET:ROLLER:DRIVEN:NO.5:FRONT

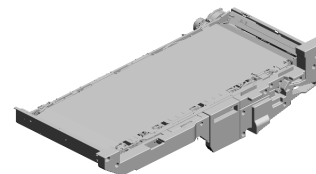

- 169.D1946140 PLATE:UPPER:POSITIONING SENSOR:INTERMEDIATE TRANSFER:ASSY

- 155.D1946073 (x4) PLAIN SHAFT BEARING:SLIDER:ON-OFF:BLACK

- 163.D1946099 HOOK:LEVER:ON-OFF:BLACK:FRONT

- 174.D1946148 SYNCHRONOUS BELT:80S2M224

- 158.D1946090 SHAFT:CAM:INTERMEDIATE TRANSFER:BLACK

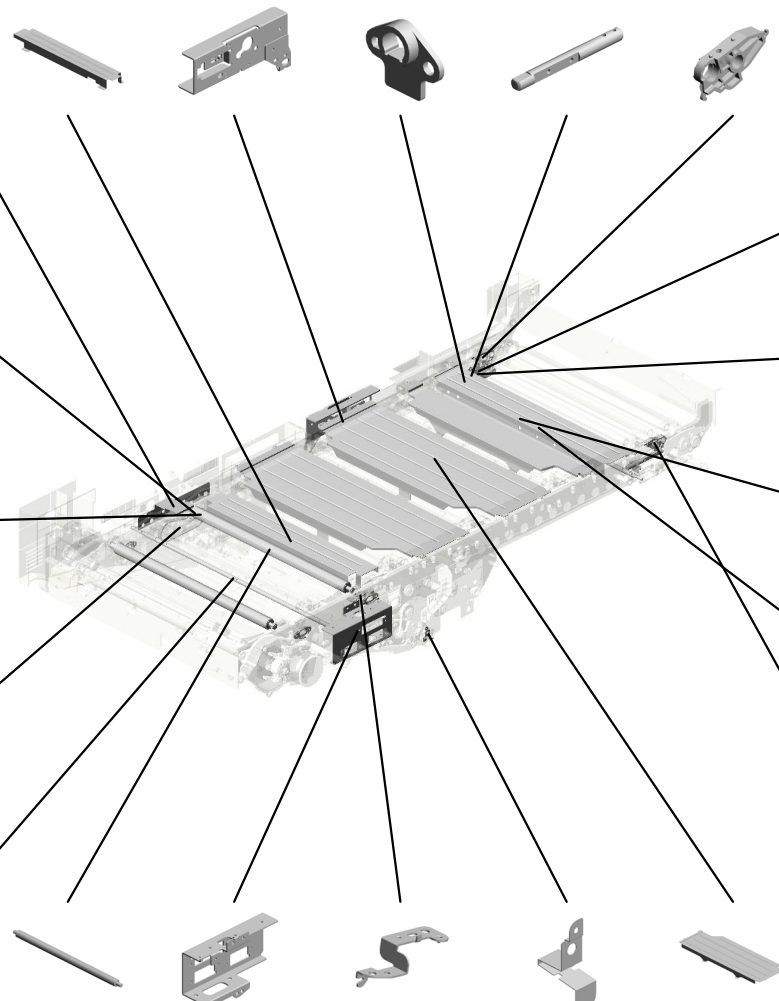

- 172.D1946145 EXCHANGE PLATE:ON-OFF:NO.5:FRONT

- 170.D1946142 BRACKET:PLAIN SHAFT BEARING:ON-OFF:NO.5:FRONT

- 165.D1946112 COVER:INTERMEDIATE TRANSFER:NO.4

- 157.D1946089 SHAFT:ON-OFF:DRIVE:NO.5:INTERMEDIATE TRANSFER

- 156.D1946088 BRACKET:ROLLER:DRIVEN:NO.5:REAR

- 168.D1946125 (x2) ROLLER:FRONT:INTERMEDIATE TRANSFER:RIGHT
- 161.D1946093 BRACKET:DRAWER:INTERMEDIATE TRANSFER
- 162.D1946098 HOOK:LEVER:ON-OFF:BLACK:REAR
- 173.D1946147 SPRING PLATE:ELECTRODE:OPPOSITE:TRANSFER ROLLER
- 166.D1946114 (x2) COVER:INTERMEDIATE TRANSFER:NO.1

U009 ITB UNIT

- 185.D1946207 (x3) SHEET:GREASE:HOLDER:TRANSFER ROLLER
- 196.D1946436 CASE:OPPOSED:TRANSFER ROLLER:FRONT
- 180.D1946177 (x2) DC STEPPER MOTOR:DIA42:24V
- 200.D1946444 SLIDER:ON-OFF:NO.5:FRONT
- 176.D1946160 SPRING PLATE:EA RTH:ROLLER:NO.5:ASS'Y

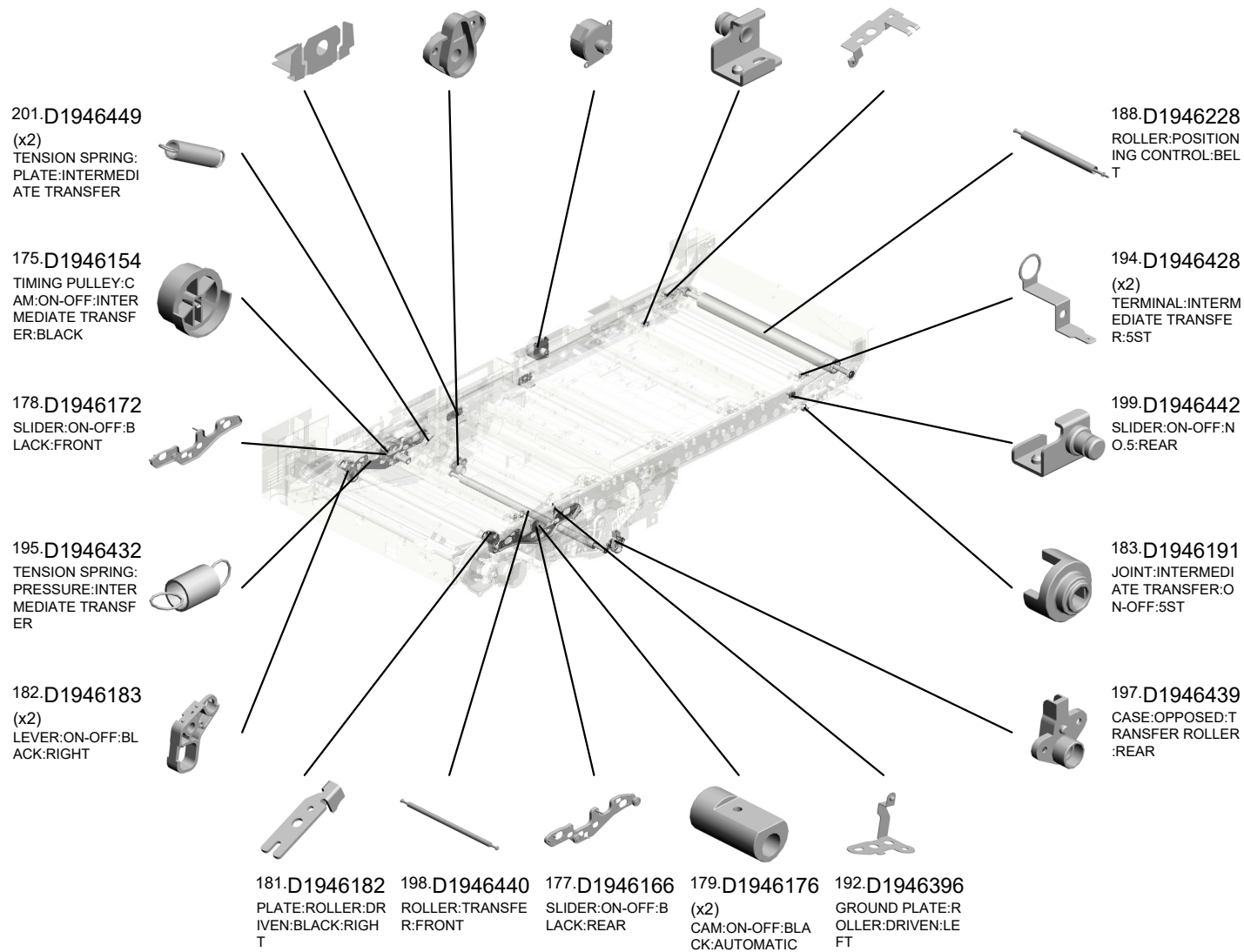
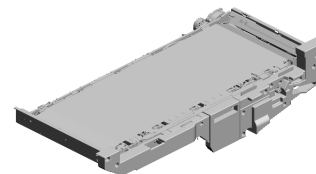

U009 ITB UNIT

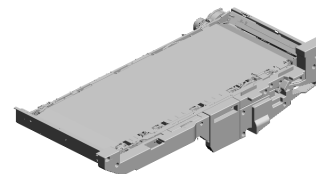

- 209.D1946475 GRIP:ON-OFF:INTERMEDIATE TRANSFER
- 208.D1946473 (x2) TENSION SPRING:SLIDER:ON-OFF:BLACK
- 204.D1946455 BRACKET:MOTOR:ON-OFF:INTERMEDIATE TRANSFER:BLACK
- 207.D1946467 TIGHTENER:INTERMEDIATE TRANSFER:ASS'Y
- 206.D1946459 (x2) TENSION SPRING:ON-OFF:BLACK:LEFT

219.B2342399
BOLT - M3X6
201502-05



211.D6882142
(x2)
PLAIN SHAFT BEARING RING:6X8X10



217.G1786393
SLEEVE:WIRE:LOWER:COVER

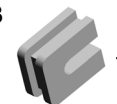

226.D1946358
BRACKET:DENSITY SENSOR:INTERMEDIATE TRANSFER



216.G1786392
HOUSING:LOWER:COVER



205.D1946457
SHAFT:CAM:INTERMEDIATE TRANSFER:BLACK:2

215.G1786352
GUIDE PLATE:ENCODER

210.D1946499
GROUND PLATE:ROLLER:DRIVEN:RIGHT

213.G1073834
(x4)
RIVET - 2.0

220.D1946222
GUIDE:TRANSPORT:INTERMEDIATE TRANSFER:5.0-ASS'Y
201502-09

221.D1946248
(x4)
DECAL:INNER COVER:INTERMEDIATE TRANSFER
201502-04



203.D1946454
BRACKET:ROLLER:TRANSFER:LEFT FRONT:ASS'Y



212.G0143291
(x6)
SNAP RING - PICK UP



202.D1946453
BRACKET:ROLLER:TRANSFER:LEFT REAR:ASS'Y



222.D0743824
(x3)
PLATE:ROLLER:INTERMEDIATE TRANSFER

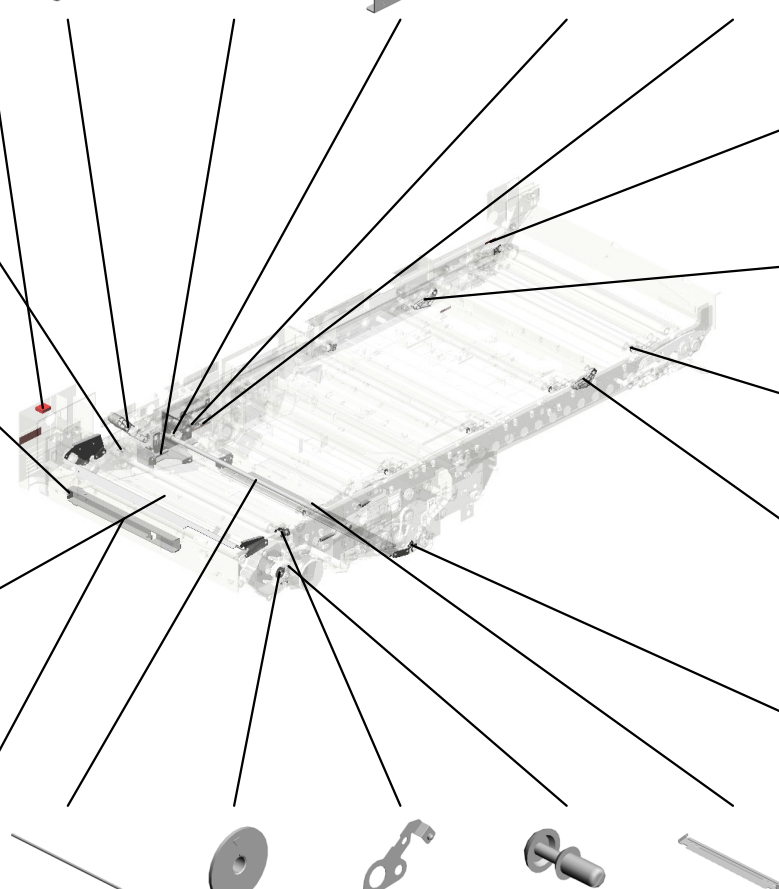

U009
ITB UNIT

240.AA043998 SYNCHRONOUS BELT:60S2M190 202201-01 O/O
234.D0A56050 FLAT BELT-TRANSFER ASS'Y 202002-03 O/O
 242.AX400275 (x2) HEATER:230V:9W 202212-01 O/O
 235.D0A56044 (x5) BRACKET:INTERMEDIATE TRANSFER:FRONT 202009-02 X/O
 237.D1946054 BRACKET:TENSION SPRING:ROLLER:NO.5:FRONT

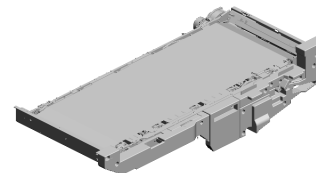

233.D1946363 PULLEY:ON-OFF:SM:27T:MELTING ADHESION 201904-03 X/O

232.D0A56187 COVER:INTERMEDIATE TRANSFER:ASS'Y 201812-11 O/O

231.D2703889 BRACKET:POSITIONING SENSOR:PEEN 201808-01 O/O

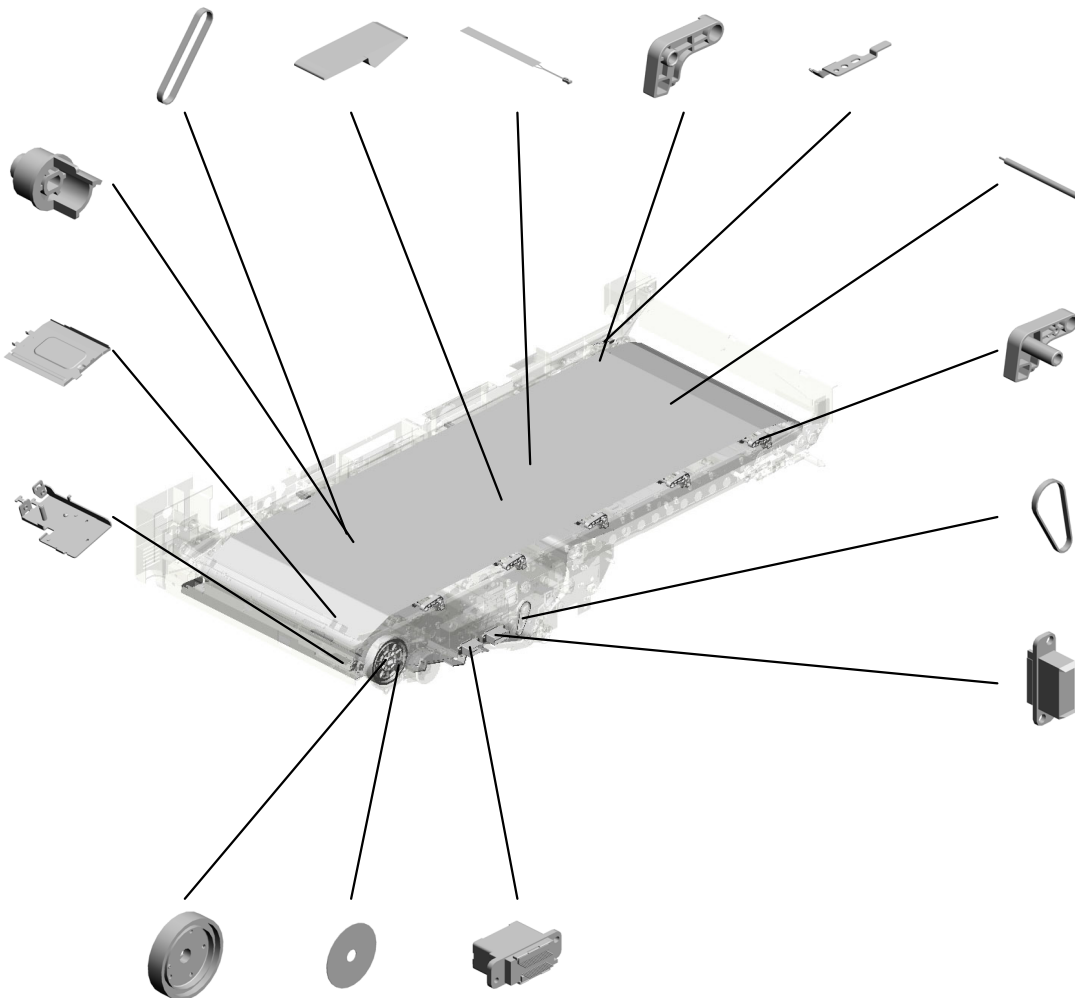

241.D2586166
(x5)
ROLLER:INTERMEDIATE TRANSFER:ASS'Y
202210-01 X/O

236.D0A56045
(x5)
BRACKET:INTERMEDIATE TRANSFER:REAR
202009-03 X/O

238.AA043725
TIMING BELT:40S2M142
202108-01 O/O

229.11035759
CONNECTOR:RFC
P-44W0-E

230.D0A51467 GEAR:DRIVE:130Z 201710-08 O/O

227.D1941496 ENCODER:ASS'Y 201706-01 X/O

228.11035758 CONNECTOR:RFC
P-36W0-E

U009_S001
CASE:TENSION:ROLLER:ASS'Y

123.D0746397
(x2)
COIL SPRING:TEN
SION:ROLLER



62.D0743808
CASE:TENSION:R
OLLER:ASS'Y

5.03603006N
SCREW - M3X6

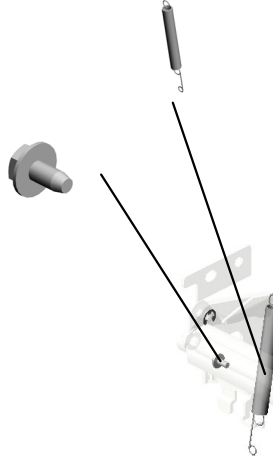

13.07200040E
(x2)
RETAINING RING -
M4



3.03530080N
SCREW:M3X8



U001	U002	U003	U004	U005	U006	U007	U008	U009	U010	U011	U012	U013	U014	U015	U016	U017	U018	U019	U020	U021
------	------	------	------	------	------	------	------	------	------	------	------	------	------	------	------	------	------	------	------	------

U009_S001_S001
ROLLER:TENSION:ASS'Y

15.07403706
(x2)
BALL BEARING - M
6X10X3

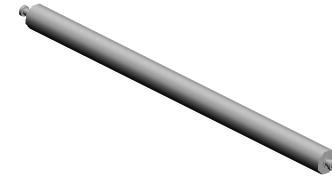
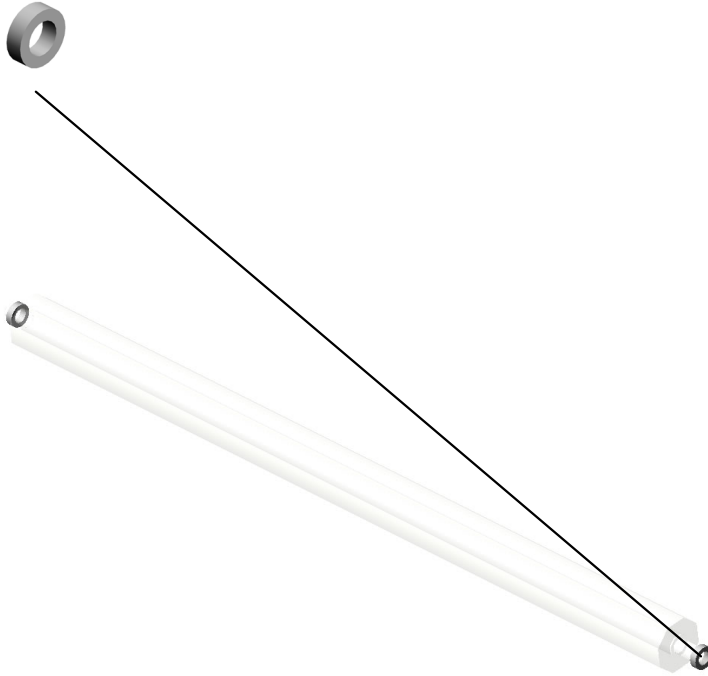

243.D0746379
ROLLER:TENSION:
ASS'Y

U001	U002	U003	U004	U005	U006	U007	U008	U009	U010	U011	U012	U013	U014	U015	U016	U017	U018	U019	U020	U021
------	------	------	------	------	------	------	------	------	------	------	------	------	------	------	------	------	------	------	------	------

U009_S002

SERVICE PARTS:COIL SPRING:TRANSFER ROLLER:EXCHANGEABLE:20N

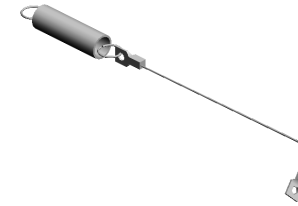
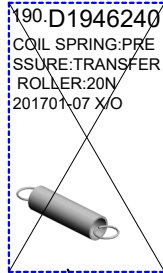

223.D1946262
SERVICE PARTS:C
OIL SPRING:TRAN
SFER ROLLER:EX
CHANGEABLE:20N

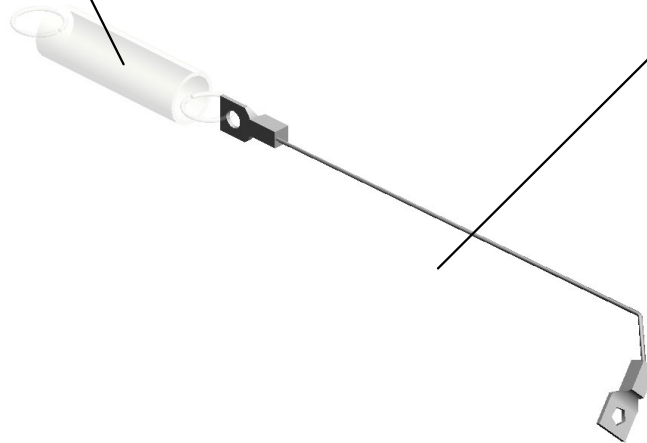

218.G1786394
WIRE:STOPPER:L
OWER:COVER

U001	U002	U003	U004	U005	U006	U007	U008	U009	U010	U011	U012	U013	U014	U015	U016	U017	U018	U019	U020	U021
------	------	------	------	------	------	------	------	------	------	------	------	------	------	------	------	------	------	------	------	------

U009_S003

SERVICE PARTS:COIL SPRING:TRANSFER ROLLER:EXCHANGEABLE:20N

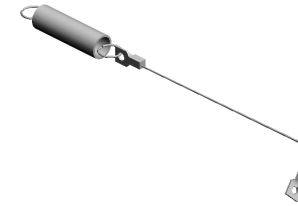
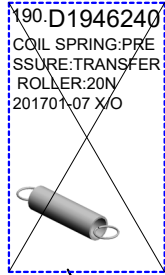

223.D1946262
SERVICE PARTS:C
OIL SPRING:TRAN
SFER ROLLER:EX
CHANGEABLE:20N

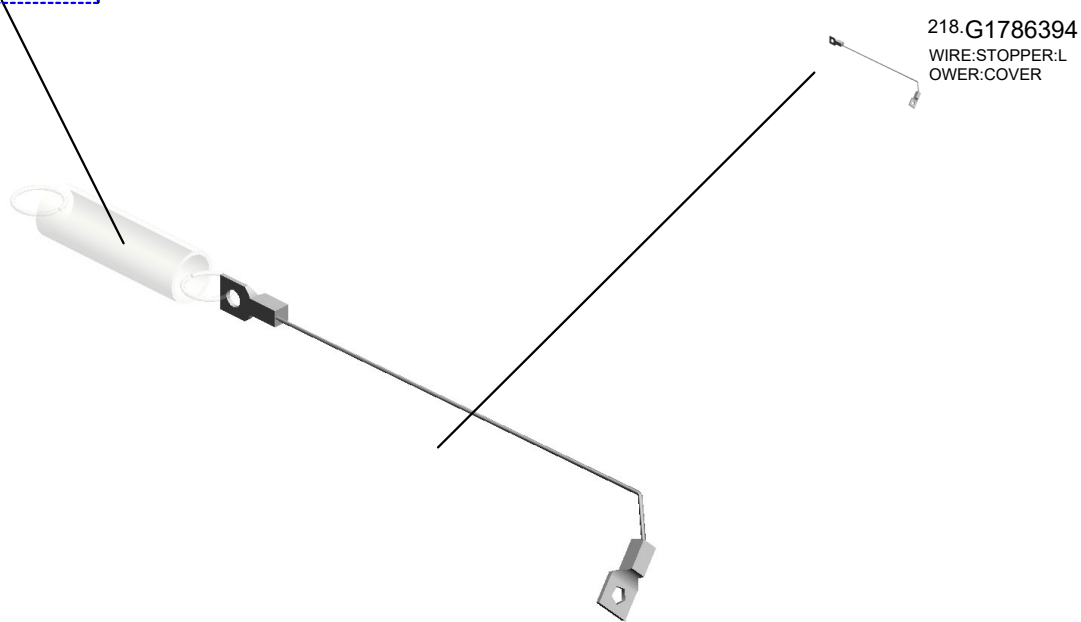

U001	U002	U003	U004	U005	U006	U007	U008	U009	U010	U011	U012	U013	U014	U015	U016	U017	U018	U019	U020	U021
------	------	------	------	------	------	------	------	------	------	------	------	------	------	------	------	------	------	------	------	------

U009_S004

SERVICE PARTS:COIL SPRING:TRANSFER ROLLER:EXCHANGEABLE:30N

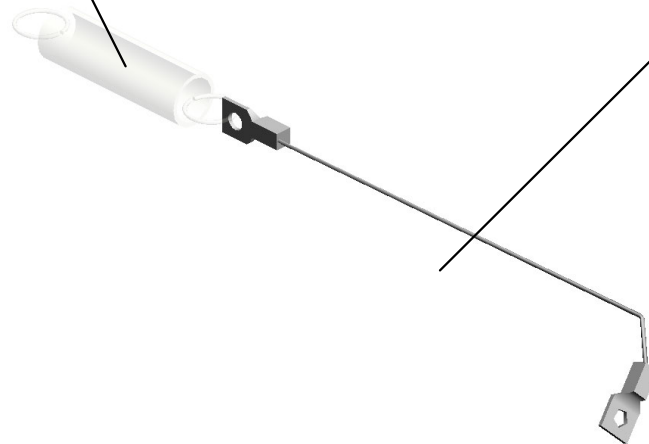
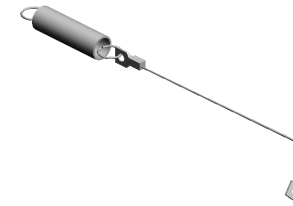
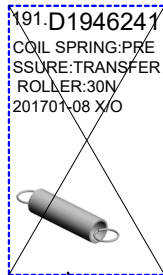

U001	U002	U003	U004	U005	U006	U007	U008	U009	U010	U011	U012	U013	U014	U015	U016	U017	U018	U019	U020	U021
------	------	------	------	------	------	------	------	------	------	------	------	------	------	------	------	------	------	------	------	------

U009_S005

SERVICE PARTS:COIL SPRING:TRANSFER ROLLER:EXCHANGEABLE:30N

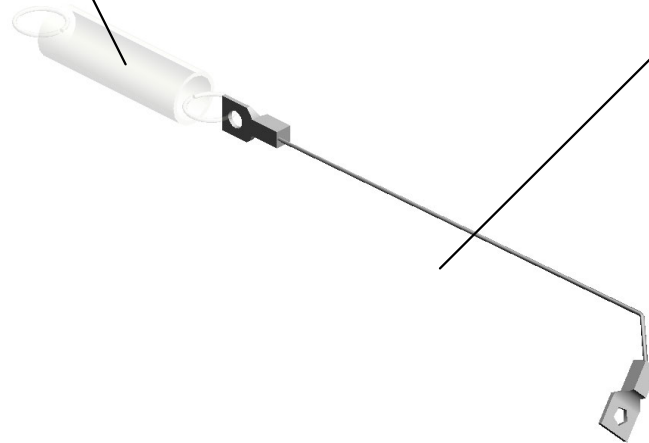
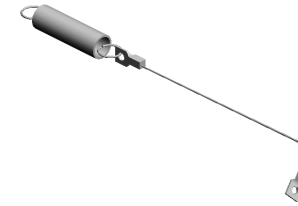
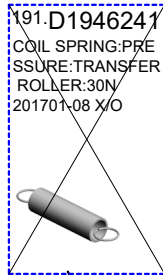

U001	U002	U003	U004	U005	U006	U007	U008	U009	U010	U011	U012	U013	U014	U015	U016	U017	U018	U019	U020	U021
------	------	------	------	------	------	------	------	------	------	------	------	------	------	------	------	------	------	------	------	------

U009_S006

SERVICE PARTS:COIL SPRING:TRANSFER ROLLER:EXCHANGEABLE:60N

122.D0746334
COIL SPRING:PRE
SSURE:TRANSFER
ROLLER

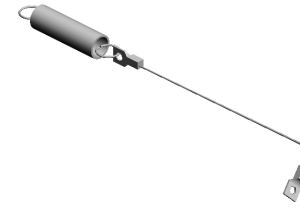
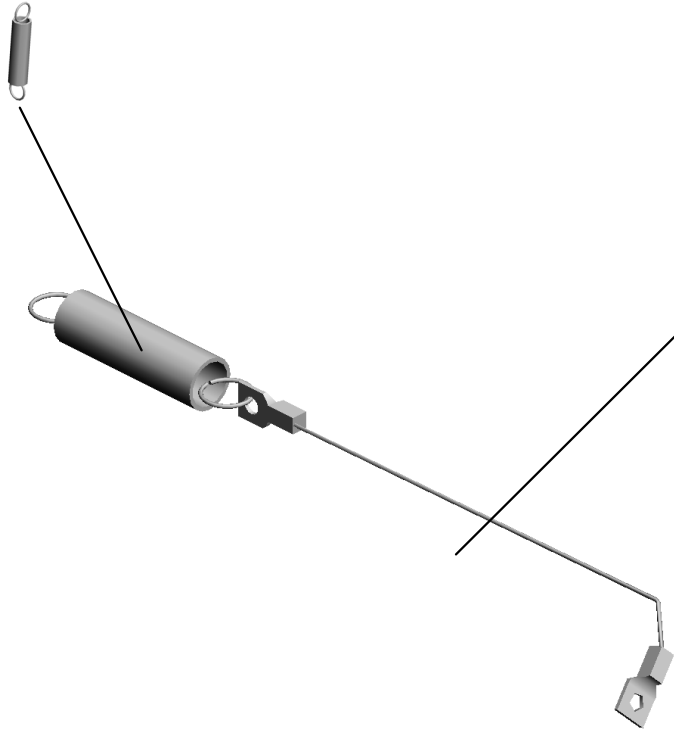

225.D1946266
SERVICE PARTS:C
OIL SPRING:TRAN
SFER ROLLER:EX
CHANGEABLE:60N

218.G1786394
WIRE:STOPPER:L
OWER:COVER

U001	U002	U003	U004	U005	U006	U007	U008	U009	U010	U011	U012	U013	U014	U015	U016	U017	U018	U019	U020	U021
------	------	------	------	------	------	------	------	------	------	------	------	------	------	------	------	------	------	------	------	------

U009_S007

SERVICE PARTS:COIL SPRING:TRANSFER ROLLER:EXCHANGEABLE:60N

122.D0746334
COIL SPRING:PRE
SSURE:TRANSFER
ROLLER

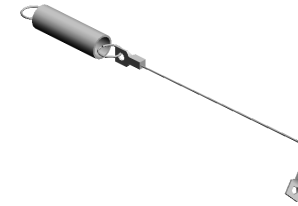

225.D1946266
SERVICE PARTS:C
OIL SPRING:TRAN
SFER ROLLER:EX
CHANGEABLE:60N

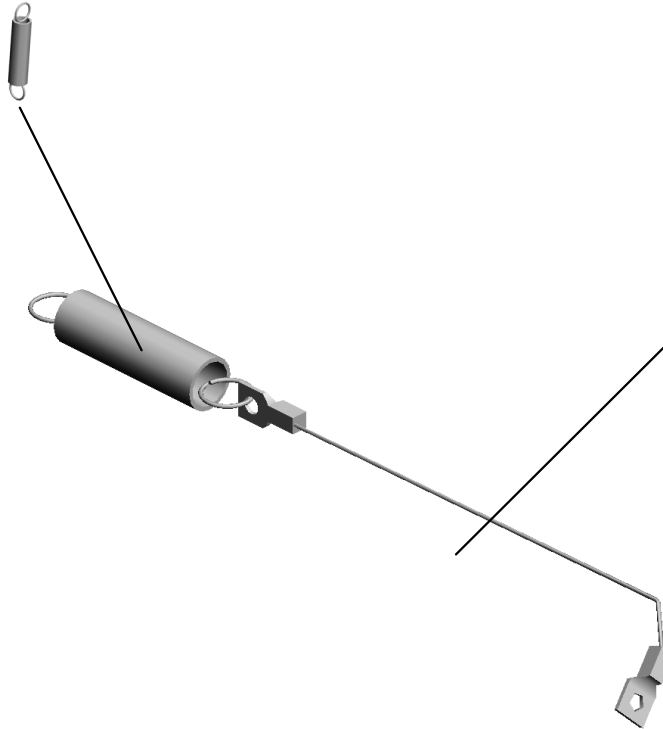

218.G1786394
WIRE:STOPPER:L
OWER:COVER



U001	U002	U003	U004	U005	U006	U007	U008	U009	U010	U011	U012	U013	U014	U015	U016	U017	U018	U019	U020	U021
------	------	------	------	------	------	------	------	------	------	------	------	------	------	------	------	------	------	------	------	------

U009_S008
ROLLER:OPPOSED:TRANSFER:PAPER:ASS'Y

14.07200060E
(x2)
RETAINING RING -
M6

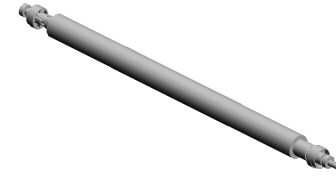

189.D1946231
ROLLER:OPPOSED
:TRANSFER:PAPE
R:ASS'Y

U001	U002	U003	U004	U005	U006	U007	U008	U009	U010	U011	U012	U013	U014	U015	U016	U017	U018	U019	U020	U021
------	------	------	------	------	------	------	------	------	------	------	------	------	------	------	------	------	------	------	------	------

U009_S009

POSITIONING SENSOR:SCALE:INTERMEDIATE TRANSFER:ASS'Y

9.04503008N
(x2)
TAPPING SCREW -
M3X8

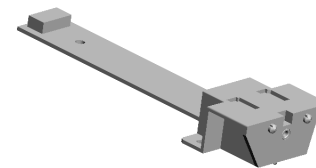

193.D1946420
POSITIONING SEN
SOR:SCALE:INTER
MEDIATE TRANSF
ER:ASS'Y

U001	U002	U003	U004	U005	U006	U007	U008	U009	U010	U011	U012	U013	U014	U015	U016	U017	U018	U019	U020	U021
------	------	------	------	------	------	------	------	------	------	------	------	------	------	------	------	------	------	------	------	------

U009_S010
GUIDE:TRANSPORT:INTERMEDIATE TRANSFER:ASS'Y

187.D1946214
GUIDE:TRANSPOR
T:INTERMEDIATE
TRANSFER:5.0+:A
SS'Y

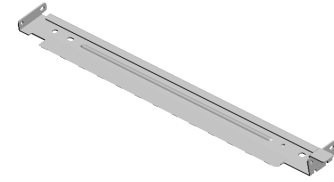
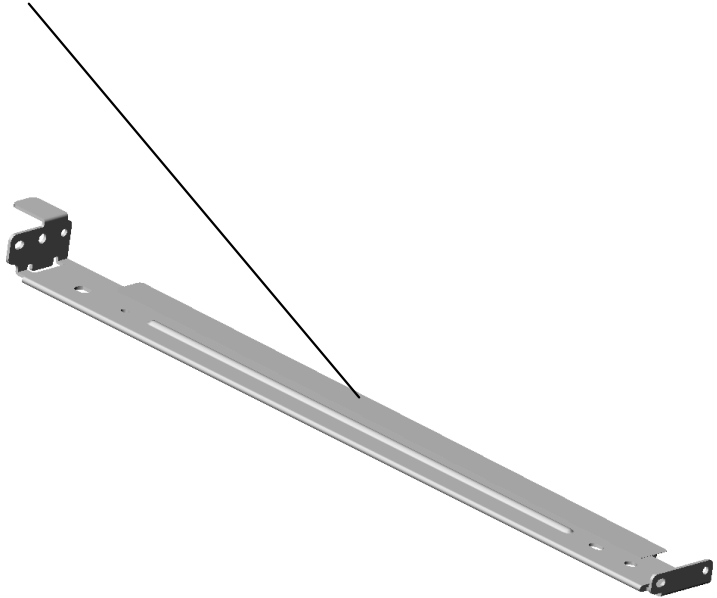

186.D1946210
GUIDE:TRANSPOR
T:INTERMEDIATE
TRANSFER:ASS'Y

U001	U002	U003	U004	U005	U006	U007	U008	U009	U010	U011	U012	U013	U014	U015	U016	U017	U018	U019	U020	U021
------	------	------	------	------	------	------	------	------	------	------	------	------	------	------	------	------	------	------	------	------

U010.ITB CLEANING

U010 S001
D0A50641
BELT CLEANING:ASS'Y

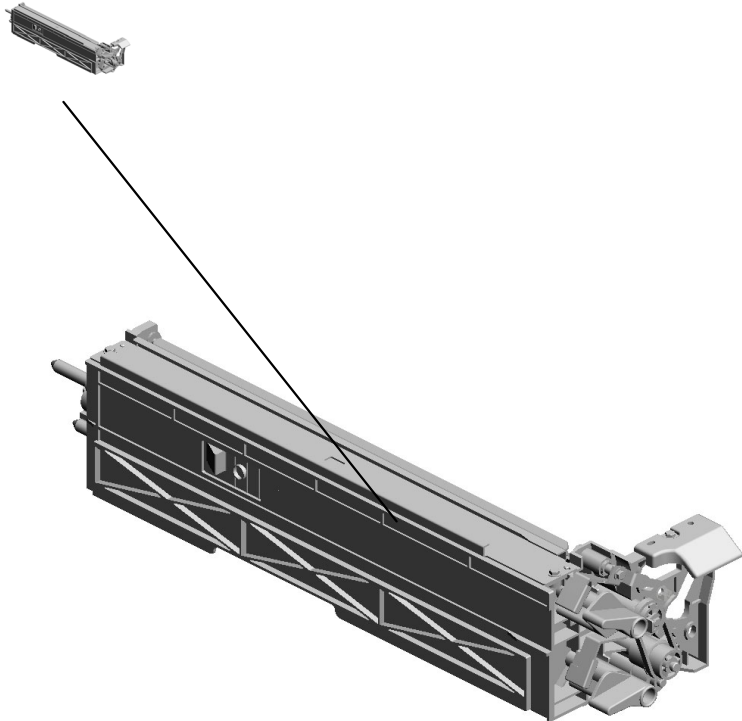

U001	U002	U003	U004	U005	U006	U007	U008	U009	U010	U011	U012	U013	U014	U015	U016	U017	U018	U019	U020	U021
------	------	------	------	------	------	------	------	------	------	------	------	------	------	------	------	------	------	------	------	------

U010_S001.BELT CLEANING:ASS'Y

U010 S001 S002
D0746450
COATING BAR:ASS'Y

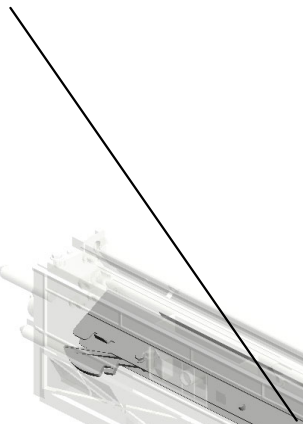

U010 S001 S001
D0746413
SCRAPER:BRUSH:REMOVE
PAPER DUST:ASS'Y

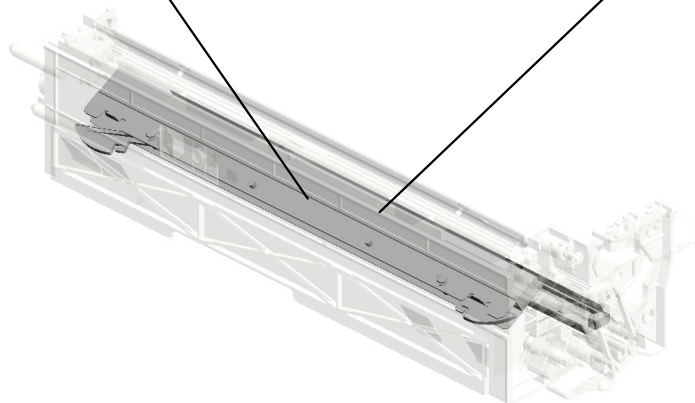
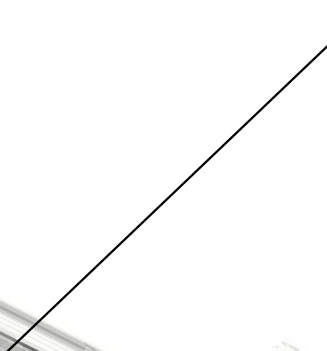

U001	U002	U003	U004	U005	U006	U007	U008	U009	U010	U011	U012	U013	U014	U015	U016	U017	U018	U019	U020	U021
------	------	------	------	------	------	------	------	------	------	------	------	------	------	------	------	------	------	------	------	------

U010
ITB CLEANING

9-B2342390
FLANGED HEXAG
ONAL HEAD BOLT:
M4X8

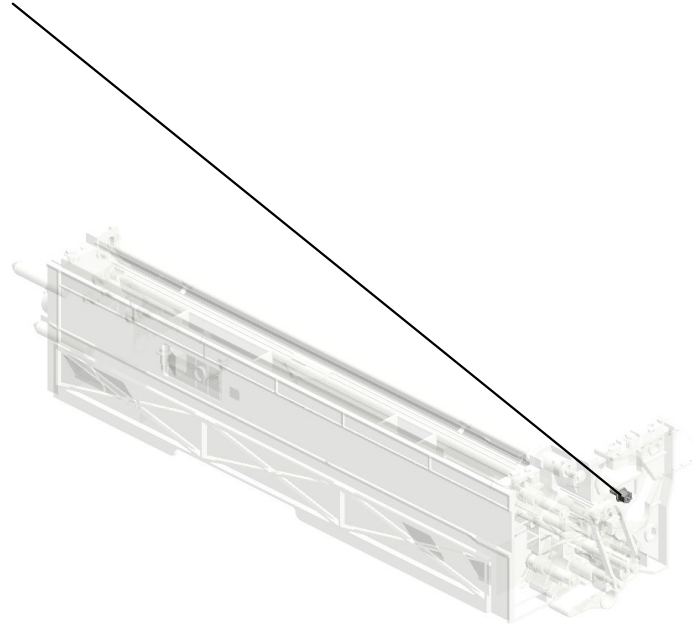
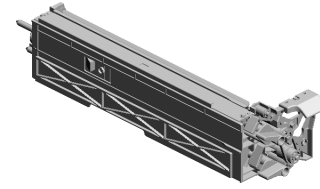

U001	U002	U003	U004	U005	U006	U007	U008	U009	U010	U011	U012	U013	U014	U015	U016	U017	U018	U019	U020	U021
------	------	------	------	------	------	------	------	------	------	------	------	------	------	------	------	------	------	------	------	------

U010_S001
BELT CLEANING:ASS'Y

- 7.AA083022 (x2) BUSHING:DIA6:DIA8
- 2.07080060N (x2) WASHER:DIA6
- 1.03603006N (x19) SCREW - M3X6
- 22.D0746431 COIL SPRING:BLADE:CLEANING:BELT CLEANING
- 20.D0746424** **BLADE:CLEANING:BELT CLEANING:ASS'Y**

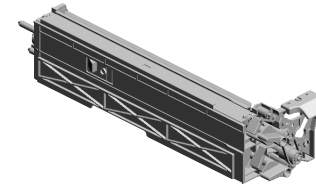

63.D0A50641
[A]
BELT CLEANING:ASS'Y
201807-09 O/O

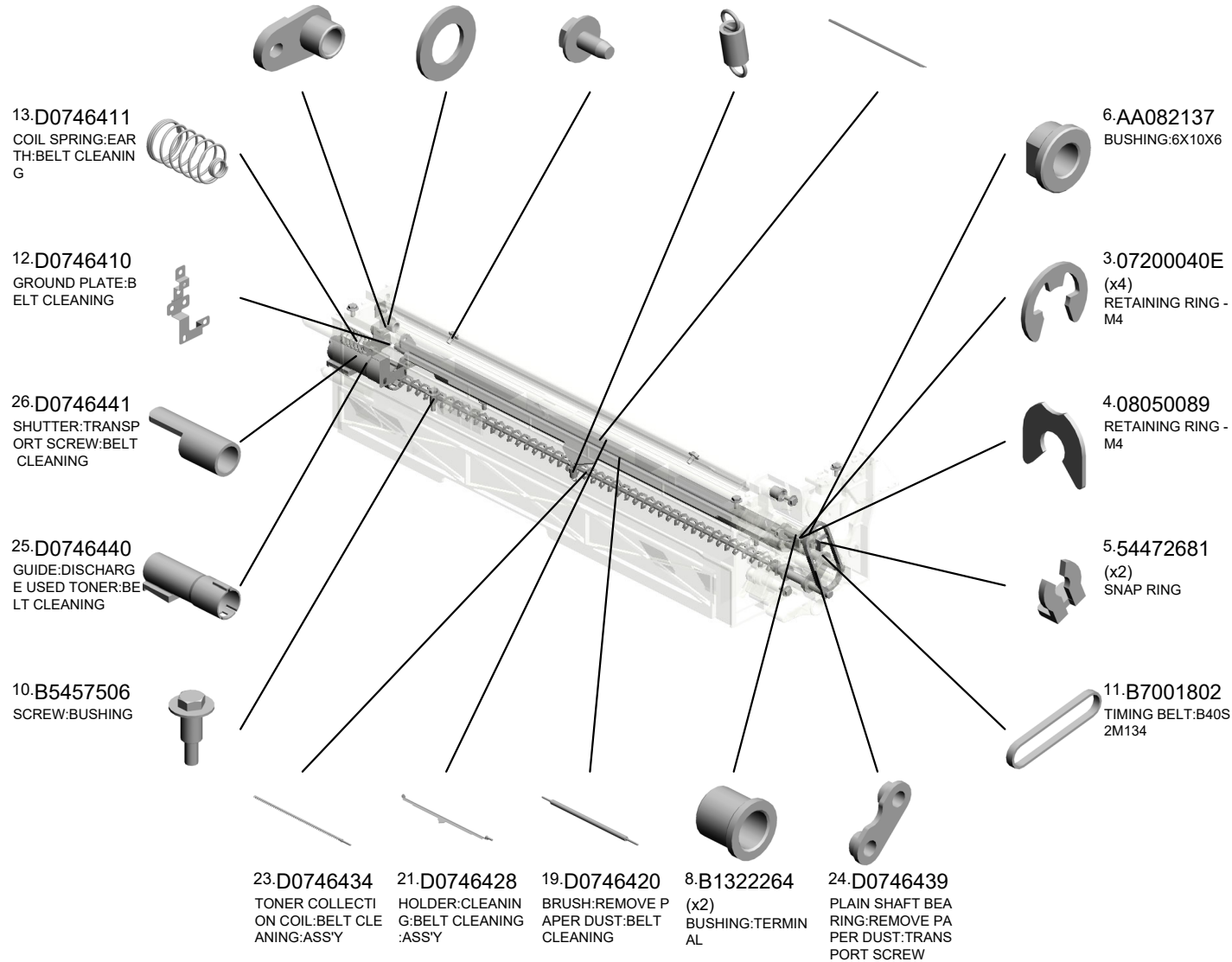

U010_S001
BELT CLEANING:ASS'Y

47.D0746486
SEAL:CASE:BRUSH:
H:REAR

35.D0746464
COIL SPRING:BLA
DE:APPLY:BELT C
LEANING

38.D0746469
SLIDE RAIL:UPPER
:BELT CLEANING

33.D0746457
BLADE:APPLY:AS
S'Y

34.D0746461
HOLDER:APPLY:B
ELT CLEANING:AS
S'Y

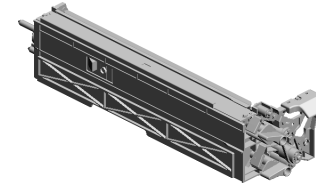

63.D0A50641
[A]
BELT CLEANING:A
SS'Y
201807-09 O/O

45.D0746481
JOINT:BRUSH:REM
OVE PAPER DUST:
BELT CLEANING



28.D0746443
SEAL:DISCHARGE
USED TONER



27.D0746442
COIL SPRING:DISC
HARGE USED TONER



36.D0746467
COIL SPRING:STO
PPER:CASE:BELT
CLEANING



37.D0746468
STOPPER:CASE:BE
LT CLEANING



48.D0746488
SEAL:HOLDER:BE
HIND:BELT CLEANI
NG

49.D0746489
VIBRATING PLATE:
TRANSPORT SCR
EW:BELT CLEANIN
G

29.D0746446
BRUSH:APPLY:BE
LT CLEANING

39.D0746470
RELEASE PLATE:B
LADE:CLEANING

43.D0746479
GEAR:COLLECT:C
OIL:Z19

40.D0746471
RELEASE PLATE:B
LADE:APPLY



44.D0746480
PULLEY:BRUSH:A
PPLY:Z30



46.D0746485
SEAL:CASE:BRUS
H:FRONT



41.D0746477
GEAR:BRUSH:REM
OVE PAPER DUST:
Z17



42.D0746478
GEAR:PULLEY:IDL
ER:BELT CLEANIN
G



U001	U002	U003	U004	U005	U006	U007	U008	U009	U010	U011	U012	U013	U014	U015	U016	U017	U018	U019	U020	U021
------	------	------	------	------	------	------	------	------	------	------	------	------	------	------	------	------	------	------	------	------

U010_S001
BELT CLEANING:ASS'Y

52.D0746492 SEAL:CASE:CLEANING BLADE:REAR
58.D1796414 SEAL:HOLDER:CLEANING BLADE:REAR LOWER
62.G1786621 (x2) COVER:RELEASE PLATE:BLADE

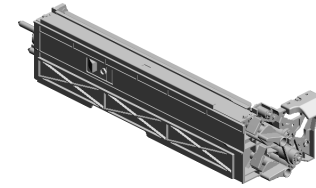

63.D0A50641
[A]
BELT CLEANING:ASS'Y
201807-09 O/O

59.D1796415 (x2) SEAL:HOLDER:CLEANING BLADE:LOWER

60.D1796416 (x2) SEAL:HOLDER:CLEANING BLADE:BEHIND

50.D0746490 SEAL:BASE:CASE:BELT CLEANING

54.D0746496 GRIP:BELT CLEANING

51.D0746491 SEAL:CASE:CLEANING BLADE:FRONT

55.D0746497 (x2) DECAL:POSITIONING DISPLAY:TCRU

53.D0746495 (x2) LEVER:RELEASE:BLADE
56.D1796412 (x2) SEAL:HOLDER:CLEANING BLADE:UPPER
57.D1796413 SEAL:HOLDER:CLEANING BLADE:FRONT LOWER



D1940641
[A]
BELT CLEANING:ASS'Y
201807-09 O/O

U001	U002	U003	U004	U005	U006	U007	U008	U009	U010	U011	U012	U013	U014	U015	U016	U017	U018	U019	U020	U021
------	------	------	------	------	------	------	------	------	------	------	------	------	------	------	------	------	------	------	------	------

U010_S001_S001
SCRAPER:BRUSH:REMOVE PAPER DUST:ASS'Y

17.D0746416
SEAL:ENTRANCE
SEAL:BELT CLEAN
ING

14.D0746413
SCRAPER:BRUSH:
REMOVE PAPER D
UST:ASS'Y

18.D0746417
(x2)
SEAL:SCRAPER

16.D0746415
DUAL FACES TEPE
:ENTRANCE SEAL:
BELT CLEANING

15.D0746414
SCRAPER:BRUSH:
REMOVE PAPER D
UST

U001	U002	U003	U004	U005	U006	U007	U008	U009	U010	U011	U012	U013	U014	U015	U016	U017	U018	U019	U020	U021
------	------	------	------	------	------	------	------	------	------	------	------	------	------	------	------	------	------	------	------	------

U010_S001_S002
COATING BAR:ASS'Y

32.D0746455
COIL SPRING:COA
TING BAR

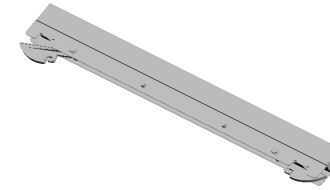

30.D0746450
COATING BAR:AS
S'Y

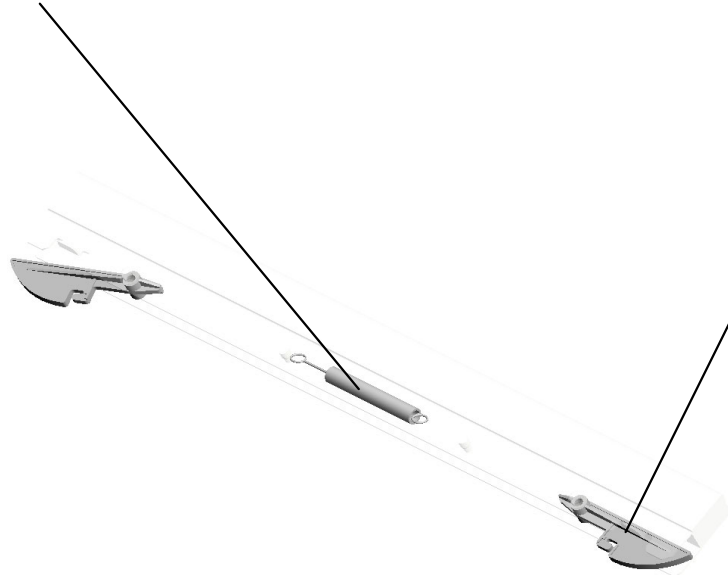

31.D0746454
(x2)
ARM:COATING BA
R:BELT CLEANING

U001	U002	U003	U004	U005	U006	U007	U008	U009	U010	U011	U012	U013	U014	U015	U016	U017	U018	U019	U020	U021
------	------	------	------	------	------	------	------	------	------	------	------	------	------	------	------	------	------	------	------	------

U011.TRANSFER/SEPARATION

U011 S001
D0A56200
TRANSFER/SEPARATION UN
IT:ASS'Y

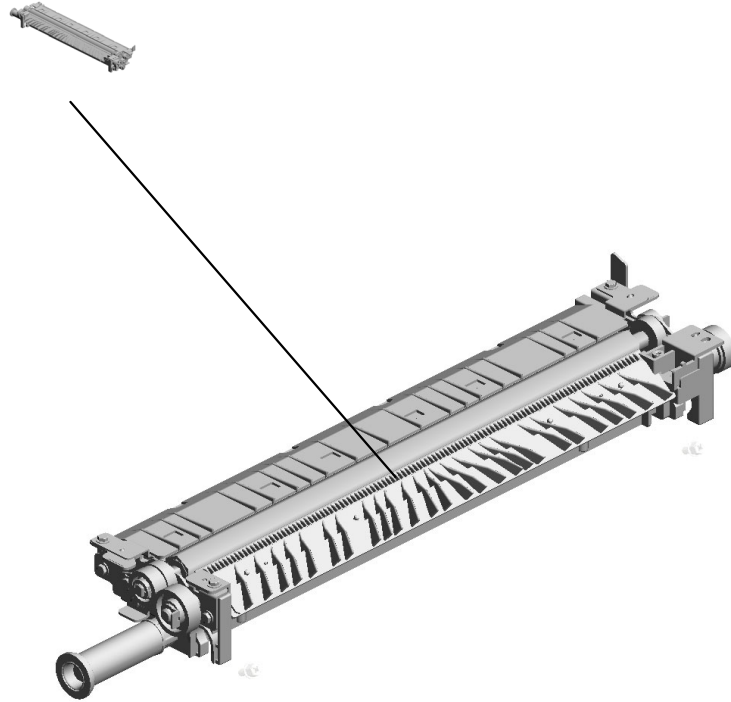

U001	U002	U003	U004	U005	U006	U007	U008	U009	U010	U011	U012	U013	U014	U015	U016	U017	U018	U019	U020	U021
------	------	------	------	------	------	------	------	------	------	------	------	------	------	------	------	------	------	------	------	------

U011_S001.TRANSFER/SEPARATION UNIT:ASS'Y

U011 S001 S001
D1946301
SEPARATION CORONA:ASS'
Y



U001	U002	U003	U004	U005	U006	U007	U008	U009	U010	U011	U012	U013	U014	U015	U016	U017	U018	U019	U020	U021
------	------	------	------	------	------	------	------	------	------	------	------	------	------	------	------	------	------	------	------	------

U011 TRANSFER/SEPARATION

18.B2342390
(x2)
FLANGED HEXAG
ONAL HEAD BOLT:
M4X8

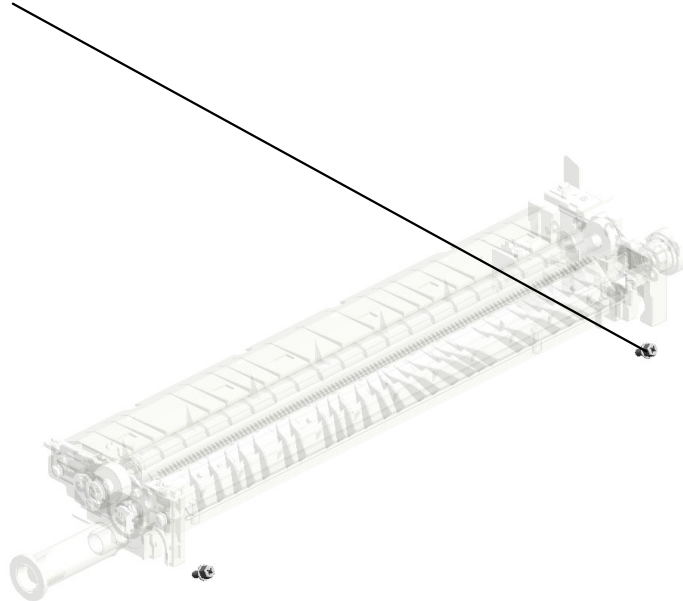
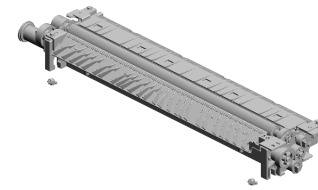

U001	U002	U003	U004	U005	U006	U007	U008	U009	U010	U011	U012	U013	U014	U015	U016	U017	U018	U019	U020	U021
------	------	------	------	------	------	------	------	------	------	------	------	------	------	------	------	------	------	------	------	------

U011_S001
TRANSFER/SEPARATION UNIT:ASS'Y



45.D0A56200
[A]
TRANSFER/SEPARATION UNIT:ASS'Y
201805-05 O/O

8.07403008 (x2) BALL BEARING - 8X22X7
9.08050089 (x2) RETAINING RING - M4
13.AA080154 REAR BUSHING
5.04543006Q (x2) TAPPING SCREW - M3X6
2.04503008N TAPPING SCREW - M3X8

7.07200060E (x2) RETAINING RING - M6

20.D0746216 SHUTTER:TONER OUTLET SUB-UNIT:SUB-ASS'Y

12.52152621 SNAP RING - M6

21.D0746219 COIL SPRING:SHUTTER:DISCHARGE USED TONER

4.04523008N (x2) TAPPING SCREW - M3X8

22.D0746228 ELECTRODE PLATE:FRAME

16.AB011125 GEAR:20/29Z

15.AA082137 (x2) BUSHING:6X10X6

10.08053568 RADIAL BALL BEARING: DIA8XDIA14X4

14.AA082101 BUSHING - 6X10X6

1.03603006N (x14) SCREW - M3X6

19.D0146272 BUSHING:BRUSH:REAR

11.52062686 (x2) SNAP RING

6.07010060N WASHER DIA6

17.AB011126 GEAR:20Z

U001	U002	U003	U004	U005	U006	U007	U008	U009	U010	U011	U012	U013	U014	U015	U016	U017	U018	U019	U020	U021
------	------	------	------	------	------	------	------	------	------	------	------	------	------	------	------	------	------	------	------	------

U011_S001

TRANSFER/SEPARATION UNIT:ASS'Y

- 46.D0A56252 TRANSFER ROLLER:18MIC 201809-01 O/O
- 25.D0746265 BLADE:TRANSFER ROLLER:ASS'Y
- 43.G1786767 COATING BAR:TRANSFER ROLLER
- 42.G1784018 CASE:COATING BAR:TRANSFER ROLLER
- 31.D0746280 GUIDE PLATE:ENTRANCE:TRANSFER ROLLER:ASS'Y



- 45.D0A56200 [A] TRANSFER/SEPARATION UNIT:ASS'Y 201805-05 O/O

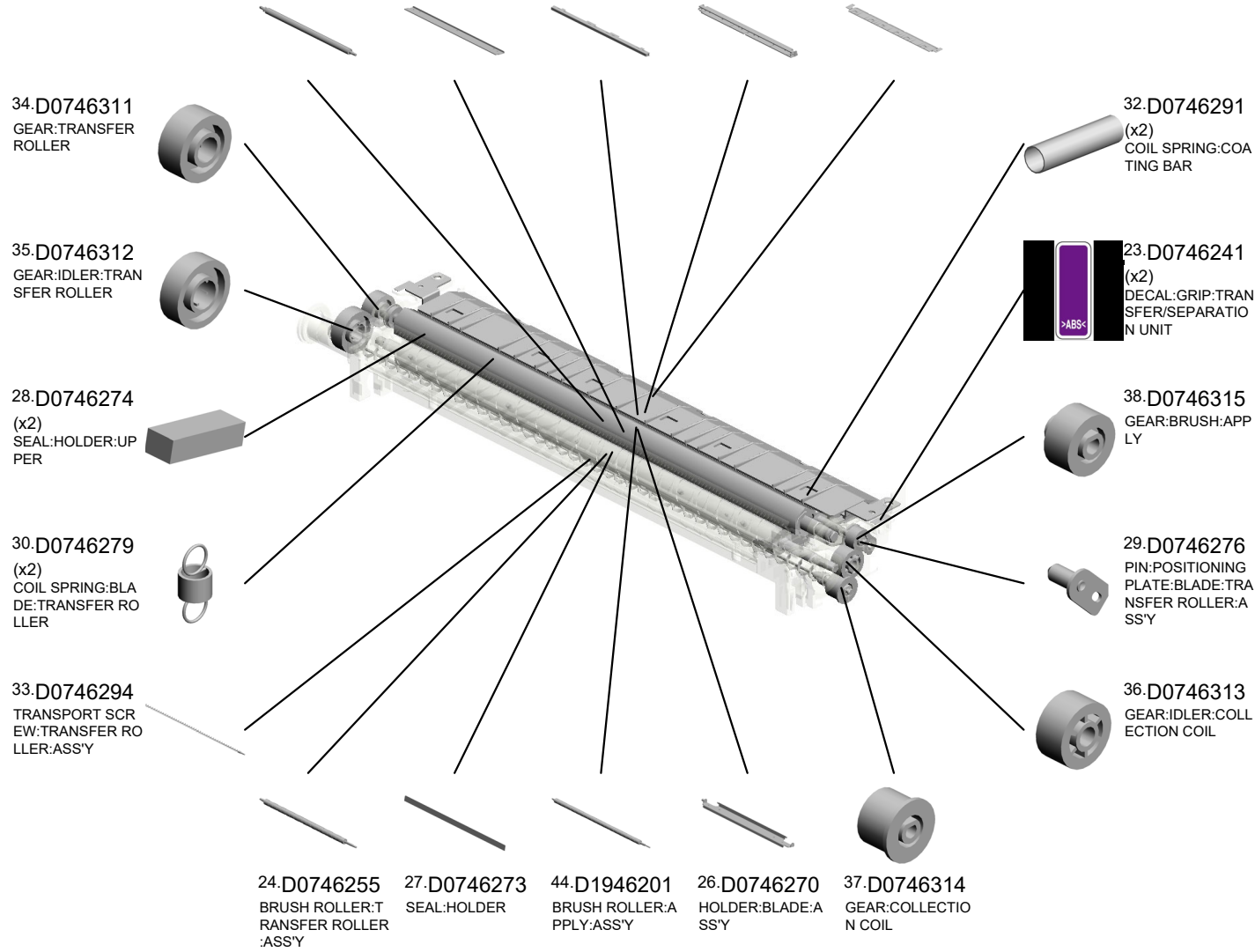

U001	U002	U003	U004	U005	U006	U007	U008	U009	U010	U011	U012	U013	U014	U015	U016	U017	U018	U019	U020	U021
------	------	------	------	------	------	------	------	------	------	------	------	------	------	------	------	------	------	------	------	------

U011_S001
TRANSFER/SEPARATION UNIT:ASS'Y

47.D0746212
SEAL:TRANSFER
ROLLER:REAR

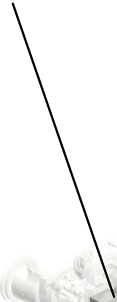
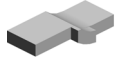

48.D0746213
SEAL:TRANSFER
ROLLER:FRONT

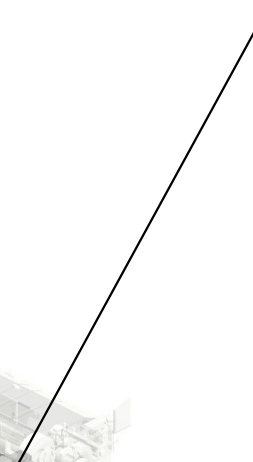

45.D0A56200
[A]
TRANSFER/SEPAR
ATION UNIT:ASS'Y
201805-05 O/O



D1946200
[A]
TRANSFER/SEPAR
ATION UNIT:ASS'Y
201805-05 O/O

U001	U002	U003	U004	U005	U006	U007	U008	U009	U010	U011	U012	U013	U014	U015	U016	U017	U018	U019	U020	U021
------	------	------	------	------	------	------	------	------	------	------	------	------	------	------	------	------	------	------	------	------

U011_S001_S001
SEPARATION CORONA:ASS'Y

3.04523006N
BINDING SELF-TAPPING SCREW:3X
6



41-D1946301
SEPARATION CORONA:ASS'Y

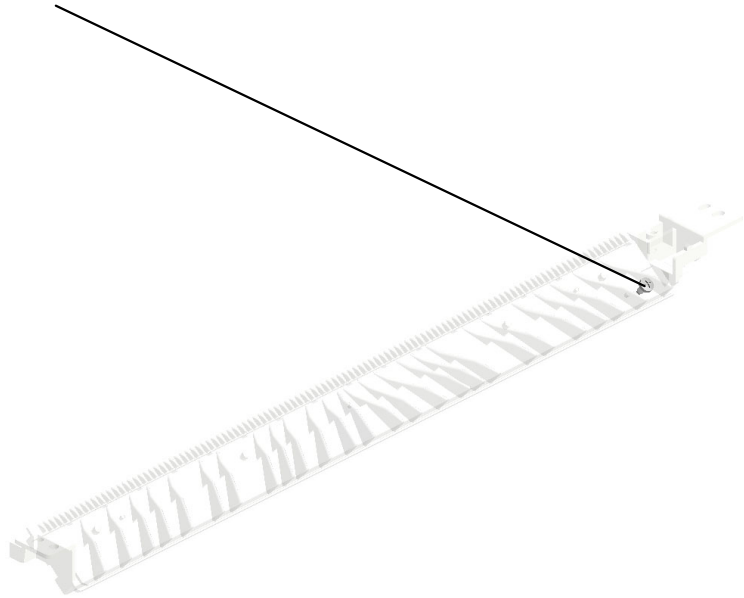

U001	U002	U003	U004	U005	U006	U007	U008	U009	U010	U011	U012	U013	U014	U015	U016	U017	U018	U019	U020	U021
------	------	------	------	------	------	------	------	------	------	------	------	------	------	------	------	------	------	------	------	------

U012.USED TONER

U012 S006
D0746627
COLLECTION BOTTLE:SMAL
L:ASSY

U012 S004
D0746601
TONER OUTLET SUB-UNIT:L
OWER:ASSY

U012 S005
D1946521
TONER OUTLET SUB-UNIT:P
CU:MAIN:5ST:ASSY

U012 S007
D0746590
COLLECTION BOTTLE:ASSY

U012 S001
D0746531
TONER OUTLET SUB-UNIT:B
ELT CLEANING:MAIN:ASSY

U012 S002
D0746551
TONER OUTLET SUB-UNIT:V
ERTICAL TRANSPORT:ASSY

U012 S003
D0746572
BRACKET:VERTICAL TRANS
PORT:ASSY

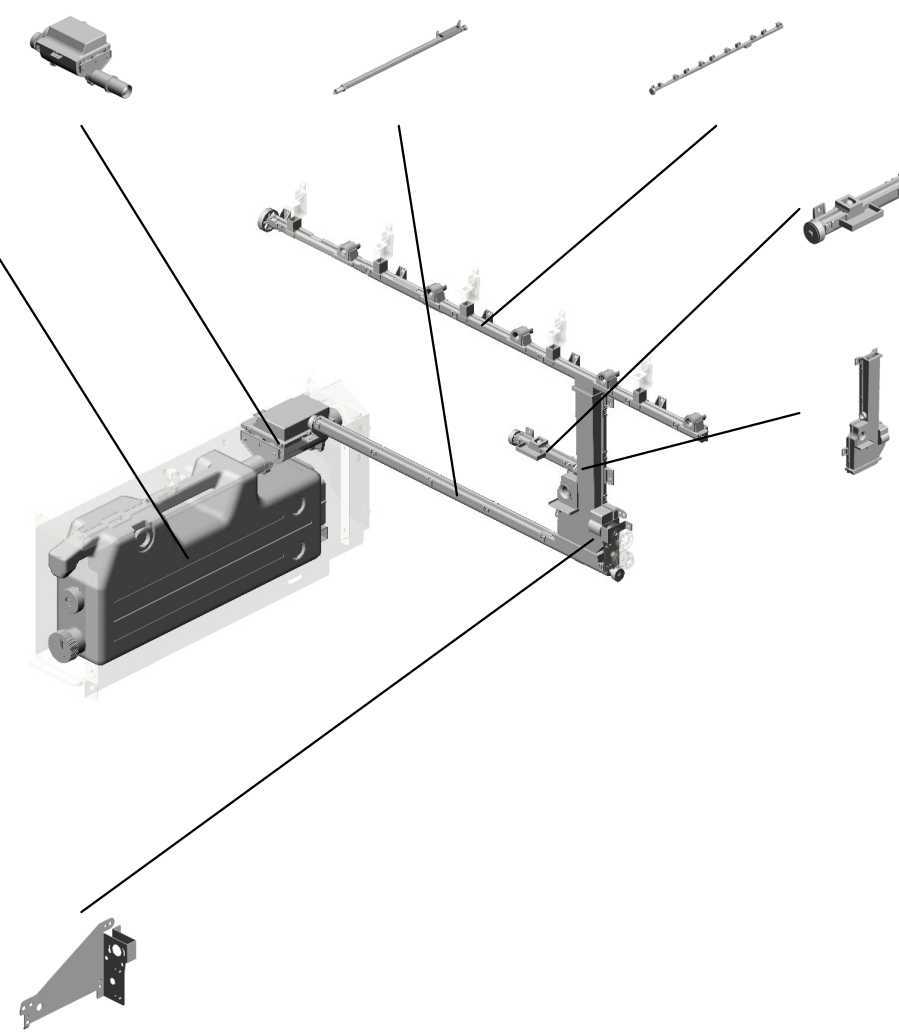

U001	U002	U003	U004	U005	U006	U007	U008	U009	U010	U011	U012	U013	U014	U015	U016	U017	U018	U019	U020	U021
------	------	------	------	------	------	------	------	------	------	------	------	------	------	------	------	------	------	------	------	------

U012 USED TONER

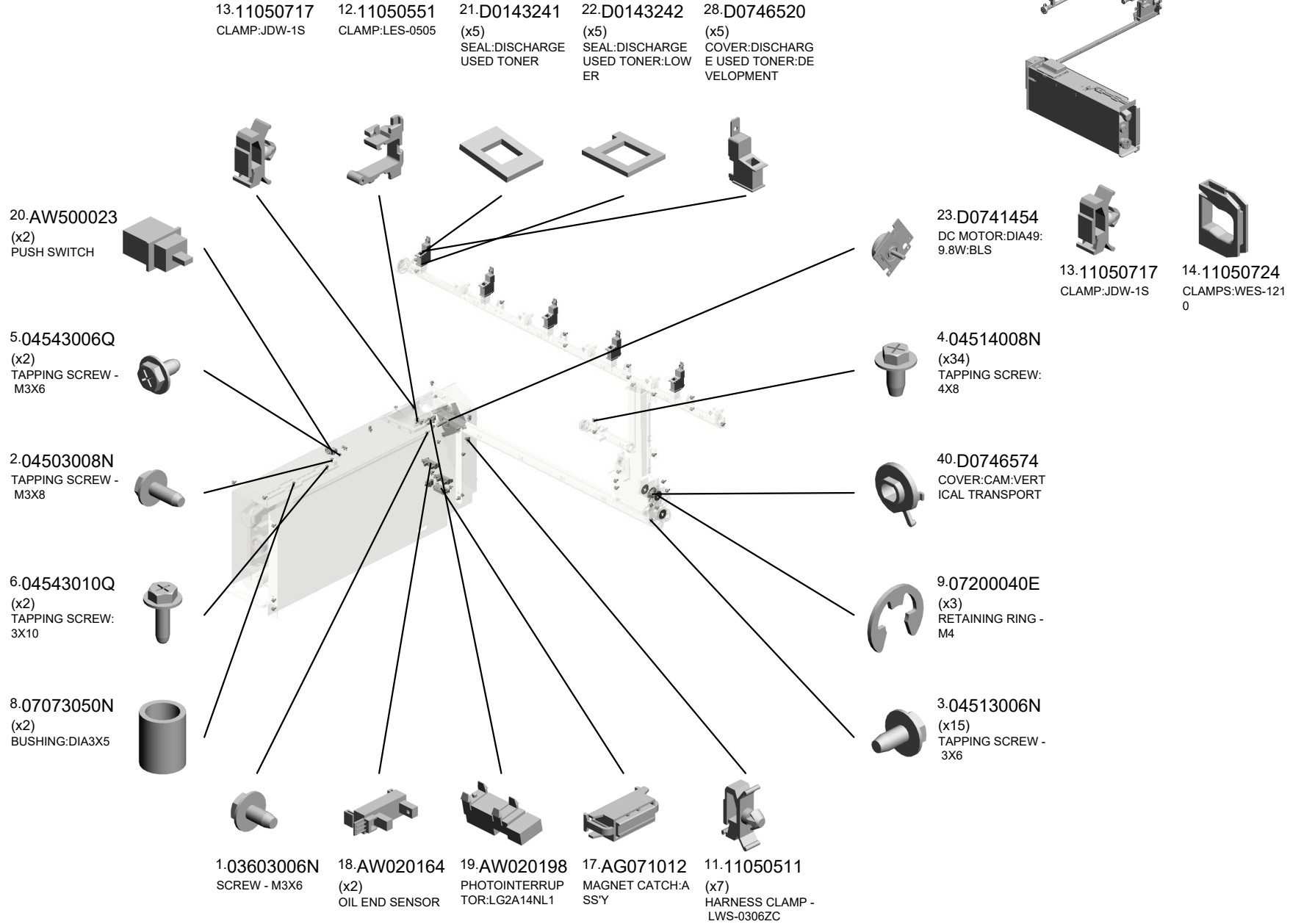

U012 USED TONER

- 71.D0746663 TORQUE LIMITER MECHANICAL CLUTCH:GEAR:Z63
- 81.D1946528 (D194/D195):(D203/D204-NA,-EU):CAP:TONER OUTLET SUB-UNIT
- 72.D0746664 GEAR:IDLER:Z49/Z27
- 73.D0746665 GEAR:JOINT:COLLECTION BOTTLE:Z65
- 74.D0746666 GEAR:IDLER:Z37/Z28

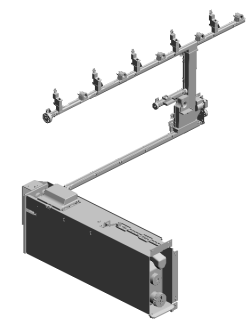

68.D0746647
BRACKET:PUSH SWITCH



70.D0746659
SHAFT:JOINT:COLLECTION BOTTLE:ASS'Y



77.D0746669
SPRING PLATE:PUSH SWITCH



69.D0746648
LINK:PUSH SWITCH:TONER RECYCLING SUB-UNIT



52.D0746626
INNER COVER:TONER RECYCLING SUB-UNIT



82.D1946656
COVER:GEAR:SIDE PLATE:PEEN



75.D0746667
HOLDER:RADIAL BALL BEARING:JOINT



42.D0746577
CAM:VERTICAL TRANSPORT:DIA15



46.D0746586
GEAR:Z35:IDLER:VERTICAL TRANSPORT



44.D0746579
SEAL:COVER:CAM:VERTICAL TRANSPORT



41.D0746575
SHAFT:CAM:VERTICAL TRANSPORT



84.GA082010
BUSHING:DIA6:DIA10:9



43.D0746578
GEAR:Z37:CAM:VERTICAL TRANSPORT



45.D0746585
(x2)
GEAR:Z38/Z24:VERTICAL TRANSPORT



U012_S001
 TONER OUTLET SUB-UNIT:BELT CLEANING:MAIN:ASS'Y

31.D0746539 GEAR:Z29:TRANSPORT SCREW:BELT CLEANING
 24.D0746511 PLAIN SHAFT BEARING:TONER RECYCLING SUB-UNIT
 32.D0746540 SEAL:BELT CLEANING:MAIN

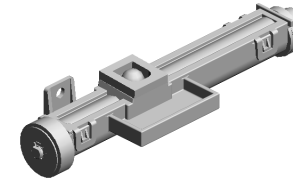

29.D0746531
 TONER OUTLET SUB-UNIT:BELT CLEANING:MAIN:ASS'Y

9.07200040E
 RETAINING RING - M4

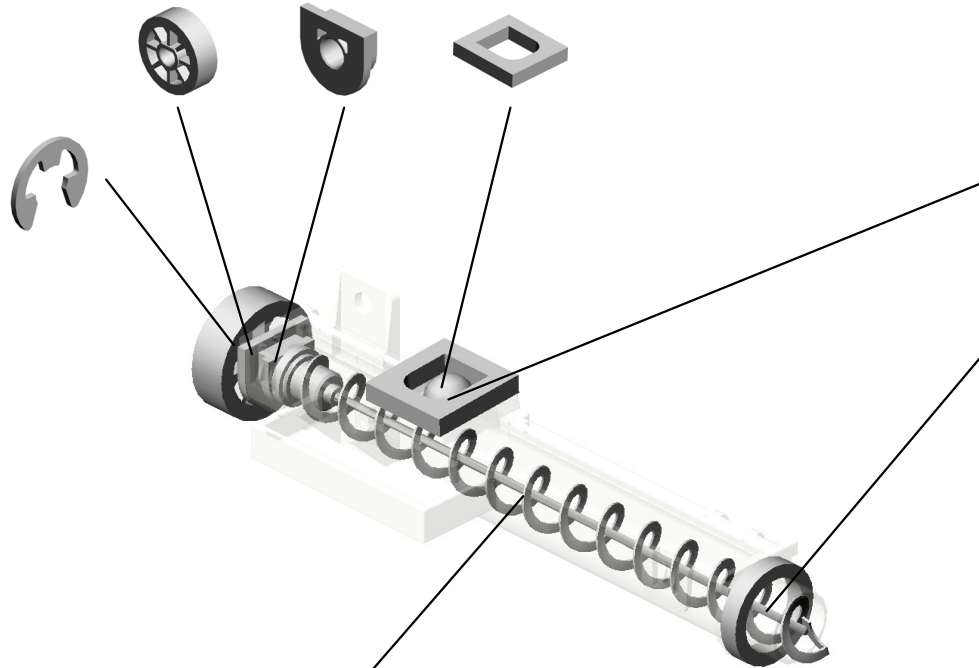

27.D0746517
 STEEL BALL:TONER OUTLET SUB-UNIT

33.D0746541
 SEAL:RING:TONER OUTLET SUB-UNIT:BELT CLEANING

30.D0746534
 TRANSPORT SCREW:BELT CLEANING:MAIN:ASS'Y

U001	U002	U003	U004	U005	U006	U007	U008	U009	U010	U011	U012	U013	U014	U015	U016	U017	U018	U019	U020	U021
------	------	------	------	------	------	------	------	------	------	------	------	------	------	------	------	------	------	------	------	------

U012_S002
TONER OUTLET SUB-UNIT:VERTICAL TRANSPORT:ASS'Y

38.D0746567
SEAL:VERTICAL T
RANSPORT:UPPE
R

35.D0746564
TONER OUTLET S
UB-UNIT:T/S UNIT:
SHUTTER:OUTER

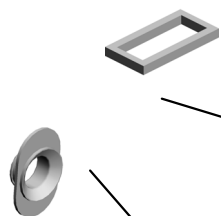

36.D0746565
TONER OUTLET S
UB-UNIT:T/S UNIT:
SHUTTER:INNER



37.D0746566
SEAL:VERTICAL T
RANSPORT:LOWE
R



34.D0746551
TONER OUTLET S
UB-UNIT:VERTICA
L TRANSPORT:AS
S'Y

U001	U002	U003	U004	U005	U006	U007	U008	U009	U010	U011	U012	U013	U014	U015	U016	U017	U018	U019	U020	U021
------	------	------	------	------	------	------	------	------	------	------	------	------	------	------	------	------	------	------	------	------

U012_S003
BRACKET:VERTICAL TRANSPORT:ASS'Y

16-AA080247
BUSHING - B-F6-3

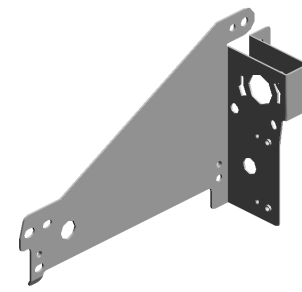
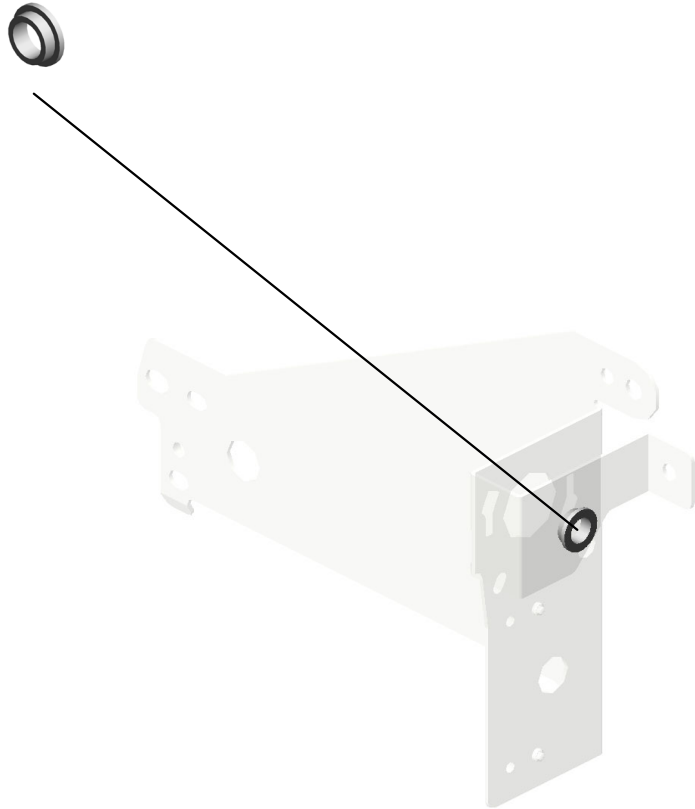

39.D0746572
BRACKET:VERTICAL TRANSPORT:ASS'Y

U001	U002	U003	U004	U005	U006	U007	U008	U009	U010	U011	U012	U013	U014	U015	U016	U017	U018	U019	U020	U021
------	------	------	------	------	------	------	------	------	------	------	------	------	------	------	------	------	------	------	------	------

U012_S004
 TONER OUTLET SUB-UNIT:LOWER:ASS'Y

49.D0746604 24.D0746511
 TRANSPORT SCR PLAIN SHAFT BEA
 EW:TONER OUTLE RING:TONER REC
 T SUB-UNIT:LOWE YCLING SUB-UNIT
 R:ASS'Y

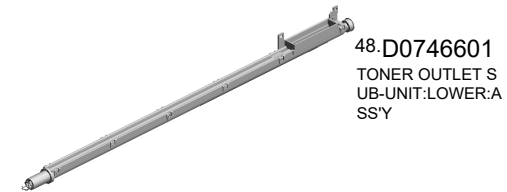

48.D0746601
 TONER OUTLET S
 UB-UNIT:LOWER:A
 SS'Y

51.D0746610
 SEAL:RING:TONER
 OUTLET SUB-UNI
 T:LOWER

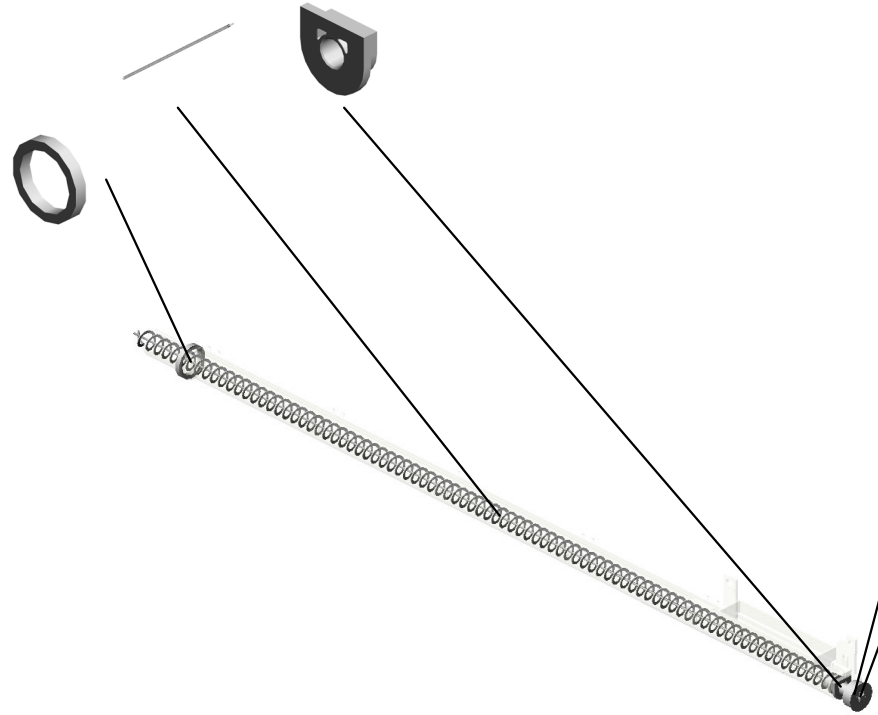

50.D0746609
 GEAR:Z23:TRANSP
 ORT SCREW:LOW
 ER

9.07200040E
 RETAINING RING -
 M4

U001	U002	U003	U004	U005	U006	U007	U008	U009	U010	U011	U012	U013	U014	U015	U016	U017	U018	U019	U020	U021
------	------	------	------	------	------	------	------	------	------	------	------	------	------	------	------	------	------	------	------	------

U012_S005

TONER OUTLET SUB-UNIT:PCU:MAIN:5ST:ASS'Y

25.D0746512 26.D0746514
GEAR:Z35:TRANSP (x5)
ORT SCREW:PCU: SEAL:TONER OUT
MAIN LET SUB-UNIT:PC
U



80.D1946521
TONER OUTLET S
UB-UNIT:PCU:MAI
N:5ST:ASS'Y

9.07200040E
RETAINING RING -
M4

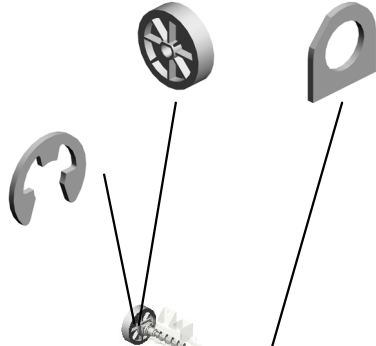

27.D0746517
(x10)
STEEL BALL: TONE
R OUTLET SUB-UN
IT



24.D0746511
(x2)
PLAIN SHAFT BEA
RING: TONER REC
YCLING SUB-UNIT



79.D1946504
TRANSPORT SCR
EW:PCU:MAIN:ASS
'Y

U001	U002	U003	U004	U005	U006	U007	U008	U009	U010	U011	U012	U013	U014	U015	U016	U017	U018	U019	U020	U021
------	------	------	------	------	------	------	------	------	------	------	------	------	------	------	------	------	------	------	------	------

U012_S006
COLLECTION BOTTLE:SMALL:ASS'Y

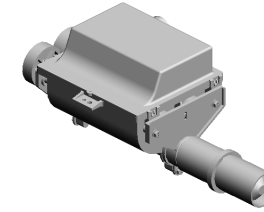

53.D0746627
COLLECTION BOT
TLE:SMALL:ASSY

63.D0746642 (x2)
PLAIN SHAFT BEARING:SMALL

67.D0746646 (x2)
SEAL:TONER RECYCLING SUB-UNIT:SMALL

59.D0746634 (x2)
AGITATOR:SMALL

54.D0746629
COVER:COLLECTION BOTTLE:SMALL

62.D0746641 (x2)
PLAIN SHAFT BEARING:SMALL:GEAR

2.04503008N
(x6)
TAPPING SCREW - M3X8

55.D0746630
PIPE:COLLECTION BOTTLE:SMALL

56.D0746631
SHUTTER:TONER RECYCLING SUB-UNIT:SMALL

57.D0746632
COMPRESSION SPRING:SHUTTER:SMALL

76.D0746668
SEAL:PIPE:TONER RECYCLING SUB-UNIT:SMALL

60.D0746635
TRANSPORT SCREW:SMALL:ASS'Y

61.D0746640
PLAIN SHAFT BEARING:TRANSPORT SCREW:SMALL

7.06320140G
PARALLEL PIN

66.D0746645
GEAR:AGITATOR:COLLECTION BOTTLE:SMALL:Z41

65.D0746644
GEAR:AGITATOR:COLLECTION BOTTLE:SMALL:Z49/Z41

58.D0746633
COVER:BEARING:SMALL

10.08050089
(x2)
RETAINING RING - M4

64.D0746643
GEAR:TRANSPORT SCREW:COLLECTION BOTTLE:SMALL:Z31

U001	U002	U003	U004	U005	U006	U007	U008	U009	U010	U011	U012	U013	U014	U015	U016	U017	U018	U019	U020	U021
------	------	------	------	------	------	------	------	------	------	------	------	------	------	------	------	------	------	------	------	------

U012_S007
COLLECTION BOTTLE:ASS'Y

10.08050089 83.G0603602
RETAINING RING - CAP:BOTTLE
M4

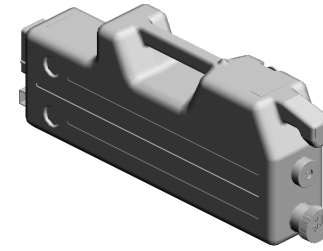

47.D0746590
COLLECTION BOT
TLE:ASS'Y

15.AA036015
CAP:COLLECTION
BOTTLE

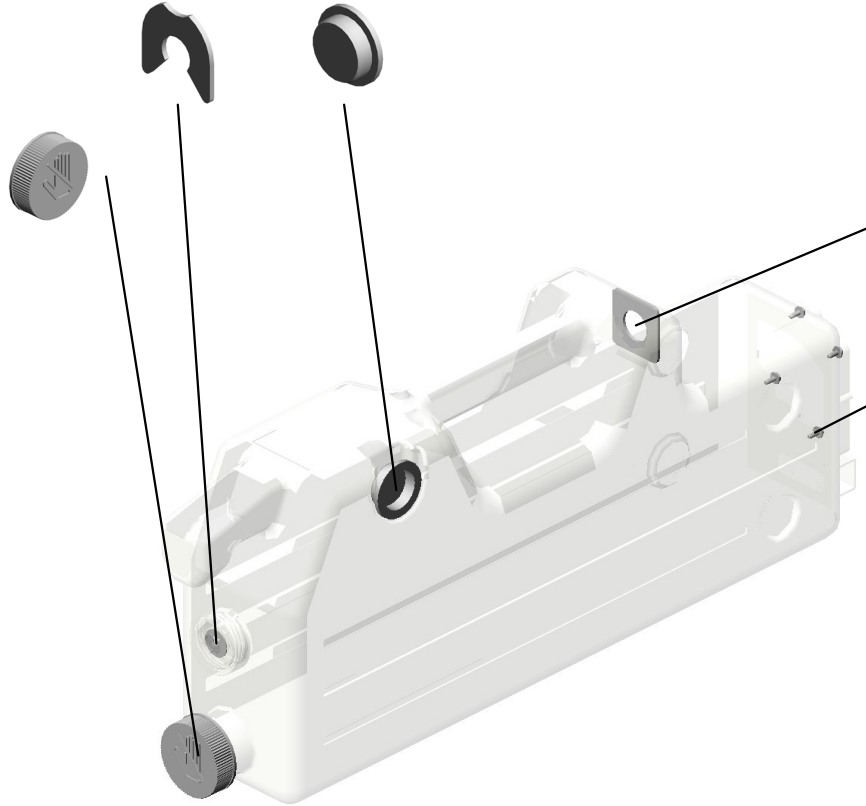

78.D0746684
SEAL:TANK:USED
TONER:COLLECT

2.04503008N
(x4)
TAPPING SCREW -
M3X8

U001	U002	U003	U004	U005	U006	U007	U008	U009	U010	U011	U012	U013	U014	U015	U016	U017	U018	U019	U020	U021
------	------	------	------	------	------	------	------	------	------	------	------	------	------	------	------	------	------	------	------	------

U013.PAPER FEED(MAIN)

U013 S001
D1942612
TRANSPORT UNIT:ASS'Y

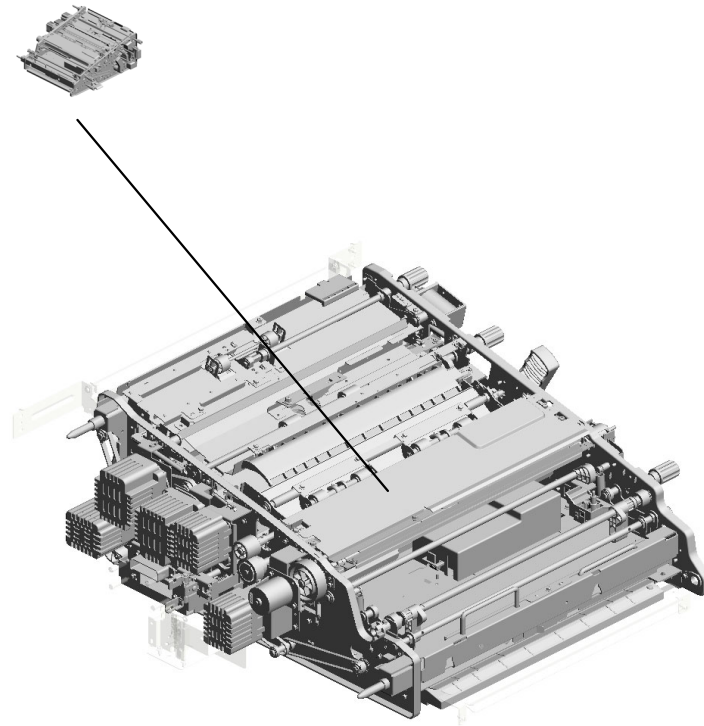

U001	U002	U003	U004	U005	U006	U007	U008	U009	U010	U011	U012	U013	U014	U015	U016	U017	U018	U019	U020	U021
------	------	------	------	------	------	------	------	------	------	------	------	------	------	------	------	------	------	------	------	------

U013_S001.TRANSPORT UNIT:ASS'Y

U013 S001 S002
D1942704
SWING UNIT:ASS'Y

U013 S001 S001
D1942681
CONTACT IMAGE SENSOR:A
SS'Y

U013 S001 S004
D0746230
CASE:TERMINAL:SEPARATI
ON:ASS'Y

U013 S001 S003
D0742979
LEVER:GUIDE PLATE

U001	U002	U003	U004	U005	U006	U007	U008	U009	U010	U011	U012	U013	U014	U015	U016	U017	U018	U019	U020	U021
------	------	------	------	------	------	------	------	------	------	------	------	------	------	------	------	------	------	------	------	------

U013 PAPER FEED(MAIN)

183.D0742942 PIN:GUIDE PLATE: CONNECTION:LARGE CAPACITY TRAY:UPPER
 156.D0742797 STAY:CONNECTIO N:LARGE CAPACIT Y TRAY
 157.D0742799 GUIDE PLATE:CON NECTION:LCT:LOW ER
 181.D0742938 GUIDE PLATE:CON NECTION:LARGE C APACITY TRAY:UP PER:PEEN
 44.54472681 SNAP RING

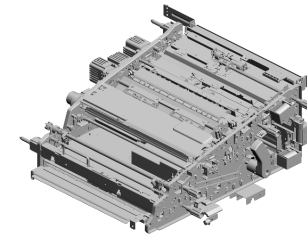

9.03604008N
(x6)
SCREW - M4X8



62.AA063725
(x2)
COMPRESSION SP RING:CONNECTO R:DRAWER:UPPE R



73.AA143884
(x2)
STEPPED SCREW: DIA5.4:DIA3.5:M3:L ONG



249.G1781602
ARM:SAFETY SWI TCH:UPPER:ASS'Y



238.D1942972
STAY:SAFETY SWI TCH



71.AA143797
CONNECTOR GUI DE PIN



1.03130040N
(x2)
SCREW:M3X4



7.03603014N
(x2)
SCREW - M3X14



237.D1942971
BRACKET:SAFETY SWITCH



43.12042612
MICRO SWITCH:D3 V-16506-3C25



202.D0743047
BRACKET:HOLDER :DUPLEX:ASS'Y



36.11050488
HARNESS CLAMP



200.D0743038
BRACKET:DUPLEX :EXIT



14.04514008N(x 3)
TAPPING SCREW:4X8

201.D0743039
GUIDE PLATE:DUP LEX:EXIT



14.04514008N
(x9)
TAPPING SCREW: 4X8



199.D0743033
GUIDE PLATE:CON NECTING



U013 PAPER FEED(MAIN)

261.G1787515 (x2)
CONNECTOR GUI
DE PIN:CONNECT
OR

255.G1784866 (x2)
COMPRESSION SP
RING:EXIT:CONNE
CTOR

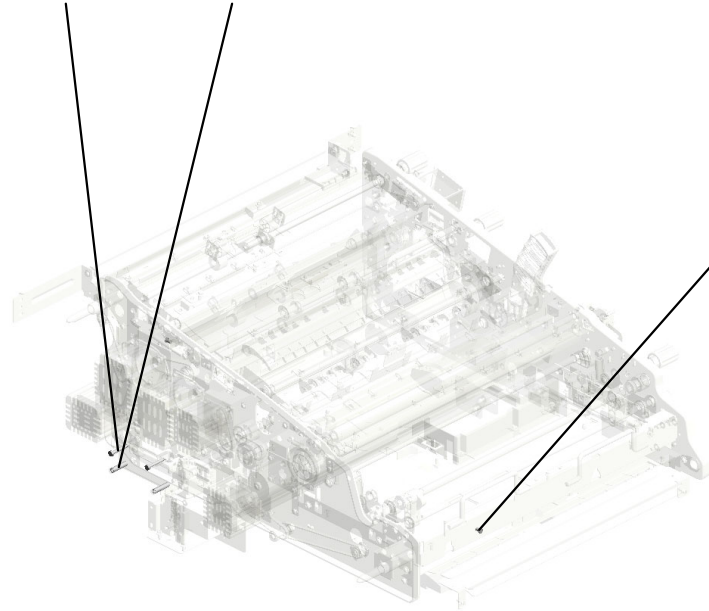
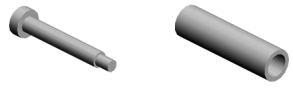
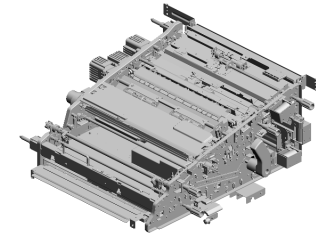

271.G1787793
(x2)
SCREW:REGISTRA
TION:FIX

U001	U002	U003	U004	U005	U006	U007	U008	U009	U010	U011	U012	U013	U014	U015	U016	U017	U018	U019	U020	U021
------	------	------	------	------	------	------	------	------	------	------	------	------	------	------	------	------	------	------	------	------

U013_S001
TRANSPORT UNIT:ASS'Y

- 5.03603006N (x29) SCREW - M3X6
- 8.03604006N (x3) SCREW - M4X6
- 6.03603008N (x4) SCREW:M3X8
- 10.03604010N (x9) SCREW:M4X10
- 9.03604008N (x91) SCREW - M4X8

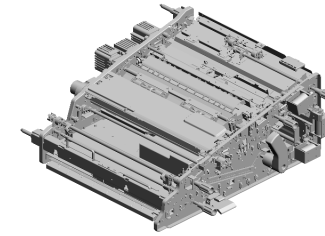

284-D1942612
[A]
TRANSPORT UNIT:
ASS'Y
201610-05 X/O

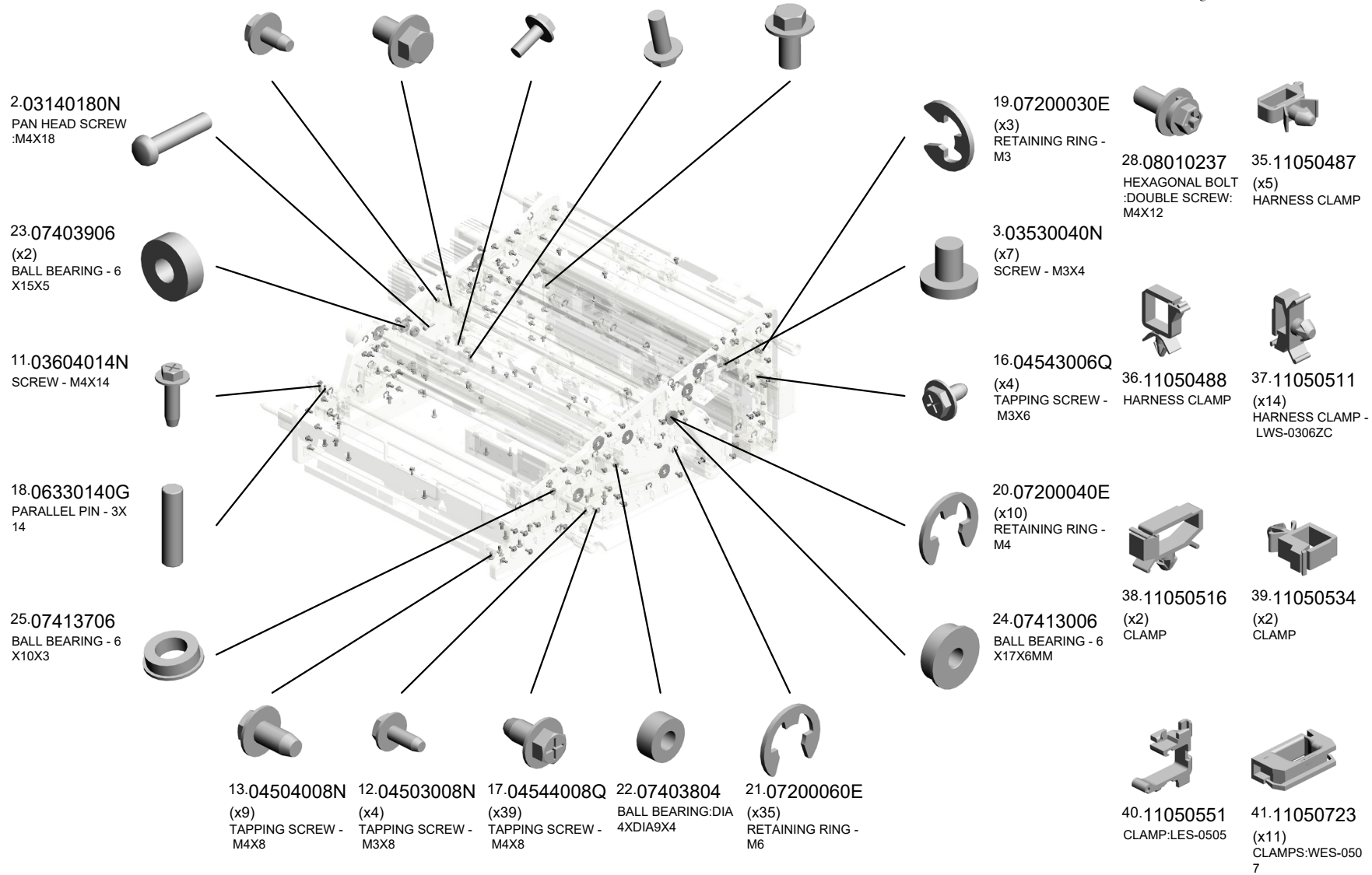

U013_S001
 TRANSPORT UNIT:ASS'Y

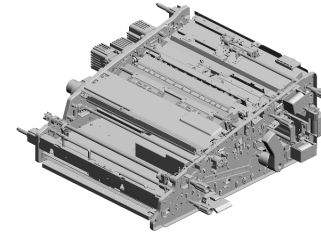

284-D1942612
 [A]
 TRANSPORT UNIT:
 ASS'Y
 201610-05 X/O

- 49.AA043621 TIMING BELT - 60S 2M156
- 41.11050723 (x3) CLAMPS:WES-050 7
- 46.AA043312 TIMING BELT:60S2 M138
- 31.08050089 (x10) RETAINING RING - M4
- 40.11050551 (x3) CLAMP:LES-0505

39.11050534
 (x4)
 CLAMP

48.AA043609
 TIMING BELT:60S2 M124

50.AA043634
 TIMING BELT - 40S 2M296

44.54472681
 SNAP RING

33.08053573
 (x2)
 RADIAL BALL BEARING: DIA8XDIA16X5

45.A2574493
 BAND

37.11050511
 (x62)
 HARNESS CLAMP - LWS-0306ZC

29.08046123
 (x2)
 HEXAGONAL BOLT :W/WASHER.M3X8

34.09543008N
 (x6)
 SCREW - M3X8

38.11050516
 (x13)
 CLAMP

32.08050092
 (x2)
 RETAINING RING - 3M

27.07423808
 (x7)
 BALL BEARING - 8 X16X5

28.08010237
 (x3)
 HEXAGONAL BOLT :DOUBLE SCREW: M4X12

30.08050088
 (x4)
 RETAINING RING - M6

26.07413708
 BALL BEARING - 8 X12X3.5MM

42.11050726
 (x2)
 CLAMPS:WES-221 7

68.AA082104
 BUSHING - 8X12X7

5.03603006N(x 5)
 SCREW - M3X6
 9.03604008N(x12)
 SCREW - M4X8
 17.04544008Q(x20)
 TAPPING SCREW - M4X8
 19.07200030E(x 1)
 RETAINING RING - M3
 20.07200040E(x 2)
 RETAINING RING - M4
 21.07200060E(x 2)
 RETAINING RING - M6

67.AA082101
 BUSHING - 6X10X6

88.AX560011
 LED

U013_S001
 TRANSPORT UNIT:ASS'Y

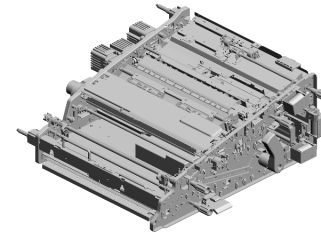

284-D1942612
 [A]
 TRANSPORT UNIT:
 ASS'Y
 201610-05 X/O

- 74.AA161122 (x2) MOTOR CUSHION
- 64.AA066402 TORSION SPRING: GUIDE PLATE:REAR
- 52.AA043639 SYNCHRONOUS BELT:B60S2M192
- 63.AA066400 COIL SPRING:PAWL:OPEN AND CLOSER
- 78.AF022167 TRANSPORT ROLLER - DRIVEN

70.AA132300 (x2) ROLLER:LOCK:PU LL OUT

59.AA061109 (x2) TENSION SPRING: PRESSURE:TIMING ROLLER:TRANSFER

68.AA082104 (x10) BUSHING - 8X12X7

54.D1942648 COIL SPRING:GATE 201607-02 X/O

53.AA061065 (x4) TENSION SPRING: DUPLEX:DRIVEN ROLLER

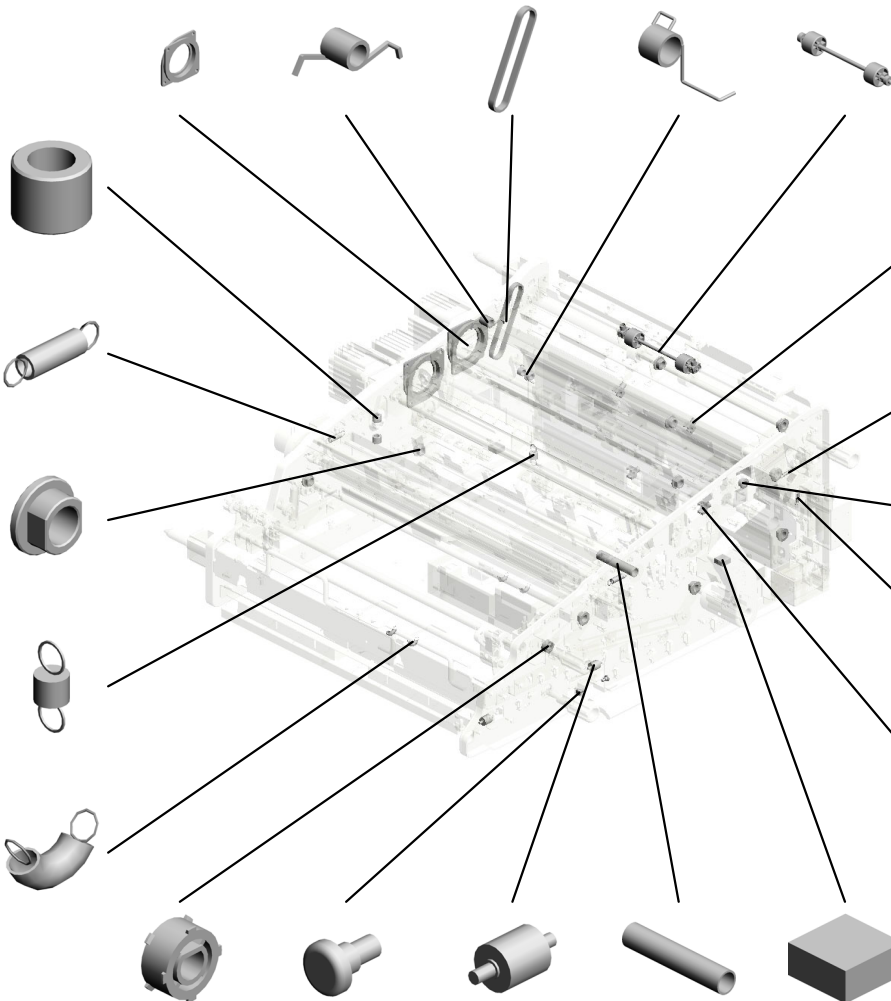

61.AA063678 (x6) SPRING - 3.5N

56.AA061097 TENSION SPRING: DC SOLENOID:ON-OFF:LARGE CAPACITY TRAY

66.AA080346 (x2) BUSHING:FLANGE TYPE:DIA6

57.AA061098 TENSION SPRING: DC SOLENOID:ON-OFF:MAIN

69.AA084059 (x6) BALL BEARING HOLDER

76.AB030846 TIMING PULLEY:S2 M:22T

72.AA143811 (x2) STEPPED SCREW - M3X4

77.AF022067 (x2) GUIDE STOPPER ROLLER

60.AA063468 COMPRESSION SPRING:RING:SHIFT

75.AA161157 (x2) BRACKET CUSHION

U013_S001
 TRANSPORT UNIT:ASS'Y

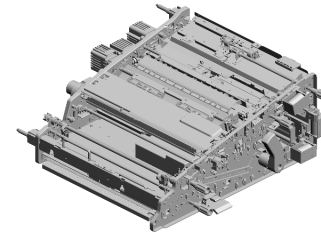

284-D1942612
 [A]
 TRANSPORT UNIT:
 ASS'Y
 201610-05 X/O

- 99.B8341648 TIMING BELT - B60 S2M120
- 86.AX040157 (x2) STEPPER MOTOR DC1.68V 6.7W
- 84.AW020198 (x2) PHOTOINTERRUPTOR:LG2A14NL1
- 83.AW000012 OPTICS SENSOR:P HOTO
- 82.AG070513 MAGNET CATCH

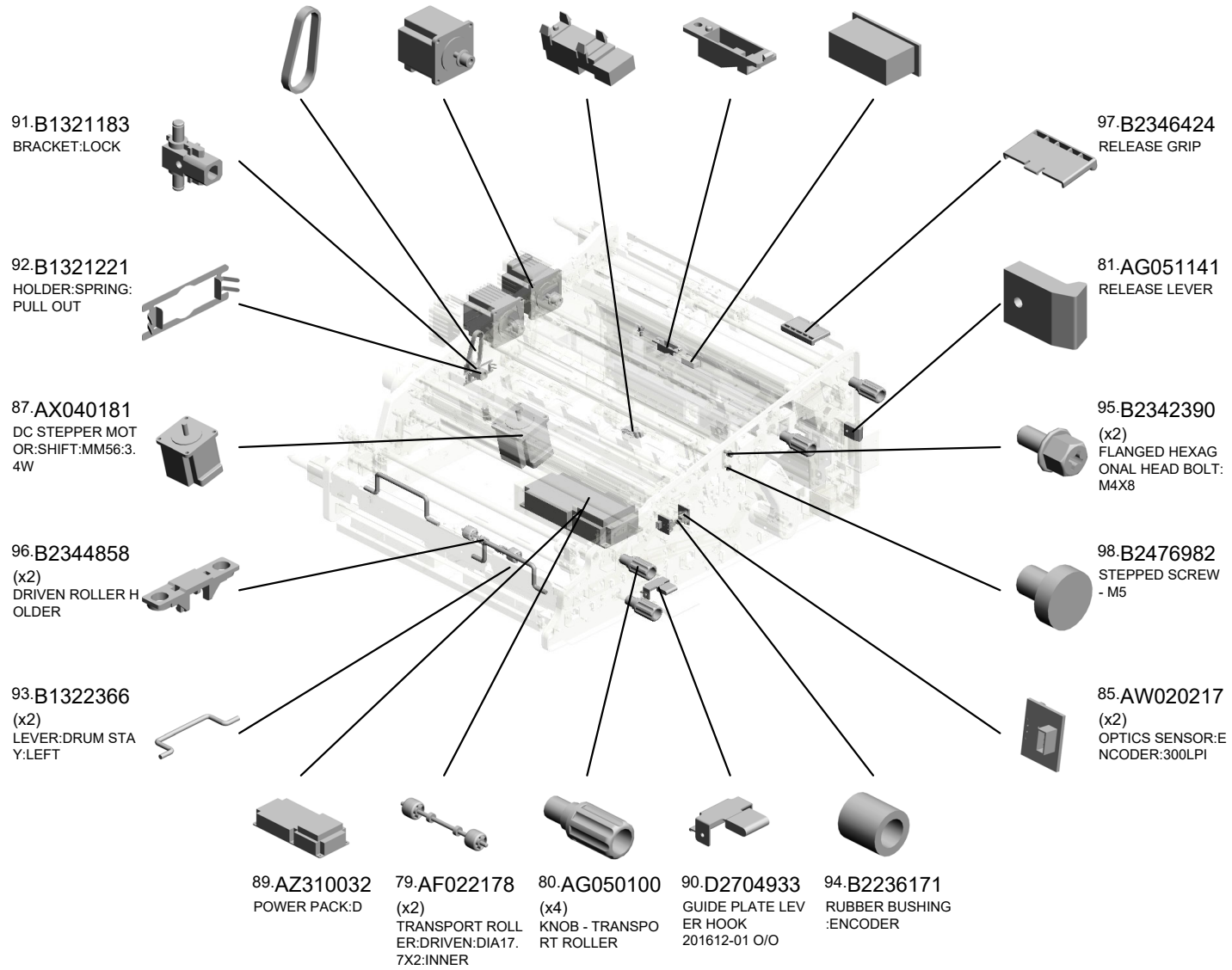

U001	U002	U003	U004	U005	U006	U007	U008	U009	U010	U011	U012	U013	U014	U015	U016	U017	U018	U019	U020	U021
------	------	------	------	------	------	------	------	------	------	------	------	------	------	------	------	------	------	------	------	------

U013_S001
 TRANSPORT UNIT:ASS'Y

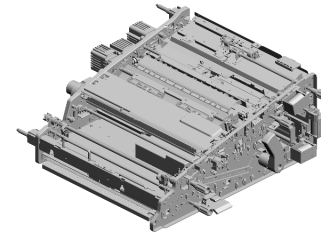

284.D1942612
 [A]
 TRANSPORT UNIT:
 ASS'Y
 201610-05 X/O

100.B8352889 TIMING BELT - B60 S2M144
 109.D0742626 TIMING PULLEY:S2 M:31T/31T
 110.D0742629 BRACKET:DC STE PPER MOTOR:TRANSPORT ROLLER:SHIFT
 101.B8722614 (x2) BUSHING:R1
 111.D0742632 BRACKET:DC STE PPER MOTOR:MM56:CAM

103.D0592399 (x5) FLANGED HEXAGONAL HEAD BOLT: M3*4

107.D0742621 PLATE:DC MOTOR:TIMING ROLLER:TRANSFER

114.D0742642 GEAR:TIMING ROLLER:TRANSFER:Z59

108.D0742622 BRACKET:DC MOTOR:TIMING ROLLER:TRANSFER

121.D0742681 SHAFT:CAM:SHIFT

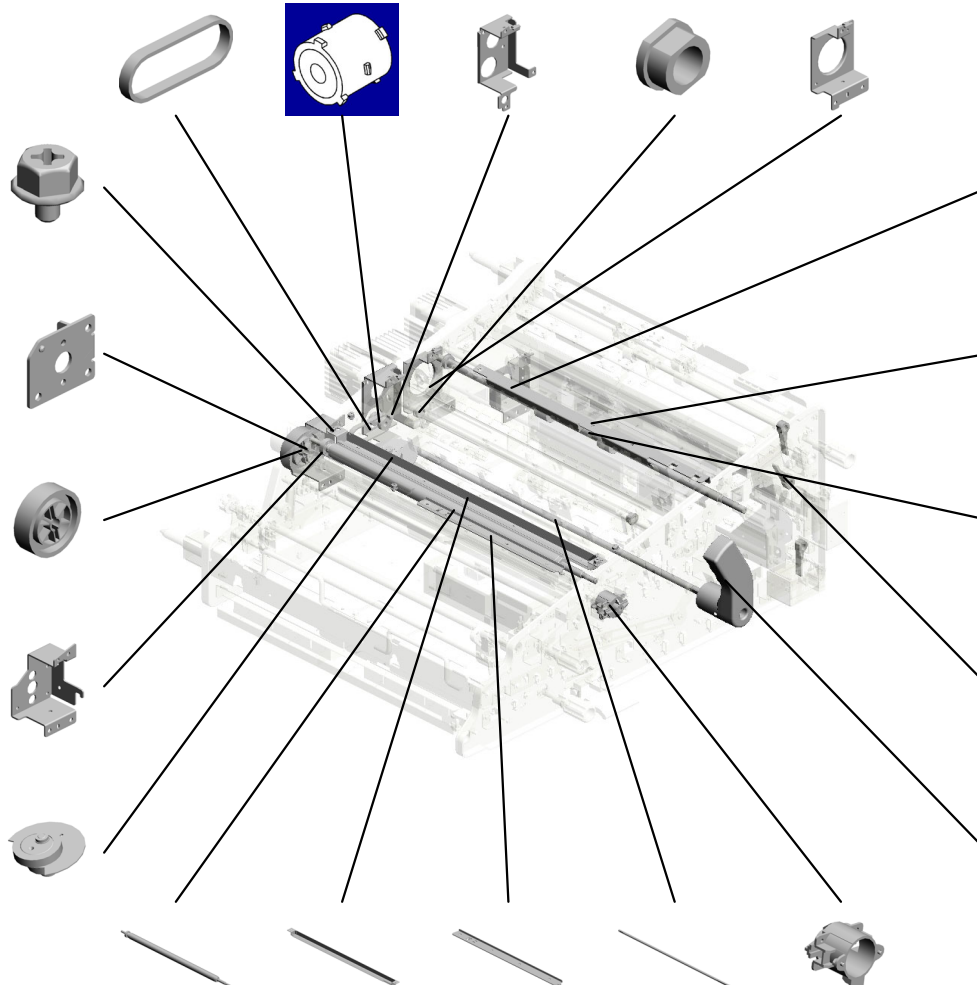

112.D0742634 BRACKET:DC STE PPER MOTOR:MM42:REGISTRATION:ENTRANCE

118.D0742663 HOLDER:SENSOR:REGISTRATION:TIMING

119.D0742665 REGISTRATION ROLLER:TIMING:DRIVE

116.D0742652 (x3) LEVER:LINK:TRANSPORT ROLLER

104.D0741179 LEVER:PULL OUT:REGISTRATION

115.D0742643 TIMING ROLLER:TRANSFER:DRIVEN
 117.D0742654 CASE:REMOVE PA PER DUST:ASS'Y
 113.D0742636 HOLDER:SENSOR:TRANSFER:TIMING
 105.D0741194 SHAFT:LOCK:TRANSPORT UNIT
 106.D0741369 COVER:ENCODER

U013_S001
TRANSPORT UNIT:ASS'Y

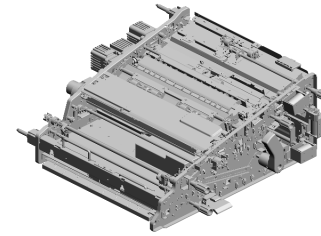

284.D1942612
[A]
TRANSPORT UNIT:
ASS'Y
201610-05 X/O

146.D0742769 BRACKET:DC STE
PPER MOTOR:REG
ISTRATION ROLLE
R:TIMING
140.D0742748 SHAFT:ARM:REGIS
TRATION ROLLER:
TIMING
144.D0742757 HOLDER:SENSOR:
CONNECTING:LCT:
NO.2
147.D0742771 SHAFT:REGISTRA
TION ROLLER:TIM
NG:DRIVEN
143.D0742756 HOLDER:SENSOR:
CONNECTING:LCT:
NO.1

141.D0742749
(x2)
ARM:REGISTRATI
ON ROLLER:TIMIN
G

150.D0742777
(x2)
CAM:REGISTRATI
ON ROLLER:TIMIN
G

125.D0742691
SHAFT:CAM

126.D0742693
CAM:GATE

130.D0742718
SHAFT:SHIFT

124.D0742687
HOLDER:HOME PO
SITION SENSOR:G
ATE

123.D0742686
DUCT:FAN:CONTA
CT IMAGE SENSO
R

149.D0742773
FIX STAND:GUIDE
PLATE:TIMING:TR
ANSFER:EXIT

131.D0742721
ARM:TRANSPORT
ROLLER:SHIFT:TA
KE SHEJTER

132.D0742722
PROTECTION:ARM
:TRANSPORT ROL
LER:SHIFT:TAKE S
HEJTER

128.D0742711
TRANSPORT ROLL
ER:CONNECTING:
LARGE CAPACITY
TRAY

142.D0742750
STAY:SOLENOID

129.D0742715
BRACKET:SOLENO
ID:PEEN

127.D0742694
CAM:TRANSPORT
ROLLER:SHIFT

148.D0742772
COVER:BEARING

U001	U002	U003	U004	U005	U006	U007	U008	U009	U010	U011	U012	U013	U014	U015	U016	U017	U018	U019	U020	U021
------	------	------	------	------	------	------	------	------	------	------	------	------	------	------	------	------	------	------	------	------

U013_S001
TRANSPORT UNIT:ASS'Y

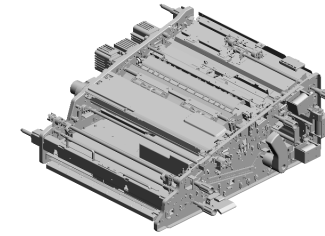

284.D1942612
[A]
TRANSPORT UNIT:
ASS'Y
201610-05 X/O

- 151.D0742783 REGISTRATION GUIDE:OPEN AND CLOSE
- 155.D0742795 GUIDE PLATE:REGISTRATION:ENTRANCE:LOWER
- 154.D0742794 HOLDER:DOUBLE FEED SENSOR:PHOTO
- 166.D0742881 TRANSPORT ROLLER:REGISTRATION:ENTRANCE:DRIVE:PRESS FIT
- 152.D1942786 GUIDE PLATE:CONNECTING:LARGE CAPACITY TRAY:LOWER
201509-06 X/O

161.D0742818
FIX STAND:GUIDE PLATE:REAR



159.D0742813
HOOK:COIL SPRING:GATE



172.D0742908
BRACKET:DC STEPPER MOTOR:DUPLEX:RIGHT



163.D0742864
GUIDE PLATE:DUPLEX:RIGHT:UPPER



167.D0742882
TRANSPORT ROLLER:DUPLEX:RIGHT:NO.1:PRESS FIT



173.D0742912
(x2)
BRACKET:SENSOR:DUPLEX:SHORT

164.D0742873
GUIDE PLATE:PULLEY OUT:RIGHT:VERTICAL TRANSPORT

162.D1942860
GUIDE PLATE:VERTICAL TRANSPORT:RIGHT:PEEN
201510-03 O/O

153.D0742789
HOLDER:DOUBLE FEED SENSOR:RAPIATE

158.D0742809
COVER:HARNES: PAPER FEED UNIT:FRONT

165.D0742876
SHAFT:LOCK:GUIDE PLATE

171.D0742904
(x2)
DC SOLENOID:PRESS FIT

168.D0742896
HOLDER:DC SOLENOID:VERTICAL TRANSPORT:UPPER

170.D0742903
DC SOLENOID:VERTICAL TRANSPORT:UPPER:PRESS FIT

169.D0742899
HOLDER:DC SOLENOID:VERTICAL TRANSPORT:LOWER:PEEN

U013_S001
TRANSPORT UNIT:ASS'Y

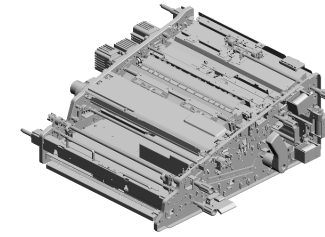

284.D1942612
[A]
TRANSPORT UNIT:
ASS'Y
201610-05 X/O

- 174.D0742924 COVER:HARNES
- 190.D0742970 (x2)
CAM:GUIDE PLATE
:OPEN AND CLOSE
- 191.D0742971 PLATE:LINK:OPEN
AND CLOSE:REAR
- 185.D0742960 GUIDE PLATE:REG
ISTRATION:ENTRA
NCE:UPPER
- 187.D0742964 STAY:REGISTRATI
ON:RIGHT UPPER

182.D0742941
TIMING PULLEY:S2
M:30T

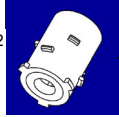

184.D0742955
GUIDE PLATE:TIMI
NG:TRANSFER

188.D0742965
HOLDER:PRESSU
RE:DRIVEN ROLLE
R:DUPLEX:EXIT

193.D0742974
STOPPER:LEVER:
TRANSPORT UNIT:
LEFT

180.D0742935
GUIDE:DUPLEX:OP
EN AND CLOSE:RI
GHT:LOWER

186.D0742962
BRACKET:MISFEE
D REMOVAL:TIMIN
G ROLLER:TRANS
FER

189.D0742969
SHAFT:MISFEED R
EMOVAL:TIMING R
OLLER:TRANSFER

176.D0742929
BRACKET:SENSO
R:VERTICAL TRAN
SPORT:NO.3

175.D0742926
BRACKET:SENSO
R:VERTICAL TRAN
SPORT:NO.2

177.D0742930
SHAFT:LINK:ON-O
FF:VERTICAL TRA
NSPORT:LOWER

179.D0742934
SHAFT:ON-OFF:LA
RGE CAPACITY TR
AY:CONNECTING

194.D0742975
STOPPER:GUIDE P
LATE:CONNECTIN
G:LARGE CAPACIT
Y TRAY

178.D0742931
SHAFT:LINK:ON-O
FF:VERTICAL TRA
NSPORT:UPPER

195.D0742977
COVER:HARNES
S:FRONT UPPER

192.D0742972
LEVER:GUIDE PLA
TE:OPEN AND CLO
SE:FRONT

U001	U002	U003	U004	U005	U006	U007	U008	U009	U010	U011	U012	U013	U014	U015	U016	U017	U018	U019	U020	U021
------	------	------	------	------	------	------	------	------	------	------	------	------	------	------	------	------	------	------	------	------

U013_S001
TRANSPORT UNIT:ASS'Y

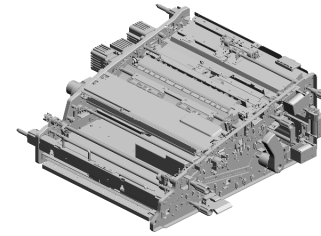

284.D1942612
[A]
TRANSPORT UNIT:
ASS'Y
201610-05 X/O

- 219.D0746338 (x2) PIN:LEVER:PRESSURE:TRANSFER ROLLER
- 215.D0746334 (x2) COIL SPRING:PRESSURE:TRANSFER ROLLER
- 203.D0743105 DC MOTOR:DIA35.8:24V:4.1W
- 205.D0743173 (x7) TIMING PULLEY:S2M:25T
- 206.D0744683 JOINT:EXIT:DRIVE

208.D0746238
JOINT:TRANSFER:DRIVE

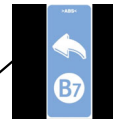

197.D0742988
DECAL:PULL OUT:RIGHT:B7

212.D0746324
GEAR:DRIVE:TRANSFER/SEPARATION UNIT

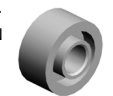

204.D0743171
TIMING ROLLER:TRANSFER:DRIVE:PRESS FIT

218.D0746337
LEVER:PRESSURE:T/S UNIT:REAR



220.D0746340 (x2)
LINK:HANDLE



222.D0746349
BRACKET:SHAFT:CONTACT POINT:TRANSFER ROLLER



217.D0746336 (x2)
CAM:TRANSFER/SEPARATION UNIT

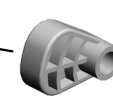

211.D0746243
DECAL:LEVER:TRANSFER/SEPARATION UNIT:REAR



221.D0746343
LINK:HANDLE:MIDDLE

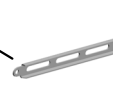

- 214.D0746333 SHAFT:LEVER:PRESSURE:TRANSFER ROLLER
- 209.D0746240 SHAFT:CONTACT POINT:T/S UNIT
- 216.D0746335 SHAFT:CAM:TRANSFER/SEPARATION UNIT
- 210.D0746242 DECAL:LEVER:TRANSFER/SEPARATION UNIT:FRONT
- 213.D0746330 LEVER:PRESSURE:T/S UNIT:FRONT



U013_S001
TRANSPORT UNIT:ASS'Y

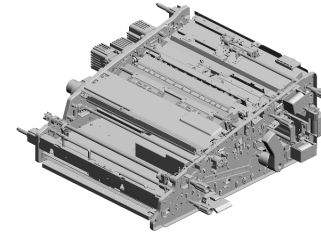

284.D1942612
[A]
TRANSPORT UNIT:
ASS'Y
201610-05 X/O

239.D1942985 GATE PAWL:PEEN
240.D1942988 SHAFT:GATE PAWL
223.D0746497 (x6) DECAL:POSITIONING DISPLAY:TCRU
246.G0602296 (x4) BALL BEARING:8X16X5MM
225.D1942669 GUIDE PLATE:CONNECTING:LARGE CAPACITY TRAY:UPPER



243.D1942999 (x3) DC STEPPER MOTOR:PAPER TRANSPORT MD:MM42:ASS'Y

235.D1942968 BRACKET:LOCK

230.D1942945 HOLDER:CAM:SHIFT

236.D1942969 COVER:TIMING:TRANSFER

232.D1942960 GUIDE PLATE:REGISTRATION:PEEN

224.D1366381 INSULATING SHEET:PULL OUT

229.D1942883 TRANSPORT ROLLER:DUPLIX:RIGHT:NO.2:PRESS FIT

233.D1942964 SHEET:BASE:COVER

244.D1945480 PCB:CRB

248.G1073834 (x4) RIVET - 2.0

247.G0603293 (x4) SPACER:6.1X8.5X0.5

242.D1942995 BRACKET:BEARING:GUIDE:REAR

228.D1942880 TRANSPORT ROLLER:VERTICAL TRANSPORT:RIGHT:ENTRANCE:PRESS FIT

245.D1945538 PCB:DRB 201602-02 X/O

241.D1942989 PLATE:ADJUSTING PIN:GATE

U013_S001
TRANSPORT UNIT:ASS'Y

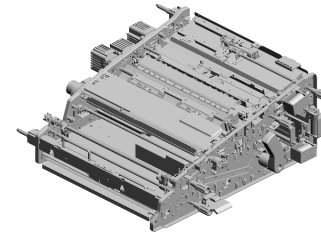

284.D1942612
[A]
TRANSPORT UNIT:
ASS'Y
201610-05 X/O

256.G1784900 (x2) COVER:DC STEPPER MOTOR:MM56
257.G1784912 PULLEY:S2M:30T
264.G1787660 (x2) PRESSURE ROLLER:TRANSPORT ROLLER
265.G1787664 (x4) SPACER
274.M0774862 (x2) TRANSPORT ROLLER:DRIVEN:DUPLICATE:DIA18X2

266.G1787694 (x3) COVER:DC STEPPER MOTOR:MM42

270.G1787781 GEAR:PULLEY

254.G1784818 (x2) SPRING:PULL OUT LOCK:EXIT

251.D1944759 BRACKET:LOCK:EXIT
201612-05 X/O

272.GW010007 (x8) PHOTO REFLECTION SENSOR:EXIT

269.G1787744 BOSS:POSITIONING PIN:TRANSPORT UNIT:NO.2

262.G1787618 PLATE:FIX:BAND

253.G1784817 (x4) SPRING:PRESSURE:ROLLER:DUPLICATE

263.G1787633 HOOK:GUIDE PLATE:DUPLICATE:ASS'Y

252.G1784808 (x2) BRACKET:PRESSURE:ROLLER

260.G1787453 (x3) ARM:ON-OFF:TRANSPORT ROLLER

268.G1787743 BOSS:POSITIONING PIN:TRANSPORT UNIT:NO.1

259.G1787392 DISC:SENSOR:CAM

273.GX640028 FAN MOTOR DC24V 1.92W

258.G1786352 GUIDE PLATE:ENCODER

U013_S001
TRANSPORT UNIT:ASS'Y

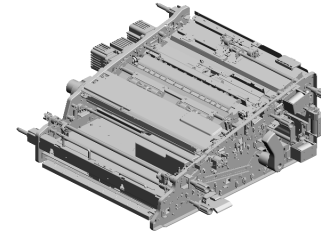

284.D1942612
[A]
TRANSPORT UNIT:
ASS'Y
201610-05 X/O

293.AA043726 SYNCHRONOUS B
ELT:60S2M134
202010-01 O/O

295.M0EB4671 (x2)
RADIAL BALL BEA
RING:REGISTRATI
ON:DRIVEN:REAR
202301-01 O/O

285.D0A52815 BRACKET:CONTA
CT POINT:GUIDE P
LATE:REAR:PEEN
201710-03 O/O

280.D1942855 SHEET:SEPARATI
ON PLATE:CONTA
CT IMAGE SENSO
R:DUCT
201506-06

290.D0A52940 HOLDER:ELECTRI
CAL COMPONENT
S SECTION:ASS'Y

292.AA043727 SYNCHRONOUS B
ELT:80S2M190
202006-05 O/O

296.D0BX2679 HOLDER:DC STEP
PER MOTOR:SHIF
T
202302-03 O/O

289.AA043731 TIMING BELT:40S2
M184
201805-03 O/O

278.D1942853 SHEET:OPPOSED:
CONTACT IMAGE
SENSOR:DUCT:LE
FT
201506-04

283.D1949903 SHEET:CIS:KIT
202105-08

281.D1942977 SEPARATION PLA
TE:CONTACT IMA
GE SENSOR:DUCT
201506-07

291.AA043733 TIMING BELT:40S2
M224
201905-07 O/O

277.D1942852 SHEET:OPPOSED:
CONTACT IMAGE
SENSOR:STAY
201506-03

286.D1941496 ENCODER:ASS'Y
201710-07 O/O

288.AA066428 TORSION SPRING:
GUIDE PLATE:FRO
NT
201804-02 O/O

287.D1942990 (x2)
TENSION SPRING:
PRESSURE:TIMIN
G ROLLER:REGIST
RATION
201710-18 X/O

294.M0EB4670 (x2)
RADIAL BALL BEA
RING:REGISTRATI
ON:DRIVEN:FRON
T
202301-02 O/O

282.D1942841 SEPARATION PLA
TE:CONTACT IMA
GE SENSOR:DUCT
201507-07

279.D1942854 SHEET:OPPOSED:
CONTACT IMAGE
SENSOR:DUCT
201506-05



D1942610
[A]
TRANSPORT UNIT:
ASS'Y
201610-05 X/O

U013_S001_S001
CONTACT IMAGE SENSOR:ASS'Y



226.D1942681
CONTACT IMAGE
SENSOR:ASS'Y

5.03603006N(x 2)
SCREW - M3X6

U001	U002	U003	U004	U005	U006	U007	U008	U009	U010	U011	U012	U013	U014	U015	U016	U017	U018	U019	U020	U021
------	------	------	------	------	------	------	------	------	------	------	------	------	------	------	------	------	------	------	------	------

U013_S001_S002
SWING UNIT:ASS'Y

68.AA082104 (x4) BUSHING - 8X12X7
 20.07200040E (x4) RETAINING RING - M4
 55.AA061078 (x2) TENSION SPRING: PRESSURE ROLLER
 145.D0742760 TRANSPORT ROLLER:SHIFT:DRIVE:PRESS FIT
 133.D0742732 GUIDE PLATE:SHIFT:UPPER:PEEN



227.D1942704
 [A]
 SWING UNIT:ASS'Y
 201507-03 X/O

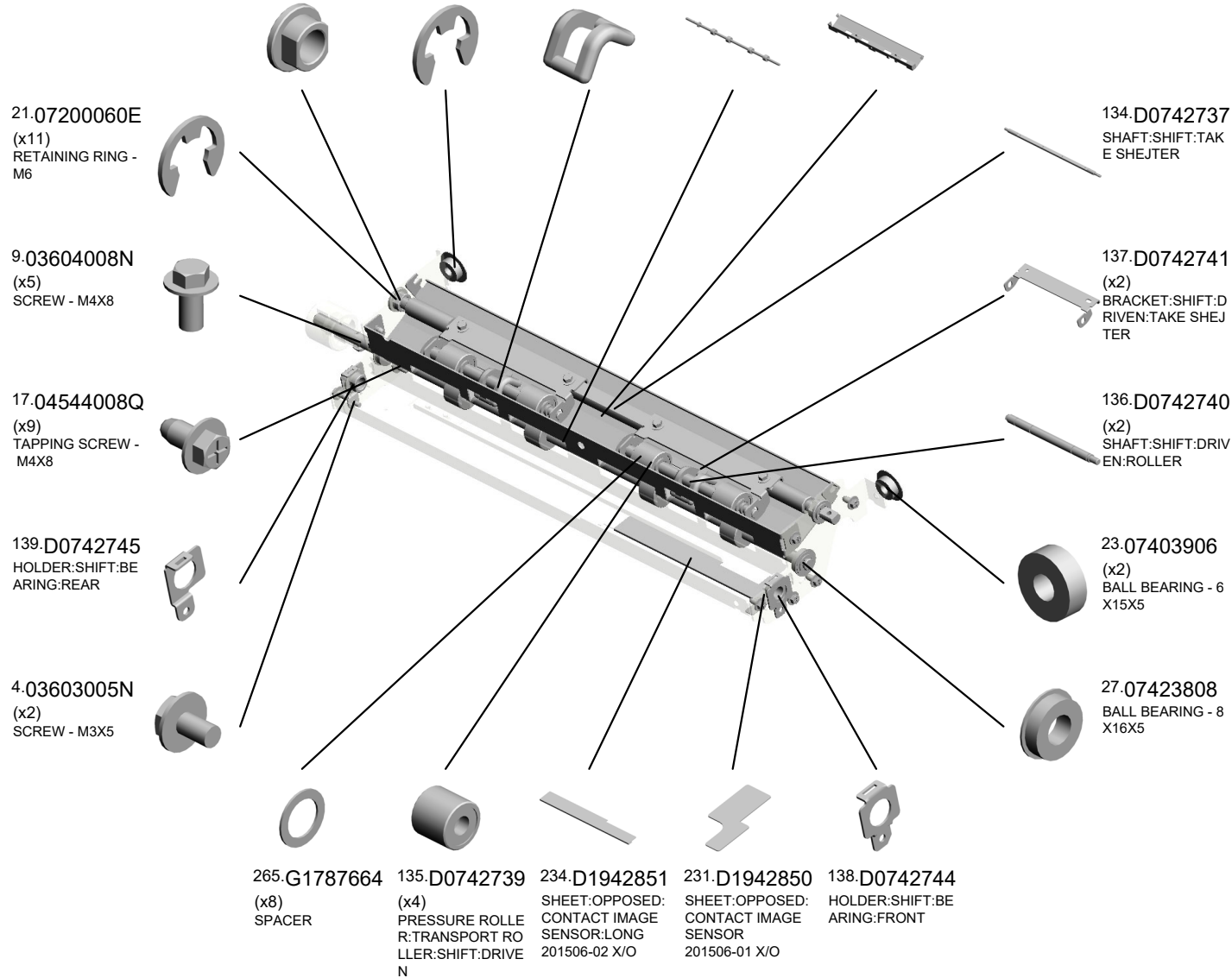

U001	U002	U003	U004	U005	U006	U007	U008	U009	U010	U011	U012	U013	U014	U015	U016	U017	U018	U019	U020	U021
------	------	------	------	------	------	------	------	------	------	------	------	------	------	------	------	------	------	------	------	------

U013_S001_S002
SWING UNIT:ASS'Y

267.G1787717
GEAR:SHIFT:ROLL
ER



227.D1942704
[A]
SWING UNIT:ASS'Y
201507-03 X/O



D1942703
[A]
SWING UNIT:ASS'Y
201507-03 X/O

U001	U002	U003	U004	U005	U006	U007	U008	U009	U010	U011	U012	U013	U014	U015	U016	U017	U018	U019	U020	U021
------	------	------	------	------	------	------	------	------	------	------	------	------	------	------	------	------	------	------	------	------

U013_S001_S003
LEVER:GUIDE PLATE

198.D0742990
DECAL:PULL OUT:
RIGHT:Z4

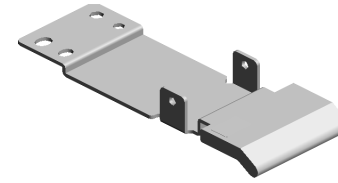

196.D0742979
LEVER:GUIDE PLATE

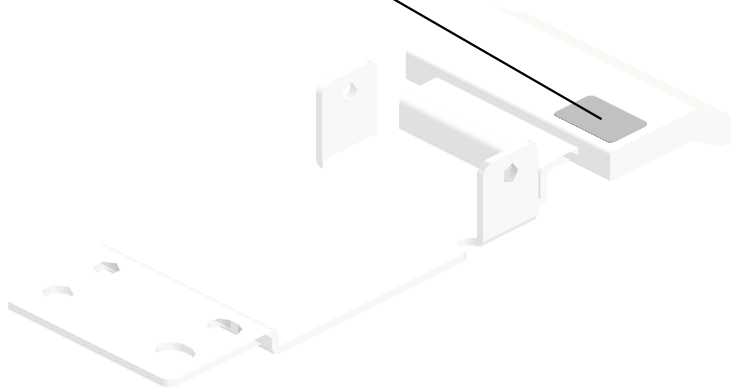

U001	U002	U003	U004	U005	U006	U007	U008	U009	U010	U011	U012	U013	U014	U015	U016	U017	U018	U019	U020	U021
------	------	------	------	------	------	------	------	------	------	------	------	------	------	------	------	------	------	------	------	------

U013_S001_S004
CASE:TERMINAL:SEPARATION:ASS'Y

15.04523008N
TAPPING SCREW -
M3X8

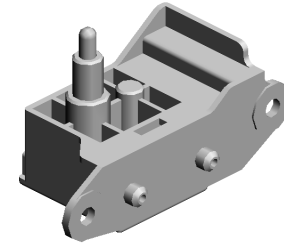

207.D0746230
CASE:TERMINAL:SEPARATION:ASS'Y

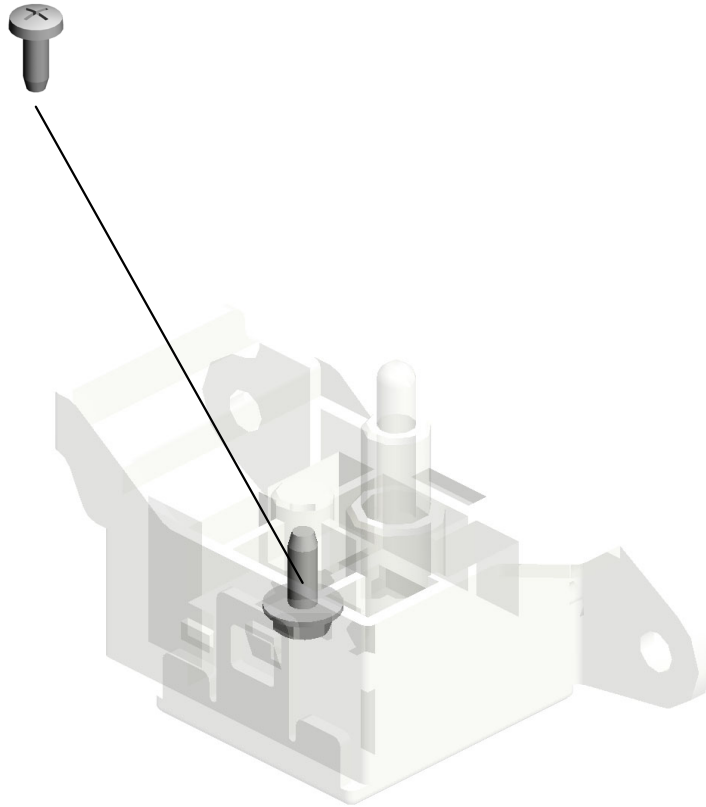

U001	U002	U003	U004	U005	U006	U007	U008	U009	U010	U011	U012	U013	U014	U015	U016	U017	U018	U019	U020	U021
------	------	------	------	------	------	------	------	------	------	------	------	------	------	------	------	------	------	------	------	------

U014.SEPARATION/PAPER TRANSPORT

U014 S001
D1943852
TRANSPORT BELT UNIT:ASS
Y

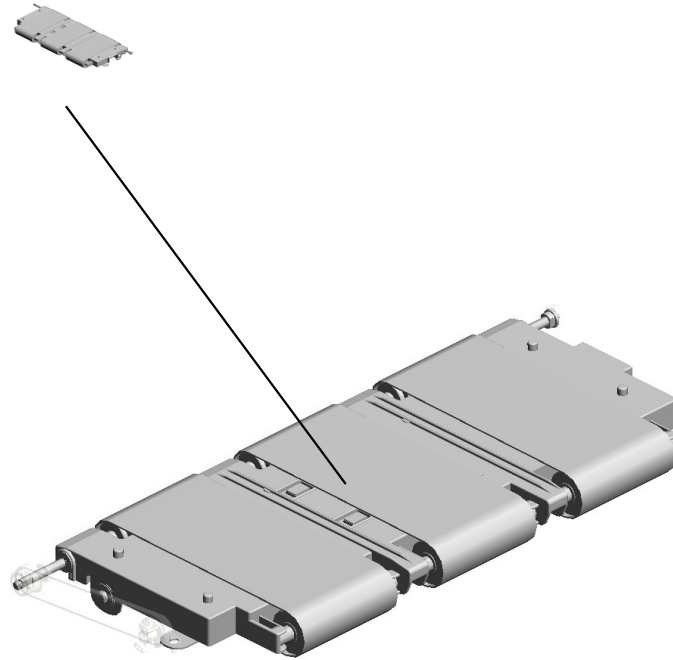

U001	U002	U003	U004	U005	U006	U007	U008	U009	U010	U011	U012	U013	U014	U015	U016	U017	U018	U019	U020	U021
------	------	------	------	------	------	------	------	------	------	------	------	------	------	------	------	------	------	------	------	------

U014 SEPARATION/PAPER TRANSPORT

15.B7031166
TIMING BELT:B40S
2M274:

16.D0741394
PULLEY:DRIVE:TR
ANSPORT UNIT

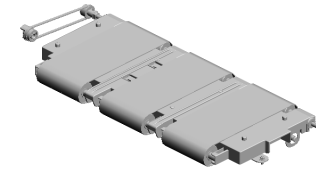

18.D0743858
PULLEY:DRIVE:VA
CUUM

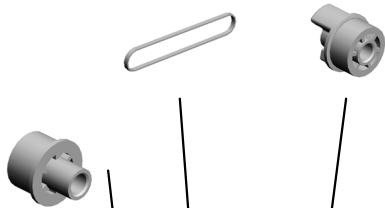

10.54472681
SNAP RING



9.11050723
CLAMPS:WES-050
7

3.04514008N
(x2)
TAPPING SCREW:
4X8



4.07200040E (x 1)
RETAINING RING - M4

12.AA082173
(x2)
PLAIN SHAFT BEA
RING:6X10X6



U001	U002	U003	U004	U005	U006	U007	U008	U009	U010	U011	U012	U013	U014	U015	U016	U017	U018	U019	U020	U021
------	------	------	------	------	------	------	------	------	------	------	------	------	------	------	------	------	------	------	------	------

U014_S001 TRANSPORT BELT UNIT:ASS'Y

- 23.GA143003 (x7) SCREW:MM5:2.5M
- 1.03603006N (x2) SCREW - M3X6
- 22.D1946229 (x2) GROUND PLATE:VACUUM:SENSOR:SRING PLATE
- 14.AX640207 (x3) FAN:MM60 201503-01 X/O

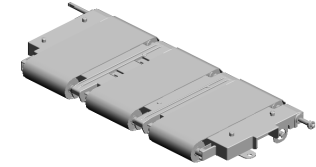

- 21.D1943852 [A] TRANSPORT BELT UNIT:ASS'Y 201601-01 X/O

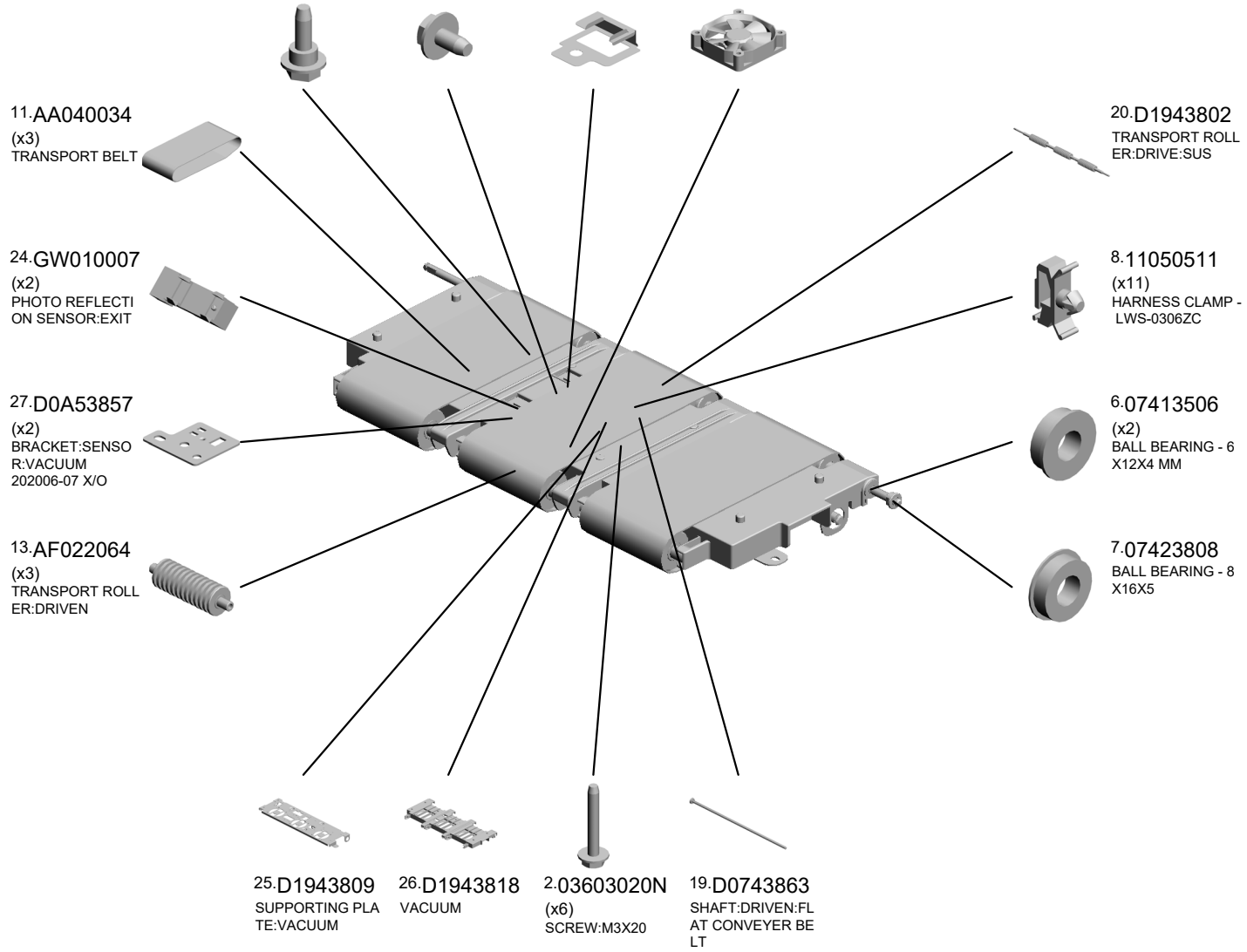

- D1943851 [A] TRANSPORT BELT UNIT:ASS'Y 201601-01 X/O

U001	U002	U003	U004	U005	U006	U007	U008	U009	U010	U011	U012	U013	U014	U015	U016	U017	U018	U019	U020	U021
------	------	------	------	------	------	------	------	------	------	------	------	------	------	------	------	------	------	------	------	------

U015.FUSING

U015 S006
D1944327
ROLLER:POLISH:ASS'Y

U015 S001
D1944031
(-AA,-EU,-CHN):FUSING UNIT
:230V:ASS'Y

U015 S002
D1944031
(-AA,-EU,-CHN):FUSING UNIT
:230V:ASS'Y

U015 S003
D1944031
(-AA,-EU,-CHN):FUSING UNIT
:230V:ASS'Y

U015 S004
D1944021
(-NA):FUSING UNIT:208V:AS
S'Y

U015 S005
D1944340
WEB:CLEANING UNIT:ASS'Y

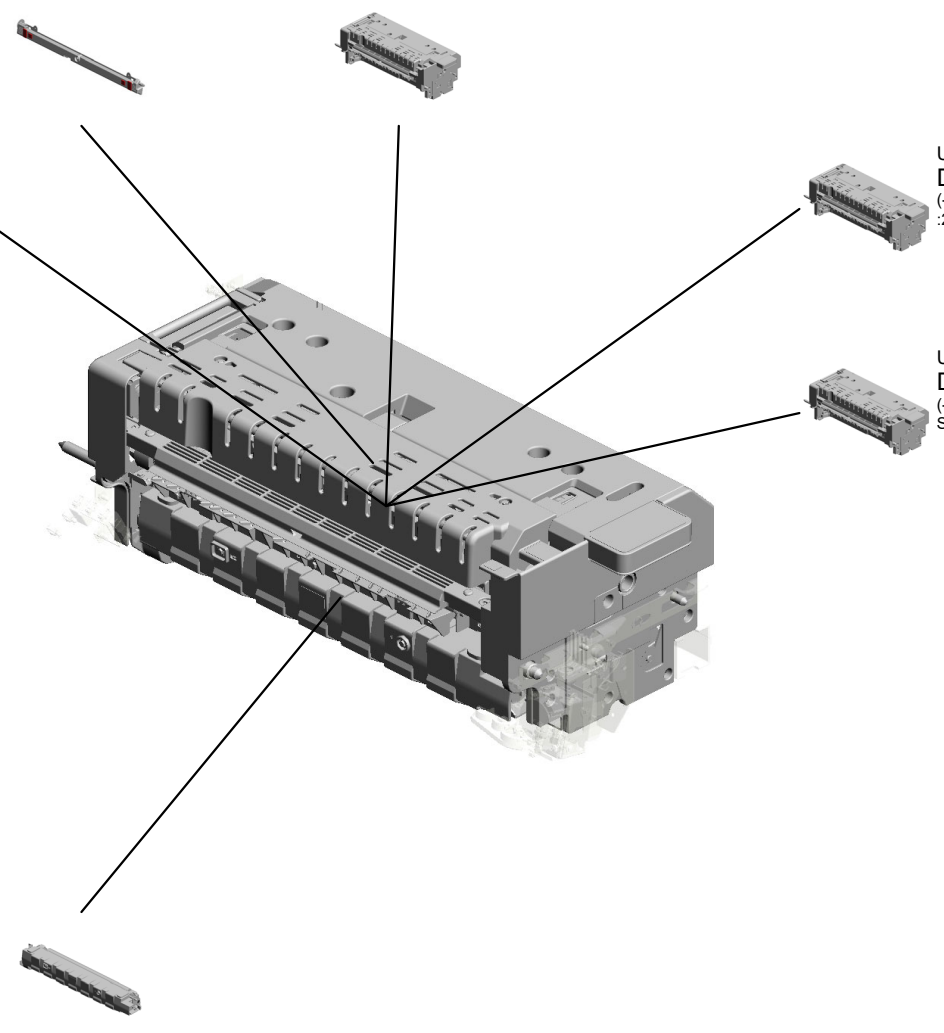

U001	U002	U003	U004	U005	U006	U007	U008	U009	U010	U011	U012	U013	U014	U015	U016	U017	U018	U019	U020	U021
------	------	------	------	------	------	------	------	------	------	------	------	------	------	------	------	------	------	------	------	------

U015_S001.(-AA,-EU,-CHN):FUSING UNIT:230V:ASS'Y

U015 S001 S002
D1944066
GUIDE PLATE:FUSING EXIT:
LOWER:NO.2:ASS'Y

U015 S001 S001
D1944190
FUSING COVER:UPPER:SUB
-ASS'Y

U015 S001 S003
D1944074
PRESSURE SUB-UNIT:STRIP
PER PLATE:ASS'Y

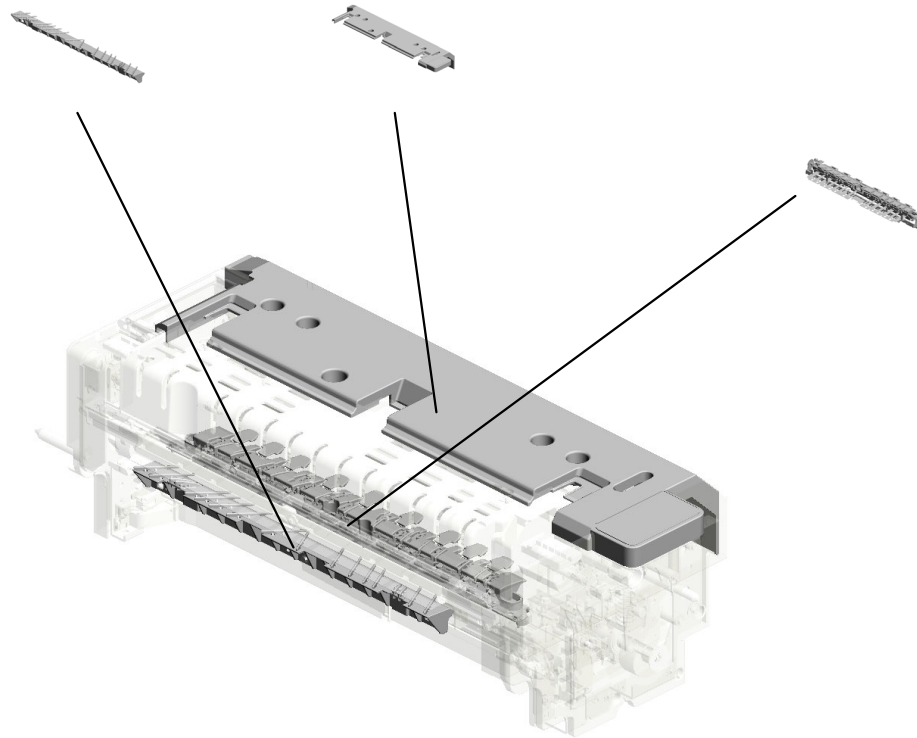

U001	U002	U003	U004	U005	U006	U007	U008	U009	U010	U011	U012	U013	U014	U015	U016	U017	U018	U019	U020	U021
------	------	------	------	------	------	------	------	------	------	------	------	------	------	------	------	------	------	------	------	------

U015_S002.(-AA,-EU,-CHN):FUSING UNIT:230V:ASS'Y

U015 S002 S002
D1944066
GUIDE PLATE:FUSING EXIT:
LOWER:NO.2:ASS'Y

U015 S002 S001
D1944190
FUSING COVER:UPPER:SUB
-ASS'Y

U015 S002 S003
D1944074
PRESSURE SUB-UNIT:STRIP
PER PLATE:ASS'Y

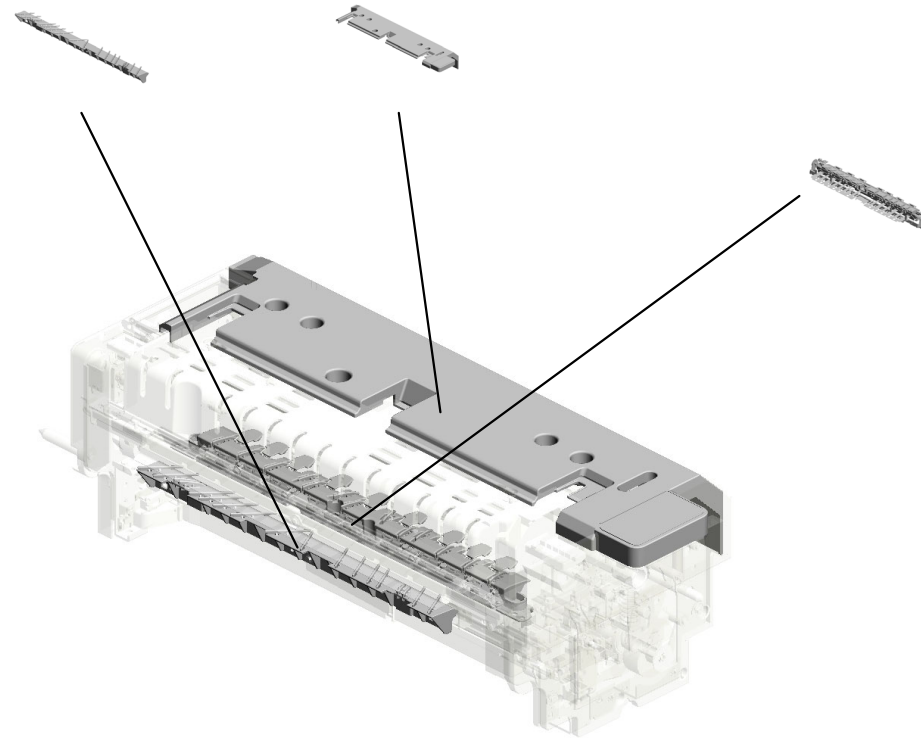

U001	U002	U003	U004	U005	U006	U007	U008	U009	U010	U011	U012	U013	U014	U015	U016	U017	U018	U019	U020	U021
------	------	------	------	------	------	------	------	------	------	------	------	------	------	------	------	------	------	------	------	------

U015_S003.(-AA,-EU,-CHN):FUSING UNIT:230V:ASS'Y

U015 S003 S002
D1944066
GUIDE PLATE:FUSING EXIT:
LOWER:NO.2:ASS'Y

U015 S003 S001
D1944190
FUSING COVER:UPPER:SUB
-ASS'Y

U015 S003 S003
D1944074
PRESSURE SUB-UNIT:STRIP
PER PLATE:ASS'Y

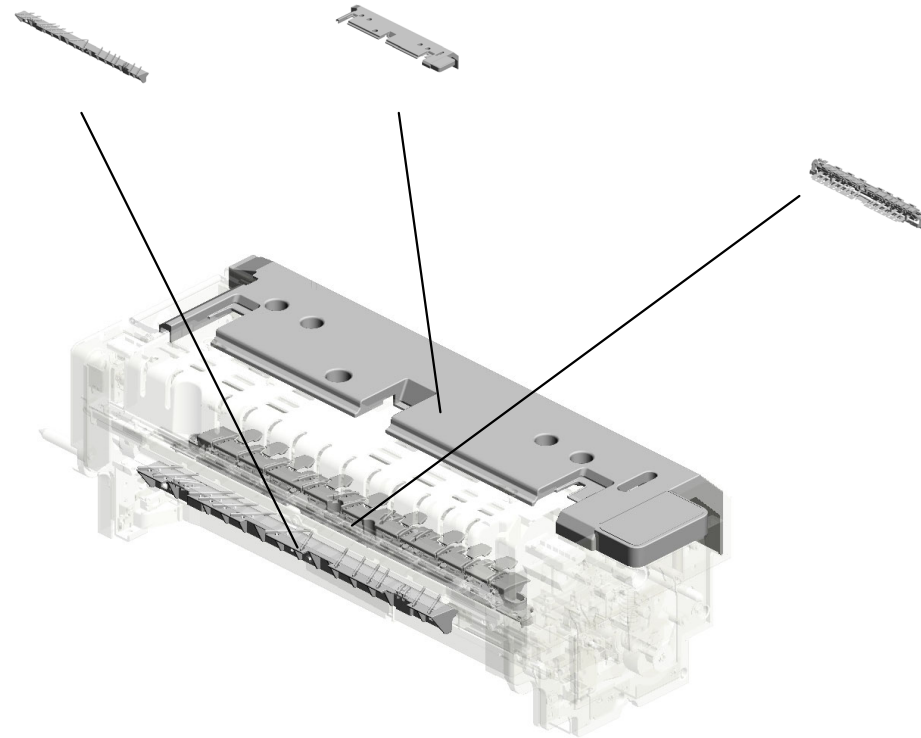

U001	U002	U003	U004	U005	U006	U007	U008	U009	U010	U011	U012	U013	U014	U015	U016	U017	U018	U019	U020	U021
------	------	------	------	------	------	------	------	------	------	------	------	------	------	------	------	------	------	------	------	------

U015_S004.(-NA):FUSING UNIT:208V:ASS'Y

U015 S004 S002
D1944066
GUIDE PLATE:FUSING EXIT:
LOWER:NO.2:ASS'Y

U015 S004 S001
D1944190
FUSING COVER:UPPER:SUB
-ASS'Y

U015 S004 S003
D1944074
PRESSURE SUB-UNIT:STRIP
PER PLATE:ASS'Y

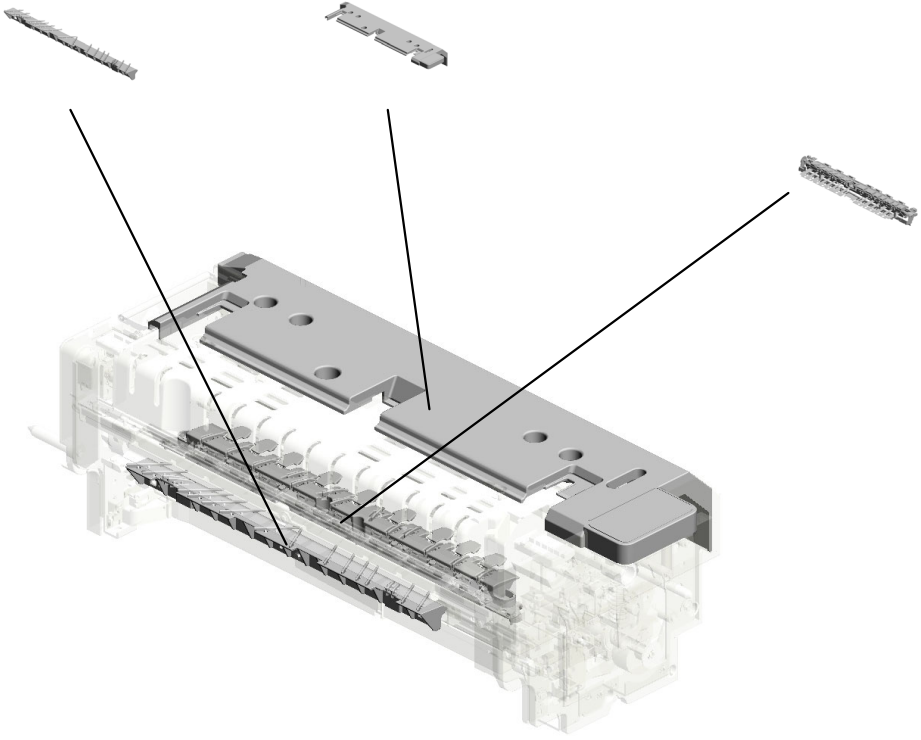

U001	U002	U003	U004	U005	U006	U007	U008	U009	U010	U011	U012	U013	U014	U015	U016	U017	U018	U019	U020	U021
------	------	------	------	------	------	------	------	------	------	------	------	------	------	------	------	------	------	------	------	------

U015_S005.WEB:CLEANING UNIT:ASS'Y

U015 S005 S001
D0744325
COVER:WEB:CLEANING FEL
T

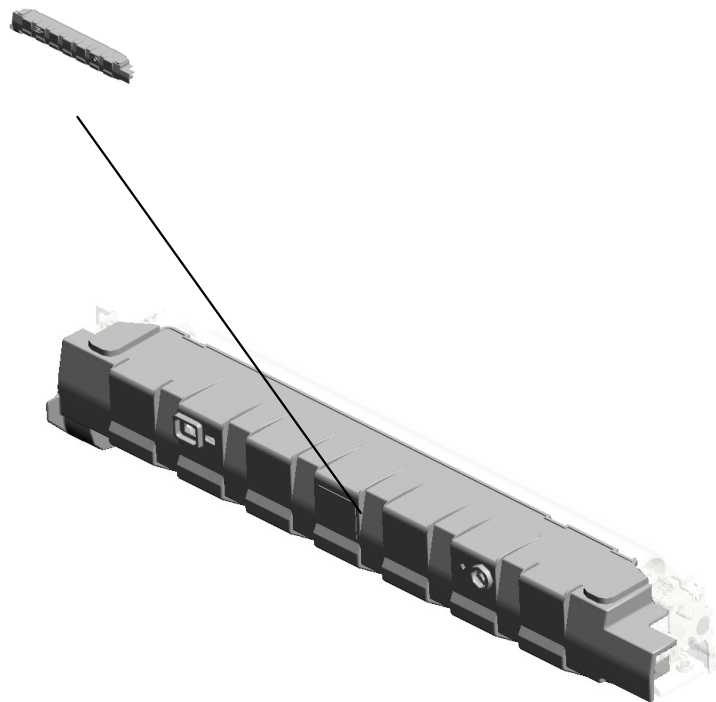

U001	U002	U003	U004	U005	U006	U007	U008	U009	U010	U011	U012	U013	U014	U015	U016	U017	U018	U019	U020	U021
------	------	------	------	------	------	------	------	------	------	------	------	------	------	------	------	------	------	------	------	------

U015 FUSING

38.AA063463 (x4) COMPRESSION SPRING: DRAWER
 19.08046123 (x3) HEXAGONAL BOLT: W/WASHER: M3X8
 167.D0744350 BRACKET: DRAWER: FUSING SECTION: 24
 83.AW020198 PHOTO INTERRUPTOR: LG2A14NL1
 11.07200060E (x2) RETAINING RING - M6

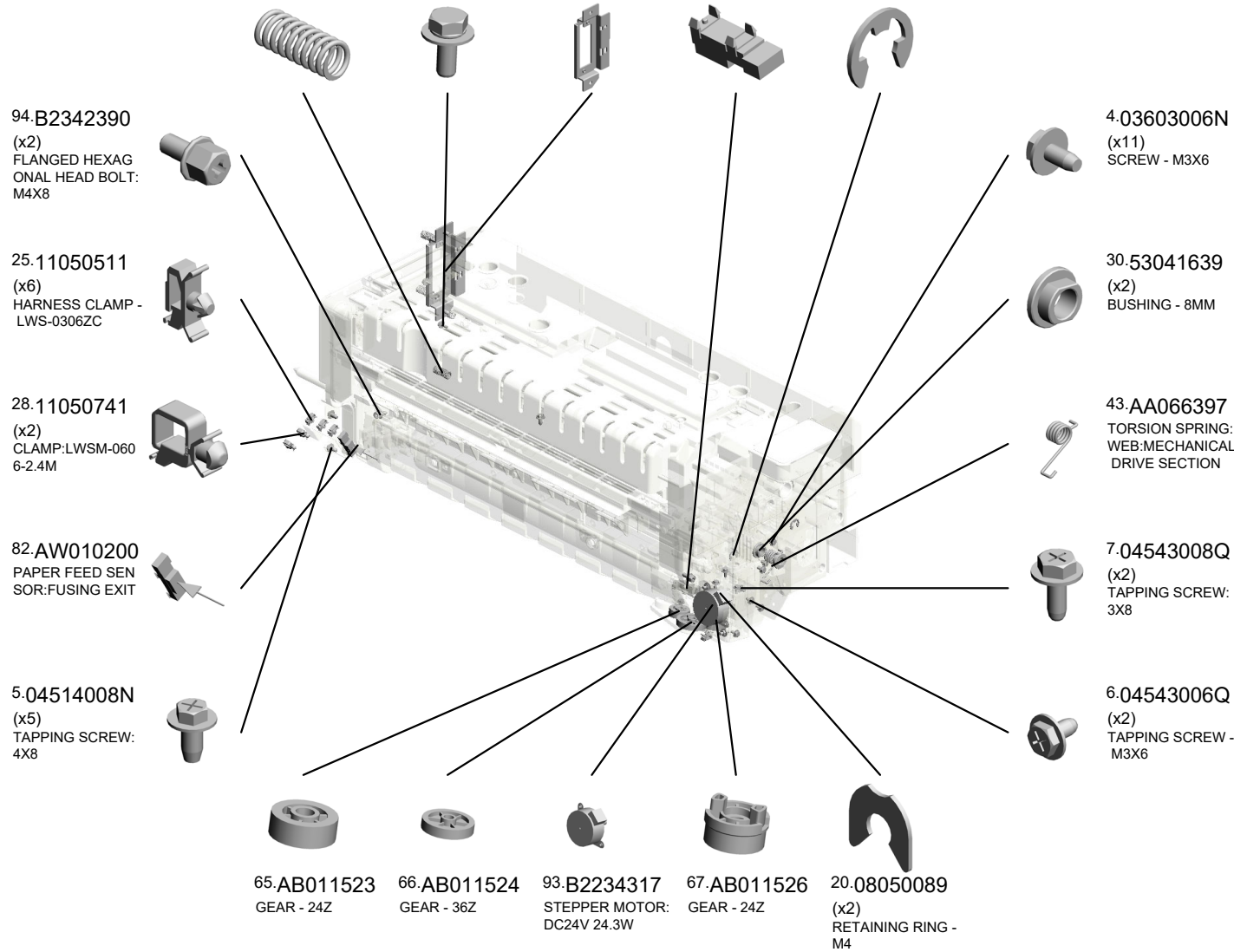
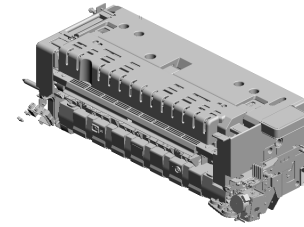

U015 FUSING

168.D0744351 (x4) STEPPED SCREW: DIA5.4DIA:DIA3.5:M 3
 275.M0EB4398 DUCT:PRESSURE: CONNECTING:A 202311-02 O/O
 179.D0744399 DUCT:PRESSURE: CONNECTING:B

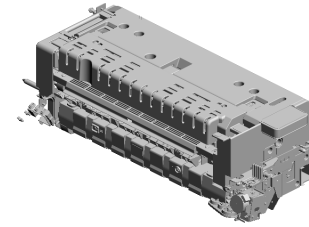

175.D0744372
 BRACKET:WEB:PH
 OTOINTERRUPTO
 R:MAIN



169.D0744352
 JOINT:GEAR:WEB:
 DRIVE

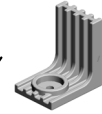
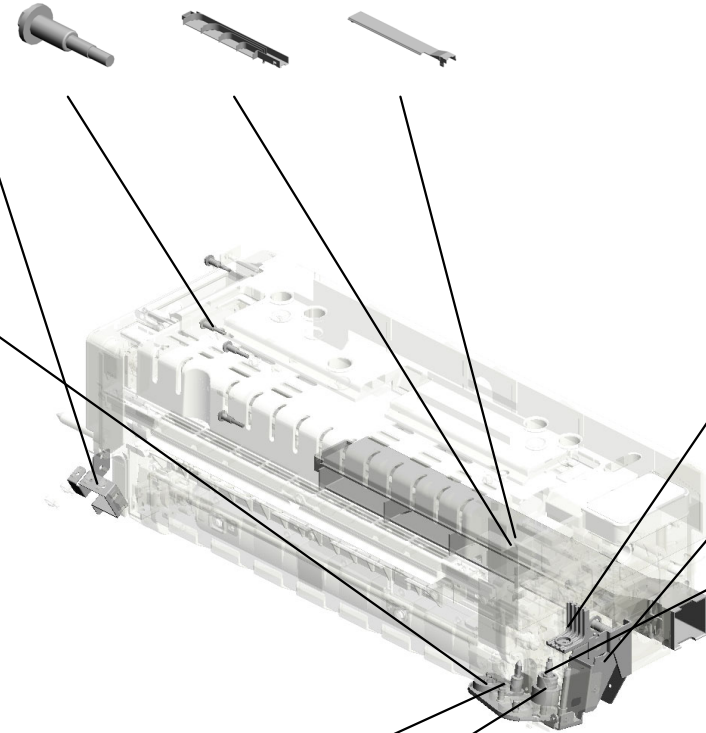

174.D0744371
 GRIP:SLIDER:FUSI
 NG



173.D0744364
 BRACKET:WEB:CL
 EANING



172.D0744356
 BRACKET:LEVER:
 WEB:DRIVE SUB-U
 NIT



170.D0744353
 COVER:GEAR:JOI
 NT



171.D0744354
 GEAR:SLOW DOW
 N:WORM GEAR

U015_S001
 (-AA,-EU,-CHN):FUSING UNIT:230V:ASS'Y

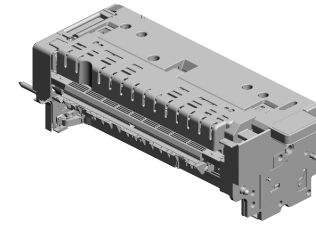

250.D1944031
 [A]
 (-AA,-EU,-CHN):FU
 SING UNIT:230V:A
 SS'Y
 201609-01 O/O

- 10.07200040E (x18) RETAINING RING - M4
- 18.07433906 RADIAL BALL BEARING: DIA6X DIA15X5
- 27.11050723 CLAMPS: WES-050 7
- 29.11050744 (x3) CLAMP: F-LWS-071 1
- 22.09543010N (x2) SCREW: POLISHED ROUND/SPRING: M3X10

15.07403706
 BALL BEARING - M6X10X3

11.07200060E
 (x15)
 RETAINING RING - M6

9.07200030E
 (x4)
 RETAINING RING - M3

14.07250250E
 (x2)
 RETAINING RING C - M25

19.08046123
 (x63)
 HEXAGONAL BOLT :W/WASHER: M3X8

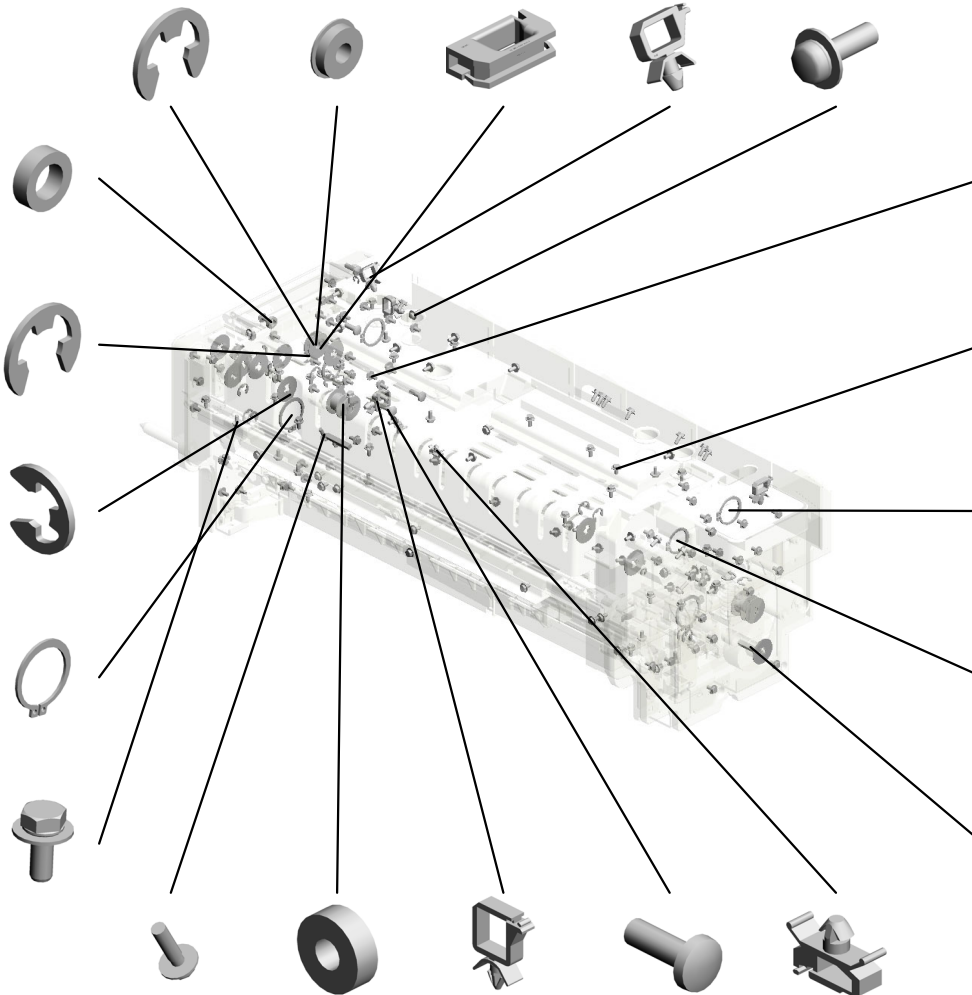

4.03603006N
 (x87)
 SCREW - M3X6

3.03603005P
 (x2)
 SCREW: M3X5

13.07250220E
 (x2)
 RETAINING RING - M22

12.07250200E
 (x2)
 RETAINING RING C - M20

21.09300404A
 (x2)
 PARALLEL KEY: 4X4X25

23.09543012N
 SCREW - M3X12

16.07403906
 (x4)
 BALL BEARING - 6X15X5

24.11050488
 HARNESS CLAMP

2.03540120N
 (x4)
 SCREW M4X12

26.11050713
 (x3)
 CLAMP: LWSM-030 6H GRAY

U015_S001
 (-AA,-EU,-CHN):FUSING UNIT:230V:ASS'Y

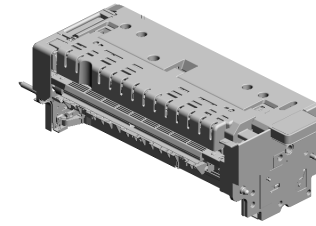

250.D1944031
 [A]
 (-AA,-EU,-CHN):FU
 SING UNIT:230V:A
 SS'Y
 201609-01 O/O

- 54.AA082101 (x4) BUSHING - 6X10X6
- 42.AA064004 (x2) COMPRESSION SP RING:PRESSURE:3 75N
- 46.AA066687 TORSION SPRING: LOCK:SEPARATIO N:REAR:15N
- 55.AA113037 (x2) TERMINAL:4P:187 STEPPED SCREW: DIA5:3.5:M3
- 57.AA143847 (x2) STEPPED SCREW: DIA5:3.5:M3

49.AA066691
 TORSION SPRING:
 GRIP

35.AA061164
 TENSION SPRING:
 GEAR:ON-OFF

50.AA080247
 (x2)
 BUSHING - B-F6-3

40.AA063484
 COMPRESSION SP
 RING:ROLLER:POL
 ISH:REAR

48.AA066690
 TORSION SPRING:
 DUCT:REAR

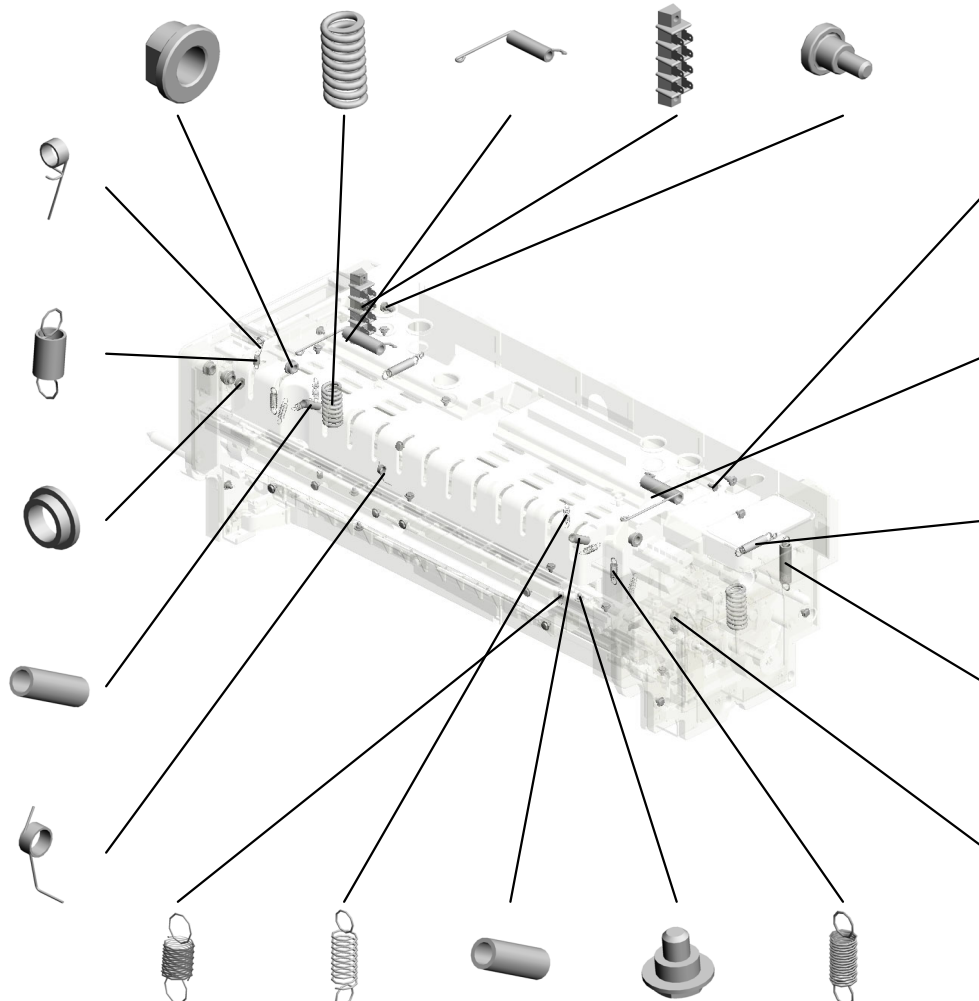

31.58942540
 ARM SCREW

45.AA066686
 TORSION SPRING:
 LOCK:SEPARATIO
 N:FRONT:15N

37.AA062352
 (x2)
 TENSION SPRING:
 HEAT ROLLER

36.AA061199
 TENSION SPRING:
 LEVER:PRESSURE
 :30N

47.AA066689
 TORSION SPRING:
 DUCT:FRONT

32.AA061115
 (x2)
 TENSION SPRING:
 0.4N

33.AA061116
 (x6)
 TENSION SPRING:
 STRIPPER PLATE:
 2N

41.AA063724
 COMPRESSION SP
 RING:ROLLER:POL
 ISH

56.AA143520
 (x24)
 SHOULDER SCRE
 W - M3

34.AA061117
 (x2)
 TENSION SPRING:
 STRIPPER PLATE:
 PLATE

U015_S001
 (-AA,-EU,-CHN):FUSING UNIT:230V:ASS'Y

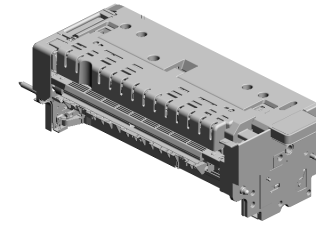

250.D1944031
 [A]
 (-AA,-EU,-CHN):FU
 SING UNIT:230V:A
 SS'Y
 201609-01 O/O

- 58.AA143885 (x2) STEPPED SCREW: M3
- 68.AB012203 GEAR:DRIVE:ROLL ER:FUSING:B
- 81.AW010147 PHOTO REFLECTI ON SENSOR
- 73.AE010122 **HOT ROLLER: DIA5 4**
- 74.AE012044 HEAT ROLLER: DIA 40

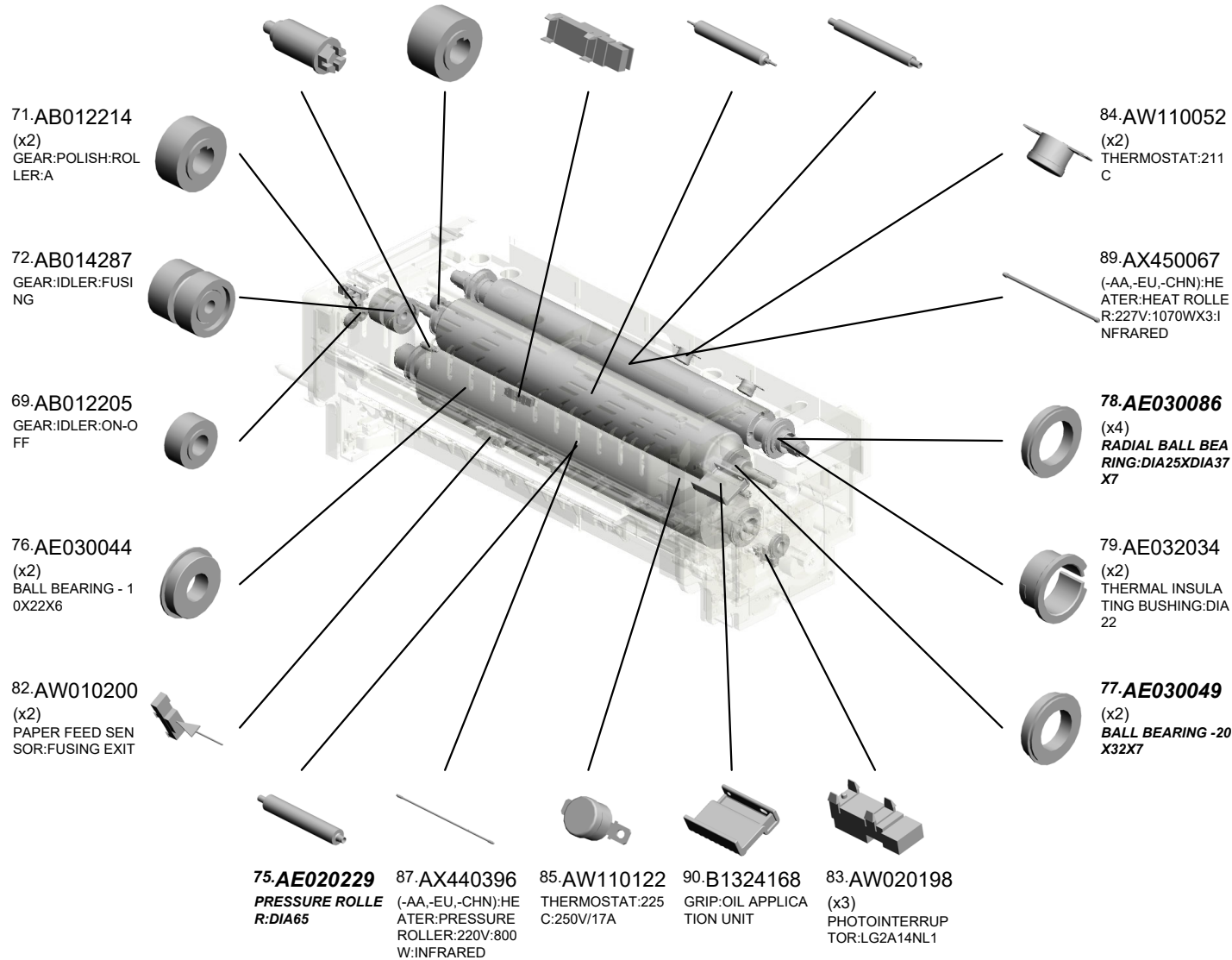

U001	U002	U003	U004	U005	U006	U007	U008	U009	U010	U011	U012	U013	U014	U015	U016	U017	U018	U019	U020	U021
------	------	------	------	------	------	------	------	------	------	------	------	------	------	------	------	------	------	------	------	------

U015_S001
 (-AA,-EU,-CHN):FUSING UNIT:230V:ASS'Y

- 91.B1324197 TORSION SPRING: LEVER (x6)
- 95.B8722614 BUSHING:R1 (x6)
- 100.BB013038 GEAR:HOT ROLLER:ASS'Y
- 92.B1324313 (x2) PRESSURE SPRING HOLDER
- 105.D0744009 (x4) HOLDER:M5

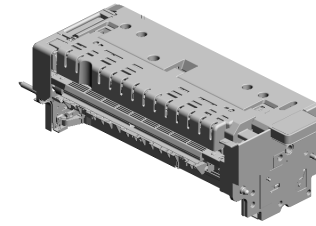

250.D1944031
 [A]
 (-AA,-EU,-CHN):FUSING UNIT:230V:ASS'Y
 201609-01 O/O

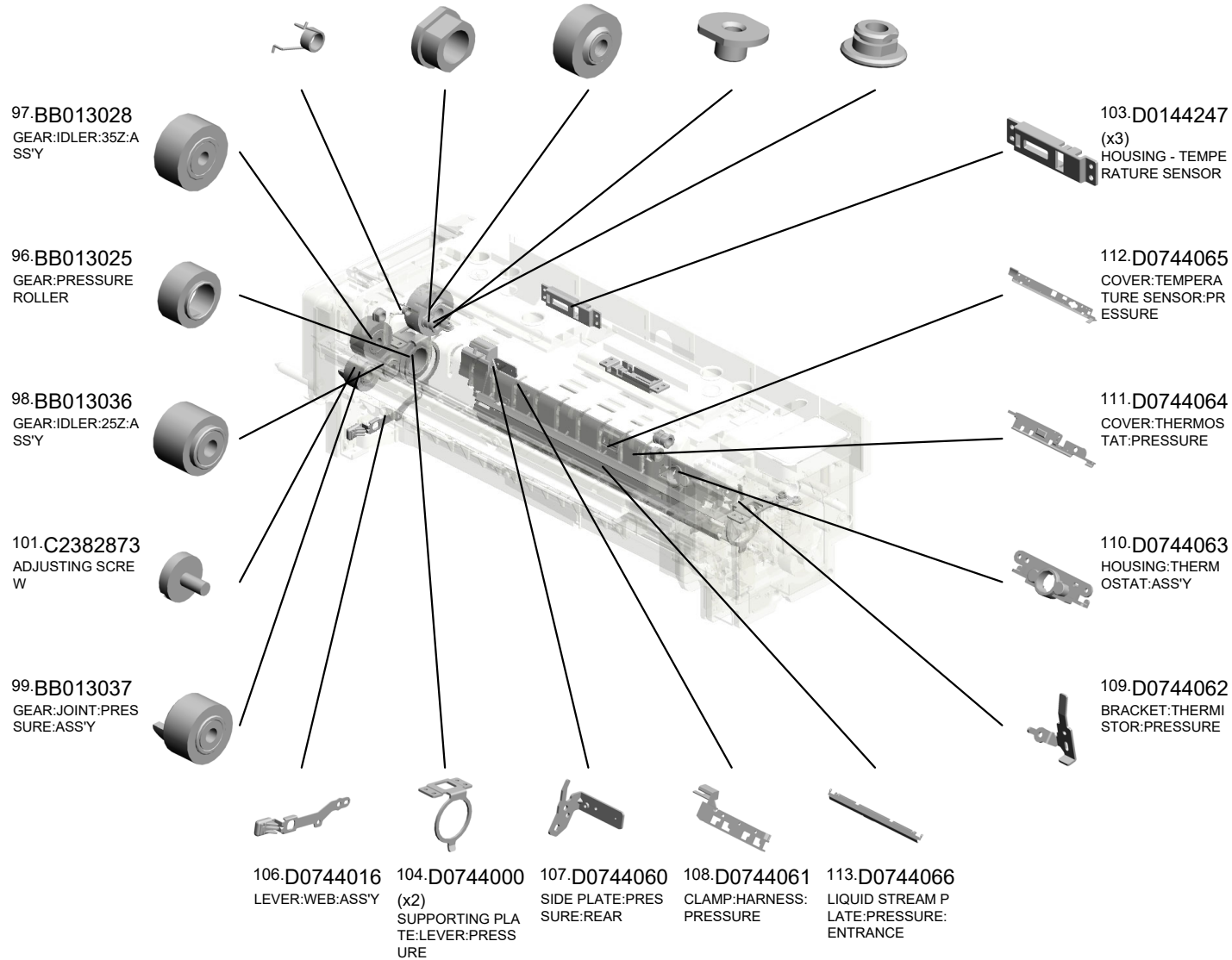

U015_S001
 (-AA,-EU,-CHN):FUSING UNIT:230V:ASS'Y

124.D0744100 COVER:BASE:ID
 122.D0744098 COVER:TERMINAL:CONNECTING
 120.D0744096 TERMINAL:CONNECTING
 123.D0744099 COVER:HARNESS:FIRST:LOWER
 121.D0744097 TAB:TERMINAL:CONNECTING

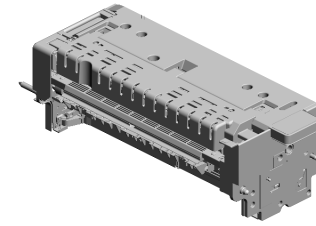

250.D1944031
 [A]
 (-AA,-EU,-CHN):FUSING UNIT:230V:ASS'Y
 201609-01 O/O

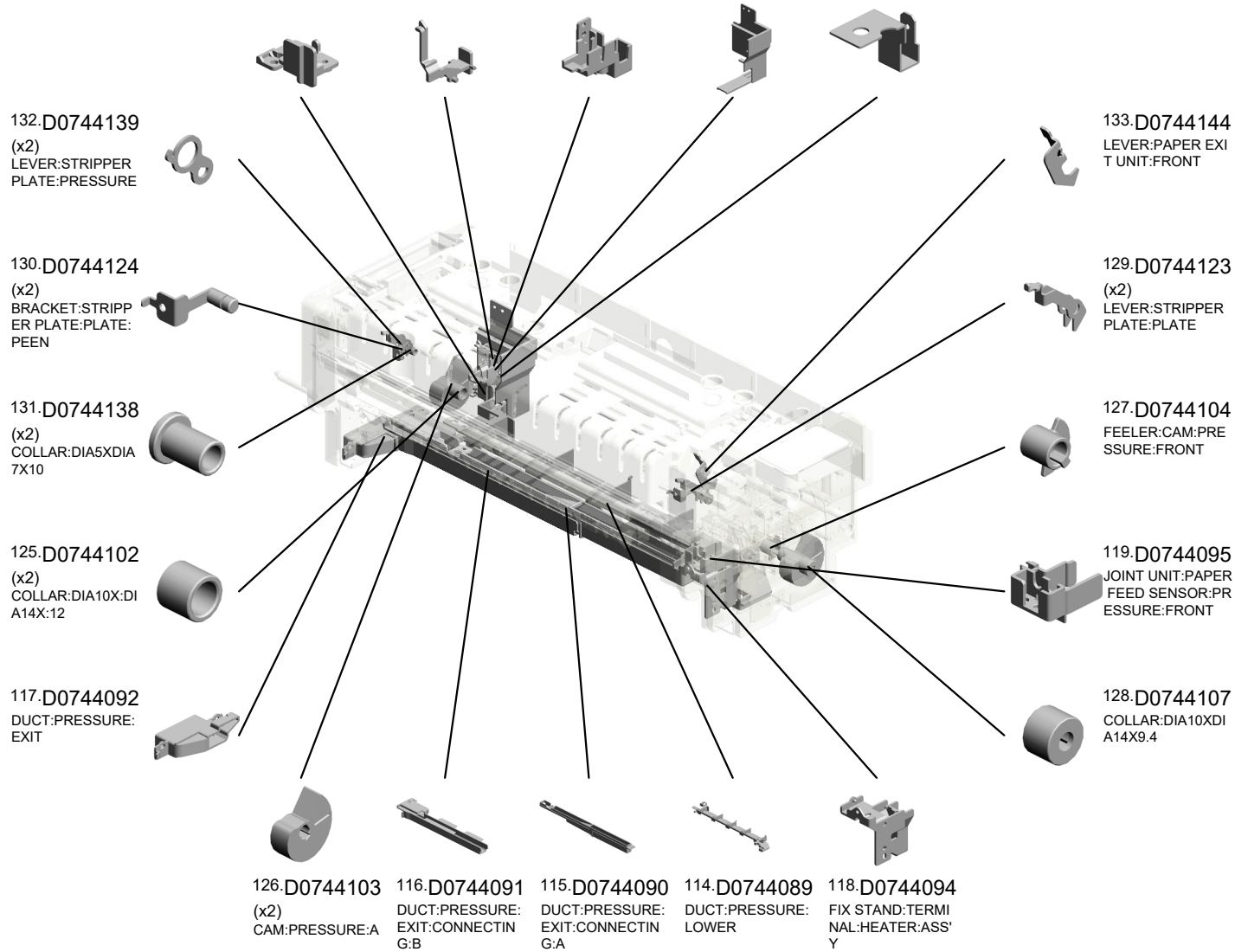

U015_S001
 (-AA,-EU,-CHN):FUSING UNIT:230V:ASS'Y

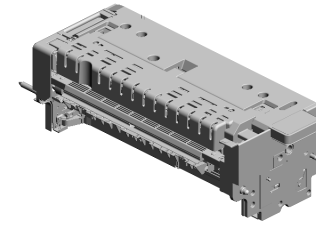

250.D1944031
 [A]
 (-AA,-EU,-CHN):FU
 SING UNIT:230V:A
 SS'Y
 201609-01 O/O

154.D0744284 GRIP:FUSING UNIT :REAR:FIBER
 149.D0744269 PIN:HANDLE:COVE R
 146.D0744264 BRACKET:DRAW E R
 153.D0744283 COVER:DRAWER: UPPER
 135.D0744172 COVER:HARNES S: FIRST

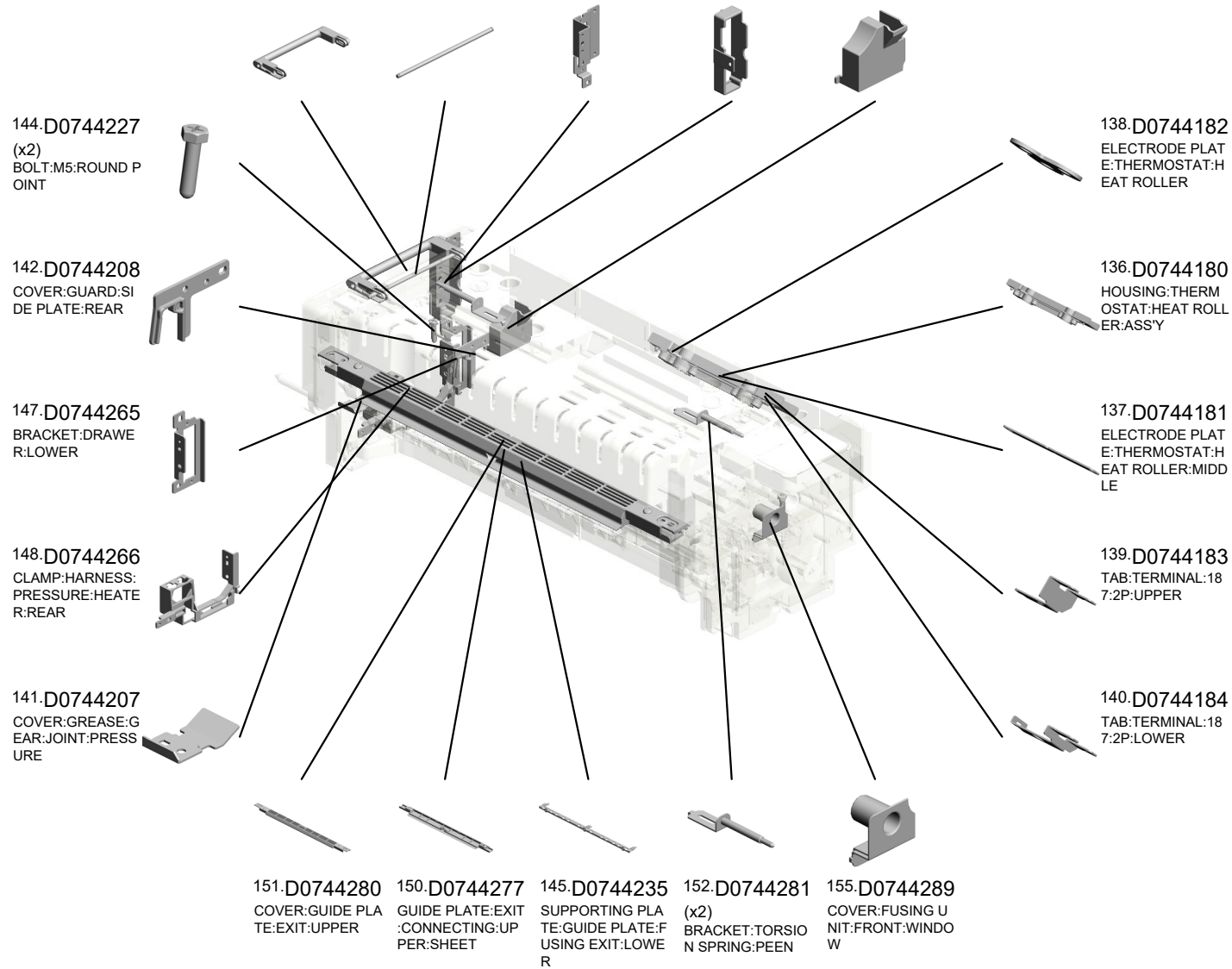

U015_S001
 (-AA,-EU,-CHN):FUSING UNIT:230V:ASS'Y

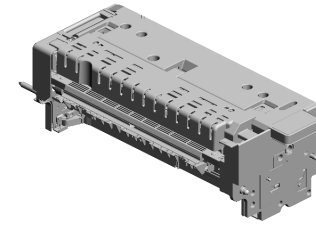

250.D1944031
 [A]
 (-AA,-EU,-CHN):FU
 SING UNIT:230V:A
 SS'Y
 201609-01 O/O

204.D1944195 HEATER HOLDER:
HEAT ROLLER:RE
AR
 195.D1944175 DISCHARGE BRUS
H:HEAT ROLLER
 200.D1944185 (x2)
RING:GUIDE:HEAT
ROLLER:DIA40
 197.D1944179 HOLDER:THERMIS
TOR:HEAT ROLLE
R:REAR
 191.D1944143 SHAFT:SEPARATI
ON SUB-UNIT

206.D1944197
HEATER HOLDER:
PRESSURE:REAR

189.D1944106
JOINT:CAM:PRESS
URE

180.D0745414
PCB:TCRU-IDB

188.D1944105
FEELER:CAM:PRE
SSURE:REAR

185.D1944068
GUIDE PLATE:FUSI
NG EXIT:LOWER:C
ONNECTING:ASS'Y

194.D1944173
DUCT:PRESSURE:
UPPER

187.D1944101
SHAFT:CAM:PRES
SURE

199.D1944184
FUSING ENTRANC
E GUIDE PLATE:LO
WER

177.D0744381
DECAL:FUSING UN
IT:POSITIONING

207.D1944198
HEATER HOLDER:
PRESSURE:FRON
T

192.D1944158
FUSING ENTRANC
E GUIDE PLATE:U
PPER:FIBER

198.D1944180
FLAT BELT-FUSIN
G:DIA80:SEAL

205.D1944196
HEATER HOLDER:
HEAT ROLLER:FR
ONT

202.D1944189
DISCHARGE BRUS
H:PRESSURE ROL
LER

196.D1944176
SIDE PLATE:PRES
SURE:ELECTRICA
L COMPONENTS:F
RONT

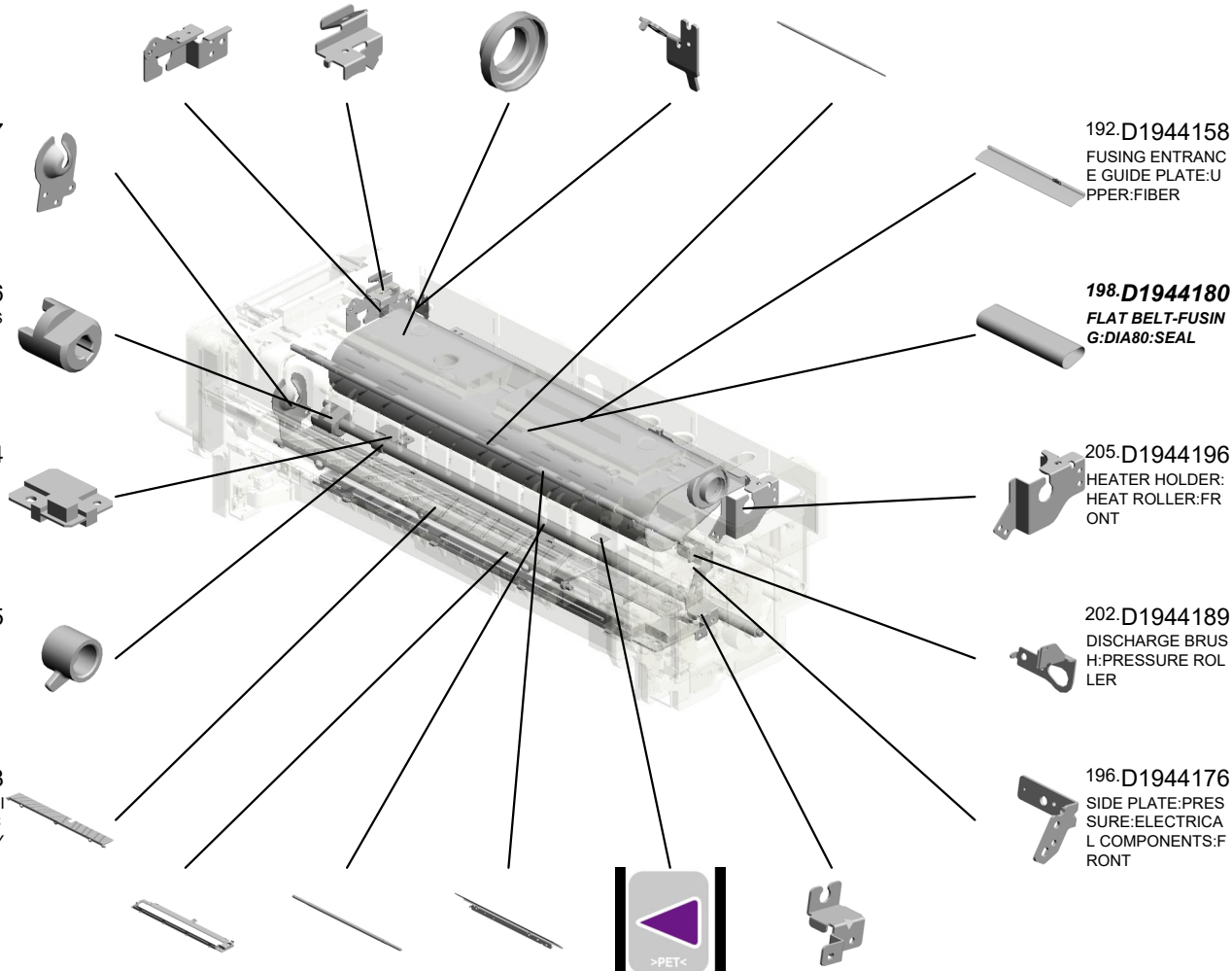

U015_S001
 (-AA,-EU,-CHN):FUSING UNIT:230V:ASS'Y

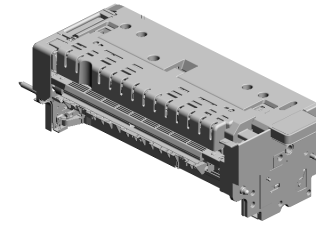

250.D1944031
 [A]
 (-AA,-EU,-CHN):FU
 SING UNIT:230V:A
 SS'Y
 201609-01 O/O

219.D1944268 BRACKET:GRIP:RE AR 201509-05 X/O
 216.D1944242 (x2) CAM:ON-OFF
 225.D1944311 SHAFT:DRIVE:POLI SH
 214.D1944234 (x2) LEVER:ON-OFF:B: PEEN
 213.D1944232 (x2) LEVER:ON-OFF:A: PEEN

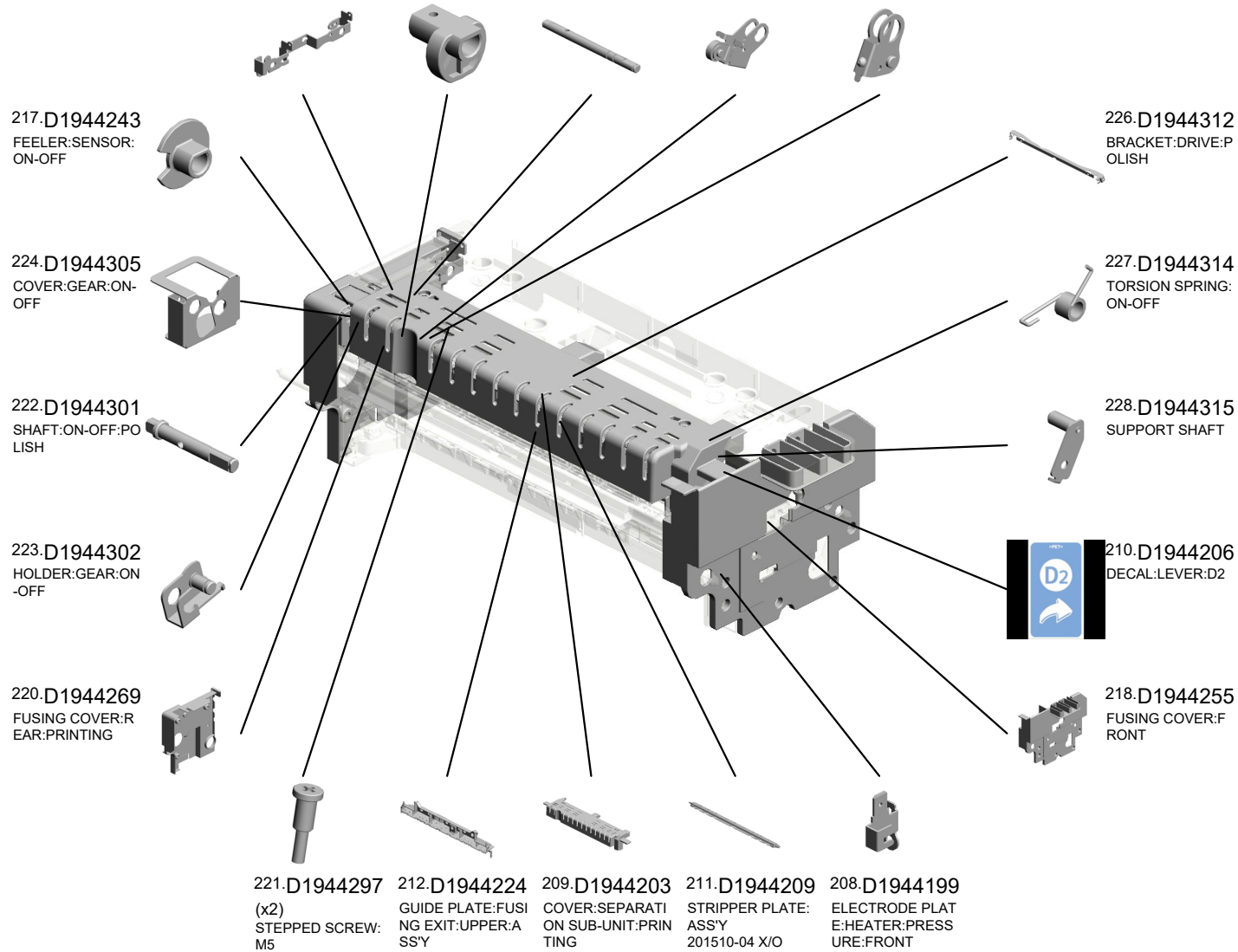

U001	U002	U003	U004	U005	U006	U007	U008	U009	U010	U011	U012	U013	U014	U015	U016	U017	U018	U019	U020	U021
------	------	------	------	------	------	------	------	------	------	------	------	------	------	------	------	------	------	------	------	------

U015_S001
 (-AA,-EU,-CHN):FUSING UNIT:230V:ASS'Y

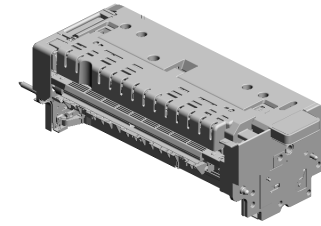

250.D1944031
 [A]
 (-AA,-EU,-CHN):FU
 SING UNIT:230V:A
 SS'Y
 201609-01 O/O

241.GA082007 230.D1944319 255.D0A53994 237.D1944399 229.D1944318
 PLAIN SHAFT BEA STOPPER:RADIAL LEVER:PAPER EXI (x2) STOPPER:RADIAL
 RING:4XDIA6DIA8 BALL BEARING:DIA T UNIT:REAR LEVER:RELEASE BALL BEARING
 10 201710-02 O/O

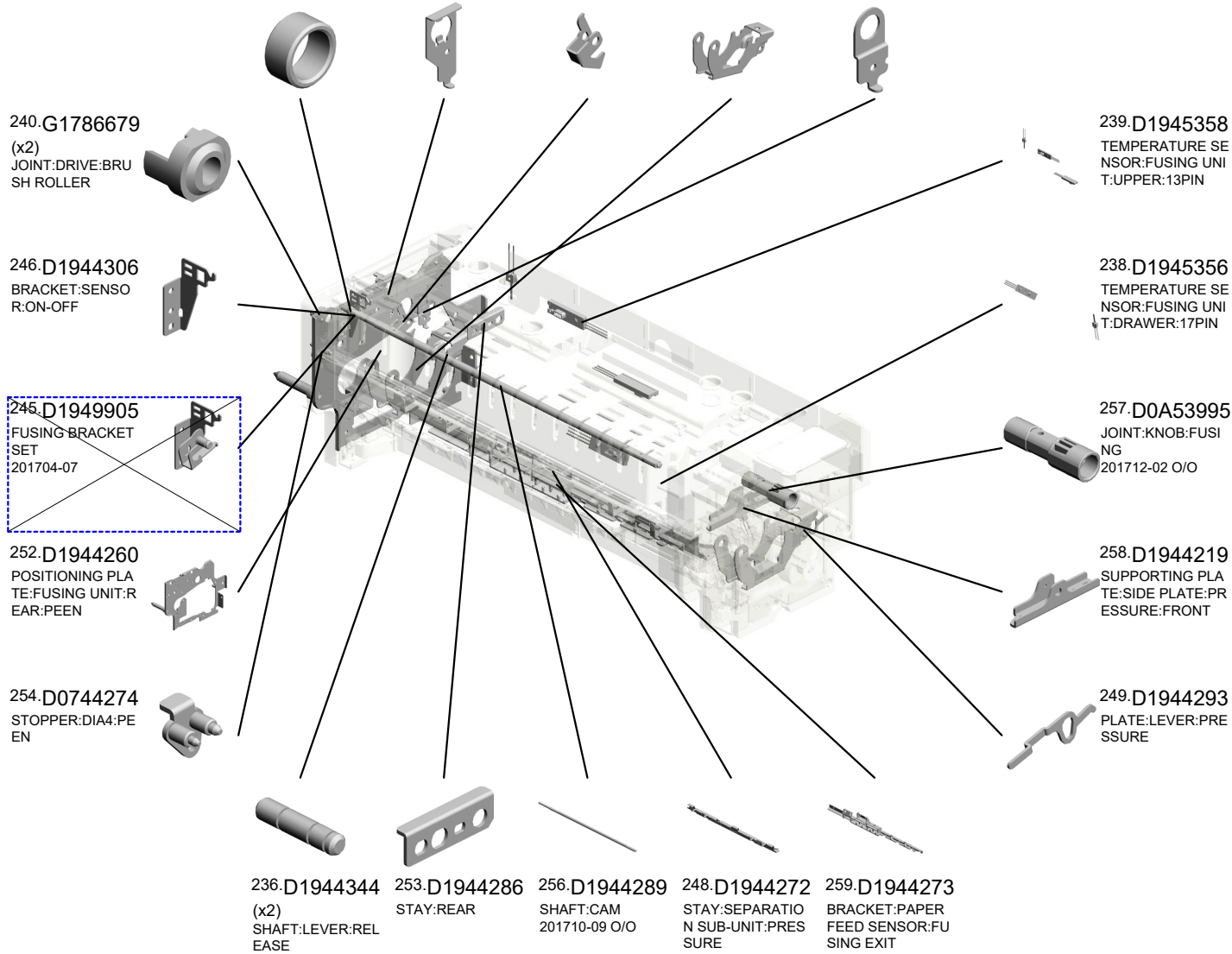

U015_S001
 (-AA,-EU,-CHN):FUSING UNIT:230V:ASS'Y

266.D1944220 SUPPORTING PLATE:SIDE PLATE:PRESSURE:REAR
 265.D1944150 SIDE PLATE:FUSING:REAR:PEEN
 270.D1944188 STAY:PRESSURE SUB-UNIT:ENTRANCE

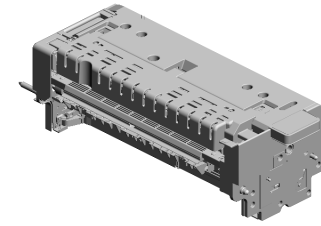

250.D1944031
 [A]
 (-AA,-EU,-CHN):FUSING UNIT:230V:ASS'Y
 201609-01 O/O

268.D1944271
 (x2)
 HEXAGON HEAD SCREW:ADHESIVE: M3X5
 201901-04 X/O

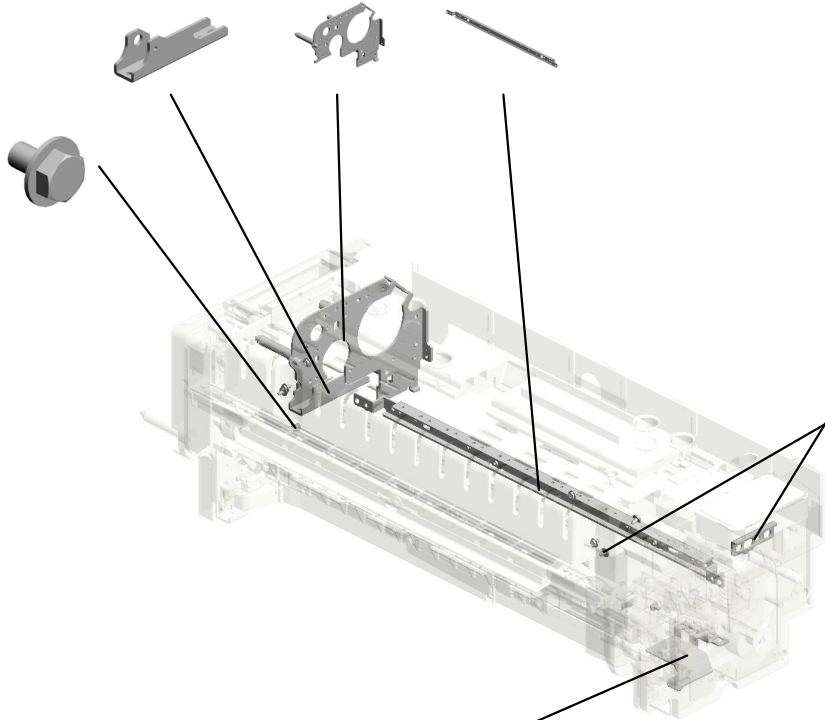

262.D1944285
 STAY:FRONT

271.D2051082
 (x7)
 HEXAGON HEAD SCREW:ROUND POINT: M3X6:BLACK
 202105-07 X/O

272.D0A54090
 BRACKET:PHOTO INTERRUPTOR:FRONT
 202208-02 X/O



D1944030
 [A]
 (-AA,-EU,-CHN):FUSING UNIT:230V:ASS'Y
 201609-01 O/O

U001	U002	U003	U004	U005	U006	U007	U008	U009	U010	U011	U012	U013	U014	U015	U016	U017	U018	U019	U020	U021
------	------	------	------	------	------	------	------	------	------	------	------	------	------	------	------	------	------	------	------	------

U015_S001_S001
FUSING COVER:UPPER:SUB-ASS'Y

201.D1944186
DECAL:WARNING (REMOVAL AND INSTALLATION);FUSING

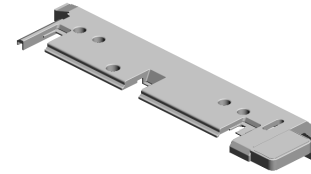
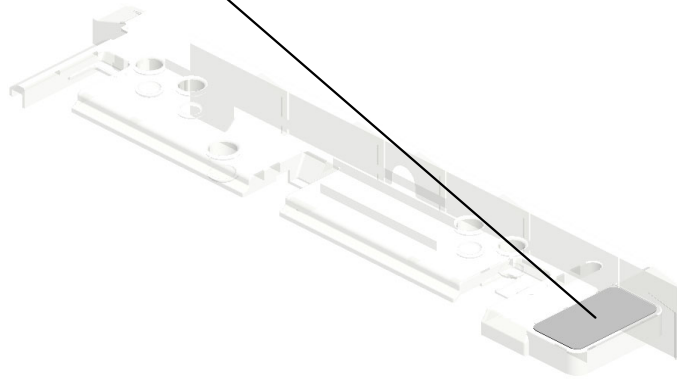

203.D1944190
FUSING COVER:UPPER:SUB-ASS'Y

U001	U002	U003	U004	U005	U006	U007	U008	U009	U010	U011	U012	U013	U014	U015	U016	U017	U018	U019	U020	U021
------	------	------	------	------	------	------	------	------	------	------	------	------	------	------	------	------	------	------	------	------

U015_S001_S002
GUIDE PLATE:FUSING EXIT:LOWER:NO.2:ASS'Y

264.D0894252
(x4)
GUIDE:FUSING EXI
T:PFA

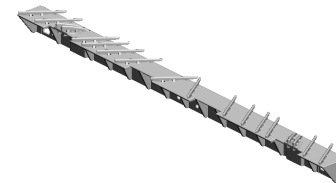
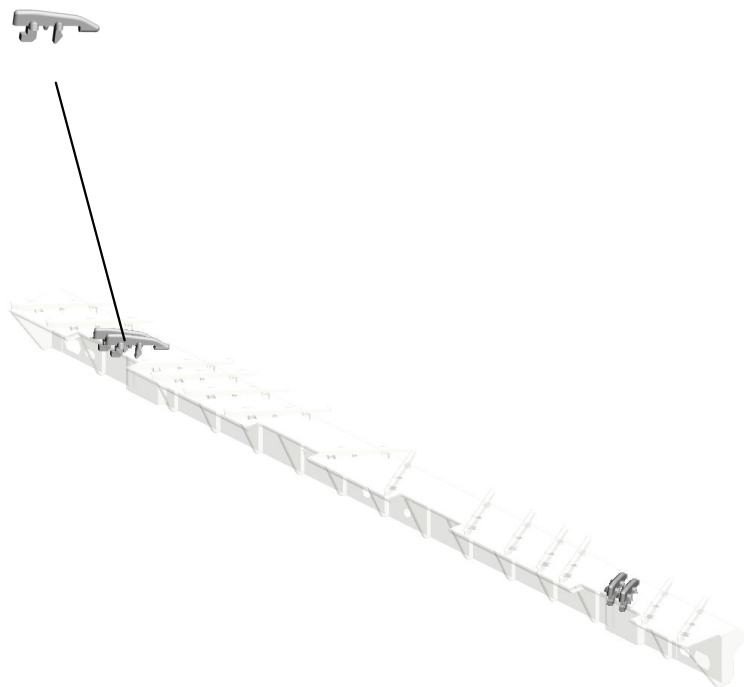

247.D1944066
GUIDE PLATE:FUSI
NG EXIT:LOWER:N
O.2:ASSY

U001	U002	U003	U004	U005	U006	U007	U008	U009	U010	U011	U012	U013	U014	U015	U016	U017	U018	U019	U020	U021
------	------	------	------	------	------	------	------	------	------	------	------	------	------	------	------	------	------	------	------	------

U015_S001_S003
 PRESSURE SUB-UNIT:STRIPPER PLATE:ASS'Y

19.08046123 264.D0894252
 HEXAGONAL BOLT (x13)
 :W/WASHER:M3X8 GUIDE:FUSING EXI
 T:PFA

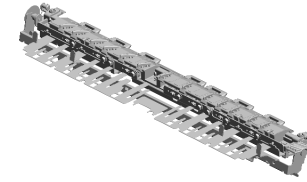

186.D1944074
 PRESSURE SUB-U
 NIT:STRIPPER PLA
 TE:ASS'Y

4.03603006N
 (x24)
 SCREW - M3X6

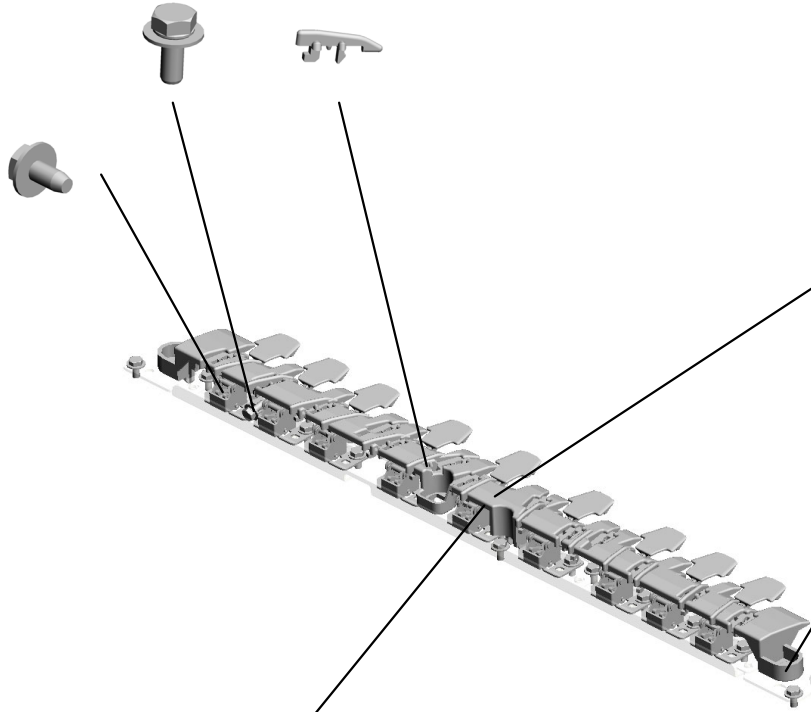

261.D1944115
 (x9)
 SERVICE PARTS:P
 ICKOFF PAWL:PRE
 SSURE ROLLER:A
 SS'Y

56.AA143520
 (x2)
 SHOULDER SCRE
 W - M3

269.D1944279
 GUIDE PLATE:SEP
 ARATION SUB-UNI
 T:PRESSURE

U001	U002	U003	U004	U005	U006	U007	U008	U009	U010	U011	U012	U013	U014	U015	U016	U017	U018	U019	U020	U021
------	------	------	------	------	------	------	------	------	------	------	------	------	------	------	------	------	------	------	------	------

U015_S002
 (-AA,-EU,-CHN):FUSING UNIT:230V:ASS'Y

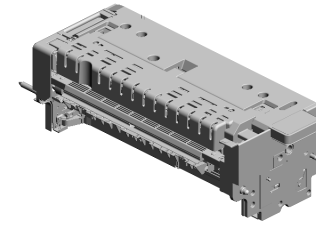

250.D1944031
 [A]
 (-AA,-EU,-CHN):FU
 SING UNIT:230V:A
 SS'Y
 201609-01 O/O

- 10.07200040E (x18) RETAINING RING - M4
- 18.07433906 RADIAL BALL BEARING: DIA6X DIA15X5
- 27.11050723 CLAMPS: WES-050 7
- 29.11050744 (x3) CLAMP: F-LWS-071 1
- 22.09543010N (x2) SCREW: POLISHED ROUND/SPRING: M3X10

15.07403706 BALL BEARING - M6X10X3

11.07200060E (x15) RETAINING RING - M6

9.07200030E (x4) RETAINING RING - M3

14.07250250E (x2) RETAINING RING C - M25

19.08046123 (x63) HEXAGONAL BOLT :W/WASHER: M3X8

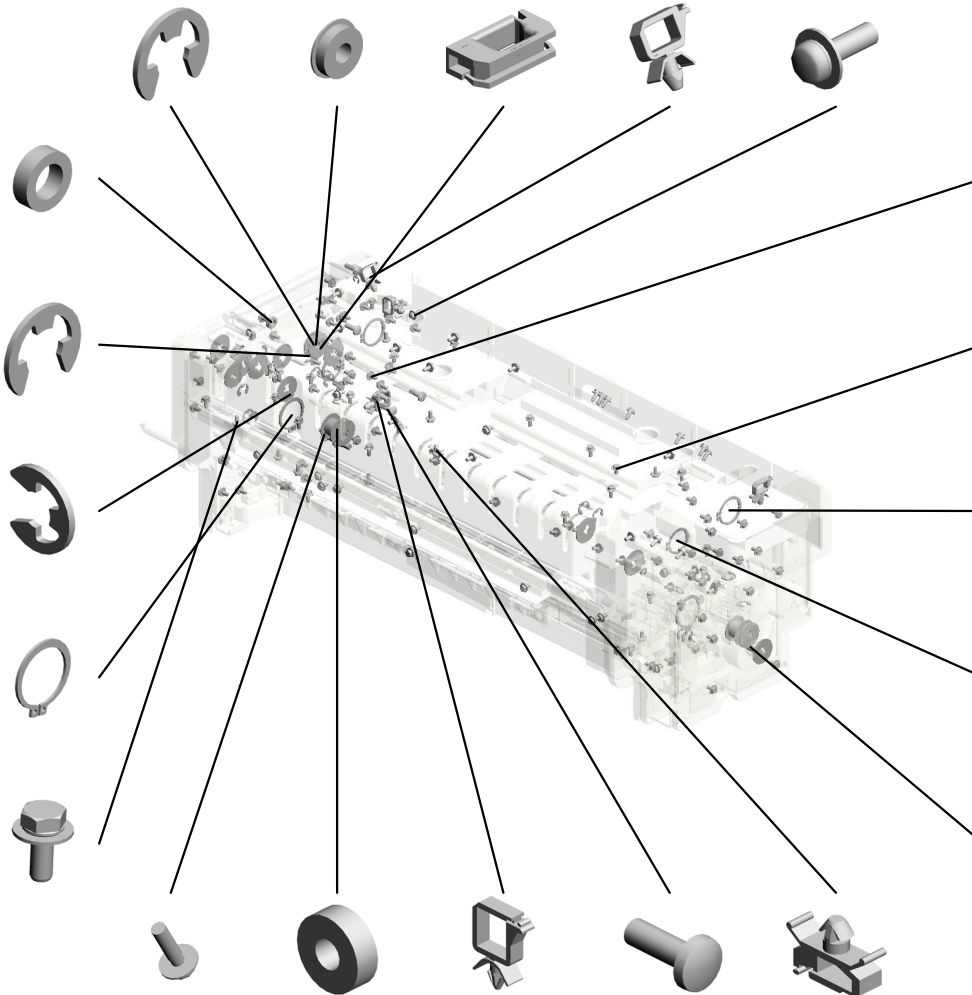

4.03603006N (x87) SCREW - M3X6

3.03603005P (x2) SCREW: M3X5

13.07250220E (x2) RETAINING RING - M22

12.07250200E (x2) RETAINING RING C - M20

21.09300404A (x2) PARALLEL KEY: 4X4X25

23.09543012N SCREW - M3X12

16.07403906 (x4) BALL BEARING - 6X15X5

24.11050488 HARNESS CLAMP

2.03540120N (x4) SCREW M4X12

26.11050713 (x3) CLAMP: LWSM-030 6H GRAY

U015_S002

(-AA,-EU,-CHN):FUSING UNIT:230V:ASS'Y

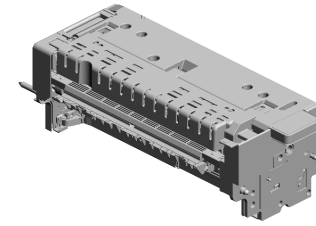

250.D1944031

[A]
(-AA,-EU,-CHN):FU
SING UNIT:230V:A
SS'Y
201609-01 O/O

- 54.AA082101 (x4) BUSHING - 6X10X6
- 42.AA064004 (x2) COMPRESSION SPRING:PRESSURE:375N
- 46.AA066687 TORSION SPRING: LOCK:SEPARATION:REAR:15N
- 55.AA113037 (x2) TERMINAL:4P:187 STEPPED SCREW: DIA5:3.5:M3
- 57.AA143847 (x2) STEPPED SCREW: DIA5:3.5:M3

49.AA066691
TORSION SPRING:
GRIP

35.AA061164
TENSION SPRING:
GEAR:ON-OFF

50.AA080247
(x2)
BUSHING - B-F6-3

40.AA063484
COMPRESSION SPRING:
ROLLER:POLISH:REAR

48.AA066690
TORSION SPRING:
DUCT:REAR

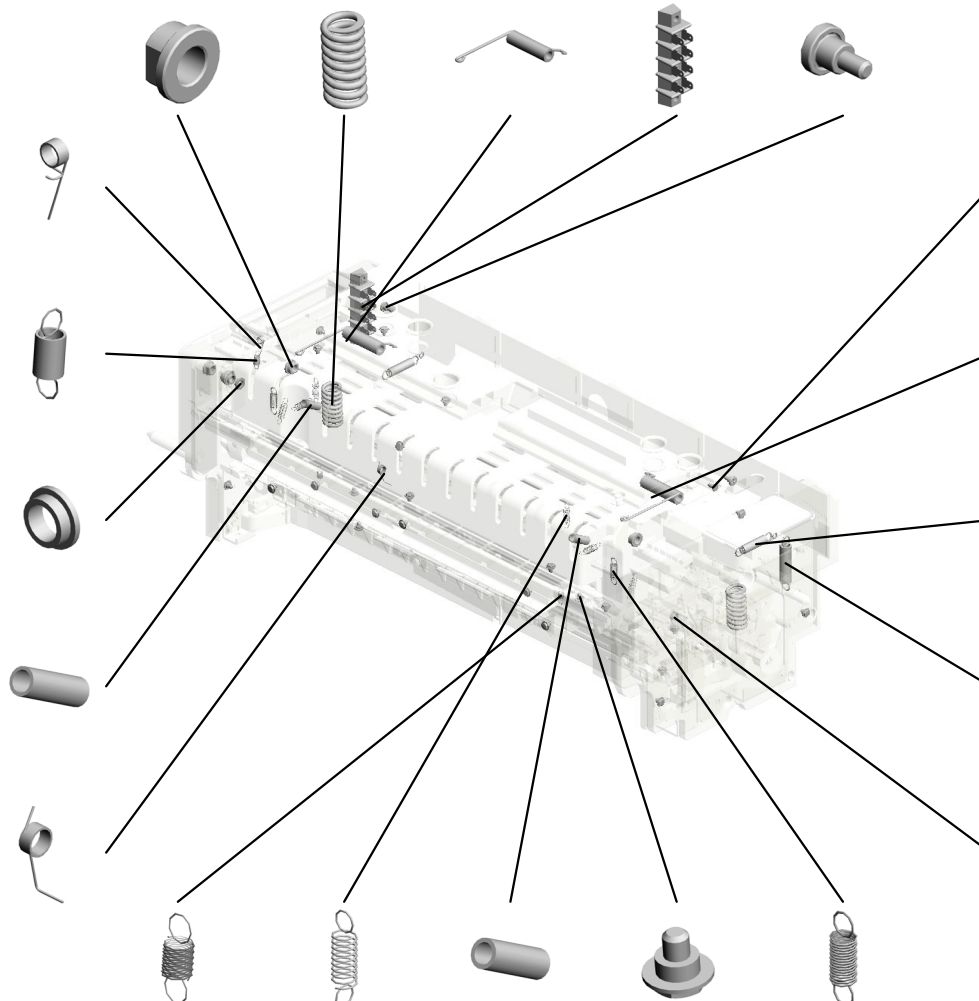

31.58942540
ARM SCREW

45.AA066686
TORSION SPRING:
LOCK:SEPARATION:
FRONT:15N

37.AA062352
(x2)
TENSION SPRING:
HEAT ROLLER

36.AA061199
TENSION SPRING:
LEVER:PRESSURE:
30N

47.AA066689
TORSION SPRING:
DUCT:FRONT

- 32.AA061115 (x2) TENSION SPRING: 0.4N
- 33.AA061116 (x6) TENSION SPRING: STRIPPER PLATE: 2N
- 41.AA063724 COMPRESSION SPRING:ROLLER:POLISH
- 56.AA143520 (x24) SHOULDER SCREW - M3
- 34.AA061117 (x2) TENSION SPRING: STRIPPER PLATE

U001	U002	U003	U004	U005	U006	U007	U008	U009	U010	U011	U012	U013	U014	U015	U016	U017	U018	U019	U020	U021
------	------	------	------	------	------	------	------	------	------	------	------	------	------	------	------	------	------	------	------	------

U015_S002
 (-AA,-EU,-CHN):FUSING UNIT:230V:ASS'Y

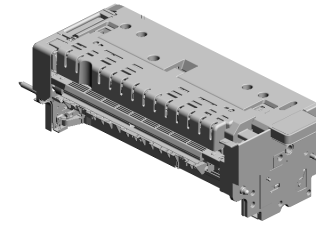

250.D1944031
 [A]
 (-AA,-EU,-CHN):FU
 SING UNIT:230V:A
 SS'Y
 201609-01 O/O

- 58.AA143885 (x2) STEPPED SCREW: M3
- 68.AB012203 GEAR:DRIVE:ROLL ER:FUSING:B
- 81.AW010147 PHOTO REFLECTI ON SENSOR
- 73.AE010122 **HOT ROLLER:DIA5 4**
- 74.AE012044 HEAT ROLLER:DIA 40

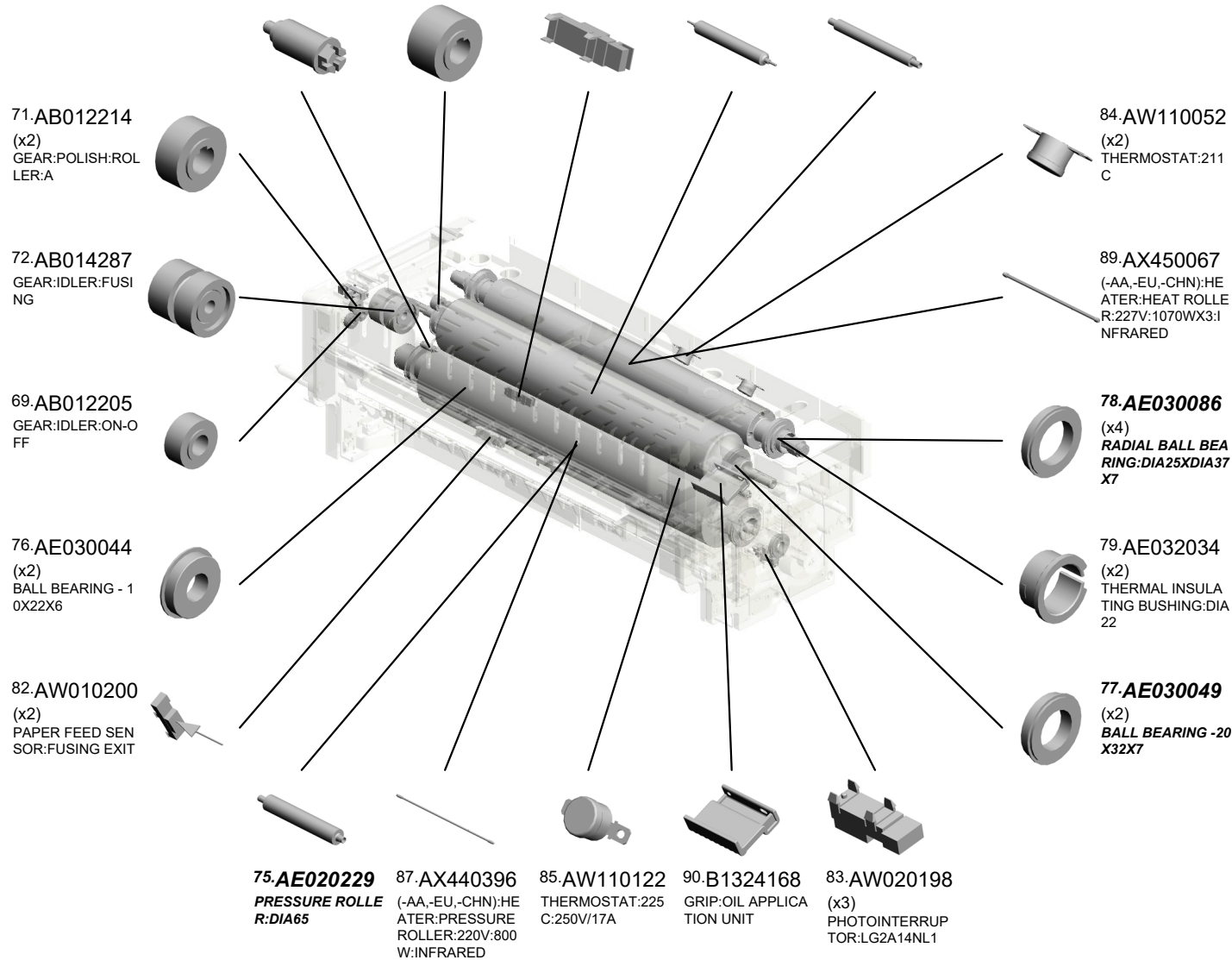

U001	U002	U003	U004	U005	U006	U007	U008	U009	U010	U011	U012	U013	U014	U015	U016	U017	U018	U019	U020	U021
------	------	------	------	------	------	------	------	------	------	------	------	------	------	------	------	------	------	------	------	------

U015_S002

(-AA,-EU,-CHN):FUSING UNIT:230V:ASS'Y

- 91.B1324197 TORSION SPRING: LEVER
- 95.B8722614 (x6) BUSHING:R1
- 100.BB013038 GEAR:HOT ROLLER:ASS'Y
- 92.B1324313 (x2) PRESSURE SPRING HOLDER
- 105.D0744009 (x4) HOLDER:M5

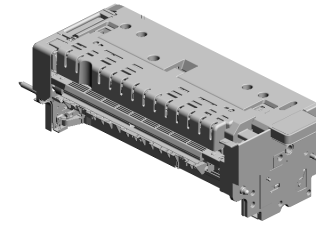

250.D1944031
 [A]
 (-AA,-EU,-CHN):FUSING UNIT:230V:ASS'Y
 201609-01 O/O

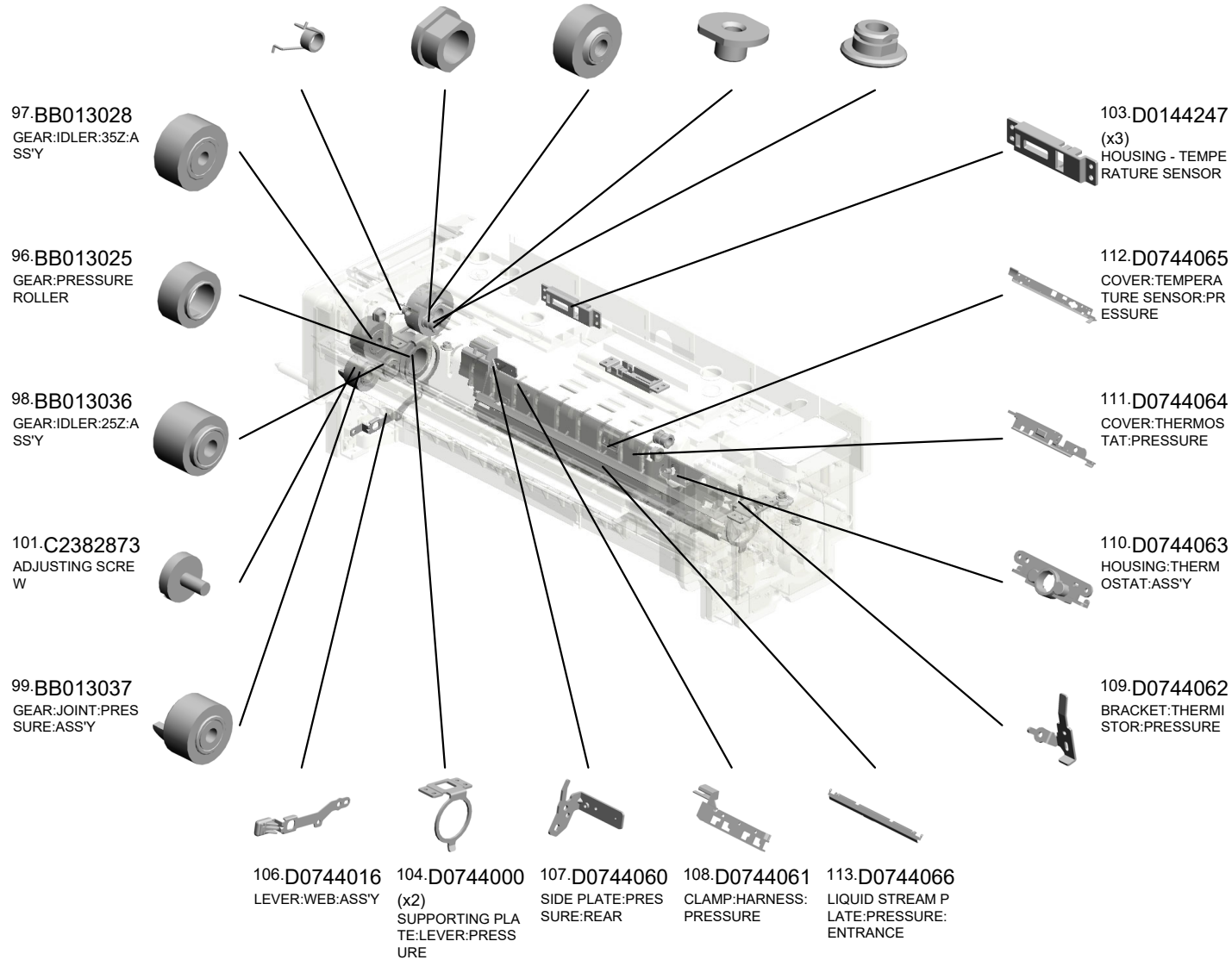

U015_S002
 (-AA,-EU,-CHN):FUSING UNIT:230V:ASS'Y

- 124.D0744100 COVER:BASE:ID
- 122.D0744098 COVER:TERMINAL:CONNECTING
- 123.D0744099 COVER:HARNESS:FIRST:LOWER
- 120.D0744096 TERMINAL:CONNECTING
- 121.D0744097 TAB:TERMINAL:CONNECTING

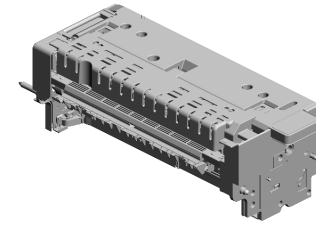

250.D1944031
 [A]
 (-AA,-EU,-CHN):FUSING UNIT:230V:ASS'Y
 201609-01 O/O

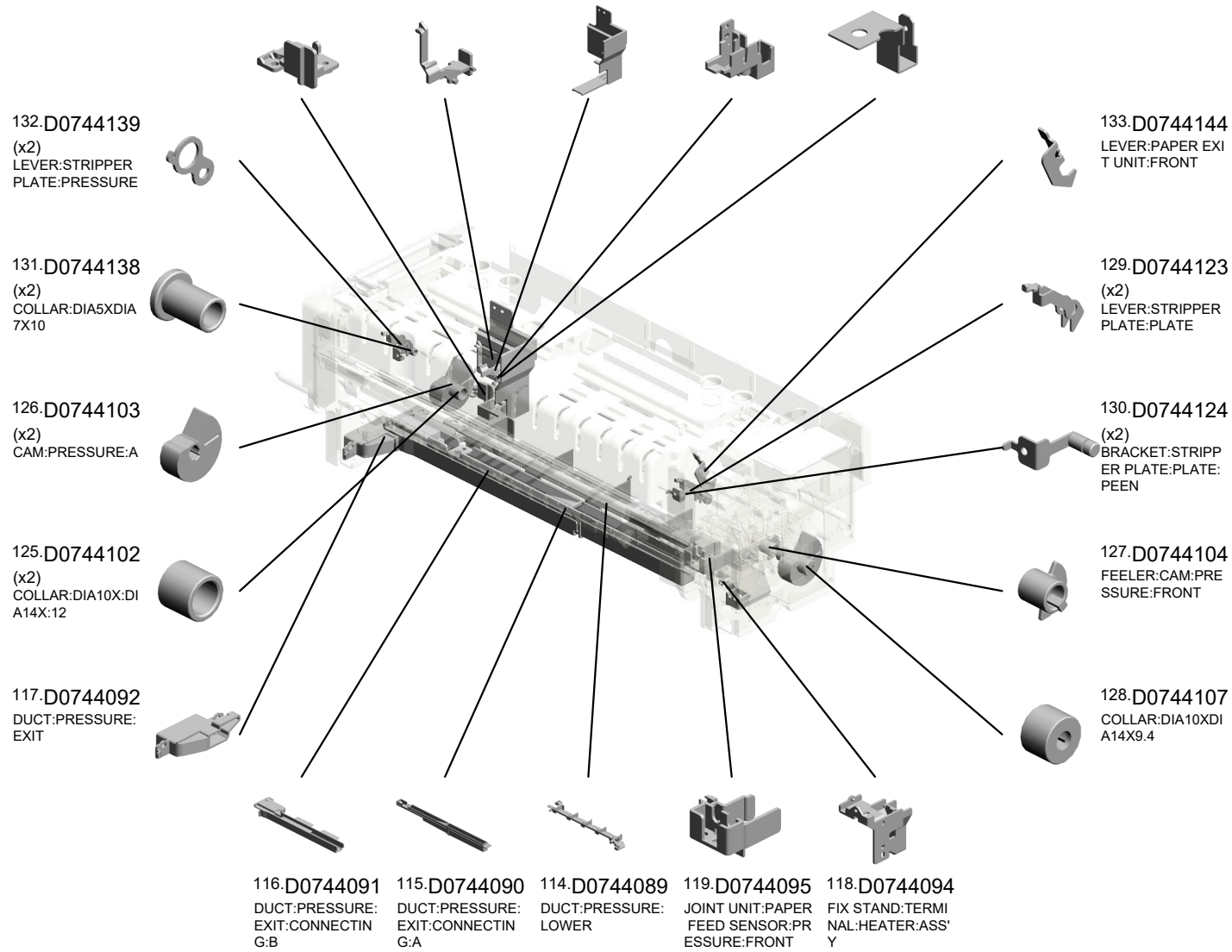

U015_S002
 (-AA,-EU,-CHN):FUSING UNIT:230V:ASS'Y

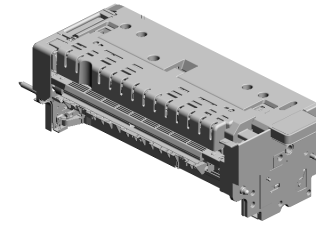

250.D1944031
 [A]
 (-AA,-EU,-CHN):FU
 SING UNIT:230V:A
 SS'Y
 201609-01 O/O

154.D0744284 GRIP:FUSING UNIT :REAR:FIBER
 149.D0744269 PIN:HANDLE:COVE R
 146.D0744264 BRACKET:DRAWER R
 153.D0744283 COVER:DRAWER: UPPER
 135.D0744172 COVER:HARNES: FIRST

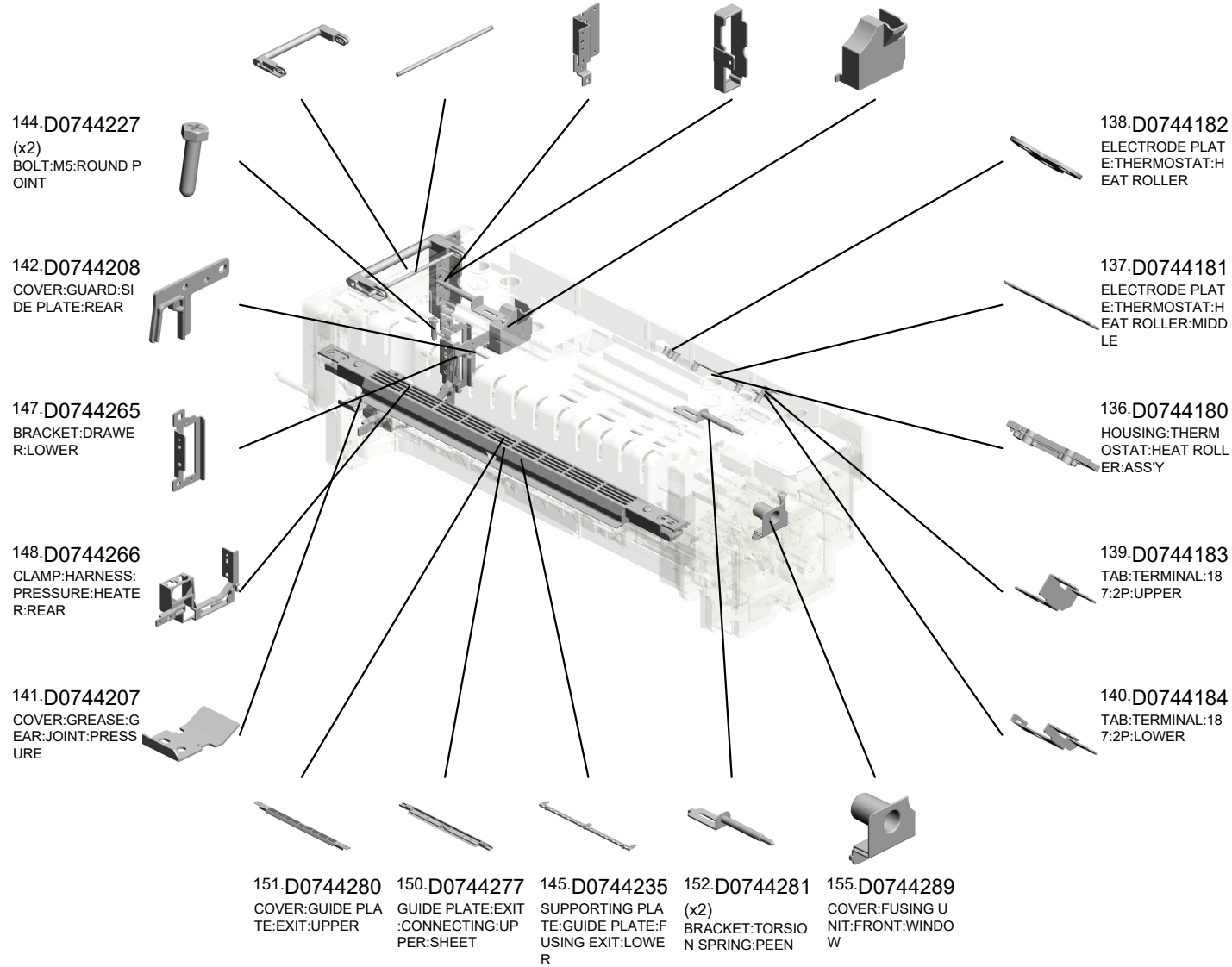

U015_S002
 (-AA,-EU,-CHN):FUSING UNIT:230V:ASS'Y

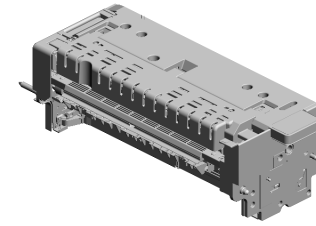

250.D1944031
 [A]
 (-AA,-EU,-CHN):FU
 SING UNIT:230V:A
 SS'Y
 201609-01 O/O

204.D1944195 HEATER HOLDER:
HEAT ROLLER:RE
AR
 195.D1944175 DISCHARGE BRUS
H:HEAT ROLLER
 200.D1944185 (x2)
RING:GUIDE:HEAT
ROLLER:DIA40
 197.D1944179 HOLDER:THERMIS
TOR:HEAT ROLLE
R:REAR
 191.D1944143 SHAFT:SEPARATI
ON SUB-UNIT

206.D1944197
HEATER HOLDER:
PRESSURE:REAR

189.D1944106
JOINT:CAM:PRESS
URE

180.D0745414
PCB:TCRU-IDB

188.D1944105
FEELER:CAM:PRE
SSURE:REAR

185.D1944068
GUIDE PLATE:FUSI
NG EXIT:LOWER:C
ONNECTING:ASS'Y

194.D1944173
DUCT:PRESSURE:
UPPER

187.D1944101
SHAFT:CAM:PRES
SURE

199.D1944184
FUSING ENTRANC
E GUIDE PLATE:LO
WER

177.D0744381
DECAL:FUSING UN
IT:POSITIONING

207.D1944198
HEATER HOLDER:
PRESSURE:FRON
T

192.D1944158
FUSING ENTRANC
E GUIDE PLATE:U
PPER:FIBER

198.D1944180
FLAT BELT-FUSIN
G:DIA80:SEAL

205.D1944196
HEATER HOLDER:
HEAT ROLLER:FR
ONT

202.D1944189
DISCHARGE BRUS
H:PRESSURE ROL
LER

196.D1944176
SIDE PLATE:PRES
SURE:ELECTRICA
L COMPONENTS:F
RONT



U015_S002

(-AA,-EU,-CHN):FUSING UNIT:230V:ASS'Y

- 219.D1944268 BRACKET:GRIP:REAR 201509-05 X/O
- 216.D1944242 (x2) CAM:ON-OFF
- 225.D1944311 SHAFT:DRIVE:POLISH
- 214.D1944234 (x2) LEVER:ON-OFF:B:PEEN
- 213.D1944232 (x2) LEVER:ON-OFF:A:PEEN

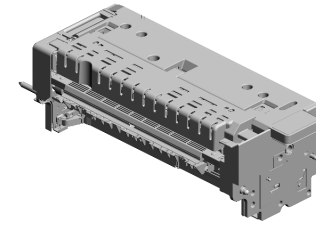

250.D1944031
[A]
 (-AA,-EU,-CHN):FUSING UNIT:230V:ASS'Y
 201609-01 O/O

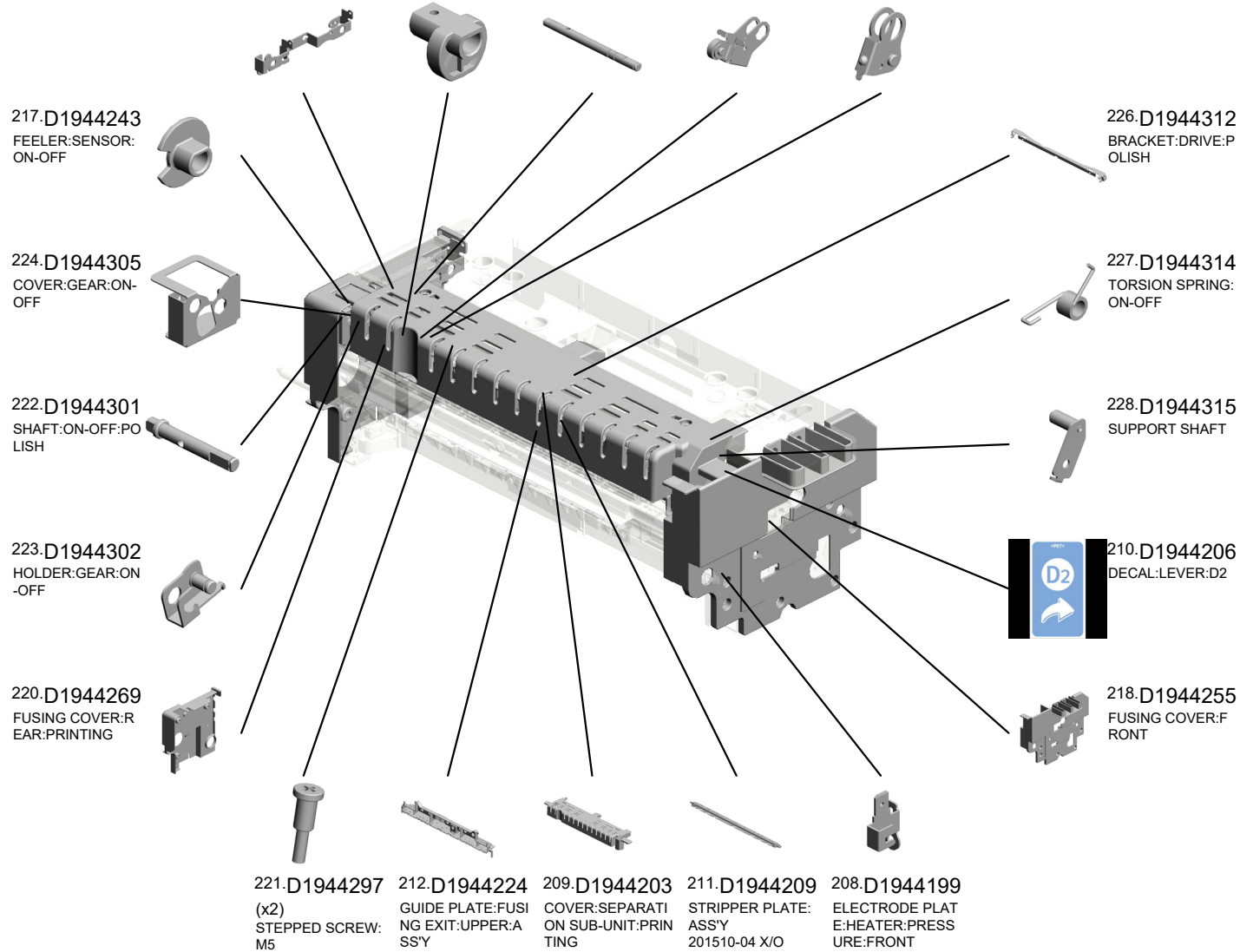

U001	U002	U003	U004	U005	U006	U007	U008	U009	U010	U011	U012	U013	U014	U015	U016	U017	U018	U019	U020	U021
------	------	------	------	------	------	------	------	------	------	------	------	------	------	------	------	------	------	------	------	------

U015_S002
 (-AA,-EU,-CHN):FUSING UNIT:230V:ASS'Y

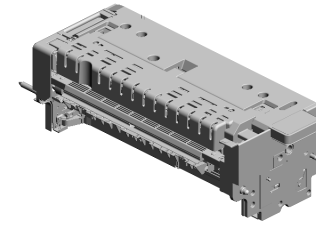

250.D1944031
 [A]
 (-AA,-EU,-CHN):FU
 SING UNIT:230V:A
 SS'Y
 201609-01 O/O

241.GA082007
 PLAIN SHAFT BEA
 RING:4XDIA6DIA8

245.D1949905
 FUSING BRACKET
 SET
 201704-07

230.D1944319
 STOPPER:RADIAL
 BALL BEARING:DIA
 10

255.D0A53994
 LEVER:PAPER EXI
 T UNIT:REAR
 201710-02 O/O

229.D1944318
 STOPPER:RADIAL
 BALL BEARING

240.G1786679
 (x2)
 JOINT:DRIVE:BRU
 SH ROLLER

246.D1944306
 BRACKET:SENSO
 R:ON-OFF

252.D1944260
 POSITIONING PLA
 TE:FUSING UNIT:R
 EAR:PEEN

254.D0744274
 STOPPER:DIA4:PE
 EN

237.D1944399
 (x2)
 LEVER:RELEASE

236.D1944344
 (x2)
 SHAFT:LEVER:REL
 EASE

253.D1944286
 STAY:REAR

256.D1944289
 SHAFT:CAM
 201710-09 O/O

248.D1944272
 STAY:SEPARATIO
 N SUB-UNIT:PRES
 SURE

259.D1944273
 BRACKET:PAPER
 FEED SENSOR:FU
 SING EXIT

239.D1945358
 TEMPERATURE SE
 NSOR:FUSING UNI
 T:UPPER:13PIN

238.D1945356
 TEMPERATURE SE
 NSOR:FUSING UNI
 T:DRAWER:17PIN

257.D0A53995
 JOINT:KNOB:FUSI
 NG
 201712-02 O/O

258.D1944219
 SUPPORTING PLA
 TE:SIDE PLATE:PR
 ESSURE:FRONT

249.D1944293
 PLATE:LEVER:PRE
 SSURE

U015_S002
 (-AA,-EU,-CHN):FUSING UNIT:230V:ASS'Y

266.D1944220 SUPPORTING PLATE:SIDE PLATE:PRESSURE:REAR
 265.D1944150 SIDE PLATE:FUSING:REAR:PEEN
 270.D1944188 STAY:PRESSURE SUB-UNIT:ENTRANCE

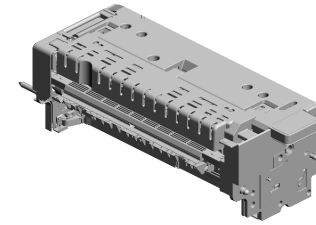

250.D1944031
 [A]
 (-AA,-EU,-CHN):FUSING UNIT:230V:ASS'Y
 201609-01 O/O

268.D1944271
 (x2)
 HEXAGON HEAD SCREW:ADHESIVE: M3X5
 201901-04 X/O

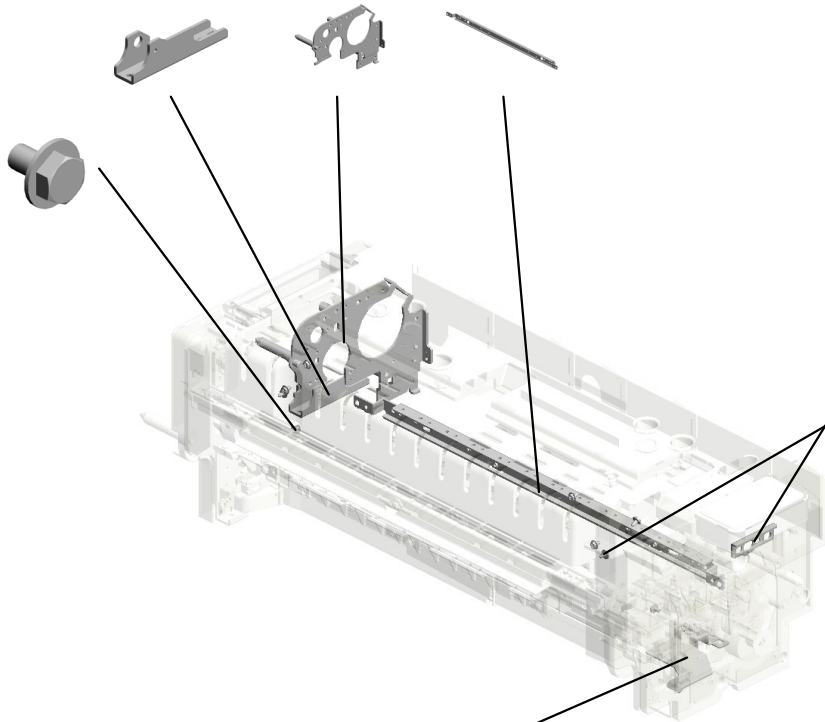

262.D1944285
 STAY:FRONT

271.D2051082
 (x7)
 HEXAGON HEAD SCREW:ROUND POINT: M3X6:BLACK
 202105-07 X/O

272.D0A54090
 BRACKET:PHOTO INTERRUPTOR:FRONT
 202208-02 X/O

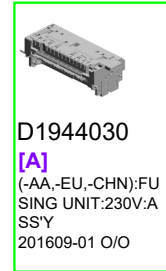

D1944030
 [A]
 (-AA,-EU,-CHN):FUSING UNIT:230V:ASS'Y
 201609-01 O/O

U015_S002_S001
FUSING COVER:UPPER:SUB-ASS'Y

201.D1944186
DECAL:WARNING (REMOVAL AND INSTALLATION);FUSING

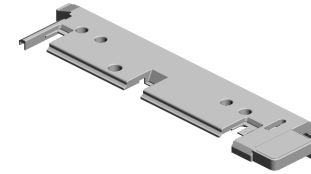

203.D1944190
FUSING COVER:UPPER:SUB-ASS'Y

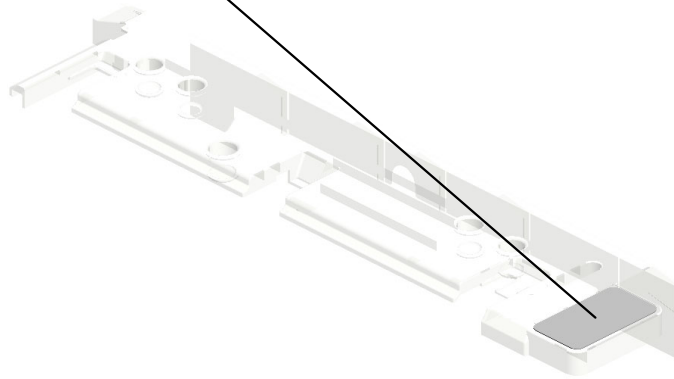

U001	U002	U003	U004	U005	U006	U007	U008	U009	U010	U011	U012	U013	U014	U015	U016	U017	U018	U019	U020	U021
------	------	------	------	------	------	------	------	------	------	------	------	------	------	------	------	------	------	------	------	------

U015_S002_S002
GUIDE PLATE:FUSING EXIT:LOWER:NO.2:ASS'Y

264.D0894252
(x4)
GUIDE:FUSING EXI
T:PFA

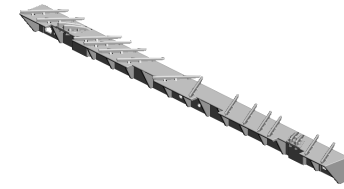
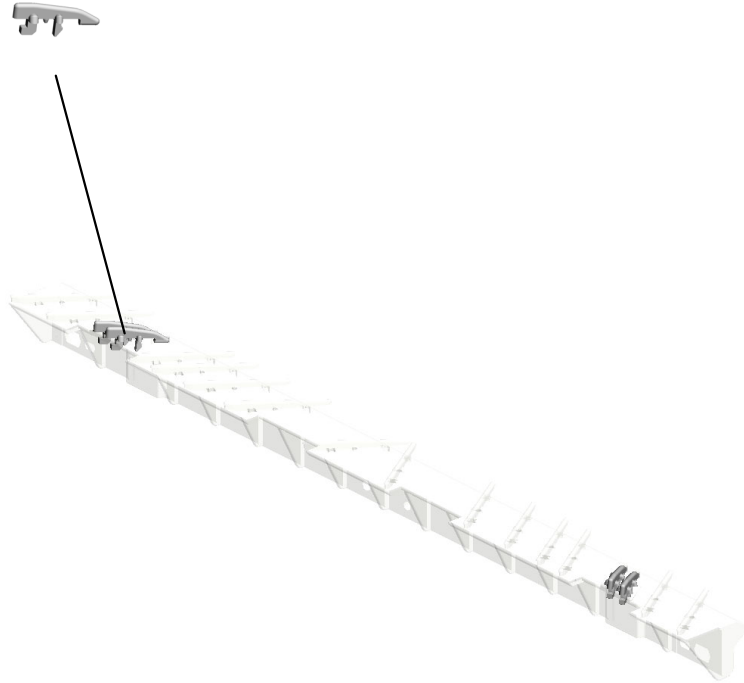

247.D1944066
GUIDE PLATE:FUSI
NG EXIT:LOWER:N
O.2:ASSY

U001	U002	U003	U004	U005	U006	U007	U008	U009	U010	U011	U012	U013	U014	U015	U016	U017	U018	U019	U020	U021
------	------	------	------	------	------	------	------	------	------	------	------	------	------	------	------	------	------	------	------	------

U015_S002_S003

PRESSURE SUB-UNIT:STRIPPER PLATE:ASS'Y

56.AA143520 264.D0894252
(x2) (x13)
SHOULDER SCRE GUIDE:FUSING EXI
W - M3 T:PFA

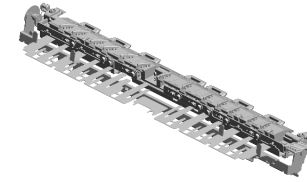

186.D1944074
PRESSURE SUB-U
NIT:STRIPPER PLA
TE:ASS'Y

19.08046123
HEXAGONAL BOLT
:W/WASHER:M3X8

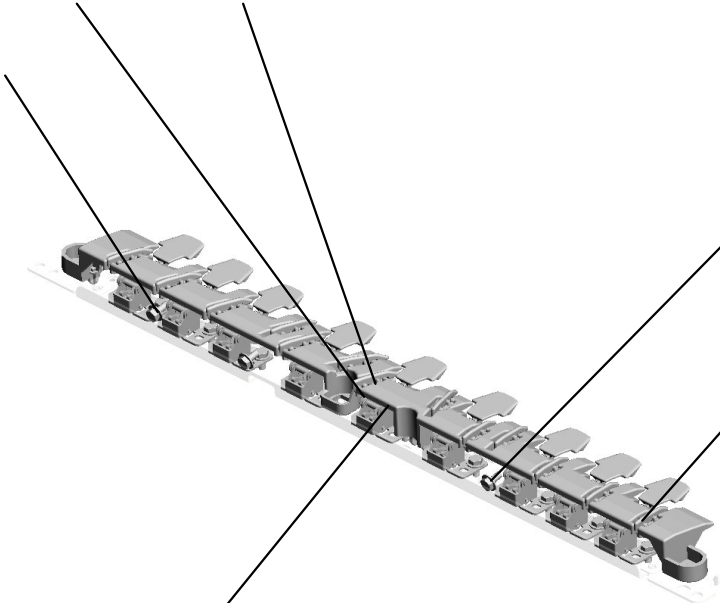
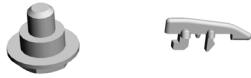

4.03603006N(x 2)
SCREW - M3X6



4.03603006N
(x22)
SCREW - M3X6



261.D1944115
(x9)
SERVICE PARTS:P
ICKOFF PAWL:PRE
SSURE ROLLER:A
SS'Y

269.D1944279
GUIDE PLATE:SEP
ARATION SUB-UNI
T:PRESSURE



U001	U002	U003	U004	U005	U006	U007	U008	U009	U010	U011	U012	U013	U014	U015	U016	U017	U018	U019	U020	U021
------	------	------	------	------	------	------	------	------	------	------	------	------	------	------	------	------	------	------	------	------

U015_S003
 (-AA,-EU,-CHN):FUSING UNIT:230V:ASS'Y

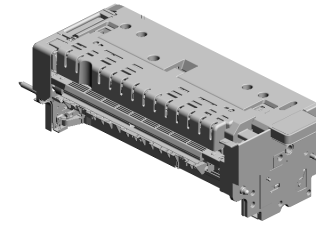

250.D1944031
 [A]
 (-AA,-EU,-CHN):FU
 SING UNIT:230V:A
 SS'Y
 201609-01 O/O

10.07200040E (x18) RETAINING RING - M4
 18.07433906 RADIAL BALL BEARING: DIA6X DIA15X5
 27.11050723 CLAMPS:WES-050 7
 29.11050744 (x3) CLAMP:F-LWS-071 1
 22.09543010N (x2) SCREW:POLISHED ROUND/SPRING:M3X10

15.07403706 BALL BEARING - M6X10X3

11.07200060E (x15) RETAINING RING - M6

9.07200030E (x4) RETAINING RING - M3

14.07250250E (x2) RETAINING RING C - M25

19.08046123 (x63) HEXAGONAL BOLT :W/WASHER:M3X8

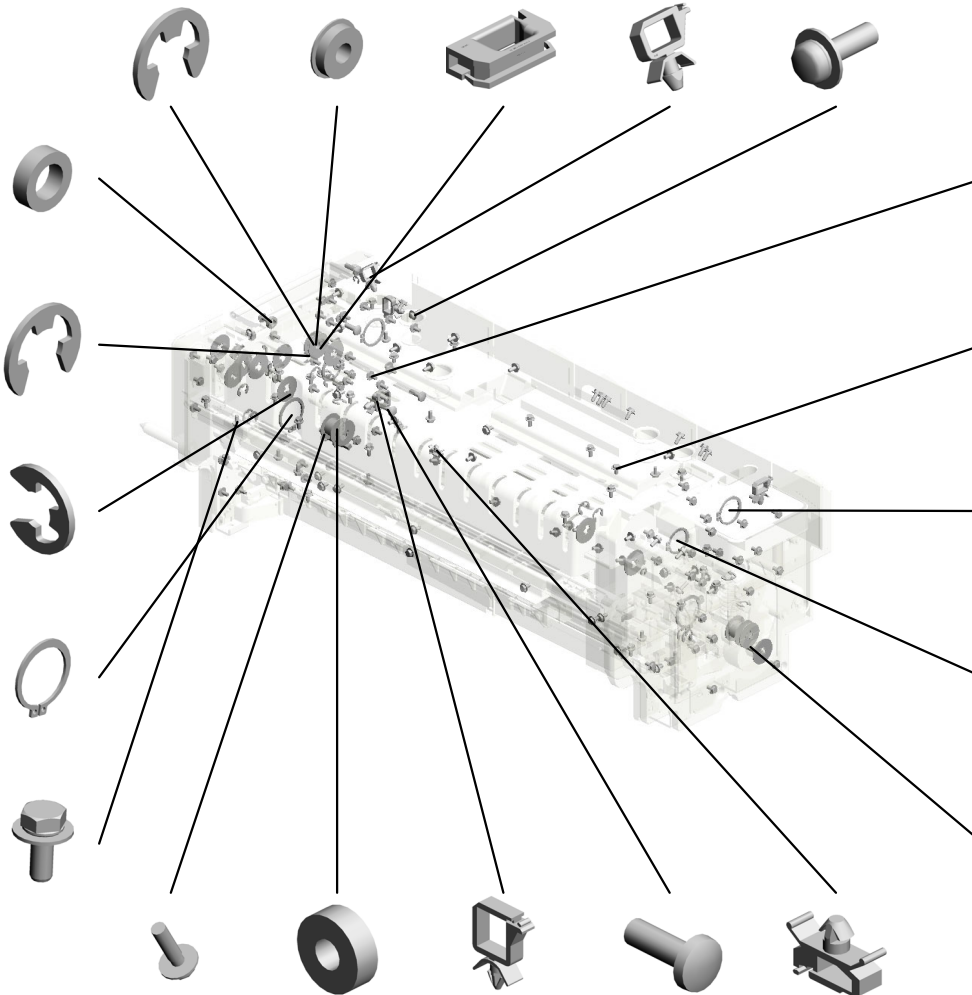

4.03603006N (x87) SCREW - M3X6

3.03603005P (x2) SCREW:M3X5

13.07250220E (x2) RETAINING RING - M22

12.07250200E (x2) RETAINING RING C - M20

21.09300404A (x2) PARALLEL KEY:4X4X25

23.09543012N SCREW - M3X12

16.07403906 (x4) BALL BEARING - 6X15X5

24.11050488 HARNESS CLAMP

2.03540120N (x4) SCREW M4X12

26.11050713 (x3) CLAMP:LWSM-030 6H GRAY

U015_S003

(-AA,-EU,-CHN):FUSING UNIT:230V:ASS'Y

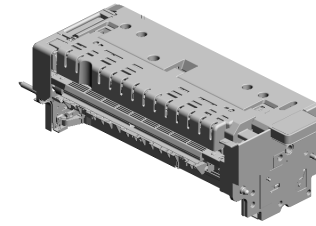

250.D1944031

[A]
(-AA,-EU,-CHN):FU
SING UNIT:230V:A
SS'Y
201609-01 O/O

- 54.AA082101 (x4) BUSHING - 6X10X6
- 42.AA064004 (x2) COMPRESSION SPRING: RING:PRESSURE:375N
- 46.AA066687 TORSION SPRING: LOCK:SEPARATION:REAR:15N
- 55.AA113037 (x2) TERMINAL:4P:187
- 57.AA143847 (x2) STEPPED SCREW: DIA5:3.5:M3

49.AA066691
TORSION SPRING:
GRIP

35.AA061164
TENSION SPRING:
GEAR:ON-OFF

50.AA080247
(x2)
BUSHING - B-F6-3

40.AA063484
COMPRESSION SPRING:
RING:ROLLER:POLISH:REAR

48.AA066690
TORSION SPRING:
DUCT:REAR

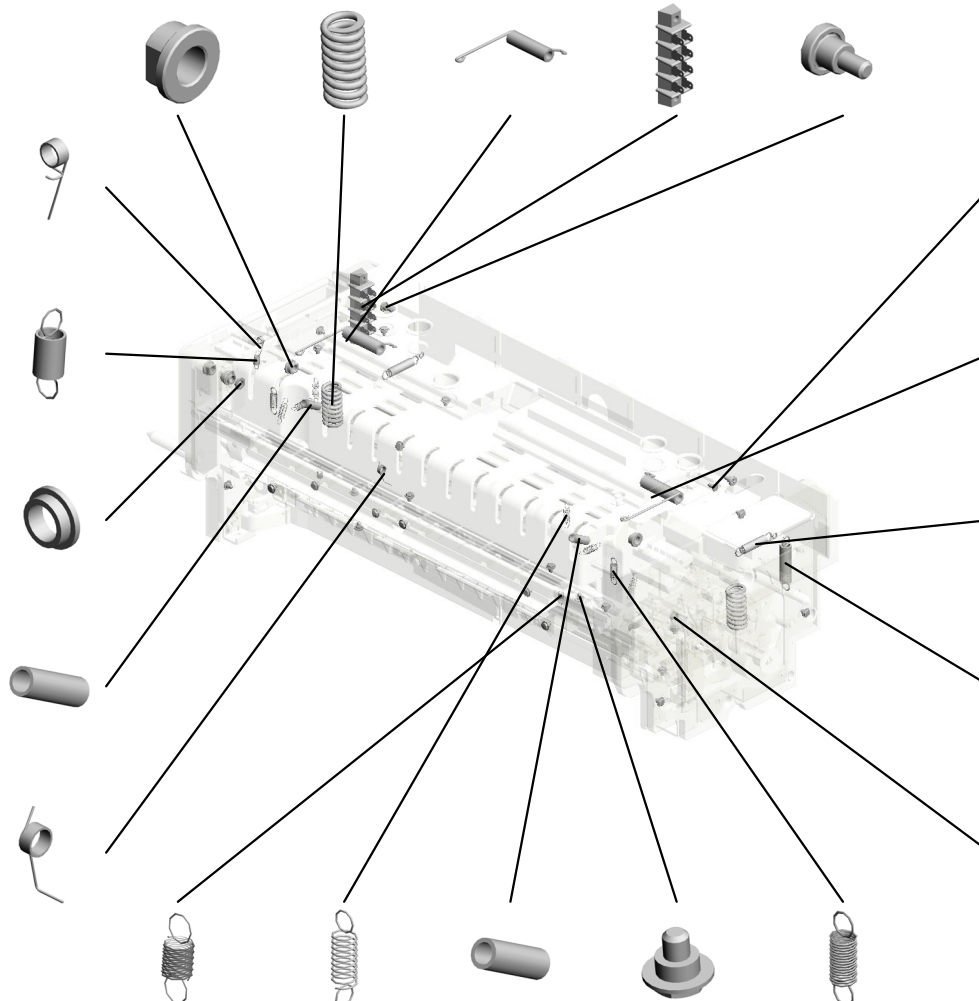

31.58942540
ARM SCREW

45.AA066686
TORSION SPRING:
LOCK:SEPARATION:FRONT:15N

37.AA062352
(x2)
TENSION SPRING:
HEAT ROLLER

36.AA061199
TENSION SPRING:
LEVER:PRESSURE:30N

47.AA066689
TORSION SPRING:
DUCT:FRONT

32.AA061115 (x2)
TENSION SPRING:
0.4N

33.AA061116 (x6)
TENSION SPRING:
STRIPPER PLATE:
2N

41.AA063724
COMPRESSION SPRING:
RING:ROLLER:POLISH

56.AA143520 (x24)
SHOULDER SCREW - M3

34.AA061117 (x2)
TENSION SPRING:
STRIPPER PLATE

U015_S003
 (-AA,-EU,-CHN):FUSING UNIT:230V:ASS'Y

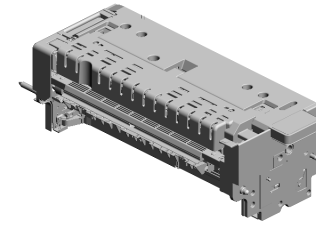

250.D1944031
 [A]
 (-AA,-EU,-CHN):FU
 SING UNIT:230V:A
 SS'Y
 201609-01 O/O

58.AA143885 (x2) STEPPED SCREW: M3
 68.AB012203 GEAR:DRIVE:ROLL ER:FUSING:B
 81.AW010147 PHOTO REFLECTI ON SENSOR
 73.AE010122 **HOT ROLLER: DIA5 4**
 74.AE012044 HEAT ROLLER: DIA 40

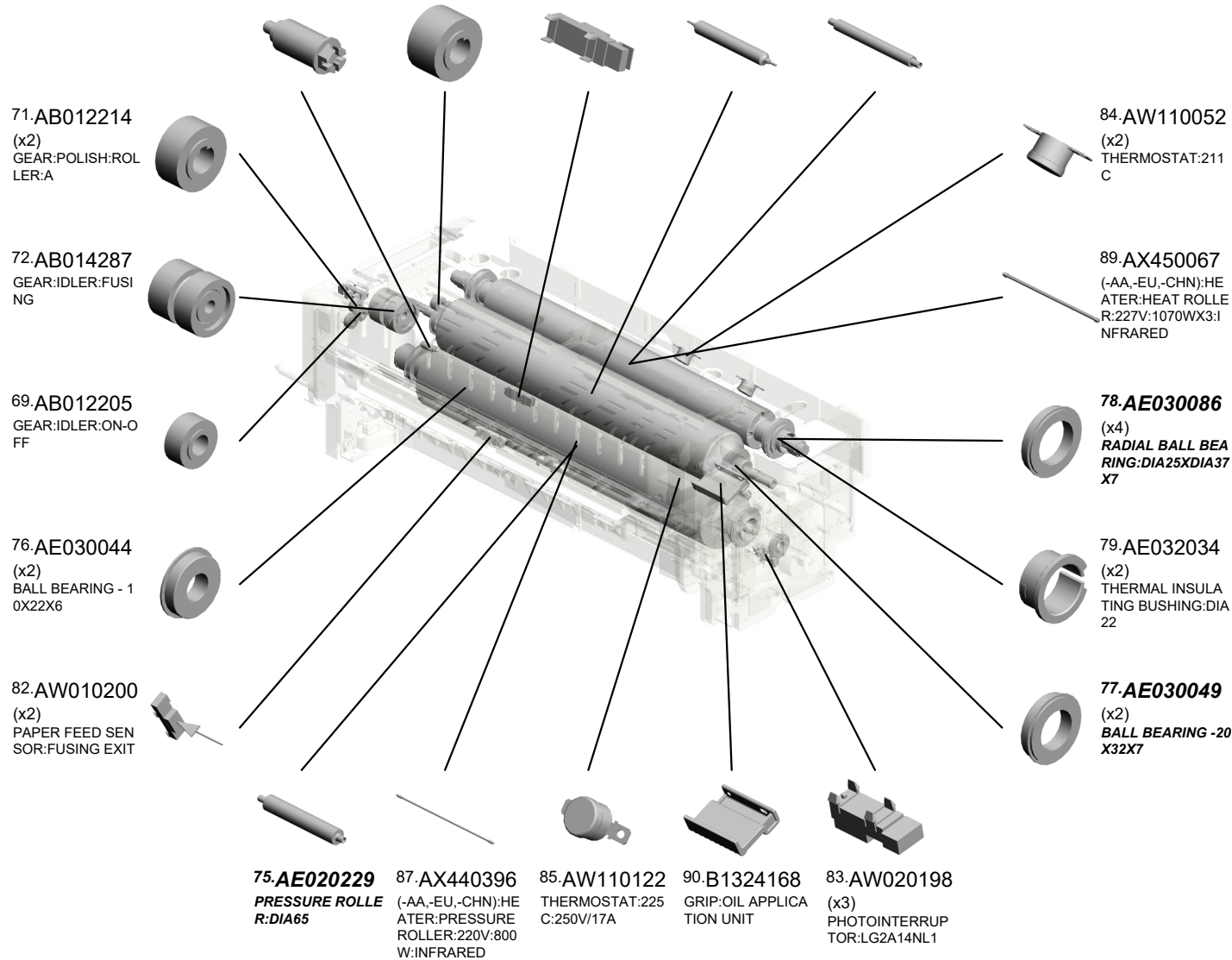

U001	U002	U003	U004	U005	U006	U007	U008	U009	U010	U011	U012	U013	U014	U015	U016	U017	U018	U019	U020	U021
------	------	------	------	------	------	------	------	------	------	------	------	------	------	-------------	------	------	------	------	------	------

U015_S003
 (-AA,-EU,-CHN):FUSING UNIT:230V:ASS'Y

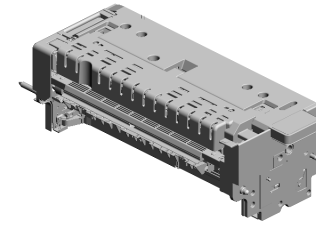

250.D1944031
 [A]
 (-AA,-EU,-CHN):FU
 SING UNIT:230V:A
 SS'Y
 201609-01 O/O

91.B1324197 TORSION SPRING: LEVER
 95.B8722614 (x6) BUSHING:R1
 100.BB013038 GEAR:HOT ROLLE R:ASS'Y
 92.B1324313 (x2) PRESSURE SPRIN G HOLDER
 105.D0744009 (x4) HOLDER:M5

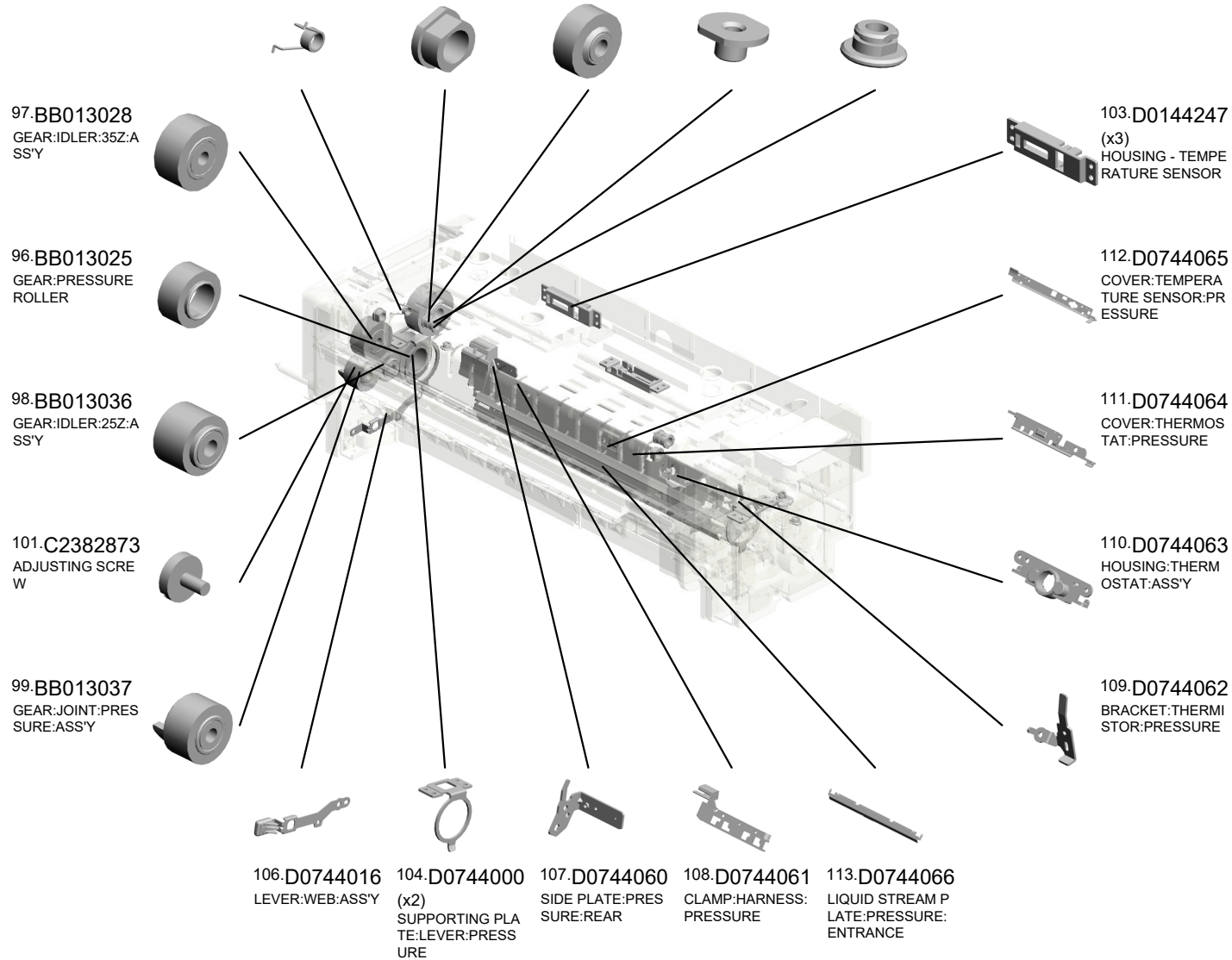

U015_S003
 (-AA,-EU,-CHN):FUSING UNIT:230V:ASS'Y

- 124.D0744100 COVER:BASE:ID
- 122.D0744098 COVER:TERMINAL:CONNECTING
- 123.D0744099 COVER:HARNESS:FIRST:LOWER
- 120.D0744096 TERMINAL:CONNECTING
- 121.D0744097 TAB:TERMINAL:CONNECTING

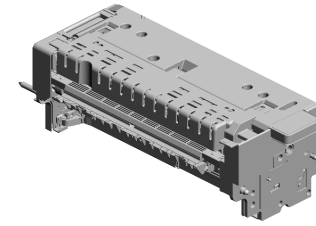

250.D1944031
 [A]
 (-AA,-EU,-CHN):FUSING UNIT:230V:ASS'Y
 201609-01 O/O

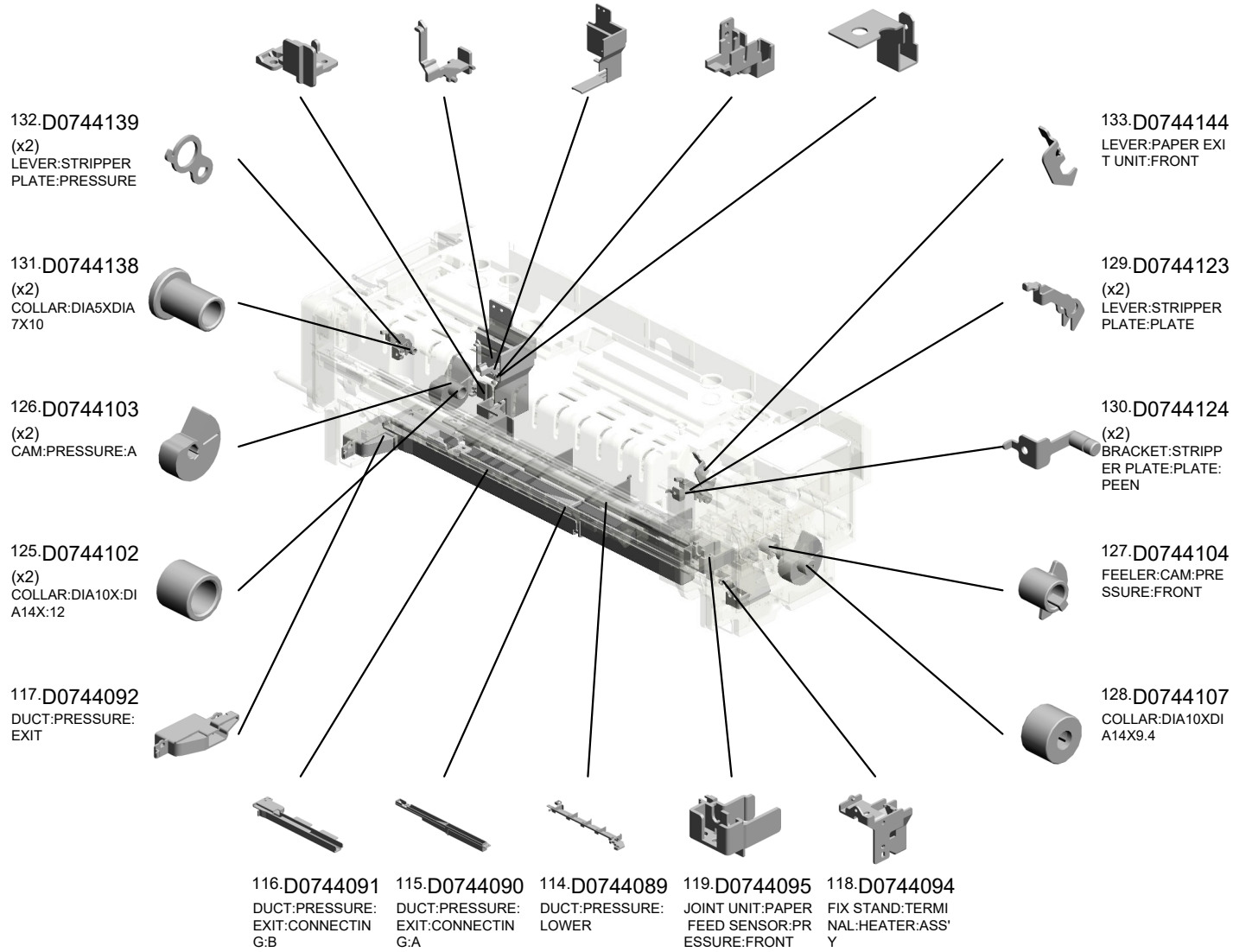

U015_S003
 (-AA,-EU,-CHN):FUSING UNIT:230V:ASS'Y

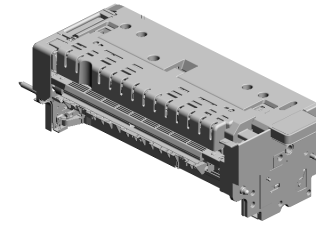

250.D1944031
 [A]
 (-AA,-EU,-CHN):FU
 SING UNIT:230V:A
 SS'Y
 201609-01 O/O

154.D0744284 GRIP:FUSING UNIT :REAR:FIBER
 149.D0744269 PIN:HANDLE:COVE R
 146.D0744264 BRACKET:DRAWE R
 153.D0744283 COVER:DRAWER: UPPER
 135.D0744172 COVER:HARNES: FIRST

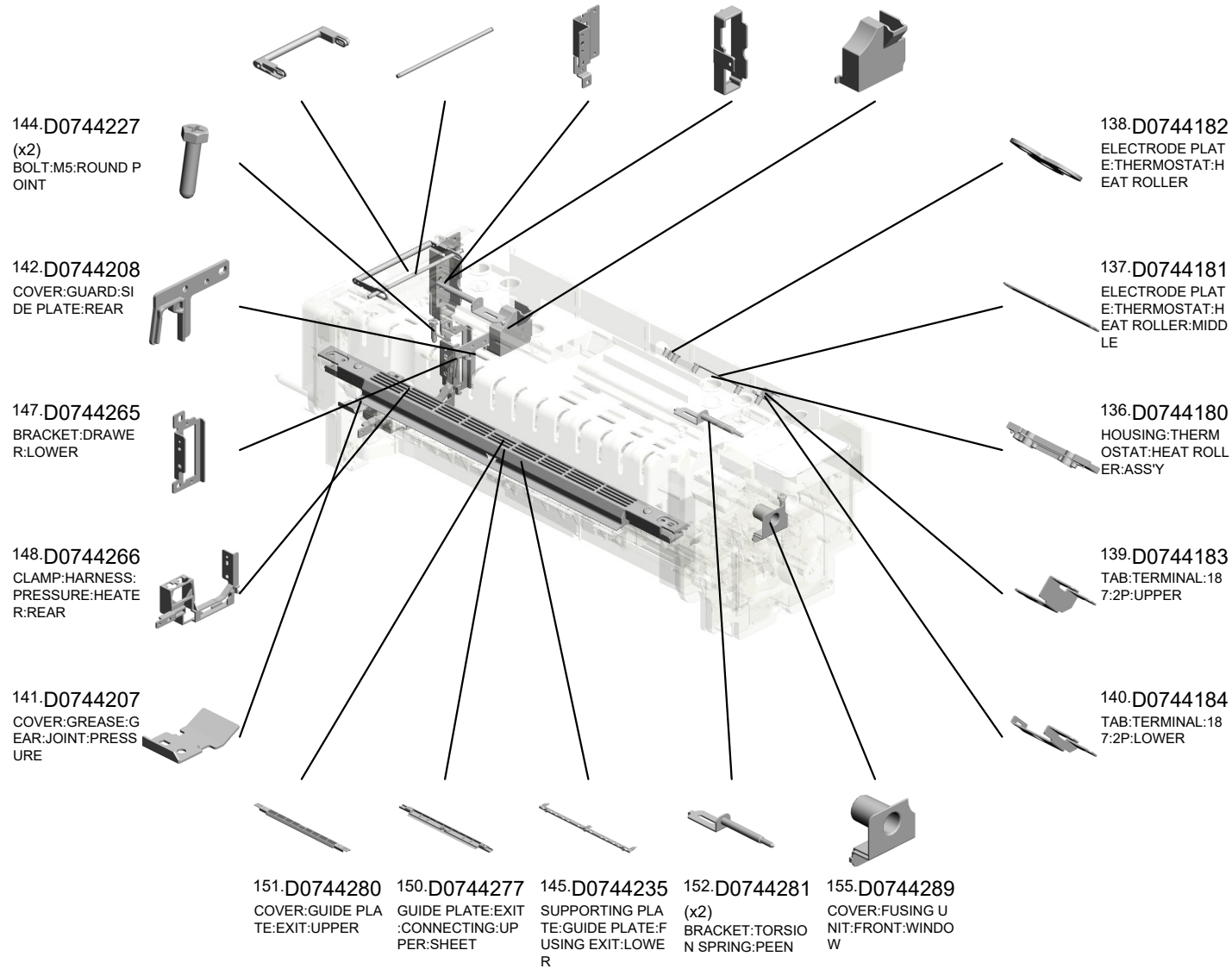

U015_S003
 (-AA,-EU,-CHN):FUSING UNIT:230V:ASS'Y

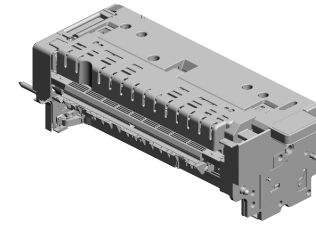

250.D1944031
 [A]
 (-AA,-EU,-CHN):FU
 SING UNIT:230V:A
 SS'Y
 201609-01 O/O

204.D1944195 HEATER HOLDER:
HEAT ROLLER:RE
AR
 195.D1944175 DISCHARGE BRUS
H:HEAT ROLLER
 200.D1944185 (x2)
RING:GUIDE:HEAT
ROLLER:DIA40
 197.D1944179 HOLDER:THERMIS
TOR:HEAT ROLLE
R:REAR
 191.D1944143 SHAFT:SEPARATI
ON SUB-UNIT

206.D1944197
HEATER HOLDER:
PRESSURE:REAR

189.D1944106
JOINT:CAM:PRESS
URE

180.D0745414
PCB:TCRU-IDB

188.D1944105
FEELER:CAM:PRE
SSURE:REAR

185.D1944068
GUIDE PLATE:FUSI
NG EXIT:LOWER:C
ONNECTING:ASS'Y

194.D1944173
DUCT:PRESSURE:
UPPER

187.D1944101
SHAFT:CAM:PRES
SURE

199.D1944184
FUSING ENTRANC
E GUIDE PLATE:LO
WER

177.D0744381
DECAL:FUSING UN
IT:POSITIONING

207.D1944198
HEATER HOLDER:
PRESSURE:FRON
T

192.D1944158
FUSING ENTRANC
E GUIDE PLATE:U
PPER:FIBER

198.D1944180
FLAT BELT-FUSIN
G:DIA80:SEAL

205.D1944196
HEATER HOLDER:
HEAT ROLLER:FR
ONT

202.D1944189
DISCHARGE BRUS
H:PRESSURE ROL
LER

196.D1944176
SIDE PLATE:PRES
SURE:ELECTRICA
L COMPONENTS:F
RONT



U015_S003

(-AA,-EU,-CHN):FUSING UNIT:230V:ASS'Y

- 219.D1944268 BRACKET:GRIP:REAR 201509-05 X/O
- 216.D1944242 (x2) CAM:ON-OFF
- 225.D1944311 SHAFT:DRIVE:POLISH
- 214.D1944234 (x2) LEVER:ON-OFF:B:PEEN
- 213.D1944232 (x2) LEVER:ON-OFF:A:PEEN

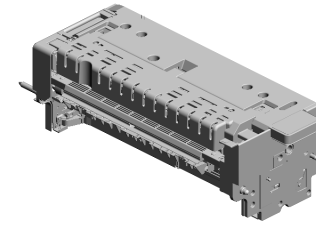

250.D1944031
[A]
 (-AA,-EU,-CHN):FUSING UNIT:230V:ASS'Y
 201609-01 O/O

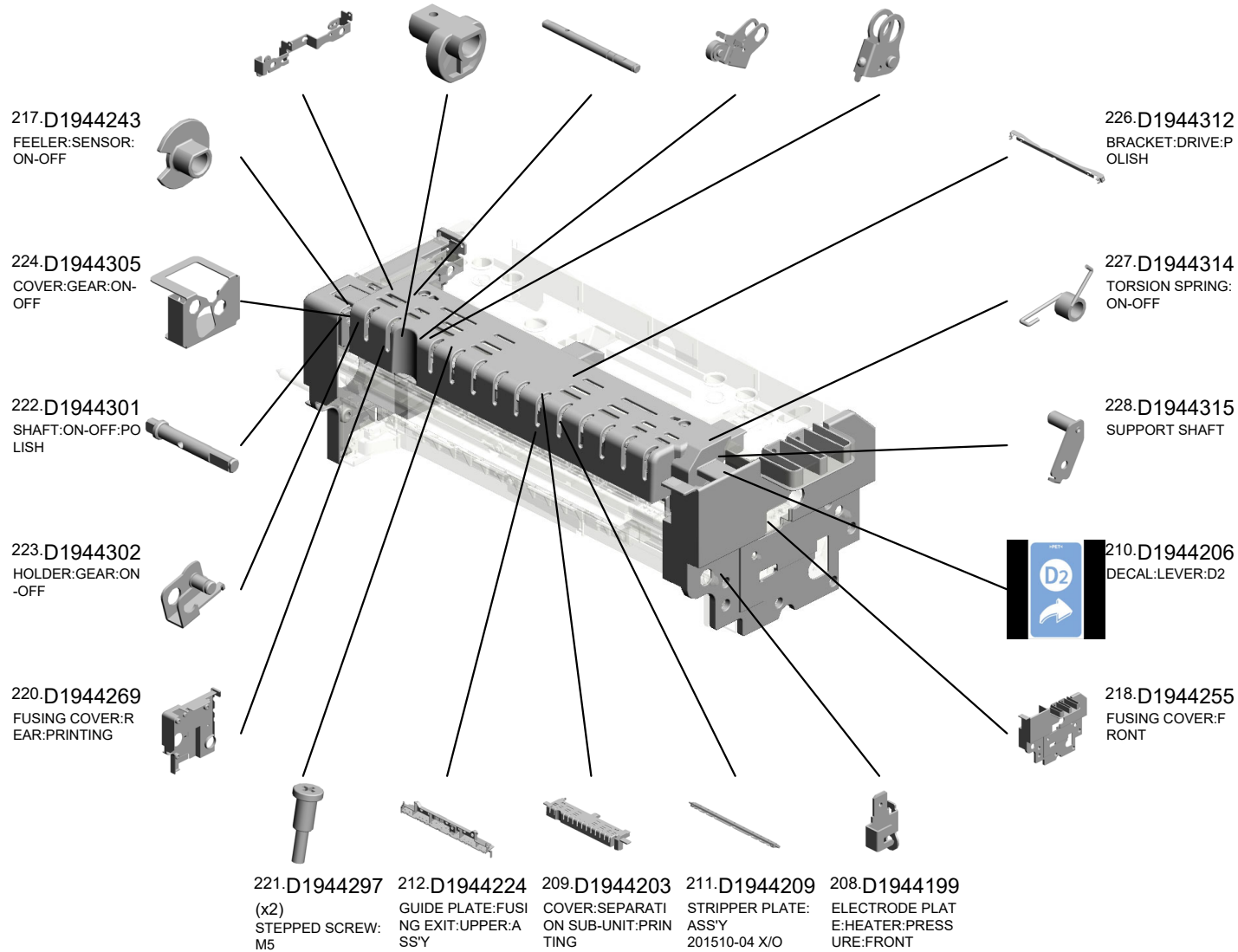

U001	U002	U003	U004	U005	U006	U007	U008	U009	U010	U011	U012	U013	U014	U015	U016	U017	U018	U019	U020	U021
------	------	------	------	------	------	------	------	------	------	------	------	------	------	------	------	------	------	------	------	------

U015_S003
 (-AA,-EU,-CHN):FUSING UNIT:230V:ASS'Y

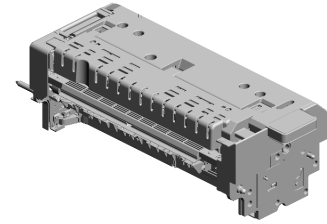

250.D1944031
 [A]
 (-AA,-EU,-CHN):FU
 SING UNIT:230V:A
 SS'Y
 201609-01 O/O

241.GA082007 PLAIN SHAFT BEARING:4XDIA6DIA8
 245.D1949905 FUSING BRACKET SET:201704-07
 230.D1944319 STOPPER:RADIAL BALL BEARING:DIA 10
 255.D0A53994 LEVER:PAPER EXIT UNIT:REAR:201710-02 O/O
 229.D1944318 STOPPER:RADIAL BALL BEARING

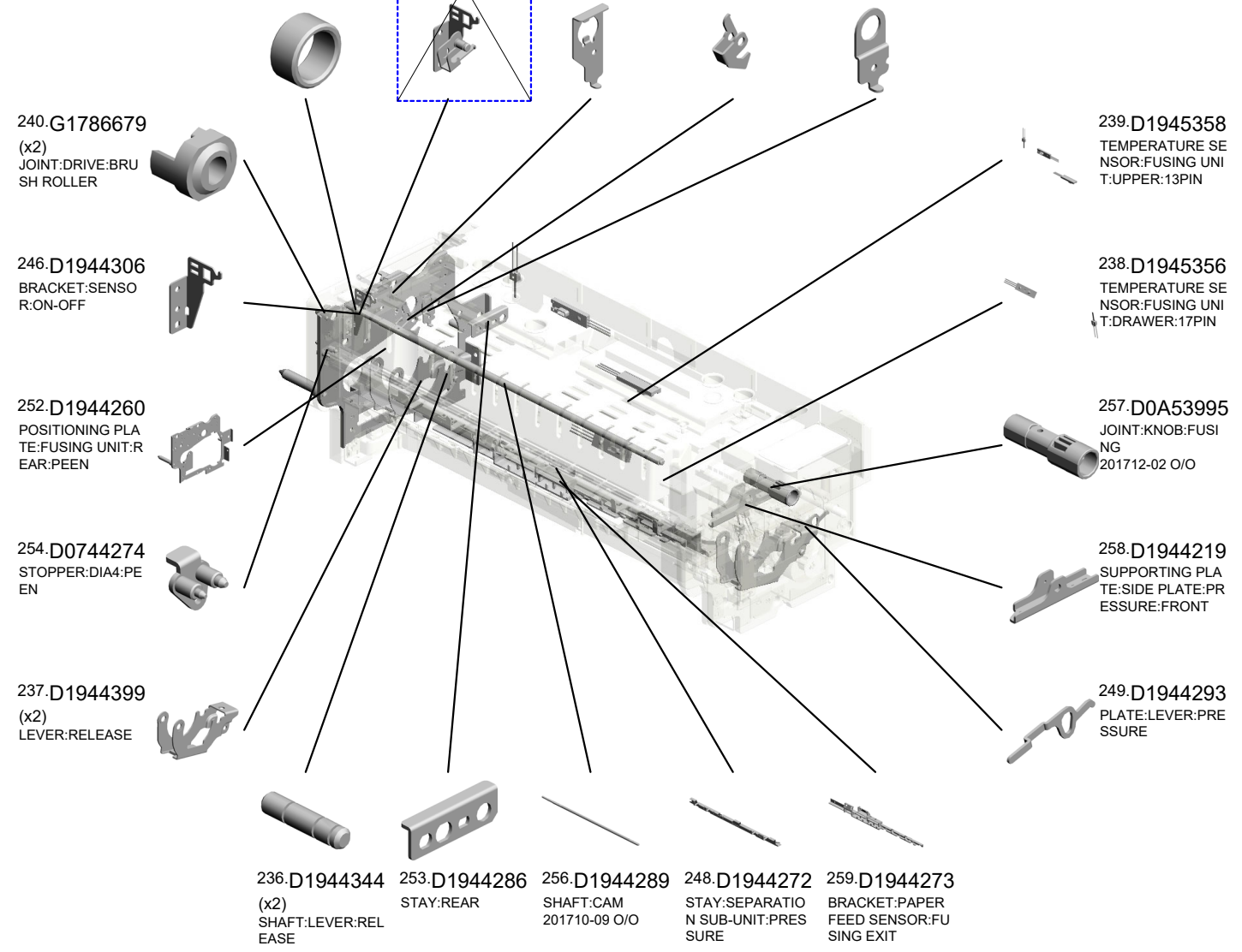

U001	U002	U003	U004	U005	U006	U007	U008	U009	U010	U011	U012	U013	U014	U015	U016	U017	U018	U019	U020	U021
------	------	------	------	------	------	------	------	------	------	------	------	------	------	------	------	------	------	------	------	------

U015_S003
 (-AA,-EU,-CHN):FUSING UNIT:230V:ASS'Y

266.D1944220 SUPPORTING PLATE:SIDE PLATE:PRESSURE:REAR
 265.D1944150 SIDE PLATE:FUSING:REAR:PEEN
 270.D1944188 STAY:PRESSURE SUB-UNIT:ENTRANCE

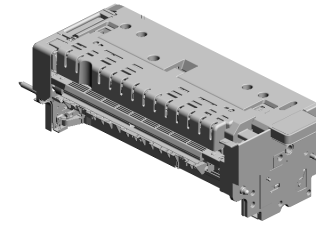

250.D1944031
 [A]
 (-AA,-EU,-CHN):FUSING UNIT:230V:ASS'Y
 201609-01 O/O

268.D1944271
 (x2)
 HEXAGON HEAD SCREW:ADHESIVE:
 M3X5
 201901-04 X/O

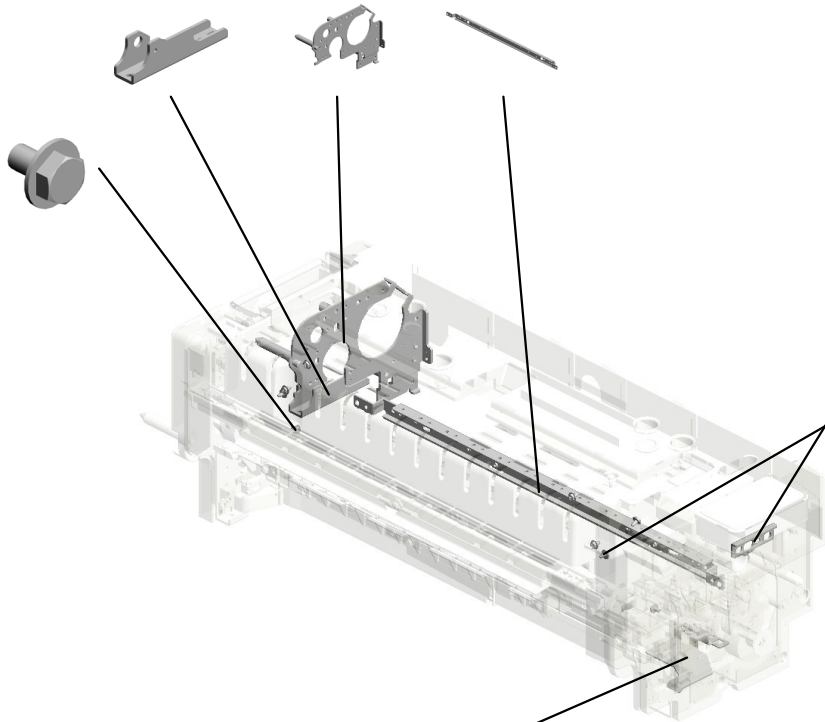

262.D1944285
 STAY:FRONT

271.D2051082
 (x7)
 HEXAGON HEAD SCREW:ROUND POINT:
 M3X6:BLACK
 202105-07 X/O

272.D0A54090
 BRACKET:PHOTO INTERRUPTOR:FRONT
 202208-02 X/O

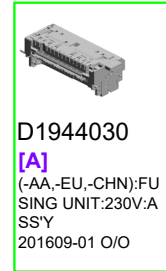

D1944030
 [A]
 (-AA,-EU,-CHN):FUSING UNIT:230V:ASS'Y
 201609-01 O/O

U001	U002	U003	U004	U005	U006	U007	U008	U009	U010	U011	U012	U013	U014	U015	U016	U017	U018	U019	U020	U021
------	------	------	------	------	------	------	------	------	------	------	------	------	------	------	------	------	------	------	------	------

U015_S003_S001
FUSING COVER:UPPER:SUB-ASS'Y

201.D1944186
DECAL:WARNING (REMOVAL AND INSTALLATION);FUSING

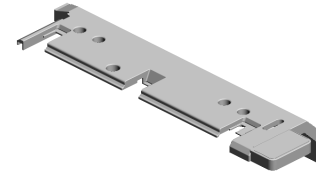
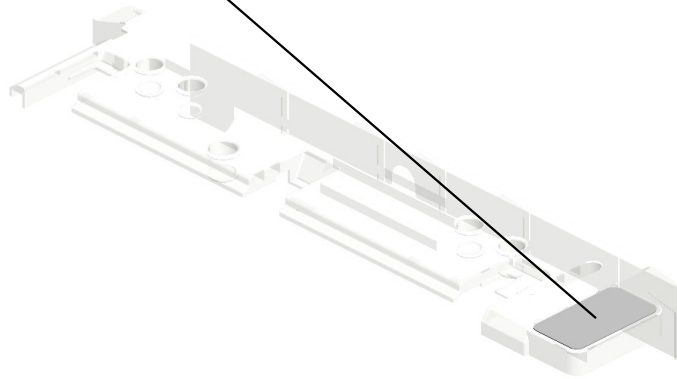

203.D1944190
FUSING COVER:UPPER:SUB-ASS'Y

U001	U002	U003	U004	U005	U006	U007	U008	U009	U010	U011	U012	U013	U014	U015	U016	U017	U018	U019	U020	U021
------	------	------	------	------	------	------	------	------	------	------	------	------	------	------	------	------	------	------	------	------

U015_S003_S002
GUIDE PLATE:FUSING EXIT:LOWER:NO.2:ASS'Y

264.D0894252
(x4)
GUIDE:FUSING EXI
T:PFA

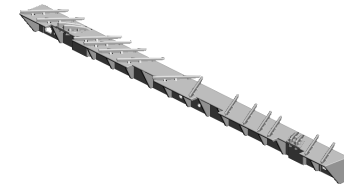

247.D1944066
GUIDE PLATE:FUSI
NG EXIT:LOWER:N
O.2:ASSY

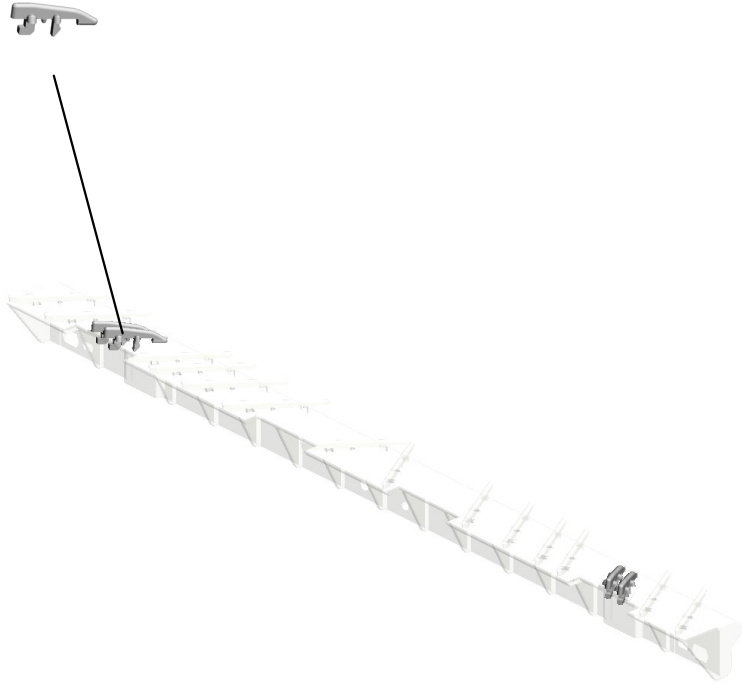

U001	U002	U003	U004	U005	U006	U007	U008	U009	U010	U011	U012	U013	U014	U015	U016	U017	U018	U019	U020	U021
------	------	------	------	------	------	------	------	------	------	------	------	------	------	------	------	------	------	------	------	------

U015_S003_S003

PRESSURE SUB-UNIT:STRIPPER PLATE:ASS'Y

4.03603006N 264.D0894252
(x24) (x13)
SCREW - M3X6 GUIDE:FUSING EXI
T:PFA

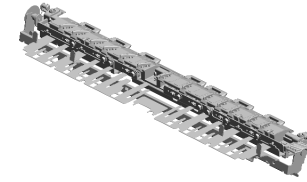

186.D1944074
PRESSURE SUB-U
NIT:STRIPPER PLA
TE:ASS'Y

19.08046123
HEXAGONAL BOLT
:W/WASHER:M3X8

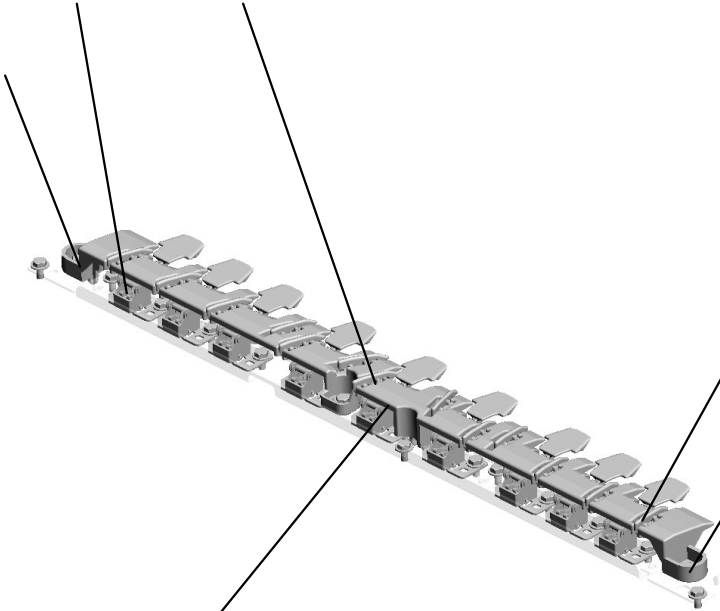

261.D1944115
(x9)
SERVICE PARTS:P
ICKOFF PAWL:PRE
SSURE ROLLER:A
SS'Y



56.AA143520
(x2)
SHOULDER SCRE
W - M3



269.D1944279
GUIDE PLATE:SEP
ARATION SUB-UNI
T:PRESSURE



U001	U002	U003	U004	U005	U006	U007	U008	U009	U010	U011	U012	U013	U014	U015	U016	U017	U018	U019	U020	U021
------	------	------	------	------	------	------	------	------	------	------	------	------	------	------	------	------	------	------	------	------

U015_S004
(-NA):FUSING UNIT:208V:ASS'Y

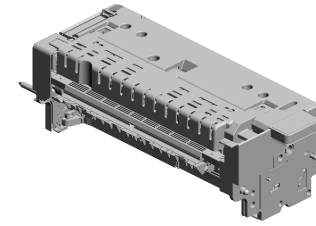

251-D1944021
[A]
(-NA):FUSING UNIT
:208V:ASS'Y
201701-01 O/O

10.07200040E (x18) RETAINING RING - M4
18.07433906 RADIAL BALL BEARING: DIA6X DIA15X5
27.11050723 CLAMPS: WES-050 7
29.11050744 (x3) CLAMP: F-LWS-071 1
22.09543010N (x2) SCREW: POLISHED ROUND/SPRING: M3X10

15.07403706 BALL BEARING - M6X10X3

11.07200060E (x15) RETAINING RING - M6

9.07200030E (x4) RETAINING RING - M3

14.07250250E (x2) RETAINING RING C - M25

19.08046123 (x63) HEXAGONAL BOLT :W/WASHER: M3X8

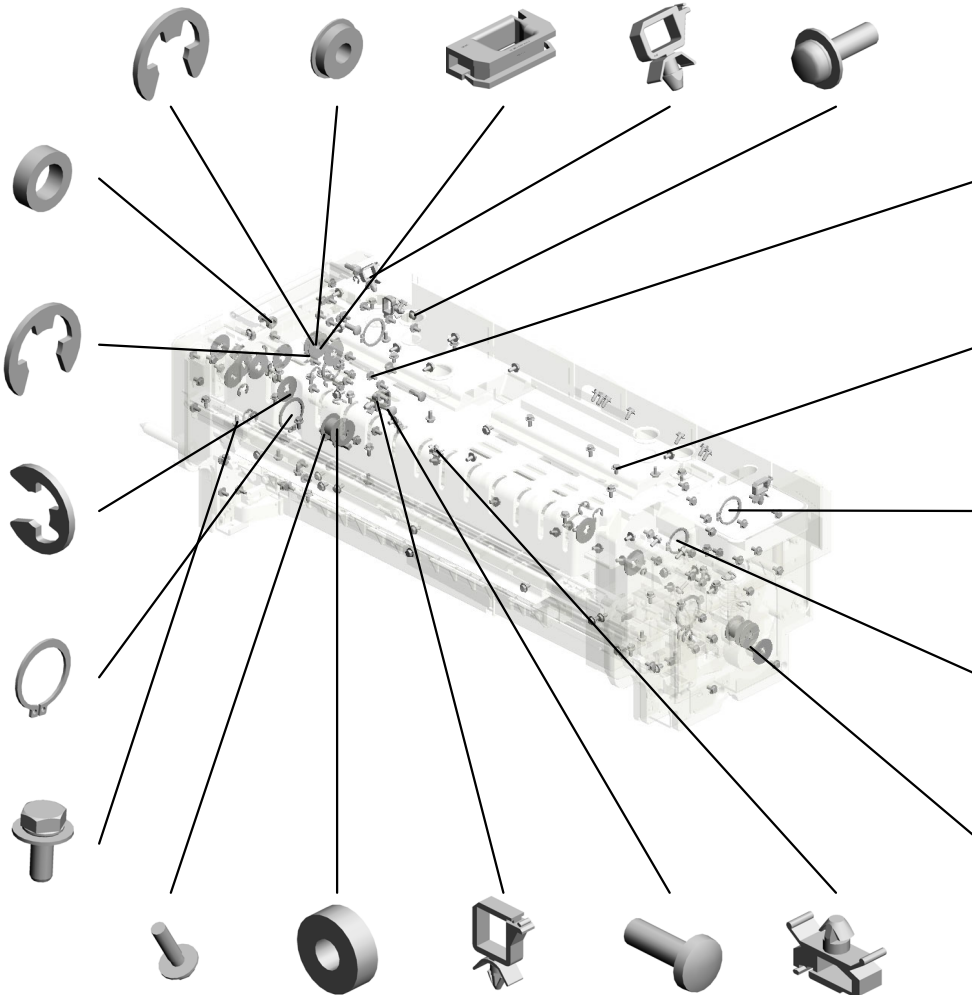

4.03603006N (x87) SCREW - M3X6

3.03603005P (x2) SCREW: M3X5

13.07250220E (x2) RETAINING RING - M22

12.07250200E (x2) RETAINING RING C - M20

21.09300404A (x2) PARALLEL KEY: 4X4X25

23.09543012N SCREW - M3X12
16.07403906 (x4) BALL BEARING - 6X15X5
24.11050488 HARNESS CLAMP
2.03540120N (x4) SCREW M4X12
26.11050713 (x3) CLAMP: LWSM-030 6H GRAY

U001	U002	U003	U004	U005	U006	U007	U008	U009	U010	U011	U012	U013	U014	U015	U016	U017	U018	U019	U020	U021
------	------	------	------	------	------	------	------	------	------	------	------	------	------	------	------	------	------	------	------	------

U015_S004
(-NA):FUSING UNIT:208V:ASS'Y

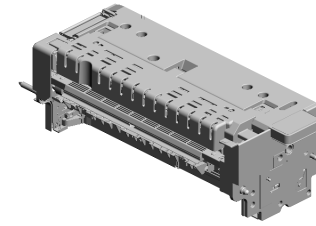

251.D1944021
[A]
(-NA):FUSING UNIT
:208V:ASS'Y
201701-01 O/O

- 54.AA082101 (x4) BUSHING - 6X10X6
- 42.AA064004 (x2) COMPRESSION SP RING:PRESSURE:3 75N
- 46.AA066687 TORSION SPRING: LOCK:SEPARATIO N:REAR:15N
- 55.AA113037 TERMINAL:4P:187
- 57.AA143847 (x2) STEPPED SCREW: DIA5:3.5:M3

49.AA066691
TORSION SPRING: GRIP

35.AA061164
TENSION SPRING: GEAR:ON-OFF

50.AA080247
(x2)
BUSHING - B-F6-3

40.AA063484
COMPRESSION SP RING:ROLLER:POL ISH:REAR

48.AA066690
TORSION SPRING: DUCT:REAR

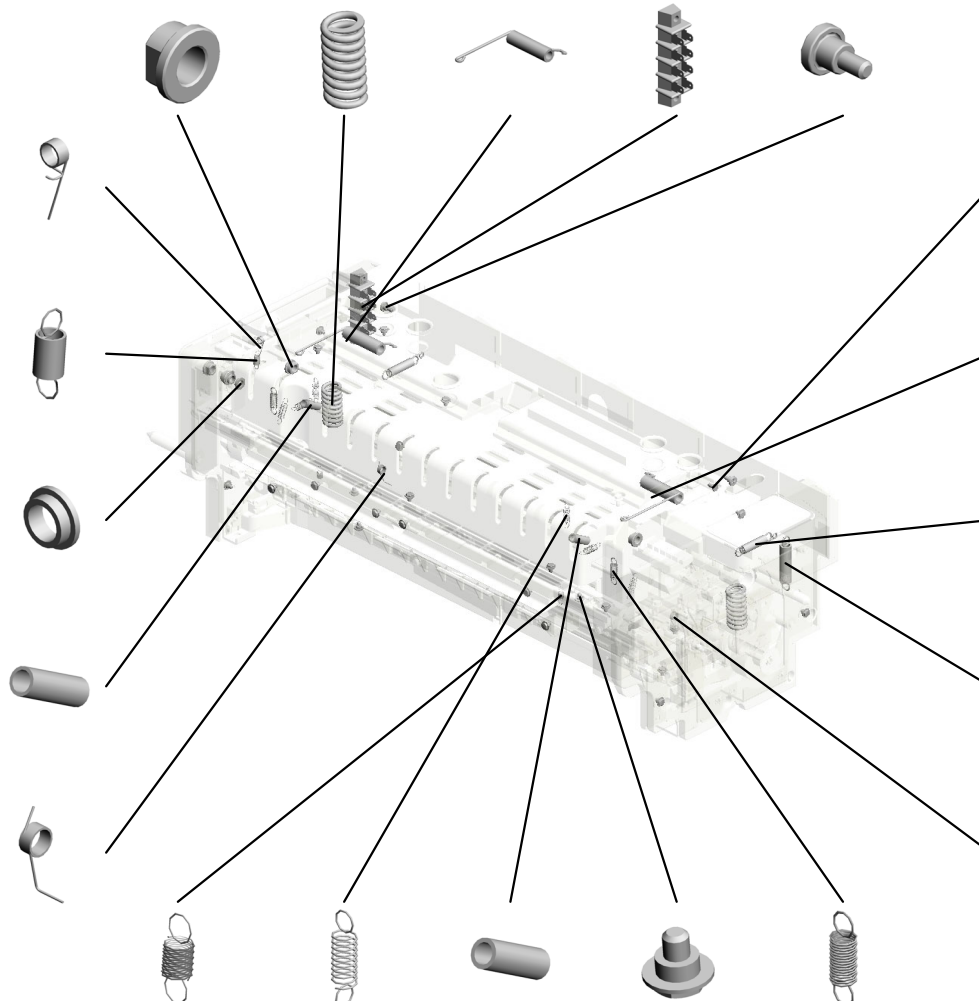

31.58942540
ARM SCREW

45.AA066686
TORSION SPRING: LOCK:SEPARATIO N:FRONT:15N

37.AA062352
(x2)
TENSION SPRING: HEAT ROLLER

36.AA061199
TENSION SPRING: LEVER:PRESSURE :30N

47.AA066689
TORSION SPRING: DUCT:FRONT

32.AA061115
(x2)
TENSION SPRING: 0.4N

33.AA061116
(x6)
TENSION SPRING: STRIPPER PLATE: 2N

41.AA063724
COMPRESSION SP RING:ROLLER:POL ISH

56.AA143520
(x24)
SHOULDER SCRE W - M3

34.AA061117
(x2)
TENSION SPRING: STRIPPER PLATE: PLATE

U015_S004
(-NA):FUSING UNIT:208V:ASS'Y

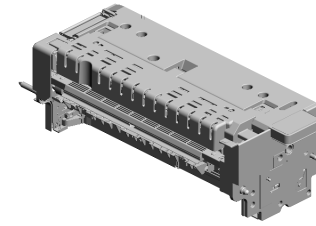

251.D1944021
[A]
(-NA):FUSING UNIT
:208V:ASS'Y
201701-01 O/O

58.AA143885 (x2) STEPPED SCREW: M3
68.AB012203 GEAR:DRIVE:ROLL ER:FUSING:B
81.AW010147 PHOTO REFLECTI ON SENSOR
73.AE010122 **HOT ROLLER: DIA5 4**
74.AE012044 HEAT ROLLER: DIA 40

71.AB012214 (x2) GEAR:POLISH:ROL LER:A

72.AB014287 GEAR:IDLER:FUSI NG

69.AB012205 GEAR:IDLER:ON-O FF

76.AE030044 (x2) BALL BEARING - 1 0X22X6

82.AW010200 (x2) PAPER FEED SEN SOR:FUSING EXIT

84.AW110052 (x2) THERMOSTAT:211 C

88.AX450066 (-NA):HEATER:HEA T ROLLER:205V:99 7WX3:INFRARED

78.AE030086 (x4) **RADIAL BALL BEA RING: DIA25XDIA37 X7**

79.AE032034 (x2) THERMAL INSULA TING BUSHING: DIA 22

77.AE030049 (x2) **BALL BEARING -20 X32X7**

75.AE020229 **PRESSURE ROLLER: DIA65**
86.AX440395 (-NA):HEATER:PRE SSURE ROLLER:20 8V:800W:INFRARE D
85.AW110122 THERMOSTAT:225 C:250V/17A
90.B1324168 GRIP:OIL APPLICA TION UNIT
83.AW020198 (x3) PHOTOINTERRUP TOR:LG2A14NL1

U001	U002	U003	U004	U005	U006	U007	U008	U009	U010	U011	U012	U013	U014	U015	U016	U017	U018	U019	U020	U021
------	------	------	------	------	------	------	------	------	------	------	------	------	------	------	------	------	------	------	------	------

U015_S004
(-NA):FUSING UNIT:208V:ASS'Y

- 91.B1324197 TORSION SPRING: LEVER
- 95.B8722614 (x6) BUSHING:R1
- 100.BB013038 GEAR:HOT ROLLER:ASS'Y
- 92.B1324313 (x2) PRESSURE SPRING HOLDER
- 105.D0744009 (x4) HOLDER:M5

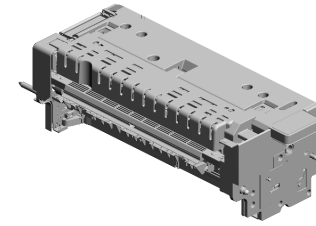

251.D1944021
[A]
(-NA):FUSING UNIT
:208V:ASS'Y
201701-01 O/O

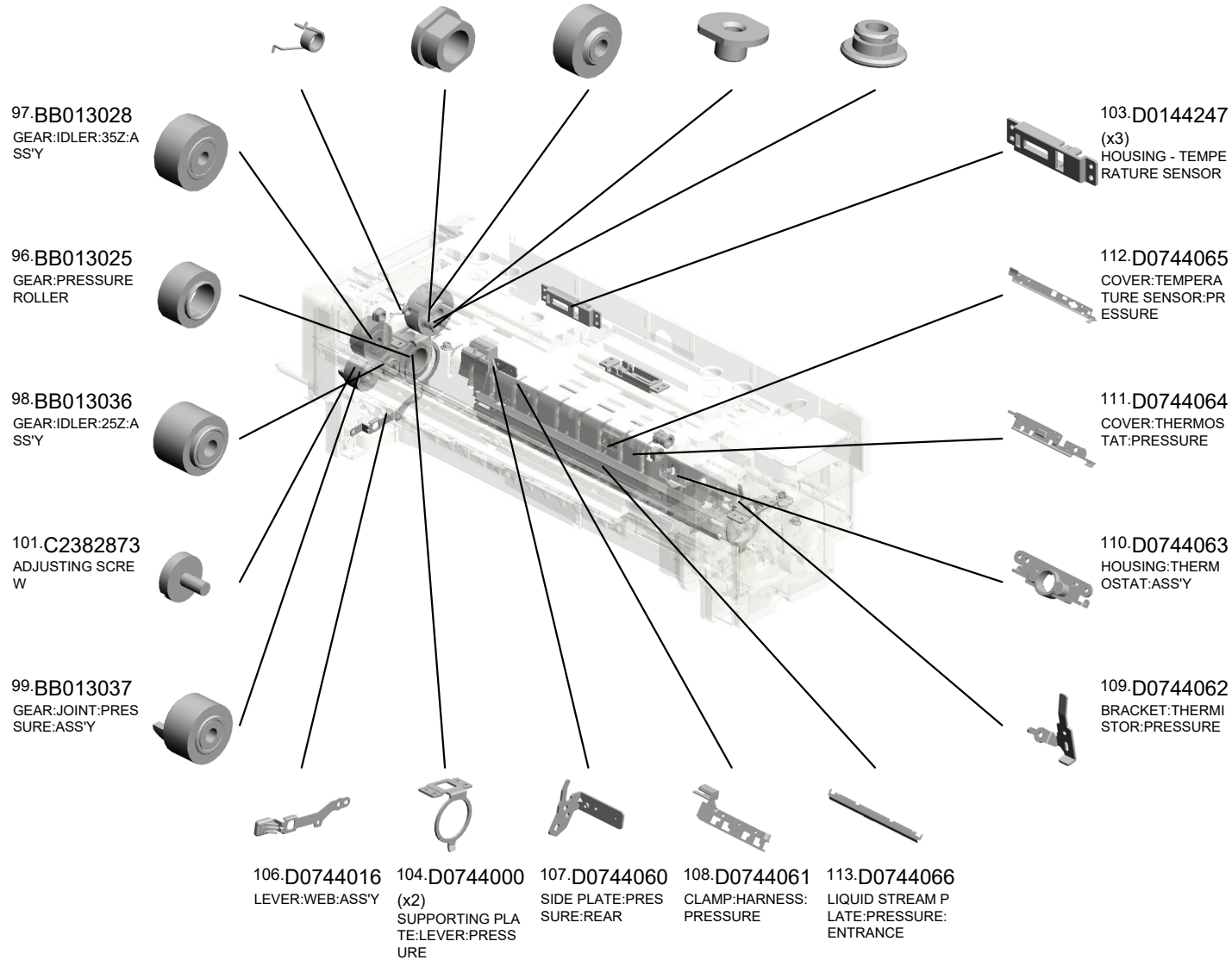

U015_S004
(-NA):FUSING UNIT:208V:ASS'Y

124.D0744100 COVER:BASE:ID
122.D0744098 COVER:TERMINAL:CONNECTING
123.D0744099 COVER:HARNESS:FIRST:LOWER
120.D0744096 TERMINAL:CONNECTING
121.D0744097 TAB:TERMINAL:CONNECTING

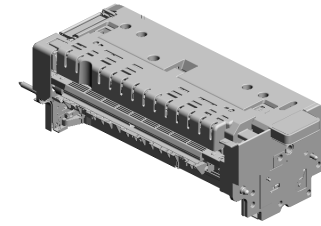

251.D1944021
[A]
(-NA):FUSING UNIT:208V:ASS'Y
201701-01 O/O

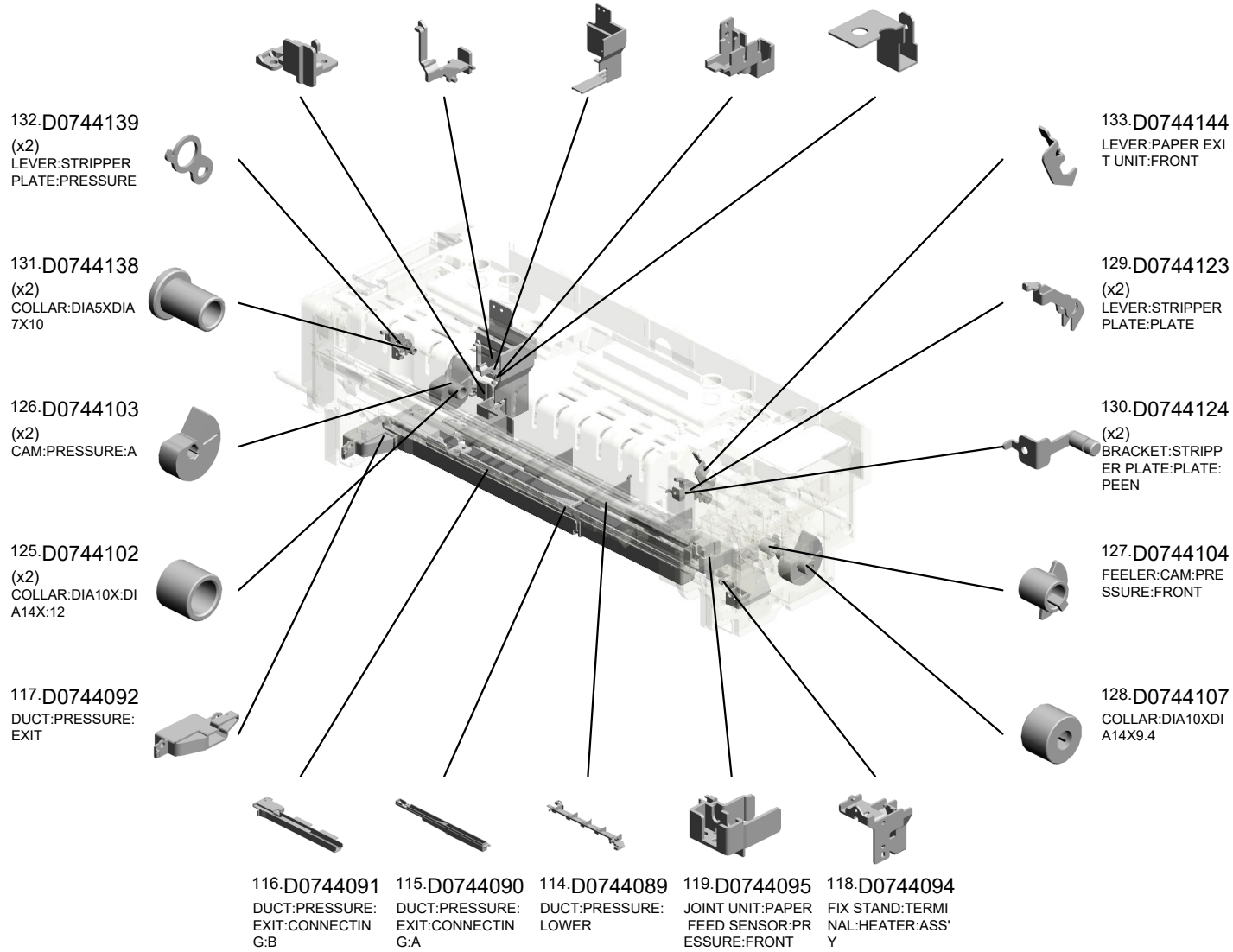

U015_S004
(-NA):FUSING UNIT:208V:ASS'Y

154.D0744284 GRIP:FUSING UNIT
:REAR:FIBER
149.D0744269 PIN:HANDLE:COVE
R
146.D0744264 BRACKET:DRAW
E R
153.D0744283 COVER:DRAWER:
UPPER
135.D0744172 COVER:HARNES
S:FIRST

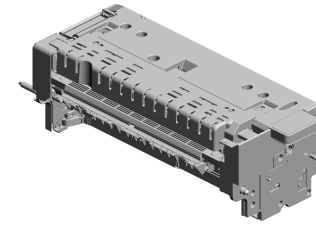

251.D1944021
[A]
(-NA):FUSING UNIT
:208V:ASS'Y
201701-01 O/O

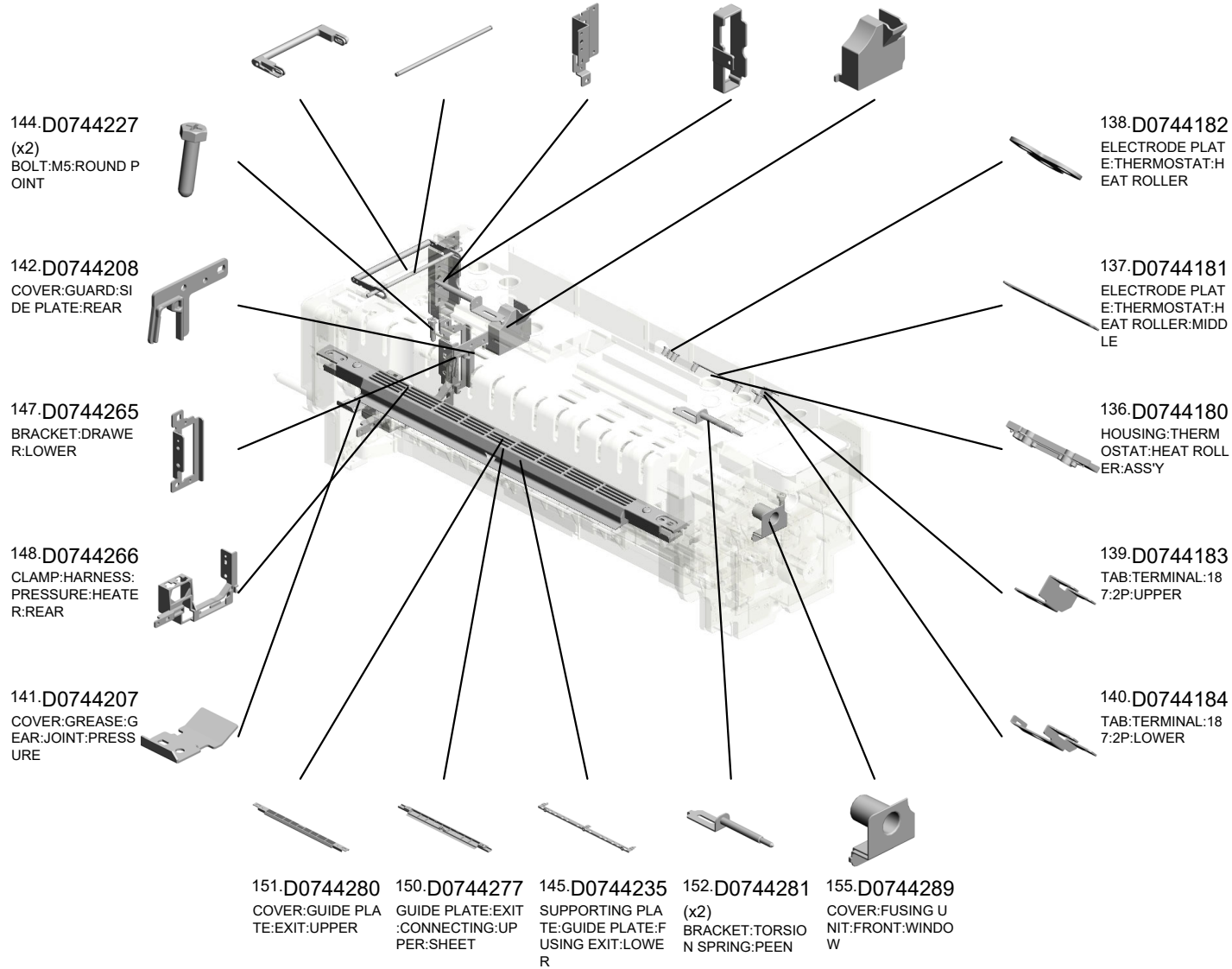

U015_S004
(-NA):FUSING UNIT:208V:ASS'Y

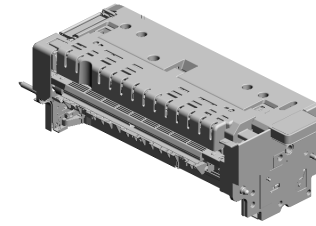

251.D1944021
[A]
(-NA):FUSING UNIT
:208V:ASS'Y
201701-01 O/O

204.D1944195 HEATER HOLDER:
HEAT ROLLER:RE
AR
195.D1944175 DISCHARGE BRUS
H:HEAT ROLLER
200.D1944185 (x2)
RING:GUIDE:HEAT
ROLLER:DIA40
197.D1944179 HOLDER:THERMIS
TOR:HEAT ROLLE
R:REAR
191.D1944143 SHAFT:SEPARATI
ON SUB-UNIT

206.D1944197
HEATER HOLDER:
PRESSURE:REAR

189.D1944106
JOINT:CAM:PRESS
URE

180.D0745414
PCB:TCRU-IDB

188.D1944105
FEELER:CAM:PRE
SSURE:REAR

185.D1944068
GUIDE PLATE:FUSI
NG EXIT:LOWER:C
ONNECTING:ASS'Y

194.D1944173
DUCT:PRESSURE:
UPPER

187.D1944101
SHAFT:CAM:PRES
SURE

199.D1944184
FUSING ENTRANC
E GUIDE PLATE:LO
WER

177.D0744381
DECAL:FUSING UN
IT:POSITIONING

207.D1944198
HEATER HOLDER:
PRESSURE:FRON
T

192.D1944158
FUSING ENTRANC
E GUIDE PLATE:U
PPER:FIBER

198.D1944180
FLAT BELT-FUSIN
G:DIA80:SEAL

205.D1944196
HEATER HOLDER:
HEAT ROLLER:FR
ONT

202.D1944189
DISCHARGE BRUS
H:PRESSURE ROL
LER

196.D1944176
SIDE PLATE:PRES
SURE:ELECTRICA
L COMPONENTS:F
RONT



U015_S004
(-NA):FUSING UNIT:208V:ASS'Y

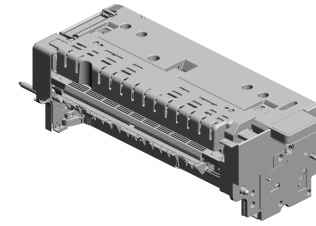

251.D1944021
[A]
(-NA):FUSING UNIT
:208V:ASS'Y
201701-01 O/O

219.D1944268 BRACKET:GRIP:RE AR 201509-05 X/O
216.D1944242 (x2) CAM:ON-OFF
225.D1944311 SHAFT:DRIVE:POLI SH
214.D1944234 (x2) LEVER:ON-OFF:B: PEEN
213.D1944232 (x2) LEVER:ON-OFF:A: PEEN

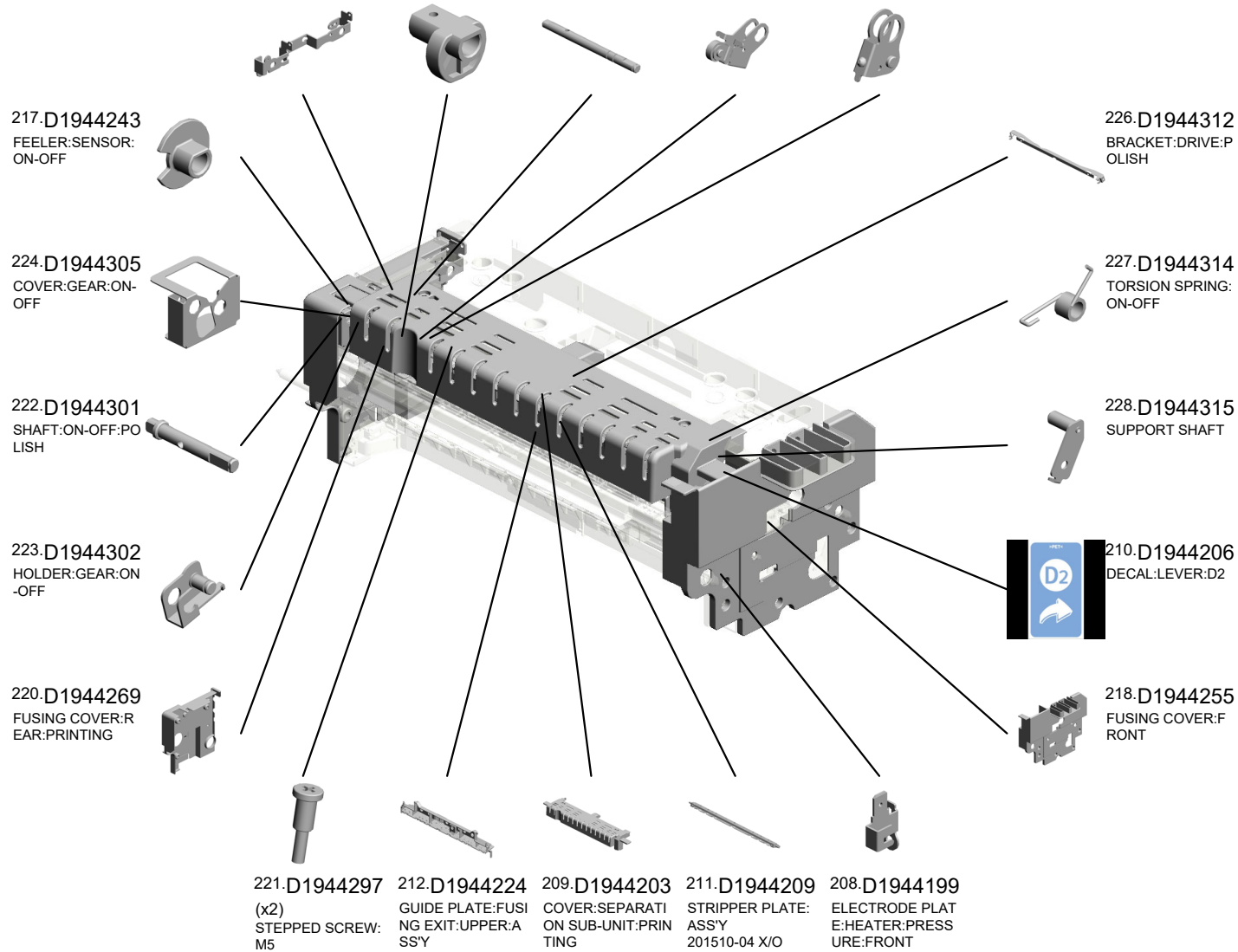

U015_S004
(-NA):FUSING UNIT:208V:ASS'Y

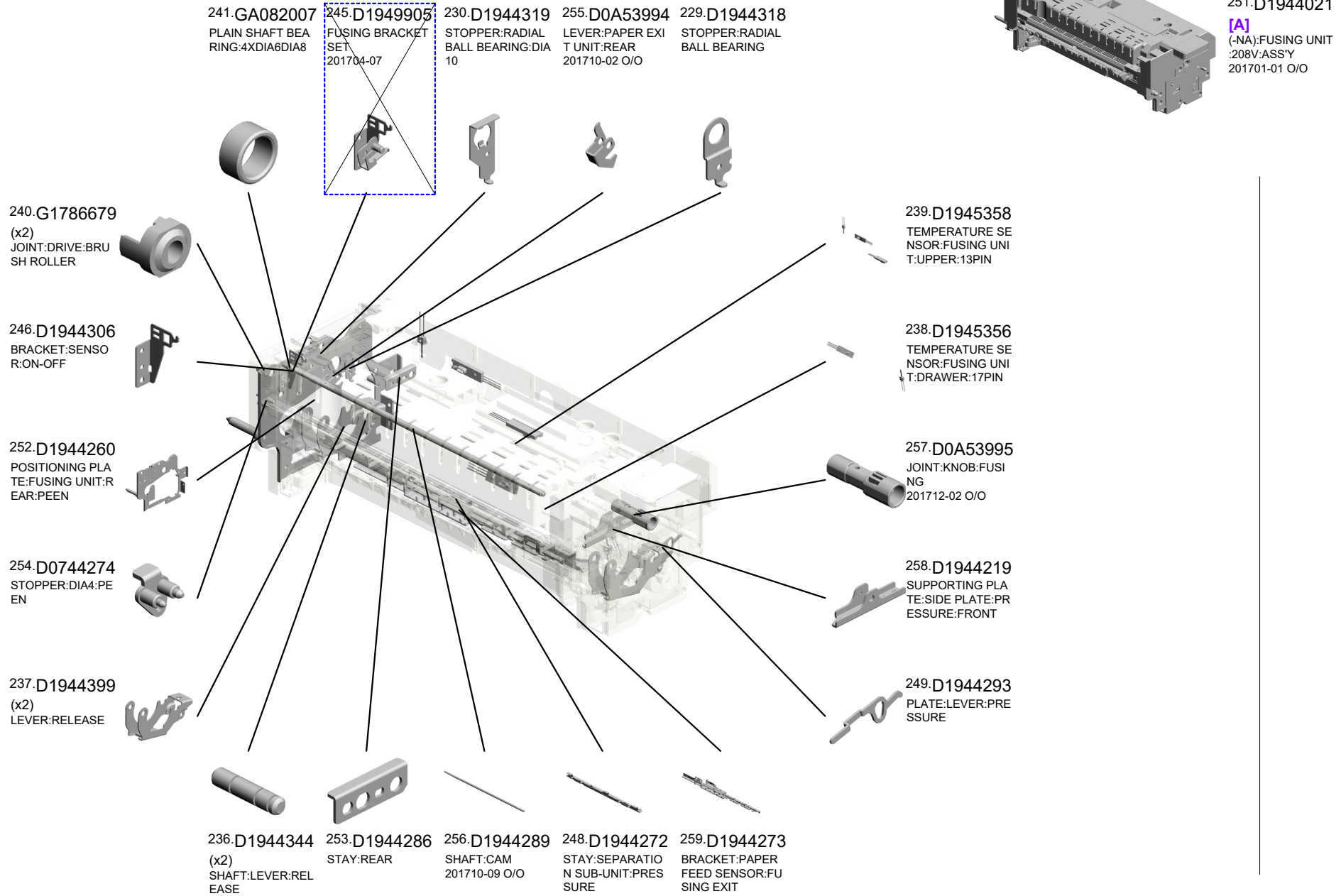

U015_S004
 (-NA):FUSING UNIT:208V:ASS'Y

266.D1944220 SUPPORTING PLATE:SIDE PLATE:PRESSURE:REAR
 265.D1944150 SIDE PLATE:FUSING:REAR:PEEN
 270.D1944188 STAY:PRESSURE SUB-UNIT:ENTRANCE

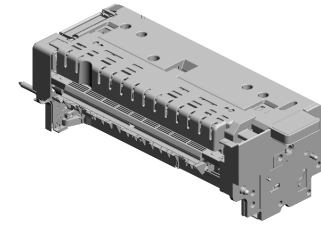

251.D1944021
 [A]
 (-NA):FUSING UNIT
 :208V:ASS'Y
 201701-01 O/O

268.D1944271
 (x2)
 HEXAGON HEAD SCREW:ADHESIVE:
 M3X5
 201901-04 X/O

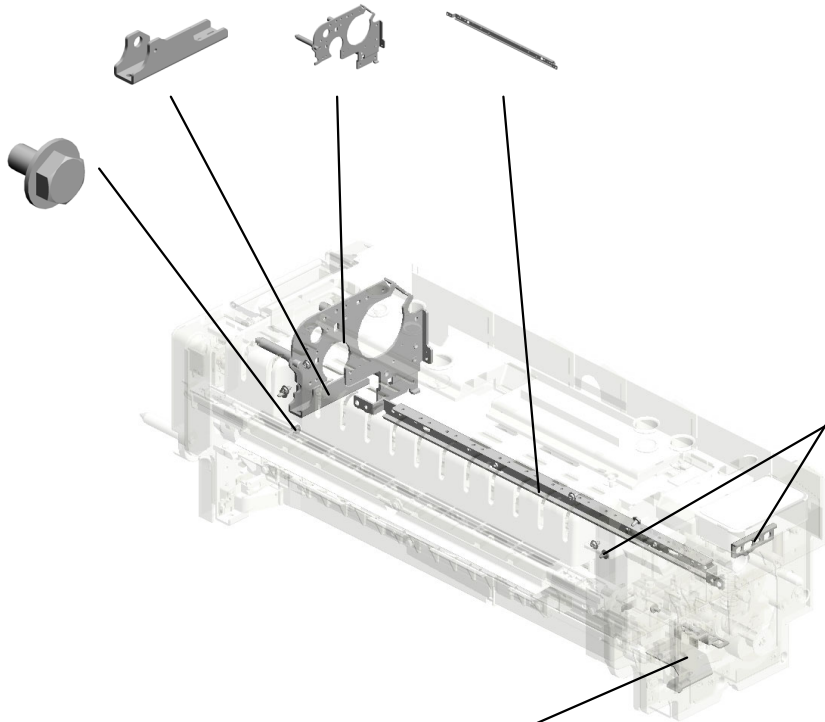

262.D1944285
 STAY:FRONT

271.D2051082
 (x7)
 HEXAGON HEAD SCREW:ROUND POINT:
 M3X6:BLACK
 202105-07 X/O

272.D0A54090
 BRACKET:PHOTO INTERRUPTOR:FRONT
 202208-02 X/O



D1944020
 [A]
 (-NA):FUSING UNIT
 :208V:ASS'Y
 201701-01 O/O

U001	U002	U003	U004	U005	U006	U007	U008	U009	U010	U011	U012	U013	U014	U015	U016	U017	U018	U019	U020	U021
------	------	------	------	------	------	------	------	------	------	------	------	------	------	------	------	------	------	------	------	------

U015_S004_S001
FUSING COVER:UPPER:SUB-ASS'Y

201.D1944186
DECAL:WARNING (REMOVAL AND INSTALLATION);FUSING

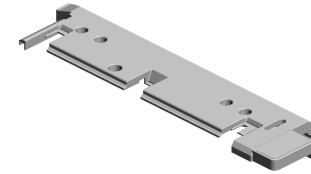
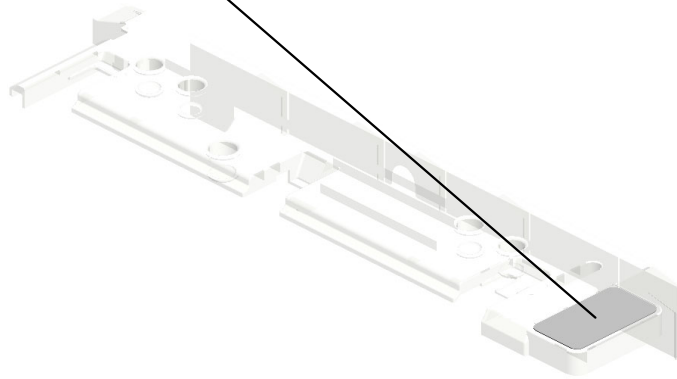

203.D1944190
FUSING COVER:UPPER:SUB-ASS'Y

U001	U002	U003	U004	U005	U006	U007	U008	U009	U010	U011	U012	U013	U014	U015	U016	U017	U018	U019	U020	U021
------	------	------	------	------	------	------	------	------	------	------	------	------	------	------	------	------	------	------	------	------

U015_S004_S002
GUIDE PLATE:FUSING EXIT:LOWER:NO.2:ASS'Y

264.D0894252
(x4)
GUIDE:FUSING EXI
T:PFA

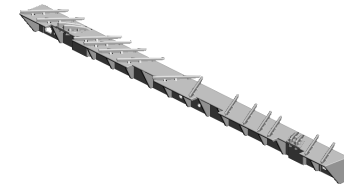
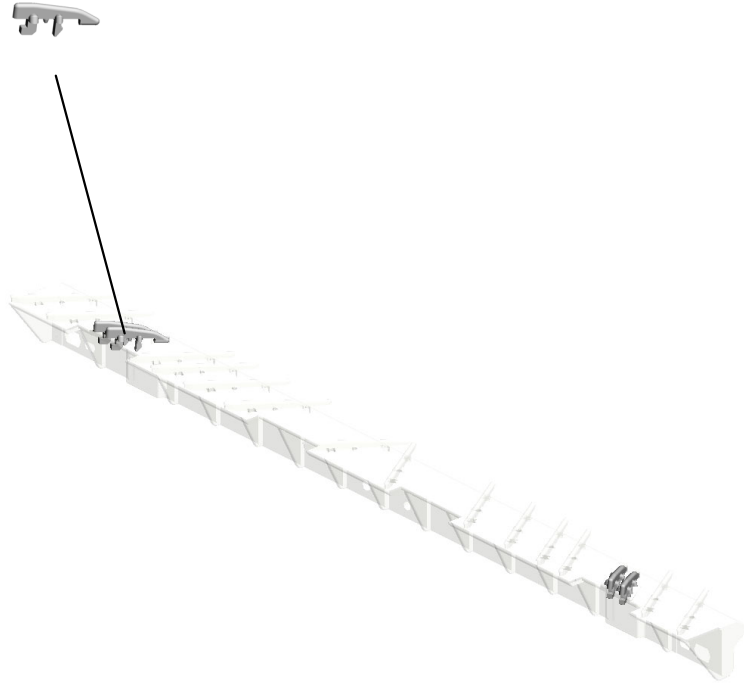

247.D1944066
GUIDE PLATE:FUSI
NG EXIT:LOWER:N
O.2:ASSY

U001	U002	U003	U004	U005	U006	U007	U008	U009	U010	U011	U012	U013	U014	U015	U016	U017	U018	U019	U020	U021
------	------	------	------	------	------	------	------	------	------	------	------	------	------	------	------	------	------	------	------	------

U015_S004_S003

PRESSURE SUB-UNIT:STRIPPER PLATE:ASS'Y

4.03603006N 264.D0894252
(x24) (x13)
SCREW - M3X6 GUIDE:FUSING EXI
T:PFA

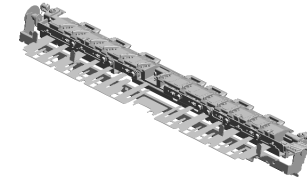

186.D1944074
PRESSURE SUB-U
NIT:STRIPPER PLA
TE:ASS'Y

19.08046123
HEXAGONAL BOLT
:W/WASHER:M3X8

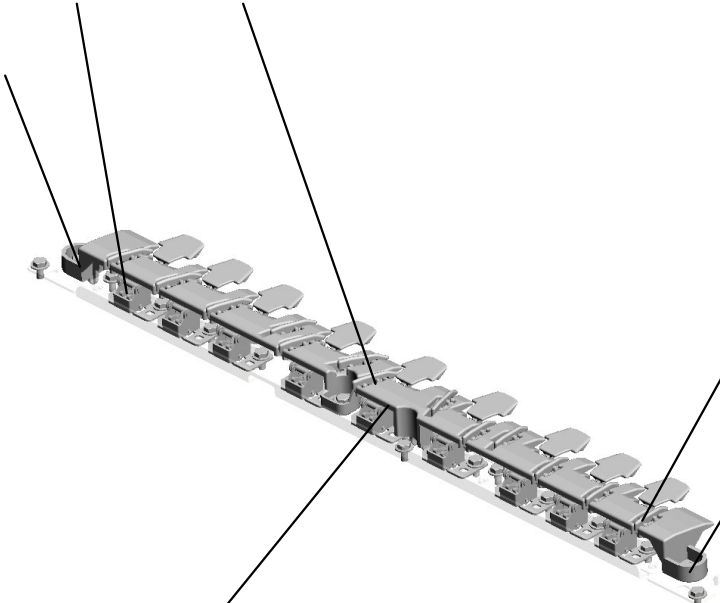

261.D1944115
(x9)
SERVICE PARTS:P
ICKOFF PAWL:PRE
SSURE ROLLER:A
SS'Y



56.AA143520
(x2)
SHOULDER SCRE
W - M3



269.D1944279
GUIDE PLATE:SEP
ARATION SUB-UNI
T:PRESSURE



U001	U002	U003	U004	U005	U006	U007	U008	U009	U010	U011	U012	U013	U014	U015	U016	U017	U018	U019	U020	U021
------	------	------	------	------	------	------	------	------	------	------	------	------	------	------	------	------	------	------	------	------

U015_S005
WEB:CLEANING UNIT:ASS'Y

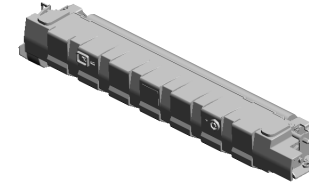

234.D1944340
WEB:CLEANING U
NIT:ASS'Y

- 39.AA063465 (x2) COMPRESSION SPRING:CLEANING FELT:27N
- 56.AA143520 SHOULDER SCREW - M3
- 80.AE045064 WEB:SUB-ASS'Y
- 19.08046123 HEXAGONAL BOLT :W/WASHER:M3X8
- 6.04543006Q (x24) TAPPING SCREW - M3X6

59.AB010173
GEAR - 60Z

62.AB010176
GEAR - 24Z

61.AB010175
GEAR - 24Z

60.AB010174
GEAR - 20Z/50Z

1.03530030N
SCREW:M3X3

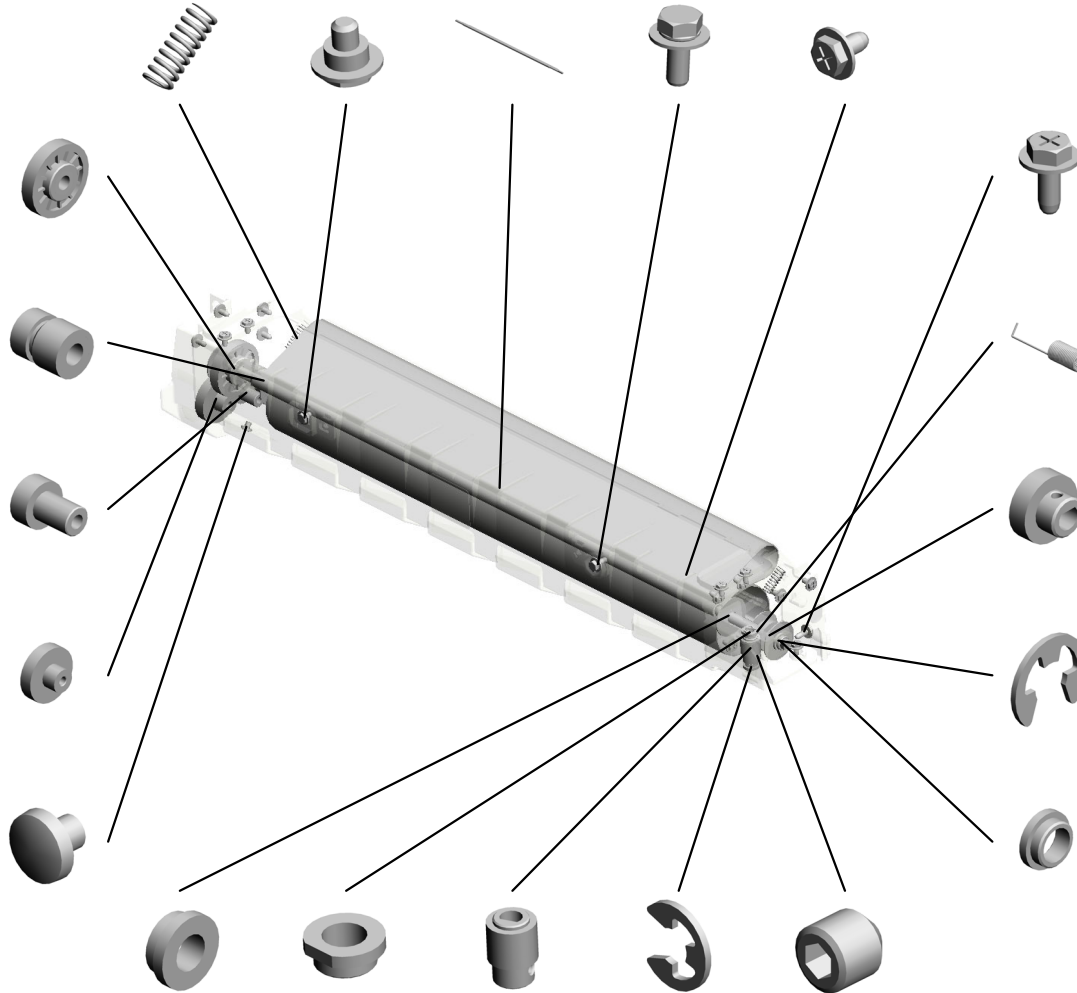

7.04543008Q
TAPPING SCREW:
3X8

44.AA066401
TORSION SPRING:
FEELER

63.AB010177
GEAR - 32Z

10.07200040E
(x5)
RETAINING RING -
M4

51.AA080354
(x3)
BUSHING - 6MM

- 53.AA080356 (x3) BUSHING - 6MM
- 52.AA080355 (x2) BUSHING - 7MM
- 64.AB010178 WORM GEAR
- 9.07200030E (x2) RETAINING RING - M3
- 8.05730030E (x2) HEXAGON HEADLESS SET SCREW - M3X3

U015_S005
WEB:CLEANING UNIT:ASS'Y

164.D0744314 BRACKET:REAR:PIN
163.D0744311 BRACKET:REAR:WEB
157.AE031076 BUSHING:DIA4
201509-03 O/O
274.M0EB4343
ROLLER:PLATE
202301-03 O/O

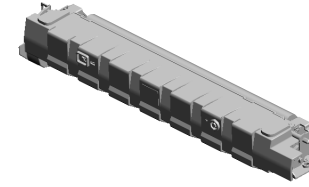

234.D1944340
WEB:CLEANING UNIT:ASSY

162.D0744310
BRACKET:REAR

102.D0094388
ROLLER CLUTCH

235.D1944342
RING:WEB:CLEANING:R

156.D0744300
SPRING PLATE:CLEANING UNIT:FUSION

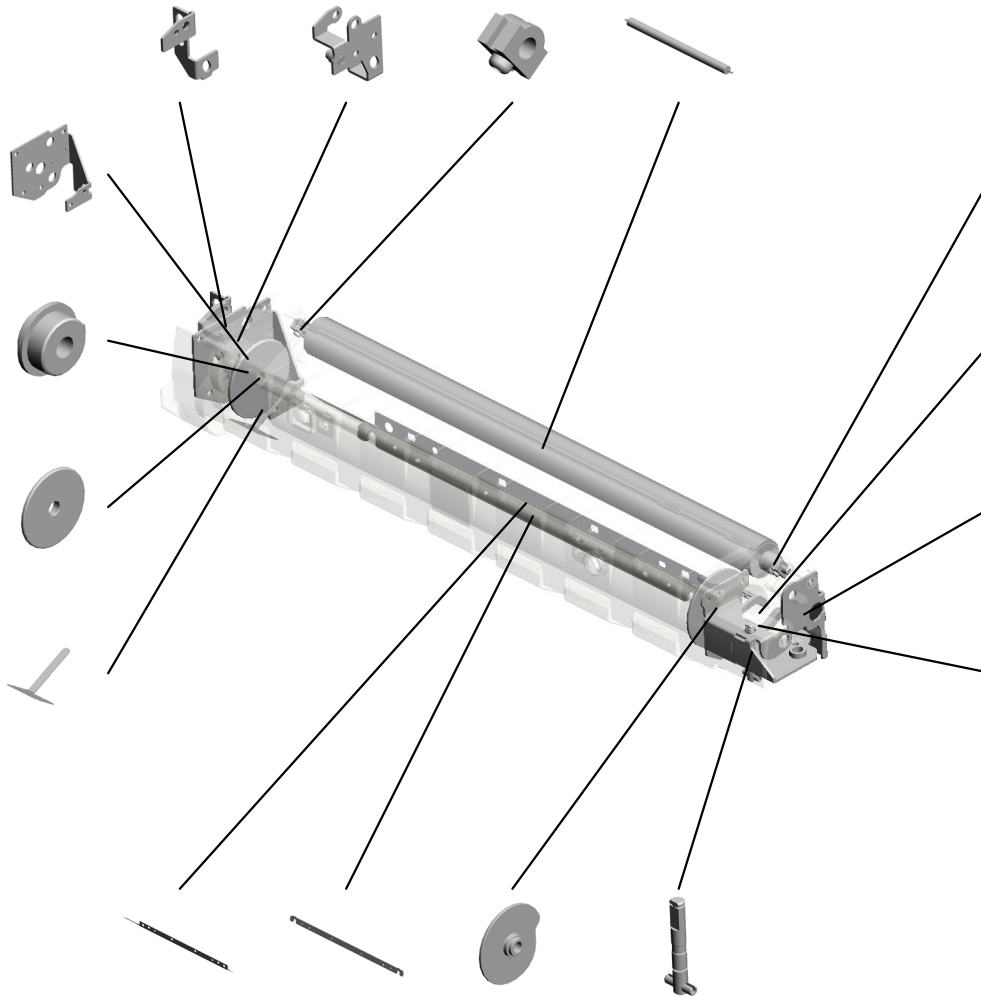

242.AE031075
PLAIN SHAFT BEARING:DIA4:MECHANICAL ROLLER CLUTCH
201509-04 O/O

158.D0744303
FEELER:CLEANING

161.D0744309
BRACKET:FRONT:AUXILIARY

160.D0744308
BRACKET:FRONT:WEB

193.D1944172 BRAKE:WEB
181.D1294331 FLAT NUT:BRAKE
182.D1794337 RING:WEB:CLEANING
159.D0744304 SHAFT:WORM GEAR:SUB-ASSY

U001	U002	U003	U004	U005	U006	U007	U008	U009	U010	U011	U012	U013	U014	U015	U016	U017	U018	U019	U020	U021
------	------	------	------	------	------	------	------	------	------	------	------	------	------	------	------	------	------	------	------	------

U015_S005_S001
COVER:WEB:CLEANING FELT

176.D0744380
DECAL:H-TEMP W
ARNING:FUSING:
WEB

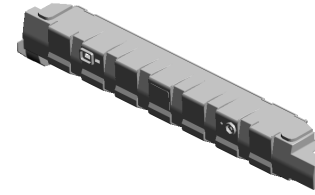

165.D0744325
COVER:WEB:CLEA
NING FELT

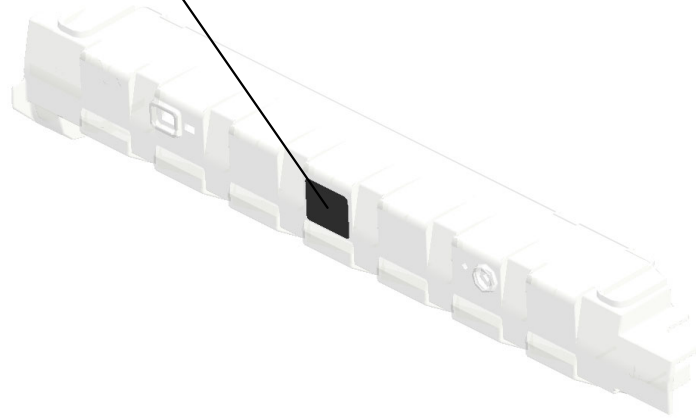

U001	U002	U003	U004	U005	U006	U007	U008	U009	U010	U011	U012	U013	U014	U015	U016	U017	U018	U019	U020	U021
------	------	------	------	------	------	------	------	------	------	------	------	------	------	------	------	------	------	------	------	------

U015_S006
 ROLLER:POLISH:ASS'Y

70.AB012207 GEAR:POLISH:ROLLER:A
 10.07200040E (x4) RETAINING RING - M4
 243.AA000290 (x2) DECAL:POSITIONING DISPLAY:SCREW:PET 201505-04

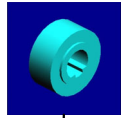

68.AB012203 GEAR:DRIVE:ROLLER:FUSING:B



244.M2054487 (x2) DECAL:GRIP:WEB 201505-05

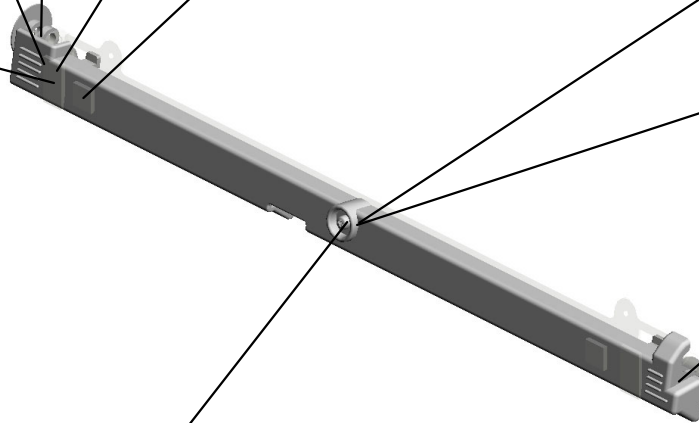
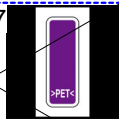

260.09543006N SCREW - M3X6 201805-01 O/O



263.D1944327 [A] ROLLER:POLISH:ASS'Y 201806-08 O/O

233.D1944328 ROLLER:POLISH



232.D1944325 COVER:ROLLER:POLISH:PRINTING 201508-04 O/O



17.07413506 (x2) BALL BEARING - 6 X12X4 MM



D1944320 [A] ROLLER:POLISH:ASS'Y 201806-08 O/O

U016.PAPER EXIT

U016 S007
D1944610
GUIDE PLATE:EXIT:UPPER

U016 S001
D1944433
COOLING UNIT:EXIT:ASS'Y

U016 S006
D1944658
SHEET:HANDLE:LOCK:ASS'Y

U016 S003
M3791627
TRANSPORT ROLLER:DRIVE
N

U016 S002
D1944435
GUIDE:OPEN AND CLOSE:EXIT:ENTRANCE:ASS'Y

U016 S004
M3791627
TRANSPORT ROLLER:DRIVE
N

U016 S005
D0744608
DC SOLENOID:GATE PAWL:EXIT:ASS'Y

U016 S010
D0A54647
LINK:REVERSE ROLLER:ASS'Y

U016 S012
M3791627
TRANSPORT ROLLER:DRIVE
N

U016 S011
D1944484
SHEET:REVERSE:ENTRANCE:HING

U016 S008
D0744541
DAMPING INSULATION:REVERSE:ADHESION

U016 S009
D0744611
DC SOLENOID:GATE PAWL:SWITCHBACK:ASS'Y

U001	U002	U003	U004	U005	U006	U007	U008	U009	U010	U011	U012	U013	U014	U015	U016	U017	U018	U019	U020	U021
------	------	------	------	------	------	------	------	------	------	------	------	------	------	------	------	------	------	------	------	------

U016.PAPER EXIT

U016 S013
D1944540
GUIDE PLATE:DUPLEX:ENTR
ANCE

U016 S015
D1944700
GUIDE:DUPLEX:OPEN AND
CLOSE:UPPER

U016 S014
D0744826
GRIP:DUPLEX:GUIDE PLATE:
LEFT

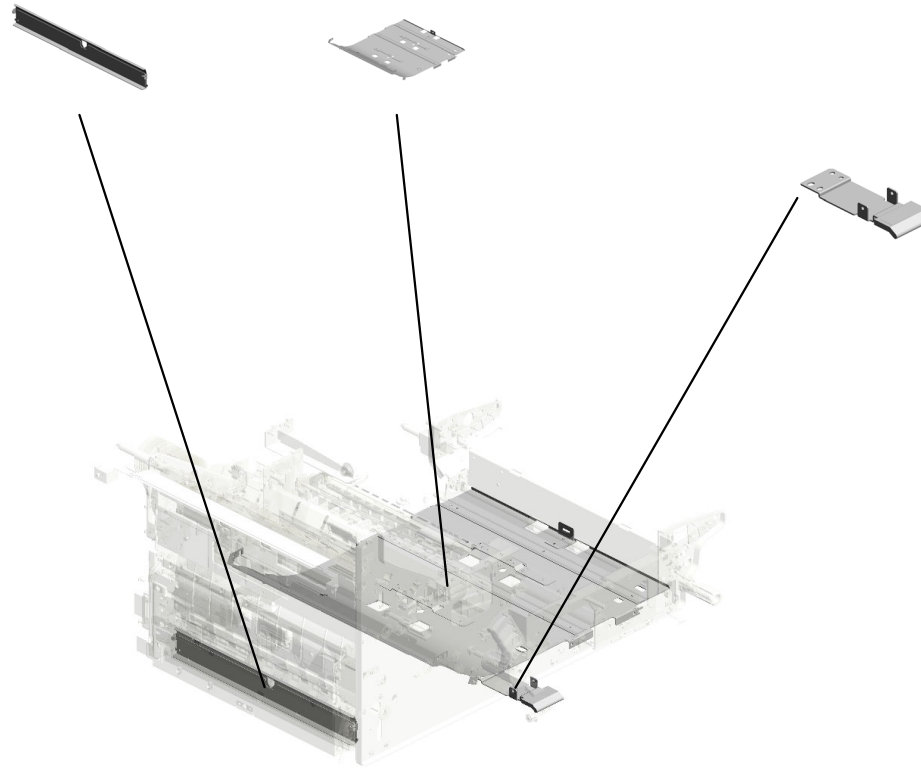

U001	U002	U003	U004	U005	U006	U007	U008	U009	U010	U011	U012	U013	U014	U015	U016	U017	U018	U019	U020	U021
------	------	------	------	------	------	------	------	------	------	------	------	------	------	------	------	------	------	------	------	------

U016_S002.GUIDE:OPEN AND CLOSE:EXIT:ENTRANCE:ASS'Y

U016 S002 S002
D1944426
GUIDE:EXIT:ENTRANCE:ADH
ESION

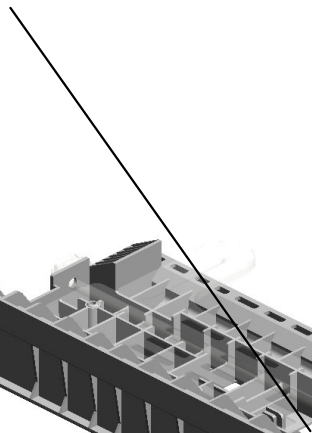

U016 S002 S001
D1944658
SHEET:HANDLE:LOCK:ASS'Y

U001	U002	U003	U004	U005	U006	U007	U008	U009	U010	U011	U012	U013	U014	U015	U016	U017	U018	U019	U020	U021
------	------	------	------	------	------	------	------	------	------	------	------	------	------	------	------	------	------	------	------	------

U016 PAPER EXIT

- 7.03604006N SCREW - M4X6
- 24.07423808 (x11) BALL BEARING - 8 X16X5
- 19.07200030E (x3) RETAINING RING - M3
- 5.03603006N (x37) SCREW - M3X6
- 14.04543006Q (x2) TAPPING SCREW - M3X6

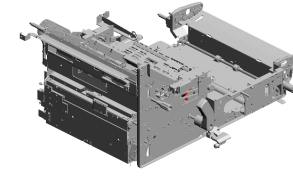

- 8.03604008N (x36) SCREW - M4X8

- 3.03530060N (x2) BIND SCREW - M3 X6

- 6.03603008N (x4) SCREW:M3X8

- 1.03140180N PAN HEAD SCREW :M4X18

- 20.07200040E (x24) RETAINING RING - M4

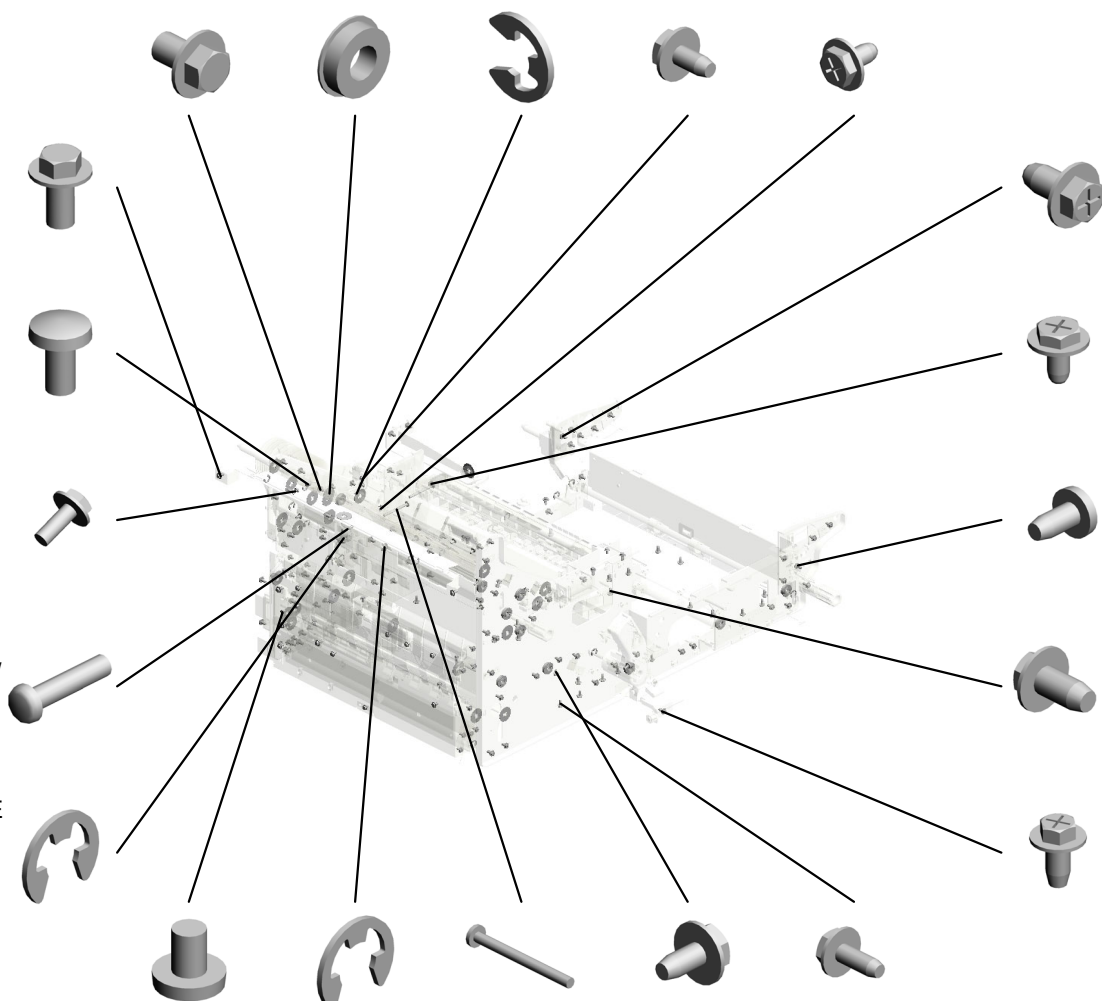

- 2.03530040N (x2) SCREW - M3X4
- 21.07200060E (x31) RETAINING RING - M6
- 4.03540450N (x2) SCREW:M4X45
- 11.04513006N (x2) TAPPING SCREW - 3X6
- 9.04503008N (x6) TAPPING SCREW - M3X8

- 3.03530060N (x 1) BIND SCREW - M3X6
- 6.03603008N (x 4) SCREW:M3X8
- 12.04514008N (x 3) TAPPING SCREW:4X8
- 14.04543006Q (x 2) TAPPING SCREW - M3X6
- 17.04544008Q (x 1) TAPPING SCREW - M4X8
- 18.04544010Q (x 3) TAPPING SCREW:4X10
- 21.07200060E (x 1) RETAINING RING - M6

- 13.04534008N (x2) BINDING SELF TAP PING SCREW:4X8

- 10.04504008N (x15) TAPPING SCREW - M4X8

- 12.04514008N (x20) TAPPING SCREW: 4X8

U016 PAPER EXIT

34.11050724 (x3) CLAMPS:WES-1210
 43.AA043432 TIMING BELT:B40S 2M204
 38.67542866 ROLLER - POSITIONING GUIDE
 41.AA043325 TIMING BELT - B40 S2M250
 42.AA043431 TIMING BELT:B40S 2M320

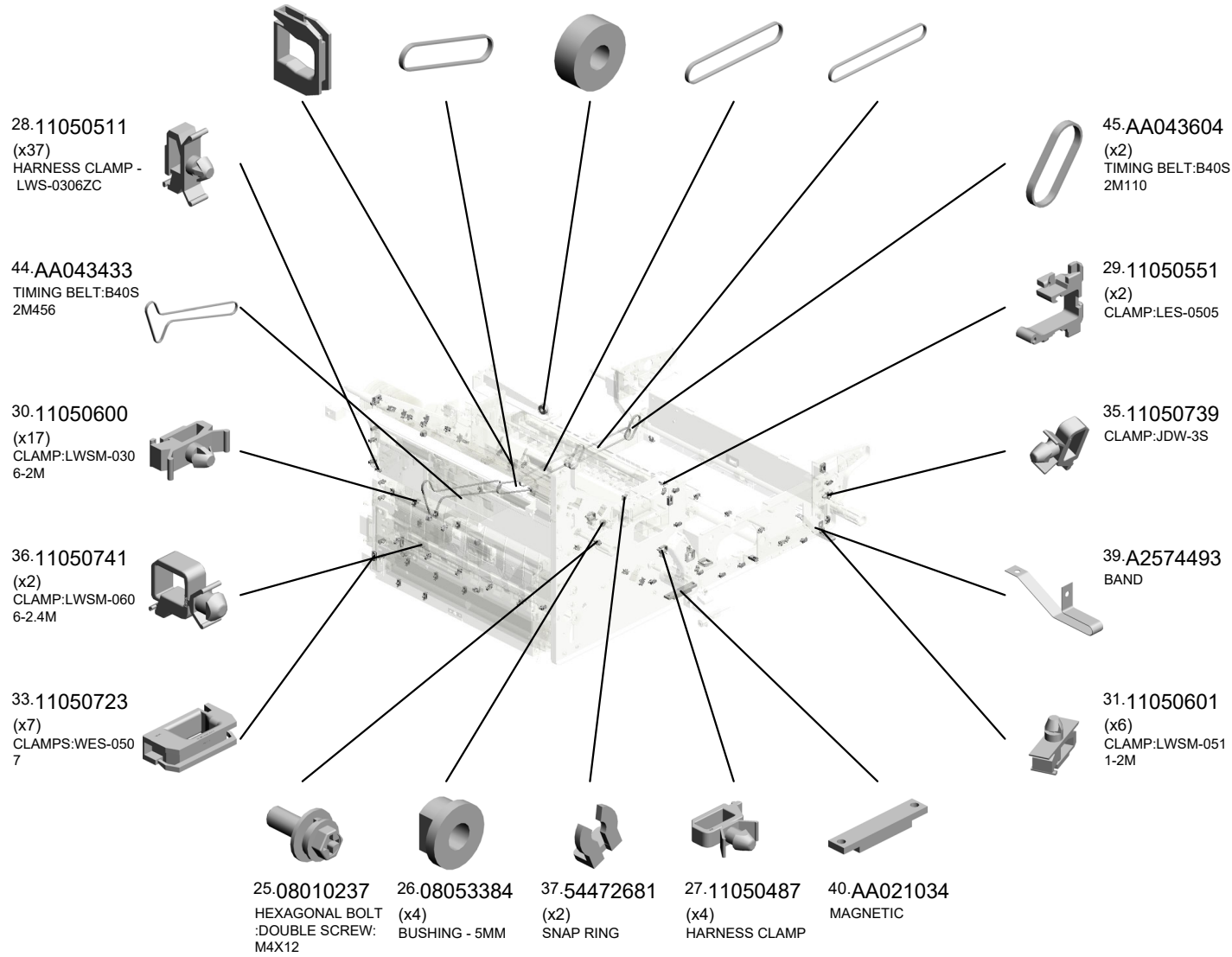
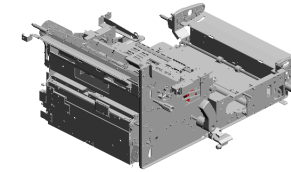

U016 PAPER EXIT

- 67.AB030805 PULLEY:COUPLIN G:30T
- 61.AA143444 (x2) STEPPED SCREW
- 53.AA082101 (x4) BUSHING - 6X10X6
- 57.AA120097 ANTISTATIC BRUS H
- 56.AA120084 DISCHARGE BRUS H

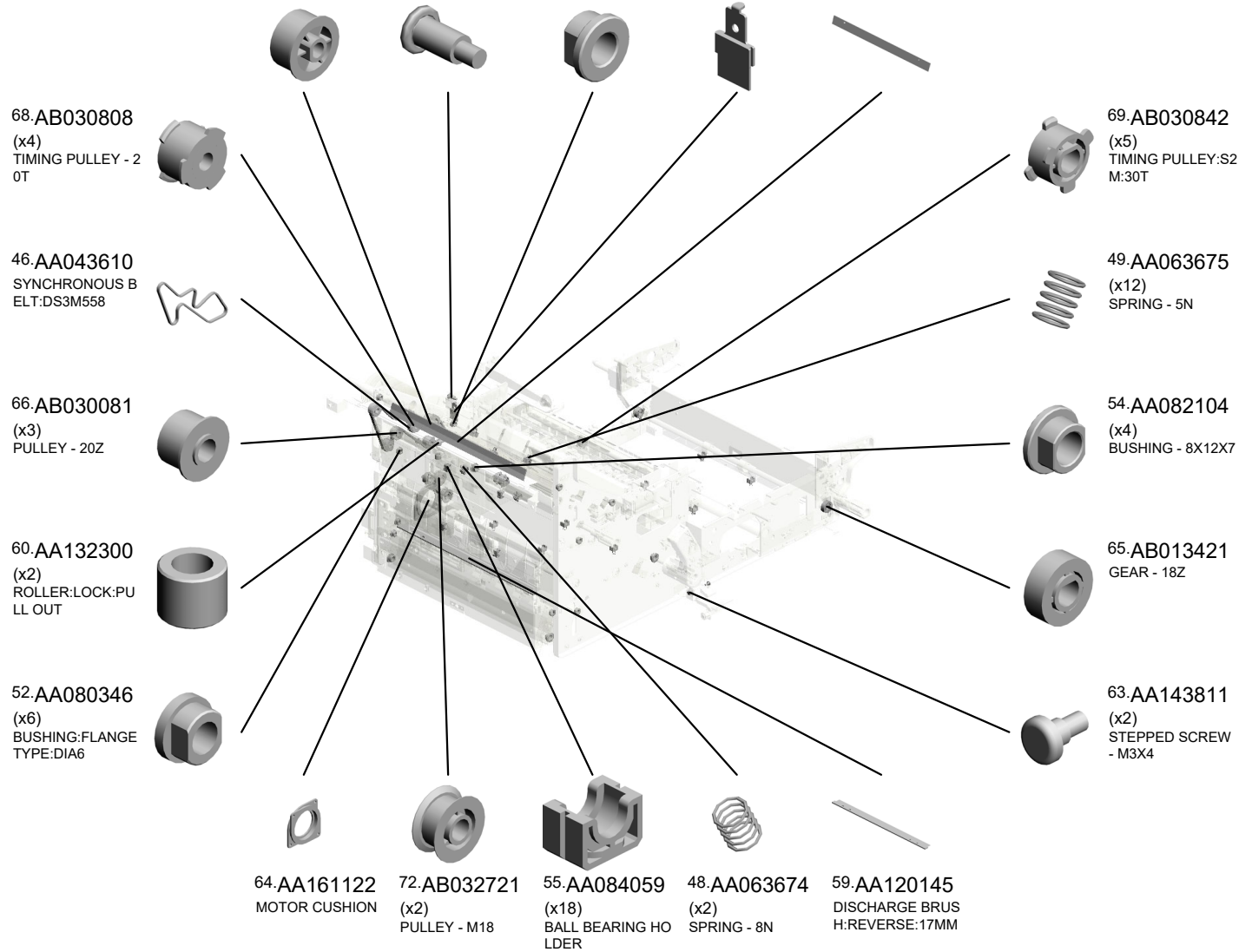
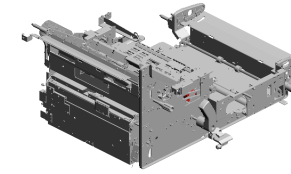

U016 PAPER EXIT

- 80.B1321183 BRACKET:LOCK
- 81.B1321221 HOLDER:SPRING: PULL OUT
- 89.D0741213 HOLDER:COIL SPRING:LOCK:PAPER EXIT UNIT
- 78.AX660016 DC FAN MOTOR:M M60X38:DC24V:PW M:18W
- 101.D0743991 PLATE:EXIT:ENTRANCE

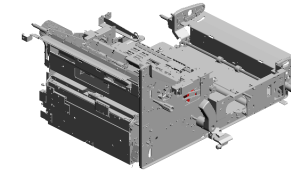

- 82.D1941234 SUPPORTING PLATE:BRACKET:LOCK 201612-03 X/O

- 100.D0743986 BRACKET:CAP:HEAT PIPE:LOWER

- 86.B8353968 TIMING BELT - B60 S2M126

- 94.D0743173 (x2) TIMING PULLEY:S2 M:25T

- 77.AX040157 STEPPER MOTOR DC1.68V 6.7W

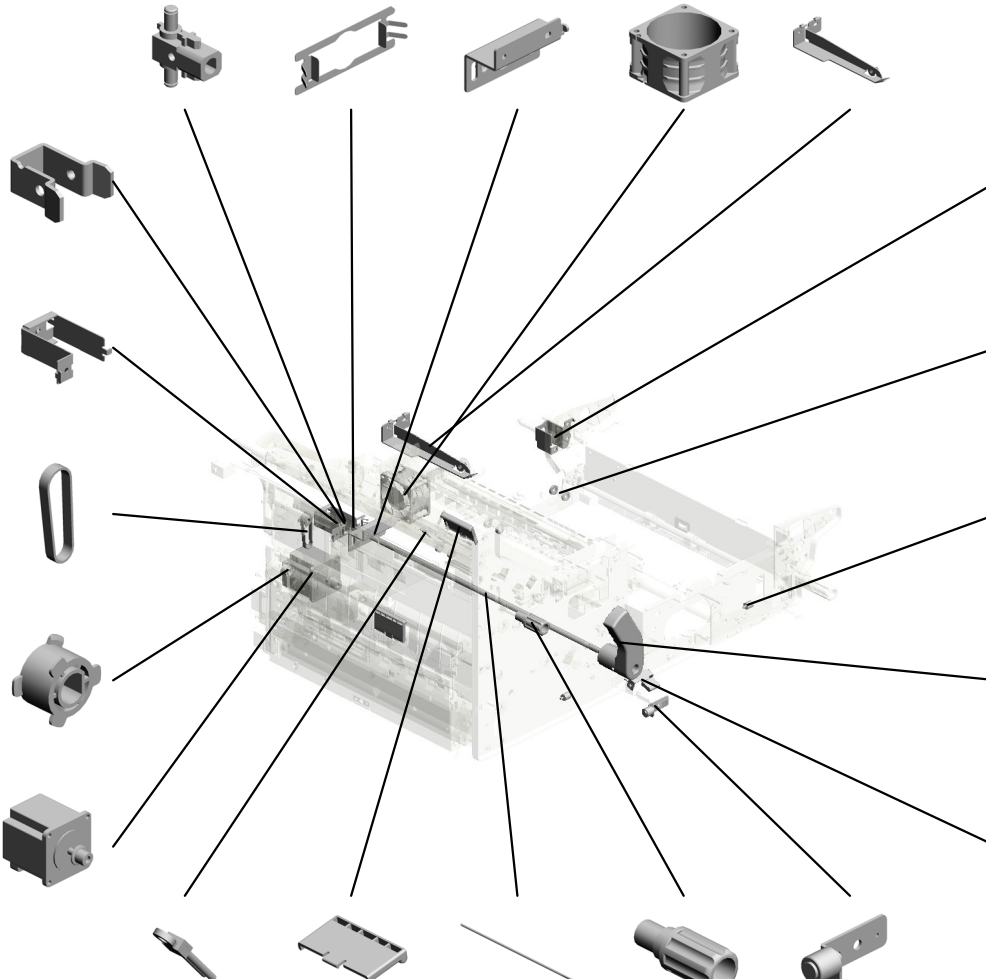

- 88.D0741212 SUPPORTING PLATE:POSITIONING PIN:RIGHT

- 92.D0742941 (x3) TIMING PULLEY:S2 M:30T

- 73.AF022067 (x3) GUIDE STOPPER ROLLER

- 87.D0741180 LEVER:PULL OUT: PAPER EXIT UNIT

- 79.D2704933 GUIDE PLATE LEVER HOOK 201612-01 O/O

- 76.AW100165 THERMISTOR:ASSY

- 84.B2346424 (x2) RELEASE GRIP

- 90.D0741215 SHAFT:LOCK:PAPER EXIT UNIT

- 74.AG050100 KNOB - TRANSPORT ROLLER

- 93.D0743047 BRACKET:HOLDER:DUPLX:ASSY

U016 PAPER EXIT

- 134.D0744683 JOINT:EXIT:DRIVE
- 130.D0744665 SHAFT:DRIVE:COUPLING:EXIT
- 129.D0744657 BRACKET:COUPLING:DC BRUSHLESS MOTOR
- 105.D0744528 BRACKET:SENSOR:EXIT:EXIT
- 119.D0744613 EXIT ROLLER:DRIVE:REVERSE:EXIT:PRESS FIT

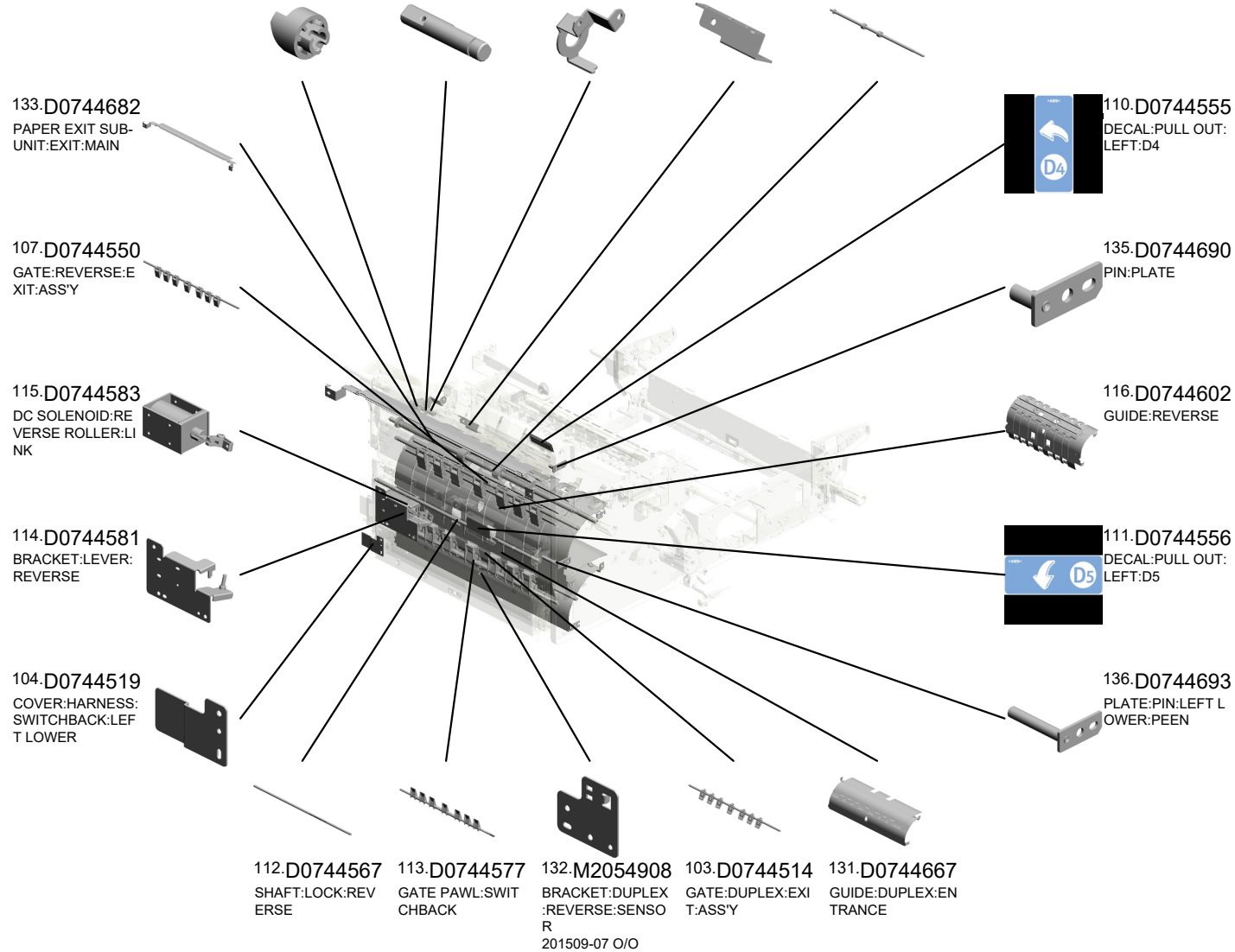
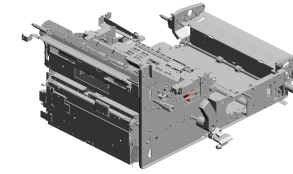

U016 PAPER EXIT

- 147.D1944408 (x2) CAP:HEAT PIPE
- 138.D0744698 (x4) LEVER:LOCK:GUIDE PLATE
- 148.D1944409 BRACKET:CAP:HEAT PIPE:UPPER
- 168.D1944614 (x2) TRANSPORT ROLLER:CONNECTING:DRIVE:EXIT
- 179.D1944741 GUIDE:EXIT:UPPER

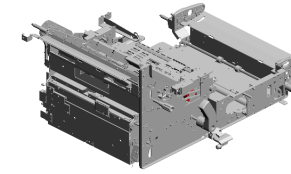

161.D1944536
GUIDE:REVERSE EXIT:RIGHT:PEEN

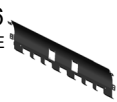

162.D1944537
BRACKET:MOTOR:REVERSE:CONNECTING



146.D1942999 (x2)
DC STEPPER MOTOR:PAPER TRANSPORT MD:MM42:ASSY

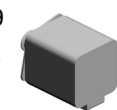

143.D0744817
PLATE:GUARD:DRIVER:DUPLER

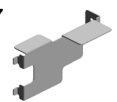

170.D1944652
BRACKET:DRAWER:PAPER EXIT UNIT



163.D1944539
BRACKET:MOTOR:REVERSE



167.D1944612 (x2)
TRANSPORT ROLLER:DRIVE:REVERSE



165.D1944589
GATE PAWL:REVERSE EXIT



137.D0744696
SHAFT:GRIP:GUIDE PLATE



176.D1944718 (x3)
TRANSPORT ROLLER:DUPLER:NO.1:PRESS FIT



141.D0744806
PLATE:OPEN AND CLOSE:DUPLER:RIGHT LOWER

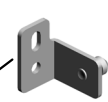

177.D1944719
TRANSPORT ROLLER:DRIVE:DUPLER:KNOB



140.D0744802
HOLDER:PRESSURE ROLLER:DUPLER:NO.2

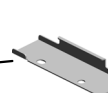

139.D0744710
KNOB:TRANSPORT ROLLER:AUXILIARY:PRESS FIT

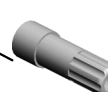

142.D0744813
GUIDE:DUPLER:OPEN AND CLOSE:LOWER



U016 PAPER EXIT

- 194.D1944759 BRACKET:LOCK:EXIT
201612-04 X/O
- 201.G1784818 (x2)
SPRING:PULL OUT
:LOCK:EXIT
- 185.D1944905 (x2)
TRANSPORT ROLL
ER:DRIVEN:PRESS
FIT
- 187.D1947169 BRACKET:FUSING:
VACUUM:FAN
- 186.D1947168 (x2)
COVER:NET:FUSIN
G:VACUUM

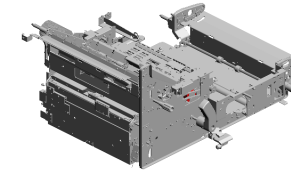

196.G1784794
SPRING:TENSION
ER:EXIT



190.G1783593
(x14)
TENSION SPRING:
STOPPER



202.G1784822
(x4)
SPRING:PRESSUR
E:0.8N:DIA0.65



188.D3553875
TIMING BELT:60S2
M224



199.G1784813
STOPPER:LEFT LO
WER:FRAME



182.D1944810
PLATE:OPEN AND
CLOSE:DUPLX:LE
FT LOWER:PEEN



180.D1944744
GUIDE:REVERSE E
XIT:LEFT



183.D1944816
BRACKET:DRAW E
R:DUPLX



181.D1944804
RUBBER FOOT:TM
-96-1



197.G1784798
SPRING:SWITC
HBACK:GATE



191.G1784651
(x2)
SUPPORTING PLA
TE:GUIDE PLATE



203.G1784828
(x4)
STAY:LOCK:LEVER
:LEFT LOWER



200.G1784817
(x6)
SPRING:PRESSUR
E:ROLLER:DUPL
X



195.G1784793
SPRING:REVERSE:
GATE



198.G1784808
(x3)
BRACKET:PRESSU
RE:ROLLER

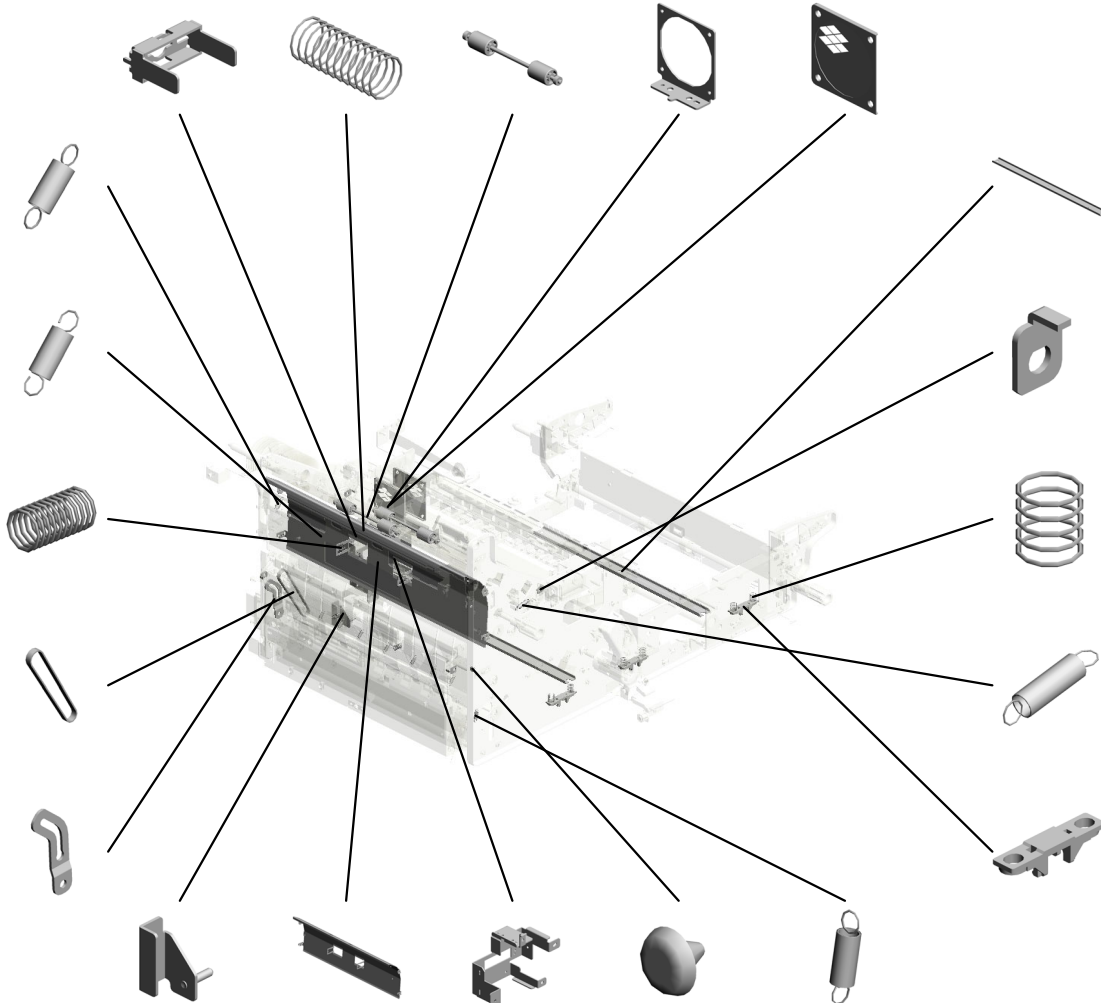

U016 PAPER EXIT

209.G1784908 (x4) COIL SPRING:LEFT LOWER:LOCK
 218.H0722216 (x2) COMPRESSION SPRING
 224.D1944742 STAY:LEFT UPPER
 225.11029803 CONNECTOR:6-29 2235-0
 215.G1787743 BOSS:POSITIONIN G PIN:TRANSPORT UNIT:NO.1

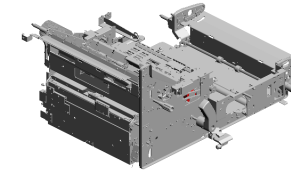

214.G1787656 TENSION SPRING: TENSIONER

207.G1784900 COVER:DC STEPPER MOTOR:MM56

231.11035759 CONNECTOR:RFC P-44W0-E 201712-04

220.M0774862 (x4) TRANSPORT ROLLER:DRIVEN:DUPLER:DIA18X2

235.D2704752 HANDLE:LOCK:FRONT:LOWER 201905-06 O/O



210.G1784909 (x2) SCREW:TRANSPORT

216.G1787744 BOSS:POSITIONIN G PIN:TRANSPORT UNIT:NO.2

213.G1787618 PLATE:FIX:BAND

206.G1784895 (x2) SHEET:DUPLER:SPRING PLATE

211.G1784916 (x2) SCREW:ROUND POINT

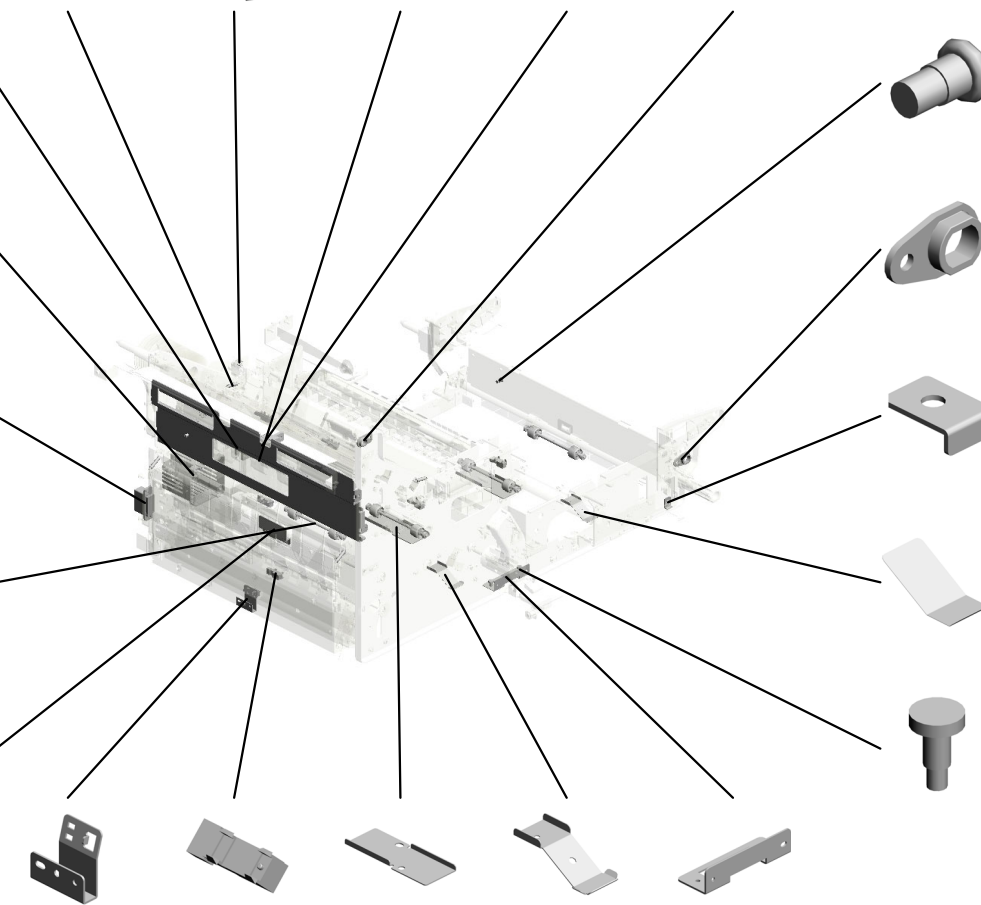

234.D0744564 BRACKET:REVERSE:SENSOR
 217.GW010007 (x8) PHOTO REFLECTION SENSOR:EXIT
 208.G1784907 (x2) HOLDER:PRESSURE ROLLER:DUPLER
 205.G1784890 (x2) SPRING PLATE:DUPLER:GUIDE:LOWER
 236.D2704670 BRACKET:MAGNET CATCH:DUPLER 202003-01 O/O

U016
PAPER EXIT

237-D1944625
LEVER:GATE PAW
L:REVERSE:PRES
S FIT
202006-04 X/O

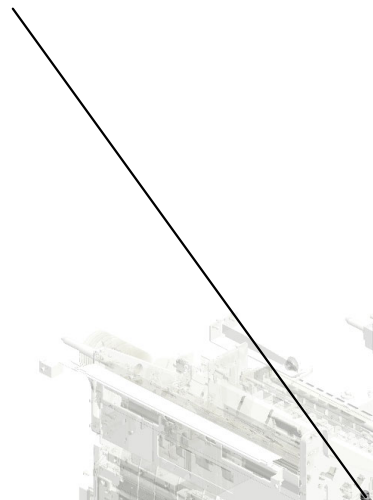
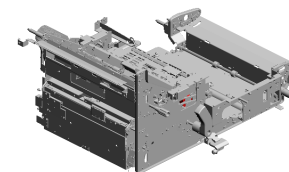

U001	U002	U003	U004	U005	U006	U007	U008	U009	U010	U011	U012	U013	U014	U015	U016	U017	U018	U019	U020	U021
------	------	------	------	------	------	------	------	------	------	------	------	------	------	------	------	------	------	------	------	------

U016_S001
COOLING UNIT:EXIT:ASS'Y

47.AA062319 SPRING
97.D0743932 LEVER:STOPPER
15.04543008Q TAPPING SCREW: 3X8
95.D0743921 SHAFT:COOLING:ENTRANCE
157.D1944487 GUIDE:BASE:EXIT:ENTRANCE

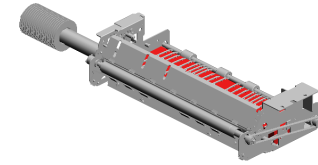

229.D1944433
COOLING UNIT:EXIT:ASSY

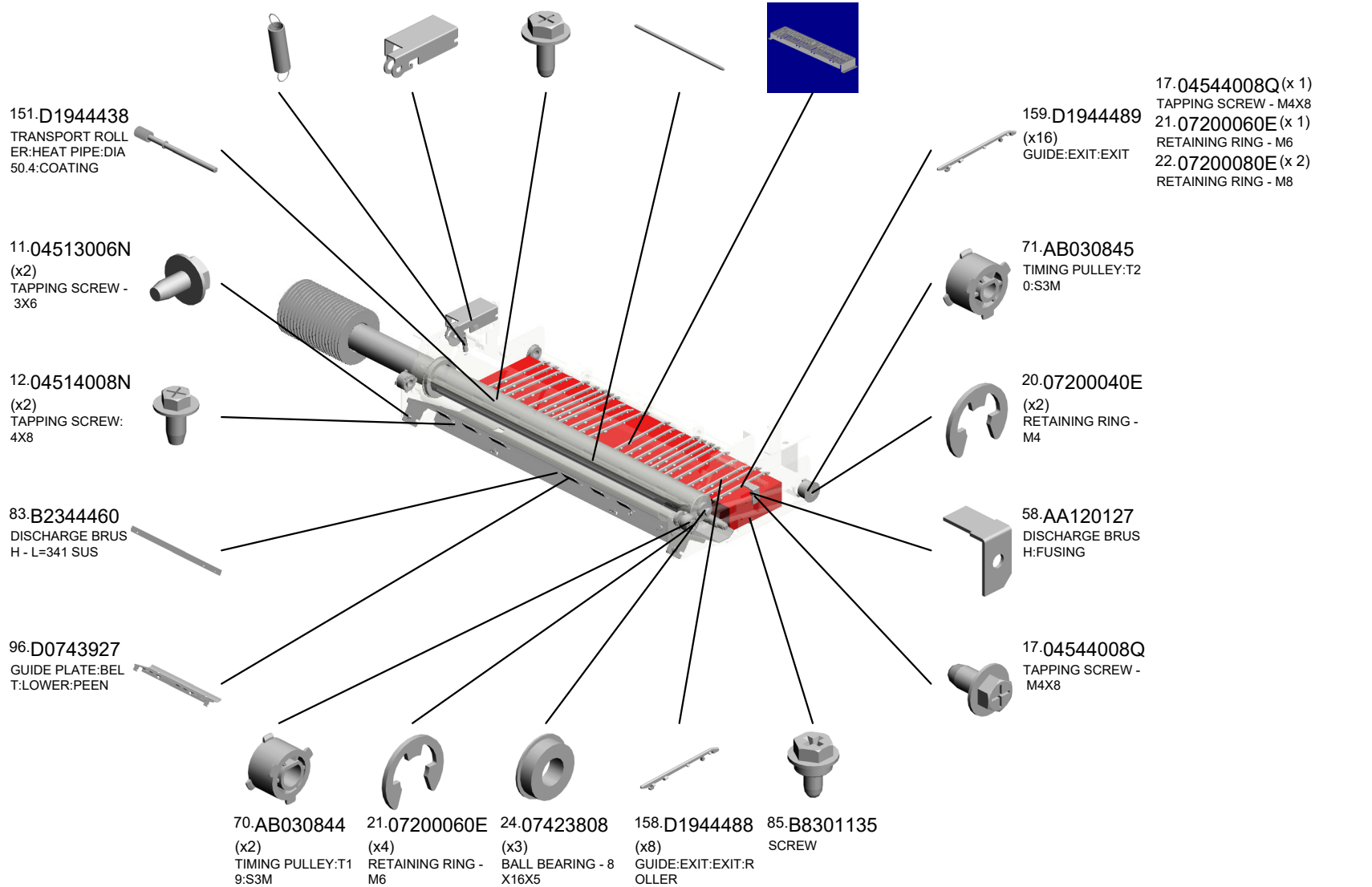

U001	U002	U003	U004	U005	U006	U007	U008	U009	U010	U011	U012	U013	U014	U015	U016	U017	U018	U019	U020	U021
------	------	------	------	------	------	------	------	------	------	------	------	------	------	------	------	------	------	------	------	------

U016_S001
 COOLING UNIT:EXIT:ASS'Y

223.D1944413 174.D1944712
 GUIDE:FIX:SHEET: FLAT CONVEYER
 CING BELT:COOLING

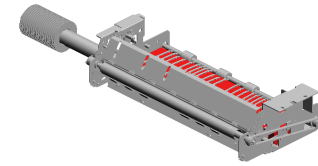

229.D1944433
 COOLING UNIT:EXI
 T:ASSY

178.D1944721
 DRIVE ROLLER:CO
 OLING UNIT:EXIT:P
 RESS FIT

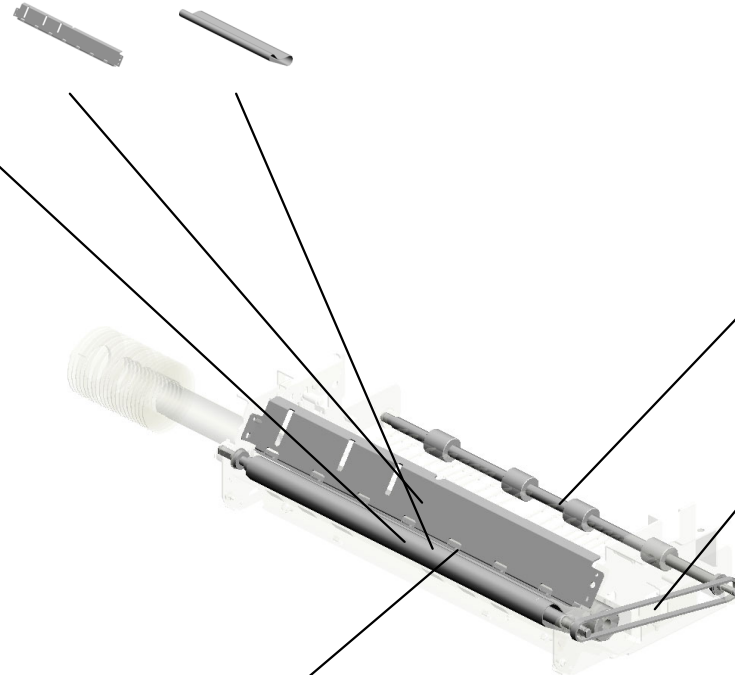

169.D1944616
 TRANSPORT ROLL
 ER:DRIVE:FUSING
 EXIT

189.D4341911
 TIMING BELT:60S3
 M402

175.D1944714
 TRANSPORT ROLL
 ER:COOLING:ENT
 RANCE

U001	U002	U003	U004	U005	U006	U007	U008	U009	U010	U011	U012	U013	U014	U015	U016	U017	U018	U019	U020	U021
------	------	------	------	------	------	------	------	------	------	------	------	------	------	------	------	------	------	------	------	------

U016_S002

GUIDE:OPEN AND CLOSE:EXIT:ENTRANCE:ASS'Y

- 50.AA063680 (x2) PRESSURE SPRING - G - 5X10.5
- 99.D0743951 SHAFT:GRIP:GUIDE PLATE
- 217.GW010007 PHOTO REFLECTIVE SENSOR:EXIT
- 32.11050692 CLAMP:LES-0503
- 98.D0743943 ROLLER:FUSING EXIT:DRIVEN:ASS'Y

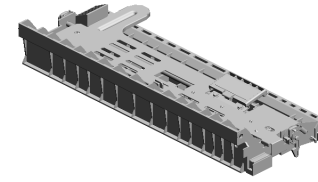

150.D1944435
GUIDE:OPEN AND CLOSE:EXIT:ENTRANCE:ASS'Y

219.M0262872 (x2) TENSION SPRING:GRIP

203.G1784828 (x2) STAY:LOCK:LEVER:LEFT LOWER

19.07200030E (x2) RETAINING RING - M3

138.D0744698 (x2) LEVER:LOCK:GUIDE PLATE

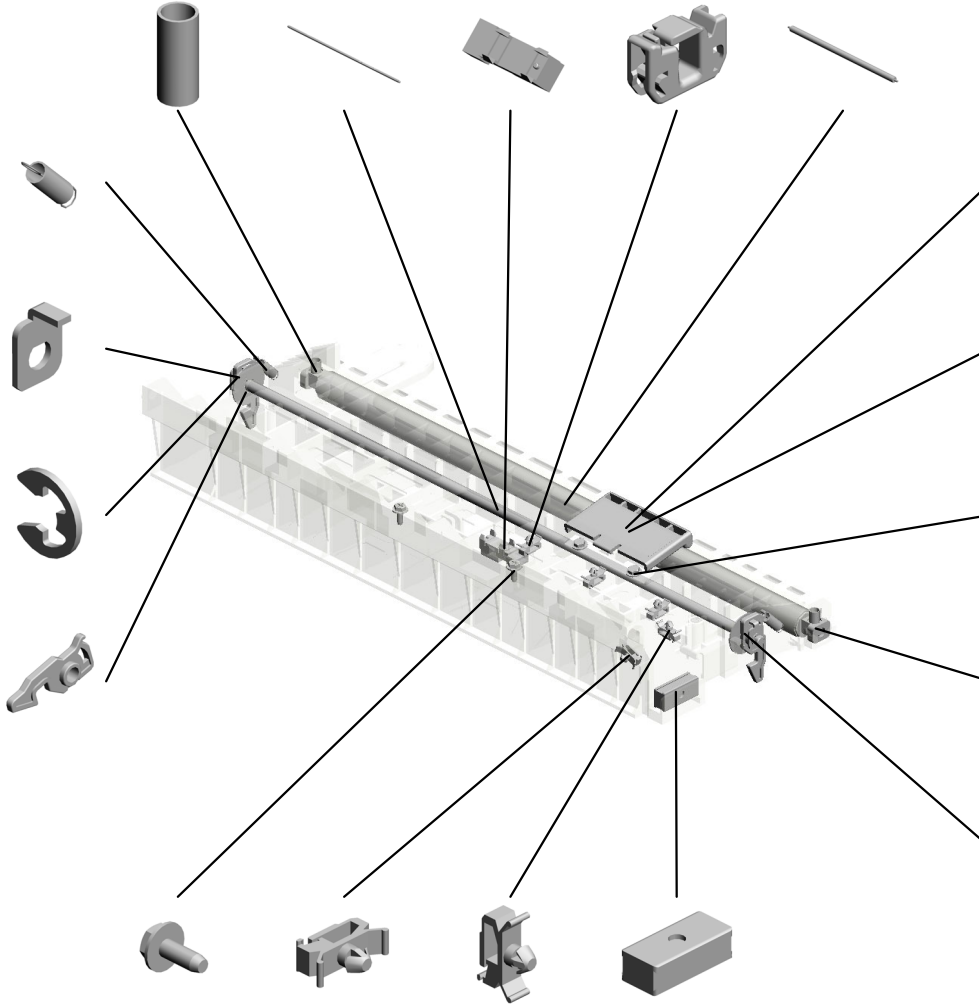

109.D0744554 DECAL:PULL OUT:LEFT:D3

84.B2346424 RELEASE GRIP

5.03603006N (x2) SCREW - M3X6

51.AA080240 (x2) BUSHING - MM5

20.07200040E (x2) RETAINING RING - M4

9.04503008N (x2) TAPPING SCREW - M3X8

30.11050600 CLAMP:LWSM-0306-2M

28.11050511 (x3) HARNESS CLAMP - LWS-0306ZC

75.AG070514 MAGNET CATCH

U016_S002_S001
SHEET:HANDLE:LOCK:ASS'Y

235.D2704752
HANDLE:LOCK:FR
AME:LOWER
201905-06 O/O

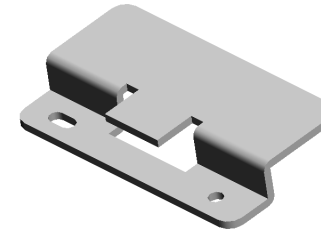

172.D1944658
SHEET:HANDLE:L
OCK:ASS'Y

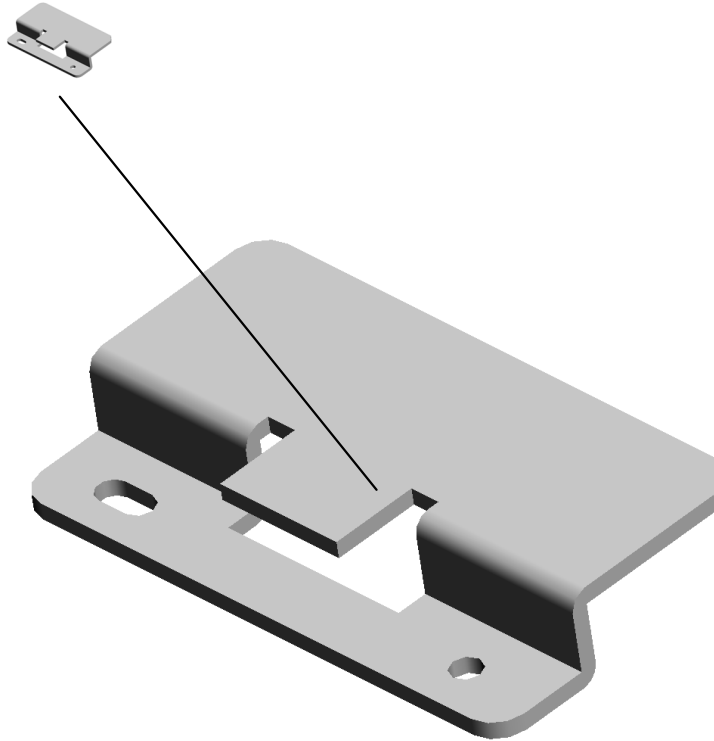

U001	U002	U003	U004	U005	U006	U007	U008	U009	U010	U011	U012	U013	U014	U015	U016	U017	U018	U019	U020	U021
------	------	------	------	------	------	------	------	------	------	------	------	------	------	------	------	------	------	------	------	------

U016_S002_S002
GUIDE:EXIT:ENTRANCE:ADHESION

152.D1944472
SHEET:TRANSPOR
T:COOLING:MIDDL
E

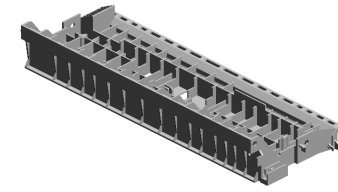

149.D1944426
GUIDE:EXIT:ENTR
ANCE:ADHESION

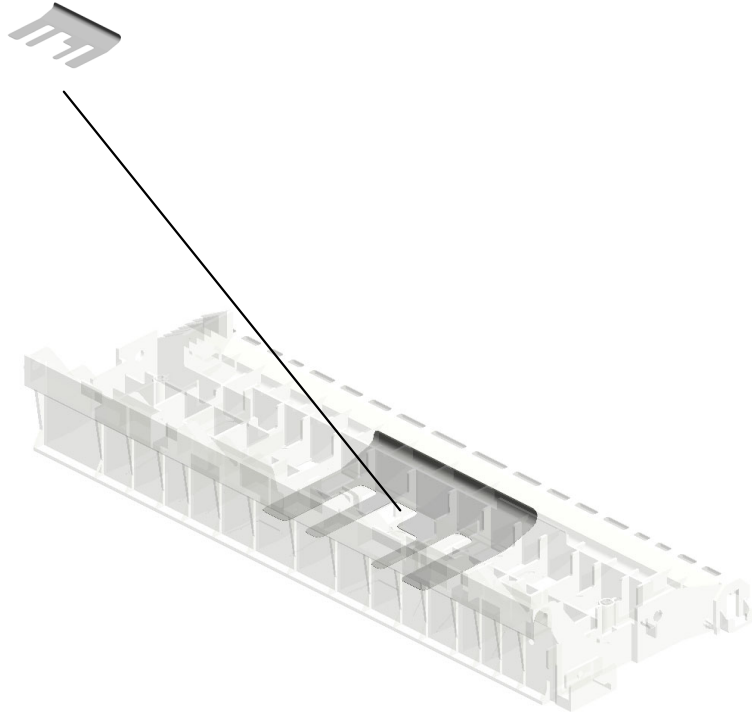

U001	U002	U003	U004	U005	U006	U007	U008	U009	U010	U011	U012	U013	U014	U015	U016	U017	U018	U019	U020	U021
------	------	------	------	------	------	------	------	------	------	------	------	------	------	------	------	------	------	------	------	------

U016_S003
TRANSPORT ROLLER:DRIVEN

23.07403804
(x2)
BALL BEARING:DIA
4XDIA9X4

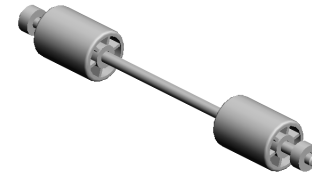
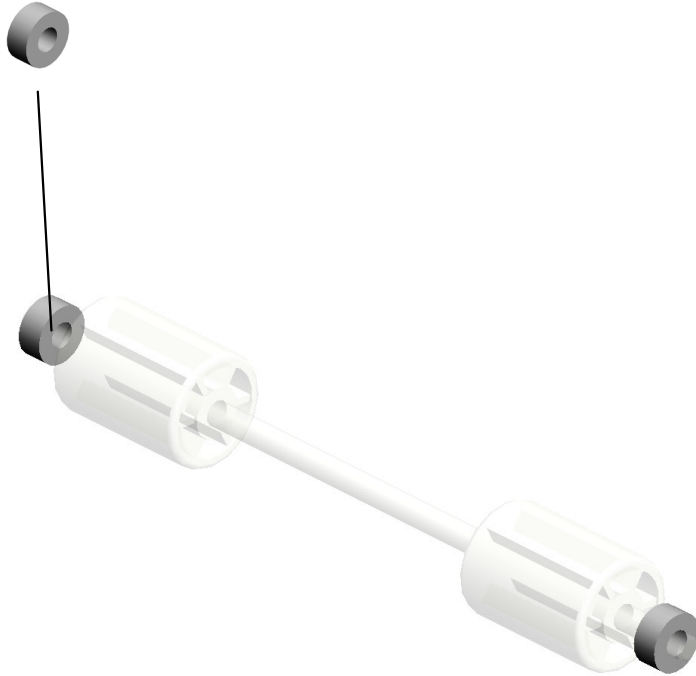

221.M3791627
TRANSPORT ROLL
ER:DRIVEN

U001	U002	U003	U004	U005	U006	U007	U008	U009	U010	U011	U012	U013	U014	U015	U016	U017	U018	U019	U020	U021
------	------	------	------	------	------	------	------	------	------	------	------	------	------	------	------	------	------	------	------	------

U016_S004
TRANSPORT ROLLER:DRIVEN

23.07403804
(x2)
BALL BEARING:DIA
4XDIA9X4

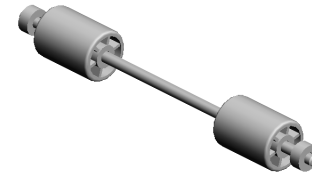
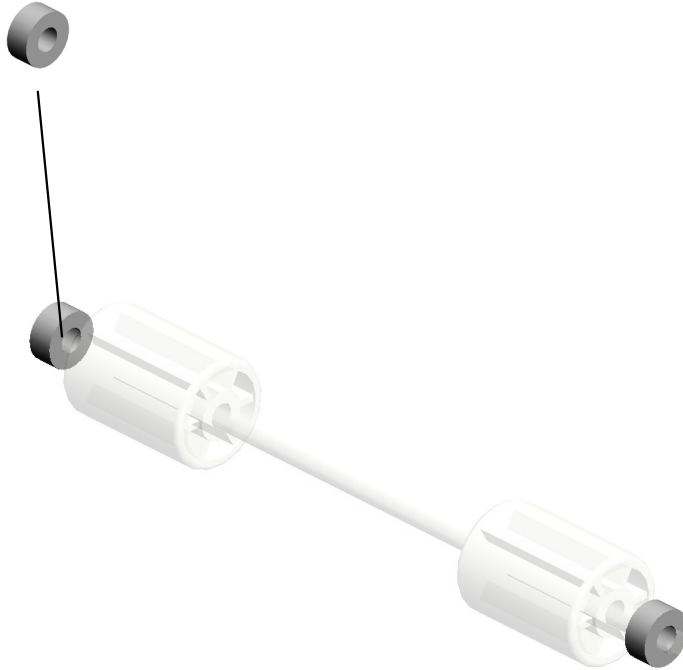

221.M3791627
TRANSPORT ROLL
ER:DRIVEN

U001	U002	U003	U004	U005	U006	U007	U008	U009	U010	U011	U012	U013	U014	U015	U016	U017	U018	U019	U020	U021
------	------	------	------	------	------	------	------	------	------	------	------	------	------	------	------	------	------	------	------	------

U016_S005
DC SOLENOID:GATE PAWL:EXIT:ASS'Y

2.03530040N
(x2)
SCREW - M3X4

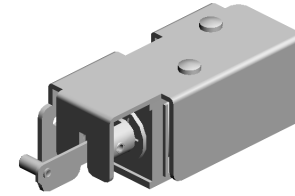

117.D0744608
DC SOLENOID:GA
TE PAWL:EXIT:AS
SY

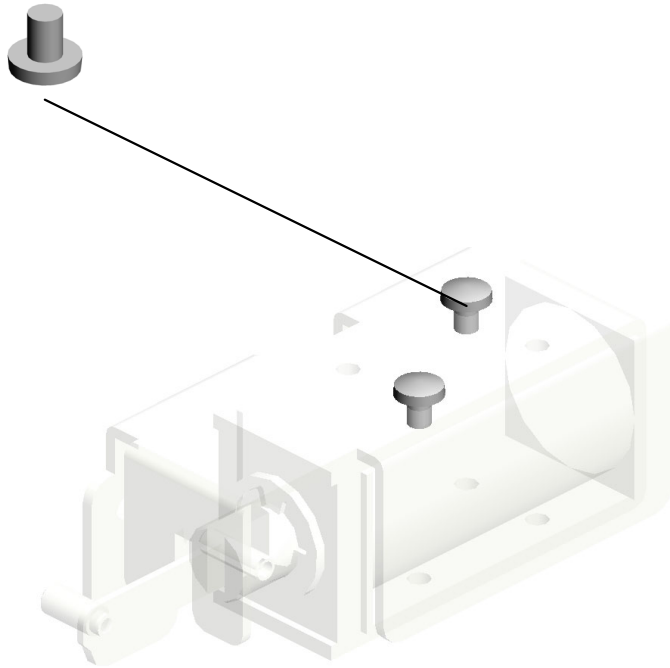

U001	U002	U003	U004	U005	U006	U007	U008	U009	U010	U011	U012	U013	U014	U015	U016	U017	U018	U019	U020	U021
------	------	------	------	------	------	------	------	------	------	------	------	------	------	------	------	------	------	------	------	------

U016_S006
SHEET:HANDLE:LOCK:ASS'Y

235.D2704752
HANDLE:LOCK:FR
AME:LOWER
201905-06 O/O

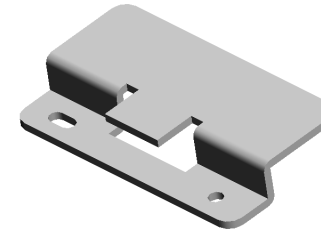

172.D1944658
SHEET:HANDLE:L
OCK:ASS'Y

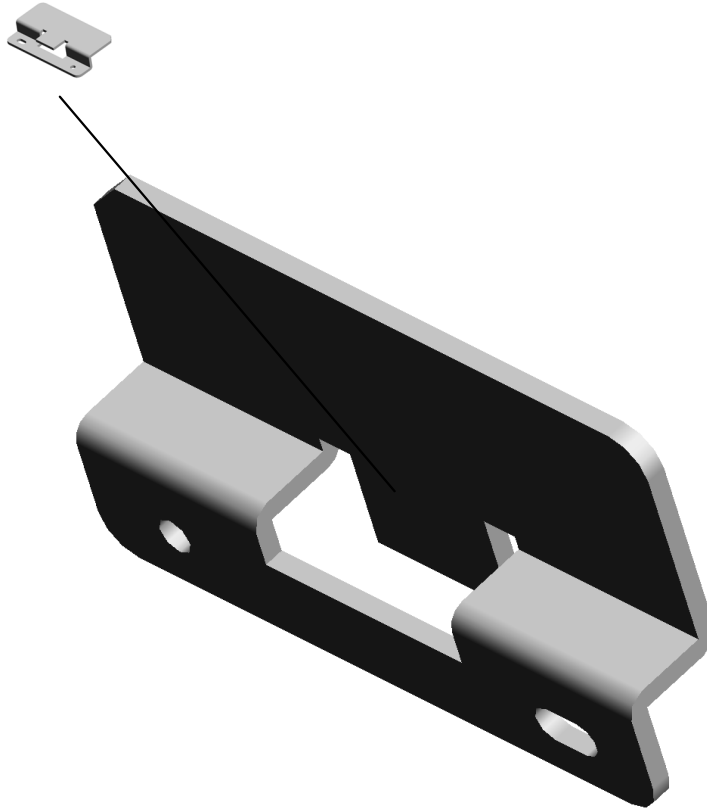

U001	U002	U003	U004	U005	U006	U007	U008	U009	U010	U011	U012	U013	U014	U015	U016	U017	U018	U019	U020	U021
------	------	------	------	------	------	------	------	------	------	------	------	------	------	------	------	------	------	------	------	------

U016_S007
GUIDE PLATE:EXIT:UPPER

228.D1944453
SHEET:TRANSPOR
T:EXIT:INNER BAC
K

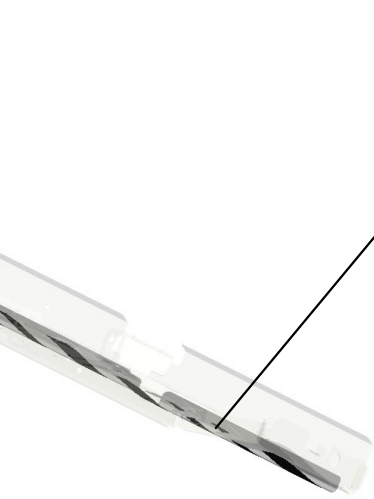

166.D1944610
GUIDE PLATE:EXIT
:UPPER

227.D1944449
SHEET:TRANSPOR
T:EXIT:FRONT



U001	U002	U003	U004	U005	U006	U007	U008	U009	U010	U011	U012	U013	U014	U015	U016	U017	U018	U019	U020	U021
------	------	------	------	------	------	------	------	------	------	------	------	------	------	------	------	------	------	------	------	------

U016_S008
DAMPING INSULATION:REVERSE:ADHESION

123.D0744628
DAMPING INSULATION:REVERSE:UPPER

106.D0744541
DAMPING INSULATION:REVERSE:ADHESION

126.D0744631
DAMPING INSULATION:REVERSE:LOWER

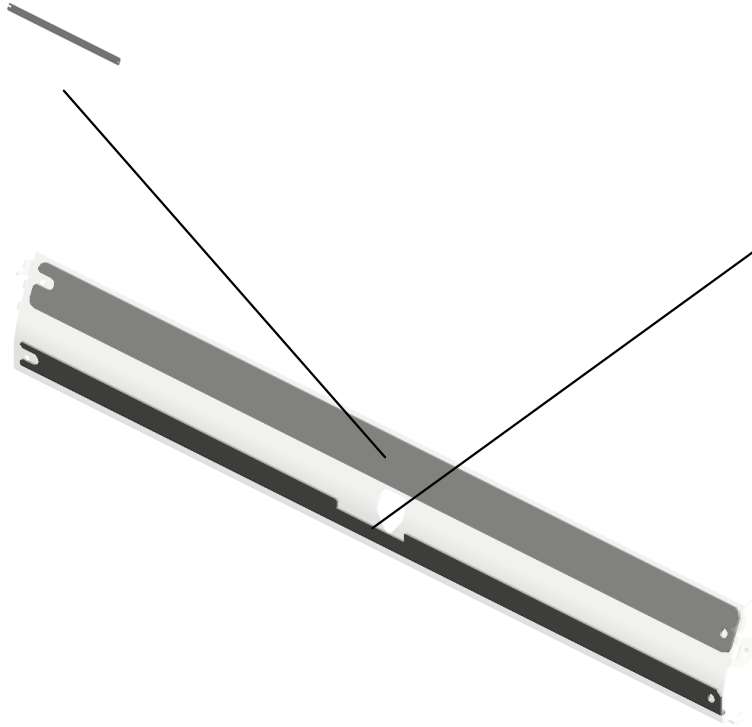

U001	U002	U003	U004	U005	U006	U007	U008	U009	U010	U011	U012	U013	U014	U015	U016	U017	U018	U019	U020	U021
------	------	------	------	------	------	------	------	------	------	------	------	------	------	------	------	------	------	------	------	------

U016_S009
DC SOLENOID:GATE PAWL:SWITCHBACK:ASS'Y

2.03530040N
(x2)
SCREW - M3X4

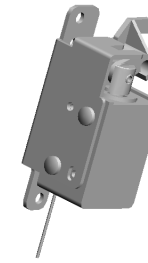
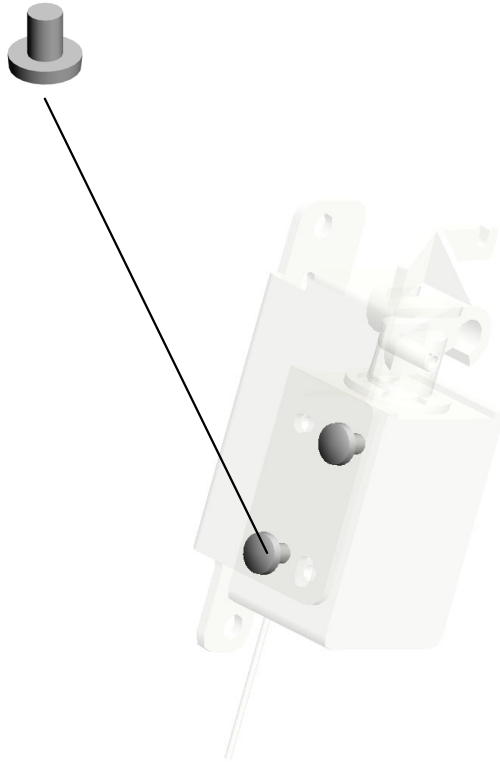

118.D0744611
DC SOLENOID:GA
TE PAWL:SWITCH
BACK:ASS'Y

U001	U002	U003	U004	U005	U006	U007	U008	U009	U010	U011	U012	U013	U014	U015	U016	U017	U018	U019	U020	U021
------	------	------	------	------	------	------	------	------	------	------	------	------	------	------	------	------	------	------	------	------

U016_S010
LINK:REVERSE ROLLER:ASS'Y

91.D0742652
LEVER:LINK:TRAN
SPORT ROLLER

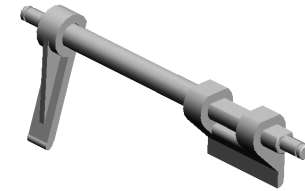

233.D0A54647
[A]
LINK:REVERSE RO
LLER:ASS'Y
201807-05 O/O

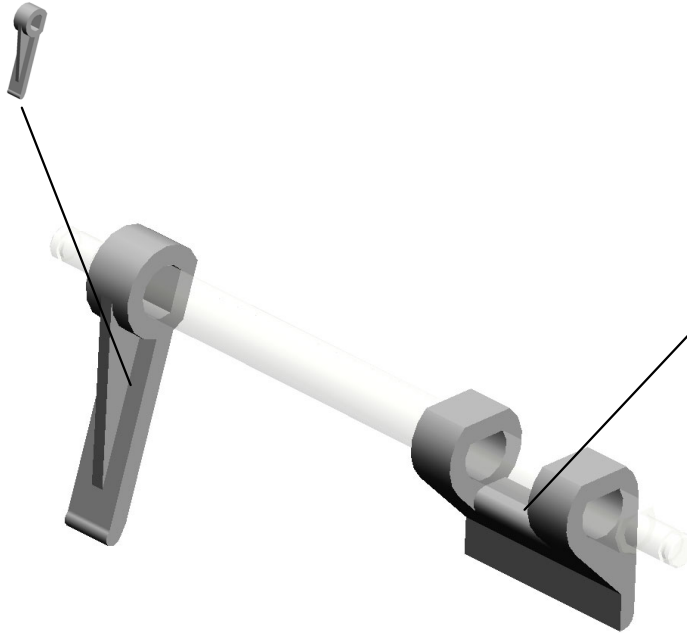

212.G1787453
ARM:ON-OFF:TRA
NSPORT ROLLER

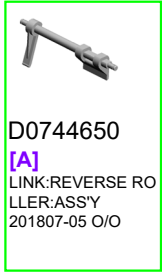

D0744650
[A]
LINK:REVERSE RO
LLER:ASS'Y
201807-05 O/O

U001	U002	U003	U004	U005	U006	U007	U008	U009	U010	U011	U012	U013	U014	U015	U016	U017	U018	U019	U020	U021
------	------	------	------	------	------	------	------	------	------	------	------	------	------	------	------	------	------	------	------	------

U016_S011
SHEET:REVERSE:ENTRANCE:HING

155.D1944482 SHEET:REVERSE
SUB-UNIT:MIDDLE
REAR

121.D0744626 DAMPING INSULAT
ION:REVERSE:ENT
RANCE:UPPER

156.D1944483 SHEET:REVERSE
SUB-UNIT:MIDDLE
REAR

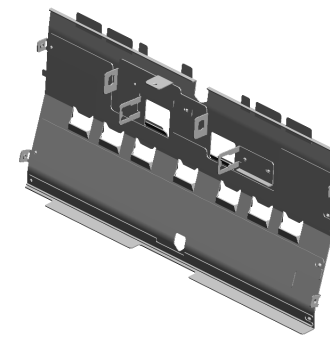

238.D1944484
[A]
SHEET:REVERSE:
ENTRANCE:HING
202009-01 X/O

153.D1944480
(x4)
SHEET:REVERSE
SUB-UNIT:FRONT
REAR

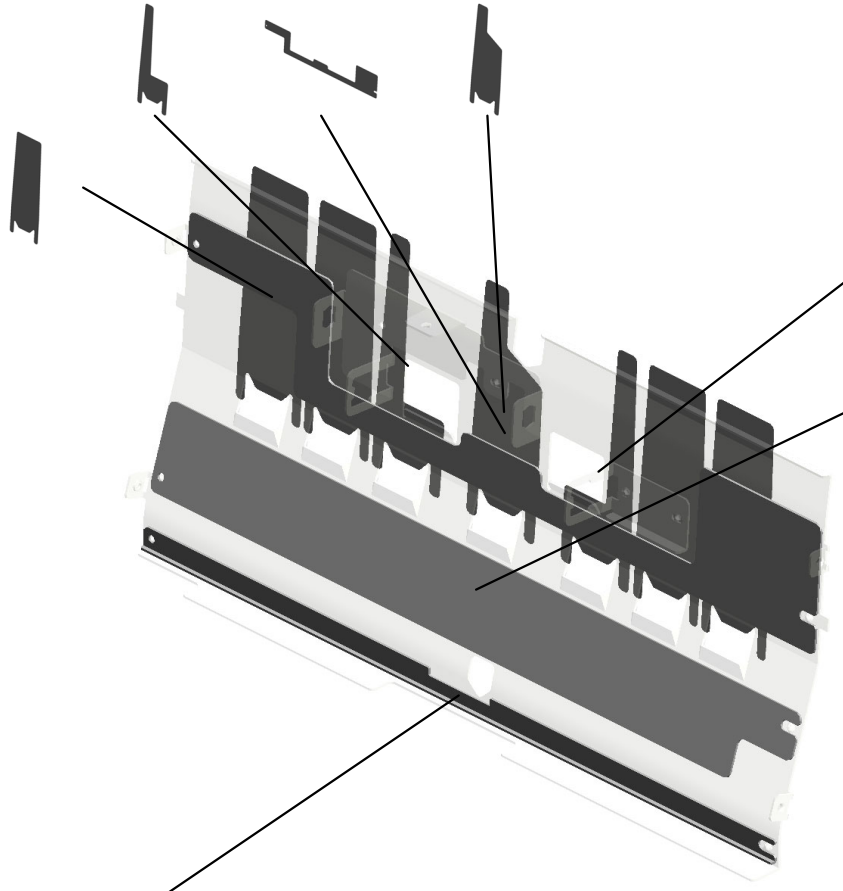

154.D1944481
SHEET:REVERSE
SUB-UNIT:MIDDLE
FRONT

122.D0744627
DAMPING INSULAT
ION:REVERSE:ENT
RANCE:LOWER

126.D0744631
DAMPING INSULAT
ION:REVERSE:LO
WER



D1944490
[A]
GUIDE:REVERSE:ENT
RANCE
202009-01 X/O

U001	U002	U003	U004	U005	U006	U007	U008	U009	U010	U011	U012	U013	U014	U015	U016	U017	U018	U019	U020	U021
------	------	------	------	------	------	------	------	------	------	------	------	------	------	------	------	------	------	------	------	------

U016_S012
TRANSPORT ROLLER:DRIVEN

23.07403804
(x2)
BALL BEARING:DIA
4XDIA9X4

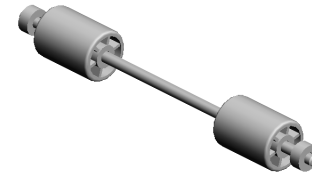
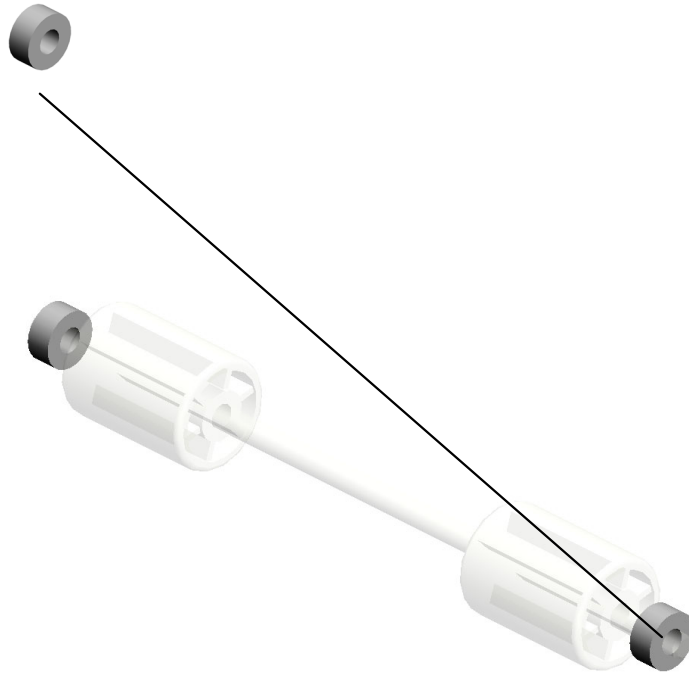

221.M3791627
TRANSPORT ROLL
ER:DRIVEN

U001	U002	U003	U004	U005	U006	U007	U008	U009	U010	U011	U012	U013	U014	U015	U016	U017	U018	U019	U020	U021
------	------	------	------	------	------	------	------	------	------	------	------	------	------	------	------	------	------	------	------	------

U016_S013
GUIDE PLATE:DUPLEX:ENTRANCE

124.D0744629
DAMPING INSULATION:
DUPLEX:ENTRANCE

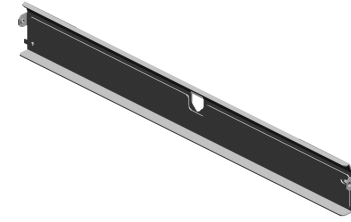

164.D1944540
GUIDE PLATE:DUPLEX:
ENTRANCE

U001	U002	U003	U004	U005	U006	U007	U008	U009	U010	U011	U012	U013	U014	U015	U016	U017	U018	U019	U020	U021
------	------	------	------	------	------	------	------	------	------	------	------	------	------	------	------	------	------	------	------	------

U016_S014
GRIP:DUPLEX:GUIDE PLATE:LEFT

108.D0744552
DECAL:PULL OUT:
LEFT:Z3

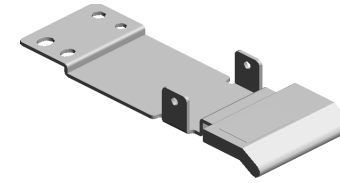

144.D0744826
GRIP:DUPLEX:GUI
DE PLATE:LEFT

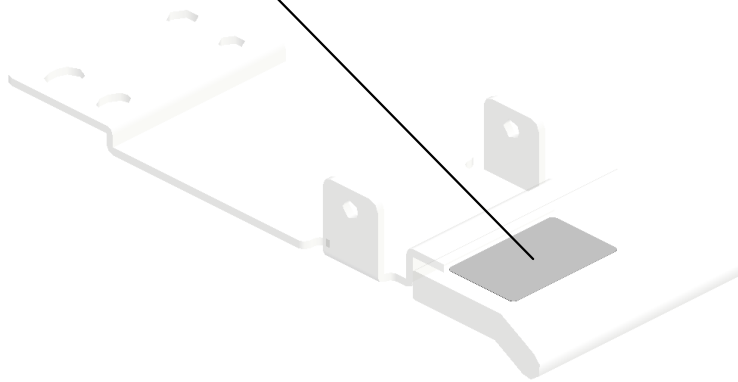

U001	U002	U003	U004	U005	U006	U007	U008	U009	U010	U011	U012	U013	U014	U015	U016	U017	U018	U019	U020	U021
------	------	------	------	------	------	------	------	------	------	------	------	------	------	------	------	------	------	------	------	------

U016_S015
GUIDE:DUPLX:OPEN AND CLOSE:UPPER

239.D1944703
(x2)
SHEET:DUPLX:O
PEN AND CLOSE:U
PPER



173.D1944700
GUIDE:DUPLX:OP
EN AND CLOSE:UP
PER

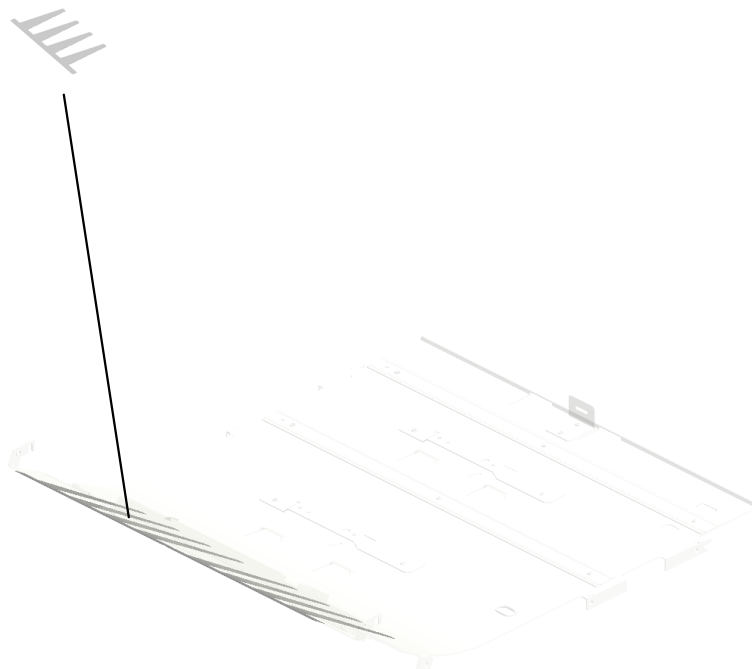

U001	U002	U003	U004	U005	U006	U007	U008	U009	U010	U011	U012	U013	U014	U015	U016	U017	U018	U019	U020	U021
------	------	------	------	------	------	------	------	------	------	------	------	------	------	------	------	------	------	------	------	------

U017 DUPLEX

- 10.AA043623 TIMING BELT - B40 S2M180
- 15.D0743173 TIMING PULLEY:S2 M:25T
- 4.04543006Q (x7) TAPPING SCREW - M3X6
- 21.D0744871 GUIDE PLATE:TRANSPORT ROLLER: DUPLEX:REVERSE
- 11.AA063674 (x2) SPRING - 8N

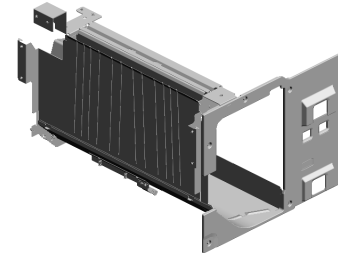

- 3.04514008N (x20) TAPPING SCREW: 4X8

- 18.D0744857 GUIDE PLATE:RECEIVING SUB-UNIT: LEFT LOWER:LEFT

- 5.04544008Q (x2) TAPPING SCREW - M4X8

- 9.11050723 CLAMPS:WES-050 7

- 8.11050511 (x7) HARNESS CLAMP - LWS-0306ZC

- 2.04513006N (x11) TAPPING SCREW - 3X6
- 20.D0744865 BRACKET:SENSOR:RECEIVING SUB-UNIT:LEFT LOWER
- 13.AW010143 PHOTO REFLECTIVE SENSOR:PSR11 TL1R-C
- 12.AA084059 (x2) BALL BEARING HOLDER
- 19.D0744860 GUIDE PLATE:RECEIVING SUB-UNIT: LEFT LOWER:LOWER

- 1.03530100N(x 1) SCREW-M3X10

- 6.07200060E (x2) RETAINING RING - M6

- 7.07423808 BALL BEARING - 8 X16X5

- 16.D0744559 DECAL:RECEIVING SUB-UNIT:E

- 17.D0744853 INNER COVER:RECEIVING SUB-UNIT:LEFT LOWER

- 14.B1325996 DECAL:TOTAL COVER

U017 DUPLEX

31.D0A54872 BRACKET:TRANSPORT ROLLER:DUPLEX:REVERSE:RIGHT
25.D0744885 GUIDE PLATE:PRESSURE ROLLER:DUPLEX:REVERSE:LEFT
30.M0774862 TRANSPORT ROLLER:DRIVEN:DUPLEX:DIA18X2

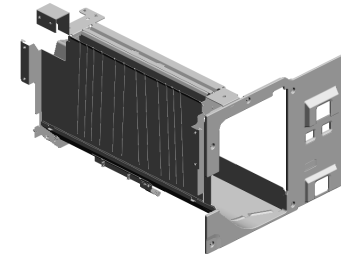

26.D1942999 DC STEPPER MOTOR:PAPER TRANSPORT MD:MM42:ASSY

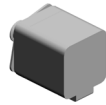

23.D0744875 BRACKET:MOTOR:DUPLEX:REVERSE



27.D1944612 TRANSPORT ROLLER:DRIVE:REVERSE



29.D1947380 (x3) (-AA,-NA,-EU):DECAL:SWITCH:HEATER:INTERMEDIATE TRANSFER

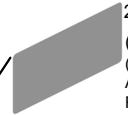

28.D1947377 (x3) (-AA,-NA,-EU):DECAL:SWITCH:HEATER:PAPER TRAY



24.D0744881 GUIDE PLATE:PRESSURE ROLLER:DUPLEX:REVERSE

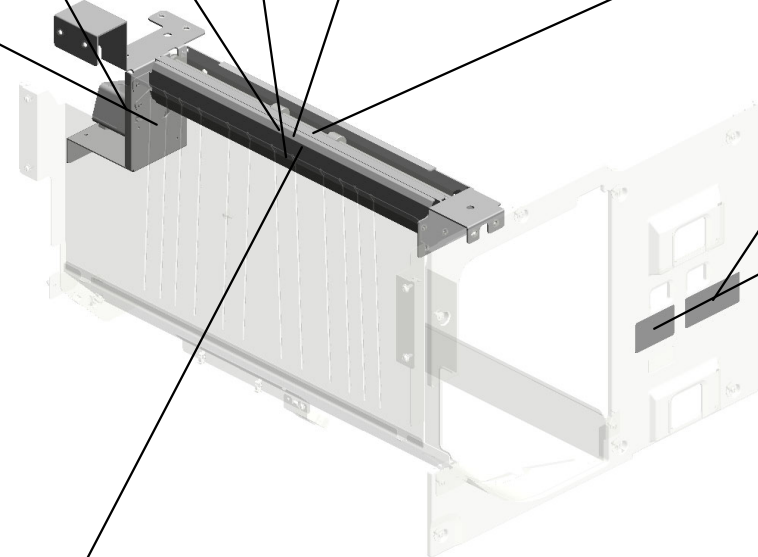

U018.MAIN DRIVE

U018 S010
D1941450
DRIVE UNIT:AROUND THE P
HOTOCONDUCTOR:CMY:AS
S'Y

U018 S012
D1941450
DRIVE UNIT:AROUND THE P
HOTOCONDUCTOR:CMY:AS
S'Y

U018 S008
D1941420
DRIVE UNIT:AROUND THE P
HOTOCONDUCTOR:ASS'Y

U018 S011
D1941450
DRIVE UNIT:AROUND THE P
HOTOCONDUCTOR:CMY:AS
S'Y

U018 S001
D1941605
SHAFT:DRIVE:EXIT:ASS'Y

U018 S009
D1941420
DRIVE UNIT:AROUND THE P
HOTOCONDUCTOR:ASS'Y

U018 S006
D1941528
SHAFT:OUTPUT:POLISH:ON-
OFF:ASS'Y

U018 S002
D1941509
SHAFT:DRIVE:BELT CLEANI
NG:ASS'Y

U018 S007
D1941532
SHAFT:OUTPUT:POLISH:FU
SING:ASS'Y

U018 S003
D1941508
SHAFT:DRIVE:TRANSFER:A
SS'Y

U018 S005
D1941538
SHAFT:OUTPUT:DRIVE:FUSI
NG:ASS'Y

U018 S004
D0741424
BRACKET:TIGHTENER:ASS'
Y

U001	U002	U003	U004	U005	U006	U007	U008	U009	U010	U011	U012	U013	U014	U015	U016	U017	U018	U019	U020	U021
------	------	------	------	------	------	------	------	------	------	------	------	------	------	------	------	------	------	------	------	------

U018.MAIN DRIVE

U018 S013
D1941630
(D203/D204):SHAFT:OUTPUT
:ON-OFF:5ST:ASS'Y

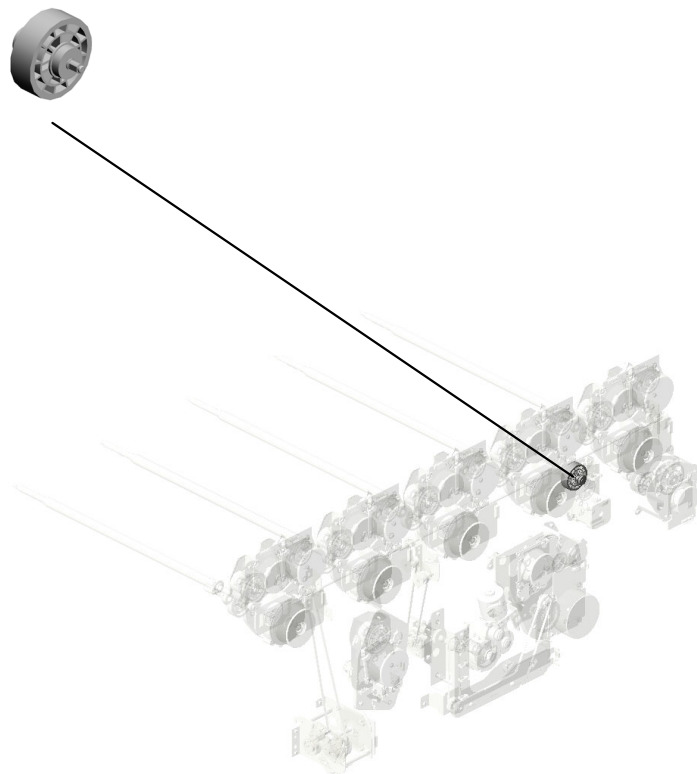

U001	U002	U003	U004	U005	U006	U007	U008	U009	U010	U011	U012	U013	U014	U015	U016	U017	U018	U019	U020	U021
------	------	------	------	------	------	------	------	------	------	------	------	------	------	------	------	------	------	------	------	------

U018_S008.DRIVE UNIT:AROUND THE PHOTOCONDUCTOR:ASS'Y

U018 S008 S002
D1941425
SHAFT:DRIVE:BRUSH ROLL
ER:ASS'Y

U018 S008 S003
D0A51431
SHAFT:DRIVE:DEVELOPME
NT SLEEVE:ASS'Y

U018 S008 S001
D1941421
SHAFT:DRIVE:TRANSPORT
SCREW:ASS'Y

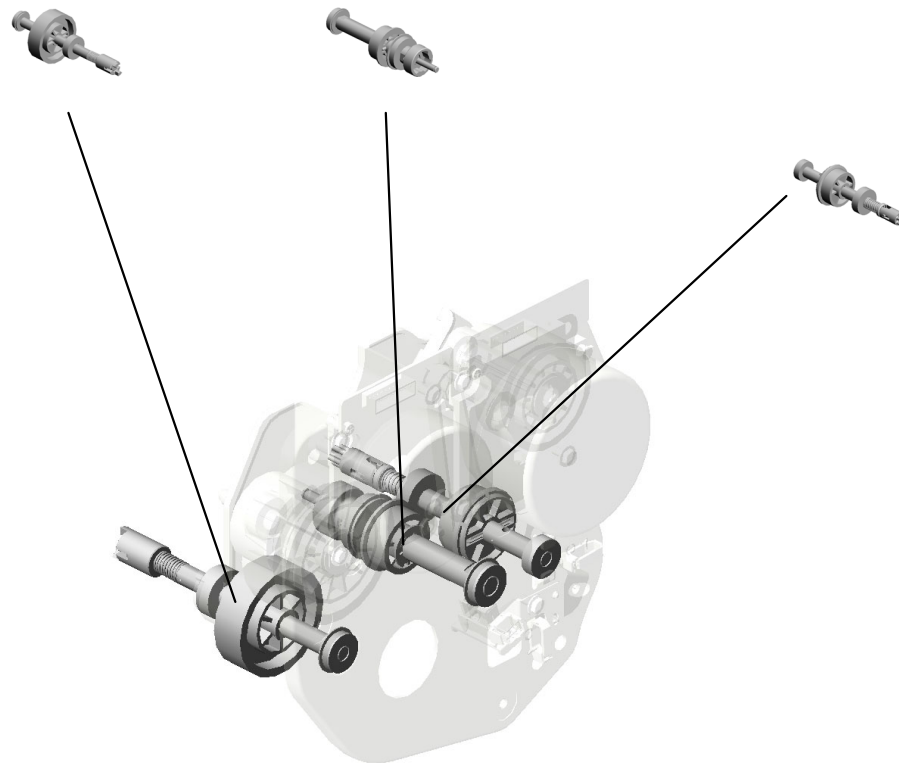

U001	U002	U003	U004	U005	U006	U007	U008	U009	U010	U011	U012	U013	U014	U015	U016	U017	U018	U019	U020	U021
------	------	------	------	------	------	------	------	------	------	------	------	------	------	------	------	------	------	------	------	------

U018_S009.DRIVE UNIT:AROUND THE PHOTOCONDUCTOR:ASS'Y

U018 S009 S002
D1941425
SHAFT:DRIVE:BRUSH ROLL
ER:ASS'Y

U018 S009 S003
D0A51431
SHAFT:DRIVE:DEVELOPME
NT SLEEVE:ASS'Y

U018 S009 S001
D1941421
SHAFT:DRIVE:TRANSPORT
SCREW:ASS'Y

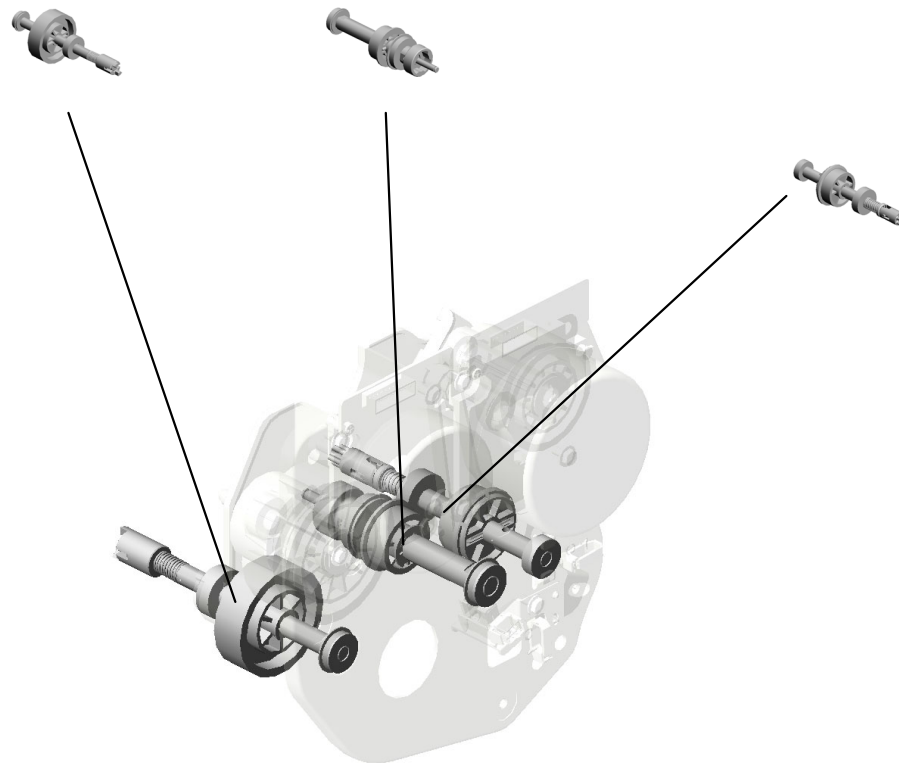

U001	U002	U003	U004	U005	U006	U007	U008	U009	U010	U011	U012	U013	U014	U015	U016	U017	U018	U019	U020	U021
------	------	------	------	------	------	------	------	------	------	------	------	------	------	------	------	------	------	------	------	------

U018_S010.DRIVE UNIT:AROUND THE PHOTOCONDUCTOR:CMY:ASS'Y

U018 S010 S001
D1941425
SHAFT:DRIVE:BRUSH ROLL
ER:ASSY

U018 S010 S002
D0A51431
SHAFT:DRIVE:DEVELOPME
NT SLEEVE:ASSY

U018 S010 S003
D1941451
SHAFT:DRIVE:TRANSPORT
SCREW:CMY:ASS'Y

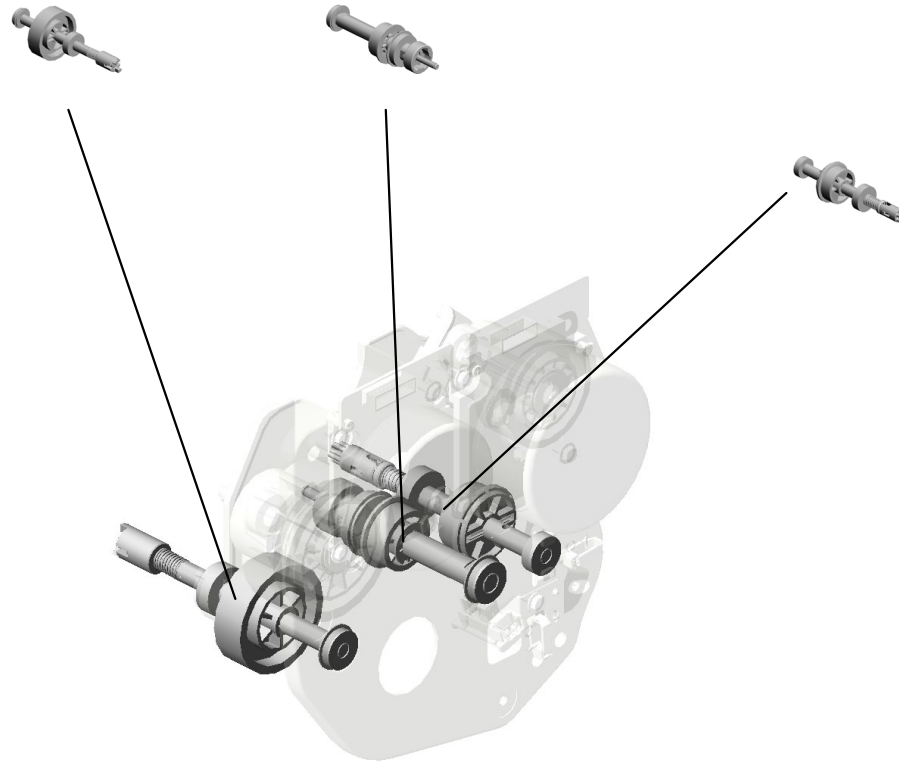

U001	U002	U003	U004	U005	U006	U007	U008	U009	U010	U011	U012	U013	U014	U015	U016	U017	U018	U019	U020	U021
------	------	------	------	------	------	------	------	------	------	------	------	------	------	------	------	------	------	------	------	------

U018_S011.DRIVE UNIT:AROUND THE PHOTOCONDUCTOR:CMY:ASS'Y

U018 S011 S001
D1941425
SHAFT:DRIVE:BRUSH ROLL
ER:ASSY

U018 S011 S002
D0A51431
SHAFT:DRIVE:DEVELOPME
NT SLEEVE:ASSY

U018 S011 S003
D1941451
SHAFT:DRIVE:TRANSPORT
SCREW:CMY:ASS'Y

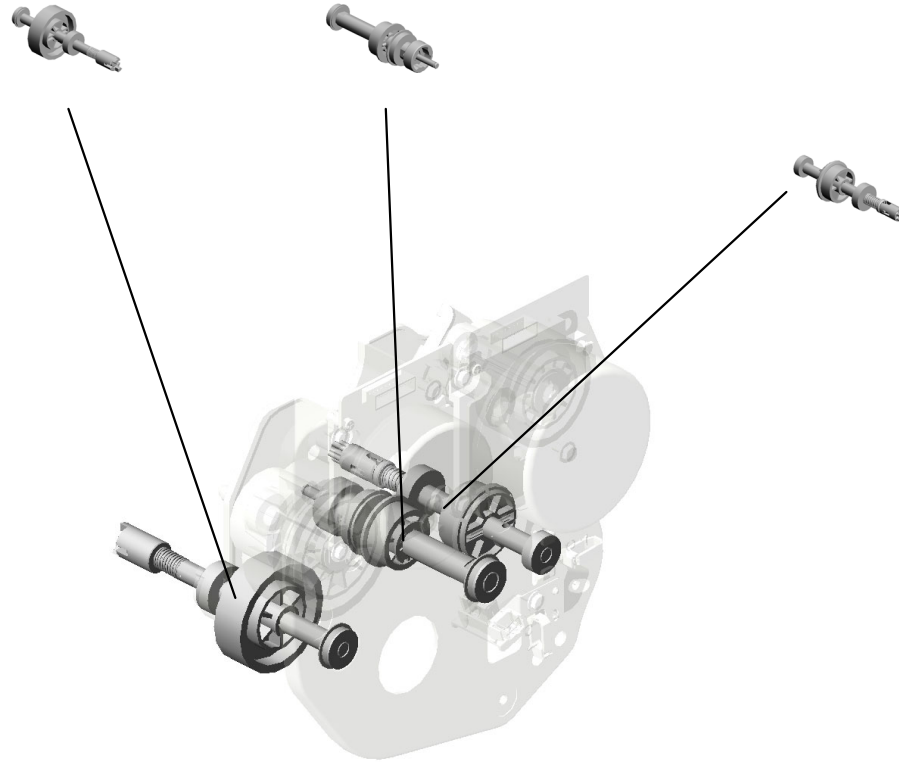

U001	U002	U003	U004	U005	U006	U007	U008	U009	U010	U011	U012	U013	U014	U015	U016	U017	U018	U019	U020	U021
------	------	------	------	------	------	------	------	------	------	------	------	------	------	------	------	------	------	------	------	------

U018_S012.DRIVE UNIT:AROUND THE PHOTOCONDUCTOR:CMY:ASS'Y

U018 S012 S001
D1941425
SHAFT:DRIVE:BRUSH ROLL
ER:ASSY

U018 S012 S002
D0A51431
SHAFT:DRIVE:DEVELOPME
NT SLEEVE:ASSY

U018 S012 S003
D1941451
SHAFT:DRIVE:TRANSPORT
SCREW:CMY:ASS'Y

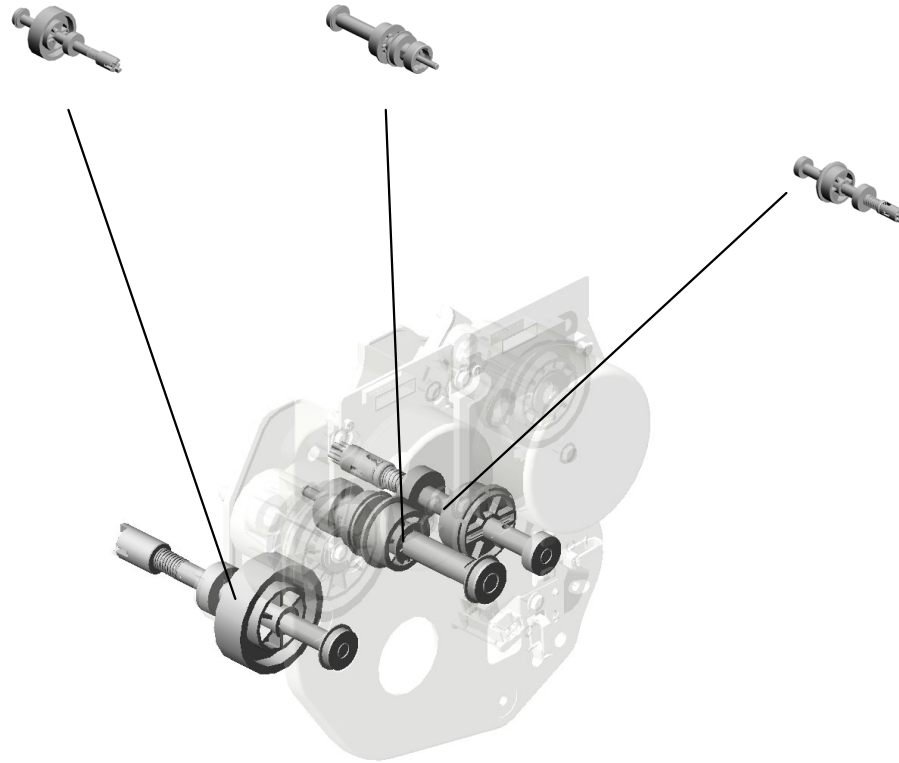

U001	U002	U003	U004	U005	U006	U007	U008	U009	U010	U011	U012	U013	U014	U015	U016	U017	U018	U019	U020	U021
------	------	------	------	------	------	------	------	------	------	------	------	------	------	------	------	------	-------------	------	------	------

U018 MAIN DRIVE

7.03604010N (x15) SCREW:M4X10
 1.03530050N (x4) SCREW-M3X5
 23.11050487 HARNESS CLAMP
 4.03603014N (x5) SCREW - M3X14
 22.09544008N (x10) SCREW - M4X8

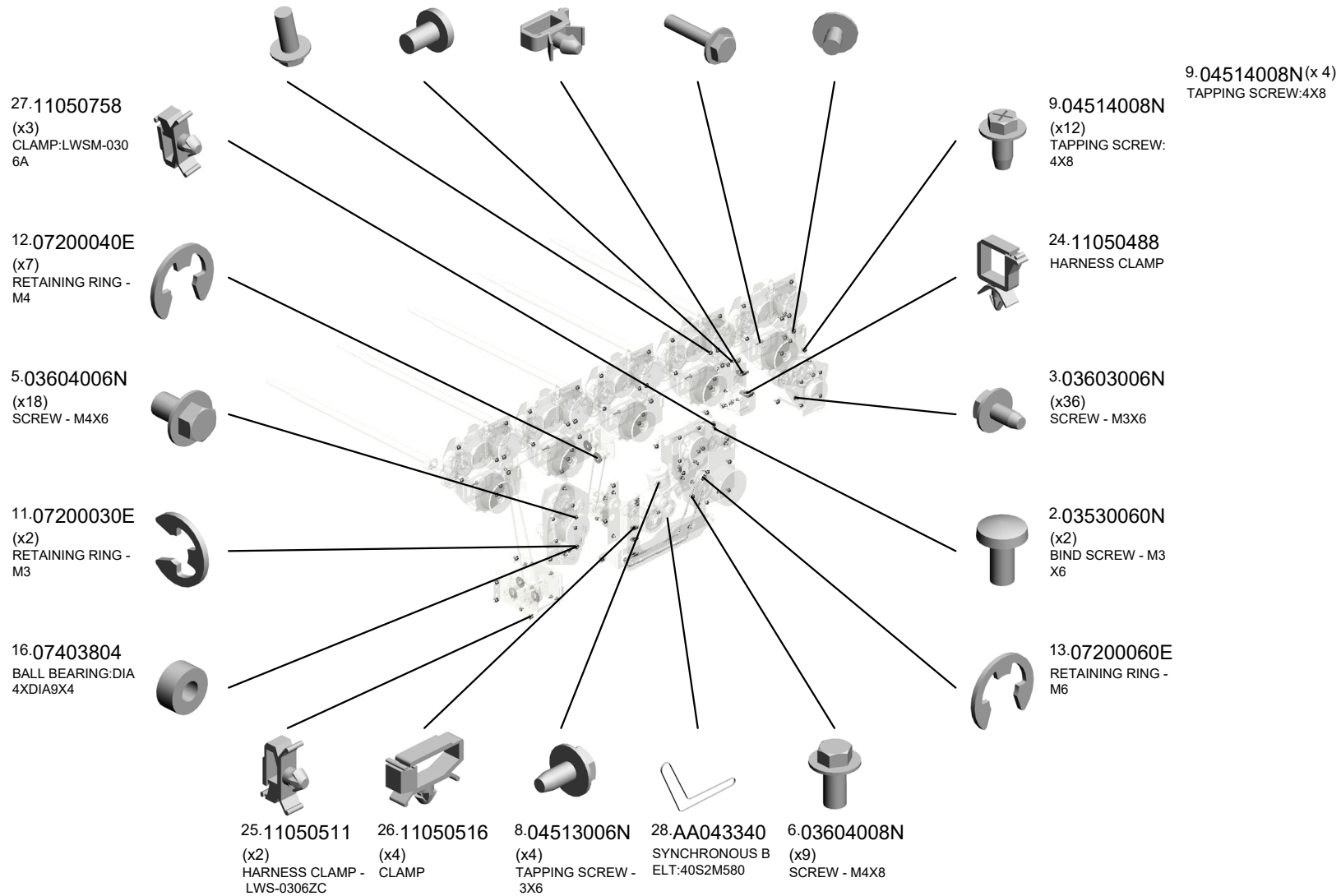
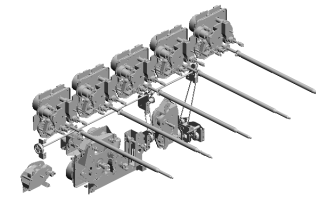

U018 MAIN DRIVE

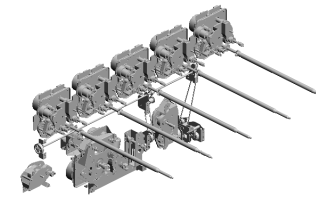

- 54.AB030850 PULLEY:TIGHTENER:DRIVE:USED TONER
- 47.AB017881 GEAR:PULLEY:DRIVE:USED TONER:44Z/32T
- 30.AA043645 SYNCHRONOUS BELT:40S2M426
- 34.AA061111 TENSION SPRING:MIDDLE:DRIVE:USED TONER
- 45.AB017860 (D203/D204):GEAR:DRIVE:Z61:Z18

41.AB017820
GEAR:DRIVE:101Z/52Z



31.AA043646
SYNCHRONOUS BELT:40S2M596



48.AB017882
GEAR:DRIVE UNIT:USED TONER:48Z/24Z



33.AA061110
TENSION SPRING:TIGHTENER:DRIVE UNIT:USED TONER



37.AB011550
GEAR:DRIVE UNIT:USED TONER:35Z



49.AB017883
GEAR:IDLER:DRIVE UNIT:USED TONER:77Z/23Z



50.AB017884
GEAR:PULLEY:DRIVE UNIT:USED TONER:36Z/32T



52.AB030840
TIMING PULLEY:S2M:26T/40T



53.AB030841
TIMING PULLEY:OUTPUT:VACUUM:2M:32T

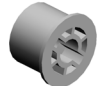

35.AA061112
TENSION SPRING:TIGHTENER



39.AB013765
GEAR:DRIVE:USED TONER:36Z



46.AB017880
GEAR:IDLER:DRIVE:EXIT:Z101/42



40.AB017815
GEAR:Z24:Z41



51.AB030838
TIMING PULLEY:DRIVE:FLAT CONVEYER BELT



44.AB017859
GEAR:Z17:Z61



U018 MAIN DRIVE

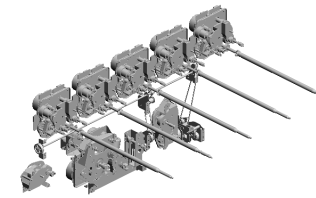

- 55.AB030851 (x2) PULLEY:DRIVE:USED TONER:25T
- 56.AB030852 (x2) PULLEY:IDLER:DRIVE:USED TONER:32T
- 81.D0741465 BRACKET:TENSION:DRIVE:USED TONER:ASSY
- 80.D0741464 SHAFT:RIGHT:DRIVE:USED TONER:ASSY
- 64.AX061315 (x5) DC MOTOR:DIA65:24V:23.5W

73.D0741390
SHAFT:OUTPUT:DRIVE:VACUUM:ASSY

71.D0741379
BRACKET:PLATE

65.AX061316
DC MOTOR:DIA63:27.7W:BRUSHLESS

58.AW020217
(x2) OPTICS SENSOR:ENCODER:300LPI

70.D0741369
COVER:ENCODER

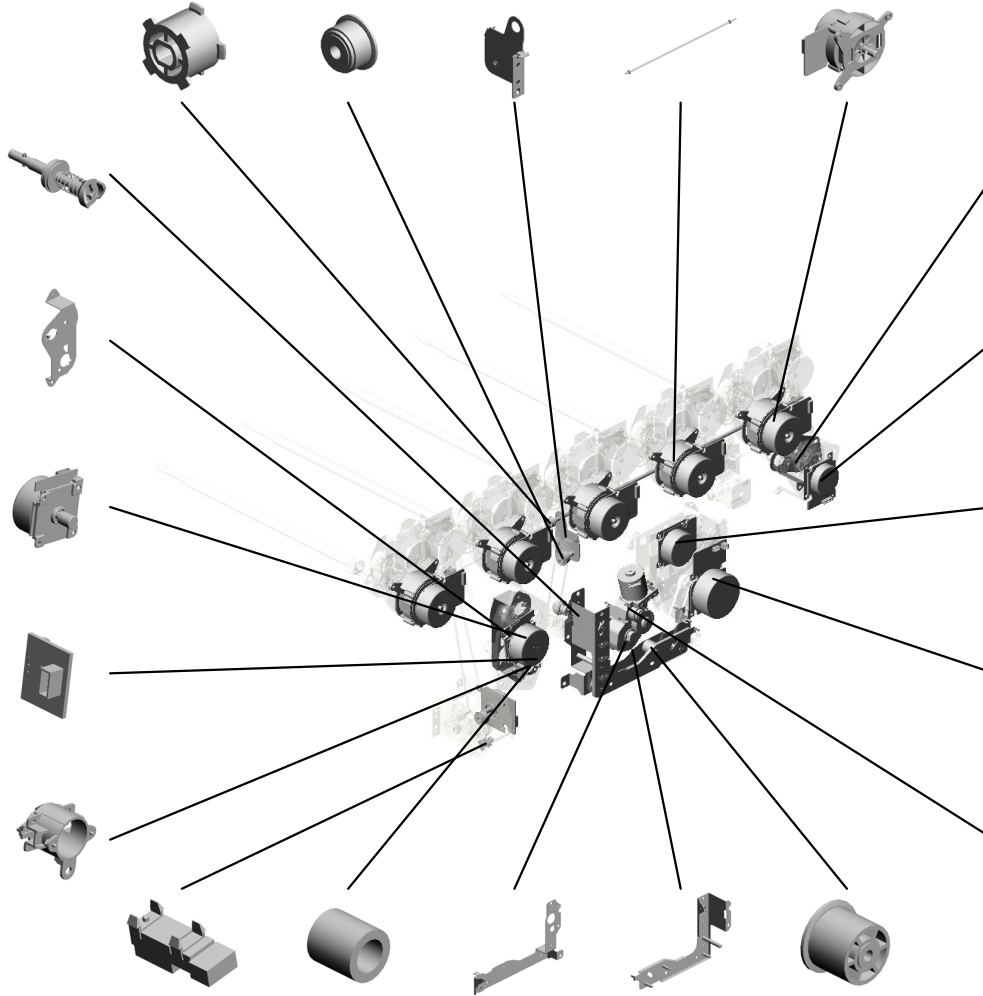

79.D0741460
BRACKET:AUXILIARY:DRIVE:EXIT

78.D0741454
(x2) DC MOTOR:DIA49:9.8W:BLS

59.AX060453
DC MOTOR:DIA55:40W:BRUSHLESS

62.AX060462
DC MOTOR:DIA73:56W:BRUSHLESS

61.AX060510
DRIVE SUB-UNIT:ON-OFF:PRESSURE ROLLER 201601-06 X/O

57.AW020198
PHOTO INTERRUPTOR:LG2A14NL1

67.B2236171
RUBBER BUSHING:ENCODER

74.D0741411
BRACKET:DRIVE:VACUUM:LOWER

75.D0741412
BRACKET:DRIVE:VACUUM:UPPER:ASSY

77.D0741426
PULLEY:IDLER

U018 MAIN DRIVE

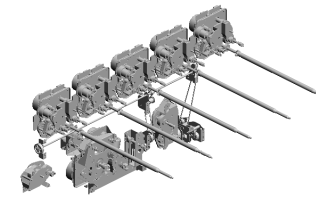

- 90.D0741496 JOINT:DRIVE:USED TONER
- 82.D0741466 BRACKET:TIGHTENER:DRIVE:USED TONER:ASSY
- 92.D1941412 (x5) DRUM SHAFT:ASSY
- 112.D1941629 (D203/D204):JOINT:DRIVE:ON-OFF:5S T
- 86.D0741476 HOLDER:RIGHT:DRIVE:USED TONER

84.D0741470
SHAFT:LEFT:DRIVE:USED TONER:ASSY

87.D0741484
HOLDER:LEFT:DRIVE:USED TONER

83.D0741468
BRACKET:MIDDLE:DRIVE:USED TONER:ASSY

102.D1941501
BRACKET:DC BRUSHLESS MOTOR:ASSY

88.D0741486
BRACKET:MOTOR:DRIVE:USED TONER

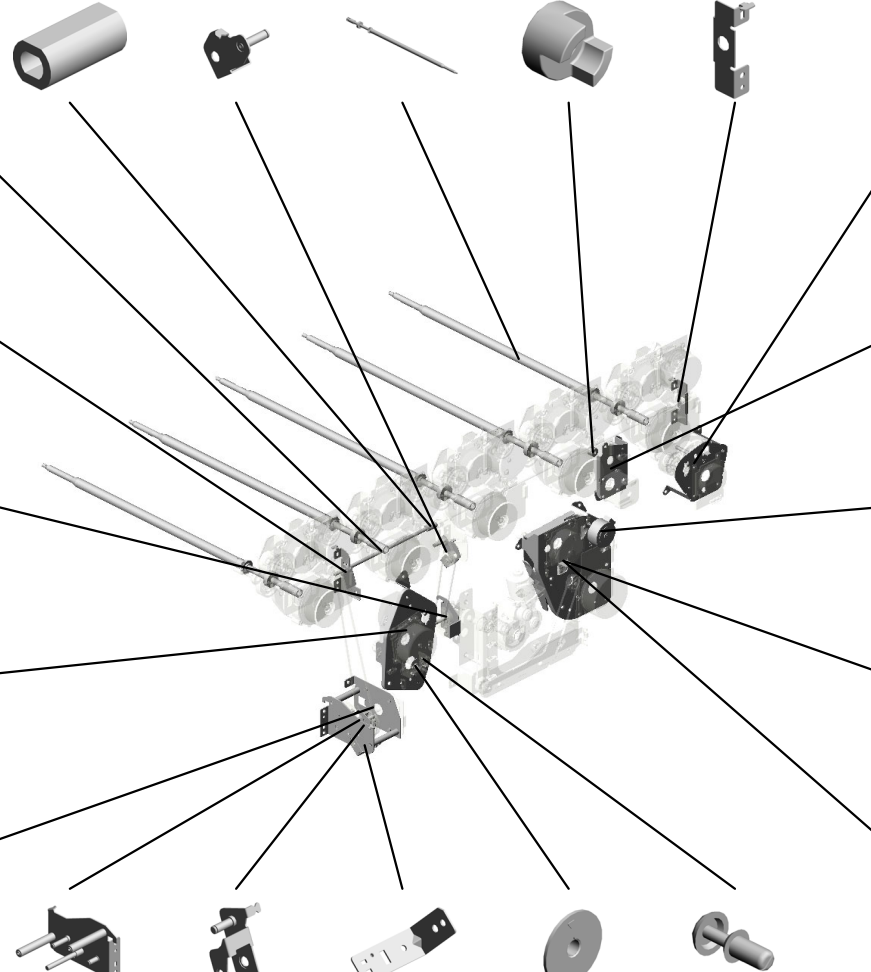

110.D1941604
BRACKET:DRIVE:EXIT:ASSY

114.D1941631
(D203/D204):BRACKET:DRIVE:ON-OFF:5S:ASSY

115.D1946177
DC STEPPER MOTOR: DIA42:24V

105.D1941521
BRACKET:SECONDARY:DRIVE:FUSING

106.D1941522
BRACKET:DRIVE:FUSING

- 89.D0741487 BRACKET:DRIVE UNIT:USED TONER
- 85.D0741473 BRACKET:TENSIONER:DRIVE UNIT:USED TONER:ASSY
- 91.D0741498 BRACKET:SENSOR
- 118.G1786352 GUIDE PLATE:ENCORDER
- 117.G1073834 (x4) RIVET - 2.0

U018 MAIN DRIVE

119.D1941496
ENCODER:ASS'Y
201710-07 O/O

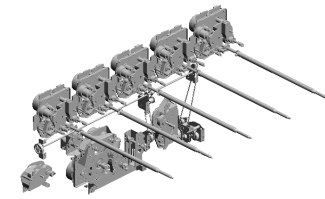

120.11050760
(x6)
CLAMP:LWSM-051
1A
201712-01 O/O

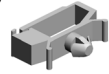

125.AX061318
(D203/D204):DC ST
EPPER MOTOR:M
M42:1.35A
202301-05 O/O

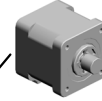

124.AA043724
SYNCHRONOUS B
ELT:40S2M288
202006-06 O/O



U001	U002	U003	U004	U005	U006	U007	U008	U009	U010	U011	U012	U013	U014	U015	U016	U017	U018	U019	U020	U021
------	------	------	------	------	------	------	------	------	------	------	------	------	------	------	------	------	------	------	------	------

U018_S001
SHAFT:DRIVE:EXIT:ASS'Y

38.AB011551
GEAR:DRIVE:EXIT:
47Z

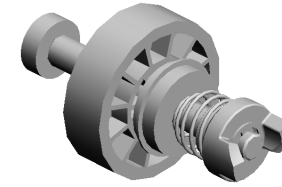

111.D1941605
SHAFT:DRIVE:EXIT
:ASS'Y

72.D0741389
COMPRESSION SP
RING:JOINT:TRAN
SPORT

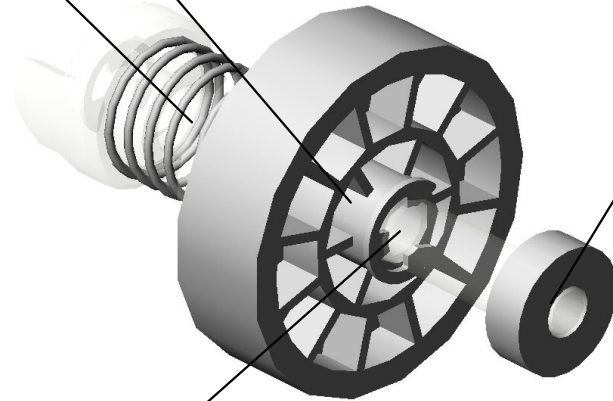

17.07403906
BALL BEARING - 6
X15X5



13.07200060E
RETAINING RING -
M6

U001	U002	U003	U004	U005	U006	U007	U008	U009	U010	U011	U012	U013	U014	U015	U016	U017	U018	U019	U020	U021
------	------	------	------	------	------	------	------	------	------	------	------	------	------	------	------	------	------	------	------	------

U018_S002
SHAFT:DRIVE:BELT CLEANING:ASS'Y

15.07403008
BALL BEARING - 8
X22X7

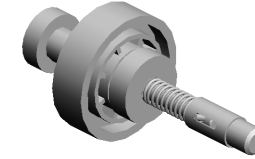

103.D1941509
[A]
SHAFT:DRIVE:BEL
T CLEANING:ASS'Y
201604-01 O/O



D1941506
[A]
SHAFT:DRIVE:TRA
NSFER:ASS'Y
201604-02 O/O

U001	U002	U003	U004	U005	U006	U007	U008	U009	U010	U011	U012	U013	U014	U015	U016	U017	U018	U019	U020	U021
------	------	------	------	------	------	------	------	------	------	------	------	------	------	------	------	------	------	------	------	------

U018_S003
SHAFT:DRIVE:TRANSFER:ASS'Y

36.AB010215
GEAR:DRIVE:155Z
201601-02 O/O

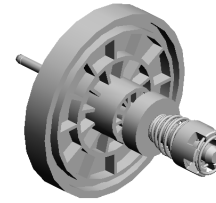

104.D1941508
SHAFT:DRIVE:TRA
NSFER:ASS'Y
201604-02 O/O



U001	U002	U003	U004	U005	U006	U007	U008	U009	U010	U011	U012	U013	U014	U015	U016	U017	U018	U019	U020	U021
------	------	------	------	------	------	------	------	------	------	------	------	------	------	------	------	------	------	------	------	------

U018_S004
BRACKET:TIGHTENER:ASS'Y

12.07200040E
RETAINING RING -
M4

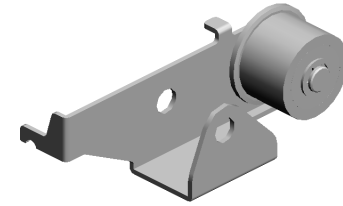

76.D0741424
BRACKET:TIGHTE
NER:ASS'Y

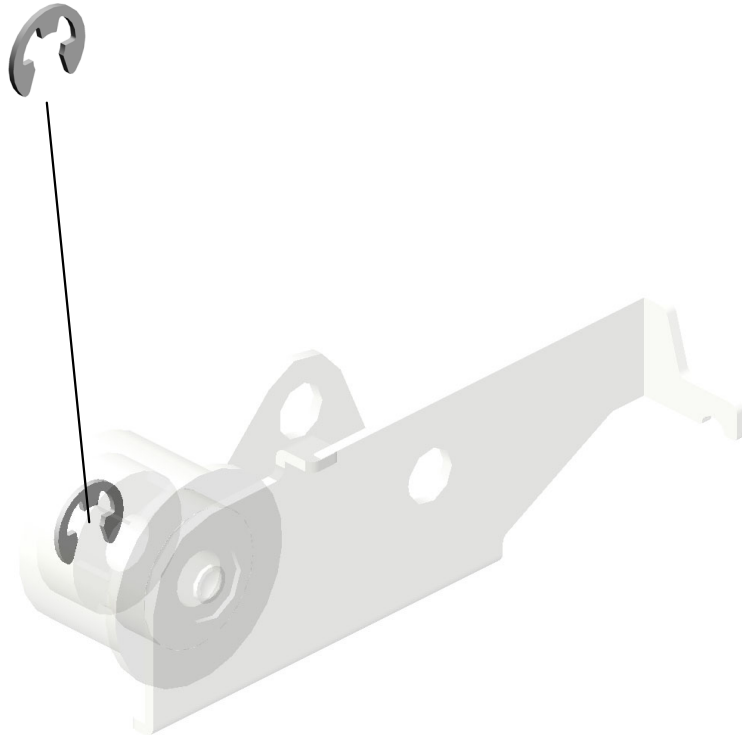

U001	U002	U003	U004	U005	U006	U007	U008	U009	U010	U011	U012	U013	U014	U015	U016	U017	U018	U019	U020	U021
------	------	------	------	------	------	------	------	------	------	------	------	------	------	------	------	------	------	------	------	------

U018_S005
SHAFT:OUTPUT:DRIVE:FUSING:ASS'Y

20.07433808
RADIAL BALL BEA
RING: DIA8X DIA16X
5

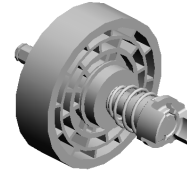

107.D1941538
SHAFT:OUTPUT:D
RIVE:FUSING:ASS'
Y
201603-01 O/O



14.07200080E
RETAINING RING -
M8

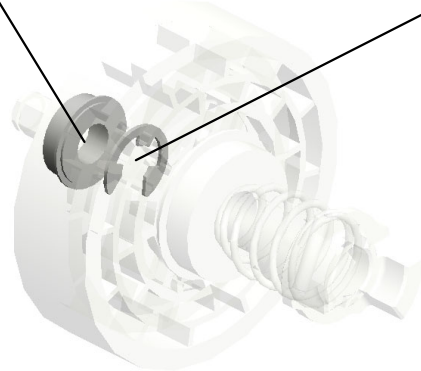

U001	U002	U003	U004	U005	U006	U007	U008	U009	U010	U011	U012	U013	U014	U015	U016	U017	U018	U019	U020	U021
------	------	------	------	------	------	------	------	------	------	------	------	------	------	------	------	------	------	------	------	------

U018_S006
SHAFT:OUTPUT:POLISH:ON-OFF:ASS'Y

21.07433906
RADIAL BALL BEA
RING:DIA6X DIA15X
5

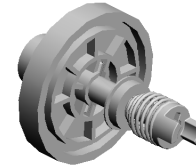

108.D1941528
SHAFT:OUTPUT:P
OLISH:ON-OFF:AS
SY



U001	U002	U003	U004	U005	U006	U007	U008	U009	U010	U011	U012	U013	U014	U015	U016	U017	U018	U019	U020	U021
------	------	------	------	------	------	------	------	------	------	------	------	------	------	------	------	------	------	------	------	------

U018_S007
SHAFT:OUTPUT:POLISH:FUSING:ASS'Y

21.07433906 13.07200060E
RADIAL BALL BEA RETAINING RING -
RING:DIA6XDIA15X M6
5

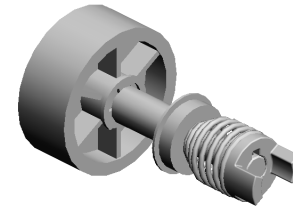

109.D1941532
SHAFT:OUTPUT:P
OLISH:FUSING:AS
SY



U001	U002	U003	U004	U005	U006	U007	U008	U009	U010	U011	U012	U013	U014	U015	U016	U017	U018	U019	U020	U021
------	------	------	------	------	------	------	------	------	------	------	------	------	------	------	------	------	------	------	------	------

DRIVE UNIT:AROUND THE PHOTOCONDUCTOR:ASS'Y

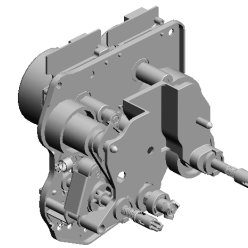

122.D1941420
DRIVE UNIT:AROU
ND THE PHOTOCO
NDUCTOR:ASS'Y

63.AX060463 DC MOTOR:DIA56:
14.7W:BRUSHLES
S
116.G0603945 TIMING BELT - TRA
NSFER BELT DRIV
E
99.D1941437 TIGHTENER:DEVE
LOPMENT SLEEVE
42.AB017857 GEAR:PULLEY:DE
VELOPMENT DRIV
E UNIT:65Z/30T

11.07200030E
RETAINING RING -
M3

10.07080040N
WASHER - DIA4

97.D1941433
JOINT:DEVELOPM
ENT SLEEVE:DRIV
E:MIDDLE

43.AB017858
GEAR:64Z/51Z

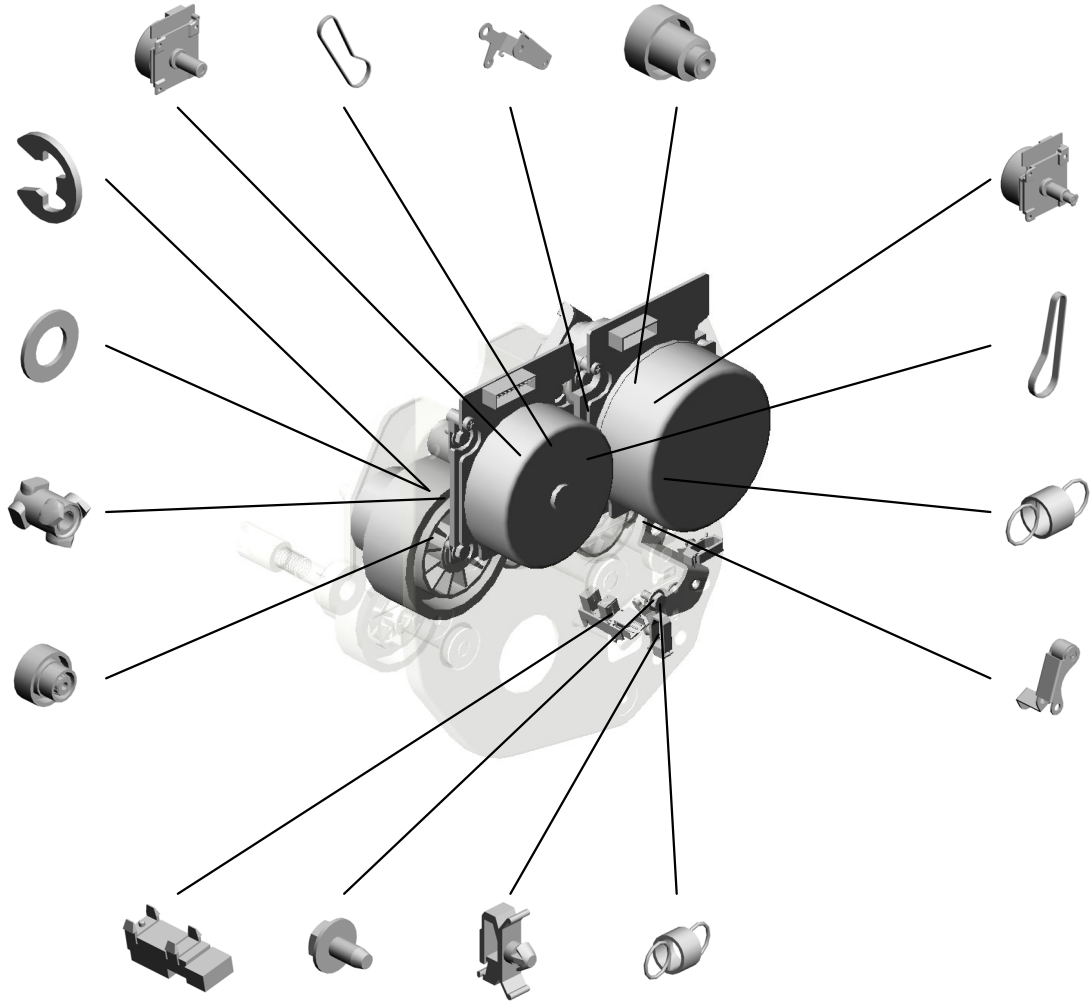

60.AX060459
DC MOTOR:DIA63:
24V:24.4W:BRUSH
LESS

32.AA043989
SYNCHRONOUS B
ELT:60S2M194

98.D1941436
TENSION SPRING:
TIGHTENER:DRIVE
:AROUND THE PH
OTOCONDUCTOR

95.D1941428
TIGHTENER:DRIVE
:DEVELOPMENT:A
SS'Y

57.AW020198 PHOTOINTERRUP
TOR:LG2A14NL1
3.03603006N (x9)
SCREW - M3X6
25.11050511 (x2)
HARNES CLAMP -
LWS-0306ZC
100.D1941441 TENSION SPRING:
DEVELOPMENT

U018_S008_S001
SHAFT:DRIVE:TRANSPORT SCREW:ASS'Y

13.07200060E
RETAINING RING -
M6

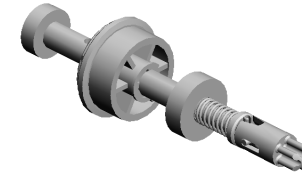

93.D1941421
SHAFT:DRIVE:TRA
NSPORT SCREW:A
SS'Y

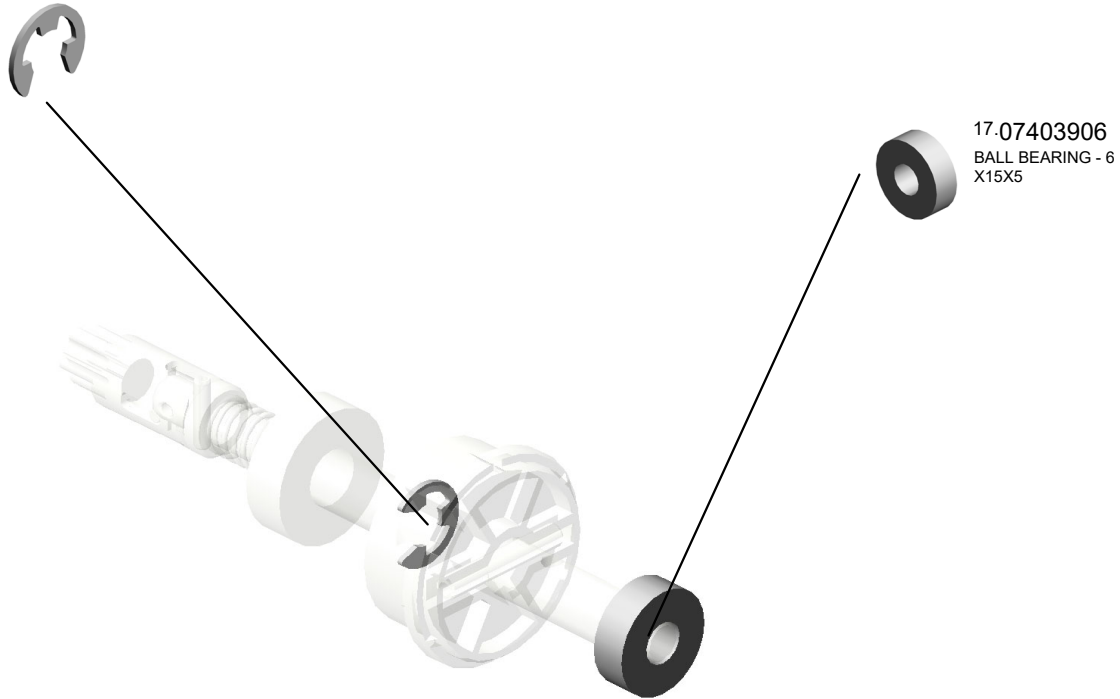

17.07403906
BALL BEARING - 6
X15X5

U001	U002	U003	U004	U005	U006	U007	U008	U009	U010	U011	U012	U013	U014	U015	U016	U017	U018	U019	U020	U021
------	------	------	------	------	------	------	------	------	------	------	------	------	------	------	------	------	------	------	------	------

U018_S008_S002
SHAFT:DRIVE:BRUSH ROLLER:ASS'Y

13.07200060E
RETAINING RING -
M6

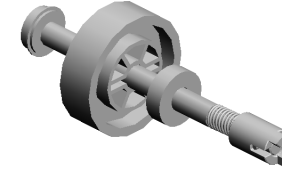

94.D1941425
SHAFT:DRIVE:BRU
SH ROLLER:ASS'Y

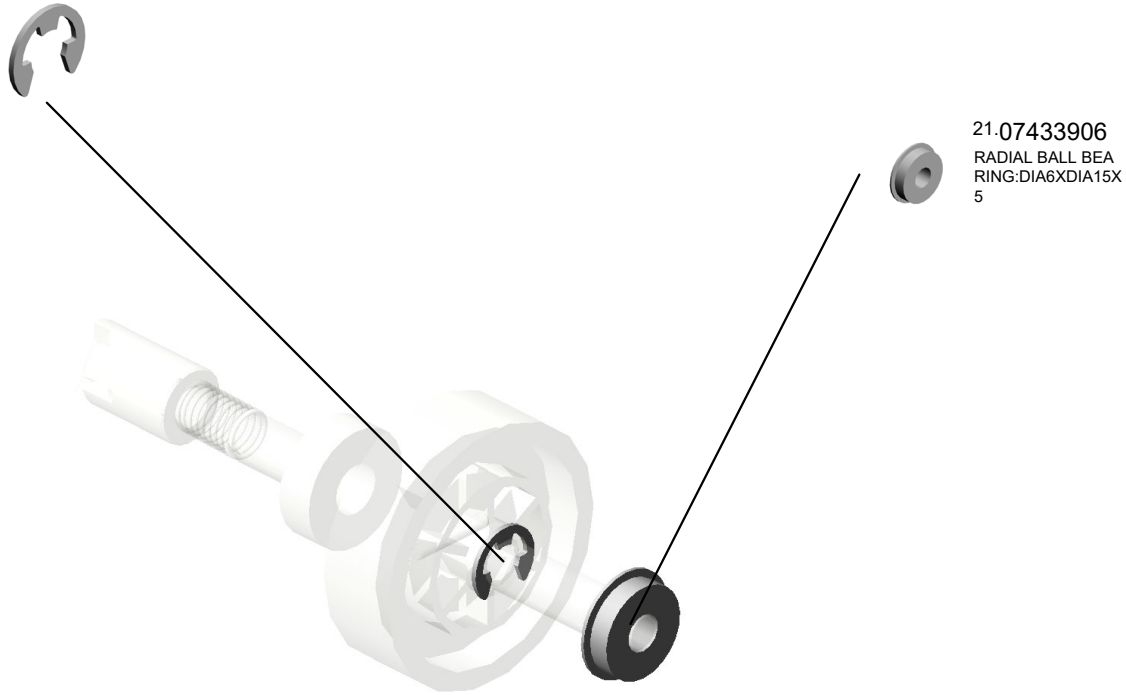

21.07433906
RADIAL BALL BEA
RING:DIA6XDIA15X
5

U001	U002	U003	U004	U005	U006	U007	U008	U009	U010	U011	U012	U013	U014	U015	U016	U017	U018	U019	U020	U021
------	------	------	------	------	------	------	------	------	------	------	------	------	------	------	------	------	------	------	------	------

U018_S008_S003

SHAFT:DRIVE:DEVELOPMENT SLEEVE:ASS'Y

20.07433808
RADIAL BALL BEA
RING: DIA8X DIA16X
5

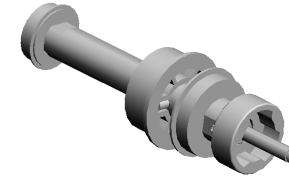

121.D0A51431

[A]
SHAFT:DRIVE:DEV
ELOPMENT SLEEV
E:ASSY
201812-10 O/O

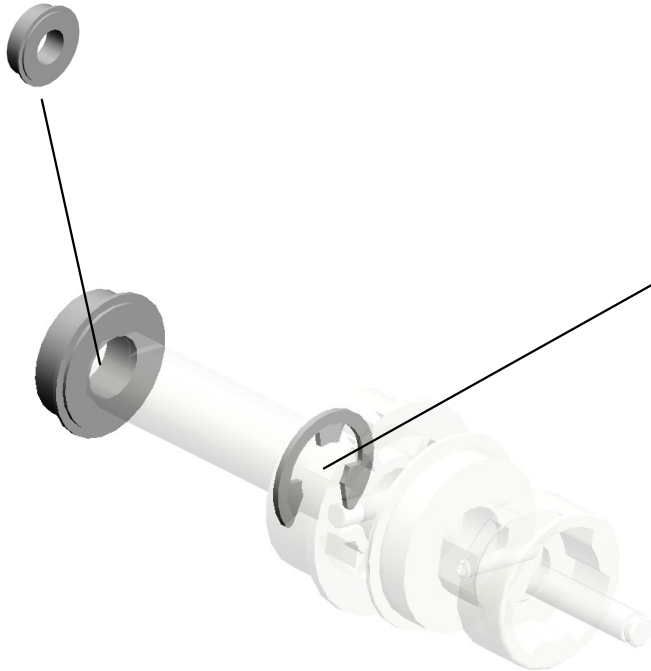

14.07200080E
RETAINING RING -
M8

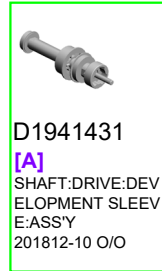

D1941431

[A]
SHAFT:DRIVE:DEV
ELOPMENT SLEEV
E:ASSY
201812-10 O/O

U001	U002	U003	U004	U005	U006	U007	U008	U009	U010	U011	U012	U013	U014	U015	U016	U017	U018	U019	U020	U021
------	------	------	------	------	------	------	------	------	------	------	------	------	------	------	------	------	------	------	------	------

U018_S009

DRIVE UNIT:AROUND THE PHOTOCONDUCTOR:ASS'Y

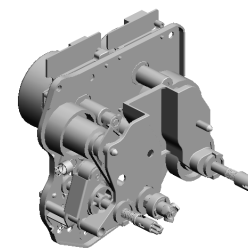

122.D1941420
DRIVE UNIT:AROU
ND THE PHOTOCO
NDUCTOR:ASS'Y

63.AX060463 DC MOTOR:DIA56:
14.7W:BRUSHLES
S
116.G0603945 TIMING BELT - TRA
NSFER BELT DRIV
E
99.D1941437 TIGHTENER:DEVE
LOPMENT SLEEVE
42.AB017857 GEAR:PULLEY:DE
VELOPMENT DRIV
E UNIT:65Z/30T

11.07200030E
RETAINING RING -
M3

10.07080040N
WASHER - DIA4

97.D1941433
JOINT:DEVELOPM
ENT SLEEVE:DRIV
E:MIDDLE

43.AB017858
GEAR:64Z/51Z

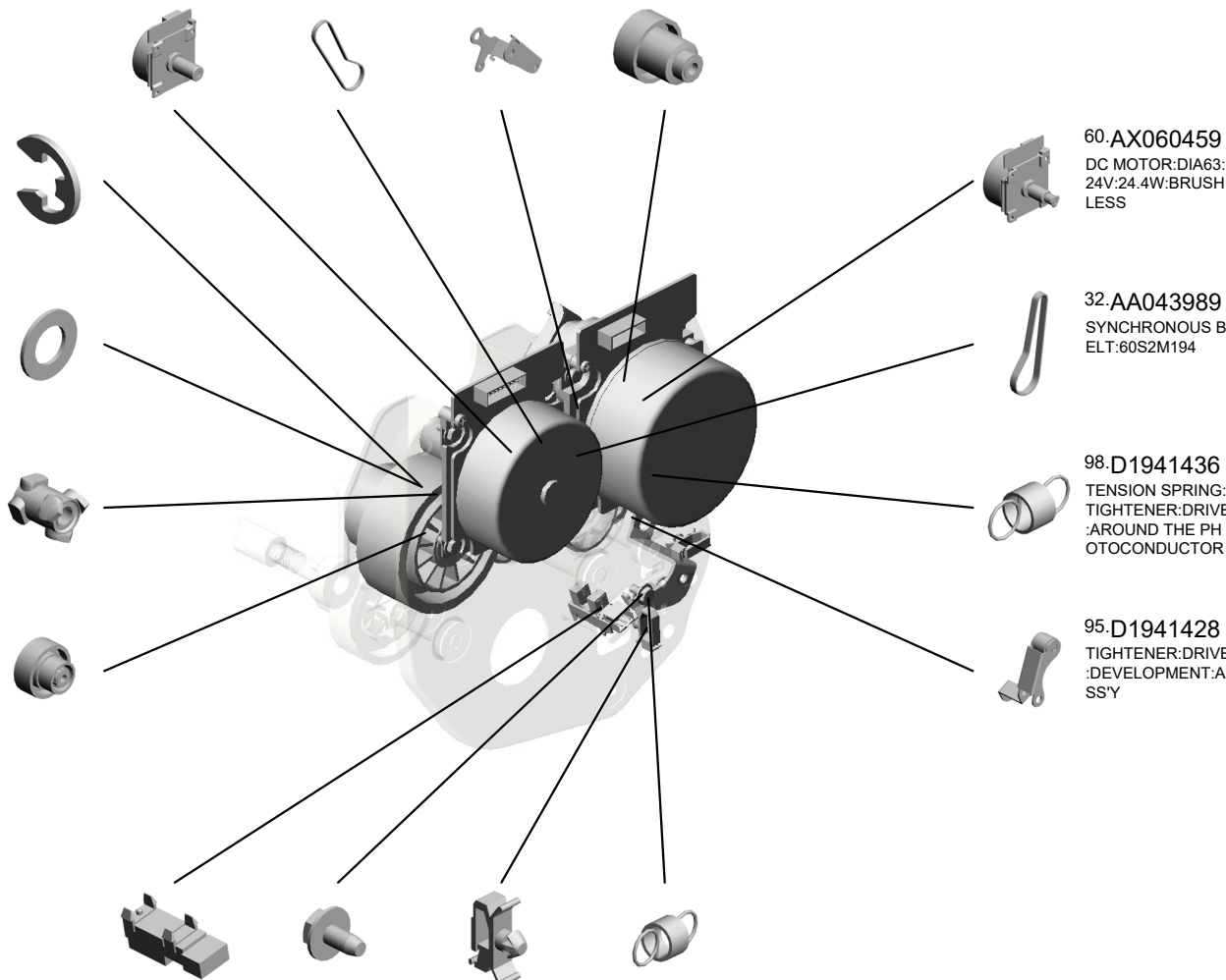

60.AX060459
DC MOTOR:DIA63:
24V:24.4W:BRUSH
LESS

32.AA043989
SYNCHRONOUS B
ELT:60S2M194

98.D1941436
TENSION SPRING:
TIGHTENER:DRIVE
:AROUND THE PH
OTOCONDUCTOR

95.D1941428
TIGHTENER:DRIVE
:DEVELOPMENT:A
SS'Y

57.AW020198 PHOTOINTERRUP
TOR:LG2A14NL1
3.03603006N (x9)
SCREW - M3X6
25.11050511 (x2)
HARNES CLAMP -
LWS-0306ZC
100.D1941441 TENSION SPRING:
DEVELOPMENT

U001	U002	U003	U004	U005	U006	U007	U008	U009	U010	U011	U012	U013	U014	U015	U016	U017	U018	U019	U020	U021
------	------	------	------	------	------	------	------	------	------	------	------	------	------	------	------	------	------	------	------	------

U018_S009_S001
SHAFT:DRIVE:TRANSPORT SCREW:ASS'Y

13.07200060E
RETAINING RING -
M6

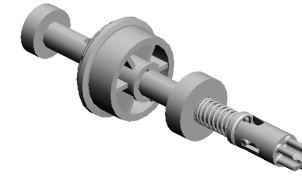

93.D1941421
SHAFT:DRIVE:TRA
NSPORT SCREW:A
SS'Y



17.07403906
BALL BEARING - 6
X15X5

U001	U002	U003	U004	U005	U006	U007	U008	U009	U010	U011	U012	U013	U014	U015	U016	U017	U018	U019	U020	U021
------	------	------	------	------	------	------	------	------	------	------	------	------	------	------	------	------	------	------	------	------

U018_S009_S002
SHAFT:DRIVE:BRUSH ROLLER:ASS'Y

13.07200060E
RETAINING RING -
M6

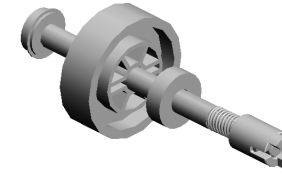

94.D1941425
SHAFT:DRIVE:BRU
SH ROLLER:ASS'Y



21.07433906
RADIAL BALL BEA
RING:DIA6XDIA15X
5

U001	U002	U003	U004	U005	U006	U007	U008	U009	U010	U011	U012	U013	U014	U015	U016	U017	U018	U019	U020	U021
------	------	------	------	------	------	------	------	------	------	------	------	------	------	------	------	------	------	------	------	------

U018_S009_S003

SHAFT:DRIVE:DEVELOPMENT SLEEVE:ASS'Y

20.07433808
RADIAL BALL BEA
RING: DIA8X DIA16X
5

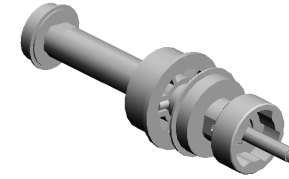

121.D0A51431

[A]
SHAFT:DRIVE:DEV
ELOPMENT SLEEV
E:ASSY
201812-10 O/O

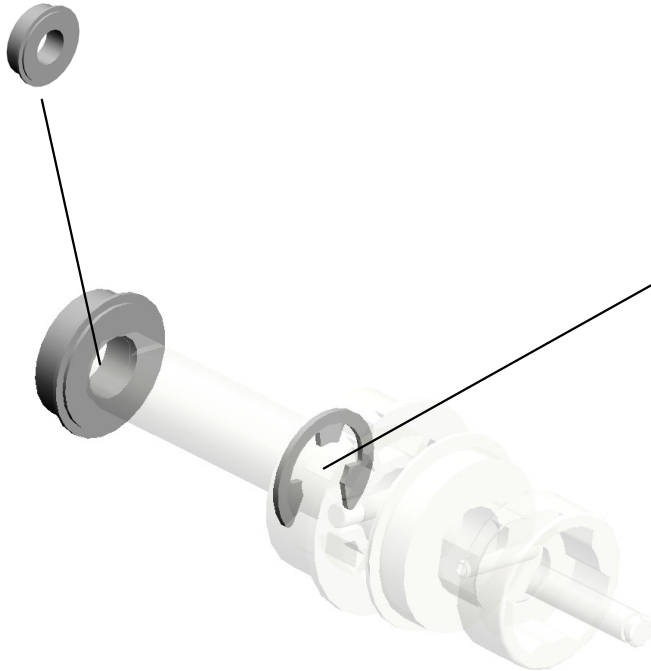

14.07200080E
RETAINING RING -
M8

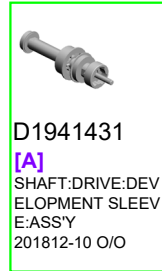

D1941431

[A]
SHAFT:DRIVE:DEV
ELOPMENT SLEEV
E:ASSY
201812-10 O/O

U001	U002	U003	U004	U005	U006	U007	U008	U009	U010	U011	U012	U013	U014	U015	U016	U017	U018	U019	U020	U021
------	------	------	------	------	------	------	------	------	------	------	------	------	------	------	------	------	------	------	------	------

U018_S010
 DRIVE UNIT:AROUND THE PHOTOCONDUCTOR:CMY:ASS'Y

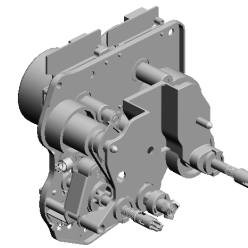

123.D1941450
 DRIVE UNIT:AROU
 ND THE PHOTOCO
 NDUCTOR:CMY:AS
 SY

63.AX060463 DC MOTOR:DIA56:
 14.7W:BRUSHLES
 S
 116.G0603945 TIMING BELT - TRA
 NSFER BELT DRIV
 E
 99.D1941437 TIGHTENER:DEVE
 LOPMENT SLEEVE
 42.AB017857 GEAR:PULLEY:DE
 VELOPMENT DRIV
 E UNIT:65Z/30T

11.07200030E
 RETAINING RING -
 M3

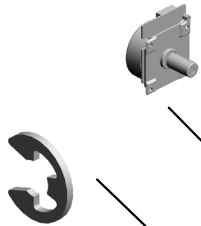

10.07080040N
 WASHER - DIA4



97.D1941433
 JOINT:DEVELOPM
 ENT SLEEVE:DRIV
 E:MIDDLE



43.AB017858
 GEAR:64Z/51Z



60.AX060459
 DC MOTOR:DIA63:
 24V:24.4W:BRUSH
 LESS



68.C2361822
 TIMING BELT - B60
 S2M186



98.D1941436
 TENSION SPRING:
 TIGHTENER:DRIVE
 :AROUND THE PH
 OTOCONDUCTOR



25.11050511
 (x2)
 HARNESS CLAMP -
 LWS-0306ZC



57.AW020198 PHOTOINTERRUP
 TOR:LG2A14NL1
 95.D1941428 TIGHTENER:DRIVE
 :DEVELOPMENT:A
 SS'Y
 3.03603006N (x9)
 SCREW - M3X6
 100.D1941441 TENSION SPRING:
 DEVELOPMENT

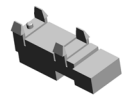

U018_S010_S001
SHAFT:DRIVE:BRUSH ROLLER:ASS'Y

13.07200060E
RETAINING RING -
M6

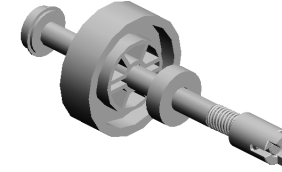

94.D1941425
SHAFT:DRIVE:BRU
SH ROLLER:ASS'Y

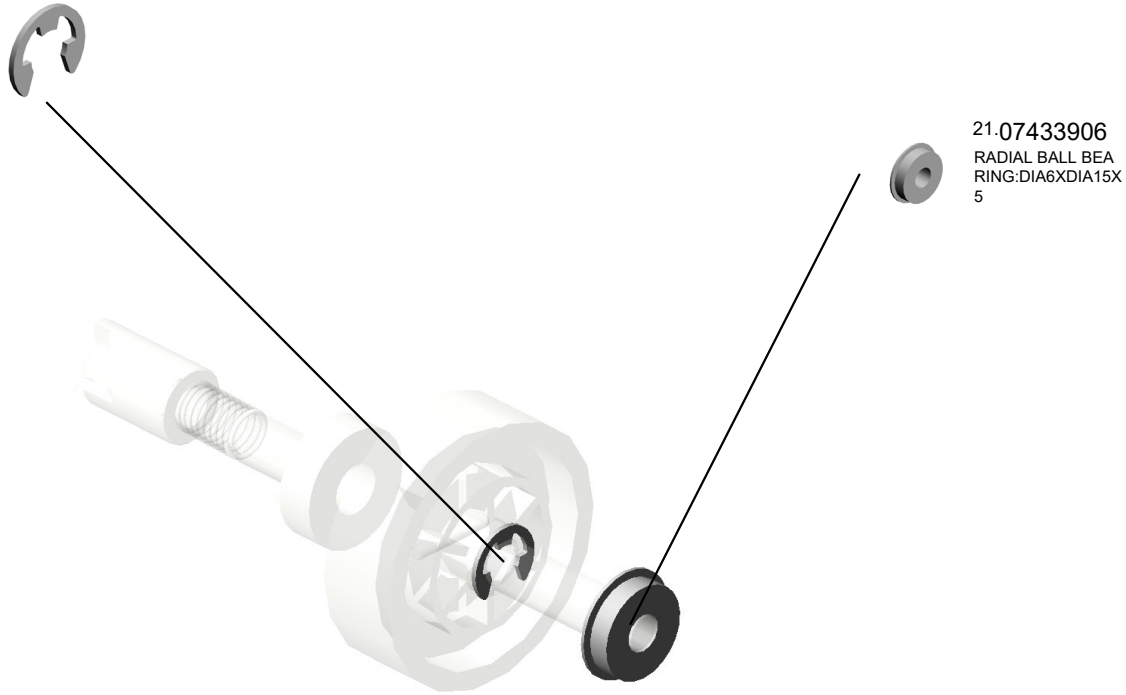

21.07433906
RADIAL BALL BEA
RING:DIA6XDIA15X
5

U001	U002	U003	U004	U005	U006	U007	U008	U009	U010	U011	U012	U013	U014	U015	U016	U017	U018	U019	U020	U021
------	------	------	------	------	------	------	------	------	------	------	------	------	------	------	------	------	------	------	------	------

U018_S010_S002
SHAFT:DRIVE:DEVELOPMENT SLEEVE:ASS'Y

20.07433808
RADIAL BALL BEA
RING: DIA8XDIA16X
5

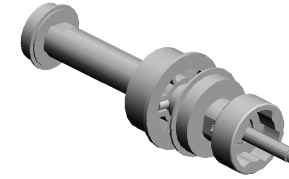

121.D0A51431
[A]
SHAFT:DRIVE:DEV
ELOPMENT SLEEV
E:ASSY
201812-10 O/O

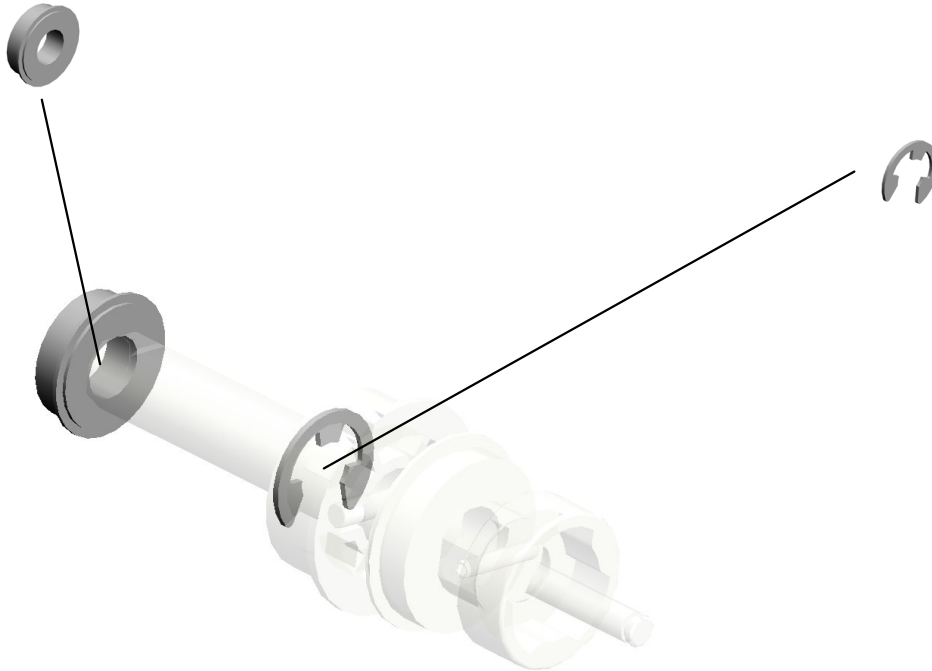

14.07200080E
RETAINING RING -
M8

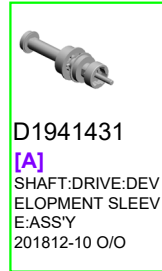

D1941431
[A]
SHAFT:DRIVE:DEV
ELOPMENT SLEEV
E:ASSY
201812-10 O/O

U001	U002	U003	U004	U005	U006	U007	U008	U009	U010	U011	U012	U013	U014	U015	U016	U017	U018	U019	U020	U021
------	------	------	------	------	------	------	------	------	------	------	------	------	------	------	------	------	------	------	------	------

U018_S010_S003

SHAFT:DRIVE:TRANSPORT SCREW:CMY:ASS'Y

17.07403906
BALL BEARING - 6
X15X5

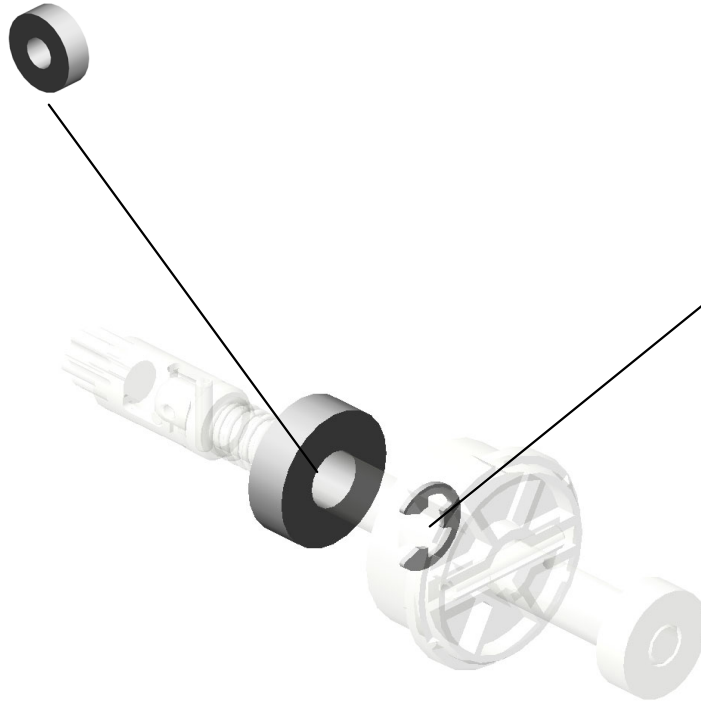

13.07200060E
RETAINING RING -
M6

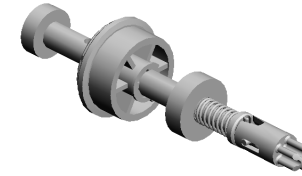

101.D1941451
SHAFT:DRIVE:TRA
NSPORT SCREW:
CMY:ASS'Y

U001	U002	U003	U004	U005	U006	U007	U008	U009	U010	U011	U012	U013	U014	U015	U016	U017	U018	U019	U020	U021
------	------	------	------	------	------	------	------	------	------	------	------	------	------	------	------	------	------	------	------	------

U018_S011
 DRIVE UNIT:AROUND THE PHOTOCONDUCTOR:CMY:ASS'Y

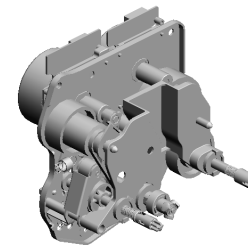

123.D1941450
 DRIVE UNIT:AROU
 ND THE PHOTOCO
 NDUCTOR:CMY:AS
 SY

63.AX060463 DC MOTOR:DIA56:
 14.7W:BRUSHLES
 S
 116.G0603945 TIMING BELT - TRA
 NSFER BELT DRIV
 E
 99.D1941437 TIGHTENER:DEVE
 LOPMENT SLEEVE
 42.AB017857 GEAR:PULLEY:DE
 VELOPMENT DRIV
 E UNIT:65Z/30T

11.07200030E
 RETAINING RING -
 M3



10.07080040N
 WASHER - DIA4



97.D1941433
 JOINT:DEVELOPM
 ENT SLEEVE:DRIV
 E:MIDDLE



43.AB017858
 GEAR:64Z/51Z



60.AX060459
 DC MOTOR:DIA63:
 24V:24.4W:BRUSH
 LESS



68.C2361822
 TIMING BELT - B60
 S2M186



98.D1941436
 TENSION SPRING:
 TIGHTENER:DRIVE
 :AROUND THE PH
 OTOCONDUCTOR



25.11050511
 (x2)
 HARNESS CLAMP -
 LWS-0306ZC



57.AW020198 PHOTOINTERRUP
 TOR:LG2A14NL1
 95.D1941428 TIGHTENER:DRIVE
 :DEVELOPMENT:A
 SS'Y
 3.03603006N (x9)
 SCREW - M3X6
 100.D1941441 TENSION SPRING:
 DEVELOPMENT



U018_S011_S001
SHAFT:DRIVE:BRUSH ROLLER:ASS'Y

13.07200060E
RETAINING RING -
M6

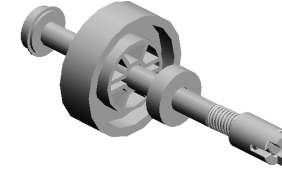

94.D1941425
SHAFT:DRIVE:BRU
SH ROLLER:ASS'Y



21.07433906
RADIAL BALL BEA
RING:DIA6XDIA15X
5

U001	U002	U003	U004	U005	U006	U007	U008	U009	U010	U011	U012	U013	U014	U015	U016	U017	U018	U019	U020	U021
------	------	------	------	------	------	------	------	------	------	------	------	------	------	------	------	------	------	------	------	------

U018_S011_S002
SHAFT:DRIVE:DEVELOPMENT SLEEVE:ASS'Y

20.07433808
RADIAL BALL BEA
RING: DIA8X DIA16X
5

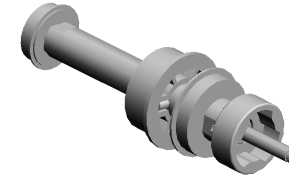

121.D0A51431
[A]
SHAFT:DRIVE:DEV
ELOPMENT SLEEV
E:ASSY
201812-10 O/O

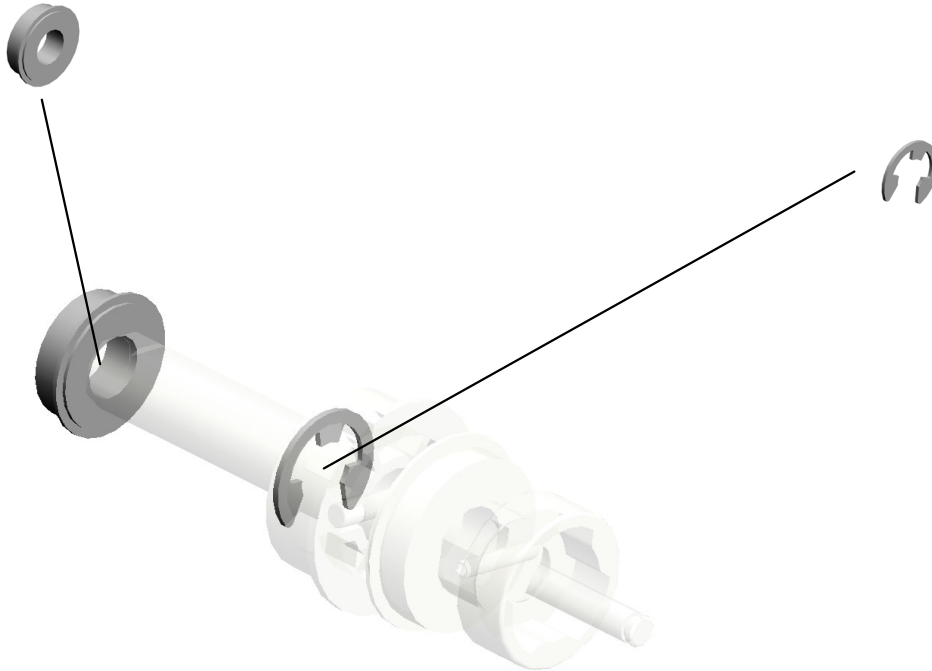

14.07200080E
RETAINING RING -
M8

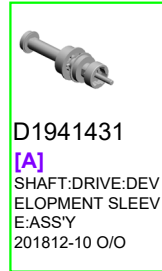

D1941431
[A]
SHAFT:DRIVE:DEV
ELOPMENT SLEEV
E:ASSY
201812-10 O/O

U001	U002	U003	U004	U005	U006	U007	U008	U009	U010	U011	U012	U013	U014	U015	U016	U017	U018	U019	U020	U021
------	------	------	------	------	------	------	------	------	------	------	------	------	------	------	------	------	------	------	------	------

U018_S011_S003
SHAFT:DRIVE:TRANSPORT SCREW:CMY:ASS'Y

17.07403906
BALL BEARING - 6
X15X5

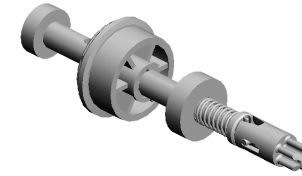

101.D1941451
SHAFT:DRIVE:TRA
NSPORT SCREW:
CMY:ASS'Y

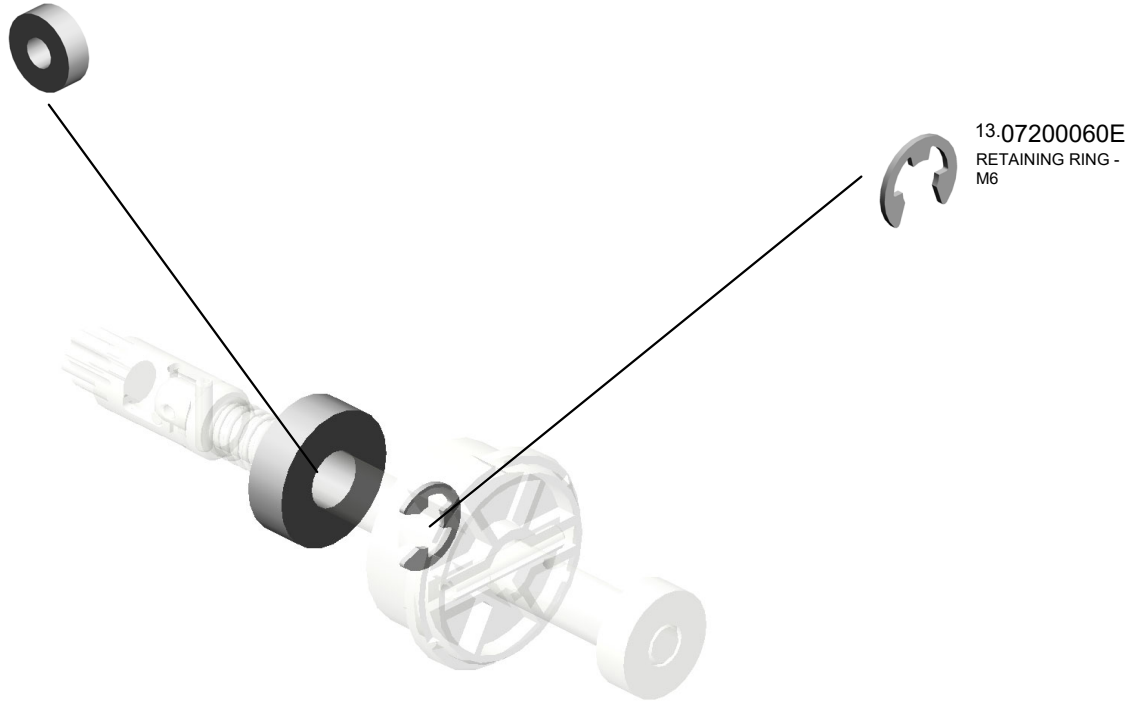

U001	U002	U003	U004	U005	U006	U007	U008	U009	U010	U011	U012	U013	U014	U015	U016	U017	U018	U019	U020	U021
------	------	------	------	------	------	------	------	------	------	------	------	------	------	------	------	------	------	------	------	------

DRIVE UNIT:AROUND THE PHOTOCONDUCTOR:CMY:ASS'Y

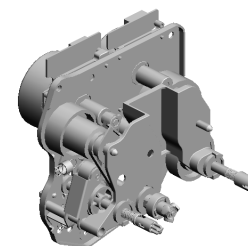

123.D1941450
DRIVE UNIT:AROU
ND THE PHOTOCO
NDUCTOR:CMY:AS
S'Y

- 63.AX060463 DC MOTOR:DIA56:
14.7W:BRUSHLES
S
- 116.G0603945 TIMING BELT - TRA
NSFER BELT DRIV
E
- 99.D1941437 TIGHTENER:DEVE
LOPMENT SLEEVE
- 42.AB017857 GEAR:PULLEY:DE
VELOPMENT DRIV
E UNIT:65Z/30T

11.07200030E
RETAINING RING -
M3



10.07080040N
WASHER - DIA4



97.D1941433
JOINT:DEVELOPM
ENT SLEEVE:DRIV
E:MIDDLE



43.AB017858
GEAR:64Z/51Z



60.AX060459
DC MOTOR:DIA63:
24V:24.4W:BRUSH
LESS

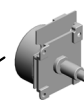

68.C2361822
TIMING BELT - B60
S2M186



98.D1941436
TENSION SPRING:
TIGHTENER:DRIVE
:AROUND THE PH
OTOCONDUCTOR



95.D1941428
TIGHTENER:DRIVE
:DEVELOPMENT:A
SS'Y



57.AW020198
PHOTOINTERRUP
TOR:LG2A14NL1

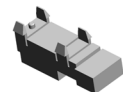

3.03603006N
(x9)
SCREW - M3X6



25.11050511
(x2)
HARNES CLAMP -
LWS-0306ZC



100.D1941441
TENSION SPRING:
DEVELOPMENT



U018_S012_S001
SHAFT:DRIVE:BRUSH ROLLER:ASS'Y

13.07200060E
RETAINING RING -
M6

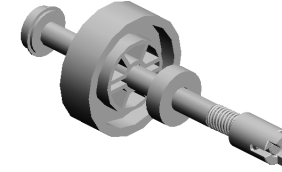

94.D1941425
SHAFT:DRIVE:BRU
SH ROLLER:ASS'Y



21.07433906
RADIAL BALL BEA
RING:DIA6XDIA15X
5

U001	U002	U003	U004	U005	U006	U007	U008	U009	U010	U011	U012	U013	U014	U015	U016	U017	U018	U019	U020	U021
------	------	------	------	------	------	------	------	------	------	------	------	------	------	------	------	------	------	------	------	------

U018_S012_S002
SHAFT:DRIVE:DEVELOPMENT SLEEVE:ASS'Y

20.07433808
RADIAL BALL BEA
RING: DIA8X DIA16X
5

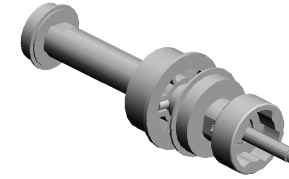

121.D0A51431
[A]
SHAFT:DRIVE:DEV
ELOPMENT SLEEV
E:ASSY
201812-10 O/O

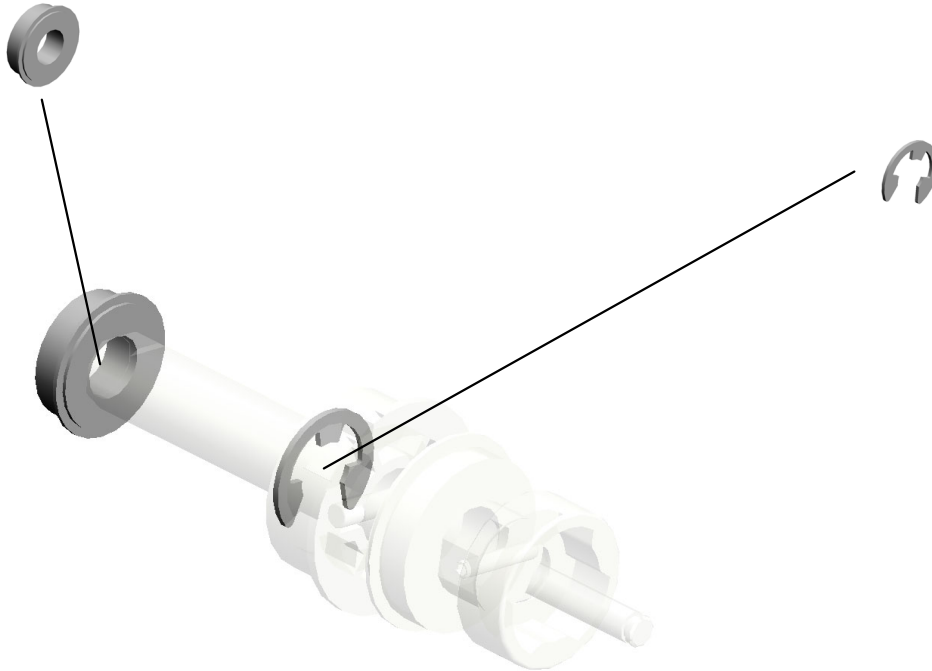

14.07200080E
RETAINING RING -
M8

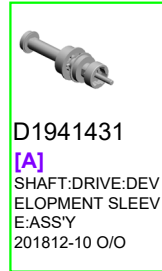

D1941431
[A]
SHAFT:DRIVE:DEV
ELOPMENT SLEEV
E:ASSY
201812-10 O/O

U001	U002	U003	U004	U005	U006	U007	U008	U009	U010	U011	U012	U013	U014	U015	U016	U017	U018	U019	U020	U021
------	------	------	------	------	------	------	------	------	------	------	------	------	------	------	------	------	------	------	------	------

U018_S012_S003

SHAFT:DRIVE:TRANSPORT SCREW:CMY:ASS'Y

13.07200060E
RETAINING RING -
M6

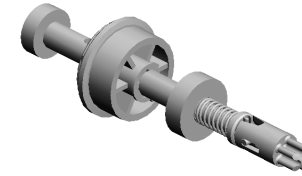

101.D1941451
SHAFT:DRIVE:TRA
NSPORT SCREW:
CMY:ASS'Y

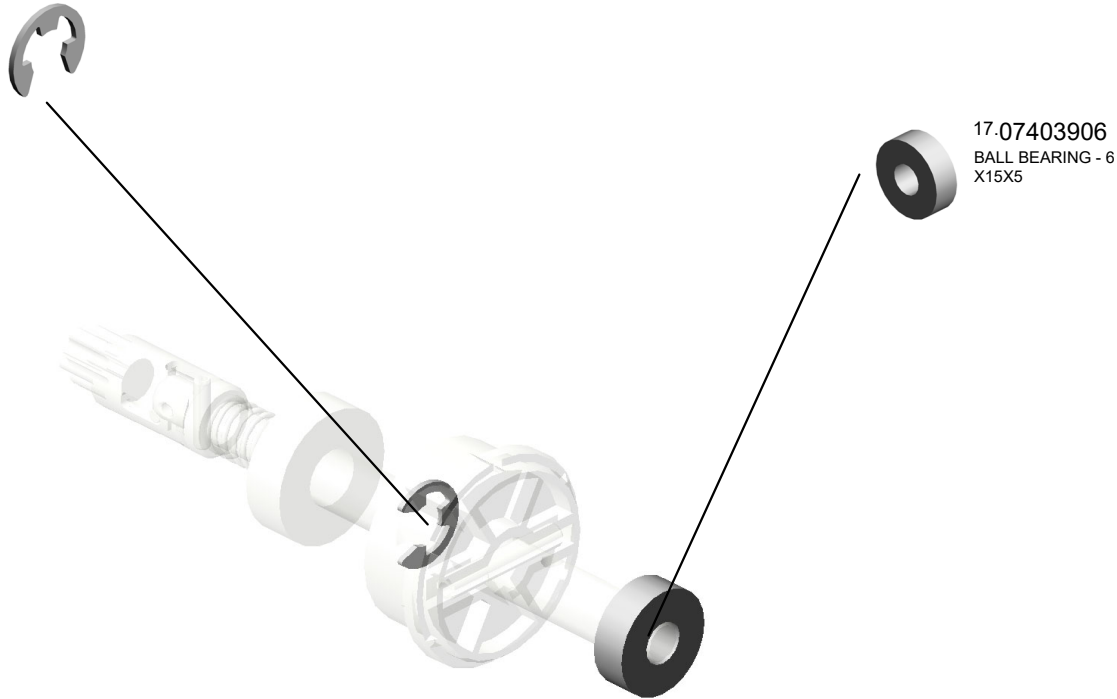

17.07403906
BALL BEARING - 6
X15X5

U001	U002	U003	U004	U005	U006	U007	U008	U009	U010	U011	U012	U013	U014	U015	U016	U017	U018	U019	U020	U021
------	------	------	------	------	------	------	------	------	------	------	------	------	------	------	------	------	------	------	------	------

U018_S013
(D203/D204):SHAFT:OUTPUT:ON-OFF:5ST:ASS'Y

18.07413006 13.07200060E
BALL BEARING - 6 RETAINING RING -
X17X6MM M6

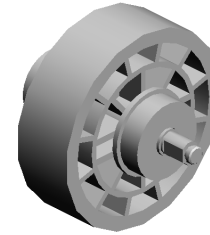

113.D1941630
(D203/D204):SHAF
T:OUTPUT:ON-OFF
:5ST:ASS'Y

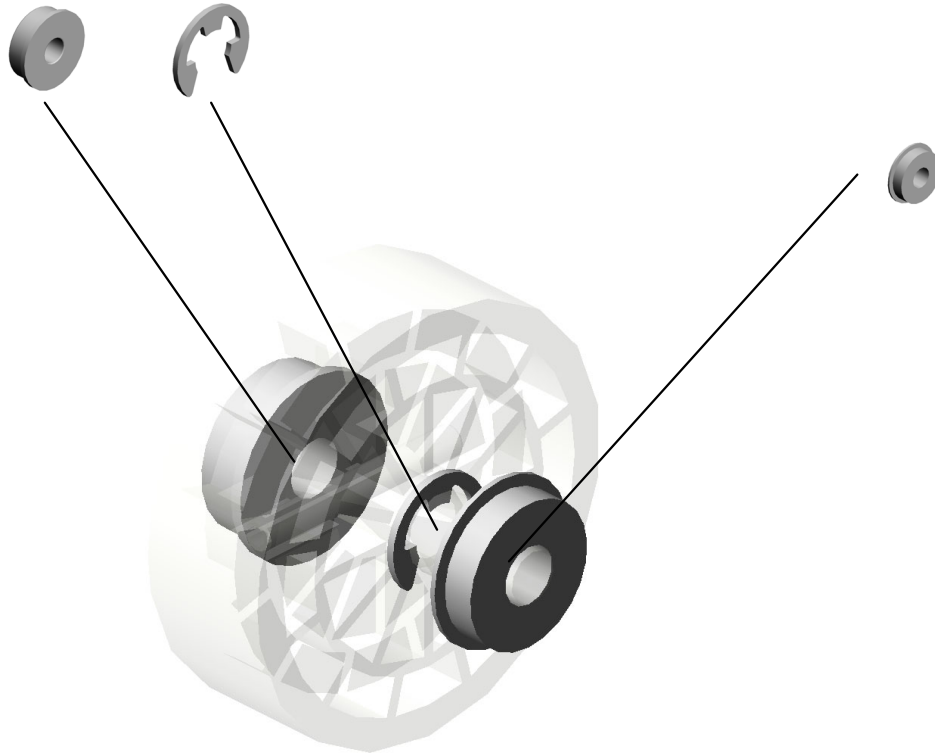

21.07433906
RADIAL BALL BEA
RING:DIA6XDIA15X
5

U001	U002	U003	U004	U005	U006	U007	U008	U009	U010	U011	U012	U013	U014	U015	U016	U017	U018	U019	U020	U021
------	------	------	------	------	------	------	------	------	------	------	------	------	------	------	------	------	------	------	------	------

U019.ELECTRICAL

U019 S001
D1945410
PCB:BCU:ASSY

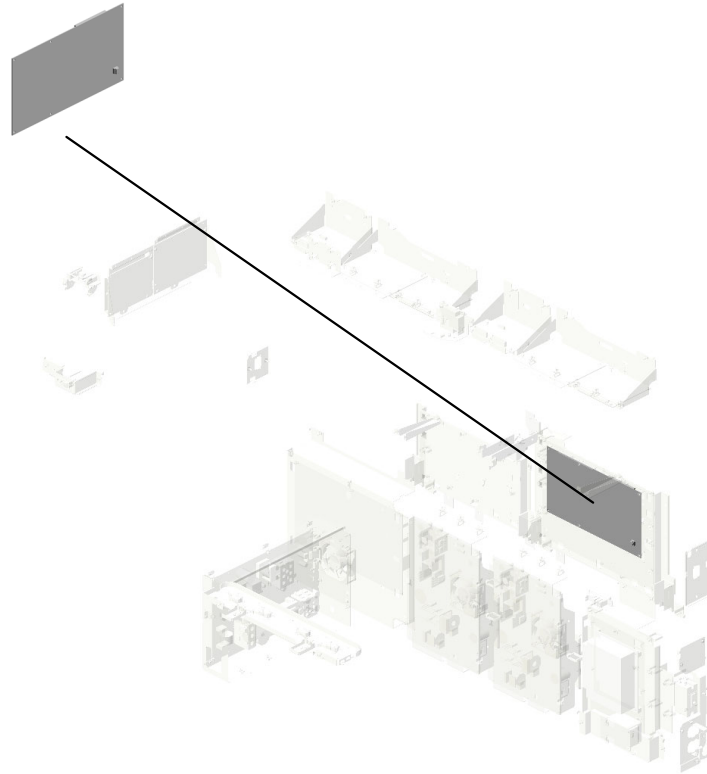

U001	U002	U003	U004	U005	U006	U007	U008	U009	U010	U011	U012	U013	U014	U015	U016	U017	U018	U019	U020	U021
------	------	------	------	------	------	------	------	------	------	------	------	------	------	------	------	------	------	------	------	------

U019 ELECTRICAL

- 6.04513006N (x2) TAPPING SCREW - 3X6
- 9.04544008Q (x4) TAPPING SCREW - M4X8
- 21.11050516 (x17) CLAMP
- 17.11050489 (x5) HARNESS CLAMP - LWS 1316
- 24.11050723 (x2) CLAMPS:WES-0507

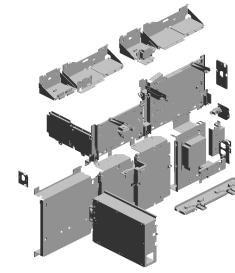

28.12042614
SWITCH AC250V/1
6A

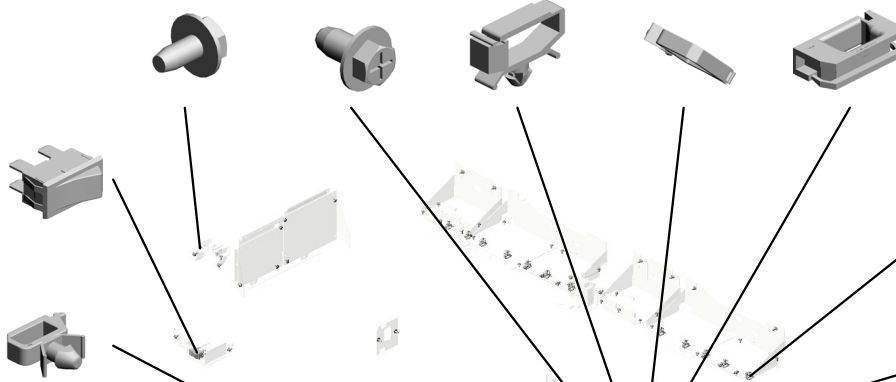

15.11050487
(x3)
HARNESS CLAMP

2.03603014N
(x4)
SCREW - M3X14

27.12042612
(x4)
MICRO SWITCH:D3
V-16506-3C25

8.04543006Q
(x8)
TAPPING SCREW -
M3X6

3.03603030N
(x6)
SCREW:M3X30

19.11050508
(x6)
HARNESS CLAMP -
LWS-0711

18.11050490
(x14)
HARNESS CLAMP -
IWS-2218

7.04514008N
(x47)
TAPPING SCREW:
4X8

26.11071281
FUSE:BJ52012F2

20.11050511
(x11)
HARNESS CLAMP -
LWS-0306ZC

13.11050409
(x19)
CARD SPACER- 6-
4MM

22.11050529
NYLON CLAMP-EM
T-3N

4.03604008N
(x3)
SCREW - M4X8

1.03603006N
(x75)
SCREW - M3X6

10.08046123
(x4)
HEXAGONAL BOLT
:W/WASHER:M3X8

14.11050410
CARD SPACER - 9-
4MM

16.11050488
(x10)
HARNESS CLAMP

18.11050490
HARNESS CLAMP -
IWS-2218

12.11050042
(x64)
WIRE BAND

15.11050487
(x2)
HARNESS CLAMP

17.11050489
(x3)
HARNESS CLAMP -
LWS 1316

19.11050508
(x4)
HARNESS CLAMP -
LWS-0711

U019 ELECTRICAL

- 41.D1495883 KEYTOP:MAIN SWI
TCH
- 42.D1495884 COMPRESSION SP
RING:KEYTOP
- 43.D1945451 AC CONTROL BOA
RD
201608-03 O/O
- 47.D1945128 INTERFACE CABL
E:LVDB_U:IPU:ASS
Y
- 46.D1945114 PCB:LVDB_U

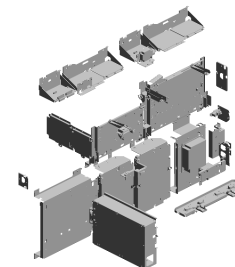

- 40.D1775686
PCB:DCSW
201608-01 O/O

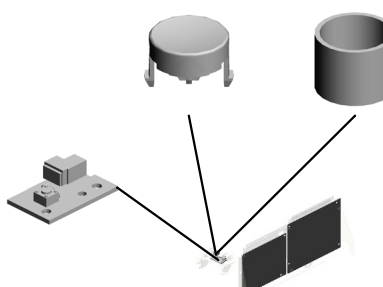

- 39.D0745920
BRACKET:MAIN S
WITCH

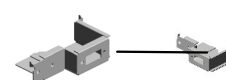

- 37.D0745916
(x2)
SPRING PLATE:SA
FETY SWITCH



- 38.D0745917
(x2)
ARM:SAFETY SWI
TCH

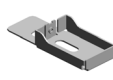

- 35.C2182185
(x2)
STEPPER SCREW



- 32.AZ240224
(x3)
DC POWER SUPPL
Y:450.3W



- 31.AX640199
(x3)
FAN:MM80:25MM:D
C 2.16W



- 49.D1945440
PCB:NRYF



- 51.D1945516
PCB:PFB

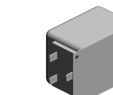

- 30.16071799
FILTER - SUP-ET20
-ER-0



- 33.AZ310037
(x3)
POWER PACK:CH
ARGE



- 34.AZ310038
(x3)
POWER PACK:DEV
ELOPMENT



- 52.D1945520
PCB:TDCU:ASS'Y

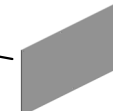

- 50.D1945506
PCB:IOB

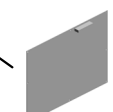

- 44.D1795923
(x2)
PLATE:POWER SU
PPLY CORD:INLET



- 20.11050511
(x14)
HARNESS CLAMP -
LWS-0306ZC



- 21.11050516
(x6)
CLAMP



- 22.11050529
NYLON CLAMP-EM
T-3N



- 23.11050559
CLAMP:EMT-5N



- 25.11050724
CLAMPS:WES-121
0

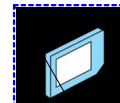

- 59.D0745100
(C71009):SD-CARD
:NICE:REGI:ASS'Y
201701-09 X/O

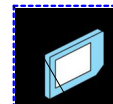

- 60.D2605100
SD-CARD:NICE:AP
PLICATION:ASS'Y
201810-02 X/O



- 68.D0CQ5100
SD-CARD:NICE:AP
PLICATION:ASS'Y
202110-02 O/O

U019 ELECTRICAL

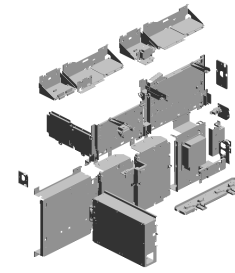

- 57.D2035492 (D203/D204):PCB:EXDB
- 69.D0A52279 BASE:ELECTRIC POTENTIAL SENSOR 202209-01 O/O
- 70.M0EB5907 (x2) BRACKET:BASE:ELECTRIC POTENTIAL SENSOR:P4 202302-01 O/O

56.D1945932
COVER:DCSW

55.D1945927
BRACKET:CONNECTOR:FIN

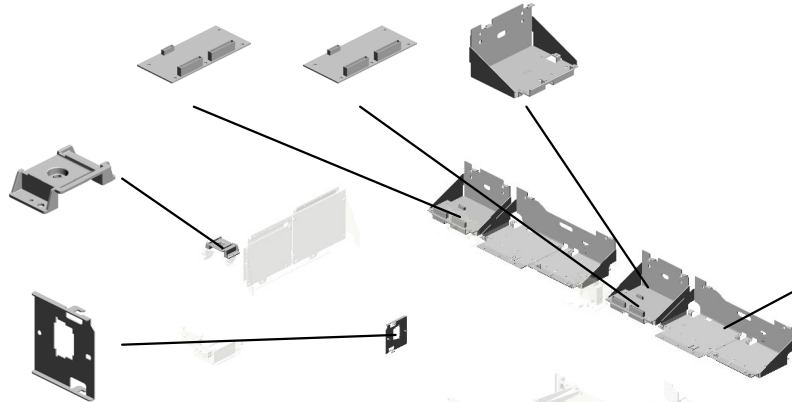

66.D1945906
(x2)
BRACKET:POWER PACK

54.D1945926
BRACKET:CONNECTOR:LARGE CAPACITY TRAY

64.D0A55928
COVER:LEAK BREAKER

- 1.03603006N(x25) SCREW - M3X6
- 4.03604008N(x 1) SCREW - M4X8
- 5.04340200N(x 2) PAN SELF-TAPPING SCREW:4X20
- 7.04514008N(x12) TAPPING SCREW:4X8
- 8.04543006Q(x 1) TAPPING SCREW - M3X6
- 9.04544008Q(x 1) TAPPING SCREW - M4X8
- 11.09505010N(x 2) SCREW:SPRING WASHER:M5X10

53.D1945914
BRACKET:SAFETY SWITCH

63.D0A55911
BRACKET:NOISE FILTER 201806-05 O/O

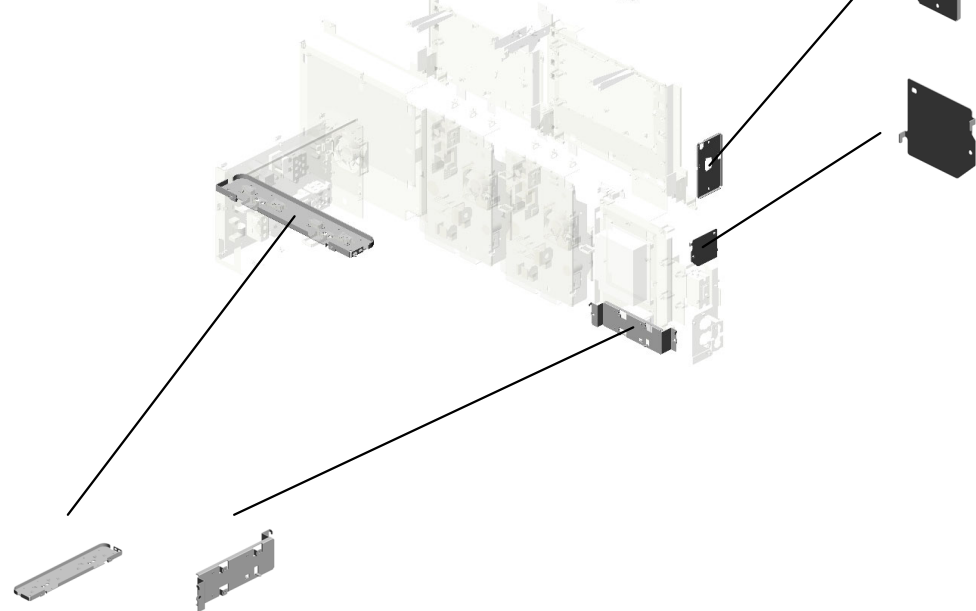

U019_S001
PCB:BCU:ASS'Y

29.14077899
EEPROM:BR24T25
6-W

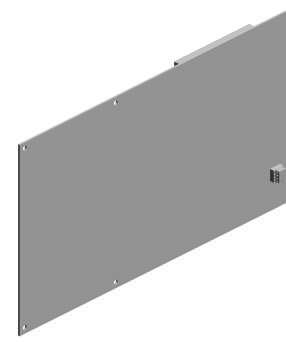
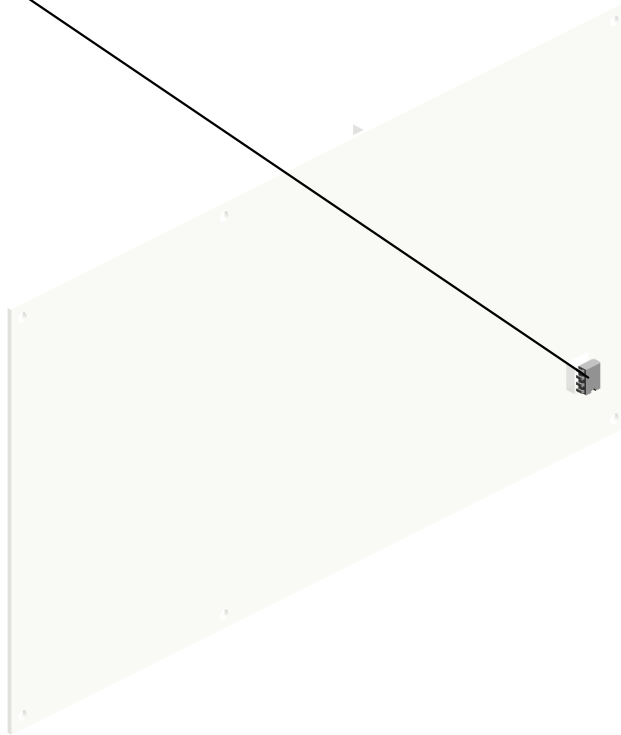

61.D1945410
PCB:BCU:ASS'Y
201710-01 X/O

U001	U002	U003	U004	U005	U006	U007	U008	U009	U010	U011	U012	U013	U014	U015	U016	U017	U018	U019	U020	U021
------	------	------	------	------	------	------	------	------	------	------	------	------	------	------	------	------	------	------	------	------

U020.CONTROLLER

U020 S003
D1941265
COVER:C/T BOX:LEFT:ASS'Y

U020 S004
D1947250
LIQUID COOLING:FAN:ASS'Y

U020 S001
D0741251
DUCT:EXHAUST:EXIT:ASS'Y

U020 S007
D1945832
HDD UNIT:ASS'Y

U020 S005
D1948515
LIQUID COOLING:PT:TAURU
S-C2:ASS'Y

U020 S008
D7306036
PCB:GIGAETHERNET:ASS'Y

U020 S006
AZ240373
POWER SUPPLY UNIT:ECO:
200V

U020 S002
D1941257
COVER:C/T BOX:RIGHT:ASS'
Y

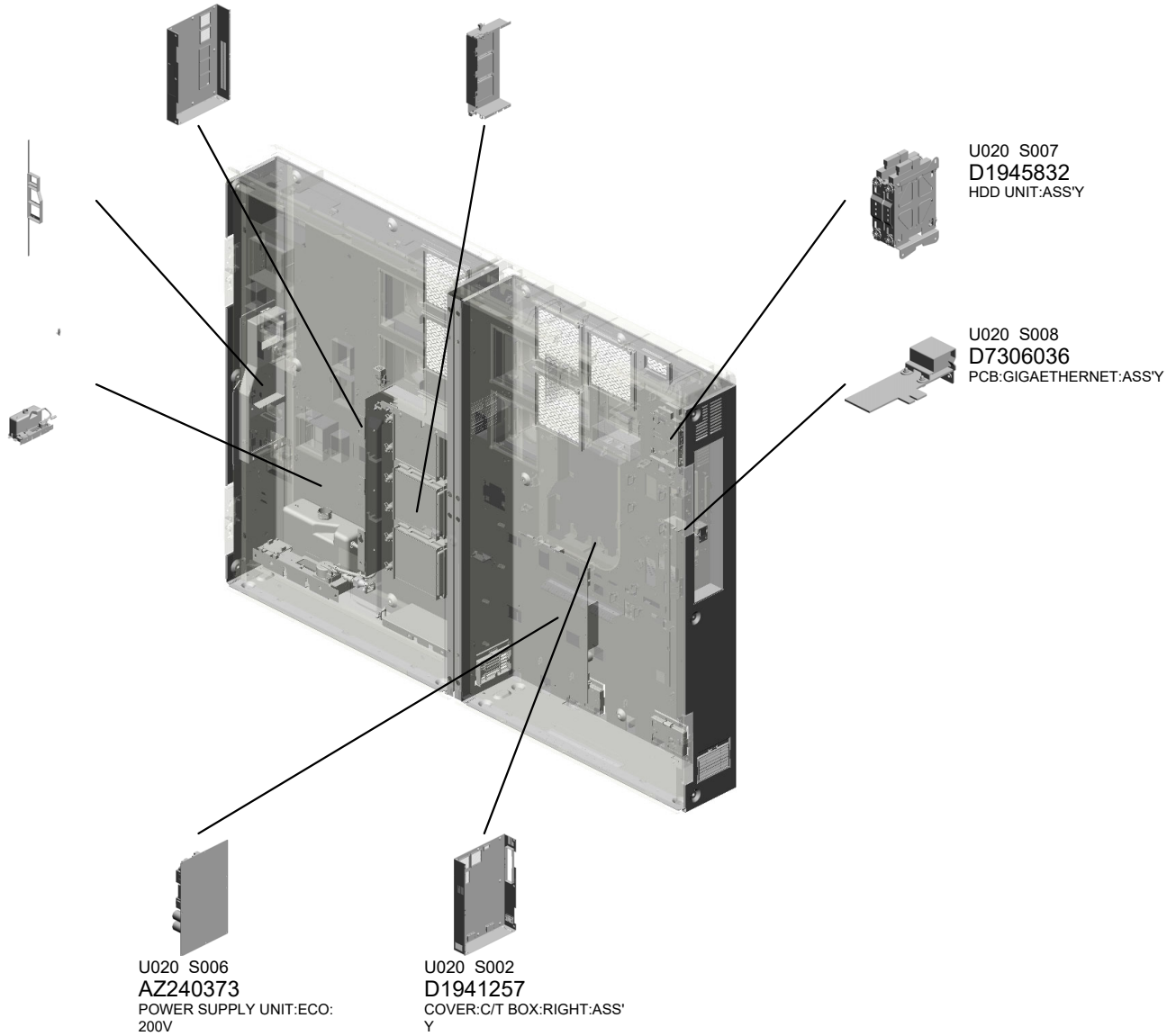

U001	U002	U003	U004	U005	U006	U007	U008	U009	U010	U011	U012	U013	U014	U015	U016	U017	U018	U019	U020	U021
------	------	------	------	------	------	------	------	------	------	------	------	------	------	------	------	------	------	------	------	------

U020 CONTROLLER

- 3.03540450N (x10) SCREW:M4X45
- 18.11050508 (x17) HARNESS CLAMP - LWS-0711
- 19.11050511 (x15) HARNESS CLAMP - LWS-0306ZC
- 21.11050517 (x6) HARNESS CLAMP - LWS-2111Z
- 7.03604008N (x7) SCREW - M4X8 201812-04 O/O

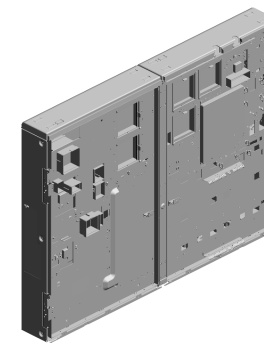

- 7.03604008N (x6) SCREW - M4X8 201812-02 O/O

- 2.03540400N (x4) SCREW:M4X40

- 10.04513006N (x5) TAPPING SCREW - 3X6

- 9.04503008N (x61) TAPPING SCREW - M3X8

- 7.03604008N (x9) SCREW - M4X8

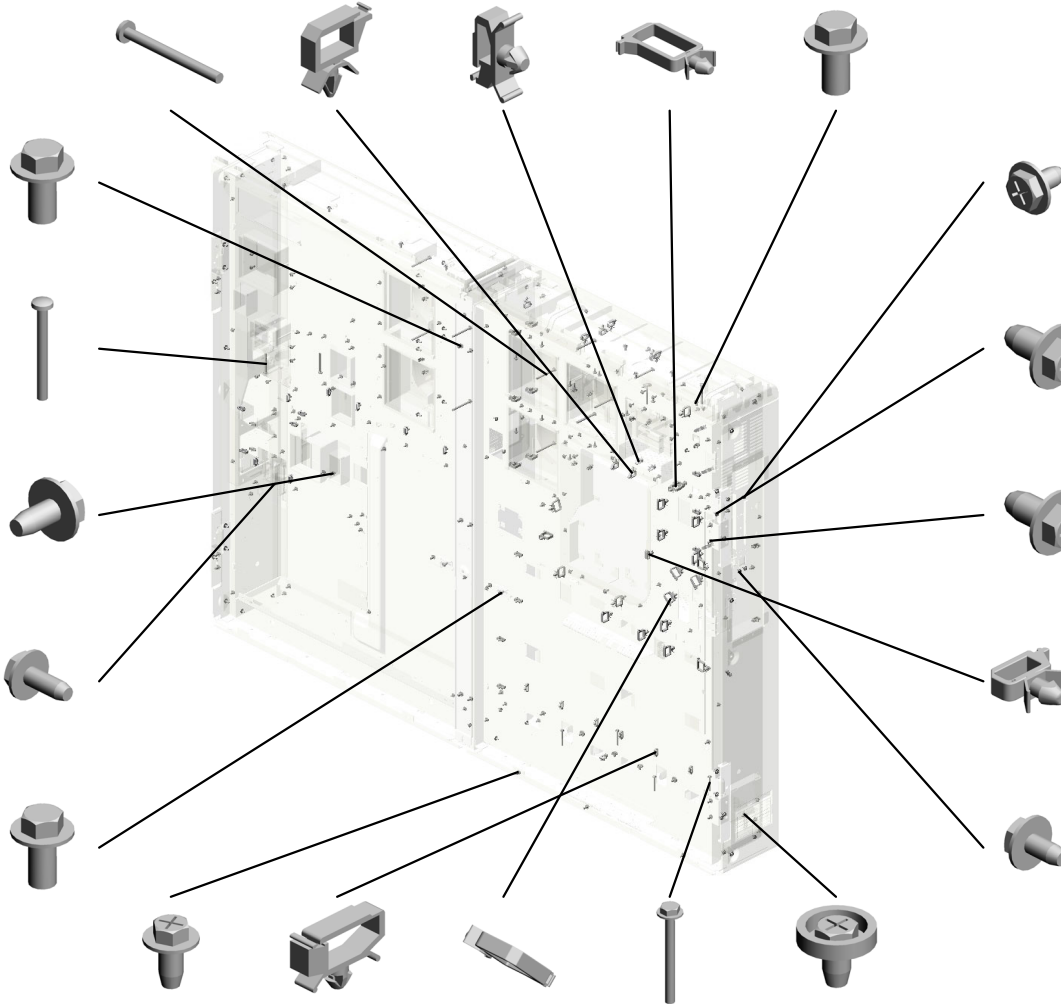

- 12.04514008N (x26) TAPPING SCREW: 4X8
- 20.11050516 (x27) CLAMP
- 17.11050489 (x14) HARNESS CLAMP - LWS 1316
- 8.03604030N (x4) SCREW:M4X30
- 11.04514006N (x2) TAPPING SCREW - 4X6

- 13.04543006Q (x91) TAPPING SCREW - M3X6



- 23.11050559 (x5) CLAMP:EMT-5N

- 26.AA143645 (x2) STEPPED SCREW: M3:45MM

- 14.04544008Q (x8) TAPPING SCREW - M4X8

- 14.04544008Q (x14) TAPPING SCREW - M4X8 201812-03 O/O



- 33.AX660621 DC FAN MOTOR:D C24V:MM120:38MM :PWM CONTROL

- 94.D1941224 (x2) HEXAGON HEAD S CREW:M4X10:WAS HER:DIA9:ASS'Y 201507-05 O/O

- 16.11050487 HARNESS CLAMP



- 4.03603006N (x21) SCREW - M3X6

- 94.D1941462 HEXAGON HEAD B OLT:DOUBLE SCR EW:M4X10

- 4.03603006N (x41) SCREW - M3X6
- 5.03603030N (x 2) SCREW:M3X30

U020 CONTROLLER

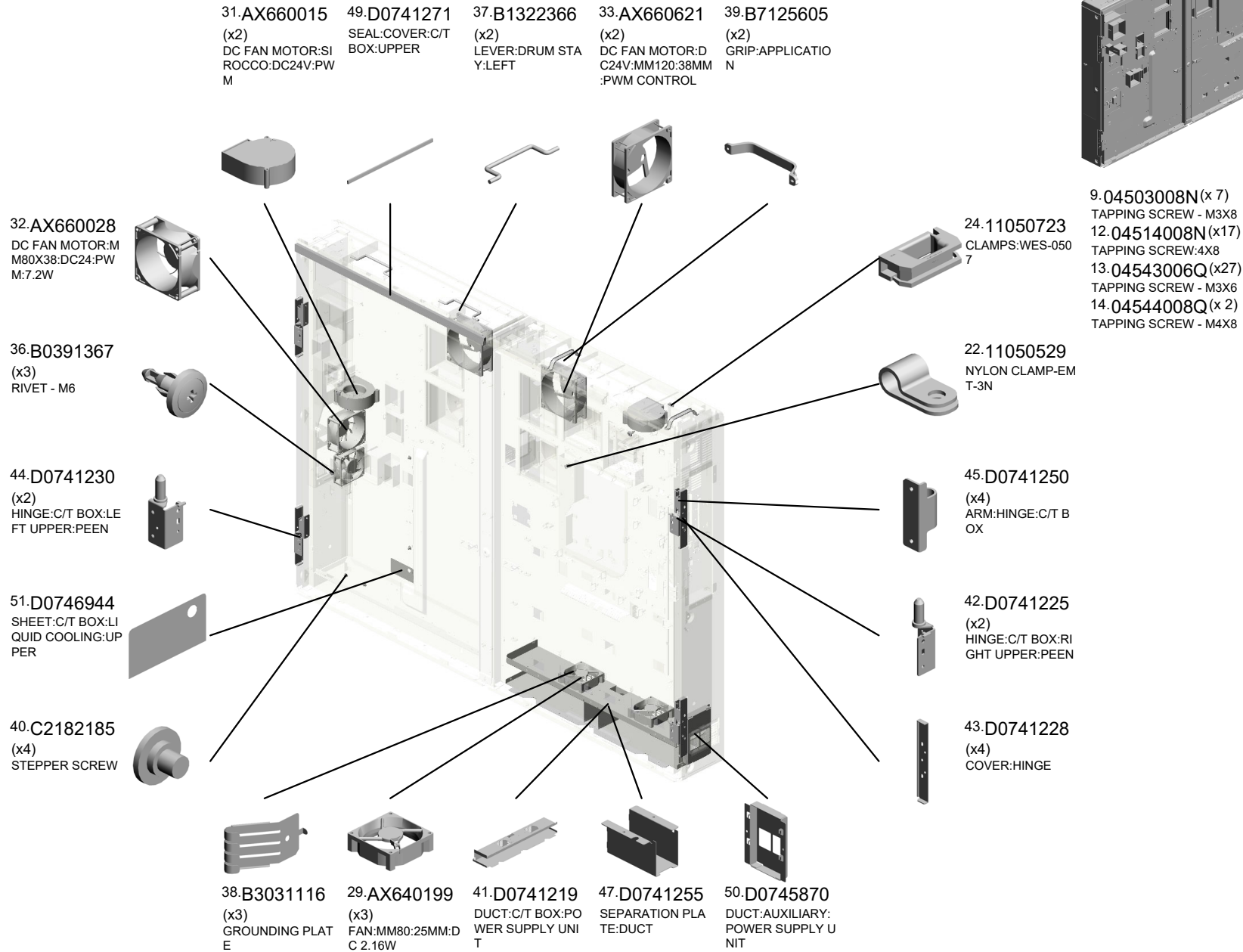
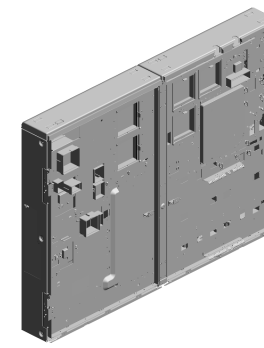

U020 CONTROLLER

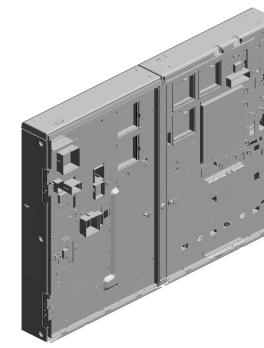

- 59.D0747114 (x7) BRACKET:FAN:DU CT:EXHAUST:C/T BOX
- 67.D0747128 SEAL:LOWER:DUCT:OZONE FILTER:C/T BOX
- 62.D0747122 DUCT:FRONT:OZONE UNIT:C/T BOX
- 64.D0747124 BRACKET:FAN:DUCT:OZONE FILTER:C/T BOX
- 63.D0747123 DUCT:REAR:OZONE UNIT:C/T BOX

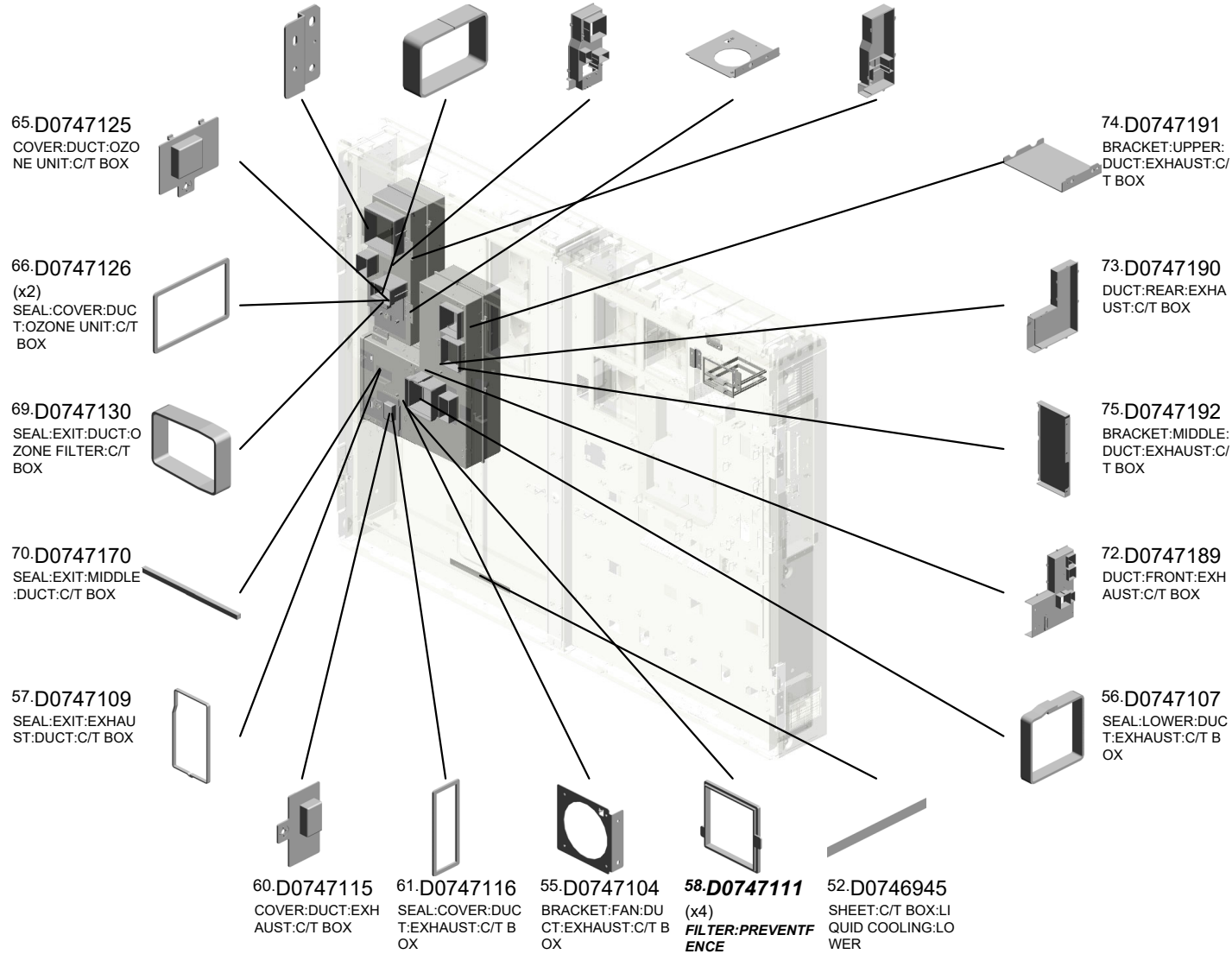

U020 CONTROLLER

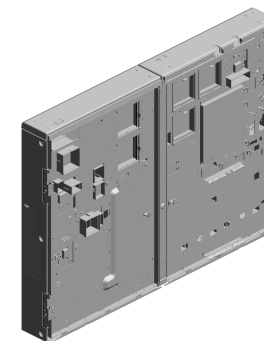

- 98.D1947110 (x2) OZONE FILTER:C/T BOX
- 78.D0747195 (x2) SEAL:DUCT:C/T BOX:MIDDLE UPPER
- 83.D0747752 (x8) CAP:COVER:TONE R SUPPLY
- 97.D1947055 (x5) FILTER:DUCT:MM120 201602-01 O/O
- 101.D1947138 (x5) DUCT:C/T BOX:FA N:MM120:UPPER

- 79.D0747197 (x3) SEAL:DUCT:C/T BOX:MIDDLE SIDEWAYS

- 80.D0747198 SEAL:DUCT:C/T BOX:MIDDLE LOWER

- 76.D0747193 BRACKET:LOWER:DUCT:EXHAUST:C/T BOX

- 77.D0747194 (x5) BRACKET:DUCT:EXHAUST:C/T BOX

- 81.D0747207 SHEET:C/T BOX:Liquid COOLING:WINDOW

- 100.D1947136 DUCT:VACUUM:HEAT SINKER:C/T BOX
- 103.D1947141 (x10) SEAL:DUCT:C/T BOX:MM120
- 87.D1365725 PCB:IMAGE PROCESSING UNIT:TYPE-S15MDA-SUB
- 86.D1365709 PCB:EX3_DDR3-DIMM:RC-A:2GB:ASSY
- 88.D1495776 COVER:USB:SMALL

- 92.D1941269 COVER:C/T BOX:RIGHT:UPPER:ASSY

- 99.D1947135 (x5) OZONE FILTER:C/T BOX:MM120 201612-06 X/X

- 102.D1947140 (x5) DUCT:C/T BOX:FA N:MM120:LOWER

- 95.D1945112 PCB:LVDB_D

- 84.D0935309 COVER:SD-CARD

U020 CONTROLLER

- 113.D1951270 COVER:C/T BOX:UPPER
- 120.D0741288 SIDE PLATE:C/T BOX:UPPER
- 119.AX660905 (x3) DC FAN MOTOR:D C24V:MM120:PWM CONTROL:18W 201510-05
- 106.D1947149 COVER:DUCT:ABS ORB DUST SUB-UNIT:C/T BOX
- 104.D1947146 DUCT:EXHAUST:ABS ORB DUST SUB-UNIT:C/T BOX:FRO NT

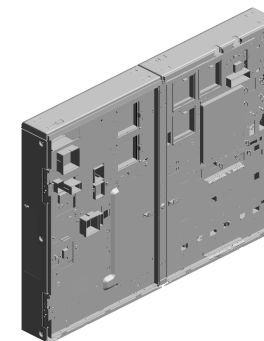

109.D1947176 SHEET:DUCT:OZONE UNIT:C/T BOX:UPPER

108.D1947175 SHEET:DUCT:OZONE UNIT:C/T BOX

123.D0741254 SIDE PLATE:C/T BOX:LEFT

107.D1947174 SHEET:DUCT:EXHAUST:C/T BOX:LARGE

116.D1957196 BRACKET:UPPER:FAN:DUCT:C/T BOX

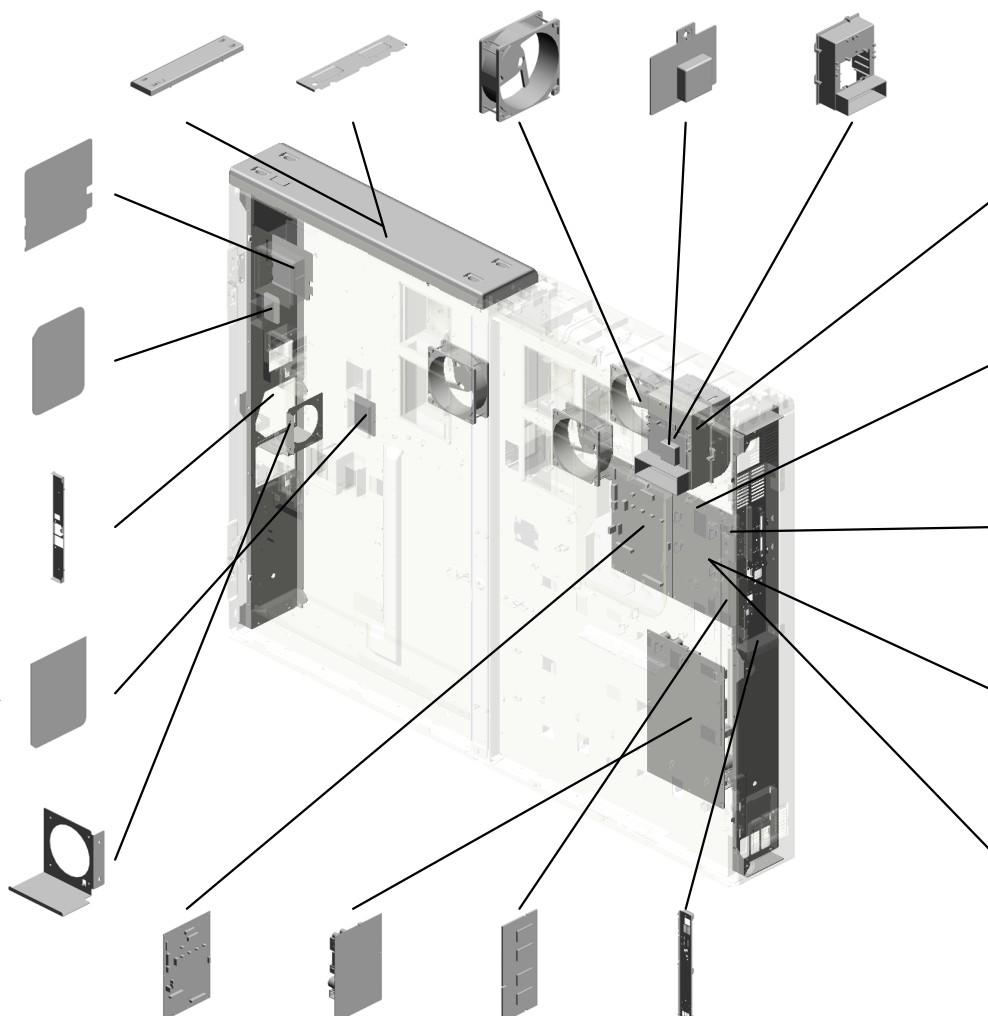

105.D1947147 DUCT:EXHAUST:ABS ORB DUST SUB-UNIT:C/T BOX:REAR

112.D1949590 NV-RAM

125.D0745101 SD-CARD:NICE:REGI2:ASSY 201701-02 X/O

129.D1955742 (D194/D203):PCB:CONTROL:SERVICE PART S:D194/D203:ASSY 202306-03 O/O

130.D1955743 (D195/D204):PCB:CONTROL:SERVICE PART S:D195/D204:ASSY 202306-02 O/O

127.D1945706 PCB:IMAGE PROCESSING UNIT 201909-02 X/O

126.AZ240299 DC POWER SUPPLY 201603-03 X/O

118.M1305245 PCB:DDR3-DIMM:RC-C:1GB:ASSY

124.D1945838 SIDE PLATE:C/T BOX:RIGHT:RIGHT:PEEN

U020_S001
DUCT:EXHAUST:EXIT:ASS'Y

71.D0747174
SEAL:DUCT:EXIT



46.D0741251
DUCT:EXHAUST:EXIT:ASS'Y

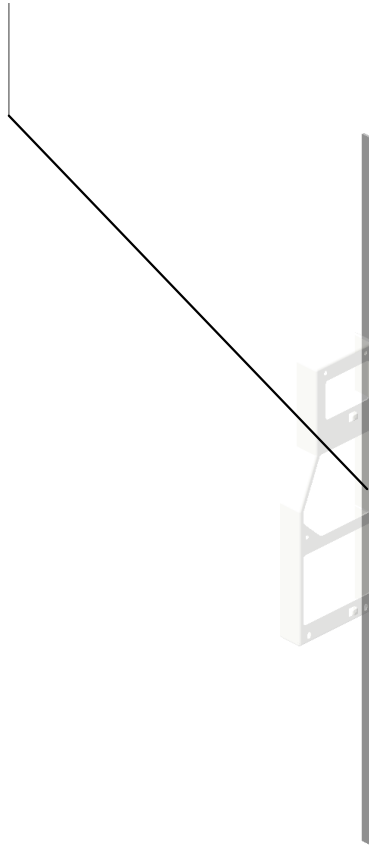

U001	U002	U003	U004	U005	U006	U007	U008	U009	U010	U011	U012	U013	U014	U015	U016	U017	U018	U019	U020	U021
------	------	------	------	------	------	------	------	------	------	------	------	------	------	------	------	------	------	------	------	------

U020_S002
COVER:C/T BOX:RIGHT:ASS'Y

93.D1941282 (x6)
SEAL:COVER:C/T
BOX:MM120

89.D1941223
SEAL:COVER:C/T
BOX:SIROCCO

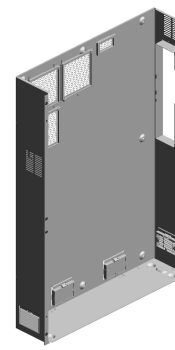

90.D1941257
COVER:C/T BOX:RI
GHT:ASS'Y

53.D0746974
(x4)
CAP:LOUVER:MM9
0

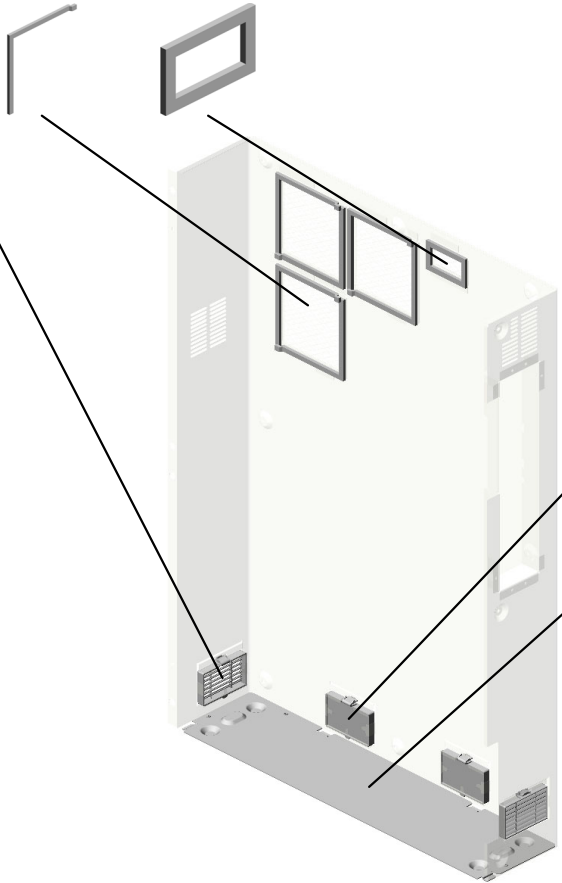

54.D0746975
(x4)
FILTER:POWER S
UPPLY UNIT:MM90



94.D1941462
(x4)
HEXAGON HEAD B
OLT:DOUBLE SCR
EW:M4X10

48.D0741258
COVER:C/T BOX:RI
GHT LOWER



U001	U002	U003	U004	U005	U006	U007	U008	U009	U010	U011	U012	U013	U014	U015	U016	U017	U018	U019	U020	U021
------	------	------	------	------	------	------	------	------	------	------	------	------	------	------	------	------	------	------	------	------

U020_S003
COVER:C/T BOX:LEFT:ASS'Y

93.D1941282
(x10)
SEAL:COVER:C/T
BOX:MM120

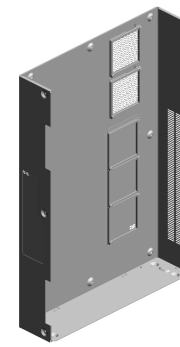
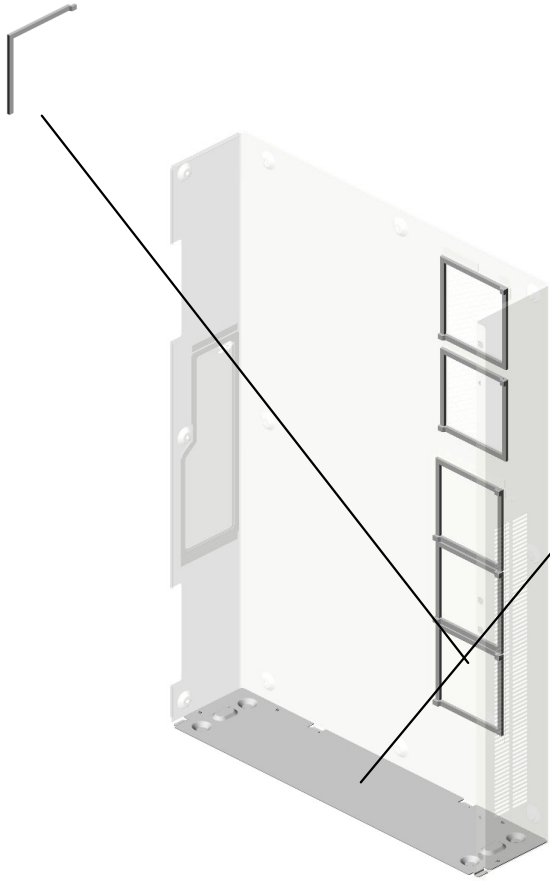

91.D1941265
COVER:C/T BOX:L
EFT:ASS'Y

48.D0741258
COVER:C/T BOX:RI
GHT LOWER



94.D1941462
(x4)
HEXAGON HEAD B
OLT:DOUBLE SCR
EW:M4X10

U001	U002	U003	U004	U005	U006	U007	U008	U009	U010	U011	U012	U013	U014	U015	U016	U017	U018	U019	U020	U021
------	------	------	------	------	------	------	------	------	------	------	------	------	------	------	------	------	------	------	------	------

U020_S004
LIQUID COOLING:FAN:ASS'Y

4.03603006N (x6) SCREW - M3X6
 30.AX640229 (x3) DC FAN MOTOR:D C24V:MM120:25MM
 5.03603030N (x6) SCREW:M3X30

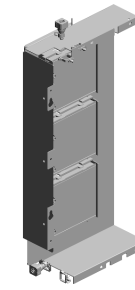

110.D1947250
LIQUID COOLING:FAN:ASS'Y

25.11050725
CLAMPS:WES-111
7

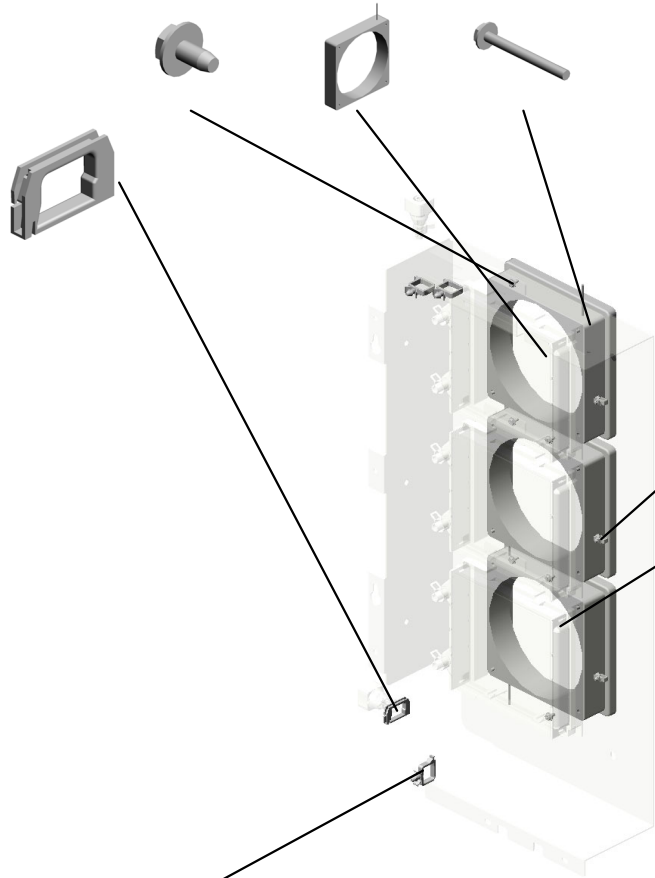

19.11050511
(x3)
HARNES CLAMP -
LWS-0306ZC

82.D0747275
(x3)
DUCT:FAN:LIQUID
COOLING

17.11050489
(x3)
HARNES CLAMP -
LWS 1316

U001	U002	U003	U004	U005	U006	U007	U008	U009	U010	U011	U012	U013	U014	U015	U016	U017	U018	U019	U020	U021
------	------	------	------	------	------	------	------	------	------	------	------	------	------	------	------	------	------	------	------	------

U020_S005
LIQUID COOLING:PT:TAURUS-C2:ASS'Y

4.03603006N 1.03530100N
(x2) SCREW-M3X10
SCREW - M3X6

111.D1948515
LIQUID COOLING:P
T:TAURUS-C2:ASS'
Y
201506-10 X/O



19.11050511
HARNESS CLAMP -
LWS-0306ZC

19.11050511
(x2)
HARNESS CLAMP -
LWS-0306ZC

1.03530100N(x 1)
SCREW-M3X10
4.03603006N(x 2)
SCREW - M3X6

U001	U002	U003	U004	U005	U006	U007	U008	U009	U010	U011	U012	U013	U014	U015	U016	U017	U018	U019	U020	U021
------	------	------	------	------	------	------	------	------	------	------	------	------	------	------	------	------	------	------	------	------

U020_S006
POWER SUPPLY UNIT:ECO:200V

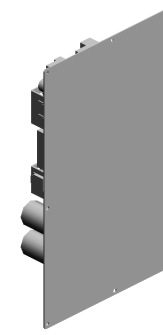

15.09543008N(x 2)
SCREW - M3X8

128.AZ240373
[A]
POWER SUPPLY U
NIT:ECO:200V
201911-04 X/O

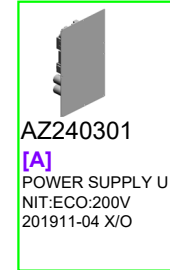

AZ240301
[A]
POWER SUPPLY U
NIT:ECO:200V
201911-04 X/O

U001	U002	U003	U004	U005	U006	U007	U008	U009	U010	U011	U012	U013	U014	U015	U016	U017	U018	U019	U020	U021
------	------	------	------	------	------	------	------	------	------	------	------	------	------	------	------	------	------	------	------	------

U020_S007
HDD UNIT:ASS'Y

27.AA143848
(x8)
STEPPED SCREW
- M3

28.AA161125
(x8)
RUBBER CUSHION

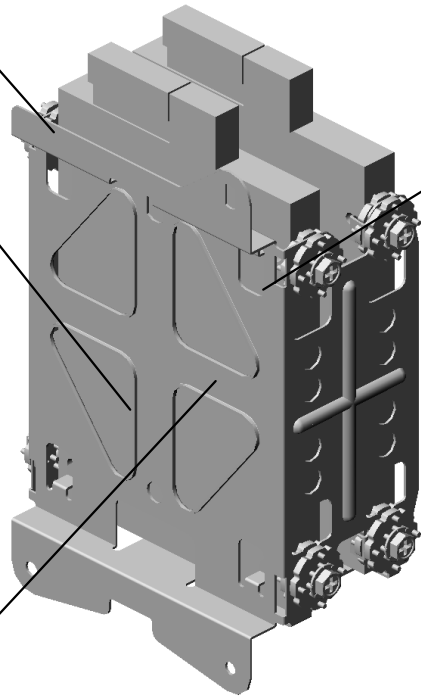

85.D2235308
(x2)
HDD:320GB:MN500
S-2:WD3200LUCT
201607-01 O/O



122.D1365978
BRACKET:HDD

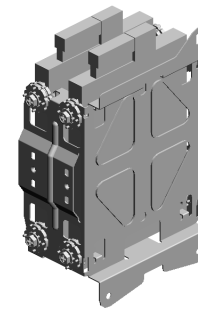

121.D1945832
HDD UNIT:ASS'Y

U020_S008
PCB:GIGAETHERNET:ASS'Y

13.04543006Q
(x2)
TAPPING SCREW -
M3X6

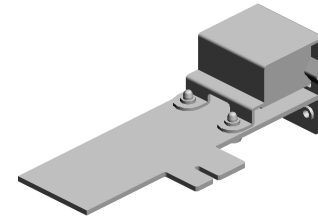

117.D7306036
PCB:GIGAETHERN
ET:ASS'Y

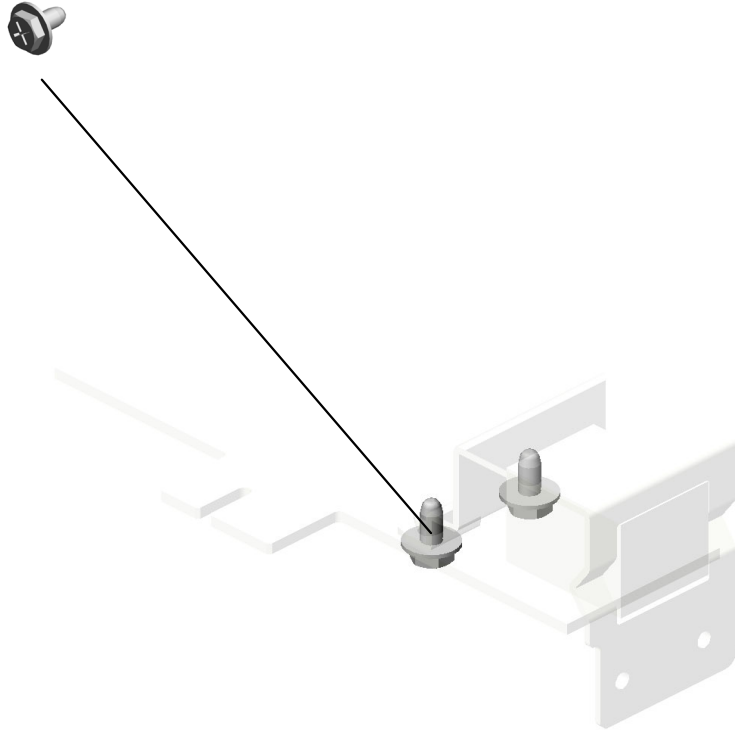

U001	U002	U003	U004	U005	U006	U007	U008	U009	U010	U011	U012	U013	U014	U015	U016	U017	U018	U019	U020	U021
------	------	------	------	------	------	------	------	------	------	------	------	------	------	------	------	------	------	------	------	------

U021.AIR COOLING

U021 S003
D0A57124
DUCT:PCU:FRONT:4ST:ASS'
Y



U021 S004
D0A57124
DUCT:PCU:FRONT:4ST:ASS'
Y



U021 S001
D0A57124
DUCT:PCU:FRONT:4ST:ASS'
Y

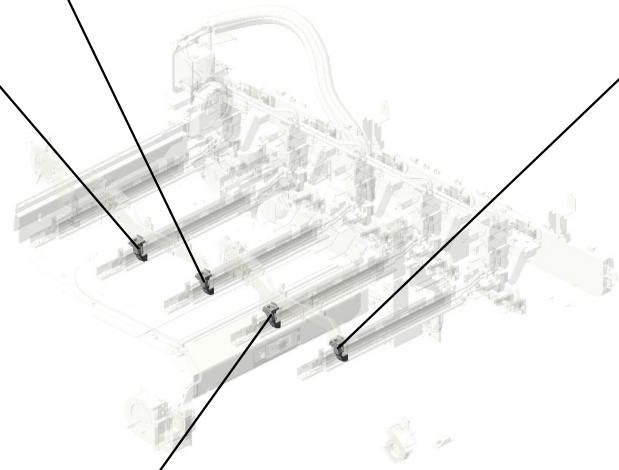

U021 S002
D0A57124
DUCT:PCU:FRONT:4ST:ASS'
Y



U001	U002	U003	U004	U005	U006	U007	U008	U009	U010	U011	U012	U013	U014	U015	U016	U017	U018	U019	U020	U021
------	------	------	------	------	------	------	------	------	------	------	------	------	------	------	------	------	------	------	------	------

U021 AIR COOLING

- 3.03540400N (x6) SCREW:M4X40
- 12.04523012N (x10) BINDING SELF-TAPPING SCREW:M3 X12
- 9.04513006N (x11) TAPPING SCREW - 3X6
- 7.04503008N (x47) TAPPING SCREW - M3X8
- 20.11050516 (x2) CLAMP

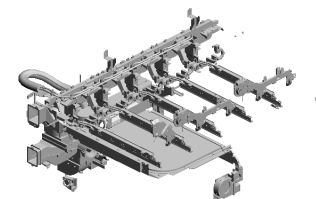

- 10.04514008N (x67) TAPPING SCREW: 4X8

- 1.03530050N (x10) SCREW-M3X5

- 6.03604008N SCREW - M4X8 201806-01 O/O

- 11.04514010N (x3) TAPPING SCREW: 4X10

- 4.03603020N (x4) SCREW:M3X20

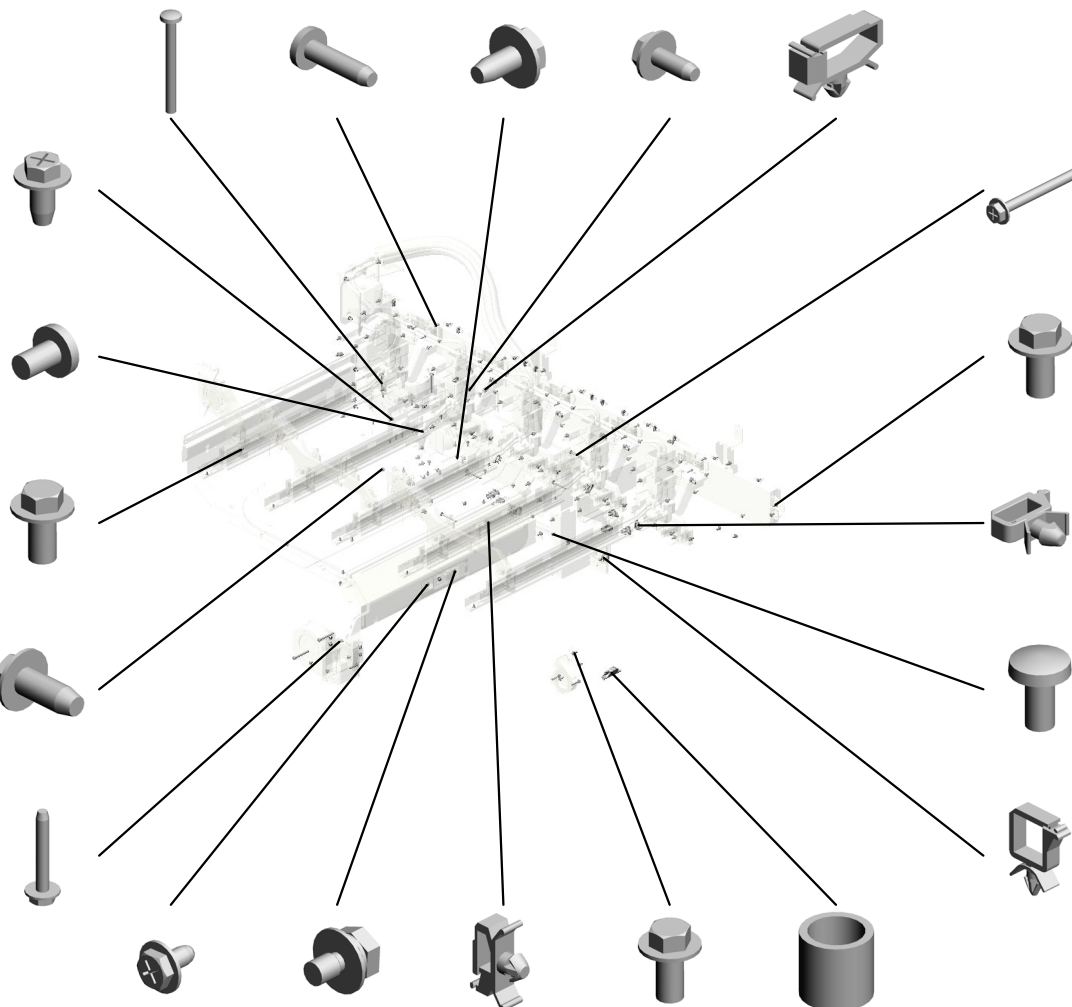

- 13.04543006Q (x10) TAPPING SCREW - M3X6
- 15.08010231 (x2) HEXAGONAL HEAD BOLT WITH WASHER:M3X6
- 19.11050511 (x20) HARNESS CLAMP - LWS-0306ZC
- 6.03604008N (x3) SCREW - M4X8
- 14.07074050N (x2) BUSHING - 4X5

- 8.04503035N (x2) TAPPING SCREW: 3X35

- 6.03604008N (x5) SCREW - M4X8 201812-02 O/O

- 16.11050487 (x10) HARNESS CLAMP

- 2.03530060N BIND SCREW - M3 X6

- 17.11050488 (x3) HARNESS CLAMP



- 17.11050488 HARNESS CLAMP



- 18.11050489 HARNESS CLAMP - LWS 1316



- 21.11050534 CLAMP

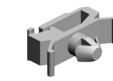

- 22.11050600 CLAMP:LWSM-030 6-2M



- 25.11050768 (x2) CLAMP:LES-0912



- 110.D1947084 SEAL:DUCT:EXHAUST:ABSORB DUST SUB-UNIT:REAR

- 3.03540400N (x 2) SCREW:M4X40
- 5.03603030N (x 2) SCREW:M3X30

U021 AIR COOLING

- 35.AX660015 (x2) DC FAN MOTOR:SIROCCO:DC24V:PW M
- 37.AX660028 DC FAN MOTOR:M80X38:DC24:PW M:7.2W
- 27.AA143645 (x6) STEPPED SCREW: M3:45MM
- 32.AX640221 (x5) FAN:SIROCCO:DC 24V:50MM
- 23.11050723 (x8) CLAMPS:WES-050 7

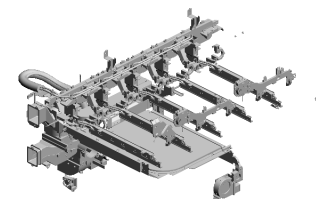

41.D0746935
SEAL:DUCT:HEAT
PIPE:FUSING

28.AA161104
(x2)
CUSHION - MOTO
R

36.AX660016
(x2)
DC FAN MOTOR:M
M60X38:DC24V:PW
M:18W

38.D0746932
DUCT:HEAT PIPE:F
USING:UPPER

42.D0746938
DUCT:CONNECTIN
G:COOLING:FUSIN
G EXIT

34.AX660014
(x2)
DC FAN MOTOR:DI
A97X38:DC24V:PW
M:38.88W

33.AX640330
(x2)
FAN:SIROCCO:DIA
51

39.D0746933
SEAL:DUCT:HEAT
PIPE:FUSING:UPP
ER

24.11050758
(x4)
CLAMP:LWSM-030
6A

30.AW100138
THERMOPILE

44.D0746940
DUCT:UPPER:HEA
T SINKER

31.AX640219
(x2)
DC FAN MOTOR:D
C24V:MM60:25MM

26.AA143544
(x11)
SCREW - M3

43.D0746939
SEAL:DUCT:CONN
ECTING:COOLING:
FUSING EXIT

29.AW100107
THERMISTOR

- 9.04513006N (x 6) TAPPING SCREW - 3X6
- 10.04514008N (x 8) TAPPING SCREW:4X8
- 11.04514010N (x 2) TAPPING SCREW:4X10
- 13.04543006Q (x 1) TAPPING SCREW - M3X6

U021 AIR COOLING

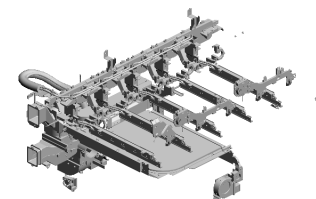

- 59.D0746979 SEAL:DUCT:EXIT:CONNECTING
- 60.D0746987 DUCT:UPPER:FUSING:EXIT:EXHAUST
- 61.D0746988 DUCT:LOWER:FUSING:EXIT:EXHAUST
- 54.D0746969 SEAL:LONG:DUCT:FUSING:EXIT
- 52.D0746967 DUCT:UPPER:FUSING:EXIT

63.D0746998
DUCT:VACUUM:HEAT PIPE:ROLLER

62.D0746995
SEAL:DUCT:HEAT PIPE:ROLLER:VACUUM

58.D0746978
DUCT:LEFT:EXIT:EXHAUST

57.D0746977
DUCT:RIGHT:EXIT:EXHAUST

55.D0746970
SEAL:SHORT:DUCT:FUSING:EXIT

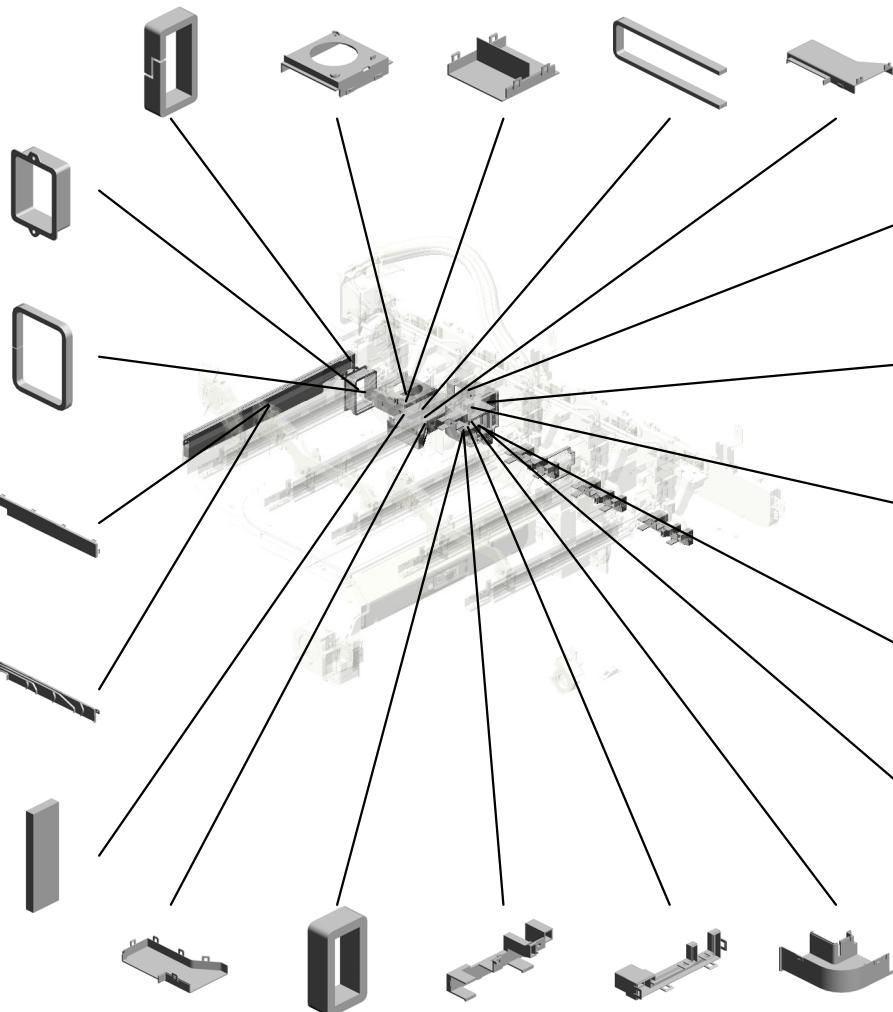

51.D0746965
BRACKET:DUCT:EXHAUST:HEAT SINKER

56.D0746972
SEAL:DUCT:EXHAUST:HEAT SINKER

48.D0746962
DUCT:UPPER:EXHAUST:HEAT SINKER

50.D0746964
BRACKET:FAN:DUCT:EXHAUST:HEAT SINKER

47.D0746943
(x2)
SEAL:LONG:DUCT:HEAT SINKER

53.D0746968
DUCT:LOWER:FUSING:EXIT

66.D0747014
(x5)
SEAL:VACUUM:DUCT:EXHAUST:DEVELOPMENT UNIT

65.D0747013
(x4)
DUCT:LOWER:EXHAUST:DEVELOPMENT UNIT

64.D0747012
(x4)
DUCT:UPPER:EXHAUST:DEVELOPMENT UNIT

49.D0746963
DUCT:LOWER:EXHAUST:HEAT SINKER

U021 AIR COOLING

- 69.D0747028 (x5) SEAL:CONNECTING:ENTRANCE
- 82.D0747095 (x5) SEAL:CONNECTING:ABSORB DUST SUB-UNIT:FAN:ENTRANCE
- 83.D0747102 (x5) SEAL:LOWER:DUCT:CONNECTING:DEVELOPMENT UNIT
- 84.D0747103 (x5) SEAL:UPPER:DUCT:CONNECTING:DEVELOPMENT UNIT
- 68.D0747017 (x5) DUCT:CONNECTING:EXHAUST:DEVELOPMENT UNIT

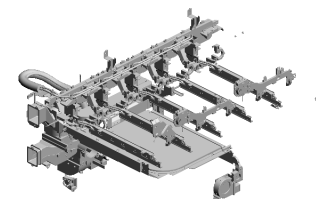

67.D0747015
(x5)
SEAL:EXIT:DUCT:EXHAUST:DEVELOPMENT UNIT



72.D0747045
SEAL:EXIT:SIROCCO



70.D0747042
DUCT:FRONT:EXIT:COOLING:FUSING



78.D0747086
SEAL:VACUUM:COOLING:INTERMEDIATE TRANSFER:PULL OUT



77.D0747083
DUCT:LEFT:COOLING:INTERMEDIATE TRANSFER:PULL OUT



75.D0747080
(x2)
SEAL:DUCT:COOLING:PRESSURE ROLLER:PULL OUT



73.D0747077
DUCT:FRONT:COOLING:PRESSURE ROLLER:PULL OUT



74.D0747078
DUCT:INNER BACK:COOLING:PRESSURE ROLLER:PULL OUT

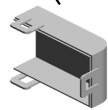

80.D0747089
SEAL:JOINT:DUCT:COOLING:PRESSURE ROLLER

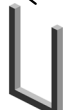

79.D0747087
(x2)
SEAL:DC FAN MOTOR:SIROCCO

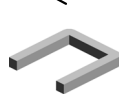

71.D0747043
DUCT:REAR:EXIT:COOLING:FUSING



76.D0747082
DUCT:RIGHT:COOLING:INTERMEDIATE TRANSFER:PULL OUT



81.D0747090
SEAL:VACUUM:POSITIONING SENSOR



85.D0747118
DUCT:INNER BACK:COOLING:POSITIONING SENSOR



86.D0747119
DUCT:FRONT:COOLING:POSITIONING SENSOR



U021 AIR COOLING

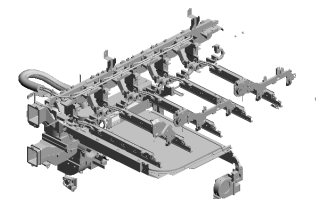

- 106.D1947026 (x5) DUCT:CONNECTING:ABSORB DUST SUB-UNIT:LEFT
- 98.D1946993 DUCT:HEAT PIPE:ROLLER:LOWER
- 97.D1946992 DUCT:HEAT PIPE:ROLLER:UPPER
- 99.D1946997 (x2) SEAL:DUCT:EXHAUST:HEAT PIPE:LONG
- 100.D1946998 (x2) SEAL:DUCT:EXHAUST:HEAT PIPE:SHORT

103.D1947003
SEAL:DUCT:HEAT PIPE:ROLLER:UPPER

89.D1941035
SEAL:HEAT PIPE:ROLLER:FAN:MM60

104.D1947006
SEAL:DUCT:HEAT PIPE:ROLLER:LOWER

102.D1947001
DUCT:EXHAUST:HEAT PIPE:ROLLER:LEFT

88.D1366928
DUCT:DC FAN MOTOR:OPTICAL WRITING UNIT

93.D1946936
BLOCK AIR MOVEMENT PLATE:THERMOPILE

90.D1946923
DUCT:HEAT PIPE:USING:SIDE

94.D1946937 (x2)
SEAL:THERMOPILE:HEAT PIPE

91.D1946924
COVER:HEAT PIPE:THERMOPILE

87.D0894366
COVER:THERMISTOR:LENS

105.D1947022
DUCT:EXHAUST:ABSORB DUST SUB-UNIT:FRONT

96.D1946958
DUCT:REAR:VACUUM:CONNECTING:HEAT SINKER

95.D1946957
DUCT:FRONT:VACUUM:CONNECTING:HEAT SINKER

101.D1947000
DUCT:EXHAUST:HEAT PIPE:ROLLER:RIGHT

92.D1946931
PANEL MOUNT:THERMOPILE

U021 AIR COOLING

116.D1947183 DUCT:EXIT:GUIDE PLATE:ENTRANCE:COVER
 115.D1947182 SEAL:DUCT:EXIT:GUIDE PLATE:INNER BACK
 119.D1947188 DUCT:EXIT:GUIDE PLATE:ENTRANCE:LEFT
 120.D1947189 DUCT:EXIT:GUIDE PLATE:ENTRANCE:RIGHT
 114.D1947181 SEAL:DUCT:EXIT:GUIDE PLATE:ENTRANCE

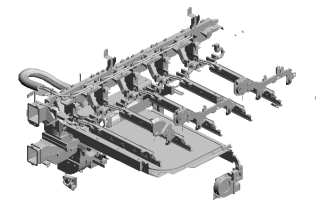

118.D1947186 SEAL:DUCT:EXIT:GUIDE PLATE:FAN



117.D1947184 DUCT:EXIT:GUIDE PLATE:EXHAUST



124.D1947266 SEAL:DUCT:COOLING:GUIDE PLATE:3



123.D1947265 SEAL:DUCT:COOLING:GUIDE PLATE:2



122.D1947264 SEAL:DUCT:COOLING:GUIDE PLATE:1



112.D1947165 SHEET:DUCT:FUSING:EXIT:EXHAUST

126.D2037013 DUCT:LOWER:EXHAUST:DEVELOPMENT UNIT:S

121.D1947227 SEAL:HEAT PIPE:ROLLER:FAN:MM80

125.D2037012 DUCT:UPPER:EXHAUST:DEVELOPMENT UNIT:S

113.D1947173 SEAL:DUCT:REAR:COOLING:FUSING EXIT

109.D1947033 (D194/D195):(D203/D204-NA,-EU):SEAL:RELAY DUCT:EXHAUST



111.D1947153 (x5) FILTER:RELAY DUCT:EXHAUST:ASS'Y



107.D1947027 (x5) DUCT:CONNECTING:ABSORB DUST SUB-UNIT:RIGHT



108.D1947030 DUCT:EXHAUST:ABSORB DUST SUB-UNIT:REAR



110.D1947084 SEAL:DUCT:EXHAUST:ABSORB DUST SUB-UNIT:REAR



U021 AIR COOLING

134.D1947152 (x2) FAN:PCU:UPPER FRONT:ASSY
 129.D1947042 (x2) DUCT:PCU:UPPER FRONT:SERVICE:ASSY 201511-05
 133.D1947144 (x4) BRACKET:DUCT:PCU:UPPER FRONT:AUXILIARY 201511-06
 138.11050761 (x9) CLAMP:LWS-0511A 201802-01 O/O

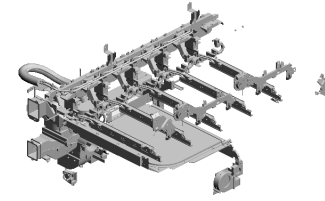

130.D1947103
 DUCT:PCU:UPPER FRONT:SST:ASSY



143.D0A57129
 DUCT:PCU:FRONT:5ST:ASSY 202402-02 O/O



137.D0A56934
 DUCT:HEAT PIPE:FRONT:USING:LOWER 201710-06 O/O



140.D0A56942 (x2)
 SEAL:SHORT:DUCT:HEAT SINKER 201806-04 O/O



139.D0A56941
 DUCT:LOWER:HEAT SINKER 201806-09 O/O



141.04544008Q
 TAPPING SCREW - M4X8 201812-03 O/O



127.GX640028
 FAN MOTOR DC24 V 1.92W



136.D0747120
 BRACKET:DUCT:COOLING:POSITIONING SENSOR

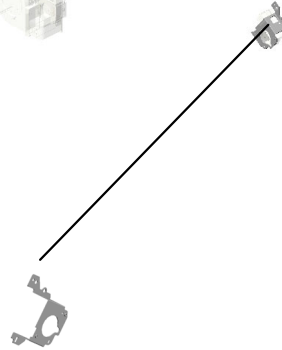

U021_S001
DUCT:PCU:FRONT:4ST:ASS'Y

131.D1947127
DUCT:PCU:FRONT:
4ST:ASS'Y

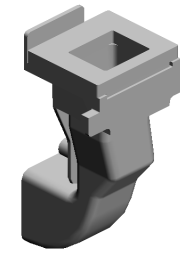

142.D0A57124
[A]
DUCT:PCU:FRONT:
4ST:ASS'Y
202001-01 O/O

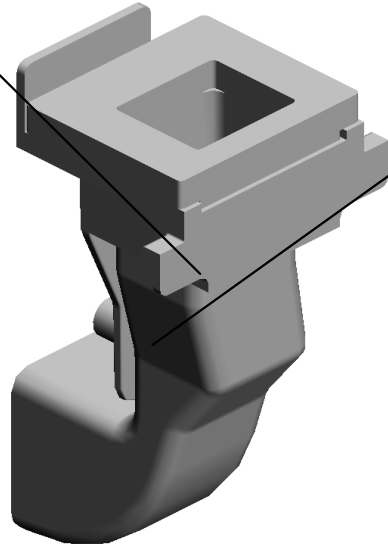

6.03604008N
SCREW - M4X8
201606-01 O/O



D1947124
[A]
DUCT:PCU:FRONT:
4ST:ASS'Y
202001-01 O/O

U001	U002	U003	U004	U005	U006	U007	U008	U009	U010	U011	U012	U013	U014	U015	U016	U017	U018	U019	U020	U021
------	------	------	------	------	------	------	------	------	------	------	------	------	------	------	------	------	------	------	------	------

U021_S002
DUCT:PCU:FRONT:4ST:ASS'Y

131.D1947127
DUCT:PCU:FRONT:
4ST:ASS'Y

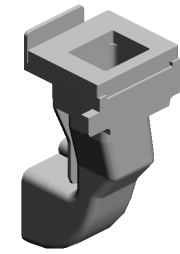

142.D0A57124
[A]
DUCT:PCU:FRONT:
4ST:ASS'Y
202001-01 O/O



6.03604008N
SCREW - M4X8
201606-01 O/O

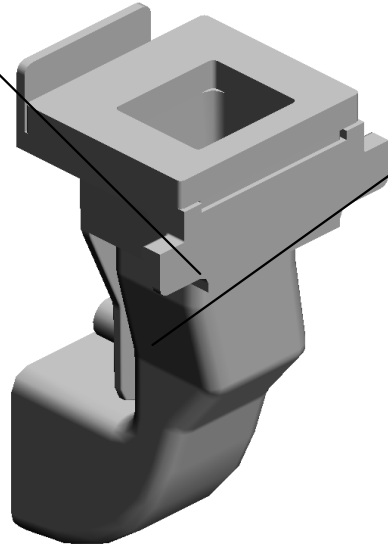

D1947124
[A]
DUCT:PCU:FRONT:
4ST:ASS'Y
202001-01 O/O

U021_S003
DUCT:PCU:FRONT:4ST:ASS'Y

131.D1947127
DUCT:PCU:FRONT:
4ST:ASS'Y

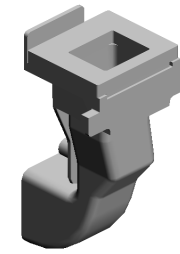

142.D0A57124
[A]
DUCT:PCU:FRONT:
4ST:ASS'Y
202001-01 O/O

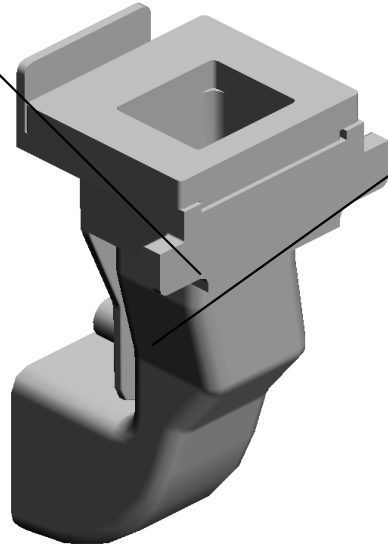

6.03604008N
SCREW - M4X8
201606-01 O/O



D1947124
[A]
DUCT:PCU:FRONT:
4ST:ASS'Y
202001-01 O/O

U001	U002	U003	U004	U005	U006	U007	U008	U009	U010	U011	U012	U013	U014	U015	U016	U017	U018	U019	U020	U021
------	------	------	------	------	------	------	------	------	------	------	------	------	------	------	------	------	------	------	------	------

U021_S004
DUCT:PCU:FRONT:4ST:ASS'Y

131.D1947127
DUCT:PCU:FRONT:
4ST:ASS'Y

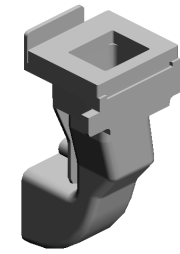

142.D0A57124
[A]
DUCT:PCU:FRONT:
4ST:ASS'Y
202001-01 O/O



6.03604008N
SCREW - M4X8
201606-01 O/O

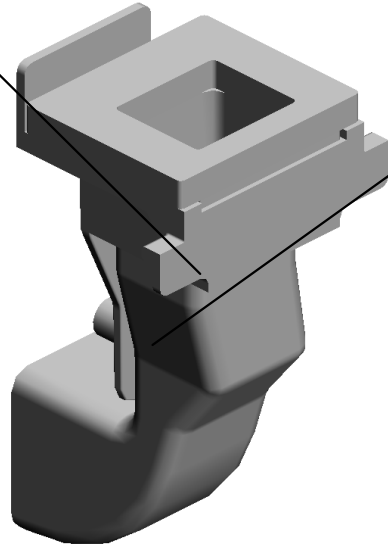

D1947124
[A]
DUCT:PCU:FRONT:
4ST:ASS'Y
202001-01 O/O

U001	U002	U003	U004	U005	U006	U007	U008	U009	U010	U011	U012	U013	U014	U015	U016	U017	U018	U019	U020	U021
------	------	------	------	------	------	------	------	------	------	------	------	------	------	------	------	------	------	------	------	------

U022 MAIN FRAME

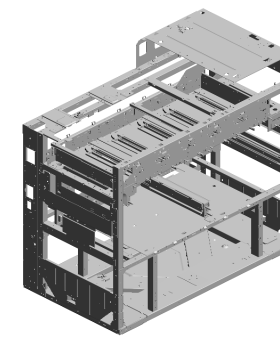

- 16.11050600 (x3) CLAMP:LWSM-030 6-2M
- 17.11050601 (x3) CLAMP:LWSM-051 1-2M
- 6.04514008N (x148) TAPPING SCREW: 4X8
- 13.11050489 (x7) HARNESS CLAMP - LWS 1316
- 11.11050487 (x14) HARNESS CLAMP

- 19.11050723 (x3) CLAMPS:WES-050 7

- 15.11050508 (x6) HARNESS CLAMP - LWS-0711

- 10.08046123 HEXAGONAL BOLT :W/WASHER:M3X8

- 26.D0741125 PLATE:RADIAL BALL BEARING:THRU ST

- 12.11050488 (x9) HARNESS CLAMP

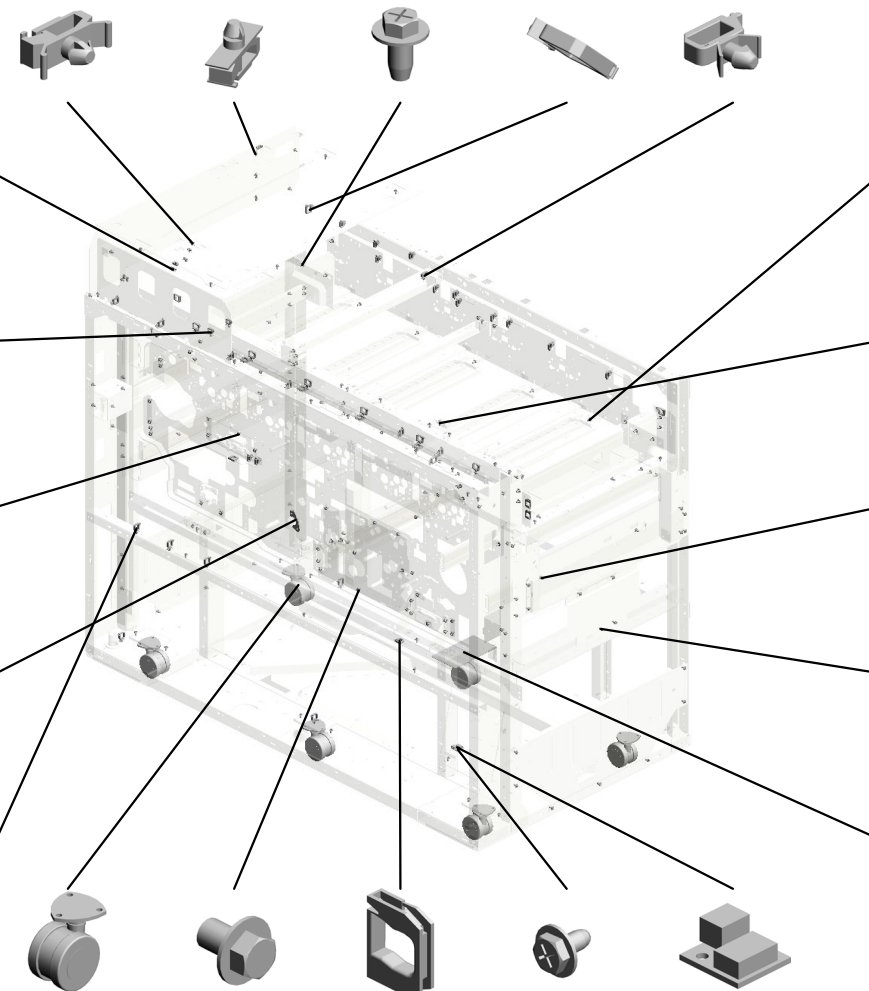

- 3.03540080N (x5) SCREW:M4X8



- 11.11050487 (x16) HARNESS CLAMP

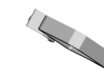

- 13.11050489 (x109) HARNESS CLAMP - LWS 1316

- 1.03140120N (x1) SCREW - M4X12



- 2.03540060N (x12) SCREW-M4X6



- 14.11050490 (x16) HARNESS CLAMP - IWS-2218



- 15.11050508 (x22) HARNESS CLAMP - LWS-0711

- 5.03604008N (x10) SCREW - M4X8



- 16.11050600 (x5) CLAMP:LWSM-030 6-2M

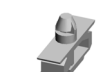

- 17.11050601 (x4) CLAMP:LWSM-051 1-2M

- 25.D0741088 SHEET:BASE:MAIN :FRONT



- 22.AH012031 (x6) CASTER:1470N



- 4.03604006N (x8) SCREW - M4X6

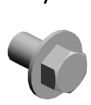

- 20.11050724 (x10) CLAMPS:WES-121 0



- 8.04543006Q TAPPING SCREW - M3X6



- 24.AW140015 TEMPERATURE & HUMIDITY SENSOR



- 18.11050683 (x3) CLAMP:LWSR-051 1S

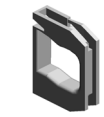

- 20.11050724 CLAMPS:WES-121 0

U022 MAIN FRAME

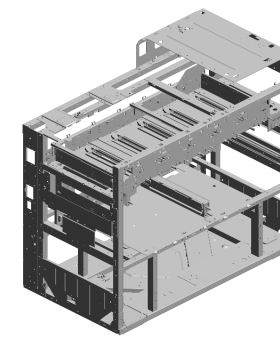

- 38.D1941162 (x2) SLIDE RAIL:TRANSPORT UNIT 201601-05 O/O
- 50.D1941190 (x5) SEAL:OPTICAL WRITING UNIT:UPPER:RIGHT 201508-02
- 49.D1941189 (x5) SEAL:OPTICAL WRITING UNIT:UPPER:LEFT 201508-01
- 42.D1941186 HOLDER:CONNECTOR:Toner Support
- 37.D1361687 GROUND PLATE:SENSOR:AKS

- 33.D0744351 (x8) STEPPED SCREW: DIA5.4DIA:3.5M3

- 35.D0746078 (x8) COMPRESSION SPRING:DRAWER:INTERMEDIATE TRANSFER

- 32.D0741195 (x4) GUIDE:LOCK:TRANSPORT UNIT

- 47.G1787744 BOSS:POSITIONING PIN:TRANSPORT UNIT:NO.2

- 44.G1781134 (x4) HEXAGONAL BOLT :M20X70

- 31.D0741173 BOSS:POSITIONING PIN:TRANSPORT UNIT:NO.2:10.3MM
- 27.D0741128 PLAIN SHAFT BEARING:POSITIONING PIN:FUSING
- 29.D0741152 SLIDE RAIL:EXIT:RIGHT
- 46.G1787743 (x3) BOSS:POSITIONING PIN:TRANSPORT UNIT:NO.1
- 30.D0741154 COVER:PAPER EXIT UNIT:EXIT

- 40.D1941168 (x5) COVER:SHIELD GLASS

- 21.11050751 (x42) CLAMP:LWSM-060 6-3.2M

- 48.D1941159 (x2) SLIDE RAIL:INTERMEDIATE TRANSFER 201702-01 O/O

- 34.D0744529 COVER:PAPER EXIT SUB-UNIT:EXIT

- 28.D0741143 BRACKET:COUPLING

- 45.G1784746 SLIDE RAIL:EXIT

- 2. 03540060N (x 3) SCREW-M4X6
- 3. 03540080N (x 2) SCREW:M4X8
- 4. 03604006N (x 7) SCREW - M4X6
- 5. 03604008N (x 4) SCREW - M4X8
- 6. 04514008N (x43) TAPPING SCREW:4X8
- 7. 04514012N (x 8) TAPPING SCREW:4X12
- 9. 04544006Q (x 1) TAPPING SCREW:4X6

U022 MAIN FRAME

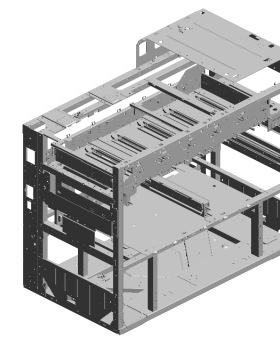

- 64.D1941371 STAY:MAIN:RIGHT UPPER:ASS'Y
- 58.D0A51164 COVER:TONER SUPPLY 201807-02 X/X
- 63.G1787515 (x2) CONNECTOR GUIDE PIN:CONNECTOR 201502-06 X/O
- 65.AW020249 PHOTOINTERRUPTOR:FLAT:PICH2MM:M4 202306-01 O/O

- 55.11035760 CONNECTOR:36W 0R-RFC-EGD(LF)(SN)

- 56.11035761 CONNECTOR:44W 0R-RFC-EGD(LF)(SN)

- 62.G1784866 (x2) COMPRESSION SPRING:EXIT:CONNECTOR

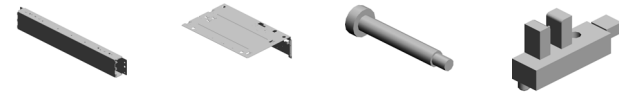

- 57.D1944653 BRACKET:DRAWER:PAPER EXIT UNIT:MAIN

- 56.11035761 CONNECTOR:44W 0R-RFC-EGD(LF)(SN) 201712-05

- 53.D0741141 (x2) SUPPORTING PLATE:FRAME:MAIN

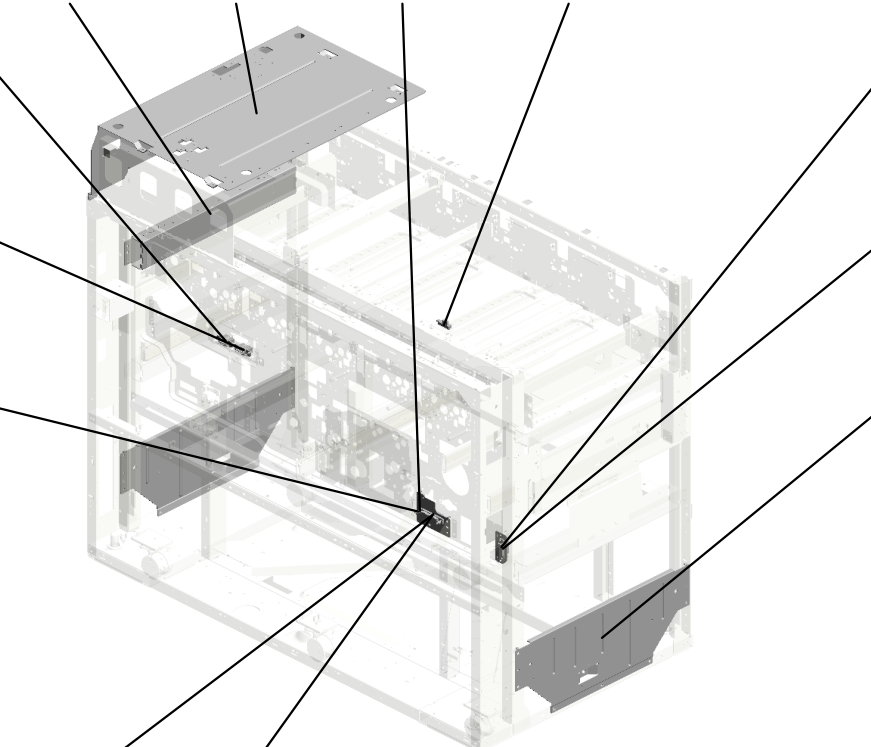

- 59.11029805 CONNECTOR:6-29 2233-0

- 60.D1944821 BRACKET:DRAWER:DUPLEX:MAIN

U023.ACCESSORIES

U023 S002
D1957984
(-AA);POWER SUPPLY COR
D:ASS'Y

U023 S003
D1957984
(-AA);POWER SUPPLY COR
D:ASS'Y

U023 S001
M0771861
TUBE TYPE LAMP:TAC:ASS'
Y

U023 S004
D1957986
POWER SUPPLY CORD:ASS'
Y

U023 S005
D1957986
POWER SUPPLY CORD:ASS'
Y

U023 S006
D1947981
(-AA,-EU);POWER SUPPLY C
ODE:DECAL:ASS'Y

U023 S007
D1947981
(-AA,-EU);POWER SUPPLY C
ODE:DECAL:ASS'Y

U023 S008
D1947981
(-AA,-EU);POWER SUPPLY C
ODE:DECAL:ASS'Y

U023 S009
D1947981
(-AA,-EU);POWER SUPPLY C
ODE:DECAL:ASS'Y

U023 S010
D1947982
(-NA);POWER SUPPLY COD
E:DECAL:ASS'Y

U023 S011
D1947982
(-NA);POWER SUPPLY COD
E:DECAL:ASS'Y

U023 S012
D1947983
(CHN);POWER SUPPLY COD
E:DECAL:ASS'Y

U001	U002	U003	U004	U005	U006	U007	U008	U009	U010	U011	U012	U013	U014	U015	U016	U017	U018	U019	U020	U021
------	------	------	------	------	------	------	------	------	------	------	------	------	------	------	------	------	------	------	------	------

U023.ACCESSORIES

U023 S013
D1947983
(CHN):POWER SUPPLY COD
E:DECAL:ASSY

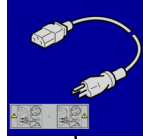

U001	U002	U003	U004	U005	U006	U007	U008	U009	U010	U011	U012	U013	U014	U015	U016	U017	U018	U019	U020	U021
------	------	------	------	------	------	------	------	------	------	------	------	------	------	------	------	------	------	------	------	------

U023 ACCESSORIES

- 16.D0746734 COVER:OPERATION PANEL:REAR
- 14.D0746727 COVER:HARNESS:OPERATION PANEL
- 24.D0746735 COVER:OPERATION PANEL:REAR UPPER 201606-02 O/O
- 19.D0747775 (x2) (-NA,-CHN):PLATE:LOGO:RICOH
- 25.D1797350 (x2) (-NA,-CHN):PLATE:LOGO:RIC

17.D0746738
CAP:COVER:ARM:RIGHT

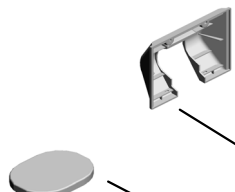

15.D0746728
COVER:ARM:OPERATION SUB-UNIT:RIGHT

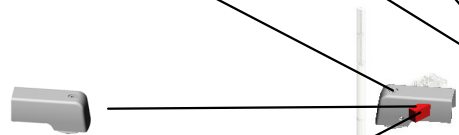

22.D1791748
HOLDER:EXPOSURE GLASS:ASS'Y

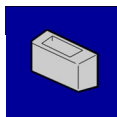

29.D1947880
(D194):(D203/D204-NA,-EU):MODEL NAME PLATE:PRO_C7100S



23.D1795923
(x2)
PLATE:POWER SUPPLY CORD:INLET



18.D0747391
(x2)
DECAL:PAPER SET DIRECTION



12.D0744225
KNOB:FUSING



20.D0747847
(x2)
(-AA,-NA):DECAL:CAUTION CHART:INKJET:PAPER

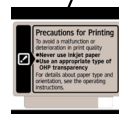

21.D0747883
(-CHN):DECAL:CAUTION CHART:INKJET:PAPER



13.D0744391
HOLDER:KNOB:FUSING:DUAL FACES TEPE



26.D1797362
(x2)
(-AA,-NA):DECAL:FUNCTION:MULTI-LANGUAGE

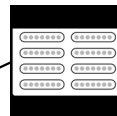

27.D1797363
(-EU):DECAL:FUNCTION:MULTI-LANGUAGE

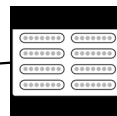

28.D1797364
(-CHN):DECAL:FUNCTION:MULTI-LANGUAGE

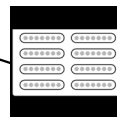

30.D1947888
(x2)
(-EU,-CHN):DECAL:DC:MAIN SWITCH



31.D1947889
(x2)
(-AA,-NA):DECAL:DC:MAIN SWITCH

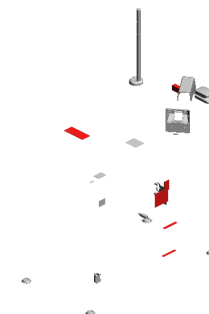

6.11050534
CLAMP

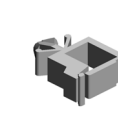

10.B0651374
CLOTH - DF EXPOSURE GLASS

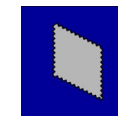

11.B3058671
(-AA):SHEET:EULA:TAIWAN



37.D1955770
(-NA):CABLE:5000:POWER_CONNECT



45.G1788350
WRENCH:HEXAGONAL BOLT

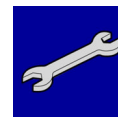

1.03540060N(x 4)
SCREW-M4X6
2.03604006N(x 7)
SCREW - M4X6

U001 U002 U003 U004 U005 U006 U007 U008 U009 U010 U011 U012 U013 U014 U015 U016 U017 U018 U019 U020 U021

U023 ACCESSORIES

53.D3AK0206 MAIN:ASS'Y
201904-04 O/O

38.D1957880 (x3)
(D195):MODEL NA
ME PLATE:PRO_C
7110S

36.D1948875 (x2)
DECAL:APPLICATI
ON:ACCESSORY



4.04514006N(x 1)
TAPPING SCREW - 4X6

5.04514008N(x 2)
TAPPING SCREW:4X8

49.D2037880
(D203):MODEL NA
ME PLATE:PRO_C
7100SX
201606-05



50.D2047880
(D204):MODEL NA
ME PLATE:PRO_C
7110SX



41.D1957990
DECAL:CAUTION:I
NLET



44.G1781141
(x4)
HOLDER:STAND:M
20



48.D1944495
DECAL:MISFEED R
EMOVAL:FLAT CO
NVEYER BELT
201606-04



32.D1947896
(x2)
(-AA,-NA):DECAL:C
AUTION CHART:C
OPY:ORIGINAL:EN
GLISH

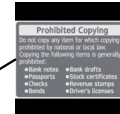

43.D7316022
DECAL:CAUTION:O
RIGINAL:MANY LA
NGUAGES



33.D1947898
(x2)
(-AA,-NA):DECAL:P
OWER SOURCE:O
FF:ENGLISH

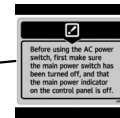

U023_S001
TUBE TYPE LAMP:TAC:ASS'Y



46.M0771861
TUBE TYPE LAMP:
TAC:ASS'Y

3.04503012N(x 3)
TAPPING SCREW:3X12

U001	U002	U003	U004	U005	U006	U007	U008	U009	U010	U011	U012	U013	U014	U015	U016	U017	U018	U019	U020	U021
------	------	------	------	------	------	------	------	------	------	------	------	------	------	------	------	------	------	------	------	------

U023_S002
(-AA):POWER SUPPLY CORD:ASS'Y

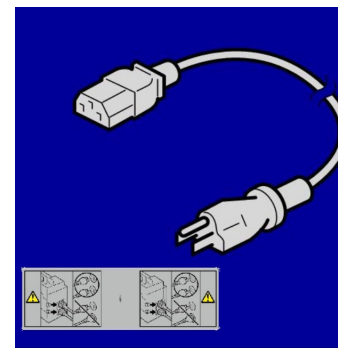

39.D1957984
(-AA):POWER SUP
PLY CORD:ASS'Y

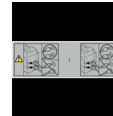
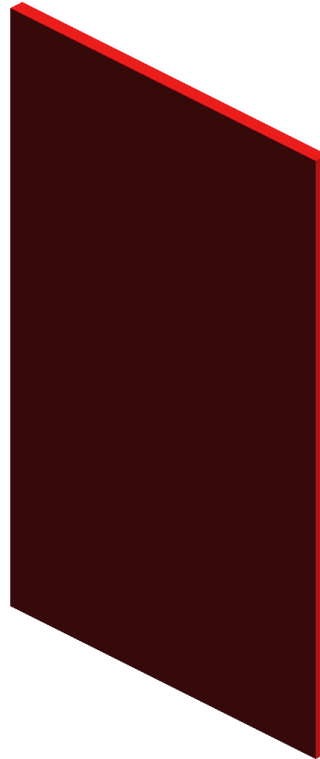

42.D1957991
DECAL:CAUTION:P
OWER SUPPLY CO
RD

U001	U002	U003	U004	U005	U006	U007	U008	U009	U010	U011	U012	U013	U014	U015	U016	U017	U018	U019	U020	U021
------	------	------	------	------	------	------	------	------	------	------	------	------	------	------	------	------	------	------	------	------

U023_S003
(-AA):POWER SUPPLY CORD:ASS'Y

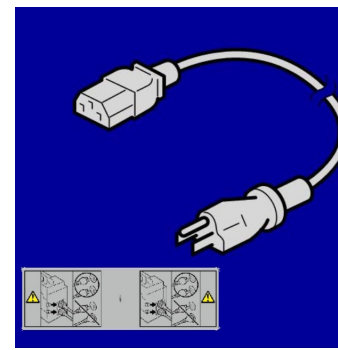

39.D1957984
(-AA):POWER SUP
PLY CORD:ASS'Y

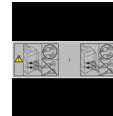
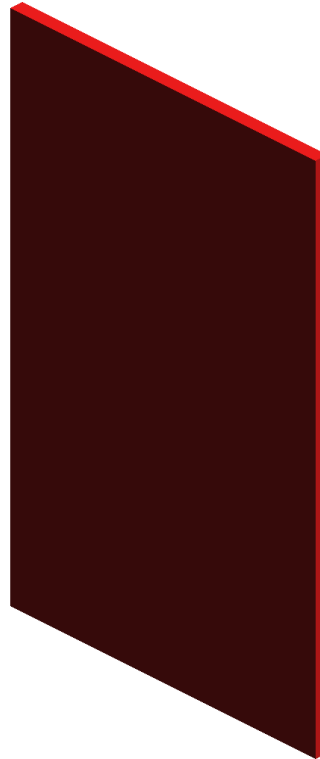

42.D1957991
DECAL:CAUTION:P
OWER SUPPLY CO
RD

U001	U002	U003	U004	U005	U006	U007	U008	U009	U010	U011	U012	U013	U014	U015	U016	U017	U018	U019	U020	U021
------	------	------	------	------	------	------	------	------	------	------	------	------	------	------	------	------	------	------	------	------

U023_S004
POWER SUPPLY CORD:ASS'Y

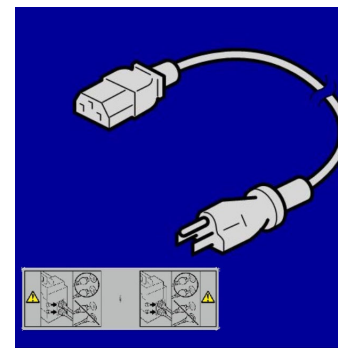

40.D1957986
POWER SUPPLY C
ORD:ASS'Y

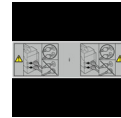
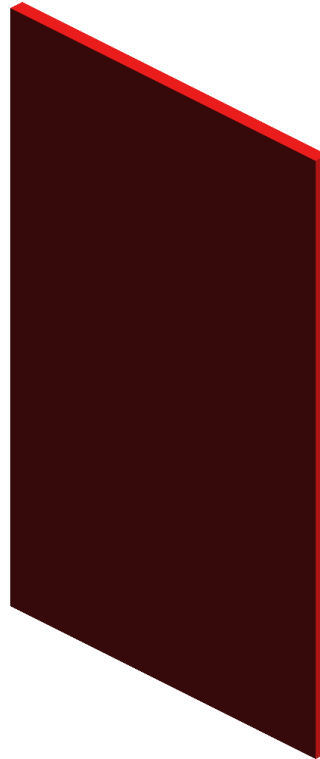

42.D1957991
DECAL:CAUTION:P
OWER SUPPLY CO
RD

U001	U002	U003	U004	U005	U006	U007	U008	U009	U010	U011	U012	U013	U014	U015	U016	U017	U018	U019	U020	U021
------	------	------	------	------	------	------	------	------	------	------	------	------	------	------	------	------	------	------	------	------

U023_S005
POWER SUPPLY CORD:ASS'Y

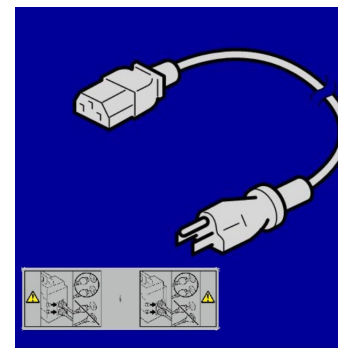

40.D1957986
POWER SUPPLY C
ORD:ASS'Y

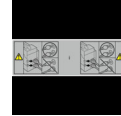
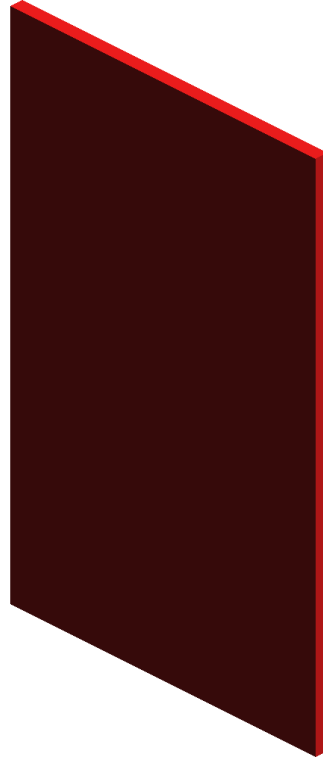

42.D1957991
DECAL:CAUTION:P
OWER SUPPLY CO
RD

U001	U002	U003	U004	U005	U006	U007	U008	U009	U010	U011	U012	U013	U014	U015	U016	U017	U018	U019	U020	U021
------	------	------	------	------	------	------	------	------	------	------	------	------	------	------	------	------	------	------	------	------

U023_S006
(-AA,-EU):POWER SUPPLY CODE:DECAL:ASS'Y

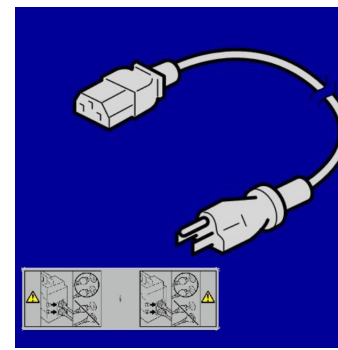

34.D1947981
(-AA,-EU):POWER
SUPPLY CODE:DE
CAL:ASS'Y

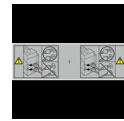

42.D1957991
DECAL:CAUTION:P
OWER SUPPLY CO
RD

7.11500454(x 1)
(-AA,-EU):POWER SUPPLY CODE:250V
:16A

U001	U002	U003	U004	U005	U006	U007	U008	U009	U010	U011	U012	U013	U014	U015	U016	U017	U018	U019	U020	U021
------	------	------	------	------	------	------	------	------	------	------	------	------	------	------	------	------	------	------	------	------

U023_S007
(-AA,-EU):POWER SUPPLY CODE:DECAL:ASS'Y

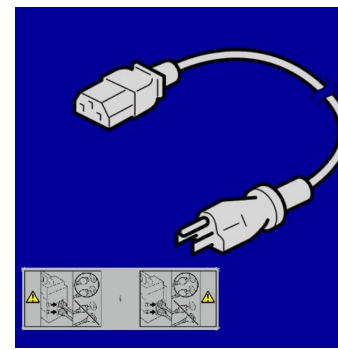

34.D1947981
(-AA,-EU):POWER
SUPPLY CODE:DE
CAL:ASS'Y

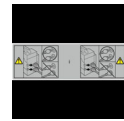
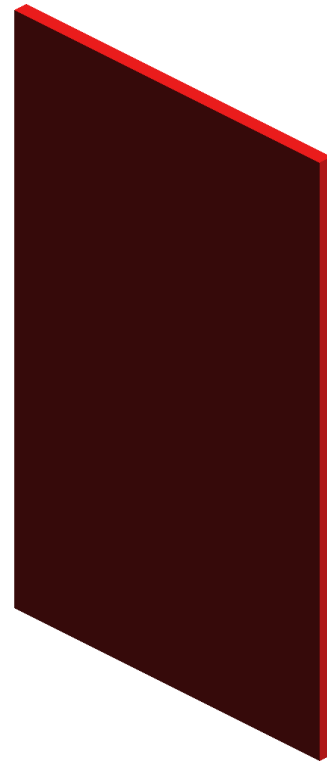

42.D1957991
DECAL:CAUTION:P
OWER SUPPLY CO
RD

7.11500454(x 1)
(-AA,-EU):POWER SUPPLY CODE:250V
:16A

U001	U002	U003	U004	U005	U006	U007	U008	U009	U010	U011	U012	U013	U014	U015	U016	U017	U018	U019	U020	U021
------	------	------	------	------	------	------	------	------	------	------	------	------	------	------	------	------	------	------	------	------

U023_S008
(-AA,-EU):POWER SUPPLY CODE:DECAL:ASS'Y

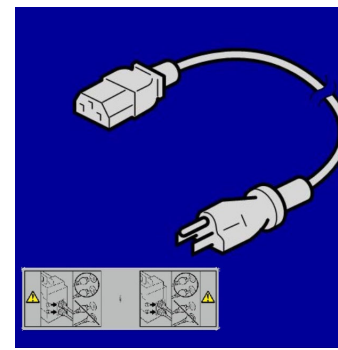

34.D1947981
(-AA,-EU):POWER
SUPPLY CODE:DE
CAL:ASS'Y

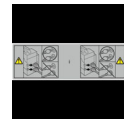
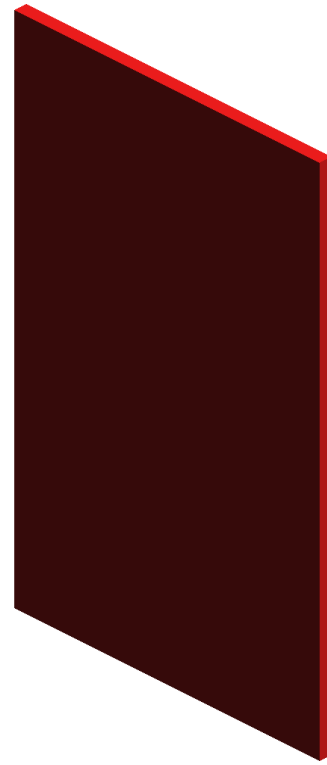

7.11500454(x 1)
(-AA,-EU):POWER SUPPLY CODE:250V
:16A
42.D1957991
DECAL:CAUTION:P
OWER SUPPLY CO
RD

U001	U002	U003	U004	U005	U006	U007	U008	U009	U010	U011	U012	U013	U014	U015	U016	U017	U018	U019	U020	U021
------	------	------	------	------	------	------	------	------	------	------	------	------	------	------	------	------	------	------	------	------

U023_S009
(-AA,-EU):POWER SUPPLY CODE:DECAL:ASS'Y

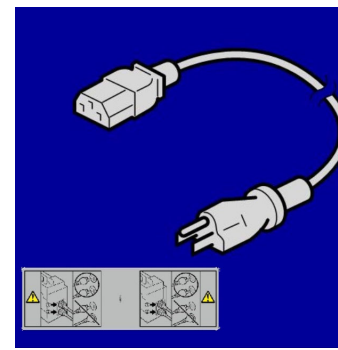

34.D1947981
(-AA,-EU):POWER
SUPPLY CODE:DE
CAL:ASS'Y

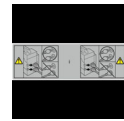
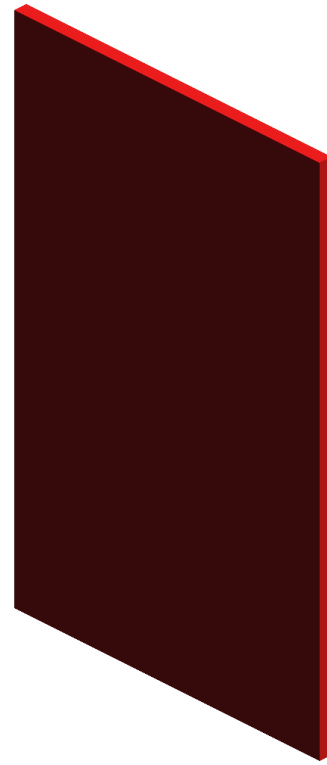

42.D1957991
DECAL:CAUTION:P
OWER SUPPLY CO
RD

7.11500454(x 1)
(-AA,-EU):POWER SUPPLY CODE:250V
:16A

U001	U002	U003	U004	U005	U006	U007	U008	U009	U010	U011	U012	U013	U014	U015	U016	U017	U018	U019	U020	U021
------	------	------	------	------	------	------	------	------	------	------	------	------	------	------	------	------	------	------	------	------

U023_S010
(-NA):POWER SUPPLY CODE:DECAL:ASS'Y

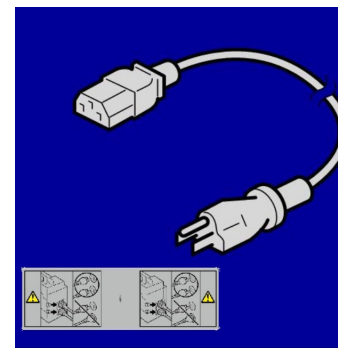

35.D1947982
(-NA):POWER SUP
PLY CODE:DECAL:
ASS'Y

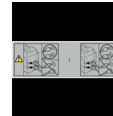
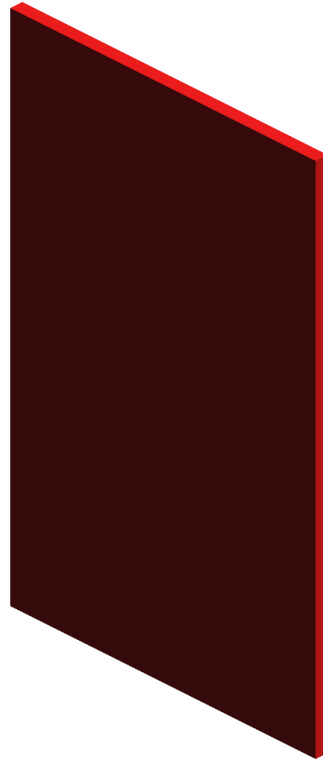

42.D1957991
DECAL:CAUTION:P
OWER SUPPLY CO
RD

8. 11500455(x 1)
(-NA):POWER SUPPLY CODE250V:20A

U001	U002	U003	U004	U005	U006	U007	U008	U009	U010	U011	U012	U013	U014	U015	U016	U017	U018	U019	U020	U021
------	------	------	------	------	------	------	------	------	------	------	------	------	------	------	------	------	------	------	------	------

U023_S011
(-NA):POWER SUPPLY CODE:DECAL:ASS'Y

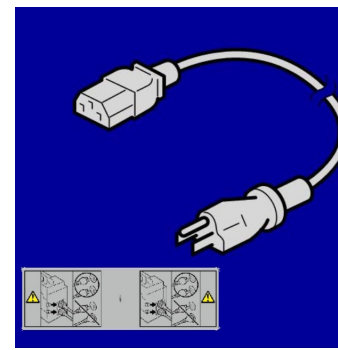

35.D1947982
(-NA):POWER SUP
PLY CODE:DECAL:
ASS'Y

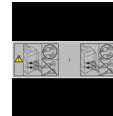
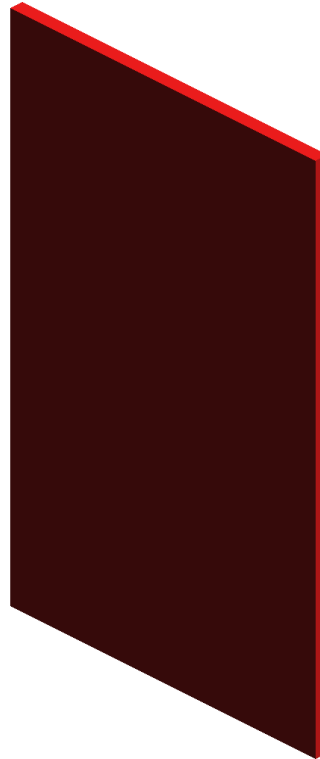

42.D1957991
DECAL:CAUTION:P
OWER SUPPLY CO
RD

8. 11500455(x 1)
(-NA):POWER SUPPLY CODE250V:20A

U001	U002	U003	U004	U005	U006	U007	U008	U009	U010	U011	U012	U013	U014	U015	U016	U017	U018	U019	U020	U021
------	------	------	------	------	------	------	------	------	------	------	------	------	------	------	------	------	------	------	------	------

U023_S012
(CHN):POWER SUPPLY CODE:DECAL:ASS'Y

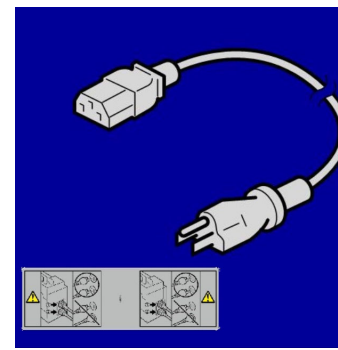

47.D1947983
(CHN):POWER SU
PLY CODE:DECA
L:ASS'Y

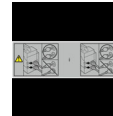
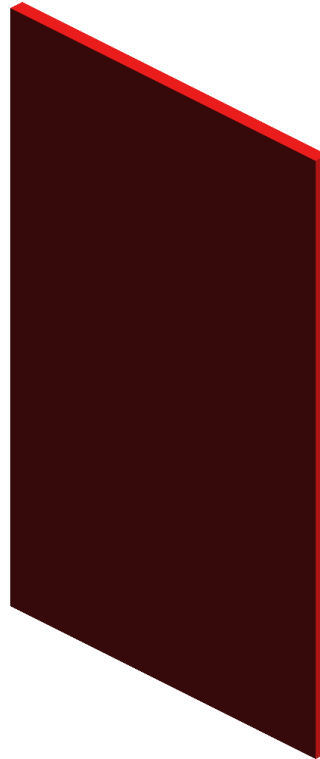

42.D1957991
DECAL:CAUTION:P
OWER SUPPLY CO
RD

9.11500466(x 1)
(-CHN):POWER SUPPLY CODE:250V:1
6A

U001	U002	U003	U004	U005	U006	U007	U008	U009	U010	U011	U012	U013	U014	U015	U016	U017	U018	U019	U020	U021
------	------	------	------	------	------	------	------	------	------	------	------	------	------	------	------	------	------	------	------	------

U023_S013
(CHN):POWER SUPPLY CODE:DECAL:ASS'Y

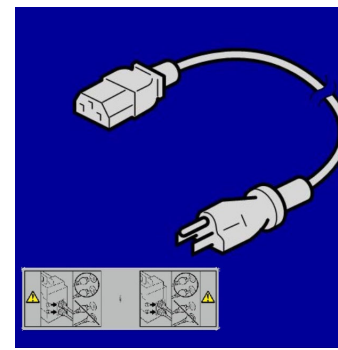

47.D1947983
(CHN):POWER SU
PLY CODE:DECA
L:ASS'Y

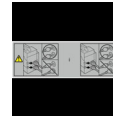
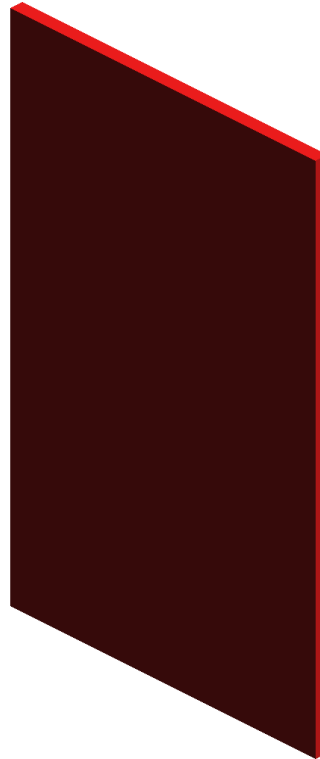

42.D1957991
DECAL:CAUTION:P
OWER SUPPLY CO
RD

9.11500466(x 1)
(-CHN):POWER SUPPLY CODE:250V:1
6A

U001	U002	U003	U004	U005	U006	U007	U008	U009	U010	U011	U012	U013	U014	U015	U016	U017	U018	U019	U020	U021
------	------	------	------	------	------	------	------	------	------	------	------	------	------	------	------	------	------	------	------	------

U024 HEATER

1-04543006Q
(x2)
TAPPING SCREW -
M3X6

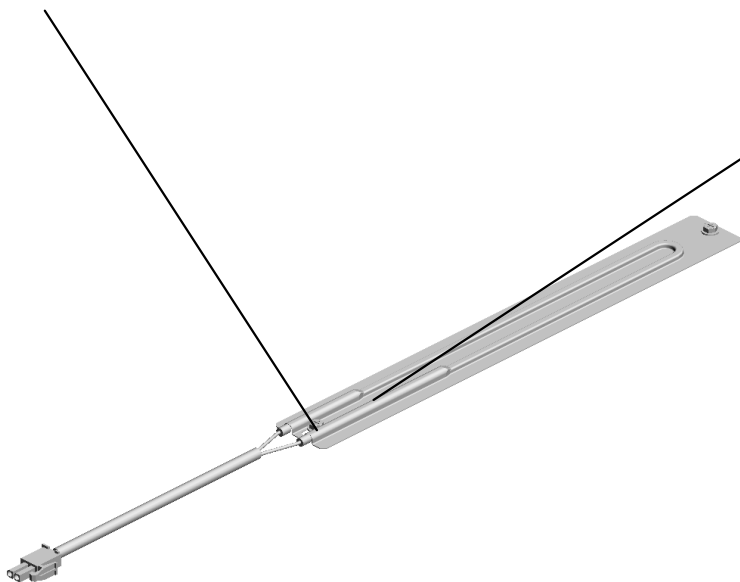

3-AX400250
[A]
HEATER:230V:9W:
THERMOFUSE:110
B&C
202404-01 O/O

B2291688
[A]
HEATER:OPTION:2
30V:9W
202404-01 O/O

U001	U002	U003	U004	U005	U006	U007	U008	U009	U010	U011	U012	U013	U014	U015	U016	U017	U018	U019	U020	U021
------	------	------	------	------	------	------	------	------	------	------	------	------	------	------	------	------	------	------	------	------

SPECIAL TOOLS



1.A1849501

ADJUSTING SCANNER PIN (4PCS/SET)

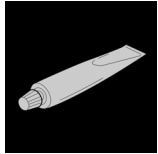

2.A2579300

GREASE - BARRIERTA S552R



3.B1329700

LUBRICANT POWDER

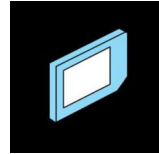

4.B6455010

SD-CARD:ASS'Y

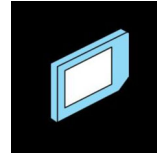

5.B6455020

SD-CARD:SERVICE:1GB:ASS'Y

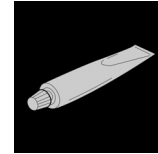

6.D0149800

GREASE : KS660



7.D0159500

G104 YELLOW TONER



8.D0159501

ZINC STEARATE

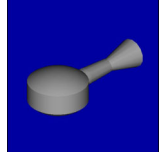

9.D0747690

BRUSH:BLOWER



10.D0749548

DG CLEANER 5PCS/SET

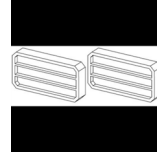

11.D0749549

JIG:OPC SET

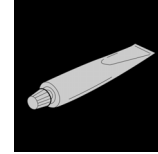

12.VSSG9002

FLUOTRIBO MG GREASE : 100G

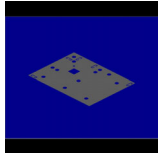

13.D1941761

SHEET:INDICATING HOLE ON A BOARD:NICE:GRAY:ASS'Y
201509-09

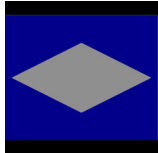

14.D1941764

SHEET:INDICATING HOLE ON A BOARD:NICE:BLACK:ASS'Y
201509-10

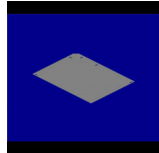

15.D1941766

COVER:NICE:BLACK
201509-11

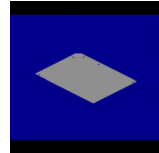

16.D1941767

COVER:NICE:WHITE
201509-12

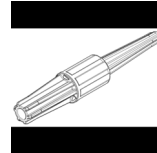

17.D1943396

JIG:SERVICE:DEVELOPMENT UNIT



19.G1785397

PCB:SIFB:CROSS



20.M0B15888

HARNESS:DEBUG:MONITOR:SERVICE
201911-01 O/O

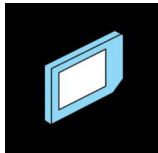

21.D0A57797

SD-CARD:SP: BATCH:TOOL:ASS'Y
202011-02

Exclusive Parts

Number	Part Name	Group	ID
50530223	BUSHING - 8MM	U006_S001	57
		U006_S002	57
		U006_S003	57
		U006_S004	57
50530447	BUSHING - 6MM	U006_S005	58
		U006_S006	58
		U006_S007	58
		U006_S008	58
52062684	SHOULDER SCREW - M3	U001	4
52062686	SNAP RING	U003_S001	26
		U009	30
		U011_S001	11
52152621	SNAP RING - M6	U003_S001	27
		U006	59
		U007	31
		U011_S001	12
53041639	BUSHING - 8MM	U015	30
54472681	SNAP RING	U001_S003	5
		U001_S004	5
		U001_S006	5
		U003_S001	28
		U003_S001_S004	28
		U006	60
		U007	32
		U007_S001	32
		U007_S004	32
		U007_S007	32
		U007_S010	32
		U007_S023	32
		U010_S001	5
		U013	44
		U013_S001	44
		U014	10
U016	37		
54472706	GEAR - 15T	U006_S018	61
		U006_S019	61
58942540	ARM SCREW	U015_S001	31
		U015_S002	31

Number	Part Name	Group	ID
		U015_S003	31
		U015_S004	31
67542866	ROLLER - POSITIONING GUIDE	U006	62
		U016	38
A1342978	SPRING PLATE	U006_S009_S002	63
A1849501	ADJUSTING SCANNER PIN (4PCS/SET)	SPECIAL TOOLS	1
A2324666	CUSHION - STEPPER MOTOR	U004	16
		U009	31
A2486687	RIGHT DRIVE SHAFT	U006_S001	64
		U006_S002	64
		U006_S003	64
		U006_S004	64
A2486694	WIRE RING	U006_S001	65
		U006_S002	65
		U006_S003	65
		U006_S004	65
A2486695	GUIDE - PULLEY	U006_S001	66
		U006_S002	66
		U006_S003	66
		U006_S004	66
A2486713	HOOK - TENSION SPRING	U006_S001	67
		U006_S002	67
		U006_S003	67
		U006_S004	67
A2501752	EXPOSURE GLASS	U004	17
A2574493	BAND	U013_S001	45
		U016	39
A2579300	GREASE - BARRIERTA S552R	SPECIAL TOOLS	2
A2672857	SPRING PLATE - SIDE FENCE	U006_S009_S001	68
A2672859	SIDE FENCE STOPPER	U006_S009_S001	69
A2943354	RACK - 10Z	U007_S013	160
		U007_S015	160
		U007_S017	160
		U007_S019	160
A2943447	TONER BOTTLE SET FEELER	U007_S013	33
		U007_S015	33
		U007_S017	33

Exclusive Parts

Number	Part Name	Group	ID
		U007_S019	33
A2943454	LEVER STOPPER	U007_S013	34
		U007_S015	34
		U007_S017	34
		U007_S019	34
A2946643	LEFT FRONT FENCE	U006_S005	70
		U006_S006	70
		U006_S007	70
		U006_S008	70
A2946655	FRONT ROLLER - SLIDE RAIL	U006_S001	71
		U006_S002	71
		U006_S003	71
		U006_S004	71
A2946690	FEELER - PAPER HEIGHT SENSOR	U006_S001	72
		U006_S002	72
		U006_S003	72
		U006_S004	72
A4181158	SPACER - M6.5X1	U003_S001_S004	29
A4221063	SEAL - 0.7X13X20	U003_S001	30
		U003_S001_S013	30
A5482139	PULLEY	U003_S001	31
A6281225	BUSHING - 8MM	U003_S001_S004	32
A8061163	GUIDE PLATE CUSHION	U003_S001_S004	33
		U003_S001_S004_S001	33
A8592112	DRIVE SHAFT - PAPER FEED BELT	U003_S001_S004	34
A8592319	BASE CUSHION	U003_S001_S004	35
A8597211	STEPPED SCREW	U003	36
AA000313	DECAL:CAUTION:INSERT:PAPER FEED SUB-UNIT	U006_S005_S001	361
		U006_S006_S001	361
		U006_S007_S001	361
		U006_S008_S001	361
AA001508	DECAL:SIDE FENCE:40X30	U006_S005_S001	73
		U006_S006_S001	73
		U006_S007_S001	73
		U006_S008_S001	73
AA001509	DECAL:SIDE FENCE:16X30	U006_S001_S004	74

Number	Part Name	Group	ID
		U006_S002_S004	74
		U006_S003_S004	74
		U006_S004_S004	74
AA001597	DECAL:SIDE FENCE:REAR	U006_S009_S001	75
AA021034	MAGNETIC	U016	40
AA036015	CAP:COLLECTION BOTTLE	U012_S007	15
AA040034	TRANSPORT BELT	U014_S001	11
AA043271	TIMING BELT S3M 196T	U006_S005	76
		U006_S006	76
		U006_S007	76
		U006_S008	76
AA043312	TIMING BELT:60S2M138	U013_S001	46
AA043325	TIMING BELT - B40S2M250	U016	41
AA043340	SYNCHRONOUS BELT:40S2M580	U018	28
AA043431	TIMING BELT:B40S2M320	U016	42
AA043432	TIMING BELT:B40S2M204	U016	43
AA043433	TIMING BELT:B40S2M456	U016	44
AA043604	TIMING BELT:B40S2M110	U016	45
AA043609	TIMING BELT:60S2M124	U013_S001	48
AA043610	SYNCHRONOUS BELT:DS3M558	U016	46
AA043621	TIMING BELT - 60S2M156	U013_S001	49
AA043623	TIMING BELT - B40S2M180	U017	10
AA043634	TIMING BELT - 40S2M296	U013_S001	50
AA043639	SYNCHRONOUS BELT:B60S2M192	U013_S001	52
AA043645	SYNCHRONOUS BELT:40S2M426	U018	30
AA043646	SYNCHRONOUS BELT:40S2M596	U018	31
AA043682	SYNCHRONOUS BELT:60S1.5M150	U003_S001	42
AA043683	SYNCHRONOUS BELT:60S1.5M204	U003_S001	43
AA043684	SYNCHRONOUS BELT:60S1.5M390	U003_S001	44
AA043698	SYNCHRONOUS BELT:40S1.5M300	U003_S001	47
AA043724	SYNCHRONOUS BELT:40S2M288	U018	124
AA043725	TIMING BELT:40S2M142	U009	238
AA043726	SYNCHRONOUS BELT:60S2M134	U013_S001	293
AA043727	SYNCHRONOUS BELT:80S2M190	U013_S001	292

Exclusive Parts

Number	Part Name	Group	ID
AA043731	TIMING BELT:40S2M184	U013_S001	289
AA043733	TIMING BELT:40S2M224	U013_S001	291
AA043737	TIMING BELT:60S2M188	U006	364
AA043989	SYNCHRONOUS BELT:60S2M194	U018_S008	32
		U018_S009	32
AA043998	SYNCHRONOUS BELT:60S2M190	U009	240
AA050116	DRIVE WERE:DRIVEN ROLLER	U009	33
AA060523	PICK-UP PRESSURE SPING	U006_S018	78
		U006_S019	78
AA060757	TENSION SPRING - LONG	U006_S001	79
		U006_S002	79
		U006_S003	79
		U006_S004	79
AA060758	TENSION SPRING - SHORT	U006_S001	80
		U006_S002	80
		U006_S003	80
		U006_S004	80
AA060811	TENSION SPRING - STOPPER	U007_S013	35
		U007_S015	35
		U007_S017	35
		U007_S019	35
AA060812	LEVER TENSION SPRING	U007_S013	36
		U007_S015	36
		U007_S017	36
		U007_S019	36
AA060842	TENSION SPRING	U003_S001	48
AA060961	TENSION SPRING:SIDE FENCE:REAR	U006_S009	81
AA060987	TENSION SPRING:TIMING BELT:10N	U006_S005	82
		U006_S006	82
		U006_S007	82
		U006_S008	82
AA061000	SPRING - 1.42N	U006_S018	83
		U006_S019	83
AA061001	RELEASE SPRING	U006_S018	84
		U006_S019	84
AA061065	TENSION SPRING:DUPLEX:DRIVE N ROLLER	U013_S001	53

Number	Part Name	Group	ID
AA061067	TENSION SPRING:DRIVE WERE:DRIVE	U009	34
AA061068	TENSION SPRING:BRACKET:DRIVEN ROLLER:INNER BACK	U009	35
AA061069	TENSION SPRING:BRACKET:DC STOPPER MOTOR	U009	36
AA061078	TENSION SPRING:PRESSURE ROLLER	U013_S001_S002	55
AA061097	TENSION SPRING:DC SOLENOID:ON-OFF:LARGE CAPACITY TRAY	U013_S001	56
AA061098	TENSION SPRING:DC SOLENOID:ON-OFF:MAIN	U013_S001	57
AA061109	TENSION SPRING:PRESSURE:TIMING ROLLER:TRANSFER	U013_S001	59
AA061110	TENSION SPRING:TIGHTENER:DRIVE UNIT:USED TONER	U018	33
AA061111	TENSION SPRING:MIDDLE:DRIVE:USED TONER	U018	34
AA061112	TENSION SPRING:TIGHTENER	U018	35
AA061114	TENSION SPRING:POSITIONING SENSOR	U009	37
AA061115	TENSION SPRING:0.4N	U015_S001	32
		U015_S002	32
		U015_S003	32
		U015_S004	32
AA061116	TENSION SPRING:STRIPPER PLATE:2N	U015_S001	33
		U015_S002	33
		U015_S003	33
		U015_S004	33
AA061117	TENSION SPRING:STRIPPER PLATE:PLATE	U015_S001	34
		U015_S002	34
		U015_S003	34
		U015_S004	34
AA061164	TENSION SPRING:GEAR:ON-OFF	U015_S001	35
		U015_S002	35
		U015_S003	35
		U015_S004	35
AA061199	TENSION SPRING:LEVER:PRESSURE	U015_S001	36

Exclusive Parts

Number	Part Name	Group	ID
	RE:30N	U015_S002	36
		U015_S003	36
		U015_S004	36
AA062319	SPRING	U016_S001	47
AA062352	TENSION SPRING:HEAT ROLLER	U015_S001	37
		U015_S002	37
		U015_S003	37
		U015_S004	37
AA063268	CONNECTOR SPRING	U006	85
AA063371	SPRING	U008_S001	16
		U008_S002	16
		U008_S003	16
		U008_S004	16
		U008_S005	16
AA063435	COMPRESSION SPRING:PAPER FEED:JOINT	U003_S001_S004	49
AA063463	COMPRESSION SPRING:DRAWER	U015	38
AA063465	COMPRESSION SPRING:CLEANING FELT:27N	U015_S005	39
AA063468	COMPRESSION SPRING:SHIFT	U013_S001	60
AA063471	COMPRESSION SPRING:PRESSURE:8N	U006	86
AA063484	COMPRESSION SPRING:ROLLER:POLISH:REAR	U015_S001	40
		U015_S002	40
		U015_S003	40
		U015_S004	40
AA063674	SPRING - 8N	U016	48
		U017	11
AA063675	SPRING - 5N	U016	49
AA063678	SPRING - 3.5N	U013_S001	61
AA063680	PRESSURE SPRING - 5X10.5	U016_S002	50
AA063693	COMPRESSION SPRING:PRESSURE:DRIVEN ROLLER	U006	87
		U006_S018	87
		U006_S019	87
AA063694	COMPRESSION SPRING:HANDLE	U006	88
AA063695	COMPRESSION SPRING:GRIP	U006	89
AA063724	COMPRESSION SPRING:ROLLER:POLISH	U015_S001	41
		U015_S002	41

Number	Part Name	Group	ID
		U015_S003	41
		U015_S004	41
AA063725	COMPRESSION SPRING:CONNECTOR:DRAWER:UPPER	U013	62
AA064004	COMPRESSION SPRING:PRESSURE:375N	U015_S001	42
		U015_S002	42
		U015_S003	42
		U015_S004	42
AA066320	FEELER TORSION SPRING	U007_S013	37
		U007_S015	37
		U007_S017	37
		U007_S019	37
AA066397	TORSION SPRING:WEB:MECHANICAL DRIVE SECTION	U015	43
AA066400	COIL SPRING:PAWL:OPEN AND CLOSE	U013_S001	63
AA066401	TORSION SPRING:FEELER	U015_S005	44
AA066402	TORSION SPRING:GUIDE PLATE:REAR	U013_S001	64
AA066428	TORSION SPRING:GUIDE PLATE:FRONT	U013_S001	288
AA066686	TORSION SPRING:LOCK:SEPARATION:FRONT:15N	U015_S001	45
		U015_S002	45
		U015_S003	45
		U015_S004	45
AA066687	TORSION SPRING:LOCK:SEPARATION:REAR:15N	U015_S001	46
		U015_S002	46
		U015_S003	46
		U015_S004	46
AA066689	TORSION SPRING:DUCT:FRONT	U015_S001	47
		U015_S002	47
		U015_S003	47
		U015_S004	47
AA066690	TORSION SPRING:DUCT:REAR	U015_S001	48
		U015_S002	48
		U015_S003	48
		U015_S004	48
AA066691	TORSION SPRING:GRIP	U015_S001	49

Exclusive Parts

Number	Part Name	Group	ID
		U015_S002	49
		U015_S003	49
		U015_S004	49
AA080154	REAR BUSHING	U011_S001	13
AA080240	BUSHING - MM5	U016_S002	51
AA080247	BUSHING - B-F6-3	U012_S003	16
		U015_S001	50
		U015_S002	50
		U015_S003	50
		U015_S004	50
AA080265	BUSHING:6X8X5	U006	90
AA080346	BUSHING:FLANGE TYPE:DIA6	U003_S001	50
		U006	91
		U013_S001	66
		U016	52
AA080347	BUSHING - 8MM	U003_S001	51
AA080354	BUSHING - 6MM	U015_S005	51
AA080355	BUSHING - 7MM	U015_S005	52
AA080356	BUSHING - 6MM	U015_S005	53
AA082101	BUSHING - 6X10X6	U003_S001	52
		U003_S001_S001	52
		U003_S001_S004	52
		U007	38
		U007_S001	38
		U007_S004	38
		U007_S007	38
		U007_S010	38
		U007_S013	38
		U007_S015	38
		U007_S017	38
		U007_S019	38
		U007_S023	38
		U007_S025	38
		U011_S001	14
		U013_S001	67
		U015_S001	54
		U015_S002	54
		U015_S003	54

Number	Part Name	Group	ID
		U015_S004	54
		U016	53
AA082104	BUSHING - 8X12X7	U003_S001_S006	53
		U013_S001	68
		U013_S001_S002	68
		U016	54
AA082137	BUSHING:6X10X6	U010_S001	6
		U011_S001	15
AA082144	BUSHING - 8X12X7	U003_S001	54
		U007	39
		U009	38
AA082173	PLAIN SHAFT BEARING:6X10X6	U014	12
AA083009	CLUTCH ROLLER - 8X18X11	U006_S018	92
		U006_S019	92
AA083022	BUSHING:DIA6:DIA8	U009	39
		U010_S001	7
AA084059	BALL BEARING HOLDER	U006	93
		U006_S018	93
		U006_S019	93
		U013_S001	69
		U016	55
		U017	12
AA113037	TERMINAL:4P:187	U015_S001	55
		U015_S002	55
		U015_S003	55
		U015_S004	55
AA120084	DISCHARGE BRUSH	U016	56
AA120097	ANTISTATIC BRUSH	U016	57
AA120127	DISCHARGE BRUSH:FUSING	U016_S001	58
AA120145	DISCHARGE BRUSH:REVERSE:17MM	U016	59
AA132013	SPACER	U003_S001_S004	55
AA132203	SPACER - 6MM	U006	94
		U006_S001	94
		U006_S002	94
		U006_S003	94
		U006_S004	94
AA132300	ROLLER:LOCK:PULL OUT	U013_S001	70

Exclusive Parts

Number	Part Name	Group	ID
		U016	60
AA140686	SHAFT - TIMING PULLEY	U006_S005	95
		U006_S006	95
		U006_S007	95
		U006_S008	95
AA140912	SCREW - 8X14X2.8	U006	96
AA140937	SHAFT:GRIP:LOWER	U006	97
AA143313	STEPPED SCREW - M5X7	U002	19
AA143444	STEPPED SCREW	U016	61
AA143520	SHOULDER SCREW - M3	U015_S001	56
		U015_S001_S003	56
		U015_S002	56
		U015_S002_S003	56
		U015_S003	56
		U015_S003_S003	56
		U015_S004	56
		U015_S004_S003	56
		U015_S005	56
AA143544	SCREW - M3	U007	40
		U007_S023	40
		U021	26
AA143550	SCREW:DIA4:M3	U006	98
AA143562	SCREW:M4:DIA6X1.2	U007_S013	41
		U007_S015	41
		U007_S017	41
		U007_S019	41
AA143569	SCREW	U006	99
AA143585	SHAFT:MISFEED REMOVAL:UPPER	U006	100
AA143586	SHAFT:MISFEED REMOVAL:LOWER	U006	101
AA143587	SHAFT:MISFEED REMOVAL:VERTICAL TRANSPORT	U006	102
AA143645	STEPPED SCREW:M3:45MM	U020	26
		U021	27
AA143718	STEPPED SCREW - M4	U006	103
AA143744	STEPPED SCREW	U009	40
AA143788	PIN:GUIDE PLATE:PAPER FEED	U003_S001	56

Number	Part Name	Group	ID
AA143789	SHAFT:CLEANER	U003_S001	57
AA143791	SCREW:SAFETY	U003_S001	58
AA143797	CONNECTOR GUIDE PIN	U006	360
		U013	71
AA143811	STEPPED SCREW - M3X4	U013_S001	72
		U016	63
AA143828	SCREW:FLY WHEEL	U007	42
AA143842	SCREW:DIA6:14.5:M4	U003_S001	59
AA143846	TAPPING SCREW:M3X6	U003_S001_S013	60
AA143847	STEPPED SCREW:DIA5:3.5:M3	U015_S001	57
		U015_S002	57
		U015_S003	57
		U015_S004	57
AA143848	STEPPED SCREW - M3	U020_S007	27
AA143872	SCREW:DIA6:M4	U006	104
AA143883	SHAFT:STOPPER:PAPER TRAY	U006	105
AA143884	STEPPED SCREW:DIA5.4:DIA3.5:M3:LONG	U013	73
AA143885	STEPPED SCREW:M3	U015_S001	58
		U015_S002	58
		U015_S003	58
		U015_S004	58
AA148776	SHAFT:DRIVE	U006	106
AA148777	SHAFT:ARM:LINK	U006	107
AA148778	SHAFT:ARM:PLATE	U006	108
AA161104	CUSHION - MOTOR	U004	18
		U021	28
AA161122	MOTOR CUSHION	U006	109
		U013_S001	74
		U016	64
AA161125	RUBBER CUSHION	U020_S007	28
AA161157	BRACKET CUSHION	U013_S001	75
AA161172	CUSHION:GUIDE PLATE	U006	112
AA161177	CUSHION:BASE:TANDEM LCT:LARGE	U006_S001	367
		U006_S002	367
		U006_S003	367
		U006_S004	367
AA161178	CUSHION:BASE:TANDEM LCT:SM	U006_S001	368

Exclusive Parts

Number	Part Name	Group	ID
	ALL	U006_S002	368
		U006_S003	368
		U006_S004	368
AB010173	GEAR - 60Z	U015_S005	59
AB010174	GEAR - 20Z/50Z	U015_S005	60
AB010175	GEAR - 24Z	U015_S005	61
AB010176	GEAR - 24Z	U015_S005	62
AB010177	GEAR - 32Z	U015_S005	63
AB010178	WORM GEAR	U015_S005	64
AB010215	GEAR:DRIVE:155Z	U018_S003	36
AB011125	GEAR:20/29Z	U011_S001	16
AB011126	GEAR:20Z	U011_S001	17
AB011392	DRIVE REVERSE GEAR - 24Z	U006_S018	113
		U006_S019	113
AB011463	(D203/D204):CONNECTING GEAR	U007_S023	43
AB011523	GEAR - 24Z	U015	65
AB011524	GEAR - 36Z	U015	66
AB011526	GEAR - 24Z	U015	67
AB011550	GEAR:DRIVE UNIT:USED TONER:35Z	U018	37
AB011551	GEAR:DRIVE:EXIT:47Z	U018_S001	38
AB011591	GEAR:REVERSE	U006_S018	114
		U006_S019	114
AB012005	GEAR - 13Z	U007	44
AB012007	(D203/D204):GEAR - 14Z	U007_S025	45
AB012008	(D203/D204):GEAR - 23Z	U007_S025	46
AB012203	GEAR:DRIVE:ROLLER:FUSING:B	U015_S001	68
		U015_S002	68
		U015_S003	68
		U015_S004	68
		U015_S006	68
AB012205	GEAR:IDLER:ON-OFF	U015_S001	69
		U015_S002	69
		U015_S003	69
		U015_S004	69
AB012207	GEAR:POLISH:ROLLER:A	U015_S006	70
AB012214	GEAR:POLISH:ROLLER:A	U015_S001	71
		U015_S002	71

Number	Part Name	Group	ID
		U015_S003	71
		U015_S004	71
AB012327	GEAR:16Z	U006_S009	115
AB013421	GEAR - 18Z	U016	65
AB013765	GEAR:DRIVE:USED TONER:36Z	U018	39
AB013781	GEAR - 30Z	U006_S001	116
		U006_S002	116
		U006_S003	116
		U006_S004	116
AB013798	GEAR - Z18	U006_S005	117
		U006_S006	117
		U006_S007	117
		U006_S008	117
AB014287	GEAR:IDLER:FUSING	U015_S001	72
		U015_S002	72
		U015_S003	72
		U015_S004	72
AB017515	DOUBLE GEAR - 12/23Z	U007_S013	47
		U007_S015	47
		U007_S017	47
		U007_S019	47
AB017725	GEAR/TIMING PULLEY - 20Z/20T	U006	118
AB017726	GEAR/TIMING PULLEY - 20Z/20T	U006	119
AB017771	GEAR:TRANSPORT ROLLER:INPUT:Z23/Z28	U006_S018	120
		U006_S019	120
AB017815	GEAR:Z24:Z41	U018	40
AB017820	GEAR:DRIVE:101Z/52Z	U018	41
AB017857	GEAR:PULLEY:DEVELOPMENT DRIVE UNIT:65Z/30T	U018_S008	42
		U018_S009	42
		U018_S010	42
		U018_S011	42
		U018_S012	42
AB017858	GEAR:64Z/51Z	U018_S008	43
		U018_S009	43
		U018_S010	43
		U018_S011	43
		U018_S012	43
AB017859	GEAR:Z17:Z61	U018	44

Exclusive Parts

Number	Part Name	Group	ID
AB017860	(D203/D204):GEAR:DRIVE:Z61:Z18	U018	45
AB017880	GEAR:IDLER:DRIVE:EXIT:Z101/42	U018	46
AB017881	GEAR:PULLEY:DRIVE:USED TONE R:44Z/32T	U018	47
AB017882	GEAR:DRIVE UNIT:USED TONER:4 8Z/24Z	U018	48
AB017883	GEAR:IDLER:DRIVE UNIT:USED T ONER:77Z/23Z	U018	49
AB017884	GEAR:PULLEY:DRIVE UNIT:USED TONER:36Z/32T	U018	50
AB019475	GEAR - 48T	U006_S005	121
		U006_S006	121
		U006_S007	121
		U006_S008	121
AB030081	PULLEY - 20Z	U016	66
AB030805	PULLEY:COUPLING:30T	U016	67
AB030808	TIMING PULLEY - 20T	U016	68
AB030838	TIMING PULLEY:DRIVE:FLAT CON VEYER BELT	U018	51
AB030840	TIMING PULLEY:S2M:26T/40T	U018	52
AB030841	TIMING PULLEY:OUTPUT:VACUU M:S2M:32T	U018	53
AB030842	TIMING PULLEY:S2M:30T	U016	69
AB030844	TIMING PULLEY:T19:S3M	U016_S001	70
AB030845	TIMING PULLEY:T20:S3M	U016_S001	71
AB030846	TIMING PULLEY:S2M:22T	U013_S001	76
AB030850	PULLEY:TIGHTENER:DRIVE:USED TONER	U018	54
AB030851	PULLEY:DRIVE:USED TONER:25T	U018	55
AB030852	PULLEY:IDLER:DRIVE:USED TONE R:32T	U018	56
AB032058	WIRE PULLEY - M10	U006_S001	122
		U006_S002	122
		U006_S003	122
		U006_S004	122
AB032072	PULLEY:DRIVEN:WIRE	U009	41
AB032719	PULLEY - M10	U006_S001	123
		U006_S002	123

Number	Part Name	Group	ID
		U006_S003	123
		U006_S004	123
AB032721	PULLEY - M18	U016	72
AB033084	TIMING PULLEY - 15T	U006_S005	124
		U006_S006	124
		U006_S007	124
		U006_S008	124
AB033085	TIMING PULLEY - 15T	U006_S005	125
		U006_S006	125
		U006_S007	125
		U006_S008	125
AC030211	MIRROR:NO.1	U004_S002	19
AE010122	HOT ROLLER:DIA54	U015_S001	73
		U015_S002	73
		U015_S003	73
		U015_S004	73
AE012044	HEAT ROLLER:DIA40	U015_S001	74
		U015_S002	74
		U015_S003	74
		U015_S004	74
AE020229	PRESSURE ROLLER:DIA65	U015_S001	75
		U015_S002	75
		U015_S003	75
		U015_S004	75
AE030044	BALL BEARING - 10X22X6	U015_S001	76
		U015_S002	76
		U015_S003	76
		U015_S004	76
AE030049	BALL BEARING -20X32X7	U015_S001	77
		U015_S002	77
		U015_S003	77
		U015_S004	77
AE030086	RADIAL BALL BEARING:DIA25XDIA 37X7	U015_S001	78
		U015_S002	78
		U015_S003	78
		U015_S004	78
AE031075	PLAIN SHAFT BEARING:DIA4:MEC HANICAL ROLLER CLUTCH	U015_S005	242

Exclusive Parts

Number	Part Name	Group	ID
AE031076	BUSHING:DIA4	U015_S005	157
AE032034	THERMAL INSULATING BUSHING: DIA22	U015_S001	79
		U015_S002	79
		U015_S003	79
		U015_S004	79
AE045064	WEB:SUB-ASS'Y	U015_S005	80
AF017033	END FENCE	U006_S009	126
AF020740	TRANSPORT ROLLER:VERTICAL T RANSPORT:DRIVE	U006	127
AF020741	TRANSPORT ROLLER:GRIP:DRIVE	U006	128
AF020743	TRANSPORT ROLLER:DRIVE:PAP ER FEED UNIT	U006_S018	129
		U006_S019	129
AF020744	TRANSPORT ROLLER:DRIVEN:PA PER FEED UNIT	U006_S018	130
		U006_S019	130
AF020786	TRANSPORT ROLLER:EXIT:PAPE R BANK:DRIVE	U006	131
AF022064	TRANSPORT ROLLER:DRIVEN	U014_S001	13
AF022067	GUIDE STOPPER ROLLER	U013_S001	77
		U016	73
AF022105	ROLLER - SLIDE RAIL	U006_S001	132
		U006_S002	132
		U006_S003	132
		U006_S004	132
AF022165	TRANSPORT ROLLER - DRIVEN	U006	133
AF022167	TRANSPORT ROLLER - DRIVEN	U013_S001	78
AF022178	TRANSPORT ROLLER:DRIVEN:DIA 17.7X2:INNER	U013_S001	79
AF030173	PAPER FEED ROLLER:PICKUP	U006_S018	375
		U006_S019	375
AF031080	PAPER FEED ROLLER:FEED	U006_S018	135
		U006_S019	135
AF032080	PAPER FEED ROLLER:SEPARATE	U006_S018	136
		U006_S019	136
AG050100	KNOB - TRANSPORT ROLLER	U006	137
		U013_S001	80
		U016	74
AG050101	KNOB - MISFEED REMOVAL	U006	138
AG051141	RELEASE LEVER	U013_S001	81

Number	Part Name	Group	ID
AG070512	MAGNET CATCH:ASS'Y	U001	6
AG070513	MAGNET CATCH	U013_S001	82
AG070514	MAGNET CATCH	U001	7
		U016_S002	75
AG071012	MAGNET CATCH:ASS'Y	U012	17
AG071013	MAGNET CATCH:24.5N:ASS'Y	U001_S004	8
		U001_S006	8
AH012031	CASTER:1470N	U022	22
AW000012	OPTICS SENSOR:PHOTO	U013_S001	83
AW010113	SENSOR	U006_S001	139
		U006_S002	139
		U006_S003	139
		U006_S004	139
AW010134	ORIGINAL SENSOR - 48MM	U004	20
AW010143	PHOTO REFIECTION SENSOR:PS R11TL1R-C	U017	13
AW010147	PHOTO REFLECTION SENSOR	U015_S001	81
		U015_S002	81
		U015_S003	81
		U015_S004	81
AW010150	PHOTO REFIECTION SENSOR:ORI GINAL TRAY	U003_S001	61
AW010151	PHOTO REFIECTION SENSOR:PS1 22TL1-A	U003_S001	62
AW010200	PAPER FEED SENSOR:FUSING EX IT	U015	82
		U015_S001	82
		U015_S002	82
		U015_S003	82
AW020145	PHOTOINTERRUPTOR:FLAT	U015_S004	82
		U006_S001	140
		U006_S002	140
		U006_S003	140
		U006_S004	140
		U006_S005	140
		U006_S006	140
		U006_S007	140
AW020163	PAPER FEED SENSOR	U006_S008	140
		U006_S005	141

Exclusive Parts

Number	Part Name	Group	ID
		U006_S006	141
		U006_S007	141
		U006_S008	141
AW020164	OIL END SENSOR	U012	18
AW020198	PHOTOINTERRUPTOR:LG2A14NL 1	U004	21
		U007	48
		U007_S013	48
		U007_S015	48
		U007_S017	48
		U007_S019	48
		U007_S024	48
		U009	42
		U012	19
		U013_S001	84
		U015	83
		U015_S001	83
		U015_S002	83
		U015_S003	83
		U015_S004	83
		U018	57
		U018_S008	57
		U018_S009	57
		U018_S010	57
		U018_S011	57
		U018_S012	57
AW020217	OPTICS SENSOR:ENCODER:300L PI	U009	43
		U013_S001	85
		U018	58
AW020218	POSITIONING SENSOR:FLAT BELT -TRANSFER	U009	44
AW020219	PHOTOINTERRUPTOR:ACTUATOR :29.2MM	U009	45
AW020234	PHOTOINTERRUPTOR:GP1A173L CS5F	U003_S001	273
AW020249	PHOTOINTERRUPTOR:FLAT:PICH 2MM:M4	U022	65
AW100107	THERMISTOR	U021	29
AW100138	THERMOPILE	U021	30

Number	Part Name	Group	ID
AW100165	THERMISTOR:ASS'Y	U016	76
AW110052	THERMOSTAT:211C	U015_S001	84
		U015_S002	84
		U015_S003	84
		U015_S004	84
AW110122	THERMOSTAT:225C:250V/17A	U015_S001	85
		U015_S002	85
		U015_S003	85
		U015_S004	85
AW140015	TEMPERATURE & HUMIDITY SEN SOR	U008	17
		U022	24
AW500010	PUSH SWITCH	U006	143
AW500023	PUSH SWITCH	U006	144
		U008	18
		U009	46
		U012	20
AX040145	DC MOTOR:TANDEM LCT	U006_S005	145
		U006_S006	145
		U006_S007	145
		U006_S008	145
AX040157	STEPPER MOTOR DC1.68V 6.7W	U006	146
		U013_S001	86
		U016	77
AX040181	DC STEPPER MOTOR:SHIFT:MM5 6:3.4W	U013_S001	87
AX040254	DC MOTOR:RISING TRAY:ASS'Y:1. 007W:BRUSH	U003_S001_S005	65
		U006_S014	147
AX060376	BRUSHLESS MOTOR:DEVELOPME NT:COLOR	U007	49
AX060393	DC STEPPER MOTOR:MM42:1.3A: 4.42V	U009	47
AX060394	DC STEPPER MOTOR:MM42:1.2A: 3.60V	U009	48
AX060453	DC MOTOR:DIA55:40W:BRUSHLES S	U018	59
AX060458	DC MOTOR:DIA56:16.5W:BRUSHL ESS	U009	49
AX060459	DC MOTOR:DIA63:24V:24.4W:BRU	U018_S008	60

Exclusive Parts

Number	Part Name	Group	ID
	SHLESS	U018_S009	60
		U018_S010	60
		U018_S011	60
		U018_S012	60
AX060462	DC MOTOR:DIA73:56W:BRUSHLESS	U018	62
AX060463	DC MOTOR:DIA56:14.7W:BRUSHLESS	U018_S008	63
		U018_S009	63
		U018_S010	63
		U018_S011	63
		U018_S012	63
AX060510	DRIVE SUB-UNIT:ON-OFF:PRESSURE ROLLER	U018	61
AX061315	DC MOTOR:DIA65:24V:23.5W	U018	64
AX061316	DC MOTOR:DIA63:27.7W:BRUSHLESS	U018	65
AX061318	(D203/D204):DC STEPPER MOTOR:MM42:1.35A	U018	125
AX200323	ELECTROMAGNETIC CLUTCH:025NM:Z31:DIA6	U007_S001	50
		U007_S004	50
		U007_S007	50
		U007_S010	50
		U007_S023	50
AX400178	HEATER:240V:18W:UPPER	U006_S011	148
AX400250	HEATER:230V:9W:THERMOFUSE:10B C	U024	3
AX400275	HEATER:230V:9W	U009	242
AX440395	(-NA):HEATER:PRESSURE ROLLER:208V:800W:INFRARED	U015_S004	86
AX440396	(-AA,-EU,-CHN):HEATER:PRESSURE ROLLER:220V:800W:INFRARED	U015_S001	87
		U015_S002	87
		U015_S003	87
AX450066	(-NA):HEATER:HEAT ROLLER:205V:997WX3:INFRARED	U015_S004	88
AX450067	(-AA,-EU,-CHN):HEATER:HEAT ROLLER:227V:1070WX3:INFRARED	U015_S001	89
		U015_S002	89
		U015_S003	89
AX560011	LED	U013_S001	88

Number	Part Name	Group	ID
AX640199	FAN:MM80:25MM:DC 2.16W	U019	31
		U020	29
AX640207	FAN:MM60	U014_S001	14
AX640219	DC FAN MOTOR:DC24V:MM60:25MM	U021	31
AX640221	FAN:SIROCCO:DC24V:50MM	U021	32
AX640229	DC FAN MOTOR:DC24V:MM120:25MM	U020_S004	30
AX640330	FAN:SIROCCO:DIA51	U021	33
AX660014	DC FAN MOTOR:DIA97X38:DC24V:PWM:38.88W	U021	34
AX660015	DC FAN MOTOR:SIROCCO:DC24V:PWM	U020	31
		U021	35
AX660016	DC FAN MOTOR:MM60X38:DC24V:PWM:18W	U016	78
AX660028	DC FAN MOTOR:MM80X38:DC24:PWM:7.2W	U020	32
		U021	37
AX660621	DC FAN MOTOR:DC24V:MM120:38MM:PWM CONTROL	U020	33
AX660905	DC FAN MOTOR:DC24V:MM120:PWM CONTROL:18W	U020	119
AZ240224	DC POWER SUPPLY:450.3W	U019	32
AZ240299	DC POWER SUPPLY	U020	126
AZ240373	POWER SUPPLY UNIT:ECO:200V	U020_S006	128
AZ300065	POWER PACK	U009	51
AZ300066	POWER PACK	U009	52
AZ310032	POWER PACK:D	U013_S001	89
AZ310037	POWER PACK:CHARGE	U019	33
AZ310038	POWER PACK:DEVELOPMENT	U019	34
AZ310039	POWER PACK:TRANSFER:1500PF	U009	53
B0042995	CAP - POSITIONING	U006	149
B0044438	BUSHING	U007_S014	51
		U007_S016	51
		U007_S018	51
		U007_S020	51
		U020	36
B0391367	RIVET - M6	U020	36
B0434645	SPRING - 2N	U003_S001	66
B0651374	CLOTH - DF EXPOSURE GLASS	U023	10

Exclusive Parts

Number	Part Name	Group	ID
B0656118	GUIDE PLATE:HEAT SINK:UPPER: FIBER	U006_S011	150
B0656136	TRAY LOCK ARM	U006	151
B0656345	PAPER END SENSOR BRACKET	U006_S018	152
		U006_S019	152
B0656524	BOTTOM PLATE LIFT SHAFT	U006_S009	153
B0656526	LIFT LEVER	U006_S009	154
B0656545	DECAL - POSITIONING	U006_S009	155
B0656591	PAPER TRAY HOLDER BASE	U006	156
B0656717	PAPER VOLUME SHIELD PLATE	U006_S001	157
		U006_S002	157
		U006_S003	157
		U006_S004	157
B0656769	LOCK ARM	U006	158
B0656823	TIMING BELT COVER	U006_S005	159
		U006_S006	159
		U006_S007	159
		U006_S008	159
B0656830	PULLEY BRACKET	U006_S005	160
		U006_S006	160
		U006_S007	160
		U006_S008	160
B0656831	SENSOR BRACKET	U006_S005	161
		U006_S006	161
		U006_S007	161
		U006_S008	161
B0656862	LARGE LEVER	U006_S001	162
		U006_S002	162
		U006_S003	162
		U006_S004	162
B0656864	SMALL LEVER	U006_S001	163
		U006_S002	163
		U006_S003	163
		U006_S004	163
B0656870	STAY -RIGHTBASE	U006_S001	164
		U006_S002	164
		U006_S003	164
		U006_S004	164

Number	Part Name	Group	ID
B0656872	OIL DAMPER BRACKET	U006_S001	165
		U006_S002	165
		U006_S003	165
		U006_S004	165
B0656875	PROTECTION -INNER COVER	U006_S001	166
		U006_S002	166
		U006_S003	166
		U006_S004	166
B0706667	END FENCE COVER FRONT	U006_S001	167
		U006_S002	167
		U006_S003	167
		U006_S004	167
B0706683	LEVER:RELEASE:FRONT	U006_S001	168
		U006_S002	168
		U006_S003	168
		U006_S004	168
B0706684	LEVER:RELEASE:REAR	U006_S001	169
		U006_S002	169
		U006_S003	169
		U006_S004	169
B1041303	HINGE SHAFT	U001	9
B1321183	BRACKET:LOCK	U013_S001	91
		U016	80
B1321221	HOLDER:SPRING:PULL OUT	U013_S001	92
		U016	81
B1322264	BUSHING:TERMINAL	U010_S001	8
B1322366	LEVER:DRUM STAY:LEFT	U013_S001	93
		U020	37
B1323223	GEAR:21/32Z	U007	52
B1323373	(D203/D204):GEAR:TRANSPORT S CREW:SUPPLY:LOWER	U007_S023	53
B1324168	GRIP:OIL APPLICATION UNIT	U015_S001	90
		U015_S002	90
		U015_S003	90
		U015_S004	90
B1324197	TORSION SPRING:LEVER	U015_S001	91
		U015_S002	91
		U015_S003	91

Exclusive Parts

Number	Part Name	Group	ID
		U015_S004	91
B1324313	PRESSURE SPRING HOLDER	U015_S001	92
		U015_S002	92
		U015_S003	92
		U015_S004	92
B1325996	DECAL:TOTAL COUNTER	U006	362
		U017	14
B1326114	CAM:ON-OFF:BLACK	U009	54
B1326726	BRACKET:ARM:ASS'Y	U006	170
B1326738	BRACKET:LIFT MOTOR:TANDEM LCT	U006	171
B1326762	DC SOLENOID:COUPLING:ASS'Y	U006_S013	172
B1326764	BRACKET:CONNECTOR:RIGHT	U006	174
B1326791	PLATE:SIDE FENCE	U006_S009_S002	175
B1326797	SIDE FENCE:REAR:AUXILIARY	U006_S009	176
B1326798	SPRING PLATE:PAPER TRAY:EAR TH	U006_S009	177
B1327541	TRAY BOTTOM PLATE:LEFT REAR	U006_S005	178
		U006_S006	178
		U006_S007	178
		U006_S008	178
B1327547	DC SOLENOID:END FENCE:FRONT:ASS'Y	U006_S001_S001	179
		U006_S002_S001	179
		U006_S003_S001	179
		U006_S004_S001	179
B1327550	COVER:PULLEY:DRIVE WERE	U006_S001	180
		U006_S002	180
		U006_S003	180
		U006_S004	180
B1327561	BACK FENCE:LEFT	U006_S005	181
		U006_S006	181
		U006_S007	181
		U006_S008	181
B1327564	SLIDER:BACK FENCE:LEFT	U006_S005	182
		U006_S006	182
		U006_S007	182
		U006_S008	182
B1327571	DC SOLENOID:END FENCE:REAR:	U006_S001_S002	183

Number	Part Name	Group	ID
	ASS'Y	U006_S002_S002	183
		U006_S003_S002	183
		U006_S004_S002	183
B1327575	BRACKET:CONNECTOR:TANDEM LCT	U006_S001	184
		U006_S002	184
		U006_S003	184
		U006_S004	184
B1327591	RAIL:PAPER TRAY:ASS'Y	U006	185
B1329700	LUBRICANT POWDER	SPECIAL TOOLS	3
B1816780	LINK:END FENCE:PAPER SIZE SENSOR:ASS'Y	U006_S009	186
B1816789	LINK:SIDE FENCE:PAPER SIZE SENSOR	U006_S009	187
B2233485	(D203/D204):SEAL:HOLDER:STOP PER:SHUTTER:1	U007_S024	54
B2234317	STEPPER MOTOR:DC24V 24.3W	U015	93
B2236171	RUBBER BUSHING:ENCODER	U009	55
		U013_S001	94
		U018	67
B2341293	LEVER - SAFETY SWITCH	U001_S003	10
		U001_S004	10
		U001_S006	10
B2342390	FLANGED HEXAGONAL HEAD BOLT:M4X8	U007	55
		U008	19
		U009	56
		U010	9
		U011	18
		U013_S001	95
B2342399	BOLT - M3X6	U009	219
B2342624	BALL BEARING - 8X12X5	U006_S018	188
		U006_S019	188
B2342864	PAD:CLEANER	U006_S009_S001	189
		U006_S009_S002	189
B2343356	JOINT:CHUCK:TONER BOTTLE	U007_S013	157
		U007_S015	157
		U007_S017	157
		U007_S019	157

Exclusive Parts

Number	Part Name	Group	ID
B2344460	DISCHARGE BRUSH - L=341 SUS	U016_S001	83
B2344858	DRIVEN ROLLER HOLDER	U013_S001	96
B2346120	BRACKET:POSITIONING:PAPER TRAY	U006	190
B2346138	RAIL - TANDEM LCT	U006	191
B2346141	POSITIONING SLEEVE - INNER BACK	U006	192
		U006_S001	192
		U006_S002	192
		U006_S003	192
		U006_S004	192
B2346188	SLIDE SLEEVE POSITIONING	U006	193
B2346222	REVERSE DRIVE SHAFT	U006_S018	194
		U006_S019	194
B2346223	DRIVEN REVERSE SHAFT	U006_S018	195
		U006_S019	195
B2346233	DC SOLENOID:REVERSE:SUB-ASSY	U006_S018	196
		U006_S019	196
B2346242	GUIDE - ROLLER:DRIVEN PRESSURE	U006_S018	197
		U006_S019	197
B2346275	PICKUP ARM	U006_S018	198
		U006_S019	198
B2346282	PICKUP DC SOLENOID	U006_S018_S002	199
		U006_S019_S002	199
B2346288	BSENSOR BRACKET - SENSOR	U006_S018	200
		U006_S019	200
B2346301	TORQUE LIMITER:75MN M	U006_S018	201
		U006_S019	201
B2346424	RELEASE GRIP	U013_S001	97
		U016	84
		U016_S002	84
B2346495	GUIDE:FRONT:PAPER TRAY	U006	202
B2346497	GUIDE:REAR:PAPER TRAY	U006	203
B2346498	SHEET:TRAY BOTTOM PLATE	U006_S009	204
B2346506	TIMING PULLEY - 30T	U006	205
B2346508	TENSION SPRING	U006	206
B2346514	TIMING BELT - S2M126	U006	207
B2346530	BRACKET	U006	208
B2346531	TIGHTENER BRACKET	U006	209

Number	Part Name	Group	ID
B2346532	TIGHTENER BRACKET	U006	210
B2346533	TIMING BELT - S2M152	U006	211
B2346542	GRIP DRIVE SHAFT	U006	213
B2346606	SENSOR BRACKET	U006_S001	214
		U006_S002	214
		U006_S003	214
		U006_S004	214
B2346612	END FENCE - FRONT	U006_S001	215
		U006_S002	215
		U006_S003	215
		U006_S004	215
B2346625	END FENCE - REAR	U006_S001	216
		U006_S002	216
		U006_S003	216
		U006_S004	216
B2346630	(-AA,-EU,-CHN):GUIDE PLATE - END FENCE	U006_S001	217
		U006_S002	217
		U006_S004	217
B2346686	SIDE FENCE - RIGHT FRONT	U006_S001_S003	218
		U006_S002_S003	218
		U006_S003_S003	218
		U006_S004_S003	218
B2346691	SIDE FENCE:TANDEM LCT:RIGHT:ASS'Y	U006_S001_S004	219
		U006_S002_S004	219
		U006_S003_S004	219
		U006_S004_S004	219
B2347540	TRAY BOTTOM PLATE:LEFT FRONT	U006_S005	220
		U006_S006	220
		U006_S007	220
		U006_S008	220
B2476695	GUIDE:MISFEED REMOVAL:PAPER TRAY	U006_S001	221
		U006_S002	221
		U006_S003	221
		U006_S004	221
		U006_S009	221
B2476753	LOCK SPRING - LARGE	U006	222
B2476754	LOCK SPRING - SMALL	U006	223
B2476901	OIL DAMPER:FALL	U006_S001	224

Exclusive Parts

Number	Part Name	Group	ID
		U006_S002	224
		U006_S003	224
		U006_S004	224
B2476950	SHAFT:SLIDER:BACK FENCE	U006_S005	225
		U006_S006	225
		U006_S007	225
		U006_S008	225
B2476951	BRACKET:PULLEY:DRIVEN:ASS'Y	U006_S005	226
		U006_S006	226
		U006_S007	226
		U006_S008	226
B2476982	STEPPED SCREW - M5	U013_S001	98
B2591131	SCREW:PCU	U008	20
B3031116	GROUNDING PLATE	U020	38
B3033682	MISFEED REMOVAL KNOB	U006	227
B3058671	(-AA):SHEET:EULA:TAIWAN	U023	11
B3863320	SPRING:BELT:PAPER FEED:8N	U003_S001_S004	67
B3871951	SPRING - PAPER SIZE SENSOR	U003_S001	68
B3872113	ROLLER - PAPER FEED BELT	U003_S001_S004	69
B4756855	SHIELD:TANDEM LCT:REAR RIGHT	U006_S001_S004	228
		U006_S002_S004	228
		U006_S003_S004	228
		U006_S004_S004	228
B4772227	PICKUP ROLLER:COUPLING	U003_S001_S004	70
B4772622	DISCHARGE BRUSH:L11	U003_S001	71
B4774117	SPRING	U003_S001_S013	72
B4774129	SPRING - 12N	U003_S001	73
B4774131	SPRING	U003_S001	74
B5457506	SCREW:BUSHING	U010_S001	10
B6455010	SD-CARD:ASS'Y	SPECIAL TOOLS	4
B6455020	SD-CARD:SERVICE:1GB:ASS'Y	SPECIAL TOOLS	5
B6523174	TENSION SPRING	U003_S001	76
B7001802	TIMING BELT:B40S2M134	U006	229
		U010_S001	11
B7004428	TIMING BELT:B40S2M158	U006	230
B7031166	TIMING BELT:B40S2M274:	U014	15
B7061859	SCREW:SLIDER:LOCK	U003_S001	79
B7125605	GRIP:APPLICATION	U004	22

Number	Part Name	Group	ID
		U020	39
B7892114	PAPER FEED BELT ROLLER	U003_S001_S004	80
B8022532	SPRING PLATE:SIDE FENCE	U003_S001	81
B8022536	SLIDER:SIDE FENCE	U003_S001	82
B8041180	DISCHARGE BRUSH:PUNCH UNIT	U003_S001	83
B8301135	SCREW	U003_S001	84
		U016_S001	85
B8323909	BRACKET CUSHION	U006	231
B8341648	TIMING BELT - B60S2M120	U013_S001	99
B8343312	COLLAR	U006	232
B8352889	TIMING BELT - B60S2M144	U013_S001	100
B8353968	TIMING BELT - B60S2M126	U016	86
B8722524	SPACER:DIA9	U003_S001	85
B8722614	BUSHING:R1	U013_S001	101
		U015_S001	95
		U015_S002	95
		U015_S003	95
		U015_S004	95
BA146065	SHAFT:STOPPER:TANDEM LCT	U006	233
BB013007	GEAR - 20Z	U006	234
		U006_S018	234
		U006_S019	234
BB013008	GEAR - 31Z	U006_S018	235
		U006_S019	235
BB013011	GEAR - 22Z	U006	236
BB013025	GEAR:PRESSURE ROLLER	U015_S001	96
		U015_S002	96
		U015_S003	96
		U015_S004	96
BB013028	GEAR:IDLER:35Z:ASS'Y	U015_S001	97
		U015_S002	97
		U015_S003	97
		U015_S004	97
BB013036	GEAR:IDLER:25Z:ASS'Y	U015_S001	98
		U015_S002	98
		U015_S003	98
		U015_S004	98
BB013037	GEAR:JOINT:PRESSURE:ASS'Y	U015_S001	99

Exclusive Parts

Number	Part Name	Group	ID
		U015_S002	99
		U015_S003	99
		U015_S004	99
BB013038	GEAR:HOT ROLLER:ASS'Y	U015_S001	100
		U015_S002	100
		U015_S003	100
		U015_S004	100
C1012360	SNAP RING	U001	11
C2182185	STEPPER SCREW	U019	35
		U020	40
C2361822	TIMING BELT - B60S2M186	U018_S010	68
		U018_S011	68
		U018_S012	68
C2363237	COLLAR 6X11.2X1.5	U009	57
C2382873	ADJUSTING SCREW	U015_S001	101
		U015_S002	101
		U015_S003	101
		U015_S004	101
C2693566	BUSHING:MM8:PRESSURE:DRIVE	U006	237
D0094388	ROLLER CLUTCH	U015_S005	102
D0142380	COMPRESSION SPRING - DRUM	U008	21
D0143241	SEAL:DISCHARGE USED TONER	U012	21
D0143242	SEAL:DISCHARGE USED TONER:LOWER	U012	22
D0143655	ELECTRIC POTENTIAL SENSOR	U008	22
D0143656	HOLDER:ELECTRIC POTENTIAL SENSOR	U008	23
D0143657	SHIELDING PLATE	U008	24
D0144247	HOUSING - TEMPERATURE SENSOR	U015_S001	103
		U015_S002	103
		U015_S003	103
		U015_S004	103
D0146272	BUSHING:BRUSH:REAR	U011_S001	19
D0146458	SPRING:BLADE:NO.1	U001_S003	12
D0146626	BRACKET:ON OFF DETECTOR:FRONT	U006_S001	238
		U006_S002	238
		U006_S003	238
		U006_S004	238

Number	Part Name	Group	ID
D0146627	BRACKET:ON OFF DETECTOR:REAR	U006_S001	239
		U006_S002	239
		U006_S003	239
		U006_S004	239
D0146784	SPRING PLATE:END FENCE	U006_S009	241
D0146785	SPRING PLATE:ARM:END FENCE:LOCK	U006_S009	242
D0149800	GREASE : KS660	SPECIAL TOOLS	6
D0159500	G104 YELLOW TONER	SPECIAL TOOLS	7
D0159501	ZINC STEARATE	SPECIAL TOOLS	8
D0291749	PULLEY:PROTECTION	U004	23
D0393368	SCREW:M3X3.5	U007_S013	56
		U007_S015	56
		U007_S017	56
		U007_S019	56
D0396327	SPACER:SENSOR:TM	U009	59
D0590761	SPRING:TANDEM TRAY:LOCK	U006	243
D0591273	DECAL:MAIN SWITCH	U007	57
D0592399	FLANGED HEXAGONAL HEAD BOLT:M3*4	U006	244
		U013_S001	103
D0592620	RETAINING RINGS-C	U006_S018	245
		U006_S019	245
D0596121	SPRING:CONNECTOR:TANDEM LOCK	U006	246
D0596170	BRACKET:SLIDE RAIL:PAPER TRAY:2:ASS'Y	U006	247
D0596172	PAPER TRAY STOPPER	U006	248
D0596212	LEVER:PRESSURE:REVERSE	U006_S018	249
		U006_S019	249
D0596277	COVER:GEAR:PAPER FEED ROLLER	U006_S018	250
		U006_S019	250
D0596278	COVER:GEAR:REVERSE	U006_S018	251
		U006_S019	251
D0596496	GUIDE:MIDDLE:PAPER TRAY	U006	252
D0596591	SPRING:PAPER TRAY:LOCK	U006	253
D0596620	LEVER:COUPLING:LEFT	U006_S005	254
		U006_S006	254
		U006_S007	254

Exclusive Parts

Number	Part Name	Group	ID
		U006_S008	254
D0596659	SUPPORTING PLATE:SIDE FENCE :LEFT	U006_S005	256
		U006_S006	256
		U006_S007	256
		U006_S008	256
D0596664	GUIDE:MIDDLE:PAPER TRAY	U006	257
D0596665	BRACKET:DC MOTOR:LEFT:ASS'Y	U006_S005	258
		U006_S006	258
		U006_S007	258
		U006_S008	258
D0596668	SIDE PLATE:SIDE:TANDEM LCT	U006_S001	259
		U006_S002	259
		U006_S003	259
		U006_S004	259
D0596690	PLATE:PAPER:ASS'Y	U006_S001_S003	260
		U006_S002_S003	260
		U006_S003_S003	260
		U006_S004_S003	260
D0596712	INNER COVER:TANDEM LCT	U006_S001	261
		U006_S002	261
		U006_S003	261
		U006_S004	261
D0596721	STOPPER:PAPER TRAY	U006	262
D0596725	BRACKET:STOPPER:PAPER TRAY :RIGHT:PEEN	U006	263
D0596728	COMPRESSION SPRING:GRIP:PA PER TRAY	U006	264
D0596731	SHIELD:GUIDE:MISFEED REMOVA L	U006	265
D0596765	DC SOLENOID:LOCK:ASS'Y	U006_S012	266
D0606639	(-CHN):TRAY BOTTOM PLATE:LEF T MIDDLE:ASS'Y	U006_S008	267
D0606680	(-CHN):BASE:TANDEM LCT:RIGHT: ADHESION	U006_S004	268
D0626692	SLIDE RAIL:PAPER TRAY:LEFT:SU B-ASS'Y	U006	269
D0741088	SHEET:BASE:MAIN:FRONT	U022	25
D0741125	PLATE:RADIAL BALL BEARING:TH	U022	26

Number	Part Name	Group	ID
	RUST		
D0741128	PLAIN SHAFT BEARING:POSITIONI NG PIN:FUSING	U022	27
D0741141	SUPPORTING PLATE:FRAME:MAI N	U022	53
D0741143	BRACKET:COUPLING	U022	28
D0741152	SLIDE RAIL:EXIT:RIGHT	U022	29
D0741154	COVER:PAPER EXIT UNIT:EXIT	U022	30
D0741173	BOSS:POSITIONING PIN:TRANSP ORT UNIT:NO.2:10.3MM	U022	31
D0741179	LEVER:PULL OUT:REGISTRATION	U013_S001	104
D0741180	LEVER:PULL OUT:PAPER EXIT UN IT	U016	87
D0741194	SHAFT:LOCK:TRANSPORT UNIT	U013_S001	105
D0741195	GUIDE:LOCK:TRANSPORT UNIT	U022	32
D0741212	SUPPORTING PLATE:POSITIONIN G PIN:RIGHT	U016	88
D0741213	HOLDER:COIL SPRING:LOCK:PAP ER EXIT UNIT	U016	89
D0741215	SHAFT:LOCK:PAPER EXIT UNIT	U016	90
D0741219	DUCT:C/T BOX:POWER SUPPLY U NIT	U020	41
D0741225	HINGE:C/T BOX:RIGHT UPPER:PE EN	U020	42
D0741228	COVER:HINGE	U020	43
D0741230	HINGE:C/T BOX:LEFT UPPER:PEE N	U020	44
D0741250	ARM:HINGE:C/T BOX	U020	45
D0741251	DUCT:EXHAUST:EXIT:ASS'Y	U020_S001	46
D0741254	SIDE PLATE:C/T BOX:LEFT	U020	123
D0741255	SEPARATION PLATE:DUCT	U020	47
D0741258	COVER:C/T BOX:RIGHT LOWER	U020_S002	48
		U020_S003	48
D0741271	SEAL:COVER:C/T BOX:UPPER	U020	49
D0741288	SIDE PLATE:C/T BOX:UPPER	U020	120
D0741369	COVER:ENCODER	U009	60
		U013_S001	106
		U018	70

Exclusive Parts

Number	Part Name	Group	ID
D0741379	BRACKET:PLATE	U018	71
D0741382	SHAFT:DRIVE:INTERMEDIATE TRANSFER:ENCODER:ADHESION	U009	61
D0741387	SHAFT:JOINT:PAPER FEED UNIT: ASS'Y	U006	270
D0741389	COMPRESSION SPRING:JOINT:TRANSPORT	U006	271
		U018_S001	72
D0741390	SHAFT:OUTPUT:DRIVE:VACUUM:ASS'Y	U018	73
D0741394	PULLEY:DRIVE:TRANSPORT UNIT	U014	16
D0741411	BRACKET:DRIVE:VACUUM:LOWER	U018	74
D0741412	BRACKET:DRIVE:VACUUM:UPPER:ASS'Y	U018	75
D0741424	BRACKET:TIGHTENER:ASS'Y	U018_S004	76
D0741426	PULLEY:IDLER	U018	77
D0741454	DC MOTOR:DIA49:9.8W:BLS	U012	23
		U018	78
D0741460	BRACKET:AUXILIARY:DRIVE:EXIT	U018	79
D0741464	SHAFT:RIGHT:DRIVE:USED TONER:ASS'Y	U018	80
D0741465	BRACKET:TENSION:DRIVE:USED TONER:ASS'Y	U018	81
D0741466	BRACKET:TIGHTENER:DRIVE:USED TONER:ASS'Y	U018	82
D0741468	BRACKET:MIDDLE:DRIVE:USED TONER:ASS'Y	U018	83
D0741470	SHAFT:LEFT:DRIVE:USED TONER:ASS'Y	U018	84
D0741473	BRACKET:TENSIONER:DRIVE UNIT:USED TONER:ASS'Y	U018	85
D0741476	HOLDER:RIGHT:DRIVE:USED TONER	U018	86
D0741484	HOLDER:LEFT:DRIVE:USED TONER	U018	87
D0741486	BRACKET:MOTOR:DRIVE:USED TONER	U018	88
D0741487	BRACKET:DRIVE UNIT:USED TONER	U018	89

Number	Part Name	Group	ID
	ER		
D0741496	JOINT:DRIVE:USED TONER	U018	90
D0741498	BRACKET:SENSOR	U018	91
D0742020	SHIELD GLASS:ASS'Y	U005_S001	9
		U005_S002	9
		U005_S003	9
D0742172	BRACKET:SOLENOID:ON-OFF	U008	25
D0742178	TENSION SPRING:SOLENOID:ON-OFF	U008	26
D0742181	CONNECTOR:1POLE	U008	27
D0742192	SHEET:DISCHARGE LAMP	U008_S008	28
		U008_S011	28
		U008_S014	28
		U008_S017	28
		U008_S020	28
D0742252	FRAME:PHOTOCONDUCTOR	U008	29
D0742272	BRACKET:TEMPERATURE & HUMIDITY SENSOR	U008	30
D0742274	BRACKET:ELECTRIC POTENTIAL SENSOR	U008	31
D0742366	LEVER:LOCK:CHARGE UNIT	U008_S008	32
		U008_S011	32
		U008_S014	32
		U008_S017	32
		U008_S020	32
D0742367	HOLDER:LOCK:CHARGE UNIT	U008_S008	33
		U008_S011	33
		U008_S014	33
		U008_S017	33
		U008_S020	33
D0742368	COMPRESSION SPRING:LOCK:CHARGE UNIT	U008_S008	34
		U008_S011	34
		U008_S014	34
		U008_S017	34
		U008_S020	34
D0742376	LEVER:LOCK:PCU	U008_S008	35
		U008_S011	35
		U008_S014	35

Exclusive Parts

Number	Part Name	Group	ID
		U008_S017	35
		U008_S020	35
D0742377	TENSION SPRING:LOCK:PCU	U008_S008	36
		U008_S011	36
		U008_S014	36
		U008_S017	36
		U008_S020	36
D0742381	COMPRESSION SPRING:LOCK:CLEANING UNIT	U008_S008	37
		U008_S011	37
		U008_S014	37
		U008_S017	37
		U008_S020	37
D0742382	HOLDER:LOCK:CLEANING UNIT:FRONT	U008_S008	38
		U008_S011	38
		U008_S014	38
		U008_S017	38
		U008_S020	38
D0742383	LEVER:LOCK:CLEANING UNIT:FRONT	U008_S008	39
		U008_S011	39
		U008_S014	39
		U008_S017	39
		U008_S020	39
D0742386	HOLDER:LOCK:CLEANING UNIT:REAR	U008_S008	40
		U008_S011	40
		U008_S014	40
		U008_S017	40
		U008_S020	40
D0742392	COVER:PCU:FRONT:ASS'Y	U008_S008_S001	41
		U008_S011_S001	41
		U008_S014_S001	41
		U008_S017_S001	41
		U008_S020_S001	41
D0742393	COVER:PCU:FRONT	U008_S008_S001	42
		U008_S011_S001	42
		U008_S014_S001	42
		U008_S017_S001	42
		U008_S020_S001	42
D0742395	GROUND PLATE:PCU:ASS'Y	U008_S008_S001	43

Number	Part Name	Group	ID
		U008_S011_S001	43
		U008_S014_S001	43
		U008_S017_S001	43
		U008_S020_S001	43
D0742414	TRANSPORT SCREW:BASE:ASS'Y	U008_S007	44
		U008_S010	44
		U008_S013	44
		U008_S016	44
		U008_S019	44
D0742419	PLAIN SHAFT BEARING:TRANSPORT SCREW	U008_S007	45
		U008_S010	45
		U008_S013	45
		U008_S016	45
		U008_S019	45
D0742424	SEAL:BLADE:CLEANING:FRONT	U008_S007	46
		U008_S010	46
		U008_S013	46
		U008_S016	46
		U008_S019	46
D0742425	SEAL:BLADE:CLEANING:REAR	U008_S007	47
		U008_S010	47
		U008_S013	47
		U008_S016	47
		U008_S019	47
D0742448	TRANSPORT SCREW:APPLY:ASS'Y	U008_S007	48
		U008_S010	48
		U008_S013	48
		U008_S016	48
		U008_S019	48
D0742459	JOINT:CLEANING UNIT	U008_S007	49
		U008_S010	49
		U008_S013	49
		U008_S016	49
		U008_S019	49
D0742477	SHEET:STAY:APPLY	U008_S007_S001	50
		U008_S010_S001	50
		U008_S013_S001	50
		U008_S016_S001	50

Exclusive Parts

Number	Part Name	Group	ID
		U008_S019_S001	50
D0742491	COVER:TONER OUTLET SUB-UNIT :CLEANING UNIT:ASS'Y	U008_S007	51
		U008_S010	51
		U008_S013	51
		U008_S016	51
		U008_S019	51
D0742497	VIBRATING PLATE:TONER OUTLE T SUB-UNIT	U008_S007	52
		U008_S010	52
		U008_S013	52
		U008_S016	52
		U008_S019	52
D0742501	GEAR:21Z:RIGHT	U008_S007_S002	53
		U008_S010_S002	53
		U008_S013_S002	53
		U008_S016_S002	53
		U008_S019_S002	53
D0742502	GEAR:IDLER:20Z:LEFT	U008_S007_S002	54
		U008_S010_S002	54
		U008_S013_S002	54
		U008_S016_S002	54
		U008_S019_S002	54
D0742503	GEAR:IDLER:31Z:LEFT	U008_S007_S002	55
		U008_S010_S002	55
		U008_S013_S002	55
		U008_S016_S002	55
		U008_S019_S002	55
D0742540	DECAL:LOCK:CLEANING UNIT	U008_S008_S001	56
		U008_S011_S001	56
		U008_S014_S001	56
		U008_S017_S001	56
		U008_S020_S001	56
D0742541	DECAL:ARROW LABEL	U008	57
		U008_S008	57
		U008_S011	57
		U008_S014	57
		U008_S017	57
		U008_S020	57
D0742542	DECAL:GRIP	U008	58

Number	Part Name	Group	ID
		U008_S007	58
		U008_S010	58
		U008_S013	58
		U008_S016	58
		U008_S019	58
D0742544	DECAL:POSITIONING DISPLAY	U008_S008	59
		U008_S011	59
		U008_S014	59
		U008_S017	59
		U008_S020	59
D0742553	SLIDE RAIL:PCU:RIGHT	U008	61
D0742561	LOCK:SLIDE RAIL:PCU:RIGHT	U008	62
D0742572	STAY:SET SENSOR:PCU	U008	63
D0742575	ARM:SET SENSOR:PCU	U008	64
D0742576	HOLDER:SET SENSOR:PCU	U008	65
D0742577	CONNECTOR:DRAWER:4POLE:RE C	U008	66
D0742621	PLATE:DC MOTOR:TIMING ROLLE R:TRANSFER	U013_S001	107
D0742622	BRACKET:DC MOTOR:TIMING ROL LER:TRANSFER	U013_S001	108
D0742626	TIMING PULLEY:S2M:31T/31T	U013_S001	109
D0742629	BRACKET:DC STEPPER MOTOR:T RANSPORT ROLLER:SHIFT	U013_S001	110
D0742632	BRACKET:DC STEPPER MOTOR:M M56:CAM	U013_S001	111
D0742634	BRACKET:DC STEPPER MOTOR:M M42:REGISTRATION:ENTRANCE	U013_S001	112
D0742636	HOLDER:SENSOR:TRANSFER:TIM ING	U013_S001	113
D0742642	GEAR:TIMING ROLLER:TRANSFER :Z59	U013_S001	114
D0742643	TIMING ROLLER:TRANSFER:DRIV EN	U013_S001	115
D0742652	LEVER:LINK:TRANSPORT ROLLER	U013_S001	116
		U016_S010	91
D0742654	CASE:REMOVE PAPER DUST:ASS' Y	U013_S001	117

Exclusive Parts

Number	Part Name	Group	ID
D0742663	HOLDER:SENSOR:REGISTRATION :TIMING	U013_S001	118
D0742665	REGISTRATION ROLLER:TIMING:D RIVE	U013_S001	119
D0742681	SHAFT:CAM:SHIFT	U013_S001	121
D0742686	DUCT:FAN:CONTACT IMAGE SEN SOR	U013_S001	123
D0742687	HOLDER:HOME POSITION SENSO R:GATE	U013_S001	124
D0742691	SHAFT:CAM	U013_S001	125
D0742693	CAM:GATE	U013_S001	126
D0742694	CAM:TRANSPORT ROLLER:SHIFT	U013_S001	127
D0742711	TRANSPORT ROLLER:CONNECTI NG:LARGE CAPACITY TRAY	U013_S001	128
D0742715	BRACKET:SOLENOID:PEEN	U013_S001	129
D0742718	SHAFT:SHIFT	U013_S001	130
D0742721	ARM:TRANSPORT ROLLER:SHIFT: TAKE SHEJTER	U013_S001	131
D0742722	PROTECTION:ARM:TRANSPORT R OLLER:SHIFT:TAKE SHEJTER	U013_S001	132
D0742732	GUIDE PLATE:SHIFT:UPPER:PEEN	U013_S001_S002	133
D0742737	SHAFT:SHIFT:TAKE SHEJTER	U013_S001_S002	134
D0742739	PRESSURE ROLLER:TRANSPORT ROLLER:SHIFT:DRIVEN	U013_S001_S002	135
D0742740	SHAFT:SHIFT:DRIVEN:ROLLER	U013_S001_S002	136
D0742741	BRACKET:SHIFT:DRIVEN:TAKE SH EJTER	U013_S001_S002	137
D0742744	HOLDER:SHIFT:BEARING:FRONT	U013_S001_S002	138
D0742745	HOLDER:SHIFT:BEARING:REAR	U013_S001_S002	139
D0742748	SHAFT:ARM:REGISTRATION ROLL ER:TIMING	U013_S001	140
D0742749	ARM:REGISTRATION ROLLER:TIMI NG	U013_S001	141
D0742750	STAY:SOLENOID	U013_S001	142
D0742756	HOLDER:SENSOR:CONNECTING:L CT:NO.1	U013_S001	143
D0742757	HOLDER:SENSOR:CONNECTING:L CT:NO.2	U013_S001	144

Number	Part Name	Group	ID
D0742760	TRANSPORT ROLLER:SHIFT:DRIV E:PRESS FIT	U013_S001_S002	145
D0742769	BRACKET:DC STEPPER MOTOR:R EGISTRATION ROLLER:TIMING	U013_S001	146
D0742771	SHAFT:REGISTRATION ROLLER:TI MING:DRIVEN	U013_S001	147
D0742772	COVER:BEARING	U013_S001	148
D0742773	FIX STAND:GUIDE PLATE:TIMING: TRANSFER:EXIT	U013_S001	149
D0742777	CAM:REGISTRATION ROLLER:TIMI NG	U013_S001	150
D0742783	REGISTRATION GUIDE:OPEN AND CLOSE	U013_S001	151
D0742789	HOLDER:DOUBLE FEED SENSOR: RADIATE	U013_S001	153
D0742794	HOLDER:DOUBLE FEED SENSOR: PHOTO	U013_S001	154
D0742795	GUIDE PLATE:REGISTRATION:EN TRANCE:LOWER	U013_S001	155
D0742797	STAY:CONNECTION:LARGE CAPA CITY TRAY	U013	156
D0742799	GUIDE PLATE:CONNECTION:LCT: LOWER	U013	157
D0742809	COVER:HARNES: PAPER FEED U NIT:FRONT	U013_S001	158
D0742813	HOOK:COIL SPRING:GATE	U013_S001	159
D0742818	FIX STAND:GUIDE PLATE:REAR	U013_S001	161
D0742864	GUIDE PLATE:DUPLEX:RIGHT:UP PER	U013_S001	163
D0742873	GUIDE PLATE:PULL OUT:RIGHT:V ERTICAL TRANSPORT	U013_S001	164
D0742876	SHAFT:LOCK:GUIDE PLATE	U013_S001	165
D0742881	TRANSPORT ROLLER:REGISTRAT ION:ENTRANCE:DRIVE:PRESS FIT	U013_S001	166
D0742882	TRANSPORT ROLLER:DUPLEX:RI GHT:NO.1:PRESS FIT	U013_S001	167
D0742896	HOLDER:DC SOLENOID:VERTICAL TRANSPORT:UPPER	U013_S001	168

Exclusive Parts

Number	Part Name	Group	ID
D0742899	HOLDER:DC SOLENOID:VERTICAL TRANSPORT:LOWER:PEEN	U013_S001	169
D0742903	DC SOLENOID:VERTICAL TRANSPORT:UPPER:PRESS FIT	U013_S001	170
D0742904	DC SOLENOID:PRESS FIT	U013_S001	171
D0742908	BRACKET:DC STEPPER MOTOR:DUPLX:RIGHT	U013_S001	172
D0742912	BRACKET:SENSOR:DUPLX:SHORT	U013_S001	173
D0742924	COVER:HARNESS	U013_S001	174
D0742926	BRACKET:SENSOR:VERTICAL TRANSPORT:NO.2	U013_S001	175
D0742929	BRACKET:SENSOR:VERTICAL TRANSPORT:NO.3	U013_S001	176
D0742930	SHAFT:LINK:ON-OFF:VERTICAL TRANSPORT:LOWER	U013_S001	177
D0742931	SHAFT:LINK:ON-OFF:VERTICAL TRANSPORT:UPPER	U013_S001	178
D0742934	SHAFT:ON-OFF:LARGE CAPACITY TRAY:CONNECTING	U013_S001	179
D0742935	GUIDE:DUPLX:OPEN AND CLOSE:RIGHT:LOWER	U013_S001	180
D0742938	GUIDE PLATE:CONNECTION:LARGE CAPACITY TRAY:UPPER:PEEN	U013	181
D0742941	TIMING PULLEY:S2M:30T	U013_S001 U016	182 92
D0742942	PIN:GUIDE PLATE:CONNECTION:LARGE CAPACITY TRAY:UPPER	U013	183
D0742955	GUIDE PLATE:TIMING:TRANSFER	U013_S001	184
D0742960	GUIDE PLATE:REGISTRATION:ENTRANCE:UPPER	U013_S001	185
D0742962	BRACKET:MISFEED REMOVAL:TIMING ROLLER:TRANSFER	U013_S001	186
D0742964	STAY:REGISTRATION:RIGHT UPPER	U013_S001	187
D0742965	HOLDER:PRESSURE:DRIVEN ROLLER:DUPLX:EXIT	U013_S001	188
D0742969	SHAFT:MISFEED REMOVAL:TIMING	U013_S001	189

Number	Part Name	Group	ID
	G ROLLER:TRANSFER		
D0742970	CAM:GUIDE PLATE:OPEN AND CLOSE	U013_S001	190
D0742971	PLATE:LINK:OPEN AND CLOSE:REAR	U013_S001	191
D0742972	LEVER:GUIDE PLATE:OPEN AND CLOSE:FRONT	U013_S001	192
D0742974	STOPPER:LEVER:TRANSPORT UNIT:LEFT	U013_S001	193
D0742975	STOPPER:GUIDE PLATE:CONNECTING:LARGE CAPACITY TRAY	U013_S001	194
D0742977	COVER:HARNESS:FRONT UPPER	U013_S001	195
D0742979	LEVER:GUIDE PLATE	U013_S001_S003	196
D0742984	DECAL:PULL OUT:RIGHT:B1	U001	13
D0742985	DECAL:PULL OUT:RIGHT:B3	U001	14
D0742986	DECAL:PULL OUT:RIGHT:B4	U001	15
D0742987	DECAL:PULL OUT:RIGHT:B6	U001	16
D0742988	DECAL:PULL OUT:RIGHT:B7	U013_S001	197
D0742989	DECAL:PULL OUT:RIGHT:Z2	U001	17
D0742990	DECAL:PULL OUT:RIGHT:Z4	U013_S001_S003	198
D0743033	GUIDE PLATE:CONNECTING	U013	199
D0743038	BRACKET:DUPLX:EXIT	U013	200
D0743039	GUIDE PLATE:DUPLX:EXIT	U013	201
D0743047	BRACKET:HOLDER:DUPLX:ASS'Y	U013 U016	202 93
D0743105	DC MOTOR:DIA35.8:24V:4.1W	U013_S001	203
D0743171	TIMING ROLLER:TRANSFER:DRIVE:PRESS FIT	U013_S001	204
D0743173	TIMING PULLEY:S2M:25T	U006 U013_S001 U016 U017	272 205 94 15
D0743216	GUIDE:TONER SUPPLY:ASS'Y	U008_S008_S002 U008_S011_S002 U008_S014_S002 U008_S017_S002 U008_S020_S002	119 119 119 119 119
D0743321	PLATE:FILTER	U008_S008	67

Exclusive Parts

Number	Part Name	Group	ID
		U008_S011	67
		U008_S014	67
		U008_S017	67
		U008_S020	67
D0743352	SEAL:GUIDE:TONER SUPPLY:UPPER	U008_S008_S002	69
		U008_S011_S002	69
		U008_S014_S002	69
		U008_S017_S002	69
		U008_S020_S002	69
D0743362	ELECTRODE PLATE:DEVELOPMENT BIAS:FRONT	U008_S008	70
		U008_S011	70
		U008_S014	70
		U008_S017	70
		U008_S020	70
D0743367	ELECTRODE PLATE:DEVELOPMENT BIAS:REAR UPPER	U008_S008	71
		U008_S011	71
		U008_S014	71
		U008_S017	71
		U008_S020	71
D0743368	ELECTRODE PLATE:DEVELOPMENT BIAS:REAR LOWER	U008_S008	72
		U008_S011	72
		U008_S014	72
		U008_S017	72
		U008_S020	72
D0743427	RADIAL BALL BEARING:DIA8XDIA16X5	U008_S008	73
		U008_S011	73
		U008_S014	73
		U008_S017	73
		U008_S020	73
D0743440	COVER:INSERT:DEVELOPER	U008_S008	74
		U008_S011	74
		U008_S014	74
		U008_S017	74
		U008_S020	74
D0743446	RECEPTACLE:DEVELOPMENT BIAS:ASS'Y	U008_S001	75
		U008_S002	75
		U008_S003	75
		U008_S004	75

Number	Part Name	Group	ID
		U008_S005	75
D0743490	FUNNEL:DEVELOPER	U006	273
D0743533	ELECTROMAGNETIC CLUTCH:DRIVE:TRANSPORT SCREW:ASS'Y	U007_S001	58
		U007_S004	58
		U007_S007	58
		U007_S010	58
D0743548	GEAR:IDLER:TRANSPORT SCREW:LARGE	U007	59
D0743703	(D203/D204):GEAR:TONER BOTTLE:DIA92	U007_S025	60
D0743708	(D203/D204):SPRING LOCK WASHER:DRIVE SUB-UNIT:TONER BOTTLE	U007_S025	61
D0743721	(D203/D204):JOINT:DRIVE:TONER SUPPLY UNIT	U007_S025	62
D0743736	SEAL:NOZZLE:NOZZLE COVER	U007_S024	64
D0743741	(D203/D204):STOPPER:SHUTTER:TONER CARTRIDGE:TYPE A	U007_S024	65
D0743742	(D203/D204):HOLDER:STOPPER:SHUTTER:TYPE A	U007_S024	66
D0743743	(D203/D204):SPRING PLATE:STOPPER:SHUTTER:TYPE B	U007_S024	67
D0743745	(D203/D204):SEAL:HOLDER:STOPPER:RIGHT	U007_S024	68
D0743746	(D203/D204):SEAL:HOLDER:STOPPER:LEFT	U007_S024	69
D0743756	SEAL:BLOCK LIGHT:LEVER	U007	70
		U007_S024	70
D0743757	MAGNET CATCH PLEET:TONER SUPPLY SUB-UNIT:UPPER	U007_S021	71
D0743763	(D203/D204):NOZZLE COVER:TONER SUPPLY SUB-UNIT	U007_S024	72
D0743766	(D203/D204):PLATE:COIL SPRING	U007_S024	73
D0743768	(D203/D204):TENSION SPRING:SHUTTER:TONER SUPPLY UNIT	U007_S024	74
D0743808	CASE:TENSION:ROLLER:ASS'Y	U009_S001	62
D0743821	TENSION SPRING:PRESSURE:INTERMEDIATE TRANSFER:COLLAR	U009	63

Exclusive Parts

Number	Part Name	Group	ID
D0743822	ROLLER:OPPOSED:BELT CLEANING:PRESS FIT	U009	64
D0743824	PLATE:ROLLER:INTERMEDIATE TRANSFER	U009	222
D0743829	DECAL:POSITIONING DISPLAY:TCRU	U007	75
		U008_S008_S001	76
		U008_S011_S001	76
		U008_S014_S001	76
		U008_S017_S001	76
		U008_S020_S001	76
	U009	65	
D0743830	DECAL:OPERATE:LEVER:INTERMEDIATE TRANSFER	U009	66
D0743841	SEAL:RIGHT:INTERMEDIATE TRANSFER	U009	67
D0743842	COVER:HARNESS:SECOND:INTERMEDIATE TRANSFER	U009	68
D0743845	FLAT NUT:INNER COVER:INTERMEDIATE TRANSFER	U009	69
D0743846	INNER COVER:BELT CLEANING	U009	70
D0743853	PLATE:FRAME:INTERMEDIATE TRANSFER	U009	71
D0743858	PULLEY:DRIVE:VACUUM	U014	18
D0743863	SHAFT:DRIVEN:FLAT CONVEYER BELT	U014_S001	19
D0743871	STOPPER:WIRE:PULLEY	U009	72
D0743872	PULLEY:DRIVE WERE:ASS'Y	U009	73
D0743873	FEELER:DRIVE WERE	U009	74
D0743874	BRACKET:POSITIONING CONTROL:DRIVEN ROLLER:INNER BACK:ASS'Y	U009	75
D0743878	HOLDER:RADIAL BALL BEARING:DRIVEN ROLLER:INNER BACK	U009	76
D0743881	BRACKET:DC STEPPER MOTOR:POSITIONING CONTROL	U009	77
D0743887	BRACKET:ON-OFF:TRANSFER ROLLER	U009	78
D0743892	LEVER:POSITIONING SENSOR:FL	U009	80

Number	Part Name	Group	ID
	AT BELT-TRANSFER		
D0743896	COVER:POSITIONING SENSOR:FL AT BELT-TRANSFER	U009	81
D0743898	BRACKET:POSITIONING SENSOR:SLACK PREVENTION	U009	82
D0743899	LEVER:POSITIONING SENSOR:SLACK PREVENTION	U009	83
D0743921	SHAFT:COOLING:ENTRANCE	U016_S001	95
D0743927	GUIDE PLATE:BELT:LOWER:PEEN	U016_S001	96
D0743932	LEVER:STOPPER	U016_S001	97
D0743943	ROLLER:FUSING EXIT:DRIVEN:ASS'Y	U016_S002	98
D0743951	SHAFT:GRIP:GUIDE PLATE	U016_S002	99
D0743986	BRACKET:CAP:HEAT PIPE:LOWER	U016	100
D0743991	PLATE:EXIT:ENTRANCE	U016	101
D0744000	SUPPORTING PLATE:LEVER:PRESSURE	U015_S001	104
		U015_S002	104
		U015_S003	104
		U015_S004	104
D0744009	HOLDER:M5	U015_S001	105
		U015_S002	105
		U015_S003	105
		U015_S004	105
D0744016	LEVER:WEB:ASS'Y	U015_S001	106
		U015_S002	106
		U015_S003	106
		U015_S004	106
D0744060	SIDE PLATE:PRESSURE:REAR	U015_S001	107
		U015_S002	107
		U015_S003	107
		U015_S004	107
D0744061	CLAMP:HARNESS:PRESSURE	U015_S001	108
		U015_S002	108
		U015_S003	108
		U015_S004	108
D0744062	BRACKET:THERMISTOR:PRESSURE	U015_S001	109
		U015_S002	109
		U015_S003	109

Exclusive Parts

Number	Part Name	Group	ID
		U015_S004	109
D0744063	HOUSING:THERMOSTAT:ASS'Y	U015_S001	110
		U015_S002	110
		U015_S003	110
		U015_S004	110
D0744064	COVER:THERMOSTAT:PRESSURE	U015_S001	111
		U015_S002	111
		U015_S003	111
		U015_S004	111
D0744065	COVER:TEMPERATURE SENSOR:PRESSURE	U015_S001	112
		U015_S002	112
		U015_S003	112
		U015_S004	112
D0744066	LIQUID STREAM PLATE:PRESSURE:ENTRANCE	U015_S001	113
		U015_S002	113
		U015_S003	113
		U015_S004	113
D0744089	DUCT:PRESSURE:LOWER	U015_S001	114
		U015_S002	114
		U015_S003	114
		U015_S004	114
D0744090	DUCT:PRESSURE:EXIT:CONNECTING:A	U015_S001	115
		U015_S002	115
		U015_S003	115
		U015_S004	115
D0744091	DUCT:PRESSURE:EXIT:CONNECTING:B	U015_S001	116
		U015_S002	116
		U015_S003	116
		U015_S004	116
D0744092	DUCT:PRESSURE:EXIT	U015_S001	117
		U015_S002	117
		U015_S003	117
		U015_S004	117
D0744094	FIX STAND:TERMINAL:HEATER:ASS'Y	U015_S001	118
		U015_S002	118
		U015_S003	118
		U015_S004	118
D0744095	JOINT UNIT:PAPER FEED SENSOR	U015_S001	119

Number	Part Name	Group	ID
	R:PRESSURE:FRONT	U015_S002	119
		U015_S003	119
		U015_S004	119
D0744096	TERMINAL:CONNECTING	U015_S001	120
		U015_S002	120
		U015_S003	120
		U015_S004	120
D0744097	TAB:TERMINAL:CONNECTING	U015_S001	121
		U015_S002	121
		U015_S003	121
		U015_S004	121
D0744098	COVER:TERMINAL:CONNECTING	U015_S001	122
		U015_S002	122
		U015_S003	122
		U015_S004	122
D0744099	COVER:HARNESS:FIRST:LOWER	U015_S001	123
		U015_S002	123
		U015_S003	123
		U015_S004	123
D0744100	COVER:BASE:ID	U015_S001	124
		U015_S002	124
		U015_S003	124
		U015_S004	124
D0744102	COLLAR:DIA10X:DIA14X:12	U015_S001	125
		U015_S002	125
		U015_S003	125
		U015_S004	125
D0744103	CAM:PRESSURE:A	U015_S001	126
		U015_S002	126
		U015_S003	126
		U015_S004	126
D0744104	FEELER:CAM:PRESSURE:FRONT	U015_S001	127
		U015_S002	127
		U015_S003	127
		U015_S004	127
D0744107	COLLAR:DIA10XDIA14X9.4	U015_S001	128
		U015_S002	128
		U015_S003	128

Exclusive Parts

Number	Part Name	Group	ID
		U015_S004	128
D0744123	LEVER:STRIPPER PLATE:PLATE	U015_S001	129
		U015_S002	129
		U015_S003	129
		U015_S004	129
D0744124	BRACKET:STRIPPER PLATE:PLATE:PEEN	U015_S001	130
		U015_S002	130
		U015_S003	130
		U015_S004	130
D0744138	COLLAR:DIA5XDIA7X10	U015_S001	131
		U015_S002	131
		U015_S003	131
		U015_S004	131
D0744139	LEVER:STRIPPER PLATE:PRESSURE	U015_S001	132
		U015_S002	132
		U015_S003	132
		U015_S004	132
D0744144	LEVER:PAPER EXIT UNIT:FRONT	U015_S001	133
		U015_S002	133
		U015_S003	133
		U015_S004	133
D0744172	COVER:HARNESS:FIRST	U015_S001	135
		U015_S002	135
		U015_S003	135
		U015_S004	135
D0744180	HOUSING:THERMOSTAT:HEAT ROLLER:ASS'Y	U015_S001	136
		U015_S002	136
		U015_S003	136
		U015_S004	136
D0744181	ELECTRODE PLATE:THERMOSTAT:HEAT ROLLER:MIDDLE	U015_S001	137
		U015_S002	137
		U015_S003	137
		U015_S004	137
D0744182	ELECTRODE PLATE:THERMOSTAT:HEAT ROLLER	U015_S001	138
		U015_S002	138
		U015_S003	138
		U015_S004	138
D0744183	TAB:TERMINAL:187:2P:UPPER	U015_S001	139

Number	Part Name	Group	ID
		U015_S002	139
		U015_S003	139
		U015_S004	139
D0744184	TAB:TERMINAL:187:2P:LOWER	U015_S001	140
		U015_S002	140
		U015_S003	140
		U015_S004	140
D0744207	COVER:GREASE:GEAR:JOINT:PRESSURE	U015_S001	141
		U015_S002	141
		U015_S003	141
		U015_S004	141
D0744208	COVER:GUARD:SIDE PLATE:REAR	U015_S001	142
		U015_S002	142
		U015_S003	142
		U015_S004	142
D0744225	KNOB:FUSING	U023	12
D0744227	BOLT:M5:ROUND POINT	U015_S001	144
		U015_S002	144
		U015_S003	144
		U015_S004	144
D0744235	SUPPORTING PLATE:GUIDE PLATE:FUSING EXIT:LOWER	U015_S001	145
		U015_S002	145
		U015_S003	145
		U015_S004	145
D0744264	BRACKET:DRAWER	U015_S001	146
		U015_S002	146
		U015_S003	146
		U015_S004	146
D0744265	BRACKET:DRAWER:LOWER	U015_S001	147
		U015_S002	147
		U015_S003	147
		U015_S004	147
D0744266	CLAMP:HARNESS:PRESSURE:HEATER:REAR	U015_S001	148
		U015_S002	148
		U015_S003	148
		U015_S004	148
D0744269	PIN:HANDLE:COVER	U015_S001	149
		U015_S002	149

Exclusive Parts

Number	Part Name	Group	ID
		U015_S003	149
		U015_S004	149
D0744274	STOPPER:DIA4:PEEN	U015_S001	254
		U015_S002	254
		U015_S003	254
		U015_S004	254
D0744277	GUIDE PLATE:EXIT:CONNECTING:UPPER:SHEET	U015_S001	150
		U015_S002	150
		U015_S003	150
		U015_S004	150
D0744280	COVER:GUIDE PLATE:EXIT:UPPER	U015_S001	151
		U015_S002	151
		U015_S003	151
		U015_S004	151
D0744281	BRACKET:TORSION SPRING:PEEN	U015_S001	152
		U015_S002	152
		U015_S003	152
		U015_S004	152
D0744283	COVER:DRAWER:UPPER	U015_S001	153
		U015_S002	153
		U015_S003	153
		U015_S004	153
D0744284	GRIP:FUSING UNIT:REAR:FIBER	U015_S001	154
		U015_S002	154
		U015_S003	154
		U015_S004	154
D0744289	COVER:FUSING UNIT:FRONT:WINDOW	U015_S001	155
		U015_S002	155
		U015_S003	155
		U015_S004	155
D0744300	SPRING PLATE:CLEANING UNIT:FUSING	U015_S005	156
D0744303	FEELER:CLEANING	U015_S005	158
D0744304	SHAFT:WORM GEAR:SUB-ASS'Y	U015_S005	159
D0744308	BRACKET:FRONT:WEB	U015_S005	160
D0744309	BRACKET:FRONT:AUXILIARY	U015_S005	161
D0744310	BRACKET:REAR	U015_S005	162
D0744311	BRACKET:REAR:WEB	U015_S005	163

Number	Part Name	Group	ID
D0744314	BRACKET:REAR:PIN	U015_S005	164
D0744325	COVER:WEB:CLEANING FELT	U015_S005_S001	165
D0744350	BRACKET:DRAWER:FUSING SECTION:24	U015	167
D0744351	STEPPED SCREW:DIA5.4DIA:DIA3.5:M3	U015	168
		U022	33
D0744352	JOINT:GEAR:WEB:DRIVE	U015	169
D0744353	COVER:GEAR:JOINT	U015	170
D0744354	GEAR:SLOW DOWN:WORM GEAR	U015	171
D0744356	BRACKET:LEVER:WEB:DRIVE SUB-UNIT	U015	172
D0744364	BRACKET:WEB:CLEANING	U015	173
D0744371	GRIP:SLIDER:FUSING	U015	174
D0744372	BRACKET:WEB:PHOTOINTERRUPTOR:MAIN	U015	175
D0744380	DECAL:H-TEMP WARNING:FUSING:WEB	U015_S005_S001	176
D0744381	DECAL:FUSING UNIT:POSITIONING	U015_S001	177
		U015_S002	177
		U015_S003	177
		U015_S004	177
D0744391	HOLDER:KNOB:FUSING:DUAL FACES TEPE	U023	13
D0744399	DUCT:PRESSURE:CONNECTING:BACK	U015	179
D0744514	GATE:DUPLEX:EXIT:ASS'Y	U016	103
D0744519	COVER:HARNESS:SWITCHBACK:LEFT LOWER	U016	104
D0744528	BRACKET:SENSOR:EXIT:EXIT	U016	105
D0744529	COVER:PAPER EXIT SUB-UNIT:EXIT	U022	34
D0744541	DAMPING INSULATION:REVERSE:ADHESION	U016_S008	106
D0744549	DECAL:MISFEED REMOVAL:EXIT	U001	18
D0744550	GATE:REVERSE:EXIT:ASS'Y	U016	107
D0744551	DECAL:PULL OUT:LEFT:Z1	U001	19
D0744552	DECAL:PULL OUT:LEFT:Z3	U016_S014	108
D0744553	DECAL:PULL OUT:LEFT:D1	U001	20
D0744554	DECAL:PULL OUT:LEFT:D3	U016_S002	109

Exclusive Parts

Number	Part Name	Group	ID
D0744555	DECAL:PULL OUT:LEFT:D4	U016	110
D0744556	DECAL:PULL OUT:LEFT:D5	U016	111
D0744557	DECAL:H-TEMP WARNING:EXIT	U001	21
D0744559	DECAL:RECEIVING SUB-UNIT:E	U017	16
D0744564	BRACKET:REVERSE:SENSOR	U016	234
D0744567	SHAFT:LOCK:REVERSE	U016	112
D0744577	GATE PAWL:SWITCHBACK	U016	113
D0744581	BRACKET:LEVER:REVERSE	U016	114
D0744583	DC SOLENOID:REVERSE ROLLER: LINK	U016	115
D0744602	GUIDE:REVERSE	U016	116
D0744608	DC SOLENOID:GATE PAWL:EXIT:A SS'Y	U016_S005	117
D0744611	DC SOLENOID:GATE PAWL:SWITC HBACK:ASS'Y	U016_S009	118
D0744613	EXIT ROLLER:DRIVE:REVERSE:EX IT:PRESS FIT	U016	119
D0744626	DAMPING INSULATION:REVERSE: ENTRANCE:UPPER	U016_S011	121
D0744627	DAMPING INSULATION:REVERSE: ENTRANCE:LOWER	U016_S011	122
D0744628	DAMPING INSULATION:REVERSE: UPPER	U016_S008	123
D0744629	DAMPING INSULATION:DUPLEX:E NTRANCE	U016_S013	124
D0744631	DAMPING INSULATION:REVERSE: LOWER	U016_S008 U016_S011	126 126
D0744657	BRACKET:COUPLING:DC BRUSHL ESS MOTOR	U016	129
D0744665	SHAFT:DRIVE:COUPLING:EXIT	U016	130
D0744667	GUIDE:DUPLEX:ENTRANCE	U016	131
D0744682	PAPER EXIT SUB-UNIT:EXIT:MAIN	U016	133
D0744683	JOINT:EXIT:DRIVE	U013_S001 U016	206 134
D0744690	PIN:PLATE	U016	135
D0744693	PLATE:PIN:LEFT LOWER:PEEN	U016	136
D0744696	SHAFT:GRIP:GUIDE PLATE	U016	137
D0744698	LEVER:LOCK:GUIDE PLATE	U016	138

Number	Part Name	Group	ID
		U016_S002	138
D0744710	KNOB:TRANSPORT ROLLER:AUXI LIARY:PRESS FIT	U016	139
D0744802	HOLDER:PRESSURE ROLLER:DU PLEX:NO.2	U016	140
D0744806	PLATE:OPEN AND CLOSE:DUPLE X:RIGHT LOWER	U016	141
D0744813	GUIDE:DUPLEX:OPEN AND CLOS E:LOWER	U016	142
D0744817	PLATE:GUARD:DRAWER:DUPLEX	U016	143
D0744826	GRIP:DUPLEX:GUIDE PLATE:LEFT	U016_S014	144
D0744853	INNER COVER:RECEIVING SUB-U NIT:LEFT LOWER	U017	17
D0744854	INNER COVER:RECEIVING SUB-U NIT:LEFT LOWER:LED	U006	274
D0744857	GUIDE PLATE:RECEIVING SUB-UN IT:LEFT LOWER:LEFT	U017	18
D0744860	GUIDE PLATE:RECEIVING SUB-UN IT:LEFT LOWER:LOWER	U017	19
D0744865	BRACKET:SENSOR:RECEIVING S UB-UNIT:LEFT LOWER	U017	20
D0744871	GUIDE PLATE:TRANSPORT ROLL ER:DUPLEX:REVERSE	U017	21
D0744875	BRACKET:MOTOR:DUPLEX:REVE RSE	U017	23
D0744881	GUIDE PLATE:PRESSURE ROLLE R:DUPLEX:REVERSE	U017	24
D0744885	GUIDE PLATE:PRESSURE ROLLE R:DUPLEX:REVERSE:LEFT	U017	25
D0745101	SD-CARD:NICE:REGI2:ASS'Y	U020	125
D0745414	PCB:TCRU-IDB	U015_S001 U015_S002 U015_S003 U015_S004	180 180 180 180
D0745870	DUCT:AUXILIARY:POWER SUPPLY UNIT	U020	50
D0745916	SPRING PLATE:SAFETY SWITCH	U019	37
D0745917	ARM:SAFETY SWITCH	U019	38

Exclusive Parts

Number	Part Name	Group	ID
D0745920	BRACKET:MAIN SWITCH	U019	39
D0746066	ROLLER:DRIVEN:INTERMEDIATE TRANSFER:NO.2:ASS'Y	U009	85
D0746074	TENSION SPRING:SLEEVE:WIRE:INTERMEDIATE TRANSFER	U009	86
D0746075	GRIP:INTERMEDIATE TRANSFER:LEFT	U009	87
D0746076	DUCT:TM SENSOR:INTERMEDIATE TRANSFER	U009	88
D0746078	COMPRESSION SPRING:DRAWER:INTERMEDIATE TRANSFER	U022	35
D0746092	BRACKET:HEATER:INTERMEDIATE TRANSFER	U009	90
D0746097	THERMOSTAT:INTERMEDIATE TRANSFER	U009	91
D0746109	PLATE:BLADE:BELT CLEANING	U009	92
D0746121	BRACKET:SENSOR:ON-OFF:TRANSFER ROLLER	U009	93
D0746125	FEELER:ON-OFF:INTERMEDIATE TRANSFER:BLACK	U009	94
D0746130	SPRING PLATE:EARTH:INTERMEDIATE TRANSFER:ASS'Y	U009	95
D0746134	PLAIN SHAFT BEARING:INSULATE	U009	96
D0746142	CAM:INTERMEDIATE TRANSFER:BLACK	U009	97
D0746146	BRACKET:BIAS:INTERMEDIATE TRANSFER	U009	100
D0746147	TERMINAL:INTERMEDIATE TRANSFER	U009	101
D0746148	SHAFT:CAM:INTERMEDIATE TRANSFER:COLLAR	U009	102
D0746149	CAM:INTERMEDIATE TRANSFER:COLLAR	U009	103
D0746153	SLIDE RAIL:ON-OFF:INTERMEDIATE TRANSFER:FRONT:ASS'Y	U009	104
D0746155	SLIDE RAIL:ON-OFF:INTERMEDIATE TRANSFER:REAR:ASS'Y	U009	105
D0746156	TENSION SPRING:ON-OFF:SLIDE	U009	106

Number	Part Name	Group	ID
	RAIL		
D0746161	COVER:BIAS:INTERMEDIATE TRANSFER	U009	108
D0746162	TIMING PULLEY:CAM:ON-OFF:INTERMEDIATE TRANSFER	U009	109
D0746163	GEAR:TIMING PULLEY:IDLER:INTERMEDIATE TRANSFER	U009	110
D0746164	SYNCHRONOUS BELT:ON-OFF:INTERMEDIATE TRANSFER	U009	111
D0746165	PULLEY:ON-OFF:BELT TENSIONER	U009	112
D0746168	TIGHTENER:INTERMEDIATE TRANSFER:ASS'Y	U009	113
D0746169	ROLLER:FRONT:INTERMEDIATE TRANSFER:LEFT	U009	114
D0746170	COIL SPRING:PRESSURE:TIGHTENER	U009	115
D0746171	GUIDE PLATE:COIL SPRING:PRESSURE:TIGHTENER	U009	116
D0746172	COLLAR:ON-OFF:INTERMEDIATE TRANSFER	U009	117
D0746175	PLAIN SHAFT BEARING:SLIDE RAIL:ON-OFF	U009	118
D0746179	GEAR:IDLER:INTERMEDIATE TRANSFER:Z17:Z53	U009	119
D0746180	COMPRESSION SPRING:BIAS:INTERMEDIATE TRANSFER	U009	120
D0746197	TERMINAL:CONNECTING:BIAS:INTERMEDIATE TRANSFER	U009	121
D0746212	SEAL:TRANSFER ROLLER:REAR	U011_S001	47
D0746213	SEAL:TRANSFER ROLLER:FRONT	U011_S001	48
D0746216	SHUTTER:TONER OUTLET SUB-UNIT:SUB-ASS'Y	U011_S001	20
D0746219	COIL SPRING:SHUTTER:DISCHARGE USED TONER	U011_S001	21
D0746228	ELECTRODE PLATE:FRAME	U011_S001	22
D0746230	CASE:TERMINAL:SEPARATION:ASS'Y	U013_S001_S004	207

Exclusive Parts

Number	Part Name	Group	ID
D0746238	JOINT:TRANSFER:DRIVE	U013_S001	208
D0746240	SHAFT:CONTACT POINT:T/S UNIT	U013_S001	209
D0746241	DECAL:GRIP:TRANSFER/SEPARATION UNIT	U011_S001	23
D0746242	DECAL:LEVER:TRANSFER/SEPARATION UNIT:FRONT	U013_S001	210
D0746243	DECAL:LEVER:TRANSFER/SEPARATION UNIT:REAR	U013_S001	211
D0746255	BRUSH ROLLER:TRANSFER ROLLER:ASS'Y	U011_S001	24
D0746265	BLADE:TRANSFER ROLLER:ASS'Y	U011_S001	25
D0746270	HOLDER:BLADE:ASS'Y	U011_S001	26
D0746273	SEAL:HOLDER	U011_S001	27
D0746274	SEAL:HOLDER:UPPER	U011_S001	28
D0746276	PIN:POSITIONING PLATE:BLADE:TRANSFER ROLLER:ASS'Y	U011_S001	29
D0746279	COIL SPRING:BLADE:TRANSFER ROLLER	U011_S001	30
D0746280	GUIDE PLATE:ENTRANCE:TRANSFER ROLLER:ASS'Y	U011_S001	31
D0746291	COIL SPRING:COATING BAR	U011_S001	32
D0746294	TRANSPORT SCREW:TRANSFER ROLLER:ASS'Y	U011_S001	33
D0746311	GEAR:TRANSFER ROLLER	U011_S001	34
D0746312	GEAR:IDLER:TRANSFER ROLLER	U011_S001	35
D0746313	GEAR:IDLER:COLLECTION COIL	U011_S001	36
D0746314	GEAR:COLLECTION COIL	U011_S001	37
D0746315	GEAR:BRUSH:APPLY	U011_S001	38
D0746324	GEAR:DRIVE:TRANSFER/SEPARATION UNIT	U013_S001	212
D0746330	LEVER:PRESSURE:T/S UNIT:FRONT	U013_S001	213
D0746333	SHAFT:LEVER:PRESSURE:TRANSFER ROLLER	U013_S001	214
D0746334	COIL SPRING:PRESSURE:TRANSFER ROLLER	U009_S006	122
		U009_S007	122
		U013_S001	215
D0746335	SHAFT:CAM:TRANSFER/SEPARATION UNIT	U013_S001	216

Number	Part Name	Group	ID
	ION UNIT		
D0746336	CAM:TRANSFER/SEPARATION UNIT	U013_S001	217
D0746337	LEVER:PRESSURE:T/S UNIT:REAR	U013_S001	218
D0746338	PIN:LEVER:PRESSURE:TRANSFER ROLLER	U013_S001	219
D0746340	LINK:HANDLE	U013_S001	220
D0746343	LINK:HANDLE:MIDDLE	U013_S001	221
D0746349	BRACKET:SHAFT:CONTACT POINT:TRANSFER ROLLER	U013_S001	222
D0746379	ROLLER:TENSION:ASS'Y	U009_S001_S001	243
D0746397	COIL SPRING:TENSION:ROLLER	U009_S001	123
D0746410	GROUND PLATE:BELT CLEANING	U010_S001	12
D0746411	COIL SPRING:EARTH:BELT CLEANING	U010_S001	13
D0746413	SCRAPER:BRUSH:REMOVE PAPER DUST:ASS'Y	U010_S001_S001	14
D0746414	SCRAPER:BRUSH:REMOVE PAPER DUST	U010_S001_S001	15
D0746415	DUAL FACES TEPE:ENTRANCE SEAL:BELT CLEANING	U010_S001_S001	16
D0746416	SEAL:ENTRANCE SEAL:BELT CLEANING	U010_S001_S001	17
D0746417	SEAL:SCRAPER	U010_S001_S001	18
D0746420	BRUSH:REMOVE PAPER DUST:BELT CLEANING	U010_S001	19
D0746424	BLADE:CLEANING:BELT CLEANING:ASS'Y	U010_S001	20
D0746428	HOLDER:CLEANING:BELT CLEANING:ASS'Y	U010_S001	21
D0746431	COIL SPRING:BLADE:CLEANING:BELT CLEANING	U010_S001	22
D0746434	TONER COLLECTION COIL:BELT CLEANING:ASS'Y	U010_S001	23
D0746439	PLAIN SHAFT BEARING:REMOVE PAPER DUST:TRANSPORT SCREW	U010_S001	24
D0746440	GUIDE:DISCHARGE USED TONER:	U010_S001	25

Exclusive Parts

Number	Part Name	Group	ID
	BELT CLEANING		
D0746441	SHUTTER:TRANSPORT SCREW:BELT CLEANING	U010_S001	26
D0746442	COIL SPRING:DISCHARGE USED TONER	U010_S001	27
D0746443	SEAL:DISCHARGE USED TONER	U010_S001	28
D0746446	BRUSH:APPLY:BELT CLEANING	U010_S001	29
D0746450	COATING BAR:ASS'Y	U010_S001_S002	30
D0746454	ARM:COATING BAR:BELT CLEANING	U010_S001_S002	31
D0746455	COIL SPRING:COATING BAR	U010_S001_S002	32
D0746457	BLADE:APPLY:ASS'Y	U010_S001	33
D0746461	HOLDER:APPLY:BELT CLEANING:ASS'Y	U010_S001	34
D0746464	COIL SPRING:BLADE:APPLY:BELT CLEANING	U010_S001	35
D0746467	COIL SPRING:STOPPER:CASE:BELT CLEANING	U010_S001	36
D0746468	STOPPER:CASE:BELT CLEANING	U010_S001	37
D0746469	SLIDE RAIL:UPPER:BELT CLEANING	U010_S001	38
D0746470	RELEASE PLATE:BLADE:CLEANING	U010_S001	39
D0746471	RELEASE PLATE:BLADE:APPLY	U010_S001	40
D0746477	GEAR:BRUSH:REMOVE PAPER DUST:Z17	U010_S001	41
D0746478	GEAR:PULLEY:IDLER:BELT CLEANING	U010_S001	42
D0746479	GEAR:COLLECT:COIL:Z19	U010_S001	43
D0746480	PULLEY:BRUSH:APPLY:Z30	U010_S001	44
D0746481	JOINT:BRUSH:REMOVE PAPER DUST:BELT CLEANING	U010_S001	45
D0746485	SEAL:CASE:BRUSH:FRONT	U010_S001	46
D0746486	SEAL:CASE:BRUSH:REAR	U010_S001	47
D0746488	SEAL:HOLDER:BEHIND:BELT CLEANING	U010_S001	48
D0746489	VIBRATING PLATE:TRANSPORT SCREW:BELT CLEANING	U010_S001	49

Number	Part Name	Group	ID
D0746490	SEAL:BASE:CASE:BELT CLEANING	U010_S001	50
D0746491	SEAL:CASE:CLEANING BLADE:FRONT	U010_S001	51
D0746492	SEAL:CASE:CLEANING BLADE:REAR	U010_S001	52
D0746495	LEVER:RELEASE:BLADE	U010_S001	53
D0746496	GRIP:BELT CLEANING	U010_S001	54
D0746497	DECAL:POSITIONING DISPLAY:TCRU	U006_S001	275
		U006_S002	275
		U006_S003	275
		U006_S004	275
		U007_S023	76
		U010_S001	55
		U013_S001	223
D0746511	PLAIN SHAFT BEARING:TONER RECYCLING SUB-UNIT	U012_S001	24
		U012_S004	24
		U012_S005	24
D0746512	GEAR:Z35:TRANSPORT SCREW:PCU:MAIN	U012_S005	25
D0746514	SEAL:TONER OUTLET SUB-UNIT:PCU	U012_S005	26
D0746517	STEEL BALL:TONER OUTLET SUB-UNIT	U012_S001	27
		U012_S005	27
D0746520	COVER:DISCHARGE USED TONER:DEVELOPMENT	U012	28
D0746531	TONER OUTLET SUB-UNIT:BELT CLEANING:MAIN:ASS'Y	U012_S001	29
D0746534	TRANSPORT SCREW:BELT CLEANING:MAIN:ASS'Y	U012_S001	30
D0746539	GEAR:Z29:TRANSPORT SCREW:BELT CLEANING	U012_S001	31
D0746540	SEAL:BELT CLEANING:MAIN	U012_S001	32
D0746541	SEAL:RING:TONER OUTLET SUB-UNIT:BELT CLEANING	U012_S001	33
D0746551	TONER OUTLET SUB-UNIT:VERTICAL TRANSPORT:ASS'Y	U012_S002	34
D0746564	TONER OUTLET SUB-UNIT:T/S UNIT	U012_S002	35

Exclusive Parts

Number	Part Name	Group	ID
	T:SHUTTER:OUTER		
D0746565	TONER OUTLET SUB-UNIT:T/S UNIT:SHUTTER:INNER	U012_S002	36
D0746566	SEAL:VERTICAL TRANSPORT:LOWER	U012_S002	37
D0746567	SEAL:VERTICAL TRANSPORT:UPPER	U012_S002	38
D0746572	BRACKET:VERTICAL TRANSPORT:ASS'Y	U012_S003	39
D0746574	COVER:CAM:VERTICAL TRANSPORT	U012	40
D0746575	SHAFT:CAM:VERTICAL TRANSPORT	U012	41
D0746577	CAM:VERTICAL TRANSPORT:DIA15	U012	42
D0746578	GEAR:Z37:CAM:VERTICAL TRANSPORT	U012	43
D0746579	SEAL:COVER:CAM:VERTICAL TRANSPORT	U012	44
D0746585	GEAR:Z38/Z24:VERTICAL TRANSPORT	U012	45
D0746586	GEAR:Z35:IDLER:VERTICAL TRANSPORT	U012	46
D0746590	COLLECTION BOTTLE:ASS'Y	U012_S007	47
D0746601	TONER OUTLET SUB-UNIT:LOWER:ASS'Y	U012_S004	48
D0746604	TRANSPORT SCREW:TONER OUTLET SUB-UNIT:LOWER:ASS'Y	U012_S004	49
D0746609	GEAR:Z23:TRANSPORT SCREW:LOWER	U012_S004	50
D0746610	SEAL:RING:TONER OUTLET SUB-UNIT:LOWER	U012_S004	51
D0746626	INNER COVER:TONER RECYCLING SUB-UNIT	U012	52
D0746627	COLLECTION BOTTLE:SMALL:ASS'Y	U012_S006	53
D0746629	COVER:COLLECTION BOTTLE:SMALL	U012_S006	54

Number	Part Name	Group	ID
D0746630	PIPE:COLLECTION BOTTLE:SMALL	U012_S006	55
D0746631	SHUTTER:TONER RECYCLING SUB-UNIT:SMALL	U012_S006	56
D0746632	COMPRESSION SPRING:SHUTTER:SMALL	U012_S006	57
D0746633	COVER:BEARING:SMALL	U012_S006	58
D0746634	AGITATOR:SMALL	U012_S006	59
D0746635	TRANSPORT SCREW:SMALL:ASS'Y	U012_S006	60
D0746640	PLAIN SHAFT BEARING:TRANSPORT SCREW:SMALL	U012_S006	61
D0746641	PLAIN SHAFT BEARING:SMALL:GEAR	U012_S006	62
D0746642	PLAIN SHAFT BEARING:SMALL	U012_S006	63
D0746643	GEAR:TRANSPORT SCREW:COLLECTION BOTTLE:SMALL:Z31	U012_S006	64
D0746644	GEAR:AGITATOR:COLLECTION BOTTLE:SMALL:Z49/Z41	U012_S006	65
D0746645	GEAR:AGITATOR:COLLECTION BOTTLE:SMALL:Z41	U012_S006	66
D0746646	SEAL:TONER RECYCLING SUB-UNIT:SMALL	U012_S006	67
D0746647	BRACKET:PUSH SWITCH	U012	68
D0746648	LINK:PUSH SWITCH:TONER RECYCLING SUB-UNIT	U012	69
D0746659	SHAFT:JOINT:COLLECTION BOTTLE:ASS'Y	U012	70
D0746663	TORQUE LIMITER MECHANICAL CLUTCH:GEAR:Z63	U012	71
D0746664	GEAR:IDLER:Z49/Z27	U012	72
D0746665	GEAR:JOINT:COLLECTION BOTTLE:Z65	U012	73
D0746666	GEAR:IDLER:Z37/Z28	U012	74
D0746667	HOLDER:RADIAL BALL BEARING:JOINT	U012	75
D0746668	SEAL:PIPE:TONER RECYCLING SUB-UNIT:SMALL	U012_S006	76

Exclusive Parts

Number	Part Name	Group	ID
D0746669	SPRING PLATE:PUSH SWITCH	U012	77
D0746684	SEAL:TANK:USED TONER:COLLECT	U012_S007	78
D0746709	BASE:ARM:OPERATION SUB-UNIT	U002	79
D0746711	FRAME:ARM:OPERATION SUB-UNIT:INNER	U002	21
D0746712	GUIDE PLATE:ARM:OPERATION SUB-UNIT	U002	22
D0746713	FRAME:ARM:OPERATION SUB-UNIT:OUTER	U002	23
D0746714	GUIDE PLATE:HINGE:OPERATION SUB-UNIT:LOWER	U002	24
D0746715	SUPPORTING PLATE:GUIDE PLATE:HINGE	U002	25
D0746717	BRACKET:COVER:ARM:RIGHT	U002	27
D0746718	HINGE:ARM:OPERATION SUB-UNIT:LOWER	U002	28
D0746719	FRAME:ARM:OPERATION SUB-UNIT:FRONT	U002	29
D0746721	GUIDE PLATE:HINGE:OPERATION SUB-UNIT:UPPER	U002	30
D0746722	HINGE:ARM:OPERATION SUB-UNIT:UPPER	U002	31
D0746723	GUIDE PLATE:OPERATION PANEL	U002	32
D0746724	BRACKET:COVER:ARM:FRONT	U002	33
D0746725	BRACKET:COVER:ARM:FRONT LOWER	U002	34
D0746726	SUPPORTING PLATE:COVER:ARM:INNER	U002	35
D0746727	COVER:HARNESS:OPERATION PANEL	U023	14
D0746728	COVER:ARM:OPERATION SUB-UNIT:RIGHT	U023	15
D0746729	COVER:ARM:OPERATION SUB-UNIT:INNER	U002	36
D0746730	COVER:ARM:OPERATION SUB-UNIT:RIGHT LOWER	U002	37
D0746731	COVER:ARM:OPERATION SUB-UNIT	U002	38

Number	Part Name	Group	ID
	IT:LEFT		
D0746732	COVER:ARM:OPERATION SUB-UNIT:LEFT LOWER	U002	39
D0746733	COVER:ARM:OPERATION SUB-UNIT:FRONT	U002	40
D0746734	COVER:OPERATION PANEL:REAR	U023	16
D0746735	COVER:OPERATION PANEL:REAR UPPER	U023	24
D0746736	COVER:ARM:OPERATION SUB-UNIT:FRONT LOWER	U002	41
D0746738	CAP:COVER:ARM:RIGHT	U023	17
D0746739	HOLDER:HINGE:OPERATION SUB-UNIT:UPPER	U002	43
D0746932	DUCT:HEAT PIPE:FUSING:UPPER	U021	38
D0746933	SEAL:DUCT:HEAT PIPE:FUSING:UPPER	U021	39
D0746935	SEAL:DUCT:HEAT PIPE:FUSING	U021	41
D0746938	DUCT:CONNECTING:COOLING:FUSING EXIT	U021	42
D0746939	SEAL:DUCT:CONNECTING:COOLING:FUSING EXIT	U021	43
D0746940	DUCT:UPPER:HEAT SINKER	U021	44
D0746943	SEAL:LONG:DUCT:HEAT SINKER	U021	47
D0746944	SHEET:C/T BOX:LIQUID COOLING:UPPER	U020	51
D0746945	SHEET:C/T BOX:LIQUID COOLING:LOWER	U020	52
D0746962	DUCT:UPPER:EXHAUST:HEAT SINKER	U021	48
D0746963	DUCT:LOWER:EXHAUST:HEAT SINKER	U021	49
D0746964	BRACKET:FAN:DUCT:EXHAUST:HEAT SINKER	U021	50
D0746965	BRACKET:DUCT:EXHAUST:HEAT SINKER	U021	51
D0746967	DUCT:UPPER:FUSING:EXIT	U021	52
D0746968	DUCT:LOWER:FUSING:EXIT	U021	53
D0746969	SEAL:LONG:DUCT:FUSING:EXIT	U021	54

Exclusive Parts

Number	Part Name	Group	ID
D0746970	SEAL:SHORT:DUCT:FUSING:EXIT	U021	55
D0746972	SEAL:DUCT:EXHAUST:HEAT SINK ER	U021	56
D0746974	CAP:LOUVER:MM90	U020_S002	53
D0746975	FILTER:POWER SUPPLY UNIT:MM 90	U020_S002	54
D0746977	DUCT:RIGHT:EXIT:EXHAUST	U021	57
D0746978	DUCT:LEFT:EXIT:EXHAUST	U021	58
D0746979	SEAL:DUCT:EXIT:CONNECTING	U021	59
D0746987	DUCT:UPPER:FUSING:EXIT:EXHA UST	U021	60
D0746988	DUCT:LOWER:FUSING:EXIT:EXHA UST	U021	61
D0746995	SEAL:DUCT:HEAT PIPE:ROLLER:V ACUUM	U021	62
D0746998	DUCT:VACUUM:HEAT PIPE:ROLLE R	U021	63
D0747012	DUCT:UPPER:EXHAUST:DEVELOP MENT UNIT	U021	64
D0747013	DUCT:LOWER:EXHAUST:DEVELO PMENT UNIT	U021	65
D0747014	SEAL:VACUUM:DUCT:EXHAUST:D EVELOPMENT UNIT	U021	66
D0747015	SEAL:EXIT:DUCT:EXHAUST:DEVE LOPMENT UNIT	U021	67
D0747017	DUCT:CONNECTING:EXHAUST:DE VELOPMENT UNIT	U021	68
D0747028	SEAL:CONNECTING:ENTRANCE	U021	69
D0747042	DUCT:FRONT:EXIT:COOLING:FUSI NG	U021	70
D0747043	DUCT:REAR:EXIT:COOLING:FUSIN G	U021	71
D0747045	SEAL:EXIT:SIROCCO	U021	72
D0747077	DUCT:FRONT:COOLING:PRESSUR E ROLLER:PULL OUT	U021	73
D0747078	DUCT:INNER BACK:COOLING:PRE SSURE ROLLER:PULL OUT	U021	74
D0747080	SEAL:DUCT:COOLING:PRESSURE	U021	75

Number	Part Name	Group	ID
	ROLLER:PULL OUT		
D0747082	DUCT:RIGHT:COOLING:INTERMED IATE TRANSFER:PULL OUT	U021	76
D0747083	DUCT:LEFT:COOLING:INTERMEDI ATE TRANSFER:PULL OUT	U021	77
D0747086	SEAL:VACUUM:COOLING:INTERM EDIATE TRANSFER:PULL OUT	U021	78
D0747087	SEAL:DC FAN MOTOR:SIROCCO	U021	79
D0747089	SEAL:JOINT:DUCT:COOLING:PRE SSURE ROLLER	U021	80
D0747090	SEAL:VACUUM:POSITIONING SEN SOR	U021	81
D0747095	SEAL:CONNECTING:ABSORB DUS T SUB-UNIT:FAN:ENTRANCE	U021	82
D0747102	SEAL:LOWER:DUCT:CONNECTING :DEVELOPMENT UNIT	U021	83
D0747103	SEAL:UPPER:DUCT:CONNECTING :DEVELOPMENT UNIT	U021	84
D0747104	BRACKET:FAN:DUCT:EXHAUST:C/ T BOX	U020	55
D0747107	SEAL:LOWER:DUCT:EXHAUST:C/T BOX	U020	56
D0747109	SEAL:EXIT:EXHAUST:DUCT:C/T B OX	U020	57
D0747111	FILTER:PREVENTFENCE	U020	58
D0747114	BRACKET:FAN:DUCT:EXHAUST:C/ T BOX	U020	59
D0747115	COVER:DUCT:EXHAUST:C/T BOX	U020	60
D0747116	SEAL:COVER:DUCT:EXHAUST:C/T BOX	U020	61
D0747118	DUCT:INNER BACK:COOLING:POS ITIONING SENSOR	U021	85
D0747119	DUCT:FRONT:COOLING:POSITION ING SENSOR	U021	86
D0747120	BRACKET:DUCT:COOLING:POSITI ONING SENSOR	U021	136
D0747122	DUCT:FRONT:OZONE UNIT:C/T BO X	U020	62

Exclusive Parts

Number	Part Name	Group	ID
D0747123	DUCT:REAR:OZONE UNIT:C/T BOX	U020	63
D0747124	BRACKET:FAN:DUCT:OZONE FILTER:C/T BOX	U020	64
D0747125	COVER:DUCT:OZONE UNIT:C/T BOX	U020	65
D0747126	SEAL:COVER:DUCT:OZONE UNIT:C/T BOX	U020	66
D0747128	SEAL:LOWER:DUCT:OZONE FILTER:C/T BOX	U020	67
D0747130	SEAL:EXIT:DUCT:OZONE FILTER:C/T BOX	U020	69
D0747170	SEAL:EXIT:MIDDLE:DUCT:C/T BOX	U020	70
D0747174	SEAL:DUCT:EXIT	U020_S001	71
D0747189	DUCT:FRONT:EXHAUST:C/T BOX	U020	72
D0747190	DUCT:REAR:EXHAUST:C/T BOX	U020	73
D0747191	BRACKET:UPPER:DUCT:EXHAUST:C/T BOX	U020	74
D0747192	BRACKET:MIDDLE:DUCT:EXHAUST:C/T BOX	U020	75
D0747193	BRACKET:LOWER:DUCT:EXHAUST:C/T BOX	U020	76
D0747194	BRACKET:DUCT:EXHAUST:C/T BOX	U020	77
D0747195	SEAL:DUCT:C/T BOX:MIDDLE UPPER	U020	78
D0747197	SEAL:DUCT:C/T BOX:MIDDLE SIDWAYS	U020	79
D0747198	SEAL:DUCT:C/T BOX:MIDDLE LOWER	U020	80
D0747207	SHEET:C/T BOX:LIQUID COOLING:WINDOW	U020	81
D0747275	DUCT:FAN:LIQUID COOLING	U020_S004	82
D0747326	SLIDE RAIL:RIGHT:NO.2:ASS'Y	U006	276
D0747330	SLIDE RAIL:LEFT:NO.1	U006	277
D0747331	STAY:SLIDE RAIL:LEFT INNER REAR:NO.1:PEEN	U006	278
D0747333	STAY:SLIDE RAIL:LEFT FRONT:NO.1	U006	279

Number	Part Name	Group	ID
D0747335	STAY:SLIDE RAIL:LEFT:NO.2	U006	280
D0747349	COMPRESSION SPRING:BRACKET:SENSOR:PAPER SIZE SENSOR	U006	281
D0747367	BRACKET:STOPPER:TANDEM LCT	U006	282
D0747381	DECAL:VERTICAL TRANSPORT:A1	U006	283
D0747382	DECAL:VERTICAL TRANSPORT:A2	U006	284
D0747383	DECAL:VERTICAL TRANSPORT:A3	U006	285
D0747384	DECAL:VERTICAL TRANSPORT:B2	U006	286
D0747385	DECAL:CAUTION CHART:TANDEM LCT	U006_S001	287
		U006_S002	287
		U006_S003	287
		U006_S004	287
D0747388	DECAL:PAPER SET DIRECTION:TANDEM LCT:RIGHT	U006_S001	288
		U006_S002	288
		U006_S003	288
		U006_S004	288
D0747389	DECAL:PAPER SET DIRECTION:TANDEM LCT:LEFT	U006_S005	289
		U006_S006	289
		U006_S007	289
		U006_S008	289
D0747390	DECAL:PAPER SET DIRECTION:PAPER TRAY	U006_S009	290
D0747391	DECAL:PAPER SET DIRECTION	U023	18
D0747392	DECAL:PAPER TRAY:NO.1	U006	291
D0747393	DECAL:PAPER TRAY:NO.2	U006	292
D0747431	STAY:HANDLE:ASS'Y	U006	293
D0747433	STUD:HANDLE:RELEASE:ASS'Y	U006	294
D0747446	BRACKET:DC STEPPER MOTOR:TRANSPORT UNIT	U006	295
D0747450	GUIDE PLATE:VERTICAL TRANSPORT:DRIVE	U006	296
D0747455	GUIDE PLATE:GRIP:UPPER	U006	297
D0747461	GUIDE PLATE:GRIP:LOWER	U006	298
D0747470	GUIDE PLATE:CONNECTING:UPPER	U006	299
D0747474	GUIDE PLATE:CONNECTING:RIGHT	U006	300
D0747476	GUIDE PLATE:OPEN AND CLOSE:	U006	301

Exclusive Parts

Number	Part Name	Group	ID
	ASS'Y		
D0747481	GUIDE PLATE:OPEN AND CLOSE:CONNECTING:ASS'Y	U006	302
D0747521	GUIDE PLATE:UPPER:PAPER FEE D UNIT	U006_S018	303
		U006_S019	303
D0747522	GUIDE PLATE:LOWER:PAPER FEE D UNIT	U006_S018	304
		U006_S019	304
D0747527	SHAFT:FEED:ASS'Y	U006_S018_S001	305
		U006_S019_S001	305
D0747540	(-AA,-EU):TANDEM LCT:RIGHT:ASS'Y	U006_S001	306
		U006_S002	306
D0747541	(-NA):TANDEM LCT:RIGHT:ASS'Y	U006_S003	307
D0747542	(-CHN):TANDEM LCT:RIGHT:ASS'Y	U006_S004	308
D0747551	COVER:PAPER TRAY:NO.1	U006	309
D0747558	COVER:GRIP:INNER BACK	U006	310
D0747561	GRIP:UPPER	U006	311
D0747562	GRIP:LOWER	U006	312
D0747565	STAY:COVER:PAPER TRAY	U006	313
D0747566	BRACKET:ARM:LINK	U006	314
D0747567	BRACKET:ARM:LINK:LEFT	U006	315
D0747568	BRACKET:FIX:AUXILIARY:COVER	U006	316
D0747570	BASE:LINK:PAPER TRAY:ASS'Y	U006	317
D0747573	BRACKET:ARM:PLATE	U006	318
D0747575	LINK:UPPER LOWER:LEFT:ASS'Y	U006	319
D0747577	LINK:UPPER LOWER:ASS'Y	U006	320
D0747579	STOPPER:TANDEM LCT	U006	321
D0747595	(-AA,-NA,-EU):BASE:TANDEM LCT:RIGHT:ADHESION	U006_S001	322
		U006_S002	322
		U006_S003	322
D0747596	(-AA,-NA,-EU):TRAY BOTTOM PLATE:LEFT MIDDLE:ASS'Y	U006_S005	323
		U006_S006	323
		U006_S007	323
D0747601	COVER:PAPER TRAY:NO.2	U006	324
D0747603	PLATE:GRIP:PAPER TRAY:NO.2	U006	325
D0747606	GRIP:PAPER TRAY:NO.2	U006	326
D0747607	ARM:PAPER TRAY:GRIP	U006	327
D0747609	PROTECTION:COVER:LED	U006	328
D0747654	INNER COVER:VERTICAL TRANSP	U006	329

Number	Part Name	Group	ID
	ORT:LEFT		
D0747659	COVER:FUNNEL:DEVELOPER	U006	331
D0747680	HEAT SINK:HEATER:LOWER:ASS'Y	U006_S010	332
D0747681	HEAT SINK:HEATER:UPPER:ASS'Y	U006_S011	333
D0747684	HEAT SINK:HEATER:UPPER:FIBER	U006_S011	334
D0747690	BRUSH:BLOWER	SPECIAL TOOLS	9
D0747752	CAP:COVER:TONER SUPPLY	U001	22
		U020	83
D0747762	BRACKET:HINGE:TONER SUPPLY	U001	24
D0747775	(-NA,-CHN):PLATE:LOGO:RICOH	U023	19
D0747780	DOOR:FRONT LEFT:UPPER:ASS'Y	U001_S002	25
D0747787	HINGE:DOOR:COLLECTION BOTTLE:ASS'Y	U001	27
D0747791	DOOR:COLLECTION BOTTLE:ASS'Y	U001_S003	28
D0747793	GRIP:DOOR:COLLECTION BOTTLE	U001_S003	29
D0747794	LEVER:RELEASE:DOOR:COLLECTION BOTTLE	U001_S003	30
D0747795	SHAFT:CONTACT POINT:GRIP	U001_S003	31
D0747797	SPRING PLATE:DOOR:LEFT LOWER	U001	32
D0747810	DOOR:FRONT RIGHT:UPPER:ASS'Y	U001_S005	33
D0747814	DOOR:FRONT RIGHT:LOWER	U001	34
D0747828	(D194-NA,CHN,AA):(D195/D203/D204):CAP:CONNECTOR	U001_S008	35
D0747829	(D194-NA,CHN,AA):(D195/D203/D204):CAP:JOINT:LARGE CAPACITY TRAY	U001_S008	36
D0747830	(D194-NA,CHN,AA):(D195/D203/D204):COVER:LARGE CAPACITY TRAY	U001_S008	37
D0747831	COVER:CONNECTOR:LARGE CAPACITY TRAY	U001_S007	38
		U001_S008	38
D0747835	DECAL:MISFEED REMOVAL:LOCATION	U001_S006	39
D0747836	DECAL:MISFEED REMOVAL:AB	U001_S006	40

Exclusive Parts

Number	Part Name	Group	ID
D0747838	DECAL:MISFEED REMOVAL:Z-1	U001_S004	42
D0747839	DECAL:MISFEED REMOVAL:Z-2	U001_S004	43
D0747843	INNER COVER:PULL OUT:LEFT	U001	44
D0747847	(-AA,-NA):DECAL:CAUTION CHART :INKJET:PAPER	U023	20
D0747848	DECAL:PULL OUT:LEFT:FUSING U NIT:SET	U001	45
D0747849	DECAL:PULL OUT:LEFT:FUSING U NIT:TCRU	U001	46
D0747850	HINGE:LEFT UPPER:ASS'Y	U001	47
D0747854	HINGE:LEFT LOWER:ASS'Y	U001	48
D0747858	HINGE:RIGHT UPPER:ASS'Y	U001	49
D0747861	HINGE:RIGHT LOWER:ASS'Y	U001	50
D0747883	(-CHN):DECAL:CAUTION CHART:IN KJET:PAPER	U023	21
D0749548	DG CLEANER 5PCS/SET	SPECIAL TOOLS	10
D0749549	JIG:OPC SET	SPECIAL TOOLS	11
D0894252	GUIDE:FUSING EXIT:PFA	U015_S001_S002	264
		U015_S001_S003	264
		U015_S002_S002	264
		U015_S002_S003	264
		U015_S003_S002	264
		U015_S003_S003	264
		U015_S004_S002	264
		U015_S004_S003	264
D0894366	COVER:THERMISTOR:LENS	U021	87
D0935309	COVER:SD-CARD	U020	84
D0951260	CAP:COVER:SCA	U003_S001	86
D0951788	KEYTOP:TRY PRINT	U002_S001	44
		U002_S002	44
		U002_S003	44
		U002_S004	44
D0951789	KEYTOP:STOP	U002_S001	45
		U002_S002	45
		U002_S003	45
		U002_S004	45
D0951790	KEYTOP:INTERRUPT	U002_S001	46
		U002_S002	46

Number	Part Name	Group	ID
		U002_S003	46
		U002_S004	46
D0A46099	SHEET:PRESSURE PLATE:SMALL	U003_S001_S011	269
D0A50641	BELT CLEANING:ASS'Y	U010_S001	63
D0A51160	SHEET:TONER SUPPLY:OPERATI ON SUB-UNIT	U007_S022	166
D0A51164	COVER:TONER SUPPLY	U022	58
D0A51431	SHAFT:DRIVE:DEVELOPMENT SL EEVE:ASS'Y	U018_S008_S003	121
		U018_S009_S003	121
		U018_S010_S002	121
		U018_S011_S002	121
		U018_S012_S002	121
D0A51467	GEAR:DRIVE:130Z	U009	230
D0A52279	BASE:ELECTRIC POTENTIAL SEN SOR	U019	69
D0A52592	DECAL:PCDU_HOPPER:W	U008	132
D0A52593	DECAL:PCDU_HOPPER:CLR	U008	133
D0A52595	DECAL:PCDU_HOPPER:NEON-Y	U008	134
D0A52596	DECAL:PCDU_HOPPER:NEON-P	U008	135
D0A52597	DECAL:PCDU_HOPPER:IV-R	U008	136
D0A52598	(CHN):DECAL:PCDU_HOPPER:CU- R	U008	137
D0A52815	BRACKET:CONTACT POINT:GUID E PLATE:REAR:PEEN	U013_S001	285
D0A52940	HOLDER:ELECTRICAL COMPONE NTS SECTION:ASS'Y	U013_S001	290
D0A53456	SEAL:DEVELOPMENT ROLLER:FR ONT:2	U008_S008	142
		U008_S011	142
		U008_S014	142
		U008_S017	142
		U008_S020	142
D0A53457	SEAL:DEVELOPMENT ROLLER:FR ONT:1	U008_S008	143
		U008_S011	143
		U008_S014	143
		U008_S017	143
		U008_S020	143
D0A53588	BRACKET:RACK:STOPPER	U007_S013	169
		U007_S015	169

Exclusive Parts

Number	Part Name	Group	ID
		U007_S017	169
		U007_S019	169
D0A53710	SEAL:REAR:SLIDER:TONER BANK:T6	U007_S013	173
		U007_S015	173
		U007_S017	173
		U007_S019	173
D0A53760	(D194/D195):INNER COVER:DUMMY:5ST:TONER SUPPLY:ASS'Y	U007_S026	167
D0A53857	BRACKET:SENSOR:VACUUM	U014_S001	27
D0A53994	LEVER:PAPER EXIT UNIT:REAR	U015_S001	255
		U015_S002	255
		U015_S003	255
		U015_S004	255
D0A53995	JOINT:KNOB:FUSING	U015_S001	257
		U015_S002	257
		U015_S003	257
		U015_S004	257
D0A54090	BRACKET:PHOTOINTERRUPTOR:FRONT	U015_S001	272
		U015_S002	272
		U015_S003	272
		U015_S004	272
D0A54647	LINK:REVERSE ROLLER:ASS'Y	U016_S010	233
D0A54872	BRACKET:TRANSPORT ROLLER:DUPLIX:REVERSE:RIGHT	U017	31
D0A55911	BRACKET:NOISE FILTER	U019	63
D0A55928	COVER:LEAK BREAKER	U019	64
D0A56044	BRACKET:INTERMEDIATE TRANSFER:FRONT	U009	235
D0A56045	BRACKET:INTERMEDIATE TRANSFER:REAR	U009	236
D0A56050	FLAT BELT-TRANSFER:ASS'Y	U009	234
D0A56187	COVER:INTERMEDIATE TRANSFER:ASS'Y	U009	232
D0A56200	TRANSFER/SEPARATION UNIT:ASS'Y	U011_S001	45
D0A56252	TRANSFER ROLLER:18MIC	U011_S001	46
D0A56934	DUCT:HEAT PIPE:FUSING:LOWER	U021	137
D0A56941	DUCT:LOWER:HEAT SINKER	U021	139

Number	Part Name	Group	ID
D0A56942	SEAL:SHORT:DUCT:HEAT SINKER	U021	140
D0A57124	DUCT:PCU:FRONT:4ST:ASS'Y	U021_S001	142
		U021_S002	142
		U021_S003	142
		U021_S004	142
D0A57129	DUCT:PCU:FRONT:5ST:ASS'Y	U021	143
D0A57144	SIDE FENCE:TANDEM LCT:LEFT REAR:ASS'Y	U006_S005_S001	373
		U006_S006_S001	373
		U006_S007_S001	373
		U006_S008_S001	373
D0A57259	DOOR:FRONT LEFT:LOWER	U001	69
D0A57285	SHEET:GUIDE PLATE:SLIDE RAIL:PCU	U008	129
D0A57797	SD-CARD:SP:BATCH:TOOL:ASS'Y	SPECIAL TOOLS	21
D0A57826	(D194-NA,CHN,AA):(D195/D203/D204):COVER:MAIN:RIGHT:ASS'Y	U001_S008	70
D0A59695	(D203/D204):DEVELOPER WHITE	U008	144
D0A59705	DEVELOPER NEON YELLOW	U008	138
D0A59715	(D203/D204):DEVELOPER NEON-PINK	U008	140
D0A59725	DEVELOPER INVISIBLE-RED	U008	139
D0A59735	(D203/D204):DEVELOPER CLEAR	U008	141
D0AL3502	(D203/D204):HOLDER:FRONT:TONER BOTTLE:5ST	U007_S024	161
D0AL3503	(D203/D204):BRACKET:HOLDER:FRONT:TONER BOTTLE	U007_S024	168
D0BX1594	HOLDER:HINGE:OPERATION SUB-UNIT:LOWER	U002	81
D0BX2679	HOLDER:DC STEPPER MOTOR:SHIFT	U013_S001	296
D0BX6780	TRAY BOTTOM PLATE:ASS'Y	U006_S009	370
D0BX7631	PAPER TRAY:UNIVERSAL:SUB-ASS'Y	U006_S009	372
D0CQ5100	SD-CARD:NICE:APPLICATION:ASS'Y	U019	68
D0EZ6646	INNER COVER:TANDEM LCT:LEFT	U006_S005	376
		U006_S006	376
		U006_S007	376

Exclusive Parts

Number	Part Name	Group	ID
		U006_S008	376
D1294331	FLAT NUT: BRAKE	U015_S005	181
D1316511	BRACKET: CONNECTOR: LEFT	U006	173
D1316775	SIDE FENCE: REAR: ASS'Y	U006_S009_S001	335
D1316777	SIDE FENCE: FRONT: ASS'Y	U006_S009_S002	336
D1361687	GROUND PLATE: SENSOR: AKS	U022	37
D1361715	GUIDE: HARNESS: LED	U004	24
D1361717	COVER: SHAFT: SCANNER	U004	25
D1361727	INNER COVER: SCANNER	U004	26
D1361751	CARRIAGE: NO.1: ASS'Y	U004_S002	28
D1361758	CLAMP: WIRE	U004	29
D1361759	GUIDE: FFC: CARRIAGE: NO.1	U004	30
D1361760	REFLECTOR: SCANNER	U004	31
D1361776	CARRIAGE: NO.2: ASS'Y	U004_S004	32
D1361784	MIRROR: NO.2: ASS'Y	U004_S004	33
D1361785	MIRROR: NO.3: ASS'Y	U004_S004	34
D1361787	GUIDE: FFC: CARRIAGE: NO.2	U004	35
D1361788	PULLEY: IDLER: CARRIAGE	U004	36
D1361793	DC STEPPER MOTOR: MM42	U004	37
D1361794	BRACKET: DC STEPPER MOTOR: TENSION	U004	38
D1361798	TENSION SPRING: TENSION: 16N	U004	39
D1361799	BRACKET: DC STEPPER MOTOR	U004	40
D1361801	SHAFT: DRIVE: SCANNER	U004	41
D1361802	TIMING PULLEY: 65	U004	42
D1361803	SYNCHRONOUS BELT: 157ST1.5-6.0	U004	43
D1361806	DRIVE WERE: DIA1	U004	44
D1361809	BRACKET: TENSION	U004	45
D1361810	TENSION SPRING: TENSION: 11N	U004	46
D1361811	PULLEY: PEEN	U004	47
D1361817	BRACKET: EXPOSURE GLASS: DOCUMENT FEEDER: SUB-ASS'Y	U004_S005	48
D1361819	SEAL: BRACKET: EXPOSURE GLASS: DOCUMENT FEEDER	U004_S005	49
D1361820	SHEET: BRACKET: EXPOSURE GLASS: DOCUMENT FEEDER	U004_S005	50
D1362365	CLEANING BLADE: ASS'Y	U008_S007	77

Number	Part Name	Group	ID
		U008_S010	77
		U008_S013	77
		U008_S016	77
		U008_S019	77
D1362411	COATING BAR: ASS'Y	U008_S007	79
		U008_S010	79
		U008_S013	79
		U008_S016	79
		U008_S019	79
D1362417	ARM: COATING BAR	U008_S007	80
		U008_S010	80
		U008_S013	80
		U008_S016	80
		U008_S019	80
D1362418	TENSION SPRING: COATING BAR: 18N	U008_S007	81
		U008_S010	81
		U008_S013	81
		U008_S016	81
		U008_S019	81
D1362441	BLADE: APPLY: ASS'Y	U008_S007	82
		U008_S010	82
		U008_S013	82
		U008_S016	82
		U008_S019	82
D1363407	SEAL: DEVELOPMENT ROLLER: REAR	U008_S008	118
		U008_S011	118
		U008_S014	118
		U008_S017	118
		U008_S020	118
D1363431	FILTER: DEVELOPMENT	U008_S008	83
		U008_S011	83
		U008_S014	83
		U008_S017	83
		U008_S020	83
D1365696	PCB: SIO	U004	51
D1365709	PCB: EX3_DDR3-DIMM: RC-A: 2GB: ASS'Y	U020	86
D1365725	PCB: IMAGE PROCESSING UNIT: T	U020	87

Exclusive Parts

Number	Part Name	Group	ID
	YPE-S15MDA-SUB		
D1365978	BRACKET:HDD	U020_S007	122
D1366100	DENSITY SENSOR:P/TM	U009	124
D1366381	INSULATING SHEET:PULL OUT	U013_S001	224
D1366499	SHEET:GUIDE:BELT CLEANING	U009	125
D1366928	DUCT:DC FAN MOTOR:OPTICAL WRITING UNIT	U021	88
D1381731	LENSBLOCK SMD:SERVICE PART S:ASS'Y	U004_S001	69
D1441085	STEPPED SCREW:M3	U004	52
D1491715	PULLEY:DRIVE WERE:FRONT	U004	53
D1491717	PULLEY:DRIVE WERE:REAR	U004	54
D1491721	ILLUMINATION UNIT:LED-B:ASS'Y	U004_S003	55
D1491804	HOLDER:EXPOSURE GLASS:SCANNER	U004	56
D1491805	HOLDER:EXPOSURE GLASS	U004	57
D1495776	COVER:USB:SMALL	U020	88
D1495883	KEYTOP:MAIN SWITCH	U019	41
D1495884	COMPRESSION SPRING:KEYTOP	U019	42
D1582660	DC MOTOR:ASS'Y:2.64W	U007_S013	77
		U007_S015	77
		U007_S017	77
		U007_S019	77
D1775686	PCB:DCSW	U019	40
D1791748	HOLDER:EXPOSURE GLASS:ASS'Y	U023	22
D1791763	(-AA,-EU,-CHN):SCALE:LEFT:ASS'Y	U004	58
D1791764	(-NA):SCALE:LEFT:ASS'Y	U004	59
D1791768	EXPOSURE GLASS:DOCUMENT FEEDER	U004	60
D1791777	COVER:EXPOSURE GLASS:DOCUMENT FEEDER	U004	61
D1791789	SCALE:REAR:PRINTING	U004	62
D1793376	LEVER:SAFETY SWITCH:TONER SUPPLY UNIT:ASS'Y	U007	78
D1794337	RING:WEB:CLEANING	U015_S005	182
D1795923	PLATE:POWER SUPPLY CORD:INLET	U019	44
		U023	23

Number	Part Name	Group	ID
D1796412	SEAL:HOLDER:CLEANING BLADE: UPPER	U010_S001	56
D1796413	SEAL:HOLDER:CLEANING BLADE: FRONT LOWER	U010_S001	57
D1796414	SEAL:HOLDER:CLEANING BLADE: REAR LOWER	U010_S001	58
D1796415	SEAL:HOLDER:CLEANING BLADE: LOWER	U010_S001	59
D1796416	SEAL:HOLDER:CLEANING BLADE: BEHIND	U010_S001	60
D1797299	LCD:10.4SVGA_SH	U002_S001	47
		U002_S002	47
		U002_S003	47
		U002_S004	47
D1797302	COVER:FRONT:ASS'Y	U002_S001_S001	77
		U002_S002_S001	77
D1797303	(-EU):COVER:FRONT:ASS'Y	U002_S003_S001	78
D1797304	(-CHN):COVER:FRONT:ASS'Y	U002_S004_S001	48
D1797312	(-AA,-NA):COVER:FRONT	U002_S002_S001	49
D1797314	(-CHN):COVER:FRONT	U002_S004_S001	51
D1797322	(-AA,-NA):COVER:FRONT RIGHT	U002_S002_S001	52
D1797324	(-CHN):COVER:FRONT RIGHT	U002_S004_S001	54
D1797330	COVER:REAR	U002_S001	55
		U002_S002	55
		U002_S003	55
		U002_S004	55
D1797331	KEYTOP:FUNCTION	U002_S001	56
		U002_S002	56
		U002_S003	56
		U002_S004	56
D1797332	KEYTOP:HOME	U002_S001	57
		U002_S002	57
		U002_S003	57
		U002_S004	57
D1797333	LENS:STATUS DISPLAY	U002_S001	58
		U002_S002	58
		U002_S003	58
		U002_S004	58

Exclusive Parts

Number	Part Name	Group	ID
D1797334	LENS:POWER SOURCE	U002_S001	59
		U002_S002	59
		U002_S003	59
		U002_S004	59
D1797335	KEYTOP:OPTION:C	U002_S001	60
		U002_S002	60
		U002_S003	60
		U002_S004	60
D1797350	(-NA,-CHN):PLATE:LOGO:RIC	U023	25
D1797362	(-AA,-NA):DECAL:FUNCTION:MULTI-LANGUAGE	U023	26
D1797363	(-EU):DECAL:FUNCTION:MULTI-LANGUAGE	U023	27
D1797364	(-CHN):DECAL:FUNCTION:MULTI-LANGUAGE	U023	28
D1797387	GASKET:4X4:L7	U002_S001	61
		U002_S002	61
		U002_S003	61
		U002_S004	61
D1797388	GASKET:4X4:L33	U002_S001	62
		U002_S002	62
		U002_S003	62
		U002_S004	62
D1797389	GASKET:7X2:L15	U002_S001	63
		U002_S002	63
		U002_S003	63
		U002_S004	63
D1797390	GASKET:10X10:L38	U002_S001	64
		U002_S002	64
		U002_S003	64
		U002_S004	64
D1797549	(-NA):TANDEM LCT:LEFT:ASS'Y	U006_S007	366
D1915150	(D203/D204):PCB:RFID-CPU	U007_S024	79
D1941035	SEAL:HEAT PIPE:ROLLER:FAN:MM60	U021	89
D1941159	SLIDE RAIL:INTERMEDIATE TRANSPORT	U022	48
D1941162	SLIDE RAIL:TRANSPORT UNIT	U022	38

Number	Part Name	Group	ID
D1941168	COVER:SHIELD GLASS	U022	40
D1941186	HOLDER:CONNECTOR:TONER SUPPLY	U022	42
D1941189	SEAL:OPTICAL WRITING UNIT:UPPER:LEFT	U022	49
D1941190	SEAL:OPTICAL WRITING UNIT:UPPER:RIGHT	U022	50
D1941202	ADF:SINAI-B:ASS'Y	U003_S001	296
D1941223	SEAL:COVER:C/T BOX:SIROCCO	U020_S002	89
D1941224	HEXAGON HEAD SCREW:M4X10:WASHER:DIA9:ASS'Y	U020	94
D1941234	SUPPORTING PLATE:BRACKET:LOCK	U016	82
D1941257	COVER:C/T BOX:RIGHT:ASS'Y	U020_S002	90
D1941265	COVER:C/T BOX:LEFT:ASS'Y	U020_S003	91
D1941269	COVER:C/T BOX:RIGHT:UPPER:ASS'Y	U020	92
D1941282	SEAL:COVER:C/T BOX:MM120	U020_S002	93
		U020_S003	93
D1941371	STAY:MAIN:RIGHT UPPER:ASS'Y	U022	64
D1941412	DRUM SHAFT:ASS'Y	U018	92
D1941420	DRIVE UNIT:AROUND THE PHOTO CONDUCTOR:ASS'Y	U018_S008	122
		U018_S009	122
D1941421	SHAFT:DRIVE:TRANSPORT SCREW:ASS'Y	U018_S008_S001	93
		U018_S009_S001	93
D1941425	SHAFT:DRIVE:BRUSH ROLLER:ASS'Y	U018_S008_S002	94
		U018_S009_S002	94
		U018_S010_S001	94
		U018_S011_S001	94
D1941428	TIGHTENER:DRIVE:DEVELOPMENT:ASS'Y	U018_S012_S001	94
		U018_S008	95
		U018_S009	95
		U018_S010	95
D1941433	JOINT:DEVELOPMENT SLEEVE:DRIVE:MIDDLE	U018_S011	95
		U018_S012	95
		U018_S008	97
		U018_S009	97
		U018_S010	97

Exclusive Parts

Number	Part Name	Group	ID
		U018_S011	97
		U018_S012	97
D1941436	TENSION SPRING:TIGHTENER:DRIVE:AROUND THE PHOTOCONDUCTOR	U018_S008	98
		U018_S009	98
		U018_S010	98
		U018_S011	98
		U018_S012	98
D1941437	TIGHTENER:DEVELOPMENT SLEEVE	U018_S008	99
		U018_S009	99
		U018_S010	99
		U018_S011	99
		U018_S012	99
D1941441	TENSION SPRING:DEVELOPMENT	U018_S008	100
		U018_S009	100
		U018_S010	100
		U018_S011	100
		U018_S012	100
D1941450	DRIVE UNIT:AROUND THE PHOTO CONDUCTOR:CMY:ASS'Y	U018_S010	123
		U018_S011	123
		U018_S012	123
D1941451	SHAFT:DRIVE:TRANSPORT SCREW:CMY:ASS'Y	U018_S010_S003	101
		U018_S011_S003	101
		U018_S012_S003	101
D1941460	HOUSING:DRIVE:INTERMEDIATE TRANSFER:2	U009	126
D1941461	BOSS:INTERMEDIATE TRANSFER: GEAR	U009	127
D1941462	HEXAGON HEAD BOLT:DOUBLE SCREW:M4X10	U009	128
		U020	94
		U020_S002	94
		U020_S003	94
D1941466	DRUM STAY:DC MOTOR:DRIVE:PRESS FIT	U009	129
D1941470	DRIVE ROLLER:INTERMEDIATE TRANSFER:ASS'Y	U009	131
D1941480	HOLDER:DRIVEN ROLLER:FRONT	U009	132
D1941481	STOPPER:DRIVEN ROLLER:FRONT LEFT	U009	133

Number	Part Name	Group	ID
D1941482	BRACKET:DRIVEN ROLLER:FRONT	U009	134
D1941483	BRACKET:DRIVE WERE:TENSION SPRING	U009	135
D1941496	ENCODER:ASS'Y	U009	227
		U013_S001	286
		U018	119
D1941499	SEAL:PREVENTFENCE:8X395X3	U009	136
D1941501	BRACKET:DC BRUSHLESS MOTOR:ASS'Y	U018	102
D1941508	SHAFT:DRIVE:TRANSFER:ASS'Y	U018_S003	104
D1941509	SHAFT:DRIVE:BELT CLEANING:ASS'Y	U018_S002	103
D1941521	BRACKET:SECONDARY:DRIVE:FUSING	U018	105
D1941522	BRACKET:DRIVE:FUSING	U018	106
D1941528	SHAFT:OUTPUT:POLISH:ON-OFF:ASS'Y	U018_S006	108
D1941532	SHAFT:OUTPUT:POLISH:FUSING:ASS'Y	U018_S007	109
D1941538	SHAFT:OUTPUT:DRIVE:FUSING:ASS'Y	U018_S005	107
D1941604	BRACKET:DRIVE:EXIT:ASS'Y	U018	110
D1941605	SHAFT:DRIVE:EXIT:ASS'Y	U018_S001	111
D1941629	(D203/D204):JOINT:DRIVE:ON-OFF:5ST	U018	112
D1941630	(D203/D204):SHAFT:OUTPUT:ON-OFF:5ST:ASS'Y	U018_S013	113
D1941631	(D203/D204):BRACKET:DRIVE:ON-OFF:5ST:ASS'Y	U018	114
D1941634	COIL SPRING:JOINT:INTERMEDIATE TRANSFER:ON-OFF:5ST	U009	137
D1941761	SHEET:INDICATING HOLE ON A BOARD:NICE:GRAY:ASS'Y	SPECIAL TOOLS	13
D1941764	SHEET:INDICATING HOLE ON A BOARD:NICE:BLACK:ASS'Y	SPECIAL TOOLS	14
D1941766	COVER:NICE:BLACK	SPECIAL TOOLS	15
D1941767	COVER:NICE:WHITE	SPECIAL TOOLS	16

Exclusive Parts

Number	Part Name	Group	ID
D1941803	OPTICAL WRITING UNIT:4ST:ASS'Y	U005_S001	13
		U005_S002	13
D1941807	(D203/D204):OPTICAL WRITING UNIT:SST:ASS'Y	U005_S003	14
D1942150	CHARGE UNIT:ASS'Y	U008_S006	84
		U008_S009	84
		U008_S012	84
		U008_S015	84
		U008_S018	84
D1942165	DECAL:GRIP	U008_S006	85
		U008_S009	85
		U008_S012	85
		U008_S015	85
D1942175	DC SOLENOID:ON-OFF:ASS'Y	U008	86
D1942191	DISCHARGE LAMP:LED ARRAY	U008_S008	87
		U008_S011	87
		U008_S014	87
		U008_S017	87
D1942277	(D203/D204):ELECTRIC POTENTIAL SENSOR	U008	88
D1942290	(D203/D204):DC SOLENOID:ON-OFF:S:ASS'Y	U008	89
D1942304	PCU:ASS'Y	U008_S008	130
		U008_S020	130
D1942307	PCU:FC:ASS'Y	U008_S011	131
		U008_S014	131
		U008_S017	131
D1942330	CLEANING UNIT:ASS'Y	U008_S007	92
		U008_S010	92
		U008_S013	92
		U008_S016	92
D1942440	SEAL:FRAME:APPLY:REAR SIDE	U008_S019	92
		U008_S007	145
		U008_S010	145
		U008_S013	145
D1942440	SEAL:FRAME:APPLY:REAR SIDE	U008_S016	145
		U008_S007	145
		U008_S010	145
		U008_S013	145

Number	Part Name	Group	ID
D1942441	SEAL:FRAME:COATING BAR:FRONT SIDE	U008_S019	145
		U008_S007	146
		U008_S010	146
		U008_S013	146
		U008_S016	146
D1942442	SEAL:FRAME:COATING BAR:REAR SIDE	U008_S019	146
		U008_S007	147
		U008_S010	147
		U008_S013	147
D1942443	SEAL:FRAME:COATING BAR:UPPER	U008_S016	147
		U008_S019	147
		U008_S007	148
D1942443	SEAL:FRAME:COATING BAR:UPPER	U008_S010	148
		U008_S013	148
		U008_S016	148
		U008_S019	148
D1942457	COVER:BEARING:OIL SUPPLY ROLLER:FRONT	U008_S007	93
		U008_S010	93
		U008_S013	93
		U008_S016	93
		U008_S019	93
D1942458	COVER:BEARING:OIL SUPPLY ROLLER:REAR	U008_S007	94
		U008_S010	94
		U008_S013	94
		U008_S016	94
D1942460	GEAR:19Z:RIGHT	U008_S019	94
		U008_S007_S002	95
		U008_S010_S002	95
		U008_S013_S002	95
D1942460	GEAR:19Z:RIGHT	U008_S016_S002	95
		U008_S019_S002	95
		U008_S007_S001	96
		U008_S010_S001	96
D1942475	STAY:APPLY:ASS'Y	U008_S013_S001	96
		U008_S016_S001	96
		U008_S019_S001	96
		U008_S007_S001	96
D1942485	SEAL:BLADE:APPLY	U008_S010	97
		U008_S007	97

Exclusive Parts

Number	Part Name	Group	ID
		U008_S013	97
		U008_S016	97
		U008_S019	97
D1942506	DRUM STAY:CLEANING UNIT	U008_S007	98
		U008_S010	98
		U008_S013	98
		U008_S016	98
		U008_S019	98
D1942507	GROUND PLATE:OIL SUPPLY ROLLER:ASS'Y	U008_S007	99
		U008_S010	99
		U008_S013	99
		U008_S016	99
		U008_S019	99
D1942550	GEAR:CLEANING:DRUM:SERVICE	U008_S007_S002	103
		U008_S010_S002	103
		U008_S013_S002	103
		U008_S016_S002	103
		U008_S019_S002	103
D1942553	SLIDE RAIL:PCU:RIGHT	U008	104
D1942558	SLIDE RAIL:PCU:LEFT	U008	105
D1942562	(D203/D204):DECAL:PCU:TCRU:5S T	U008	106
D1942566	GUIDE PLATE:SLIDE RAIL:PCU:S:PEEN	U008	107
D1942612	TRANSPORT UNIT:ASS'Y	U013_S001	284
D1942648	COIL SPRING:GATE	U013_S001	54
D1942669	GUIDE PLATE:CONNECTING:LARGE CAPACITY TRAY:UPPER	U013_S001	225
D1942681	CONTACT IMAGE SENSOR:ASS'Y	U013_S001_S001	226
D1942704	SWING UNIT:ASS'Y	U013_S001_S002	227
D1942786	GUIDE PLATE:CONNECTING:LARGE CAPACITY TRAY:LOWER	U013_S001	152
D1942841	SEPARATION PLATE:CONTACT IMAGE SENSOR:DUCT	U013_S001	282
D1942850	SHEET:OPPOSED:CONTACT IMAGE SENSOR	U013_S001_S002	231
D1942851	SHEET:OPPOSED:CONTACT IMAGE SENSOR:LONG	U013_S001_S002	234

Number	Part Name	Group	ID
D1942852	SHEET:OPPOSED:CONTACT IMAGE SENSOR:STAY	U013_S001	277
D1942853	SHEET:OPPOSED:CONTACT IMAGE SENSOR:DUCT:LEFT	U013_S001	278
D1942854	SHEET:OPPOSED:CONTACT IMAGE SENSOR:DUCT	U013_S001	279
D1942855	SHEET:SEPARATION PLATE:CONTACT IMAGE SENSOR:DUCT	U013_S001	280
D1942860	GUIDE PLATE:VERTICAL TRANSPORT:RIGHT:PEEN	U013_S001	162
D1942880	TRANSPORT ROLLER:VERTICAL TRANSPORT:RIGHT:ENTRANCE:PRESS FIT	U013_S001	228
D1942883	TRANSPORT ROLLER:DUPLEX:RIGHT:NO.2:PRESS FIT	U013_S001	229
D1942927	STOPPER:LEVER:5MM	U001	67
D1942945	HOLDER:CAM:SHIFT	U013_S001	230
D1942960	GUIDE PLATE:REGISTRATION:PEEN	U013_S001	232
D1942964	SHEET:BASE:COVER	U013_S001	233
D1942968	BRACKET:LOCK	U013_S001	235
D1942969	COVER:TIMING:TRANSFER	U013_S001	236
D1942971	BRACKET:SAFETY SWITCH	U013	237
D1942972	STAY:SAFETY SWITCH	U013	238
D1942977	SEPARATION PLATE:CONTACT IMAGE SENSOR:DUCT	U013_S001	281
D1942985	GATE PAWL:PEEN	U013_S001	239
D1942988	SHAFT:GATE PAWL	U013_S001	240
D1942989	PLATE:ADJUSTING PIN:GATE	U013_S001	241
D1942990	TENSION SPRING:PRESSURE:TIMING ROLLER:REGISTRATION	U013_S001	287
D1942991	INNER COVER:PULL OUT:RIGHT	U001	51
D1942992	INNER COVER:PULL OUT:RIGHT:SMALL	U001	52
D1942995	BRACKET:BEARING:GUIDE:REAR	U013_S001	242
D1942999	DC STEPPER MOTOR:PAPER TRANSPORT MD:MM42:ASS'Y	U006	337
		U013_S001	243
		U016	146

Exclusive Parts

Number	Part Name	Group	ID
		U017	26
D1943216	COVER:HARNESS:OPERATION SUB-UNIT:TONER BOTTLE:ASS'Y	U007_S022	80
D1943330	ENTRANCE SEAL:DEVELOPMENT:ASS'Y	U008_S008	120
		U008_S011	120
		U008_S014	120
		U008_S017	120
		U008_S020	120
D1943396	JIG:SERVICE:DEVELOPMENT UNIT	SPECIAL TOOLS	17
D1943409	GEAR:DRIVE:TONER SUPPLY	U007	164
D1943424	BRACKET:DRIVE:TONER HOPPER:ASS'Y	U007	81
D1943441	CASE:TONER HOPPER:TONER SUPPLY:FRONT:ASS'Y	U007_S002	82
		U007_S005	82
		U007_S008	82
		U007_S011	82
		U007_S023_S001	82
D1943450	PUMP UNIT:TONER SUPPLY:ASS'Y	U007_S003	83
		U007_S006	83
		U007_S009	83
		U007_S012	83
		U007_S023_S002	83
D1943482	BRACKET:DRIVE:TONER SUPPLY UNIT:ASS'Y	U007	84
D1943485	GEAR:IDLER:DRIVE:TONER SUPPLY UNIT:ASS'Y	U007	85
D1943495	STAND:INNER COVER:TONER SUPPLY	U007	86
D1943496	STAND:INNER COVER:RECEPTACLE:TONER SUPPLY	U007	151
D1943546	TONER BANK:ASS'Y	U007_S013	174
		U007_S015	174
		U007_S017	174
		U007_S019	174
D1943564	LEVER:BASE:TONER BANK	U007_S013	88
		U007_S015	88
		U007_S017	88

Number	Part Name	Group	ID
		U007_S019	88
D1943566	GRIP:LEVER:BASE:TONER BANK	U007_S013	89
		U007_S015	89
		U007_S017	89
		U007_S019	89
D1943567	GUIDE:BASE:TONER BANK	U007	90
		U007_S013	90
		U007_S015	90
		U007_S017	90
		U007_S019	90
D1943587	GEAR:TORQUE LIMITER MECHANICAL CLUTCH:DRIVE:TONER BOTTLE	U007	91
D1943589	STOPPER:TONER BOTTLE	U007_S013	92
		U007_S015	92
		U007_S017	92
		U007_S019	92
D1943599	GEAR:RACK:Z12:Z35	U007_S013	93
		U007_S015	93
		U007_S017	93
		U007_S019	93
D1943603	GEAR:DRIVE:TONER BOTTLE:Z14	U007	94
D1943621	GEAR:DC MOTOR	U007_S013	95
		U007_S015	95
		U007_S017	95
		U007_S019	95
D1943622	GEAR:IDLER	U007_S013	96
		U007_S015	96
		U007_S017	96
		U007_S019	96
D1943623	GEAR:AGITATOR	U007_S013	97
		U007_S015	97
		U007_S017	97
		U007_S019	97
D1943626	TUBE:BK	U007	98
D1943627	TUBE:TONER:C	U007	99
D1943628	TUBE:TONER:M:REAR	U007	100
D1943629	TUBE:TONER:Y:REAR	U007	101

Exclusive Parts

Number	Part Name	Group	ID
D1943630	DC MOTOR:DRIVE:TONER BOTTL E:ASS'Y:5.85W:BRUSH	U007_S013	102
		U007_S015	102
		U007_S017	102
		U007_S019	102
		U007_S025	102
D1943632	DC MOTOR:SLIDER:TONER BANK: ASS'Y:4.2W:BRUSH	U007_S013	103
		U007_S015	103
		U007_S017	103
		U007_S019	103
D1943642	SHAFT:FEELER:SENSOR:ON OFF DETECTOR:TONER BANK	U007	104
D1943653	BRACKET:INNER COVER:TONER BANK:PEEN	U007	175
D1943655	INNER COVER:TONER BANK:ASS' Y	U007_S021	105
D1943660	DECAL:COLORED DISPLAY:TONE R BANK:K	U007_S021	106
D1943661	DECAL:COLORED DISPLAY:TONE R BANK:C	U007_S021	107
D1943662	DECAL:COLORED DISPLAY:TONE R BANK:M	U007_S021	108
D1943663	DECAL:COLORED DISPLAY:TONE R BANK:Y	U007_S021	109
D1943664	DECAL:OPERATE:TONER BOTTLE :4C	U007_S021	110
D1943677	COVER:GEAR:TONER BOTTLE:AS S'Y	U007_S014	111
		U007_S016	111
		U007_S018	111
		U007_S020	111
D1943707	SLIDER:TONER BANK	U007_S013	170
		U007_S015	170
		U007_S017	170
		U007_S019	170
D1943708	SEAL:INNER:SLIDER:TONER BAN K	U007_S013	171
		U007_S015	171
		U007_S017	171
		U007_S019	171
D1943709	SEAL:OUTER:SLIDER:TONER BAN	U007_S013	172

Number	Part Name	Group	ID
	K	U007_S015	172
		U007_S017	172
		U007_S019	172
D1943712	HOLDER:HOOK:CAP:TONER BOTTL LE	U007_S013	165
		U007_S015	165
		U007_S017	165
		U007_S019	165
D1943713	PLATE:SHAFT:CHUCK:TONER BO TTLE	U007_S013	156
		U007_S015	156
		U007_S017	156
		U007_S019	156
D1943724	COMPRESSION SPRING:PRESSU RE:SLIDER:TONER BANK	U007_S013	154
		U007_S015	154
		U007_S017	154
		U007_S019	154
D1943726	SEAL:GEAR:DRIVE:TONER BOTTL E	U007	112
D1943732	GEAR:TONER BANK:RIC:K:ASS'Y	U007	113
D1943737	GEAR:TONER BANK:RIC:C:ASS'Y	U007	114
D1943742	GEAR:TONER BANK:RIC:M:ASS'Y	U007	115
D1943747	GEAR:TONER BANK:RIC:Y:ASS'Y	U007	116
D1943752	COVER:GEAR:TONER BOTTLE:RI GHT UPPER	U007_S014	117
		U007_S016	117
		U007_S018	117
		U007_S020	117
D1943753	COVER:GEAR:TONER BOTTLE:RI GHT LOWER	U007_S014	118
		U007_S016	118
		U007_S018	118
		U007_S018	118
		U007_S020	118
D1943754	COVER:GEAR:TONER BOTTLE:LE FT LOWER	U007_S014	119
		U007_S016	119
		U007_S018	119
		U007_S020	119
D1943755	COVER:HARNESS:OPERATION SU B-UNIT:TONER BOTTLE:RIGHT	U007_S022	120
D1943760	(D203/D204-NA,-EU):INNER COVE R:DUMMY:5ST:TONERSUPPLY	U007	122
D1943762	INNER COVER:TONER HOPPER:T	U007	123

Exclusive Parts

Number	Part Name	Group	ID
	ONER SUPPLY		
D1943764	INNER COVER:TONER HOPPER:5 ST:TONER SUPPLY	U007	124
D1943765	TORSION SPRING:SAFETY SWITC H:TONER SUPPLY UNIT	U007	125
D1943767	MAGNET CATCH PLEET:FRONT U PPER	U007	127
D1943768	BRACKET:SAFETY SWITCH:INNER COVER:TONER SUPPLY	U007	128
D1943776	INNER COVER:MOTOR:TONER HO PPER:TONER SUPPLY	U007	126
D1943802	TRANSPORT ROLLER:DRIVE:SUS	U014_S001	20
D1943809	SUPPORTING PLATE:VACUUM	U014_S001	25
D1943818	VACUUM	U014_S001	26
D1943847	INNER COVER:INTERMEDIATE TR ANSFER:PCU	U009	138
D1943852	TRANSPORT BELT UNIT:ASS'Y	U014_S001	21
D1943860	INNER COVER:INTERMEDIATE TR ANSFER:LEFT	U009	139
D1943861	INNER COVER:INTERMEDIATE TR ANSFER:RIGHT	U009	147
D1944021	(-NA):FUSING UNIT:208V:ASS'Y	U015_S004	251
D1944031	(-AA,-EU,-CHN):FUSING UNIT:230V :ASS'Y	U015_S001	250
		U015_S002	250
		U015_S003	250
D1944066	GUIDE PLATE:FUSING EXIT:LOWE R:NO.2:ASS'Y	U015_S001_S002	247
		U015_S002_S002	247
		U015_S003_S002	247
		U015_S004_S002	247
D1944068	GUIDE PLATE:FUSING EXIT:LOWE R:CONNECTING:ASS'Y	U015_S001	185
		U015_S002	185
		U015_S003	185
		U015_S004	185
D1944074	PRESSURE SUB-UNIT:STRIPPER PLATE:ASS'Y	U015_S001_S003	186
		U015_S002_S003	186
		U015_S003_S003	186
		U015_S004_S003	186
D1944101	SHAFT:CAM:PRESSURE	U015_S001	187

Number	Part Name	Group	ID
		U015_S002	187
		U015_S003	187
		U015_S004	187
D1944105	FEELER:CAM:PRESSURE:REAR	U015_S001	188
		U015_S002	188
		U015_S003	188
		U015_S004	188
D1944106	JOINT:CAM:PRESSURE	U015_S001	189
		U015_S002	189
		U015_S003	189
		U015_S004	189
D1944115	SERVICE PARTS:PICKOFF PAWL: PRESSURE ROLLER:ASS'Y	U015_S001_S003	261
		U015_S002_S003	261
		U015_S003_S003	261
		U015_S004_S003	261
D1944143	SHAFT:SEPARATION SUB-UNIT	U015_S001	191
		U015_S002	191
		U015_S003	191
		U015_S004	191
D1944150	SIDE PLATE:FUSING:REAR:PEEN	U015_S001	265
		U015_S002	265
		U015_S003	265
		U015_S004	265
D1944158	FUSING ENTRANCE GUIDE PLATE :UPPER:FIBER	U015_S001	192
		U015_S002	192
		U015_S003	192
		U015_S004	192
D1944172	BRAKE:WEB	U015_S005	193
D1944173	DUCT:PRESSURE:UPPER	U015_S001	194
		U015_S002	194
		U015_S003	194
		U015_S004	194
D1944175	DISCHARGE BRUSH:HEAT ROLLE R	U015_S001	195
		U015_S002	195
		U015_S003	195
		U015_S004	195
D1944176	SIDE PLATE:PRESSURE:ELECTRI CAL COMPONENTS:FRONT	U015_S001	196
		U015_S002	196

Exclusive Parts

Number	Part Name	Group	ID
		U015_S003	196
		U015_S004	196
D1944179	HOLDER:THERMISTOR:HEAT ROLLER:REAR	U015_S001	197
		U015_S002	197
		U015_S003	197
		U015_S004	197
		U015_S004	197
D1944180	FLAT BELT-FUSING:DIA80:SEAL	U015_S001	198
		U015_S002	198
		U015_S003	198
		U015_S004	198
D1944184	FUSING ENTRANCE GUIDE PLATE:LOWER	U015_S001	199
		U015_S002	199
		U015_S003	199
		U015_S004	199
D1944185	RING:GUIDE:HEAT ROLLER:DIA40	U015_S001	200
		U015_S002	200
		U015_S003	200
		U015_S004	200
D1944186	DECAL:WARNING (REMOVAL AND INSTALLATION):FUSING	U015_S001_S001	201
		U015_S002_S001	201
		U015_S003_S001	201
		U015_S004_S001	201
D1944188	STAY:PRESSURE SUB-UNIT:ENTRANCE	U015_S001	270
		U015_S002	270
		U015_S003	270
		U015_S004	270
D1944189	DISCHARGE BRUSH:PRESSURE ROLLER	U015_S001	202
		U015_S002	202
		U015_S003	202
		U015_S004	202
D1944190	FUSING COVER:UPPER:SUB-ASS'Y	U015_S001_S001	203
		U015_S002_S001	203
		U015_S003_S001	203
		U015_S004_S001	203
D1944195	HEATER HOLDER:HEAT ROLLER:REAR	U015_S001	204
		U015_S002	204
		U015_S003	204
		U015_S004	204

Number	Part Name	Group	ID
D1944196	HEATER HOLDER:HEAT ROLLER:FRONT	U015_S001	205
		U015_S002	205
		U015_S003	205
		U015_S004	205
D1944197	HEATER HOLDER:PRESSURE:REAR	U015_S001	206
		U015_S002	206
		U015_S003	206
D1944198	HEATER HOLDER:PRESSURE:FRONT	U015_S001	207
		U015_S002	207
		U015_S003	207
D1944199	ELECTRODE PLATE:HEATER:PRESSURE:FRONT	U015_S001	208
		U015_S002	208
		U015_S003	208
D1944203	COVER:SEPARATION SUB-UNIT:PRINTING	U015_S001	209
		U015_S002	209
		U015_S003	209
		U015_S004	209
D1944206	DECAL:LEVER:D2	U015_S001	210
		U015_S002	210
		U015_S003	210
		U015_S004	210
D1944209	STRIPPER PLATE:ASS'Y	U015_S001	211
		U015_S002	211
		U015_S003	211
		U015_S004	211
D1944219	SUPPORTING PLATE:SIDE PLATE:PRESSURE:FRONT	U015_S001	258
		U015_S002	258
		U015_S003	258
		U015_S004	258
D1944220	SUPPORTING PLATE:SIDE PLATE:PRESSURE:REAR	U015_S001	266
		U015_S002	266
		U015_S003	266
		U015_S004	266
D1944224	GUIDE PLATE:FUSING EXIT:UPPER:ASS'Y	U015_S001	212
		U015_S002	212

Exclusive Parts

Number	Part Name	Group	ID
		U015_S003	212
		U015_S004	212
D1944232	LEVER:ON-OFF:A:PEEN	U015_S001	213
		U015_S002	213
		U015_S003	213
		U015_S004	213
		U015_S004	213
D1944234	LEVER:ON-OFF:B:PEEN	U015_S001	214
		U015_S002	214
		U015_S003	214
		U015_S004	214
D1944242	CAM:ON-OFF	U015_S001	216
		U015_S002	216
		U015_S003	216
		U015_S004	216
D1944243	FEELER:SENSOR:ON-OFF	U015_S001	217
		U015_S002	217
		U015_S003	217
		U015_S004	217
D1944255	FUSING COVER:FRONT	U015_S001	218
		U015_S002	218
		U015_S003	218
		U015_S004	218
D1944260	POSITIONING PLATE:FUSING UNIT:REAR:PEEN	U015_S001	252
		U015_S002	252
		U015_S003	252
		U015_S004	252
D1944268	BRACKET:GRIP:REAR	U015_S001	219
		U015_S002	219
		U015_S003	219
		U015_S004	219
D1944269	FUSING COVER:REAR:PRINTING	U015_S001	220
		U015_S002	220
		U015_S003	220
		U015_S004	220
D1944271	HEXAGON HEAD SCREW:ADHESIVE:M3X5	U015_S001	268
		U015_S002	268
		U015_S003	268
		U015_S004	268

Number	Part Name	Group	ID
D1944272	STAY:SEPARATION SUB-UNIT:PRESSURE	U015_S001	248
		U015_S002	248
		U015_S003	248
		U015_S004	248
D1944273	BRACKET:PAPER FEED SENSOR:FUSING EXIT	U015_S001	259
		U015_S002	259
		U015_S003	259
		U015_S004	259
D1944279	GUIDE PLATE:SEPARATION SUB-UNIT:PRESSURE	U015_S001_S003	269
		U015_S002_S003	269
		U015_S003_S003	269
		U015_S004_S003	269
D1944285	STAY:FRONT	U015_S001	262
		U015_S002	262
		U015_S003	262
		U015_S004	262
D1944286	STAY:REAR	U015_S001	253
		U015_S002	253
		U015_S003	253
		U015_S004	253
D1944289	SHAFT:CAM	U015_S001	256
		U015_S002	256
		U015_S003	256
		U015_S004	256
D1944293	PLATE:LEVER:PRESSURE	U015_S001	249
		U015_S002	249
		U015_S003	249
		U015_S004	249
D1944297	STEPPED SCREW:M5	U015_S001	221
		U015_S002	221
		U015_S003	221
		U015_S004	221
D1944301	SHAFT:ON-OFF:POLISH	U015_S001	222
		U015_S002	222
		U015_S003	222
		U015_S004	222
D1944302	HOLDER:GEAR:ON-OFF	U015_S001	223
		U015_S002	223

Exclusive Parts

Number	Part Name	Group	ID
		U015_S003	223
		U015_S004	223
D1944305	COVER:GEAR:ON-OFF	U015_S001	224
		U015_S002	224
		U015_S003	224
		U015_S004	224
D1944306	BRACKET:SENSOR:ON-OFF	U015_S001	246
		U015_S002	246
		U015_S003	246
		U015_S004	246
D1944311	SHAFT:DRIVE:POLISH	U015_S001	225
		U015_S002	225
		U015_S003	225
		U015_S004	225
D1944312	BRACKET:DRIVE:POLISH	U015_S001	226
		U015_S002	226
		U015_S003	226
		U015_S004	226
D1944314	TORSION SPRING:ON-OFF	U015_S001	227
		U015_S002	227
		U015_S003	227
		U015_S004	227
D1944315	SUPPORT SHAFT	U015_S001	228
		U015_S002	228
		U015_S003	228
		U015_S004	228
D1944318	STOPPER:RADIAL BALL BEARING	U015_S001	229
		U015_S002	229
		U015_S003	229
		U015_S004	229
D1944319	STOPPER:RADIAL BALL BEARING: DIA10	U015_S001	230
		U015_S002	230
		U015_S003	230
		U015_S004	230
D1944325	COVER:ROLLER:POLISH:PRINTIN G	U015_S006	232
D1944327	ROLLER:POLISH:ASS'Y	U015_S006	263
D1944328	ROLLER:POLISH	U015_S006	233

Number	Part Name	Group	ID
D1944340	WEB:CLEANING UNIT:ASS'Y	U015_S005	234
D1944342	RING:WEB:CLEANING:R	U015_S005	235
D1944344	SHAFT:LEVER:RELEASE	U015_S001	236
		U015_S002	236
		U015_S003	236
		U015_S004	236
D1944399	LEVER:RELEASE	U015_S001	237
		U015_S002	237
		U015_S003	237
		U015_S004	237
D1944408	CAP:HEAT PIPE	U016	147
D1944409	BRACKET:CAP:HEAT PIPE:UPPER	U016	148
D1944413	GUIDE:FIX:SHEET:GING	U016_S001	223
D1944426	GUIDE:EXIT:ENTRANCE:ADHESIO N	U016_S002_S002	149
D1944433	COOLING UNIT:EXIT:ASS'Y	U016_S001	229
D1944435	GUIDE:OPEN AND CLOSE:EXIT:EN TRANCE:ASS'Y	U016_S002	150
D1944438	TRANSPORT ROLLER:HEAT PIPE: DIA50.4:COATING	U016_S001	151
D1944449	SHEET:TRANSPORT:EXIT:FRONT	U016_S007	227
D1944453	SHEET:TRANSPORT:EXIT:INNER BACK	U016_S007	228
D1944472	SHEET:TRANSPORT:COOLING:MI DDLE	U016_S002_S002	152
D1944480	SHEET:REVERSE SUB-UNIT:FRON T REAR	U016_S011	153
D1944481	SHEET:REVERSE SUB-UNIT:MIDD LE FRONT	U016_S011	154
D1944482	SHEET:REVERSE SUB-UNIT:MIDD LE REAR	U016_S011	155
D1944483	SHEET:REVERSE SUB-UNIT:MIDD LE	U016_S011	156
D1944484	SHEET:REVERSE:ENTRANCE:CIN G	U016_S011	238
D1944487	GUIDE:BASE:EXIT:ENTRANCE	U016_S001	157
D1944488	GUIDE:EXIT:EXIT:ROLLER	U016_S001	158
D1944489	GUIDE:EXIT:EXIT	U016_S001	159

Exclusive Parts

Number	Part Name	Group	ID
D1944495	DECAL:MISFEED REMOVAL:FLAT CONVEYER BELT	U023	48
D1944497	DECAL:MISFEED REMOVAL:DE	U001_S004	41
D1944536	GUIDE:REVERSE EXIT:RIGHT:PEEN	U016	161
D1944537	BRACKET:MOTOR:REVERSE:CONNECTING	U016	162
D1944539	BRACKET:MOTOR:REVERSE	U016	163
D1944540	GUIDE PLATE:DUPLX:ENTRANCE	U016_S013	164
D1944589	GATE PAWL:REVERSE EXIT	U016	165
D1944610	GUIDE PLATE:EXIT:UPPER	U016_S007	166
D1944612	TRANSPORT ROLLER:DRIVE:REVERSE	U016 U017	167 27
D1944614	TRANSPORT ROLLER:CONNECTING:DRIVE:EXIT	U016	168
D1944616	TRANSPORT ROLLER:DRIVE:FUSING EXIT	U016_S001	169
D1944625	LEVER:GATE PAWL:REVERSE:PRESS FIT	U016	237
D1944652	BRACKET:DRAWER:PAPER EXIT UNIT	U016	170
D1944653	BRACKET:DRAWER:PAPER EXIT UNIT:MAIN	U022	57
D1944658	SHEET:HANDLE:LOCK:ASS'Y	U016_S002_S001 U016_S006	172 172
D1944700	GUIDE:DUPLX:OPEN AND CLOSE:UPPER	U016_S015	173
D1944703	SHEET:DUPLX:OPEN AND CLOSE:UPPER	U016_S015	239
D1944712	FLAT CONVEYER BELT:COOLING	U016_S001	174
D1944714	TRANSPORT ROLLER:COOLING:ENTRANCE	U016_S001	175
D1944718	TRANSPORT ROLLER:DUPLX:NO.1:PRESS FIT	U016	176
D1944719	TRANSPORT ROLLER:DRIVE:DUPLX:KNOB	U016	177
D1944721	DRIVE ROLLER:COOLING UNIT:EX	U016_S001	178

Number	Part Name	Group	ID
	IT:PRESS FIT		
D1944741	GUIDE:EXIT:UPPER	U016	179
D1944742	STAY:LEFT UPPER	U016	224
D1944744	GUIDE:REVERSE EXIT:LEFT	U016	180
D1944759	BRACKET:LOCK:EXIT	U013_S001 U016	251 194
D1944804	RUBBER FOOT:TM-96-1	U016	181
D1944810	PLATE:OPEN AND CLOSE:DUPLX:LEFT LOWER:PEEN	U016	182
D1944816	BRACKET:DRAWER:DUPLX	U016	183
D1944821	BRACKET:DRAWER:DUPLX:MAIN	U022	60
D1944905	TRANSPORT ROLLER:DRIVEN:PRESS FIT	U016	185
D1945112	PCB:LVDB_D	U020	95
D1945114	PCB:LVDB_U	U019	46
D1945126	PCB:IDB	U004	71
D1945128	INTERFACE CABLE:LVDB_U:IPU:ASS'Y	U019	47
D1945130	INTERFACE CABLE:SBU:LVDB_U:ASS'Y	U004	64
D1945356	TEMPERATURE SENSOR:FUSING UNIT:DRAWER:17PIN	U015_S001 U015_S002 U015_S003 U015_S004	238 238 238 238
D1945358	TEMPERATURE SENSOR:FUSING UNIT:UPPER:13PIN	U015_S001 U015_S002 U015_S003 U015_S004	239 239 239 239
D1945410	PCB:BCU:ASS'Y	U019_S001	61
D1945426	PCB:TSB:ASS'Y	U007	129
D1945440	PCB:NRYF	U019	49
D1945451	AC CONTROL BOARD	U019	43
D1945480	PCB:CRB	U013_S001	244
D1945506	PCB:IOB	U019	50
D1945516	PCB:PFB	U019	51
D1945520	PCB:TDCU:ASS'Y	U019	52
D1945538	PCB:DRB	U013_S001	245
D1945546	PCB:TDRB	U009	140

Exclusive Parts

Number	Part Name	Group	ID
D1945706	PCB:IMAGE PROCESSING UNIT	U020	127
D1945832	HDD UNIT:ASS'Y	U020_S007	121
D1945838	SIDE PLATE:C/T BOX:RIGHT:RIGHT:PEEN	U020	124
D1945906	BRACKET:POWER PACK	U019	66
D1945914	BRACKET:SAFETY SWITCH	U019	53
D1945926	BRACKET:CONNECTOR:LARGE CAPACITY TRAY	U019	54
D1945927	BRACKET:CONNECTOR:FIN	U019	55
D1945932	COVER:DCSW	U019	56
D1945934	COVER:DCSW	U001	53
D1945941	STAY:SLIDE RAIL:LEFT FRONT	U006	338
D1946011	COVER:INTERMEDIATE TRANSFER:BLACK	U009	141
D1946012	COVER:INTERMEDIATE TRANSFER:BLACK:1	U009	142
D1946031	TENSION SPRING:ROLLER:DRIVE NO:NO.5:RIGHT	U009	143
D1946032	TENSION SPRING:ROLLER:DRIVE NO:NO.5:LEFT	U009	144
D1946033	TENSION SPRING:SLIDER:SHAFT:NO.5	U009	145
D1946042	EXCHANGE PLATE:ON-OFF:NO.5:REAR	U009	146
D1946051	BRACKET:PLAIN SHAFT BEARING:ON-OFF:NO.5:REAR	U009	148
D1946052	ROLLER:DRIVEN:INTERMEDIATE TRANSFER:NO.5	U009	149
D1946054	BRACKET:TENSION SPRING:ROLLER:NO.5:FRONT	U009	237
D1946055	PLAIN SHAFT BEARING:SHAFT:ON-OFF:NO.5:LEFT	U009	150
D1946058	COLLAR:ROLLER:DRIVEN:INTERMEDIATE TRANSFER:NO.5	U009	151
D1946061	LEVER:ON-OFF:BLACK:LEFT:FRONT	U009	152
D1946062	LEVER:ON-OFF:BLACK:LEFT:REAR	U009	153

Number	Part Name	Group	ID
D1946065	PLATE:ROLLER:DRIVEN:BLACK	U009	154
D1946073	PLAIN SHAFT BEARING:SLIDER:ON-OFF:BLACK	U009	155
D1946088	BRACKET:ROLLER:DRIVEN:NO.5:REAR	U009	156
D1946089	SHAFT:ON-OFF:DRIVE:NO.5:INTERMEDIATE TRANSFER	U009	157
D1946090	SHAFT:CAM:INTERMEDIATE TRANSFER:BLACK	U009	158
D1946091	PLAIN SHAFT BEARING:SHAFT:ON-OFF:NO.5:RIGHT	U009	159
D1946092	SHAFT:SLIDE:ON-OFF:INTERMEDIATE TRANSFER:NO.5	U009	160
D1946093	BRACKET:DRAWER:INTERMEDIATE TRANSFER	U009	161
D1946098	HOOK:LEVER:ON-OFF:BLACK:REAR	U009	162
D1946099	HOOK:LEVER:ON-OFF:BLACK:FRONT	U009	163
D1946103	BRACKET:MOTOR:ON-OFF:INTERMEDIATE TRANSFER	U009	164
D1946112	COVER:INTERMEDIATE TRANSFER:NO.4	U009	165
D1946114	COVER:INTERMEDIATE TRANSFER:NO.1	U009	166
D1946115	COVER:INTERMEDIATE TRANSFER:NO.2	U009	167
D1946125	ROLLER:FRONT:INTERMEDIATE TRANSFER:RIGHT	U009	168
D1946140	PLATE:UPPER:POSITIONING SENSOR:INTERMEDIATE TRANSFER:ASS'Y	U009	169
D1946142	BRACKET:PLAIN SHAFT BEARING:ON-OFF:NO.5:FRONT	U009	170
D1946144	BRACKET:ROLLER:DRIVEN:NO.5:FRONT	U009	171
D1946145	EXCHANGE PLATE:ON-OFF:NO.5:FRONT	U009	172

Exclusive Parts

Number	Part Name	Group	ID
D1946147	SPRING PLATE:ELECTRODE:OPPOSED:TRANSFER ROLLER	U009	173
D1946148	SYNCHRONOUS BELT:80S2M224	U009	174
D1946154	TIMING PULLEY:CAM:ON-OFF:INTERMEDIATE TRANSFER:BLACK	U009	175
D1946160	SPRING PLATE:EARTH:ROLLER:NO.5:ASS'Y	U009	176
D1946166	SLIDER:ON-OFF:BLACK:REAR	U009	177
D1946172	SLIDER:ON-OFF:BLACK:FRONT	U009	178
D1946176	CAM:ON-OFF:BLACK:AUTOMATIC	U009	179
D1946177	DC STEPPER MOTOR:DIA42:24V	U009 U018	180 115
D1946182	PLATE:ROLLER:DRIVEN:BLACK:RIGHT	U009	181
D1946183	LEVER:ON-OFF:BLACK:RIGHT	U009	182
D1946191	JOINT:INTERMEDIATE TRANSFER:ON-OFF:5ST	U009	183
D1946201	BRUSH ROLLER:APPLY:ASS'Y	U011_S001	44
D1946207	SHEET:GREASE:HOLDER:TRANSFER ROLLER	U009	185
D1946210	GUIDE:TRANSPORT:INTERMEDIATE TRANSFER:ASS'Y	U009_S010	186
D1946214	GUIDE:TRANSPORT:INTERMEDIATE TRANSFER:5.0+:ASS'Y	U009_S010	187
D1946222	GUIDE:TRANSPORT:INTERMEDIATE TRANSFER:5.0-:ASS'Y	U009	220
D1946228	ROLLER:POSITIONING CONTROL:BELT	U009	188
D1946229	GROUND PLATE:VACUUM:SENSOR:SPRING PLATE	U014_S001	22
D1946231	ROLLER:OPPOSED:TRANSFER:PART:ASS'Y	U009_S008	189
D1946236	HEXAGON HEAD SCREW:WASHER:M4X10:ASS'Y	U009	8
D1946248	DECAL:INNER COVER:INTERMEDIATE TRANSFER	U009	221
D1946262	SERVICE PARTS:COIL SPRING:TRANSFER ROLLER:EXCHANGEABLE	U009_S002 U009_S003	223 223

Number	Part Name	Group	ID
	E:20N		
D1946263	SERVICE PARTS:COIL SPRING:TRANSFER ROLLER:EXCHANGEABLE:30N	U009_S004 U009_S005	224 224
D1946266	SERVICE PARTS:COIL SPRING:TRANSFER ROLLER:EXCHANGEABLE:60N	U009_S006 U009_S007	225 225
D1946301	SEPARATION CORONA:ASS'Y	U011_S001_S001	41
D1946358	BRACKET:DENSITY SENSOR:INTERMEDIATE TRANSFER	U009	226
D1946363	PULLEY:ON-OFF:S2M:27T:MELTING ADHESION	U009	233
D1946396	GROUND PLATE:ROLLER:DRIVEN:LEFT	U009	192
D1946420	POSITIONING SENSOR:SCALE:INTERMEDIATE TRANSFER:ASS'Y	U009_S009	193
D1946428	TERMINAL:INTERMEDIATE TRANSFER:5ST	U009	194
D1946432	TENSION SPRING:PRESSURE:INTERMEDIATE TRANSFER	U009	195
D1946436	CASE:OPPOSED:TRANSFER ROLLER:FRONT	U009	196
D1946439	CASE:OPPOSED:TRANSFER ROLLER:REAR	U009	197
D1946440	ROLLER:TRANSFER:FRONT	U009	198
D1946442	SLIDER:ON-OFF:NO.5:REAR	U009	199
D1946444	SLIDER:ON-OFF:NO.5:FRONT	U009	200
D1946449	TENSION SPRING:PLATE:INTERMEDIATE TRANSFER	U009	201
D1946453	BRACKET:ROLLER:TRANSFER:LEFT REAR:ASS'Y	U009	202
D1946454	BRACKET:ROLLER:TRANSFER:LEFT FRONT:ASS'Y	U009	203
D1946455	BRACKET:MOTOR:ON-OFF:INTERMEDIATE TRANSFER:BLACK	U009	204
D1946457	SHAFT:CAM:INTERMEDIATE TRANSFER:BLACK:2	U009	205
D1946459	TENSION SPRING:ON-OFF:BLACK:	U009	206

Exclusive Parts

Number	Part Name	Group	ID
	LEFT		
D1946467	TIGHTENER:INTERMEDIATE TRANSFER:ASS'Y	U009	207
D1946473	TENSION SPRING:SLIDER:ON-OFF:BLACK	U009	208
D1946475	GRIP:ON-OFF:INTERMEDIATE TRANSFER	U009	209
D1946499	GROUND PLATE:ROLLER:DRIVEN:RIGHT	U009	210
D1946504	TRANSPORT SCREW:PCU:MAIN:ASS'Y	U012_S005	79
D1946521	TONER OUTLET SUB-UNIT:PCU:MAIN:5ST:ASS'Y	U012_S005	80
D1946528	(D194/D195):(D203/D204-NA,-EU):CAP:TONER OUTLET SUB-UNIT	U012	81
D1946656	COVER:GEAR:SIDE PLATE:PEEN	U012	82
D1946737	CAP:COVER:ARM:FRONT	U002	42
D1946923	DUCT:HEAT PIPE:FUSING:SIDE	U021	90
D1946924	COVER:HEAT PIPE:THERMOPILE	U021	91
D1946931	PANEL MOUNT:THERMOPILE	U021	92
D1946936	BLOCK AIR MOVEMENT PLATE:THERMOPILE	U021	93
D1946937	SEAL:THERMOPILE:HEAT PIPE	U021	94
D1946957	DUCT:FRONT:VACUUM:CONNECTING:HEAT SINKER	U021	95
D1946958	DUCT:REAR:VACUUM:CONNECTING:HEAT SINKER	U021	96
D1946992	DUCT:HEAT PIPE:ROLLER:UPPER	U021	97
D1946993	DUCT:HEAT PIPE:ROLLER:LOWER	U021	98
D1946997	SEAL:DUCT:EXHAUST:HEAT PIPE:LONG	U021	99
D1946998	SEAL:DUCT:EXHAUST:HEAT PIPE:SHORT	U021	100
D1947000	DUCT:EXHAUST:HEAT PIPE:ROLLER:RIGHT	U021	101
D1947001	DUCT:EXHAUST:HEAT PIPE:ROLLER:LEFT	U021	102
D1947003	SEAL:DUCT:HEAT PIPE:ROLLER:UPPER	U021	103

Number	Part Name	Group	ID
	PPER		
D1947006	SEAL:DUCT:HEAT PIPE:ROLLER:LOWER	U021	104
D1947022	DUCT:EXHAUST:ABSORB DUST SUB-UNIT:FRONT	U021	105
D1947026	DUCT:CONNECTING:ABSORB DUST SUB-UNIT:LEFT	U021	106
D1947027	DUCT:CONNECTING:ABSORB DUST SUB-UNIT:RIGHT	U021	107
D1947030	DUCT:EXHAUST:ABSORB DUST SUB-UNIT:REAR	U021	108
D1947033	(D194/D195):(D203/D204-NA,-EU):HEET:RELAY DUCT:EXHAUST	U021	109
D1947042	DUCT:PCU:UPPER FRONT:SERVICE:ASS'Y	U021	129
D1947055	FILTER:DUCT:MM120	U020	97
D1947084	SEAL:DUCT:EXHAUST:ABSORB DUST SUB-UNIT:REAR	U021	110
D1947103	DUCT:PCU:UPPER FRONT:SST:ASS'Y	U021	130
D1947110	OZONE FILTER:C/T BOX	U020	98
D1947127	DUCT:PCU:FRONT:4ST:ASS'Y	U021_S001	131
		U021_S002	131
		U021_S003	131
		U021_S004	131
D1947135	OZONE FILTER:C/T BOX:MM120	U020	99
D1947136	DUCT:VACUUM:HEAT SINKER:C/T BOX	U020	100
D1947138	DUCT:C/T BOX:FAN:MM120:UPPER	U020	101
D1947140	DUCT:C/T BOX:FAN:MM120:LOWER	U020	102
D1947141	SEAL:DUCT:C/T BOX:MM120	U020	103
D1947144	BRACKET:DUCT:PCU:UPPER FRONT:AUXILIARY	U021	133
D1947146	DUCT:EXHAUST:ABSORB DUST SUB-UNIT:C/T BOX:FRONT	U020	104
D1947147	DUCT:EXHAUST:ABSORB DUST SUB-UNIT:REAR	U020	105

Exclusive Parts

Number	Part Name	Group	ID
	UB-UNIT:C/T BOX:REAR		
D1947149	COVER:DUCT:ABSORB DUST SUB-UNIT:C/T BOX	U020	106
D1947152	FAN:PCU:UPPER FRONT:ASS'Y	U021	134
D1947153	FILTER:RELAY DUCT:EXHAUST:ASS'Y	U021	111
D1947165	SHEET:DUCT:FUSING:EXIT:EXHAUST	U021	112
D1947168	COVER:NET:FUSING:VACUUM	U016	186
D1947169	BRACKET:FUSING:VACUUM:FAN	U016	187
D1947173	SEAL:DUCT:REAR:COOLING:FUSING EXIT	U021	113
D1947174	SHEET:DUCT:EXHAUST:C/T BOX:LARGE	U020	107
D1947175	SHEET:DUCT:OZONE UNIT:C/T BOX	U020	108
D1947176	SHEET:DUCT:OZONE UNIT:C/T BOX:UPPER	U020	109
D1947181	SEAL:DUCT:EXIT:GUIDE PLATE:ENTRANCE	U021	114
D1947182	SEAL:DUCT:EXIT:GUIDE PLATE:INNER BACK	U021	115
D1947183	DUCT:EXIT:GUIDE PLATE:ENTRANCE:COVER	U021	116
D1947184	DUCT:EXIT:GUIDE PLATE:EXHAUST	U021	117
D1947186	SEAL:DUCT:EXIT:GUIDE PLATE:FAN	U021	118
D1947188	DUCT:EXIT:GUIDE PLATE:ENTRANCE:LEFT	U021	119
D1947189	DUCT:EXIT:GUIDE PLATE:ENTRANCE:RIGHT	U021	120
D1947227	SEAL:HEAT PIPE:ROLLER:FAN:MM80	U021	121
D1947250	LIQUID COOLING:FAN:ASS'Y	U020_S004	110
D1947264	SEAL:DUCT:COOLING:GUIDE PLATE:1	U021	122
D1947265	SEAL:DUCT:COOLING:GUIDE PLATE	U021	123

Number	Part Name	Group	ID
	TE:2		
D1947266	SEAL:DUCT:COOLING:GUIDE PLATE:3	U021	124
D1947346	DC MOTOR:RISE:TANDEM LCT:ASS'Y:19.2W:BRUSH	U006	339
D1947377	(-AA,-NA,-EU):DECAL:SWITCH:HEATER:PAPER TRAY	U017	28
D1947380	(-AA,-NA,-EU):DECAL:SWITCH:HEATER:INTERMEDIATE TRANSFER	U017	29
D1947469	GUIDE PLATE:FEED PAPER AGAIN:ASS'Y	U006_S015	340
D1947500	PAPER FEED UNIT:PAPER BANK:ASS'Y	U006_S018	341
		U006_S019	341
D1947547	(-CHN):TANDEM LCT:LEFT:ASS'Y	U006_S008	344
D1947552	LEFT SIDE PLATE	U006_S005	346
		U006_S006	346
		U006_S007	346
		U006_S008	346
D1947635	ARM:END FENCE:LOCK	U006_S009	348
D1947657	INNER COVER:VERTICAL TRANSPORT:RIGHT:DECAL:SUB-ASS'Y	U006	363
D1947716	COVER:MAIN:LEFT:ASS'Y	U001_S007	54
D1947720	SEAL:EXTERIOR:EXIT:GUIDE PLATE:ENTRANCE	U001_S007	55
D1947741	COVER:UPPER FRONT	U001	56
D1947743	COVER:UPPER RIGHT	U001	57
D1947744	BRACKET:COVER:UPPER RIGHT	U001	58
D1947746	COVER:UPPER REAR	U001	59
D1947747	COVER:UPPER REAR:SMALL	U001	60
D1947761	(D194/D195):(D203/D204-NA,-EU):INNER COVER:5ST	U001	61
D1947801	SUPPORTING PLATE:DOOR:FRONT LEFT:ASS'Y	U001_S004	62
D1947816	SUPPORTING PLATE:DOOR:FRONT RIGHT:ASS'Y	U001_S006	63
D1947829	(D194-EU):COVER:MAIN:RIGHT:ASS'Y	U001	64
D1947880	(D194):(D203/D204-NA,-EU):MODE	U023	29

Exclusive Parts

Number	Part Name	Group	ID
	L NAME PLATE:PRO_C7100S		
D1947888	(-EU,-CHN):DECAL:DC:MAIN SWITCH	U023	30
D1947889	(-AA,-NA):DECAL:DC:MAIN SWITCH	U023	31
D1947896	(-AA,-NA):DECAL:CAUTION CHART: COPY:ORIGINAL:ENGLISH	U023	32
D1947898	(-AA,-NA):DECAL:POWER SOURCE:OFF:ENGLISH	U023	33
D1947981	(-AA,-EU):POWER SUPPLY CODE:DECAL:ASS'Y	U023_S006	34
		U023_S007	34
		U023_S008	34
		U023_S009	34
D1947982	(-NA):POWER SUPPLY CODE:DECAL:ASS'Y	U023_S010	35
		U023_S011	35
D1947983	(CHN):POWER SUPPLY CODE:DECAL:ASS'Y	U023_S012	47
		U023_S013	47
D1948515	LIQUID COOLING:PT:TAURUS-C2:ASS'Y	U020_S005	111
D1948520	SERVICE PARTS:DECAL:NEON_Y:ASS'Y	U008	121
D1948523	SERVICE PARTS:DECAL:NEON-P:ASS'Y	U008	123
D1948524	SERVICE PARTS:DECAL:IV-R:ASS'Y	U008	127
D1948875	DECAL:APPLICATION:ACCESSORY	U023	36
D1949510	OPC DRUM DIA60	U008	108
D1949590	NV-RAM	U020	112
D1949640	DEVELOPER BLACK	U008	109
D1949660	DEVELOPER CYAN	U008	110
D1949670	DEVELOPER MAGENTA	U008	111
D1949680	DEVELOPER YELLOW	U008	112
D1951270	COVER:C/T BOX:UPPER	U020	113
D1955742	(D194/D203):PCB:CTL:SERVICE PARTS:D194/D203:ASS'Y	U020	129
D1955743	(D195/D204):PCB:CTL:SERVICE PARTS:D195/D204:ASS'Y	U020	130

Number	Part Name	Group	ID
D1955770	(-NA):CABLE:5000:POWER_CONNECT	U023	37
D1957196	BRACKET:UPPER:FAN:DUCT:C/T BOX	U020	116
D1957230	(-AA,-NA):OPERATION PANEL:ASS'Y	U002_S001	65
		U002_S002	65
D1957231	(-EU):OPERATION PANEL:ASS'Y	U002_S003	66
D1957232	(-CHN):OPERATION PANEL:ASS'Y	U002_S004	67
D1957238	PCB:IOKEY:ASS'Y	U002_S001	80
		U002_S002	80
		U002_S003	80
		U002_S004	80
D1957245	ABSORPTION SHEET:LCD	U002_S001	68
		U002_S002	68
		U002_S003	68
		U002_S004	68
D1957250	PCB:LCDCAR2FT:ASS'Y	U002_S001	69
		U002_S002	69
		U002_S003	69
		U002_S004	69
D1957254	PCB:SVGA:SDUSB:ASS'Y	U002_S001	70
		U002_S002	70
		U002_S003	70
		U002_S004	70
D1957880	(D195):MODEL NAME PLATE:PRO_C7110S	U023	38
D1957984	(-AA):POWER SUPPLY CORD:ASS'Y	U023_S002	39
		U023_S003	39
D1957986	POWER SUPPLY CORD:ASS'Y	U023_S004	40
		U023_S005	40
D1957990	DECAL:CAUTION:INLET	U023	41
D1957991	DECAL:CAUTION:POWER SUPPLY CORD	U023_S002	42
		U023_S003	42
		U023_S004	42
		U023_S005	42
		U023_S006	42
		U023_S007	42
		U023_S008	42

Exclusive Parts

Number	Part Name	Group	ID
		U023_S009	42
		U023_S010	42
		U023_S011	42
		U023_S012	42
		U023_S013	42
D2033429	(D203/D204):TONER HOPPER:TONER SUPPLY:5ST:ASS'Y	U007_S023	159
D2033471	(D203/D204)SHAFT:ELECTROMAGNETIC CLUTCH:DRIVE:TRANSPORT SCREW:5ST	U007_S023	130
D2033493	HOLDER:RECEPTACLE:TONER SUPPLY UNIT:5ST:ASS'Y	U007	153
D2033500	(D203/D204):HOLDER:FRONT:TONER BOTTLE:5ST:ASS'Y	U007_S024	131
D2033505	(D203/D204):LEVER:TONER BOTTLE:5ST	U007_S024	133
D2033507	(D203/D204):NOZZLE:TONER SUPPLY	U007_S024	134
D2033508	(D203/D204):COVER:HOLDER:FRONT:TONER BOTTLE:5ST	U007_S024	135
D2033509	(D203/D204):INSULATING SHEET:PCB:RFID:CPU	U007_S024	136
D2033512	(D203/D204):GUIDE:TONER BOTTLE:5ST	U007	137
D2033515	(D203/D204):GUIDE:FRONT:TONER BOTTLE:5ST	U007	138
D2033516	(D203/D204):GUIDE:UPPER:TONER BOTTLE:5ST	U007	139
D2033521	(D203/D204):DRIVE UNIT:TONER BOTTLE:5ST:ASS'Y	U007_S025	140
D2033525	(D203/D204):COVER:DRIVE UNIT:TONER BOTTLE:5ST	U007_S025	141
D2033528	(D203/D204):COIL SPRING:DRIVE SUB-UNIT:TONER SUPPLY UNIT	U007_S025	63
D2033530	(D203/D204):DECAL:COLORED DISPLAY:TONER BANK:S	U007_S024	142
D2033531	(D203/D204):DECAL:OPERATE:TONER BOTTLE:5ST	U007	143

Number	Part Name	Group	ID
D2033540	(D203/D204):COIL SPRING:LEVER:TONER SUPPLY UNIT	U007_S024	144
D2033625	TUBE:TONER:S	U007	145
D2033710	(D203/D204):DECAL:TCRU:PUMP:5ST	U007_S023	146
D2035453	(D203/D204):PCB:RFID-AFE:S	U007_S024	150
D2035492	(D203/D204):PCB:EXDB	U019	57
D2037012	DUCT:UPPER:EXHAUST:DEVELOPMENT UNIT:S	U021	125
D2037013	DUCT:LOWER:EXHAUST:DEVELOPMENT UNIT:S	U021	126
D2037880	(D203):MODEL NAME PLATE:PRO_C7100SX	U023	49
D2047880	(D204):MODEL NAME PLATE:PRO_C7110SX	U023	50
D2051082	HEXAGON HEAD SCREW:ROUND POINT:M3X6:BK	U015_S001	271
		U015_S002	271
		U015_S003	271
		U015_S004	271
D2235308	HDD:320GB:MN500S-2:WD3200LUCT	U020_S007	85
D2582402	OIL SUPPLY ROLLER:ASS'Y	U008_S007	78
		U008_S010	78
		U008_S013	78
		U008_S016	78
		U008_S019	78
D2586166	ROLLER:INTERMEDIATE TRANSFER:ASS'Y	U009	241
D2703889	BRACKET:POSITIONING SENSOR:PEEN	U009	231
D2704670	BRACKET:MAGNET CATCH:DUPL EX	U016	236
D2704752	HANDLE:LOCK:FRAME:LOWER	U016	235
		U016_S002_S001	235
		U016_S006	235
D2704933	GUIDE PLATE LEVER HOOK	U013_S001	90
		U016	79
D2706541	SHAFT:DRIVE:FEED:ASS'Y	U006	369

Exclusive Parts

Number	Part Name	Group	ID
D2707555	(-AA,-EU):TANDEM LCT:LEFT:ASS'Y	U006_S005	374
		U006_S006	374
D3551333	SHIELDING PLATE:SAFETY SWITCH:DOOR	U007	148
D3553810	BRACKET:DETENT:RIGHT:ASS'Y	U006_S016	349
D3553828	HOLDER:STAY:GUIDE PLATE	U006	350
D3553840	BRACKET:DETENT:ASS'Y	U006_S017	351
D3553844	SHOE:HANDLE:RELEASE	U006	352
D3553858	TORSION SPRING:GUIDE PLATE:16N	U006	353
D3553875	TIMING BELT:60S2M224	U016	188
D3AK0206	MAIN:ASS'Y	U023	53
D3B01320	HINGE:LEFT:ASS'Y	U003_S001	270
D3B01350	HINGE:RIGHT:ASS'Y	U003_S001	271
D3B04711	GUIDE PLATE:PRESSURE PLATE:LEFT:ASS'Y	U003_S001_S011	282
D3B04724	CUSHION:PRESSURE PLATE:LARGE	U003_S001_S011	283
D3B04725	CUSHION:PRESSURE PLATE:SMALL	U003_S001_S011	281
D3B04730	PRESSURE PLATE:ASS'Y	U003_S001_S011	293
D3FF1451	HOLDER:FEELER:APS	U003_S001	294
D3FF2219	GUIDE:PAPER FEED BELT:FRONT	U003_S001_S004	272
D3FF2233	BRACKET:PAPER FEED BELT	U003_S001_S004	279
D3FF2851	SENSOR COVER:PHOTO INTERRUPTOR	U003_S001	274
D3FF2852	COVER:SENSOR	U003_S001	275
D3FF6071	DECAL:CAUTION:ORIGINAL:PICK-UP PAPER JAM	U003_S001_S004	276
D4122653	BUSHING:DIA6	U003_S001	88
		U003_S001_S007	88
D4122669	TENSION SPRING:GUIDE PLATE:PRESSURE:2N	U003_S001	89
D4123145	TENSION SPRING:LEVER:MISFEED REMOVAL	U003_S001	90
D4341911	TIMING BELT:60S3M402	U016_S001	189
D5161261	COVER:LED	U006	354
D5161453	DIFFUSION PLATE:LED	U006	355

Number	Part Name	Group	ID
D5165200	PCB:LED:ASS'Y	U006	356
D5224906	STEPPED SCREW:M3:DIA6:1.7MM:ROUND POINT	U003_S001	91
		U003_S001	92
D5412241	REVERSE ROLLER:PAPER FEED	U003_S001	92
D5431313	COMPRESSION SPRING:HINGE:LEFT	U003_S001	93
D5431625	GEAR:Z24:SEPARATION	U003_S001	94
D5431717	SHAFT:PULLEY:SCANNING:EXIT	U003_S001	95
D5431821	TIMING PULLEY:T33/Z24	U003_S001	96
D5431822	FLANGE:DIA24	U003_S001	97
D5433314	SHEET:SCANNING:ENTRANCE:MIDDLE	U003_S001_S010	98
		U003_S001_S012	98
D5433631	ROLLER:SCANNING:BEHIND:ASS'Y	U003_S001_S007	99
D5433635	GEAR:ROLLER:SCANNING:BEHIND	U003_S001	100
D5434382	COMPRESSION SPRING:PULL OUT	U003_S001	101
D5434393	CUSHION:GUIDE PLATE:ENTRANCE:PAPER FEED:INNER BACK	U003_S001	102
D5435125	SPRING PLATE:CABLE:CONTACT IMAGE SENSOR	U003_S001	103
D6421454	FEELER:APS	U003_S001	104
D6831362	COMPRESSION SPRING:HINGE:RIGHT	U003_S001	107
D6831385	BRACKET:SAFETY SWITCH:PAPER FEED	U003_S001	108
D6831386	SHAFT:CONTACT POINT:ON OFF DETECTOR:PAPER FEED	U003_S001	109
D6831387	TENSION SPRING:ON OFF DETECTOR:PAPER FEED	U003_S001	110
D6831413	BRACKET:SAFETY SWITCH	U003_S001	111
D6831414	SPRING PLATE:SAFETY SWITCH	U003_S001	112
D6831415	FEELER:SENSOR:ON OFF DETECTOR	U003_S001	113
D6831614	BRACKET:MOTOR:PAPER FEED	U003_S001	116
D6831615	STAY:MOTOR:PAPER FEED	U003_S001	117
D6831617	DC MOTOR:ASS'Y:20W:BRUSHLESS	U003_S001	118

Exclusive Parts

Number	Part Name	Group	ID
	SS		
D6831620	SHAFT:SEPARATION:DRIVE:INPUT:SUB-ASS'Y	U003_S001_S001	119
D6831632	SHAFT:REVERSE ROLLER:SUB-ASS'Y	U003_S001_S002	120
D6831635	GEAR:REVERSE ROLLER:DRIVE	U003_S001	121
D6831640	SHAFT:INPUT:PAPER FEED:SUB-ASS'Y	U003_S001_S003	122
D6831642	TIMING PULLEY:IDLER:PULL OUT	U003_S001	123
D6831643	GEAR:INPUT:PAPER FEED	U003_S001	124
D6831644	SPACER:SHAFT:INPUT:PAPER FEED	U003_S001	125
D6831671	BRACKET:MOTOR:PICK UP	U003_S001	126
D6831675	DC STEPPER MOTOR:DIA42:T15:52M:ASS'Y	U003_S001	127
D6831680	CAM:PICKUP	U003_S001	128
D6831682	TIMING PULLEY:PICKUP:DRIVE	U003_S001	129
D6831691	GEAR:PAPER FEED:COUPLING	U003_S001	130
D6831711	BRACKET:MOTOR:PULL OUT	U003_S001	131
D6831718	STAY:MOTOR:PULL OUT	U003_S001	132
D6831762	BRACKET:MOTOR:MIDDLE	U003_S001	133
D6831766	DC MOTOR:10W:BRUSHLESS	U003_S001	134
D6831811	BRACKET:MOTOR:SCANNING:EXIT	U003_S001	135
D6831813	TIMING PULLEY:COUPLING:SCANNING:INNER BACK	U003_S001	136
D6831814	TIMING PULLEY:COUPLING:EXIT	U003_S001	137
D6831822	DC MOTOR:20W:SCANNING:20W:BRUSHLESS	U003_S001	138
D6831841	BRACKET:TENSIONER:SCANNING:INNER BACK	U003_S001	139
D6831845	PULLEY:IDLER:DIA14	U003_S001	140
D6831851	BRACKET:TENSIONER:SCANNING:FRONT	U003_S001	141
D6831855	TIMING PULLEY:TENSIONER:SCANNING:FRONT	U003_S001	142
D6831856	TENSION SPRING:TENSION:SCANNING:FRONT	U003_S001	143

Number	Part Name	Group	ID
D6831912	BRACKET:HINGE:RIGHT	U003_S001	144
D6832110	ROLLER:PULL OUT:DRIVE	U003_S001	145
D6832112	TIMING PULLEY:ROLLER:PULL OUT:DRIVE	U003_S001	146
D6832210	ROLLER:MIDDLE:DRIVE	U003_S001	147
D6832221	GEAR:IDLER:Z18	U003_S001_S004	148
D6832222	STOPPER:SHAFT:SEPARATION:DRIVE	U003_S001	149
D6832224	GUIDE:PAPER FEED:ENTRANCE:FRONT	U003_S001_S004	150
D6832228	PICKUP ROLLER	U003_S001_S004	151
D6832229	TIMING PULLEY:GEAR:T19/Z23	U003_S001_S004	152
D6832231	BRACKET:PICKUP	U003_S001_S004	153
D6832232	TIMING PULLEY:PICKUP:T21	U003_S001_S004	154
D6832235	SHAFT:PICKUP:SUB-ASS'Y	U003_S001_S004	156
D6832236	SHEET:BRACKET:PICKUP:INNER BACK	U003_S001_S004	157
D6832240	GUIDE:PAPER FEED:ENTRANCE:INNER BACK:ASS'Y	U003_S001_S004_S001	158
D6832242	SHEET:GUIDE:PAPER FEED:INNER BACK	U003_S001_S004_S001	159
D6832272	LEVER:PICKUP ROLLER:RISE	U003_S001_S004	160
D6832311	TORQUE LIMITER MECHANICAL CLUTCH:SEPARATOR	U003_S001	161
D6832393	HOLDER:ORIGINAL TABLE	U003_S001	162
D6832417	SHEET:ENTRANCE:SEPARATION PAD	U003_S001	163
D6832510	GUIDE PLATE:PAPER FEED:LOWER:ASS'Y	U003_S001	164
D6832728	STOPPER:RELEASE:SHAFT:BASE	U003_S001	165
D6832729	JOINT:RISING TRAY:AUXILIARY	U003_S001	166
D6832733	FEELER:SENSOR:ORIGINAL SENSOR	U003_S001	167
D6832742	CUSHION:STOPPER PAWL	U003_S001	168
D6832743	SHEET:CUSHION:STOPPER PAWL	U003_S001	169
D6832747	PAD:SIDE FENCE:SMALL	U003_S001	170
D6832748	PAD:SIDE FENCE:LARGE	U003_S001	171
D6832752	LEVER:RISE:BASE	U003_S001	172

Exclusive Parts

Number	Part Name	Group	ID
D6832755	SHAFT:RISE:BASE:SUB-ASS'Y	U003_S001	173
D6832781	ORIGINAL TABLE:BEHIND	U003_S001	174
D6832912	FEELER:PAPER SIZE SENSOR	U003_S001	175
D6832913	SHEET:SENSOR:SEPARATION	U003_S001	265
D6833111	ROLLER:SCANNING:ENTRANCE:DRIVE	U003_S001	176
D6833150	ROLLER:SCANNING:EXIT:DRIVE:ASS'Y	U003_S001_S006	177
D6833155	TIMING PULLEY:ROLLER:SCANNING:EXIT:DRIVE	U003_S001	178
D6833221	GUIDE:SCANNING:UPPER	U003_S001	179
D6833251	GROUND PLATE:ROLLER	U003_S001	180
D6833260	SHEET:SCANNING:EXIT:UPPER:ASS'Y	U003_S001	181
D6833311	BRACKET:GUIDE:SCANNING:UPPER	U003_S001	182
D6833361	SPRING PLATE:GUIDE PLATE:SCANNING	U003_S001	184
D6833411	GUIDE:SCANNING:ENTRANCE:LOWER:SUB-ASS'Y	U003_S001_S010	185
D6833421	BASE:SCANNING:ENTRANCE:LOWER	U003_S001	186
D6833422	LEVER:PRESSURE RELEASE	U003_S001	187
D6833510	SHAFT:LEVER:MISFEED REMOVAL:ASS'Y	U003_S001	188
D6833616	BRACKET:DISCHARGE BRUSH	U003_S001	189
D6833621	GUIDE:EXIT:LOWER:SUB-ASS'Y	U003_S001	190
D6833643	COMPRESSION SPRING:CONTACT IMAGE SENSOR:EXIT	U003_S001_S008	192
D6833644	SHEET:GUIDE:CONTACT IMAGE SENSOR:EXIT:LOWER	U003_S001_S008	193
D6833645	ROLLER:MIDDLE:DRIVEN	U003_S001	194
		U003_S001_S008	194
D6833646	GUIDE:CONTACT IMAGE SENSOR:EXIT:LOWER:ASS'Y	U003_S001_S008	278
D6833651	COVER:SCANNING:EXIT	U003_S001	195
D6833662	GUIDE PLATE:CONTACT IMAGE SENSOR:ENTRANCE:ASS'Y	U003_S001_S009	196

Number	Part Name	Group	ID
D6833666	LEVER:GUIDE PLATE:CONTACT IMAGE SENSOR:FRONT	U003_S001_S009	197
D6833667	LEVER:GUIDE PLATE:CONTACT IMAGE SENSOR:REAR	U003_S001_S009	198
D6833710	ROLLER:CONTACT IMAGE SENSOR:EXIT:DRIVE:PRESS FIT	U003_S001	199
D6833714	TIMING PULLEY:ROLLER:CIS:EXIT:DRIVE	U003_S001	200
D6833715	TIMING PULLEY:ROLLER:CIS:EXIT:FRONT	U003_S001	201
D6833811	GUIDE PLATE:EXIT:UPPER	U003_S001	202
D6833812	DISCHARGE BRUSH:EXIT	U003_S001	203
		U003_S001_S009	203
D6833911	ROLLER:EXIT:DRIVE	U003_S001	204
D6833915	TIMING PULLEY:ROLLER:EXIT:DRIVE	U003_S001	205
D6834323	SHAFT:CONTACT POINT:GUIDE:APER FEED	U003_S001	206
D6834325	BRACKET:GUIDE:PAPER FEED:FRONT	U003_S001	207
D6834328	BRACKET:GUIDE:PAPER FEED:INNER BACK	U003_S001	208
D6834341	BRACKET:PULL OUT:DRIVEN	U003_S001	209
D6834343	PRESSURE PLATE:PICKUP	U003_S001_S013	210
D6834344	COMPRESSION SPRING:PICKUP:2.1N	U003_S001_S013	211
D6834345	DISCHARGE BRUSH:EXIT:L37	U003_S001	212
D6834350	DRIVEN ROLLER:PULL OUT	U003_S001	213
D6834351	LINK:STOPPER:COVER:PAPER FEED	U003_S001_S013	214
D6834361	SHAFT:CONTACT POINT:GRIP	U003_S001_S013	215
D6834367	GROUND PLATE:HOOK:INNER BACK	U003_S001_S013	216
D6834372	HOOK:CONTACT POINT:FRONT:GRIP	U003_S001_S013	217
D6834374	HOOK:CONTACT POINT:INNER BACK:GRIP	U003_S001_S013	218
D6834421	SHAFT:EXIT:DRIVEN	U003_S001	219

Exclusive Parts

Number	Part Name	Group	ID
D6834430	ROLLER:EXIT:DRIVEN	U003_S001	220
D6834441	HOLDER:CUSHION:PRESSURE PLATE	U003_S001	221
D6834442	TAPE:PRESSURE PLATE	U003_S001	222
		U003_S001_S014	222
D6834722	CUSHION:TAPE:SMALL	U003_S001_S011	225
D6835111	GUIDE:HARNESS:MAIN	U003_S001	228
D6835121	GUIDE:HARNESS:SUB	U003_S001	229
D6835863	CONTACT IMAGE SENSOR:ASS'Y	U003_S001	230
D6842171	PAPER FEED BELT	U003_S001_S004	231
D6882142	PLAIN SHAFT BEARING:6X8X10	U009	211
D6902425	DISCHARGE BRUSH:SHORT:FRONT	U003_S001	232
D7101333	SHIELDING PLATE:OPEN AND CLOSE:SENSOR:DOOR	U001	65
D7306036	PCB:GIGAETHERNET:ASS'Y	U020_S008	117
D7312202	SHAFT:SEPARATION:ASS'Y	U003_S001_S004	277
D7312239	COVER:PICKUP ROLLER	U003_S001_S004	234
D7312731	BASE:ORIGINAL TABLE	U003_S001	266
D7312734	COVER:LOWER:BASE	U003_S001	235
D7312746	SIDE FENCE:ORIGINAL TABLE	U003_S001	236
D7312751	RAIL:SIDE FENCE	U003_S001	237
D7312771	ORIGINAL TABLE:FACE FRONT	U003_S001	238
D7312912	GUIDE PLATE:PULL OUT:LOWER:DOUBLE FEED SENSOR	U003_S001	240
D7312913	GUIDE PLATE:PULL OUT:LOWER	U003_S001	239
D7313390	GUIDE PLATE:SCANNING:CONTACT:0.6MM:PEEN	U003_S001	280
D7313511	HOOK:OPTICAL READING UNIT:FRONT	U003_S001	241
D7314112	COVER:FRONT RIGHT	U003_S001	242
D7314113	COVER:FRONT	U003_S001	243
D7314211	COVER:REAR	U003_S001	244
D7314311	GUIDE:PAPER FEED:UPPER:SUB-ASS'Y	U003_S001_S012	268
D7314315	GUIDE:PAPER FEED:UPPER:DOUBLE FEED SENSOR	U003_S001	267
D7314336	CUSHION:STOPPER:FEELER:ORIGINAL	U003_S001_S013	247

Number	Part Name	Group	ID
	GINAL SENSOR		
D7314352	BRACKET:PRESSURE:PICKUP	U003_S001_S013	248
D7314370	COVER:PAPER FEED:ASS'Y	U003_S001_S013	249
D7314371	GRIP:COVER:PAPER FEED	U003_S001_S013	250
D7314412	TRAY:EXIT:AUXILIARY:LARGE	U003_S001	252
D7314413	TRAY:EXIT:AUXILIARY:SMALL	U003_S001	253
D7314418	TRAY:EXIT	U003_S001	251
D7314510	COVER:LOWER:ASS'Y	U003_S001_S014	254
D7314611	COVER:LEFT LOWER	U003_S001	255
D7315415	PCB:URB:DF:ASS'Y	U003_S001	297
D7315530	PCB:MAIN CONTROL BOARD:DOCUMENT FEEDER:ASS'Y	U003_S001	256
D7316011	DECAL:SIZE:ORIGINAL	U003_S001	257
D7316022	DECAL:CAUTION:ORIGINAL:MANY LANGUAGES	U023	43
D7316031	DECAL:SET:ORIGINAL TABLE	U003_S001	258
D7316041	DECAL:BASE:ORIGINAL	U003_S001	259
D7316051	DECAL:DESIGN SKETCH:MISFEED REMOVAL:P	U003_S001	260
D7316241	DECAL:STOPPER:SEPARATION UNIT	U003_S001	261
G0143291	SNAP RING - PICK UP	U009	212
G0291980	DECAL - LD	U005_S001	12
		U005_S002	12
		U005_S003	12
		U008_S008_S001	115
		U008_S011_S001	115
		U008_S014_S001	115
		U008_S017_S001	115
		U008_S020_S001	115
G0602296	BALL BEARING:8X16X5MM	U013_S001	246
G0602652	BUSHING - M4	U003_S001	262
		U003_S001_S008	262
G0603293	SPACER:6.1X8.5X0.5	U013_S001	247
G0603602	CAP:BOTTLE	U012_S007	83
G0603945	TIMING BELT - TRANSFER BELT DRIVE	U018_S008	116
		U018_S009	116
		U018_S010	116

Exclusive Parts

Number	Part Name	Group	ID
		U018_S011	116
		U018_S012	116
G1073834	RIVET - 2.0	U009	213
		U013_S001	248
		U018	117
G1781134	HEXAGONAL BOLT:M20X70	U022	44
G1781141	HOLDER:STAND:M20	U023	44
G1781602	ARM:SAFETY SWITCH:UPPER:AS S'Y	U013	249
G1783593	TENSION SPRING:STOPPER	U016	190
G1784018	CASE:COATING BAR:TRANSFER ROLLER	U011_S001	42
G1784651	SUPPORTING PLATE:GUIDE PLATE	U016	191
G1784746	SLIDE RAIL:EXIT	U022	45
G1784793	SPRING:REVERSE:GATE	U016	195
G1784794	SPRING:TENSIONER:EXIT	U016	196
G1784798	SPRING:SWITCHBACK:GATE	U016	197
G1784808	BRACKET:PRESSURE:ROLLER	U013_S001	252
		U016	198
G1784813	STOPPER:LEFT LOWER:FRAME	U016	199
G1784817	SPRING:PRESSURE:ROLLER:DUPLICATE	U013_S001	253
		U016	200
G1784818	SPRING:PULL OUT:LOCK:EXIT	U013_S001	254
		U016	201
G1784822	SPRING:PRESSURE:0.8N:DIA0.65	U016	202
G1784828	STAY:LOCK:LEVER:LEFT LOWER	U016	203
		U016_S002	203
G1784866	COMPRESSION SPRING:EXIT:CONNECTOR	U013	255
		U022	62
G1784890	SPRING PLATE:DUPLICATE:GUIDE:LOWER	U016	205
G1784895	SHEET:DUPLICATE:SPRING PLATE	U016	206
G1784900	COVER:DC STEPPER MOTOR:MM56	U013_S001	256
		U016	207
G1784907	HOLDER:PRESSURE ROLLER:DUPLICATE	U016	208
G1784908	COIL SPRING:LEFT LOWER:LOCK	U016	209

Number	Part Name	Group	ID
G1784909	SCREW:TRANSPORT	U016	210
G1784912	PULLEY:S2M:30T	U013_S001	257
G1784916	SCREW:ROUND POINT	U016	211
G1785029	GEAR:DECURA:Z20/M1	U006	357
G1785397	PCB:SIFB:CROSS	SPECIAL TOOLS	19
G1786352	GUIDE PLATE:ENCODER	U009	215
		U013_S001	258
		U018	118
G1786392	HOUSING:LOWER:COVER	U009	216
G1786393	SLEEVE:WIRE:LOWER:COVER	U009	217
G1786394	WIRE:STOPPER:LOWER:COVER	U009_S002	218
		U009_S003	218
		U009_S004	218
		U009_S005	218
		U009_S006	218
		U009_S007	218
G1786621	COVER:RELEASE PLATE:BLADE	U010_S001	62
G1786679	JOINT:DRIVE:BRUSH ROLLER	U015_S001	240
		U015_S002	240
		U015_S003	240
		U015_S004	240
G1786767	COATING BAR:TRANSFER ROLLER	U011_S001	43
G1787392	DISC:SENSOR:CAM	U013_S001	259
G1787453	ARM:ON-OFF:TRANSPORT ROLLER	U013_S001	260
		U016_S010	212
G1787515	CONNECTOR GUIDE PIN:CONNECTOR	U013	261
		U022	63
G1787618	PLATE:FIX:BAND	U013_S001	262
		U016	213
G1787633	HOOK:GUIDE PLATE:DUPLICATE:ASS'Y	U013_S001	263
G1787656	TENSION SPRING:TENSIONER	U016	214
G1787660	PRESSURE ROLLER:TRANSPORT ROLLER	U013_S001	264
G1787664	SPACER	U013_S001	265
		U013_S001_S002	265
G1787694	COVER:DC STEPPER MOTOR:MM	U013_S001	266

Exclusive Parts

Number	Part Name	Group	ID
	42		
G1787717	GEAR:SHIFT:ROLLER	U013_S001_S002	267
G1787743	BOSS:POSITIONING PIN:TRANSP ORT UNIT:NO.1	U013_S001	268
		U016	215
		U022	46
G1787744	BOSS:POSITIONING PIN:TRANSP ORT UNIT:NO.2	U013_S001	269
		U016	216
		U022	47
G1787781	GEAR:PULLEY	U013_S001	270
G1787793	SCREW:REGISTRATION:FIX	U013	271
G1788350	WRENCH:HEXAGONAL BOLT	U023	45
G4042810	SPRING PLATE - 2ND MIRROR	U004_S004	65
G5701225	SENSOR SHIELDING PLATE	U004	66
GA082007	PLAIN SHAFT BEARING:4XDIA6DI A8	U015_S001	241
		U015_S002	241
		U015_S003	241
		U015_S004	241
GA082010	BUSHING:DIA6:DIA10:9	U012	84
GA143003	SCREW:MM5:2.5MM	U014_S001	23
GW010007	PHOTO REFLECTION SENSOR:EXI T	U006	358
		U006_S018	358
		U006_S019	358
		U013_S001	272
		U014_S001	24
		U016	217
GW020024	PHOTO INTERRUPTOR:LG2A24BL1 :GF	U006_S018	371
		U006_S019	371
GW230008	TONER END SENSOR	U007_S002	149
		U007_S005	149
		U007_S008	149
		U007_S011	149
		U007_S013	149
		U007_S015	149
		U007_S017	149
		U007_S019	149
	U007_S023_S001	149	
GX640028	FAN MOTOR DC24V 1.92W	U013_S001	273

Number	Part Name	Group	ID
		U021	127
H0602126	BUSHING - M6X7	U003_S001_S004	263
H0722216	COMPRESSION SPRING	U016	218
J0155505	DRAWER:CONNECTOR:USED DEV ELPER:PLUG	U008_S008	116
		U008_S011	116
		U008_S014	116
		U008_S017	116
		U008_S020	116
M0261778	GUIDE:FFC	U004	67
M0261815	CLAMP:MIRROR:NO.1	U004_S002	68
M0262872	TENSION SPRING:GRIP	U016_S002	219
M0447747	CAP:COVER:REAR	U001	66
M0771766	KNOB:VARIABLE RESISTOR	U002_S001	72
		U002_S002	72
		U002_S003	72
		U002_S004	72
M0771767	KEYTOP:START	U002_S001	73
		U002_S002	73
		U002_S003	73
		U002_S004	73
M0771768	KEYTOP:10KEY	U002_S001	74
		U002_S002	74
		U002_S003	74
		U002_S004	74
M0771769	KEYTOP:RESET SWITCH	U002_S001	75
		U002_S002	75
		U002_S003	75
		U002_S004	75
M0771800	TOUCH PANEL:10.4INCH	U002_S001	76
		U002_S002	76
		U002_S003	76
		U002_S004	76
M0771861	TUBE TYPE LAMP:TAC:ASS'Y	U023_S001	46
M0774862	TRANSPORT ROLLER:DRIVEN:DU PLEX:DIA18X2	U006	359
		U013_S001	274
		U016	220
		U017	30
M0B15888	HARNESS:DEBUG:MONITOR:SER	SPECIAL TOOLS	20

Exclusive Parts

Number	Part Name	Group	ID
	VICE		
M0EB2524	GUIDE PLATE:SLIDE RAIL:PCU	U008	149
M0EB4343	ROLLER:PLATE	U015_S005	274
M0EB4398	DUCT:PRESSURE:CONNECTING:A	U015	275
M0EB4670	RADIAL BALL BEARING:REGISTRATION:DRIVEN:FRONT	U013_S001	294
M0EB4671	RADIAL BALL BEARING:REGISTRATION:DRIVEN:REAR	U013_S001	295
M0EB5907	BRACKET:BASE:ELECTRIC POTENTIAL SENSOR:P4	U019	70
M0EB7873	COVER:TONER SUPPLY:UPPER:ASS'Y	U001_S001	72
M0EB7960	DOOR:TONER SUPPLY	U001	73
M1305245	PCB:DDR3-DIMM:RC-C:1GB:ASS'Y	U020	118
M2054908	BRACKET:DUPLEX:REVERSE:SENSOR	U016	132
M3791627	TRANSPORT ROLLER:DRIVEN	U016_S003	221
		U016_S004	221
		U016_S012	221
VSSG9002	FLUOTRIBO MG GREASE : 100G	SPECIAL TOOLS	12

Standard Parts



03130040N
SCREW:M3X4

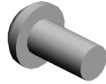

03130060N
SCREW - M3X6

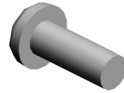

03130080N
PAN HEAD SCREW:M3X8



03130120N
PAN HEAD SCREW:M3X12

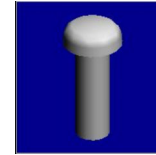

03140060N
SCREW - M4X6



03140120N
SCREW - M4X12



03140180N
PAN HEAD SCREW:M4X18

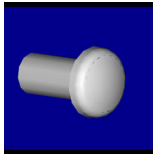

03150100N
PAN HEAD SCREW:M5X10

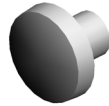

03530030N
SCREW:M3X3



03530040N
SCREW - M3X4



03530050N
SCREW-M3X5



03530060N
BIND SCREW - M3X6



03530080N
SCREW:M3X8



03530100N
SCREW-M3X10



03540040N
SCREW-M4X4



03540060N
SCREW-M4X6



03540080N
SCREW:M4X8



03540120N
SCREW M4X12



03540400N
SCREW:M4X40



03540450N
SCREW:M4X45



03603005N
SCREW - M3X5



03603005P
SCREW:M3X5



03603006N
SCREW - M3X6



03603008N
SCREW:M3X8



03603014N
SCREW - M3X14



03603020N
SCREW:M3X20



03603030N
SCREW:M3X30

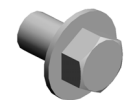

03604006N
SCREW - M4X6

Standard Parts



03604008N
SCREW - M4X8

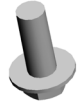

03604010N
SCREW:M4X10



03604014N
SCREW - M4X14



03604020N
SCREW:M4X20



03604030N
SCREW:M4X30



04340060N
PAN SELF-TAPPING SCREW:
M4X6



04340200N
PAN SELF-TAPPING SCREW:
4X20



04503008N
TAPPING SCREW - M3X8



04503010N
TAPPING SCREW - M3X10



04503012N
TAPPING SCREW:3X12



04503035N
TAPPING SCREW:3X35

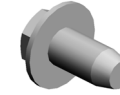

04504008N
TAPPING SCREW - M4X8



04504010N
TAPPING SCREW:M4X10



04504012N
TAPPING SCREW:4X12



04513006N
TAPPING SCREW - 3X6



04513008N
TAPPING SCREW - M3X8



04514006N
TAPPING SCREW - 4X6



04514008N
TAPPING SCREW:4X8



04514010N
TAPPING SCREW:4X10

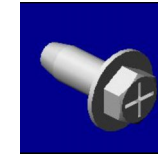

04514012N
TAPPING SCREW:4X12



04514025N
TAPPING SCREW:M4X25



04523006N
BINDING SELF-TAPPING SC
REW:3X6



04523008N
TAPPING SCREW - M3X8



04523010P
BINDING SELF-TAPPING SC
REW:3X10

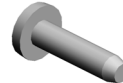

04523012N
BINDING SELF-TAPPING SC
REW:M3X12

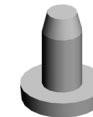

04524008N
TAPPING SCREW:M4X8



04524010N
BINDING SELF-TAPPING SC
REW:4X10



04534006N
BINDING SELF TAPPING SC
REW:4X6

Standard Parts



04534008N
BINDING SELF TAPPING SC
REW:4X8



04543006Q
TAPPING SCREW - M3X6



04543008Q
TAPPING SCREW:3X8



04543010Q
TAPPING SCREW:3X10



04543014Q
TAPPING SCREW:3X14



04544006Q
TAPPING SCREW:4X6

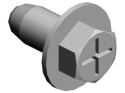

04544008Q
TAPPING SCREW - M4X8



04544010Q
TAPPING SCREW:4X10



04583010N
HEXAGON HEAD TAPPING S
CREW:3X10

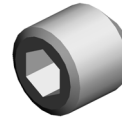

05730030E
HEXAGON HEADLESS SET S
CREW - M3X3



06320140G
PARALLEL PIN



06330140G
PARALLEL PIN - 3X14

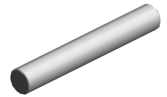

06330200G
PIN - M3X20



07010060N
WASHER DIA6



07073050N
BUSHING:DIA3X5

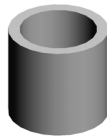

07074050N
BUSHING - 4X5



07080040N
WASHER - DIA4



07080060N
WASHER:DIA6



07080080N
WASHER-DIA8



07200030E
RETAINING RING - M3



07200040E
RETAINING RING - M4



07200060E
RETAINING RING - M6



07200080E
RETAINING RING - M8



07250200E
RETAINING RING C - M20



07250220E
RETAINING RING - M22



07250250E
RETAINING RING C - M25



07403008
BALL BEARING - 8X22X7

Standard Parts



07403706
BALL BEARING - M6X10X3



07403804
BALL BEARING:DIA4XDIA9X4



07403906
BALL BEARING - 6X15X5



07413006
BALL BEARING - 6X17X6MM



07413506
BALL BEARING - 6X12X4 MM

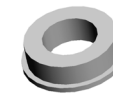

07413706
BALL BEARING - 6X10X3



07413708
BALL BEARING - 8X12X3.5M
M



07423808
BALL BEARING - 8X16X5

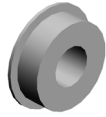

07433806
RADIAL BALL BEARING:DIA6
XDIA13X5

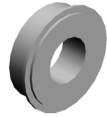

07433808
RADIAL BALL BEARING:DIA8
XDIA16X5



07433906
RADIAL BALL BEARING:DIA6
XDIA15X5



07922054C
SYNCHRONOUS BELT:40S2
M108:CR



07922061C
SYNCHRONOUS BELT:40S2
M122:CR



07922063C
SYNCHRONOUS BELT:40S2
M126:CR



07922065C
SYNCHRONOUS BELT:40S2
M130:CR



07922076C
SYNCHRONOUS BELT:40S2
M152:CR



07922079C
SYNCHRONOUS BELT:40S2
M158:CR



07922080C
SYNCHRONOUS BELT:40S2
M160:CR



07922101C
SYNCHRONOUS BELT:40S2
M202:CR



07922129C
SYNCHRONOUS BELT:40S2
M258:CR

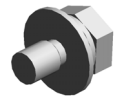

08010231
HEXAGONAL HEAD BOLT W/
WASHER:M3X6



08010237
HEXAGONAL BOLT:DOUBLE
SCREW:M4X12



08025220
TAPPING SCREW - M4X8



08025312
TAPPING SCREW:WASHER:3
X10



08025320
HEXAGON HEAD TAPPING S
CREW:ES:3X10



08025324
HEXAGON HEAD TAPPING S
CREW:PF:4X10

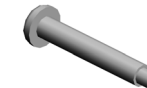

08030058
STEPPED SCREW

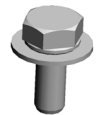

08046123
HEXAGONAL BOLT:W/WASH
ER:M3X8

Standard Parts



08046128
HEXAGONAL BOLT:DOUBLE
SCREW:M3X10



08050088
RETAINING RING - M6



08050089
RETAINING RING - M4



08050092
RETAINING RING - 3M



08050103
RETAINING RINGS-E:SILENC
ER:DIA3



08050104
RETAINING RINGS-E:SILENC
ER:DIA4



08050106
RETAINING RINGS-E:SILENC
ER:DIA6



08053384
BUSHING - 5MM



08053568
RADIAL BALL BEARING:DIA8
XDIA14X4

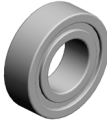

08053573
RADIAL BALL BEARING:DIA8
XDIA16X5

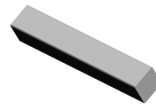

09300404A
PARALLEL KEY:4X4X25



09505010N
SCREW:SPRING WASHER:M
5X10



09513006N
SCREW - M3X6

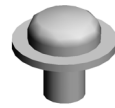

09514006N
SCREW:POLISHED ROUND:
M4X6

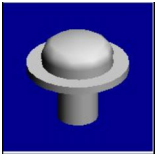

09514010N
SCREW:POLISHED ROUND:
M4X10



09543006N
SCREW - M3X6

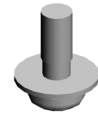

09543008N
SCREW - M3X8



09543010N
SCREW:POLISHED ROUND/
SPRING:M3X10



09543012N
SCREW - M3X12

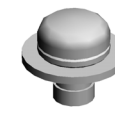

09544006N
SCREW:POLISHED ROUND/
SPRING:M4X6



09544008N
SCREW - M4X8

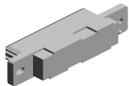

11029803
CONNECTOR:6-292235-0

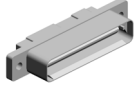

11029805
CONNECTOR:6-292233-0

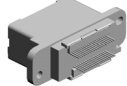

11035758
CONNECTOR:RFCP-36W0-E



11035759
CONNECTOR:RFCP-44W0-E

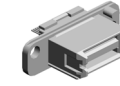

11035760
CONNECTOR:36W0R-RFC-E
GD(LF)(SN)

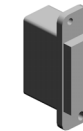

11035761
CONNECTOR:44W0R-RFC-E
GD(LF)(SN)

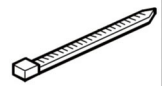

11050042
WIRE BAND

Standard Parts



11050328
HARNESS CLAMP - ES-0505



11050409
CARD SPACER- 6.4MM



11050410
CARD SPACER - 9.4MM

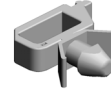

11050487
HARNESS CLAMP



11050488
HARNESS CLAMP



11050489
HARNESS CLAMP - LWS 131
6

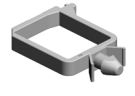

11050490
HARNESS CLAMP - IWS-2218



11050508
HARNESS CLAMP - LWS-071
1



11050511
HARNESS CLAMP - LWS-030
6ZC

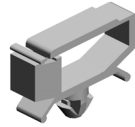

11050516
CLAMP



11050517
HARNESS CLAMP - LWS-211
1Z

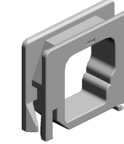

11050518
EDGE SADDLE - LES-1010



11050529
NYLON CLAMP-EMT-3N



11050530
NYLON CLAMP-EMT-4N



11050534
CLAMP



11050551
CLAMP:LES-0505



11050559
CLAMP:EMT-5N

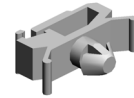

11050600
CLAMP:LWSM-0306-2M

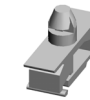

11050601
CLAMP:LWSM-0511-2M



11050603
CLAMP:FFC-20



11050621
CLAMP - SB-2712



11050683
CLAMP:LWSR-0511S

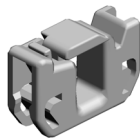

11050692
CLAMP:LES-0503

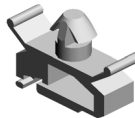

11050713
CLAMP:LWSM-0306H GRAY



11050717
CLAMP:JDW-1S



11050723
CLAMPS:WES-0507



11050724
CLAMPS:WES-1210

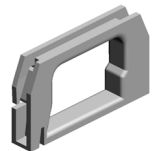

11050725
CLAMPS:WES-1117

Standard Parts

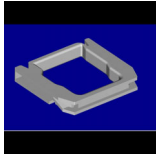

11050726
CLAMPS:WES-2217



11050739
CLAMP:JDW-3S

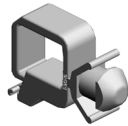

11050741
CLAMP:LWSM-0606-2.4M



11050744
CLAMP:F-LWS-0711

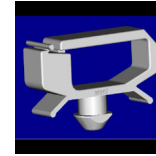

11050751
CLAMP:LWSM-0606-3.2M



11050758
CLAMP:LWSM-0306A

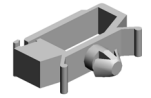

11050760
CLAMP:LWSM-0511A



11050761
CLAMP:LWS-0511A



11050768
CLAMP:LES-0912

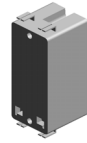

11071281
FUSE:BJS2012F2

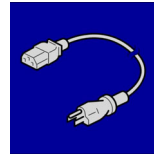

11500454
(-AA,-EU):POWER SUPPLY C
ODE:250V:16A

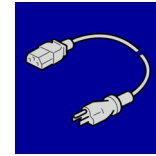

11500455
(-NA):POWER SUPPLY CODE
250V:20A

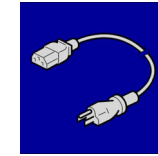

11500466
(-CHN):POWER SUPPLY COD
E:250V:16A

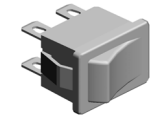

12042570
ROCKER SWITCH:SDDJE132
00



12042612
MICRO SWITCH:D3V-16506-3
C25

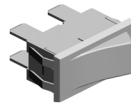

12042614
SWITCH AC250V/16A

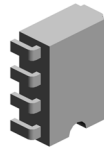

14077899
EEPROM:BR24T256-W

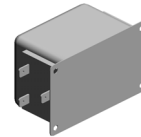

16071799
FILTER - SUP-ET20-ER-0

PM Part List

Number	Part Name	Num	Group	ID
AE010122	HOT ROLLER:DIA54	4	U015_S001	73
			U015_S002	73
			U015_S003	73
			U015_S004	73
AE020229	PRESSURE ROLLER:DIA65	4	U015_S001	75
			U015_S002	75
			U015_S003	75
			U015_S004	75
AE030049	BALL BEARING -20X32X7	8	U015_S001	77
			U015_S002	77
			U015_S003	77
			U015_S004	77
AE030086	RADIAL BALL BEARING:DIA25XDIA37X7	16	U015_S001	78
			U015_S002	78
			U015_S003	78
			U015_S004	78
AE045064	WEB:SUB-ASS'Y	1	U015_S005	80
AF031080	PAPER FEED ROLLER:FEED	2	U006_S018	135
			U006_S019	135
AF032080	PAPER FEED ROLLER:SEPARATE	2	U006_S018	136
			U006_S019	136
D0742424	SEAL:BLADE:CLEANING:FRONT	5	U008_S007	46
			U008_S010	46
			U008_S013	46
			U008_S016	46
D0742425	SEAL:BLADE:CLEANING:REAR	5	U008_S007	47
			U008_S010	47
			U008_S013	47
			U008_S016	47
D0742459	JOINT:CLEANING UNIT	5	U008_S007	49
			U008_S010	49
			U008_S013	49
			U008_S016	49
D0744300	SPRING PLATE:CLEANING UNIT:FUSING	1	U015_S005	156

Number	Part Name	Num	Group	ID
D0746265	BLADE:TRANSFER ROLLER:ASS'Y	1	U011_S001	25
D0746424	BLADE:CLEANING:BELT CLEANING:ASS'Y	1	U010_S001	20
D0746446	BRUSH:APPLY:BELT CLEANING	1	U010_S001	29
D0746450	COATING BAR:ASS'Y	1	U010_S001_S002	30
D0746457	BLADE:APPLY:ASS'Y	1	U010_S001	33
D0747111	FILTER:PREVENTFENCE	4	U020	58
D0A56050	FLAT BELT-TRANSFER:ASS'Y	1	U009	234
D0A56252	TRANSFER ROLLER:18MIC	1	U011_S001	46
D1362365	CLEANING BLADE:ASS'Y	5	U008_S007	77
			U008_S010	77
			U008_S013	77
			U008_S016	77
			U008_S019	77
D1362411	COATING BAR:ASS'Y	5	U008_S007	79
			U008_S010	79
			U008_S013	79
			U008_S016	79
			U008_S019	79
D1362441	BLADE:APPLY:ASS'Y	5	U008_S007	82
			U008_S010	82
			U008_S013	82
			U008_S016	82
			U008_S019	82
D1363431	FILTER:DEVELOPMENT	5	U008_S008	83
			U008_S011	83
			U008_S014	83
			U008_S017	83
			U008_S020	83
D1942150	CHARGE UNIT:ASS'Y	5	U008_S006	84
			U008_S009	84
			U008_S012	84
			U008_S015	84
			U008_S018	84
D1942485	SEAL:BLADE:APPLY	10	U008_S007	97

PM Part List

Number	Part Name	Num	Group	ID
			U008_S010	97
			U008_S013	97
			U008_S016	97
			U008_S019	97
D1942550	GEAR:CLEANING:DRUM:SERV VICE	5	U008_S007_S002	103
			U008_S010_S002	103
			U008_S013_S002	103
			U008_S016_S002	103
			U008_S019_S002	103
D1944180	FLAT BELT-FUSING:DIA80:SE EAL	4	U015_S001	198
			U015_S002	198
			U015_S003	198
			U015_S004	198
D1944328	ROLLER:POLISH	1	U015_S006	233
D1946231	ROLLER:OPPOSED:TRANSFER: PAPER:ASS'Y	1	U009_S008	189
D1946301	SEPARATION CORONA:ASS' Y	1	U011_S001_S001	41
D1947135	OZONE FILTER:C/T BOX:MM 120	5	U020	99
D1947153	FILTER:RELAY DUCT:EXHAU ST:ASS'Y	5	U021	111
D1949510	OPC DRUM DIA60	5	U008	108
D2582402	OIL SUPPLY ROLLER:ASS'Y	5	U008_S007	78
			U008_S010	78
			U008_S013	78
			U008_S016	78
			U008_S019	78
D2586166	ROLLER:INTERMEDIATE TR ANSFER:ASS'Y	5	U009	241
D5412241	REVERSE ROLLER:PAPER FE EED	1	U003_S001	92
D6832228	PICKUP ROLLER	1	U003_S001_S004	151
D6842171	PAPER FEED BELT	1	U003_S001_S004	231
G1786767	COATING BAR:TRANSFER R OLLER	1	U011_S001	43
M0EB4343	ROLLER:PLATE	1	U015_S005	274

Design Change List

Number	Title	Set	Old Part		New Part		Index No.		Q'ty	Interchg		Reason	Cut-in S/N
			P/N	Name	P/N	Name	Group	ID		Indiv.	Set		
202404-01	2404Modification	-	B2291688	HEATER:OPTION :230V:9W	AX400250	HEATER:230V:9 W:THERMOFUSE :110βC	U024	3	1	O/O			
202402-01	2402Modification	-	M0EB7959	DOOR:TONER S UPPLY	M0EB7960	DOOR:TONER S UPPLY	U001	73	1	O/O			
202402-02	2402Modification	-	D1947129	DUCT:PCU:FRO NT:5ST:ASS'Y	D0A57129	DUCT:PCU:FRO NT:5ST:ASS'Y	U021	143	1	O/O			
202311-01	2311Modification	-	D0596646	INNER COVER:T ANDEM LCT:LEF T	D0EZ6646	INNER COVER:T ANDEM LCT:LEF T	U006_S005	376	1	O/O			
							U006_S006	376	1				
							U006_S007	376	1				
							U006_S008	376	1				
202311-02	2311Modification	-	D0744398	DUCT:PRESSUR E:CONNECTING: A	M0EB4398	DUCT:PRESSUR E:CONNECTING: A	U015	275	1	O/O			
202308-01	2308Modification	-			D0746379	ROLLER:TENSIO N:ASS'Y	U009_S001 _S001	243	1				
202306-01	2306Modification	-	AW020207	PHOTOINTERRU PTOR:FLAT:PICH 2MM:M4	AW020249	PHOTOINTERRU PTOR:FLAT:PICH 2MM:M4	U022	65	1	O/O			
202306-02	2306Modification	-	D1955719	(D195/D204):PCB :CTL:SERVICE P ARTS:D195/D204 :ASS'Y	D1955743	(D195/D204):PCB :CTL:SERVICE P ARTS:D195/D204 :ASS'Y	U020	130	1	O/O			
202306-03	2306Modification	-	D1955718	(D194/D203):PCB :CTL:SERVICE P ARTS:D194/D203 :ASS'Y	D1955742	(D194/D203):PCB :CTL:SERVICE P ARTS:D194/D203 :ASS'Y	U020	129	1	O/O			
202306-04	2306Modification	-			D7315415	PCB:URB:DF:AS S'Y	U003_S001	297	1				
202303-01	2303Modification	-	D0A52552	GUIDE PLATE:SL	M0EB2524	GUIDE PLATE:SL	U008	149	4	O/O			

Design Change List

Number	Title	Set	Old Part		New Part		Index No.		Q'ty	Interchg		Reason	Cut-in S/N
			P/N	Name	P/N	Name	Group	ID		Indiv.	Set		
		-		IDE RAIL:PCU		IDE RAIL:PCU							
202302-01	2302Modification	-	D1945908	BRACKET:BASE: ELECTRIC POTE NTIAL SENSOR	M0EB5907	BRACKET:BASE: ELECTRIC POTE NTIAL SENSOR: P4	U019	70	2	O/O			
202302-02	2302Modification	-	D0747753	COVER:TONER SUPPLY:UPPER: ASS'Y	M0EB7873	COVER:TONER SUPPLY:UPPER: ASS'Y	U001_S001	72	1	O/O			
202302-03	2302Modification	-	D0742679	HOLDER:DC STE PPER MOTOR:S HIFT	D0BX2679	HOLDER:DC STE PPER MOTOR:S HIFT	U013_S001	296	1	O/O			
202302-04	2302Modification	-	D1941200	ADF:ASS'Y	D1941202	ADF:SINAI-B:ASS Y	U003_S001	296	1	O/O			
202301-01	2301Modification	-	M0777429	BALL BEARING:R EGISTRATION:D RIVEN:REAR	M0EB4671	RADIAL BALL BE ARING:REGISTR ATION:DRIVEN:R EAR	U013_S001	295	1	O/O			
			M0777429	BALL BEARING:R EGISTRATION:D RIVEN:REAR	M0EB4671	RADIAL BALL BE ARING:REGISTR ATION:DRIVEN:R EAR	U013_S001	295	1	O/O			
202301-02	2301Modification	-	M0777428	BALL BEARING:R EGISTRATION:D RIVEN:FRONT	M0EB4670	RADIAL BALL BE ARING:REGISTR ATION:DRIVEN:F RONT	U013_S001	294	1	O/O			
			M0777428	BALL BEARING:R EGISTRATION:D RIVEN:FRONT	M0EB4670	RADIAL BALL BE ARING:REGISTR ATION:DRIVEN:F RONT	U013_S001	294	1	O/O			
202301-03	2301Modification	-	D0744333	ROLLER:PLATE	M0EB4343	ROLLER:PLATE	U015_S005	274	1	O/O			

Design Change List

Number	Title	Set	Old Part		New Part		Index No.		Q'ty	Interchg		Reason	Cut-in S/N
			P/N	Name	P/N	Name	Group	ID		Indiv.	Set		
202301-04	2301Modification	-	AA043328	TIMING BELT:40S2M130	07922065C	SYNCHRONOUS BELT:40S2M130:CR	U003_S001_S004	295	1	O/O			
202301-05	2301Modification	-	AX061317	(D203/D204):DC STEPPER MOTOR:MM42:1.35A	AX061318	(D203/D204):DC STEPPER MOTOR:MM42:1.35A	U018	125	1	O/O			
202212-01	2212Mod1fication	-	AX400194	HEATER - 230V/9W	AX400275	HEATER:230V:9W	U009	242	2	O/O			
202212-02	2212Mod1fication	-	D6831451	HOLDER:FEELE R:APS	D3FF1451	HOLDER:FEELE R:APS	U003_S001	294	1	O/O			
202212-03	2212Mod1fication	-	D3B04720	PRESSURE PLATE:ASS'Y	D3B04730	PRESSURE PLATE:ASS'Y	U003_S001_S011	293	1	O/O			
202210-01	2210Modification	-	D0746158	ROLLER:INTERMEDIATE TRANSFER:ASS'Y	D2586166	ROLLER:INTERMEDIATE TRANSFER:ASS'Y	U009	241	1	X/O			
			D0746158	ROLLER:INTERMEDIATE TRANSFER:ASS'Y	D2586166	ROLLER:INTERMEDIATE TRANSFER:ASS'Y	U009	241	1	X/O			
			D0746158	ROLLER:INTERMEDIATE TRANSFER:ASS'Y	D2586166	ROLLER:INTERMEDIATE TRANSFER:ASS'Y	U009	241	1	X/O			
			D0746158	ROLLER:INTERMEDIATE TRANSFER:ASS'Y	D2586166	ROLLER:INTERMEDIATE TRANSFER:ASS'Y	U009	241	1	X/O			
			D0746158	ROLLER:INTERMEDIATE TRANSFER:ASS'Y	D2586166	ROLLER:INTERMEDIATE TRANSFER:ASS'Y	U009	241	1	X/O			
202210-02	2210Modification	-	AA043685	SYNCHRONOUS BELT:40S2M258	07922129C	SYNCHRONOUS BELT:40S2M258:CR	U003_S001	292	1	O/O			

Design Change List

Number	Title	Set	Old Part		New Part		Index No.		Q'ty	Interchg		Reason	Cut-in S/N
			P/N	Name	P/N	Name	Group	ID		Indiv.	Set		
202209-01	2209Modification	-	D1942279	PCB:ELECTRIC POTENTIAL SENSOR	D0A52279	BASE:ELECTRIC POTENTIAL SENSOR	U019	69	1	O/O			
202208-01	2208Modification	-	AF030072	PAPER FEED ROLLER:PICKUP	AF030173	PAPER FEED ROLLER:PICKUP	U006_S018	375	1	O/O			
							U006_S019	375	1				
202208-02	2208Modification	-	D0744087	BRACKET:PHOTO INTERRUPTOR:FRONT	D0A54090	BRACKET:PHOTO INTERRUPTOR:FRONT	U015_S001	272	1	X/O			
							U015_S002	272	1				
							U015_S003	272	1				
							U015_S004	272	1				
202207-01	2207Modification	-	D1943751	DOOR:TONER SUPPLY	M0EB7959	DOOR:TONER SUPPLY	U001	71	1	O/O			
202201-01	2201Modification	-	AA043728	SYNCHRONOUS BELT:60S2M190	AA043998	SYNCHRONOUS BELT:60S2M190	U009	240	1	O/O			
202110-01	2110 Modification	-	G1785023	TIMING BELT:S2M190	AA043728	SYNCHRONOUS BELT:60S2M190	U009	239	1	O/O			
202110-02	2110 Modification	-	D0AK5100	SD-CARD:NICE:APPLICATION:ASS'Y	D0CQ5100	SD-CARD:NICE:APPLICATION:ASS'Y	U019	68	1	O/O			
202108-01	2108 Modification	-	AA043976	TIMING BELT:40S2M142	AA043725	TIMING BELT:40S2M142	U009	238	1	O/O			
202108-02	2108 Modification	-	D1947545	(-AA,-EU):TANDEM LCT:LEFT:ASS'Y	D2707555	(-AA,-EU):TANDEM LCT:LEFT:ASS'Y	U006_S006	374	1	O/O			
			D1947545	(-AA,-EU):TANDEM LCT:LEFT:ASS'Y	D2707555	(-AA,-EU):TANDEM LCT:LEFT:ASS'Y	U006_S005	374	1	O/O			
202107-01	2107 Modification	-			D1946054	BRACKET:TENSION SPRING:ROLLER:NO.5:FRONT	U009	237	1				

Design Change List

Number	Title	Set	Old Part		New Part		Index No.		Q'ty	Interchg		Reason	Cut-in S/N
			P/N	Name	P/N	Name	Group	ID		Indiv.	Set		
202106-01	2106 Modification	-	B7003305	TIMING BELT:B40S2M152	07922076C	SYNCHRONOUS BELT:40S2M152:CR	U003_S001	291	1	O/O			
202106-02	2106 Modification	-			D1944703	SHEET:DUPLX:OPEN AND CLOSE:UPPER	U016_S015	239	2				
202105-01	2105 Modification	-	AA043339	TIMING BELT:PA PER EXIT:40S2M122	07922061C	SYNCHRONOUS BELT:40S2M122:CR	U003_S001	286	1	O/O			
202105-02	2105 Modification	-	AA043632	TIMING BELT - 40S2M126	07922063C	SYNCHRONOUS BELT:40S2M126:CR	U003_S001	287	1	O/O			
202105-03	2105 Modification	-	AA043681	SYNCHRONOUS BELT:40S2M108	07922054C	SYNCHRONOUS BELT:40S2M108:CR	U003_S001	285	1	O/O			
202105-04	2105 Modification	-	AA043694	SYNCHRONOUS BELT:B40S2M202	07922101C	SYNCHRONOUS BELT:40S2M202:CR	U003_S001	290	1	O/O			
202105-05	2105 Modification	-	AA043710	SYNCHRONOUS BELT:40S2M158	07922079C	SYNCHRONOUS BELT:40S2M158:CR	U003_S001	288	1	O/O			
202105-06	2105 Modification	-	M3644131	TIMING BELT:B40S2M160	07922080C	SYNCHRONOUS BELT:40S2M160:CR	U003_S001	289	1	O/O			
202105-07	2105 Modification	A	03603006N	SCREW - M3X6	D2051082	HEXAGON HEAD SCREW:ROUND POINT:M3X6:BK	U015_S004	271	1	X/O			
			03603006N	SCREW - M3X6	D2051082	HEXAGON HEAD SCREW:ROUND POINT:M3X6:BK	U015_S004	271	1	X/O			

Design Change List

Number	Title	Set	Old Part		New Part		Index No.		Q'ty	Interchg		Reason	Cut-in S/N
			P/N	Name	P/N	Name	Group	ID		Indiv.	Set		
			03603006N	SCREW - M3X6	D2051082	HEXAGON HEAD SCREW:ROUND POINT:M3X6:BK	U015_S004	271	1	X/O			
			03603006N	SCREW - M3X6	D2051082	HEXAGON HEAD SCREW:ROUND POINT:M3X6:BK	U015_S004	271	1	X/O			
			03603006N	SCREW - M3X6	D2051082	HEXAGON HEAD SCREW:ROUND POINT:M3X6:BK	U015_S004	271	1	X/O			
			03603006N	SCREW - M3X6	D2051082	HEXAGON HEAD SCREW:ROUND POINT:M3X6:BK	U015_S004	271	1	X/O			
			03603006N	SCREW - M3X6	D2051082	HEXAGON HEAD SCREW:ROUND POINT:M3X6:BK	U015_S004	271	1	X/O			
			03603006N	SCREW - M3X6	D2051082	HEXAGON HEAD SCREW:ROUND POINT:M3X6:BK	U015_S003	271	1	X/O			
			03603006N	SCREW - M3X6	D2051082	HEXAGON HEAD SCREW:ROUND POINT:M3X6:BK	U015_S003	271	1	X/O			
			03603006N	SCREW - M3X6	D2051082	HEXAGON HEAD SCREW:ROUND POINT:M3X6:BK	U015_S003	271	1	X/O			
			03603006N	SCREW - M3X6	D2051082	HEXAGON HEAD SCREW:ROUND POINT:M3X6:BK	U015_S003	271	1	X/O			

Design Change List

Number	Title	Set	Old Part		New Part		Index No.		Q'ty	Interchg		Reason	Cut-in S/N
			P/N	Name	P/N	Name	Group	ID		Indiv.	Set		
			03603006N	SCREW - M3X6	D2051082	HEXAGON HEAD SCREW:ROUND POINT:M3X6:BK	U015_S003	271	1	X/O			
			03603006N	SCREW - M3X6	D2051082	HEXAGON HEAD SCREW:ROUND POINT:M3X6:BK	U015_S003	271	1	X/O			
			03603006N	SCREW - M3X6	D2051082	HEXAGON HEAD SCREW:ROUND POINT:M3X6:BK	U015_S002	271	1	X/O			
			03603006N	SCREW - M3X6	D2051082	HEXAGON HEAD SCREW:ROUND POINT:M3X6:BK	U015_S002	271	1	X/O			
			03603006N	SCREW - M3X6	D2051082	HEXAGON HEAD SCREW:ROUND POINT:M3X6:BK	U015_S002	271	1	X/O			
			03603006N	SCREW - M3X6	D2051082	HEXAGON HEAD SCREW:ROUND POINT:M3X6:BK	U015_S002	271	1	X/O			
			03603006N	SCREW - M3X6	D2051082	HEXAGON HEAD SCREW:ROUND POINT:M3X6:BK	U015_S002	271	1	X/O			
			03603006N	SCREW - M3X6	D2051082	HEXAGON HEAD SCREW:ROUND POINT:M3X6:BK	U015_S002	271	1	X/O			
			03603006N	SCREW - M3X6	D2051082	HEXAGON HEAD SCREW:ROUND POINT:M3X6:BK	U015_S001	271	1	X/O			

Design Change List

Number	Title	Set	Old Part		New Part		Index No.		Q'ty	Interchg		Reason	Cut-in S/N
			P/N	Name	P/N	Name	Group	ID		Indiv.	Set		
			03603006N	SCREW - M3X6	D2051082	HEXAGON HEAD SCREW:ROUND POINT:M3X6:BK	U015_S001	271	1	X/O			
			03603006N	SCREW - M3X6	D2051082	HEXAGON HEAD SCREW:ROUND POINT:M3X6:BK	U015_S001	271	1	X/O			
			03603006N	SCREW - M3X6	D2051082	HEXAGON HEAD SCREW:ROUND POINT:M3X6:BK	U015_S001	271	1	X/O			
			03603006N	SCREW - M3X6	D2051082	HEXAGON HEAD SCREW:ROUND POINT:M3X6:BK	U015_S001	271	1	X/O			
			03603006N	SCREW - M3X6	D2051082	HEXAGON HEAD SCREW:ROUND POINT:M3X6:BK	U015_S001	271	1	X/O			
			03603006N	SCREW - M3X6	D2051082	HEXAGON HEAD SCREW:ROUND POINT:M3X6:BK	U015_S001	271	1	X/O			
202105-08	2105 Modification	-	D1949903	SHEET:CIS:KIT			U013_S001	283	1				
202103-01	2103 Modification	-			D1942440	SEAL:FRAME:AP PLY:REAR SIDE	U008_S007	145	1				
							U008_S010	145	1				
							U008_S013	145	1				
							U008_S016	145	1				
							U008_S019	145	1				
202103-02	2103 Modification	A			D1942441	SEAL:FRAME:CO ATING BAR:FRO NT SIDE	U008_S007	146	1				
							U008_S010	146	1				
							U008_S013	146	1				
							U008_S016	146	1				
							U008_S019	146	1				
202103-03	2103 Modification	A			D1942442	SEAL:FRAME:CO	U008_S007	147	1				

Design Change List

Number	Title	Set	Old Part		New Part		Index No.		Q'ty	Interchg		Reason	Cut-in S/N
			P/N	Name	P/N	Name	Group	ID		Indiv.	Set		
						ATING BAR:REA R SIDE	U008_S010	147	1				
							U008_S013	147	1				
							U008_S016	147	1				
							U008_S019	147	1				
202103-04	2103 Modification	A			D1942443	SEAL:FRAME:CO ATING BAR:UPP ER	U008_S007	148	1				
							U008_S010	148	1				
							U008_S013	148	1				
							U008_S016	148	1				
							U008_S019	148	1				
202102-01	2102 Modification	-			D1944188	STAY:PRESSUR E SUB-UNIT:ENT RANCE	U015_S001	270	1				
							U015_S002	270	1				
							U015_S003	270	1				
							U015_S004	270	1				
202101-01	2101 Modification	-	D6834720	PRESSURE PLA TE:ASS'Y	D3B04720	PRESSURE PLA TE:ASS'Y	U003_S001	284	1	O/O			
202012-01	2012 Modification	-	D6834711	GUIDE PLATE:P RESSURE PLAT E:LEFT	D3B04711	GUIDE PLATE:P RESSURE PLAT E:LEFT:ASS'Y	U003_S001 _S011	282	1	O/O			
202012-02	2012 Modification	-	D6834724	CUSHION:PRES SURE PLATE:LA RGE	D3B04724	CUSHION:PRES SURE PLATE:LA RGE	U003_S001 _S011	283	1	O/O			
202012-03	2012 Modification	-	D1949690	(D203/D204):DEV ELOPER WHITE	D0A59695	(D203/D204):DEV ELOPER WHITE	U008	144	1	O/O			
202011-01	2011 Modification	-	D6834725	CUSHION:PRES SURE PLATE:SM ALL	D3B04725	CUSHION:PRES SURE PLATE:SM ALL	U003_S001 _S011	281	1	O/O			
202011-02	2011 Modification	-			D0A57797	SD-CARD:SP:BA TCH:TOOL:ASS'Y	SPECIAL T OOLS	21	1				
202011-03	2011 Modification	A			D0A53456	SEAL:DEVELOP MENT ROLLER:F	U008_S020	142	1				

Design Change List

Number	Title	Set	Old Part		New Part		Index No.		Q'ty	Interchg		Reason	Cut-in S/N
			P/N	Name	P/N	Name	Group	ID		Indiv.	Set		
						RONT:2							
					D0A53456	SEAL:DEVELOPMENT ROLLER:FRONT:2	U008_S017	142	1				
					D0A53456	SEAL:DEVELOPMENT ROLLER:FRONT:2	U008_S014	142	1				
					D0A53456	SEAL:DEVELOPMENT ROLLER:FRONT:2	U008_S011	142	1				
					D0A53456	SEAL:DEVELOPMENT ROLLER:FRONT:2	U008_S008	142	1				
202011-04	2011 Modification	A	D1363406	SEAL:DEVELOPMENT ROLLER:FRONT	D0A53457	SEAL:DEVELOPMENT ROLLER:FRONT:1	U008_S008	143	1	O/O			
							U008_S011	143	1				
							U008_S014	143	1				
							U008_S017	143	1				
							U008_S020	143	1				
202011-05	2011 Modification	-	D1949701	(D203/D204):DEVELOPER CLEAR	D0A59735	(D203/D204):DEVELOPER CLEAR	U008	141	1	O/O			
202010-01	2010 Modification	-	G1784636	TIMING BELT:S2M134_67	AA043726	SYNCHRONOUS BELT:60S2M134	U013_S001	293	1	O/O			
202009-01	2009 Modification	-	D1944490	GUIDE:REVERSE:ENTRANCE	D1944484	SHEET:REVERSE:ENTRANCE:CI NG	U016_S011	238	1	X/O			
202009-02	2009 Modification	A	D0746144	BRACKET:INTERMEDIATE TRANSFER:FRONT	D0A56044	BRACKET:INTERMEDIATE TRANSFER:FRONT	U009	235	5	X/O			
202009-03	2009 Modification	A	D0746145	BRACKET:INTERMEDIATE TRANS	D0A56045	BRACKET:INTERMEDIATE TRANS	U009	236	5	X/O			

Design Change List

Number	Title	Set	Old Part		New Part		Index No.		Q'ty	Interchg		Reason	Cut-in S/N
			P/N	Name	P/N	Name	Group	ID		Indiv.	Set		
				FER:REAR		FER:REAR							
202006-01	2006 Modification	-	D6832233	BRACKET:PAPE R FEED BELT	D3FF2233	BRACKET:PAPE R FEED BELT	U003_S001 _S004	279	1	X/O			
202006-02	2006 Modification	-			D1943653	BRACKET:INNER COVER:TONER BANK:PEEN	U007	175	1				
202006-03	2006 Modification	-	D6833350	GUIDE PLATE:S CANNING	D7313390	GUIDE PLATE:S CANNING:CONT ACT:0.6MM:PEE N	U003_S001	280	1	X/O			
202006-04	2006 Modification	-	D1944656	LEVER:GATE PA WL:REVERSE	D1944625	LEVER:GATE PA WL:REVERSE:PR ESS FIT	U016	237	1	X/O			
202006-05	2006 Modification	-	D0742685	SYNCHRONOUS BELT:B80S2M19 0	AA043727	SYNCHRONOUS BELT:80S2M190	U013_S001	292	1	O/O			
202006-06	2006 Modification	-	AA043584	TIMING BELT:S2 M288	AA043724	SYNCHRONOUS BELT:40S2M288	U018	124	1	O/O			
202006-07	2006 Modification	-	D0743855	BRACKET:SENS OR:VACUUM	D0A53857	BRACKET:SENS OR:VACUUM	U014_S001	27	2	X/O			
202005-01	2005 Modification	-	AA043647	TIMING BELT:60 S2M188	AA043737	TIMING BELT:60 S2M188	U006	364	2	O/O			
202005-02	2005 Modification	-	D1949720	(D203/D204):DEV ELOPER NEON-P INK	D0A59715	(D203/D204):DEV ELOPER NEON-P INK	U008	140	1	O/O			
202004-01	2004 Modification	-	D6833641	GUIDE:CONTAC T IMAGE SENSO R:EXIT:LOWER:A SS'Y	D6833646	GUIDE:CONTAC T IMAGE SENSO R:EXIT:LOWER:A SS'Y	U003_S001 _S008	278	1	X/O			
202003-01	2003 Modification	-	D2704669	BRACKET:MAGN	D2704670	BRACKET:MAGN	U016	236	1	O/O			

Design Change List

Number	Title	Set	Old Part		New Part		Index No.		Q'ty	Interchg		Reason	Cut-in S/N
			P/N	Name	P/N	Name	Group	ID		Indiv.	Set		
		-		ET CATCH:DUPL EX		ET CATCH:DUPL EX							
202003-02	2003 Modification	-	D7312200	SHAFT:SEPARAT ION:ASS'Y	D7312202	SHAFT:SEPARAT ION:ASS'Y	U003_S001 _S004	277	1	O/O			
202002-01	2002 Modification	-	D1949710	DEVELOPER NE ON-YELLOW	D0A59705	DEVELOPER NE ON YELLOW	U008	138	1	O/O			
202002-02	2002 Modification	-	D1949730	(D203/D204):DEV ELOPER INVISIB LE-RED	D0A59725	DEVELOPER INV ISIBLE-RED	U008	139	1	O/O			
202002-03	2002 Modification	-	D0746055	FLAT BELT-TRA NSFER:SERVICE PARTS:ASS'Y	D0A56050	FLAT BELT-TRA NSFER:ASS'Y	U009	234	1	O/O			
202002-04	2002 Modification	-			D1941450	DRIVE UNIT:ARO UND THE PHOT OCONDUCTOR: CMY:ASS'Y	U018_S010 U018_S011 U018_S012	123 123 123	1 1 1				
202002-05	2002 Modification	-			D1945906	BRACKET:POWE R PACK	U019	66	2				
202002-06	2002 Modification	-			D1945908	BRACKET:BASE: ELECTRIC POTE NTIAL SENSOR	U019	67	2				
202002-07	2002 Modification	-			D0A52592	DECAL:PCDU_H OPPER:W	U008	132	1				
202002-08	2002 Modification	-			D0A52593	DECAL:PCDU_H OPPER:CLR	U008	133	1				
202002-09	2002 Modification	-			D0A52595	DECAL:PCDU_H OPPER:NEON-Y	U008	134	1				
202002-10	2002 Modification	-			D0A52596	DECAL:PCDU_H OPPER:NEON-P	U008	135	1				
202002-11	2002 Modification	-			D0A52597	DECAL:PCDU_H	U008	136	1				

Design Change List

Number	Title	Set	Old Part		New Part		Index No.		Q'ty	Interchg		Reason	Cut-in S/N
			P/N	Name	P/N	Name	Group	ID		Indiv.	Set		
		-				OPPER:IV-R							
202002-12	2002 Modification	-			D0A52598	(CHN):DECAL:PC DU_HOPPER:CU -R	U008	137	1				
202001-01	2001 Modification	-	D1947124	DUCT:PCU:FRO NT:4ST:ASS'Y	D0A57124	DUCT:PCU:FRO NT:4ST:ASS'Y	U021_S004	142	1	O/O			
			D1947124	DUCT:PCU:FRO NT:4ST:ASS'Y	D0A57124	DUCT:PCU:FRO NT:4ST:ASS'Y	U021_S003	142	1	O/O			
			D1947124	DUCT:PCU:FRO NT:4ST:ASS'Y	D0A57124	DUCT:PCU:FRO NT:4ST:ASS'Y	U021_S002	142	1	O/O			
			D1947124	DUCT:PCU:FRO NT:4ST:ASS'Y	D0A57124	DUCT:PCU:FRO NT:4ST:ASS'Y	U021_S001	142	1	O/O			
201911-01	1911 Modification	-	D1945398	HARNESS:DEBU G:MONITOR:SER VICE:CONNECTI NG	M0B15888	HARNESS:DEBU G:MONITOR:SER VICE	SPECIAL T OOLS	20	1	O/O			
201911-02	1911 Modification	-			D3FF6071	DECAL:CAUTION :ORIGINAL:PICK- UP PAPER JAM	U003_S001 _S004	276	1				
201911-03	1911 Modification	-	D1797544	SIDE FENCE:TA NDEM LCT:LEFT REAR:ASS'Y	D0A57144	SIDE FENCE:TA NDEM LCT:LEFT REAR:ASS'Y	U006_S008 _S001	373	1	X/O			
			D1797544	SIDE FENCE:TA NDEM LCT:LEFT REAR:ASS'Y	D0A57144	SIDE FENCE:TA NDEM LCT:LEFT REAR:ASS'Y	U006_S007 _S001	373	1	X/O			
			D1797544	SIDE FENCE:TA NDEM LCT:LEFT REAR:ASS'Y	D0A57144	SIDE FENCE:TA NDEM LCT:LEFT REAR:ASS'Y	U006_S006 _S001	373	1	X/O			
			D1797544	SIDE FENCE:TA NDEM LCT:LEFT	D0A57144	SIDE FENCE:TA NDEM LCT:LEFT	U006_S005 _S001	373	1	X/O			

Design Change List

Number	Title	Set	Old Part		New Part		Index No.		Q'ty	Interchg		Reason	Cut-in S/N
			P/N	Name	P/N	Name	Group	ID		Indiv.	Set		
		-		REAR:ASS'Y		REAR:ASS'Y							
201911-04	1911 Modification	-	AZ240301	POWER SUPPLY UNIT:ECO:200V	AZ240373	POWER SUPPLY UNIT:ECO:200V	U020_S006	128	1	X/O			
201910-01	1910 Modification	-	D1945124	PCB:IDB	D1945126	PCB:IDB	U004	71	1	O/O			
201909-01	1909 Modification	-	D1947631	PAPER TRAY:UNIVERSAL:SUB-ASS'Y	D0BX7631	PAPER TRAY:UNIVERSAL:SUB-ASS'Y	U006_S009	372	1	O/O			
201909-02	1909 Modification	-	D1945702	PCB:IMAGE PROCESSING UNIT	D1945706	PCB:IMAGE PROCESSING UNIT	U020	127	1	X/O			
201909-03	1909 Modification	-	D1943545	TONER BANK:ASS'Y	D1943546	TONER BANK:ASS'Y	U007_S019	174	1	O/O			
			D1943545	TONER BANK:ASS'Y	D1943546	TONER BANK:ASS'Y	U007_S017	174	1	O/O			
			D1943545	TONER BANK:ASS'Y	D1943546	TONER BANK:ASS'Y	U007_S015	174	1	O/O			
			D1943545	TONER BANK:ASS'Y	D1943546	TONER BANK:ASS'Y	U007_S013	174	1	O/O			
201908-01	1908 Modification	-	D1945180	CABLE:MAIN:OPTICAL WRITING UNIT:USB	D1945181	CABLE:MAIN:OPTICAL WRITING UNIT:USB	B7(1/3),B8(1/3),B10(1/3)		1	O/O			
201907-01	1907 Modification	-			D1944279	GUIDE PLATE:SEPARATION SUB-UNIT:PRESSURE	U015_S001	269	1				
							U015_S002	269	1				
							U015_S003	269	1				
							U015_S004	269	1				
201906-01	1906 Modification	-	AW020198	PHOTOINTERRUPTOR:LG2A14NL	GW020024	PHOTOINTERRUPTOR:LG2A24BL	U006_S018	371	1	O/O			
							U006_S019	371	1				

Design Change List

Number	Title	Set	Old Part		New Part		Index No.		Q'ty	Interchg		Reason	Cut-in S/N
			P/N	Name	P/N	Name	Group	ID		Indiv.	Set		
		-		1		1:GF							
201905-01	1905 Modification	-			D1941371	STAY:MAIN:RIGHT UPPER:ASS'Y	U022	64	1				
201905-02	1905 Modification	-			D1941420	DRIVE UNIT:AROUND THE PHOTOCONDUCTOR:ASS'Y	U018_S008	122	1				
							U018_S009	122	1				
201905-03	1905 Modification	-			D3FF2851	SENSOR COVER:PHOTOINTERRUPTOR	U003_S001	274	1				
201905-04	1905 Modification	-			D3FF2852	COVER:SENSOR	U003_S001	275	1				
201905-05	1905 Modification	-	D0146780	TRAY BOTTOM PLATE:ASS'Y	D0BX6780	TRAY BOTTOM PLATE:ASS'Y	U006_S009	370	1	O/O			
201905-06	1905 Modification	-	G1784752	HANDLE:LOCK:FRAME:LOWER	D2704752	HANDLE:LOCK:FRAME:LOWER	U016	235	1	O/O			
							U016_S002_S001	235	1				
							U016_S006	235	1				
201905-07	1905 Modification	-	AA043638	TIMING BELT:40S2M224	AA043733	TIMING BELT:40S2M224	U013_S001	291	1	O/O			
201905-08	1905 Modification	-	D1942303	PCU:ASS'Y	D1942304	PCU:ASS'Y	U008_S020	130	1	X/O			
			D1942303	PCU:ASS'Y	D1942304	PCU:ASS'Y	U008_S008	130	1	X/O			
201905-09	1905 Modification	-	D1942306	PCU:FC:ASS'Y	D1942307	PCU:FC:ASS'Y	U008_S017	131	1	X/O			
			D1942306	PCU:FC:ASS'Y	D1942307	PCU:FC:ASS'Y	U008_S014	131	1	X/O			
			D1942306	PCU:FC:ASS'Y	D1942307	PCU:FC:ASS'Y	U008_S011	131	1	X/O			
201904-01	1904 Modification	-	AW020224	PHOTOINTERRUPTOR:GP1A173L CSVF	AW020234	PHOTOINTERRUPTOR:GP1A173L CS5F	U003_S001	273	1	O/O			
			AW020224	PHOTOINTERRUPTOR:GP1A173L CSVF	AW020234	PHOTOINTERRUPTOR:GP1A173L CS5F	U003_S001	273	1	O/O			

Design Change List

Number	Title	Set	Old Part		New Part		Index No.		Q'ty	Interchg		Reason	Cut-in S/N
			P/N	Name	P/N	Name	Group	ID		Indiv.	Set		
		-	AW020224	PHOTOINTERRU PTOR:GP1A173L CSVF	AW020234	PHOTOINTERRU PTOR:GP1A173L CS5F	U003_S001	273	1	O/O			
		-	AW020224	PHOTOINTERRU PTOR:GP1A173L CSVF	AW020234	PHOTOINTERRU PTOR:GP1A173L CS5F	U003_S001	273	1	O/O			
		-	AW020224	PHOTOINTERRU PTOR:GP1A173L CSVF	AW020234	PHOTOINTERRU PTOR:GP1A173L CS5F	U003_S001	273	1	O/O			
		-	AW020224	PHOTOINTERRU PTOR:GP1A173L CSVF	AW020234	PHOTOINTERRU PTOR:GP1A173L CS5F	U003_S001	273	1	O/O			
		-	AW020224	PHOTOINTERRU PTOR:GP1A173L CSVF	AW020234	PHOTOINTERRU PTOR:GP1A173L CS5F	U003_S001	273	1	O/O			
		-	AW020224	PHOTOINTERRU PTOR:GP1A173L CSVF	AW020234	PHOTOINTERRU PTOR:GP1A173L CS5F	U003_S001	273	1	O/O			
		-	AW020224	PHOTOINTERRU PTOR:GP1A173L CSVF	AW020234	PHOTOINTERRU PTOR:GP1A173L CS5F	U003_S001	273	1	O/O			
201904-02	1904 Modification	-	D1941806	(D203/D204):OPT ICAL WRITING U NIT:5ST:ASS'Y	D1941807	(D203/D204):OPT ICAL WRITING U NIT:SST:ASS'Y	U005_S003	14	1	O/O			
201904-03	1904 Modification	-	D1946203	PULLEY:ON-OFF: TRANSFER ROL LER	D1946363	PULLEY:ON-OFF: S2M:27T:MELTIN G ADHESION	U009	233	1	X/O			

Design Change List

Number	Title	Set	Old Part		New Part		Index No.		Q'ty	Interchg		Reason	Cut-in S/N
			P/N	Name	P/N	Name	Group	ID		Indiv.	Set		
201904-04	1904 Modification	-	D3AK1006	MAIN:ASS'Y	D3AK0206	MAIN:ASS'Y	U023	53	1	O/O			
201904-05	1904 Modification	-	B2346541	FEED DRIVE SH AFT	D2706541	SHAFT:DRIVE:FEED:ASS'Y	U006	369	1	O/O			
			B2346541	FEED DRIVE SH AFT	D2706541	SHAFT:DRIVE:FEED:ASS'Y	U006	369	1	O/O			
201904-06	1904 Modification	-	11050758	CLAMP:LWSM-0306A	11050511	HARNESS CLAMP - LWS-0306ZC	U004	70	1	X/O			
			11050758	CLAMP:LWSM-0306A	11050511	HARNESS CLAMP - LWS-0306ZC	U004	70	1	X/O			
			11050758	CLAMP:LWSM-0306A	11050511	HARNESS CLAMP - LWS-0306ZC	U004	70	1	X/O			
			11050758	CLAMP:LWSM-0306A	11050511	HARNESS CLAMP - LWS-0306ZC	U004	70	1	X/O			
			11050758	CLAMP:LWSM-0306A	11050511	HARNESS CLAMP - LWS-0306ZC	U004	70	1	X/O			
			11050758	CLAMP:LWSM-0306A	11050511	HARNESS CLAMP - LWS-0306ZC	U004	70	1	X/O			
			11050758	CLAMP:LWSM-0306A	11050511	HARNESS CLAMP - LWS-0306ZC	U004	70	1	X/O			
			11050758	CLAMP:LWSM-0306A	11050511	HARNESS CLAMP - LWS-0306ZC	U004	70	1	X/O			
			11050758	CLAMP:LWSM-0306A	11050511	HARNESS CLAMP - LWS-0306ZC	U004	70	1	X/O			
			11050758	CLAMP:LWSM-0306A	11050511	HARNESS CLAMP - LWS-0306ZC	U004	70	1	X/O			
			11050758	CLAMP:LWSM-0306A	11050511	HARNESS CLAMP - LWS-0306ZC	U004	70	1	X/O			
			11050758	CLAMP:LWSM-0306A	11050511	HARNESS CLAMP - LWS-0306ZC	U004	70	1	X/O			

Design Change List

Number	Title	Set	Old Part		New Part		Index No.		Q'ty	Interchg		Reason	Cut-in S/N
			P/N	Name	P/N	Name	Group	ID		Indiv.	Set		
		-		06A		P - LWS-0306ZC							
			11050758	CLAMP:LWSM-0306A	11050511	HARNESS CLAMP - LWS-0306ZC	U004	70	1	X/O			
			11050758	CLAMP:LWSM-0306A	11050511	HARNESS CLAMP - LWS-0306ZC	U004	70	1	X/O			
			11050758	CLAMP:LWSM-0306A	11050511	HARNESS CLAMP - LWS-0306ZC	U004	70	1	X/O			
			11050758	CLAMP:LWSM-0306A	11050511	HARNESS CLAMP - LWS-0306ZC	U004	70	1	X/O			
201902-01	1902 Modification	-	D1945185	HARNESS:OPTICAL WRITING UNIT:AND			B7(1/3)		0				
201902-02	1902 Modification	-	D1945184	HARNESS:OPTICAL WRITING UNIT			B8(1/3),B9(1/3)		0				
201902-03	1902 Modification	-	D0746716	HOLDER:HINGE: OPERATION SUB-UNIT:LOWER	D0BX1594	HOLDER:HINGE: OPERATION SUB-UNIT:LOWER	U002	81	1	O/O			
201902-04	1902 Modification	-	B6522215	GUIDE:PAPER FEED BELT:FRONT	D3FF2219	GUIDE:PAPER FEED BELT:FRONT	U003_S001_S004	272	1	O/O			
201902-05	1902 Modification	-	D6831350	HINGE:RIGHT:ASSY	D3B01350	HINGE:RIGHT:ASSY	U003_S001	271	1	X/O			
201901-01	1901 Modification	-			D0746212	SEAL:TRANSFER ROLLER:REAR	U011_S001	47	1				
201901-02	1901 Modification	-			D0746213	SEAL:TRANSFER ROLLER:FRONT	U011_S001	48	1				
201901-03	1901 Modification	-			D0A53710	SEAL:REAR:SLIDER:TONER BANK:T6	U007_S013	173	1				
							U007_S015	173	1				
							U007_S017	173	1				

Design Change List

Number	Title	Set	Old Part		New Part		Index No.		Q'ty	Interchg		Reason	Cut-in S/N
			P/N	Name	P/N	Name	Group	ID		Indiv.	Set		
		-					U007_S019	173	1				
201901-04	1901 Modification	-	03603005N	SCREW - M3X5	D1944271	HEXAGON HEAD SCREW:ADHESI VE:M3X5	U015_S001	268	1	X/O			
			03603005N	SCREW - M3X5	D1944271	HEXAGON HEAD SCREW:ADHESI VE:M3X5	U015_S002	268	1	X/O			
			03603005N	SCREW - M3X5	D1944271	HEXAGON HEAD SCREW:ADHESI VE:M3X5	U015_S003	268	1	X/O			
			03603005N	SCREW - M3X5	D1944271	HEXAGON HEAD SCREW:ADHESI VE:M3X5	U015_S004	268	1	X/O			
			03603005N	SCREW - M3X5	D1944271	HEXAGON HEAD SCREW:ADHESI VE:M3X5	U015_S001	268	1	X/O			
			03603005N	SCREW - M3X5	D1944271	HEXAGON HEAD SCREW:ADHESI VE:M3X5	U015_S002	268	1	X/O			
			03603005N	SCREW - M3X5	D1944271	HEXAGON HEAD SCREW:ADHESI VE:M3X5	U015_S003	268	1	X/O			
			03603005N	SCREW - M3X5	D1944271	HEXAGON HEAD SCREW:ADHESI VE:M3X5	U015_S004	268	1	X/O			
201812-01	1812 Modification	-			03604008N	SCREW - M4X8	U022	5	1				
					03604008N	SCREW - M4X8	U022	5	1				
201812-02	1812 Modification	-	04514008N	TAPPING SCRE W:4X8	03604008N	SCREW - M4X8	U020	7	1	O/O			
			04514008N	TAPPING SCRE	03604008N	SCREW - M4X8	U020	7	1	O/O			

Design Change List

Number	Title	Set	Old Part		New Part		Index No.		Q'ty	Interchg		Reason	Cut-in S/N
			P/N	Name	P/N	Name	Group	ID		Indiv.	Set		
		-		W:4X8									
			04514008N	TAPPING SCRE W:4X8	03604008N	SCREW - M4X8	U020	7	1	O/O			
			04514008N	TAPPING SCRE W:4X8	03604008N	SCREW - M4X8	U020	7	1	O/O			
			04514008N	TAPPING SCRE W:4X8	03604008N	SCREW - M4X8	U020	7	1	O/O			
			04514008N	TAPPING SCRE W:4X8	03604008N	SCREW - M4X8	U020	7	1	O/O			
			04514008N	TAPPING SCRE W:4X8	03604008N	SCREW - M4X8	U021	6	1	O/O			
			04514008N	TAPPING SCRE W:4X8	03604008N	SCREW - M4X8	U021	6	1	O/O			
			04514008N	TAPPING SCRE W:4X8	03604008N	SCREW - M4X8	U021	6	1	O/O			
			04514008N	TAPPING SCRE W:4X8	03604008N	SCREW - M4X8	U021	6	1	O/O			
201812-03	1812 Modification	-	04514008N	TAPPING SCRE W:4X8	04544008Q	TAPPING SCRE W - M4X8	U020	14	1	O/O			
			04514008N	TAPPING SCRE W:4X8	04544008Q	TAPPING SCRE W - M4X8	U020	14	1	O/O			
			04514008N	TAPPING SCRE W:4X8	04544008Q	TAPPING SCRE W - M4X8	U020	14	1	O/O			
			04514008N	TAPPING SCRE W:4X8	04544008Q	TAPPING SCRE W - M4X8	U020	14	1	O/O			
			04514008N	TAPPING SCRE W:4X8	04544008Q	TAPPING SCRE W - M4X8	U020	14	1	O/O			
			04514008N	TAPPING SCRE	04544008Q	TAPPING SCRE	U020	14	1	O/O			

Design Change List

Number	Title	Set	Old Part		New Part		Index No.		Q'ty	Interchg		Reason	Cut-in S/N
			P/N	Name	P/N	Name	Group	ID		Indiv.	Set		
		-		W:4X8		W - M4X8							
			04514008N	TAPPING SCRE W:4X8	04544008Q	TAPPING SCRE W - M4X8	U020	14	1	O/O			
			04514008N	TAPPING SCRE W:4X8	04544008Q	TAPPING SCRE W - M4X8	U020	14	1	O/O			
			04514008N	TAPPING SCRE W:4X8	04544008Q	TAPPING SCRE W - M4X8	U020	14	1	O/O			
			04514008N	TAPPING SCRE W:4X8	04544008Q	TAPPING SCRE W - M4X8	U020	14	1	O/O			
			04514008N	TAPPING SCRE W:4X8	04544008Q	TAPPING SCRE W - M4X8	U020	14	1	O/O			
			04514008N	TAPPING SCRE W:4X8	04544008Q	TAPPING SCRE W - M4X8	U020	14	1	O/O			
			04514008N	TAPPING SCRE W:4X8	04544008Q	TAPPING SCRE W - M4X8	U020	14	1	O/O			
			04514008N	TAPPING SCRE W:4X8	04544008Q	TAPPING SCRE W - M4X8	U020	14	1	O/O			
			04514008N	TAPPING SCRE W:4X8	04544008Q	TAPPING SCRE W - M4X8	U021	141	1	O/O			
201812-04	1812 Modification	-	03604006N	SCREW - M4X6	03604008N	SCREW - M4X8	U020	7	1	O/O			
			03604006N	SCREW - M4X6	03604008N	SCREW - M4X8	U020	7	1	O/O			
			03604006N	SCREW - M4X6	03604008N	SCREW - M4X8	U020	7	1	O/O			
			03604006N	SCREW - M4X6	03604008N	SCREW - M4X8	U020	7	1	O/O			
			03604006N	SCREW - M4X6	03604008N	SCREW - M4X8	U020	7	1	O/O			
			03604006N	SCREW - M4X6	03604008N	SCREW - M4X8	U020	7	1	O/O			
			03604006N	SCREW - M4X6	03604008N	SCREW - M4X8	U020	7	1	O/O			
201812-05	1812 Modification	-			D1945398	HARNESS:DEBU G:MONITOR:SER VICE:CONNECTI NG							

Design Change List

Number	Title	Set	Old Part		New Part		Index No.		Q'ty	Interchg		Reason	Cut-in S/N
			P/N	Name	P/N	Name	Group	ID		Indiv.	Set		
201812-06	1812 Modification	-			G1785397	PCB:SIFB:CROSS	SPECIAL TOOLS	19	1				
201812-07	1812 Modification	-	AA161129	CUSHION - LARGE	AA161177	CUSHION:BASE:TANDEM LCT:LARGE	U006_S001	367	1	O/O			
							U006_S002	367	1				
							U006_S003	367	1				
							U006_S004	367	1				
201812-08	1812 Modification	-	AA161130	CUSHION - SMALL	AA161178	CUSHION:BASE:TANDEM LCT:SMALL	U006_S001	368	2	O/O			
							U006_S002	368	2				
							U006_S003	368	2				
							U006_S004	368	2				
201812-09	1812 Modification	-	D6831320	HINGE:LEFT:ASSY	D3B01320	HINGE:LEFT:ASSY	U003_S001	270	1	X/O			
201812-10	1812 Modification	-	D1941431	SHAFT:DRIVE:DEVELOPMENT SLEEVE:ASSY	D0A51431	SHAFT:DRIVE:DEVELOPMENT SLEEVE:ASSY	U018_S008	121	1	O/O			
							U018_S009	121	1				
							U018_S010	121	1				
							U018_S011	121	1				
							U018_S012	121	1				
201812-11	1812 Modification	-	D0746088	COVER:INTERMEDIATE TRANSFER:ASSY	D0A56187	COVER:INTERMEDIATE TRANSFER:ASSY	U009	232	1	O/O			

Design Change List

Number	Title	Set	Old Part		New Part		Index No.		Q'ty	Interchg		Reason	Cut-in S/N
			P/N	Name	P/N	Name	Group	ID		Indiv.	Set		
201812-12	1812 Modification	-			D0A53588	BRACKET:RACK:STOPPER	U007_S013	169	1				
					D0A53588	BRACKET:RACK:STOPPER	U007_S015	169	1				
					D0A53588	BRACKET:RACK:STOPPER	U007_S017	169	1				
					D0A53588	BRACKET:RACK:STOPPER	U007_S019	169	1				
201812-13	1812 Modification	-			D1943707	SLIDER:TONER BANK	U007_S013	170	1				
							U007_S015	170	1				
							U007_S017	170	1				
							U007_S019	170	1				
201812-14	1812 Modification	-			D1943708	SEAL:INNER:SLIDER:TONER BANK	U007_S013	171	1				
							U007_S015	171	1				
							U007_S017	171	1				
							U007_S019	171	1				
201812-15	1812 Modification	-			D1943709	SEAL:OUTER:SLIDER:TONER BANK	U007_S013	172	1				
							U007_S015	172	1				
							U007_S017	172	1				
							U007_S019	172	1				
201812-16	1812 Modification	A			D1943809	SUPPORTING PLATE:VACUUM	U014_S001	25	1		X/O	Set parts number [AX640207(201503-01)][D1943818]	
201812-17	1812 Modification	A			D1943818	VACUUM	U014_S001	26	1		X/O	Set parts number [AX640207(201503-01)][D1943809]	
201812-18	1812 Modification	-			D1944220	SUPPORTING PLATE:SIDE PLATE:PRESSURE:REAR	U015_S001	266	1				
							U015_S002	266	1				
							U015_S003	266	1				
							U015_S004	266	1				

Design Change List

Number	Title	Set	Old Part		New Part		Index No.		Q'ty	Interchg		Reason	Cut-in S/N
			P/N	Name	P/N	Name	Group	ID		Indiv.	Set		
201810-01	1810 Modification	-	D1955100	SD-CARD:NICE:LEO:ASS'Y	D0AK5100	SD-CARD:NICE:APPLICATION:ASS'Y	U019	65	1	X/O		Old part number D1955100/D2605100,Int X/O	
201810-02	1810 Modification	-	D2605100	SD-CARD:NICE:APPLICATION:ASS'Y			U019	60	1	X/O		New part number D0AK5100,Int X/O	
201809-01	1809 Modification	-	D1946202	TRANSFER ROLLER:18MIC	D0A56252	TRANSFER ROLLER:18MIC	U011_S001	46	1	O/O			
201809-02	1809 Modification	-			D2035259	HARNESS:TONE R SUPPLY UNIT:UNIT:CONNECTING:5ST	G2(2/3)		1				
201809-03	1809 Modification	-			D1943396	JIG:SERVICE:DEVELOPMENT UNIT	SPECIAL TOOLS	17	1				
201808-01	1808 Modification	-	D0743889	BRACKET:POSITIONING SENSOR:FLAT BELT-TRANSFER	D2703889	BRACKET:POSITIONING SENSOR:PEEN	U009	231	1	O/O			
201808-02	1808 Modification	-	D1947546	(-NA):TANDEM LCT:LEFT:ASS'Y	D1797549	(-NA):TANDEM LCT:LEFT:ASS'Y	U006_S007	366	1	O/O			
201808-03	1808 Modification	-			D0744564	BRACKET:REVERSE:SENSOR	U016	234	1				
201807-01	1807 Modification	-	07423808	BALL BEARING - 8X16X5	07433808	RADIAL BALL BEARING:DIA8XDIA16X5	U006	365	1	O/O			
			07423808	BALL BEARING - 8X16X5	07433808	RADIAL BALL BEARING:DIA8XDIA16X5	U006	365	1	O/O			
			07423808	BALL BEARING - 8X16X5	07433808	RADIAL BALL BEARING:DIA8XDIA16X5	U006	365	1	O/O			

Design Change List

Number	Title	Set	Old Part		New Part		Index No.		Q'ty	Interchg		Reason	Cut-in S/N
			P/N	Name	P/N	Name	Group	ID		Indiv.	Set		
		-		8X16X5		ARING:DIA8XDIA 16X5							
			07423808	BALL BEARING - 8X16X5	07433808	RADIAL BALL BE ARING:DIA8XDIA 16X5	U006	365	1	O/O			
			07423808	BALL BEARING - 8X16X5	07433808	RADIAL BALL BE ARING:DIA8XDIA 16X5	U006_S018	365	1	O/O			
			07423808	BALL BEARING - 8X16X5	07433808	RADIAL BALL BE ARING:DIA8XDIA 16X5	U006_S018	365	1	O/O			
			07423808	BALL BEARING - 8X16X5	07433808	RADIAL BALL BE ARING:DIA8XDIA 16X5	U006_S019	365	1	O/O			
			07423808	BALL BEARING - 8X16X5	07433808	RADIAL BALL BE ARING:DIA8XDIA 16X5	U006_S019	365	1	O/O			
201807-02	1807 Modification	A	D1941164	COVER:TONER SUPPLY	D0A51164	COVER:TONER SUPPLY	U022	58	1	X/X			
201807-03	1807 Modification	A	D1943756	COVER:HARNES S:OPERATION S UB-UNIT:TONER BOTTLE:UPPER	D0A51160	SHEET:TONER S UPPLY:OPERATI ON SUB-UNIT	U007_S022	166	1	X/X			
201807-04	1807 Modification	-	B6524743	SHEET:PRESSU RE PLATE:SMAL L	D0A46099	SHEET:PRESSU RE PLATE:SMAL L	U003_S001 _S011	269	1	O/O			
201807-05	1807 Modification	-	D0744650	LINK:REVERSE ROLLER:ASS'Y	D0A54647	LINK:REVERSE ROLLER:ASS'Y	U016_S010	233	1	O/O			
201807-06	1807 Modification	-			D0A53760	(D194/D195):INN ER COVER:DUM	U007_S026	167	1	X/O		Old part number D1943760,Int X/O	

Design Change List

Number	Title	Set	Old Part		New Part		Index No.		Q'ty	Interchg		Reason	Cut-in S/N
			P/N	Name	P/N	Name	Group	ID		Indiv.	Set		
		-				MY:5ST:TONER SUPPLY:ASS'Y							
201807-07	1807 Modification	-	D0AL3504	(D203/D204):BRA CKET:HOLDER:F RONT:TONER B OTTLE	D0AL3503	(D203/D204):BRA CKET:HOLDER:F RONT:TONER B OTTLE	U007_S024	168	1	O/O			
201807-08	1807 Modification	-	D1361731	LENSBLOCK SM D:ASS'Y	D1381731	LENSBLOCK SM D:SERVICE PAR TS:ASS'Y	U004_S001	69	1	O/O			
201807-09	1807 Modification	-	D1940641	BELT CLEANING: ASS'Y	D0A50641	BELT CLEANING: ASS'Y	U010_S001	63	1	O/O			
201807-10	1807 Modification	-	D3AK1000	MEDIA IDENTIFI CATION UNIT	D3AK1006	MAIN:ASS'Y	U023	52	1	O/O			
201807-11	1807 Modification	-			D1944150	SIDE PLATE:FUS ING:REAR:PEEN	U015_S001	265	1				
							U015_S002	265	1				
							U015_S003	265	1				
							U015_S004	265	1				
201807-12	1807 Modification	-			D0A52940	HOLDER:ELECT RICAL COMPON ENTS SECTION: ASS'Y	U013_S001	290	1				
201807-13	1807 Modification	-			D0894252	GUIDE:FUSING E XIT:PFA	U015_S001	264	4				
							_S002						
							U015_S001	264	13				
							_S003						
							U015_S002	264	4				
							_S002						
							U015_S002	264	13				
							_S003						
							U015_S003	264	4				

Design Change List

Number	Title	Set	Old Part		New Part		Index No.		Q'ty	Interchg		Reason	Cut-in S/N
			P/N	Name	P/N	Name	Group	ID		Indiv.	Set		
		-					_S002						
							U015_S003	264	13				
							U015_S004	264	4				
							U015_S004	264	13				
201807-14	1807 Modification	-	D0745384	HARNESS:FUSIN G:PRESSURE:TH ERMOSTAT	D0A55348	HARNESS:FUSIN G:PRESSURE:TH ERMOSTAT	E9(2/3)		1	O/O			
201807-15	1807 Modification	-	D1945268	HARNESS:TONE R BOTTLE:OPEN AND CLOSE:SE NSOR:CONNECT ING			D6(1/3),G3(2/3)		0				
201807-16	1807 Modification	-			D1945258	(D203/D204):HAR NESS:TONER SU PPLY UNIT:MAIN: CONNECTING:5S T	G2(2/3)		1				
201806-01	1806 Modification	B	D1947826	(D194-NA,CHN,A A):(D195/D203/D 204):COVER:MAI N:RIGHT:ASS'Y	D0A57826	(D194-NA,CHN,A A):(D195/D203/D 204):COVER:MAI N:RIGHT:ASS'Y	U001_S008	70	1	X/X			
201806-02	1806 Modification	B			D0A55928	COVER:LEAK BR EAKER	U019	64	1				
201806-03	1806 Modification	B			04514008N	TAPPING SCRE W:4X8	U019	7	1				
					04514008N	TAPPING SCRE W:4X8	U019	7	1				

Design Change List

Number	Title	Set	Old Part		New Part		Index No.		Q'ty	Interchg		Reason	Cut-in S/N
			P/N	Name	P/N	Name	Group	ID		Indiv.	Set		
201806-04	1806 Modification	-	D0746942	SEAL:SHORT:DU CT:HEAT SINKE R	D0A56942	SEAL:SHORT:DU CT:HEAT SINKE R	U021	140	2	O/O			
201806-05	1806 Modification	-	D0745911	BRACKET:NOISE FILTER	D0A55911	BRACKET:NOISE FILTER	U019	63	1	O/O			
201806-06	1806 Modification	A	D0742552	GUIDE PLATE:SL IDE RAIL:PCU	D0A52552	GUIDE PLATE:SL IDE RAIL:PCU	U008	128	4	O/O			
201806-07	1806 Modification	A			D0A57285	SHEET:GUIDE P LATE:SLIDE RAIL :PCU	U008	129	1				
					D0A57285	SHEET:GUIDE P LATE:SLIDE RAIL :PCU	U008	129	1				
					D0A57285	SHEET:GUIDE P LATE:SLIDE RAIL :PCU	U008	129	1				
					D0A57285	SHEET:GUIDE P LATE:SLIDE RAIL :PCU	U008	129	1				
201806-08	1806 Modification	-	D1944320	ROLLER:POLISH: ASS'Y	D1944327	ROLLER:POLISH: ASS'Y	U015_S006	263	1	O/O			
201806-09	1806 Modification	-	D0746941	DUCT:LOWER:H EAT SINKER	D0A56941	DUCT:LOWER:H EAT SINKER	U021	139	1	O/O			
201805-01	1805 Modification	-	08046123	HEXAGONAL BO LT:W/WASHER:M 3X8	09543006N	SCREW - M3X6	U015_S006	260	1	O/O			
201805-02	1805 Modification	-	G1784669	BRACKET:MAGN ET CATCH:DUPL EX	D2704669	BRACKET:MAGN ET CATCH:DUPL EX	U016	232	1	O/O			
201805-03	1805 Modification	-	AA043608	TIMING BELT:40	AA043731	TIMING BELT:40	U013_S001	289	1	O/O			

Design Change List

Number	Title	Set	Old Part		New Part		Index No.		Q'ty	Interchg		Reason	Cut-in S/N
			P/N	Name	P/N	Name	Group	ID		Indiv.	Set		
		-		S2M184		S2M184							
201805-04	1805 Modification	-	AA043647	TIMING BELT:60 S2M188	AA043737	TIMING BELT:60 S2M188	U006	364	1	O/O			
			AA043647	TIMING BELT:60 S2M188	AA043737	TIMING BELT:60 S2M188	U006	364	1	O/O			
			AA043647	TIMING BELT:60 S2M188	AA043737	TIMING BELT:60 S2M188	U006	364	1	O/O			
			AA043647	TIMING BELT:60 S2M188	AA043737	TIMING BELT:60 S2M188	U006	364	1	O/O			
201805-05	1805 Modification	-	D1946200	TRANSFER/SEP ARATION UNIT:A SS'Y	D0A56200	TRANSFER/SEP ARATION UNIT:A SS'Y	U011_S001	45	1	O/O			
201805-06	1805 Modification	-			D1944285	STAY:FRONT	U015_S001	262	1				
							U015_S002	262	1				
							U015_S003	262	1				
							U015_S004	262	1				
201805-07	1805 Modification	-			D1948524	SERVICE PARTS :DECAL:IV-R:ASS 'Y	U008	127	1				
201805-08	1805 Modification	-			D1944115	SERVICE PARTS :PICKOFF PAWL: PRESSURE ROL LER:ASS'Y	U015_S001	261	9				
							U015_S002	261	9				
							U015_S003	261	9				
							U015_S004	261	9				
201804-01	1804 Modification	-	D0747785	DOOR:FRONT LE FT:LOWER	D0A57259	DOOR:FRONT LE FT:LOWER	U001	69	1	O/O			
201804-02	1804 Modification	-	AA066403	TORSION SPRIN	AA066428	TORSION SPRIN	U013_S001	288	1	O/O			

Design Change List

Number	Title	Set	Old Part		New Part		Index No.		Q'ty	Interchg		Reason	Cut-in S/N
			P/N	Name	P/N	Name	Group	ID		Indiv.	Set		
		-		G:GUIDE PLATE:FRONT		G:GUIDE PLATE:FRONT							
201804-03	1804 Modification	-			D1943712	HOLDER:HOOK:CAP:TONER BOTTLE	U007_S013	165	1				
							U007_S015	165	1				
							U007_S017	165	1				
							U007_S019	165	1				
201804-04	1804 Modification	-			D1957238	PCB:IOKEY:ASS'Y	U002_S001	80	1				
							U002_S002	80	1				
							U002_S003	80	1				
							U002_S004	80	1				
201803-01	1803 Modification	-	D1941802	OPTICAL WRITING UNIT:4ST:ASS'Y	D1941803	OPTICAL WRITING UNIT:4ST:ASS'Y	U005_S001	13	1	O/O			
			D1941802	OPTICAL WRITING UNIT:4ST:ASS'Y	D1941803	OPTICAL WRITING UNIT:4ST:ASS'Y	U005_S002	13	1	O/O			
201803-02	1803 Modification	-			D1943409	GEAR:DRIVE:TONER SUPPLY	U007	164	1				
201803-03	1803 Modification	-			D1944219	SUPPORTING PLATE:SIDE PLATE:PRESSURE:FRONT	U015_S001	258	1				
							U015_S002	258	1				
							U015_S003	258	1				
							U015_S004	258	1				
201803-04	1803 Modification	-			D1944273	BRACKET:PAPER FEED SENSOR:FUSING EXIT	U015_S001	259	1				
							U015_S002	259	1				
							U015_S003	259	1				
							U015_S004	259	1				

Design Change List

Number	Title	Set	Old Part		New Part		Index No.		Q'ty	Interchg		Reason	Cut-in S/N
			P/N	Name	P/N	Name	Group	ID		Indiv.	Set		
201803-05	1803 Modification	-			D1949730	(D203/D204):DEV ELOPER INVISIB LE-RED	U008	126	1				
201802-01	1802 Modification	-	11050487	HARNESS CLAM P	11050761	CLAMP:LWS-051 1A	U021	138	1	O/O			
			11050487	HARNESS CLAM P	11050761	CLAMP:LWS-051 1A	U021	138	1	O/O			
			11050487	HARNESS CLAM P	11050761	CLAMP:LWS-051 1A	U021	138	1	O/O			
			11050487	HARNESS CLAM P	11050761	CLAMP:LWS-051 1A	U021	138	1	O/O			
			11050487	HARNESS CLAM P	11050761	CLAMP:LWS-051 1A	U021	138	1	O/O			
			11050487	HARNESS CLAM P	11050761	CLAMP:LWS-051 1A	U021	138	1	O/O			
			11050487	HARNESS CLAM P	11050761	CLAMP:LWS-051 1A	U021	138	1	O/O			
			11050487	HARNESS CLAM P	11050761	CLAMP:LWS-051 1A	U021	138	1	O/O			
			11050487	HARNESS CLAM P	11050761	CLAMP:LWS-051 1A	U021	138	1	O/O			
201801-01	1801 Modification	-	D0746708	BASE:ARM:OPE RATION SUB-UNI T:ASS'Y			U002	20	1	X/O		New part number D0746709,Int x/o	
201801-02	1801 Modification	-			D0746709	BASE:ARM:OPE RATION SUB-UNI T	U002	79	1	X/O		Old part number D0746708,Int x/o	
201712-01	1712 Modification	-	11050516	CLAMP	11050760	CLAMP:LWSM-05 11A	U018	120	1	O/O			
			11050516	CLAMP	11050760	CLAMP:LWSM-05	U018	120	1	O/O			

Design Change List

Number	Title	Set	Old Part		New Part		Index No.		Q'ty	Interchg		Reason	Cut-in S/N
			P/N	Name	P/N	Name	Group	ID		Indiv.	Set		
		-				11A							
			11050516	CLAMP	11050760	CLAMP:LWSM-05 11A	U018	120	1	O/O			
			11050516	CLAMP	11050760	CLAMP:LWSM-05 11A	U018	120	1	O/O			
			11050516	CLAMP	11050760	CLAMP:LWSM-05 11A	U018	120	1	O/O			
			11050516	CLAMP	11050760	CLAMP:LWSM-05 11A	U018	120	1	O/O			
201712-02	1712 Modification	-	D0744224	JOINT:KNOB:FU SING	D0A53995	JOINT:KNOB:FU SING	U015_S001	257	1	O/O			
							U015_S002	257	1				
							U015_S003	257	1				
							U015_S004	257	1				
201712-03	1712 Modification	-	D1943544	TONER BANK:AS S'Y	D1943545	TONER BANK:AS S'Y	U007	163	1	X/O			
			D1943544	TONER BANK:AS S'Y	D1943545	TONER BANK:AS S'Y	U007	163	1	X/O			
			D1943544	TONER BANK:AS S'Y	D1943545	TONER BANK:AS S'Y	U007	163	1	X/O			
			D1943544	TONER BANK:AS S'Y	D1943545	TONER BANK:AS S'Y	U007	163	1	X/O			
201712-04	1712 Modification	-	11035761	CONNECTOR:44 W0R-RFC-EGD(L F)(SN)	11035759	CONNECTOR:RF CP-44W0-E	U016	231	1				
201712-05	1712 Modification	-	11035759	CONNECTOR:RF CP-44W0-E	11035761	CONNECTOR:44 W0R-RFC-EGD(L F)(SN)	U022	56	1				
201711-01	1711 Modification	-			D1949720	(D203/D204):DEV ELOPER NEON-P INK	U008	125	1				

Design Change List

Number	Title	Set	Old Part		New Part		Index No.		Q'ty	Interchg		Reason	Cut-in S/N
			P/N	Name	P/N	Name	Group	ID		Indiv.	Set		
201710-01	1710 Modification	-	D1945400	PCB:BCU:ASS'Y	D1945410	PCB:BCU:ASS'Y	U019_S001	61	1	X/O			
201710-02	1710 Modification	-	D0744145	LEVER:PAPER EXIT UNIT:REAR	D0A53994	LEVER:PAPER EXIT UNIT:REAR	U015_S001	255	1	O/O			
							U015_S002	255	1				
							U015_S003	255	1				
							U015_S004	255	1				
201710-03	1710 Modification	-	D0742815	BRACKET:CONTACT POINT:GUIDE PLATE:REAR	D0A52815	BRACKET:CONTACT POINT:GUIDE PLATE:REAR:PEEN	U013_S001	285	1	O/O			
201710-04	1710 Modification	-	D0744872	BRACKET:TRANSPORT ROLLER:DUPLEX:REVERSE:RIGHT	D0A54872	BRACKET:TRANSPORT ROLLER:DUPLEX:REVERSE:RIGHT	U017	31	1	O/O			
201710-05	1710 Modification	-	D0747656	INNER COVER:VERTICAL TRANSPORT:RIGHT	D1947657	INNER COVER:VERTICAL TRANSPORT:RIGHT:DECAL:SUB-ASS'Y	U006	363	1	O/O			
201710-06	1710 Modification	-	D0746934	DUCT:HEAT PIPE:FUSING:LOWER	D0A56934	DUCT:HEAT PIPE:FUSING:LOWER	U021	137	1	O/O			
201710-07	1710 Modification	-	D0396137	ENCODER:ASS'Y	D1941496	ENCODER:ASS'Y	U013_S001	286	1	O/O			
			D0396137	ENCODER:ASS'Y	D1941496	ENCODER:ASS'Y	U018	119	1	O/O			
201710-08	1710 Modification	-	D1941467	GEAR:DRIVE:130Z	D0A51467	GEAR:DRIVE:130Z	U009	230	1	O/O			
201710-09	1710 Modification	-	D1944241	SHAFT:CAM	D1944289	SHAFT:CAM	U015_S001	256	1	O/O			
							U015_S002	256	1				
							U015_S003	256	1				
							U015_S004	256	1				
201710-10	1710 Modification	-	D1949700	(D203/D204):DEVELOPER CLEAR	D1949701	(D203/D204):DEVELOPER CLEAR	U008	124	1	X/O			

Design Change List

Number	Title	Set	Old Part		New Part		Index No.		Q'ty	Interchg		Reason	Cut-in S/N
			P/N	Name	P/N	Name	Group	ID		Indiv.	Set		
201710-11	1710 Modification	-			D1948523	SERVICE PARTS :DECAL:NEON-P: ASS'Y	U008	123	1				
201710-12	1710 Modification	-			11035758	CONNECTOR:RF CP-36W0-E	U009	228	1				
201710-13	1710 Modification	-			11035760	CONNECTOR:36 W0R-RFC-EGD(L F)(SN)	U022	55	1				
201710-14	1710 Modification	-			11035761	CONNECTOR:44 W0R-RFC-EGD(L F)(SN)	U016	230	1				
							U022	56	1				
201710-15	1710 Modification	-			11035759	CONNECTOR:RF CP-44W0-E	U009	229	1				
							U022	54	1				
201710-16	1710 Modification	A	D2033504	(D203/D204):BRA CKET:HOLDER:F RONT:TONER B OTTLE	D0AL3504	(D203/D204):BRA CKET:HOLDER:F RONT:TONER B OTTLE	U007_S024	162	1	X/X			
201710-17	1710 Modification	A			D0AL3502	(D203/D204):HOL DER:FRONT:TON ER BOTTLE:5ST	U007_S024	161	1				
201710-18	1710 Modification	-	AA061108	TENSION SPRIN G:PRESSURE:TI MING ROLLER:R EGISTRATION	D1942990	TENSION SPRIN G:PRESSURE:TI MING ROLLER:R EGISTRATION	U013_S001	287	2	X/O			
201709-01	1709 Modification	-	D7314310	GUIDE:PAPER F EED:UPPER:SUB -ASS'Y	D7314311	GUIDE:PAPER F EED:UPPER:SUB -ASS'Y	U003_S001 _S012	268	1	O/O			
201709-02	1709 Modification	-			D1944433	COOLING UNIT:E XIT:ASS'Y	U016_S001	229	1				
201709-03	1709 Modification	-			D0744274	STOPPER:DIA4:P	U015_S001	254	1				

Design Change List

Number	Title	Set	Old Part		New Part		Index No.		Q'ty	Interchg		Reason	Cut-in S/N
			P/N	Name	P/N	Name	Group	ID		Indiv.	Set		
		-				EEN	U015_S002	254	1				
							U015_S003	254	1				
							U015_S004	254	1				
201707-01	1707 Modification	-	D7314313	GUIDE:PAPER FEED:UPPER:DOUBLE FEED SENSOR	D7314315	GUIDE:PAPER FEED:UPPER:DOUBLE FEED SENSOR	U003_S001	267	1	O/O			
201706-01	1706 Modification	-	D0396137	ENCODER:ASS'Y	D1941496	ENCODER:ASS'Y	U009	227	1	X/O			
201706-02	1706 Modification	-			D0741141	SUPPORTING PLATE:FRAME:MAIN	U022	53	2				
201705-01	1705 Modification	-			B1325996	DECAL:TOTAL COUNTER	U006	362	1				
201705-02	1705 Modification	-	D0744656	LEVER:GATE PAWL:REVERSE	D1944656	LEVER:GATE PAWL:REVERSE	U016	128	1	X/O			
201704-04	1704 Modification	-			D1944286	STAY:REAR	U015_S001	253	1				
							U015_S002	253	1				
							U015_S003	253	1				
							U015_S004	253	1				
201704-05	1704 Modification	-			D7312731	BASE:ORIGINAL TABLE	U003_S001	266	1				
201704-06	1704 Modification	-	M0771870	HARNESS:TUBE TYPE LAMP:JOINT			H6(2/3)		0				
201704-07	1704 Modification	-	D1949905	FUSING BRACKET SET			U015_S001	245	1				
							U015_S002	245	1				
							U015_S003	245	1				
							U015_S004	245	1				
201703-01	1703 Modification	-			D1944260	POSITIONING PLATE:FUSING UNIT	U015_S001	252	1				
							U015_S002	252	1				

Design Change List

Number	Title	Set	Old Part		New Part		Index No.		Q'ty	Interchg		Reason	Cut-in S/N
			P/N	Name	P/N	Name	Group	ID		Indiv.	Set		
		-				T:REAR:PEEN	U015_S003	252	1				
							U015_S004	252	1				
201702-01	1702 Modification	-	M2051095	SLIDE RAIL:INTERMEDIATE TRANSFER	D1941159	SLIDE RAIL:INTERMEDIATE TRANSFER	U022	48	2	O/O			
201702-02	1702 Modification	-			A2943354	RACK - 10Z	U007_S013	160	1				
							U007_S015	160	1				
							U007_S017	160	1				
							U007_S019	160	1				
201702-03	1702 Modification	-			D1946358	BRACKET:DENSITY SENSOR:INTERMEDIATE TRANSFER	U009	226	1				
201701-01	1701 Modification	-	D1944020	(-NA):FUSING UNIT:208V:ASS'Y	D1944021	(-NA):FUSING UNIT:208V:ASS'Y	U015_S004	251	1	O/O			
201701-02	1701 Modification	-			D0745101	SD-CARD:NICE:REGI2:ASS'Y	U020	125	1	X/O		Old part number: D0745100 Int:x/o	
201701-03	1701 Modification	-			D1946262	SERVICE PARTS:COIL SPRING:TRANSFER ROLLER:EXCHANGEABLE:20N	U009_S002	223	1	X/O		Old part number: D1946240 Int:x/o	
							U009_S003	223	1				
201701-04	1701 Modification	-			D1946263	SERVICE PARTS:COIL SPRING:TRANSFER ROLLER:EXCHANGEABLE:30N	U009_S004	224	1	X/O		Old part number: D1946241 Int:x/o	
							U009_S005	224	1				
201701-05	1701 Modification	-			D1946266	SERVICE PARTS:COIL SPRING:TRANSFER ROLL	U009_S006	225	1				
							U009_S007	225	1				

Design Change List

Number	Title	Set	Old Part		New Part		Index No.		Q'ty	Interchg		Reason	Cut-in S/N
			P/N	Name	P/N	Name	Group	ID		Indiv.	Set		
		-				ER:EXCHANGEABLE:60N							
201701-06	1701 Modification	-			D2033429	(D203/D204):TONER HOPPER:TONER SUPPLY:5ST:ASS'Y	U007_S023	159	1	X/X		Old part number: D2033430 Int:x/x	
201701-07	1701 Modification	-	D1946240	COIL SPRING:PRESSURE:TRANSFER ROLLER:20N			U009_S002	190	1	X/O		New part number: D1946262 Int:x/o	
							U009_S003	190	1				
201701-08	1701 Modification	-	D1946241	COIL SPRING:PRESSURE:TRANSFER ROLLER:30N			U009_S004	191	1	X/O		New part number: D1946263 Int:x/o	
							U009_S005	191	1				
201701-09	1701 Modification	-	D0745100	(C7100S):SD-CARD:NICE:REG:ASS'Y			U019	59	1	X/O		New part number: D0745101 Int:x/o	
201612-01	1612 Modification	-	B0654933	GUIDE PLATE LEVER HOOK	D2704933	GUIDE PLATE LEVER HOOK	U013_S001	90	1	O/O			
			B0654933	GUIDE PLATE LEVER HOOK	D2704933	GUIDE PLATE LEVER HOOK	U016	79	1	O/O			
201612-02	1612 Modification	-				B2343356	JOINT:CHUCK:TONER BOTTLE	U007_S013	157	1			
								U007_S015	157	1			
								U007_S017	157	1			
								U007_S019	157	1			
201612-03	1612 Modification	A	B1321224	SUPPORTING PLATE:BRACKET:LOCK	D1941234	SUPPORTING PLATE:BRACKET:LOCK	U016	82	1	X/O	X/O		
201612-04	1612 Modification	A	G1784759	BRACKET:LOCK:EXIT	D1944759	BRACKET:LOCK:EXIT	U016	194	1	X/O	X/O		

Design Change List

Number	Title	Set	Old Part		New Part		Index No.		Q'ty	Interchg		Reason	Cut-in S/N
			P/N	Name	P/N	Name	Group	ID		Indiv.	Set		
201612-05	1612 Modification	-	G1784759	BRACKET:LOCK:EXIT	D1944759	BRACKET:LOCK:EXIT	U013_S001	251	1	X/O			
201612-06	1612 Modification	-	D1947130	OZONE FILTER:C/T BOX:MM120	D1947135	OZONE FILTER:C/T BOX:MM120	U020	99	2	X/X		Old part number: D1947130,Int:x/x	
					D1947135	OZONE FILTER:C/T BOX:MM120	U020	99	1	X/X			
					D1947135	OZONE FILTER:C/T BOX:MM120	U020	99	1	X/X			
					D1947135	OZONE FILTER:C/T BOX:MM120	U020	99	1	X/X			
201611-01	1611 Modification	-	AA043669	TIMING BELT:40S2M158	AA043710	SYNCHRONOUS BELT:40S2M158	U003_S001	40	1	O/O			
201611-02	1611 Modification	-	D0746737	CAP:COVER:ARM:FRONT	D1946737	CAP:COVER:ARM:FRONT	U002	42	1	O/O			
201611-03	1611 Modification	-			D1945838	SIDE PLATE:C/T BOX:RIGHT:RIGHT:PEEN	U020	124	1				
201611-04	1611 Modification	-			D0741254	SIDE PLATE:C/T BOX:LEFT	U020	123	1				
201611-05	1611 Modification	-			D0747120	BRACKET:DUCT:COOLING:POSITIONING SENSOR	U021	136	1				
201610-03	1610 Modification	-	D6835860	CONTACT IMAGE SENSOR:ASS'Y	D6835863	CONTACT IMAGE SENSOR:ASS'Y	U003_S001	230	1	O/O			
201610-04	1610 Modification	-	D7312911	GUIDE PLATE:PULL OUT:LOWER	D7312913	GUIDE PLATE:PULL OUT:LOWER	U003_S001	239	1	O/O			
201610-05	1610 Modification	-	D1942610	TRANSPORT UNIT:ASS'Y	D1942612	TRANSPORT UNIT:ASS'Y	U013_S001	284	1	X/O			
201610-06	1610 Modification	-			D1949710	DEVELOPER NE	U008	122	1				

Design Change List

Number	Title	Set	Old Part		New Part		Index No.		Q'ty	Interchg		Reason	Cut-in S/N
			P/N	Name	P/N	Name	Group	ID		Indiv.	Set		
		-				ON-YELLOW							
201610-07	1610 Modification	-			D1948520	SERVICE PARTS :DECAL:NEON_Y :ASS'Y	U008	121	1				
201609-01	1609 Modification	-	D1944030	(-AA,-EU,-CHN):F USING UNIT:230 V:ASS'Y	D1944031	(-AA,-EU,-CHN):F USING UNIT:230 V:ASS'Y	U015_S001	250	1	O/O			
			D1944030	(-AA,-EU,-CHN):F USING UNIT:230 V:ASS'Y	D1944031	(-AA,-EU,-CHN):F USING UNIT:230 V:ASS'Y	U015_S002	250	1	O/O			
			D1944030	(-AA,-EU,-CHN):F USING UNIT:230 V:ASS'Y	D1944031	(-AA,-EU,-CHN):F USING UNIT:230 V:ASS'Y	U015_S003	250	1	O/O			
201609-02	1609 Modification	-			D1944449	SHEET:TRANSP ORT:EXIT:FRON T	U016_S007	227	1				
201609-03	1609 Modification	-			D1944453	SHEET:TRANSP ORT:EXIT:INNER BACK	U016_S007	228	1				
201609-04	1609 Modification	-	D1957211	(-AA,-NA):OPERA TION PANEL:ASS 'Y	D1957230	(-AA,-NA):OPERA TION PANEL:ASS 'Y	U002_S001	65	1	O/O			
			D1957211	(-AA,-NA):OPERA TION PANEL:ASS 'Y	D1957230	(-AA,-NA):OPERA TION PANEL:ASS 'Y	U002_S002	65	1	O/O			
201609-05	1609 Modification	-	D1957212	(-EU):OPERATIO N PANEL:ASS'Y	D1957231	(-EU):OPERATIO N PANEL:ASS'Y	U002_S003	66	1	O/O			
201609-06	1609 Modification	-	D1957213	(-CHN):OPERATI ON PANEL:ASS'Y	D1957232	(-CHN):OPERATI ON PANEL:ASS'Y	U002_S004	67	1	O/O			
201608-01	1608 Modification	-	D1495686	PCB:DCSW	D1775686	PCB:DCSW	U019	40	1	O/O			

Design Change List

Number	Title	Set	Old Part		New Part		Index No.		Q'ty	Interchg		Reason	Cut-in S/N
			P/N	Name	P/N	Name	Group	ID		Indiv.	Set		
201608-02	1608 Modification	-	D1362401	DRUM LUBRICANT SUPPLY ROLLER:ASS'Y	D2582402	OIL SUPPLY ROLLER:ASS'Y	U008_S007	78	1	O/O			
			D1362401	DRUM LUBRICANT SUPPLY ROLLER:ASS'Y	D2582402	OIL SUPPLY ROLLER:ASS'Y	U008_S010	78	1	O/O			
			D1362401	DRUM LUBRICANT SUPPLY ROLLER:ASS'Y	D2582402	OIL SUPPLY ROLLER:ASS'Y	U008_S013	78	1	O/O			
			D1362401	DRUM LUBRICANT SUPPLY ROLLER:ASS'Y	D2582402	OIL SUPPLY ROLLER:ASS'Y	U008_S016	78	1	O/O			
			D1362401	DRUM LUBRICANT SUPPLY ROLLER:ASS'Y	D2582402	OIL SUPPLY ROLLER:ASS'Y	U008_S019	78	1	O/O			
201608-03	1608 Modification	-	D1795445	AC CONTROL BOARD	D1945451	AC CONTROL BOARD	U019	43	1	O/O			
201608-04	1608 Modification	-			D1943330	ENTRANCE SEAL:DEVELOPMENT:ASS'Y	U008_S008	120	1				
					D1943330	ENTRANCE SEAL:DEVELOPMENT:ASS'Y	U008_S011	120	1				
					D1943330	ENTRANCE SEAL:DEVELOPMENT:ASS'Y	U008_S014	120	1				
					D1943330	ENTRANCE SEAL:DEVELOPMENT:ASS'Y	U008_S017	120	1				
					D1943330	ENTRANCE SEAL:DEVELOPMENT:ASS'Y	U008_S020	120	1				

Design Change List

Number	Title	Set	Old Part		New Part		Index No.		Q'ty	Interchg		Reason	Cut-in S/N
			P/N	Name	P/N	Name	Group	ID		Indiv.	Set		
		-				L:DEVELOPME T:ASS'Y							
201607-01	1607 Modification	-	D1245298	HDD:WD:320GB: WD3200BUCT	D2235308	HDD:320GB:MN5 00S-2:WD3200LU CT	U020_S007	85	2	O/O			
201607-02	1607 Modification	-	AA061066	COIL SPRING:GA TE	D1942648	COIL SPRING:GA TE	U013_S001	54	1	X/O			
201607-03	1607 Modification	-			D3AK1000	MEDIA IDENTIFI CATION UNIT	U023	51	1				
201606-01	1606 Modification	-	03540080N	SCREW:M4X8	03604008N	SCREW - M4X8	U021_S001	6	1	O/O			
			03540080N	SCREW:M4X8	03604008N	SCREW - M4X8	U021_S002	6	1	O/O			
			03540080N	SCREW:M4X8	03604008N	SCREW - M4X8	U021_S003	6	1	O/O			
			03540080N	SCREW:M4X8	03604008N	SCREW - M4X8	U021_S004	6	1	O/O			
			03540080N	SCREW:M4X8	03604008N	SCREW - M4X8	U021	6	1	O/O			
201606-02	1606 Modification	-	D1797235	COVER:OPERATI ON PANEL:REAR UPPER	D0746735	COVER:OPERATI ON PANEL:REAR UPPER	U023	24	1	O/O			
201606-03	1606 Modification	-	D1797323	(-EU):COVER:FR ONT RIGHT			U002_S003 _S001	53	1				
201606-04	1606 Modification	-			D1944495	DECAL:MISFEED REMOVAL:FLAT CONVEYER BEL T	U023	48	1				
201606-05	1606 Modification	-			D2037880	(D203):MODEL N AME PLATE:PRO _C7100SX	U023	49	1				
201606-06	1606 Modification	-			D2047880	(D204):MODEL N AME PLATE:PRO _C7110SX	U023	50	1				
201606-07	1606 Modification	A	D1946048	INNER COVER:IN	D1943861	INNER COVER:IN	U009	147	1	X/O	X/O	Set Part Number	

Design Change List

Number	Title	Set	Old Part		New Part		Index No.		Q'ty	Interchg		Reason	Cut-in S/N
			P/N	Name	P/N	Name	Group	ID		Indiv.	Set		
				TERMEDIATE TR ANSFER:RIGHT		TERMEDIATE TR ANSFER:RIGHT						[D1943860:INNE R COVER:INTER MEDIATE TRANS FER:LEFT(20150 2-01)]	
201605-01	1605 Modification	-	AW020203	PHOTOINTERRU PTOR:GP1A173L CS2F	AW020224	PHOTOINTERRU PTOR:GP1A173L CSVF	U003_S001	64	9	O/O			
201605-02	1605 Modification	-	D1942305	PCU:YMC:ASS'Y	D1942306	PCU:FC:ASS'Y	U008	91	1	X/O			
			D1942305	PCU:YMC:ASS'Y	D1942306	PCU:FC:ASS'Y	U008	91	1	X/O			
			D1942305	PCU:YMC:ASS'Y	D1942306	PCU:FC:ASS'Y	U008	91	1	X/O			
201605-04	1605 Modification	-			D1944293	PLATE:LEVER:P RESSURE	U015_S001	249	1				
							U015_S002	249	1				
							U015_S003	249	1				
							U015_S004	249	1				
201605-05	1605 Modification	-			D0743216	GUIDE:TONER S UPPLY:ASS'Y	U008_S008	119	1				
							U008_S011	119	1				
							U008_S014	119	1				
							U008_S017	119	1				
							U008_S020	119	1				
201605-06	1605 Modification	-	AW020198	PHOTOINTERRU PTOR:LG2A14NL 1	AW020224	PHOTOINTERRU PTOR:GP1A173L CSVF	U003_S001	64	1	O/O			
201604-01	1604 Modification	-	D1941503	SHAFT:DRIVE:BE LT CLEANING:AS	D1941509	SHAFT:DRIVE:BE LT CLEANING:AS	U018_S002	103	1	O/O			

Design Change List

Number	Title	Set	Old Part		New Part		Index No.		Q'ty	Interchg		Reason	Cut-in S/N
			P/N	Name	P/N	Name	Group	ID		Indiv.	Set		
		-		S'Y		S'Y							
201604-02	1604 Modification	-	D1941506	SHAFT:DRIVE:TRANSFER:ASS'Y	D1941508	SHAFT:DRIVE:TRANSFER:ASS'Y	U018_S003	104	1	O/O			
201604-03	1604 Modification	-	D2035450	(D203/D204):PCB:RFID-AFE:S			U007_S024	147	1				
201604-04	1604 Modification	-			11029803	CONNECTOR:6-292235-0	U016	225	1				
201604-05	1604 Modification	-			11029805	CONNECTOR:6-292233-0	U022	59	1				
201603-01	1603 Modification	-	D1941526	SHAFT:OUTPUT:DRIVE:FUSING:ASS'Y	D1941538	SHAFT:OUTPUT:DRIVE:FUSING:ASS'Y	U018_S005	107	1	O/O			
201603-02	1603 Modification	-			D1943713	PLATE:SHAFT:HUCK:TONER BOTTLE	U007_S013	156	1				
					D1943713	PLATE:SHAFT:HUCK:TONER BOTTLE	U007_S015	156	1				
					D1943713	PLATE:SHAFT:HUCK:TONER BOTTLE	U007_S017	156	1				
					D1943713	PLATE:SHAFT:HUCK:TONER BOTTLE	U007_S019	156	1				
201603-03	1603 Modification	-	AZ240224	DC POWER SUPPLY:450.3W	AZ240299	DC POWER SUPPLY	U020	126	1	X/O			
201603-04	1603 Modification	-	AZ240259	POWER SUPPLY UNIT:ECO:200V:456.4W	AZ240301	POWER SUPPLY UNIT:ECO:200V	U020	35	1	X/O			
201603-05	1603 Modification	-			D1365978	BRACKET:HDD	U020_S007	122	1				

Design Change List

Number	Title	Set	Old Part		New Part		Index No.		Q'ty	Interchg		Reason	Cut-in S/N
			P/N	Name	P/N	Name	Group	ID		Indiv.	Set		
201602-01	1602 Modification	-	D1947065	FILTER:DUCT:M M120	D1947055	FILTER:DUCT:M M120	U020	97	5	O/O			
201602-02	1602 Modification	-	D1945532	PCB:DRB	D1945538	PCB:DRB	U013_S001	245	1	X/O			
201602-03	1602 Modification	-			D1945832	HDD UNIT:ASS'Y	U020_S007	121	1				
201602-04	1602 Modification	-			D1944272	STAY:SEPARATI ON SUB-UNIT:PR ESSURE	U015_S001	248	1				
							U015_S002	248	1				
							U015_S003	248	1				
							U015_S004	248	1				
201602-05	1602 Modification	-			D1944742	STAY:LEFT UPP ER	U016	224	1				
201602-06	1602 Modification	-	D1947826	(D194-NA,CHN,AA): (D195/D203/D204): COVER:MAIN:RIGHT:ASS'Y	D1947829	(D194-EU):COVE R:MAIN:RIGHT:ASS'Y	U001	64	1	O/O			
201602-07	1602 Modification	-			D1943544	TONER BANK:ASS'Y	U007	155	4				
201602-08	1602 Modification	-			D1943751	DOOR:TONER SUPPLY	U001	68	1				
201601-01	1601 Modification	-	D1943851	TRANSPORT BELT UNIT:ASS'Y	D1943852	TRANSPORT BELT UNIT:ASS'Y	U014_S001	21	1	X/O			
201601-02	1601 Modification	-	AB010153	GEAR:DRIVE:155Z	AB010215	GEAR:DRIVE:155Z	U018_S003	36	1	O/O			
201601-04	1601 Modification	-	D1945542	PCB:TDRB	D1945546	PCB:TDRB	U009	140	1	X/O			
201601-05	1601 Modification	-	D1941161	SLIDE RAIL:TRANSPORT UNIT	D1941162	SLIDE RAIL:TRANSPORT UNIT	U022	38	2	O/O			
201601-06	1601 Modification	-	AX060460	DRIVE UNIT:ON-OFF:PRESSURE ROLLER	AX060510	DRIVE SUB-UNIT:ON-OFF:PRESSURE ROLLER	U018	61	1	X/O			
201601-07	1601 Modification	-			D0741288	SIDE PLATE:C/T BOX:UPPER	U020	120	1				

Design Change List

Number	Title	Set	Old Part		New Part		Index No.		Q'ty	Interchg		Reason	Cut-in S/N
			P/N	Name	P/N	Name	Group	ID		Indiv.	Set		
201601-08	1601 Modification	-			D1363406	SEAL:DEVELOPMENT ROLLER:FRONT	U008_S008	117	1				
							U008_S011	117	1				
							U008_S014	117	1				
							U008_S017	117	1				
							U008_S020	117	1				
201601-09	1601 Modification	-			D1363407	SEAL:DEVELOPMENT ROLLER:REAR	U008_S008	118	1				
							U008_S011	118	1				
							U008_S014	118	1				
							U008_S017	118	1				
							U008_S020	118	1				
201512-01	1512 Modification	-	D7314411	TRAY:EXIT	D7314418	TRAY:EXIT	U003_S001	251	1	X/O			
201512-02	1512 Modification	-			D1942610	TRANSPORT UNIT:ASS'Y	U013	284	1				
201512-03	1512 Modification	-			D1946201	BRUSH ROLLER:APPLY:ASS'Y	U011_S001	44	1				
201512-04	1512 Modification	-			D1943724	COMPRESSION SPRING:PRESSURE:SLIDER:TONER BANK	U007_S013	154	1				
							U007_S015	154	1				
							U007_S017	154	1				
							U007_S019	154	1				
201512-05	1512 Modification	-			D0743824	PLATE:ROLLER:INTERMEDIATE TRANSFER	U009	222	3				
201508-01	1508 Modification	-			D1941189	SEAL:OPTICAL WRITING UNIT:UPPER:LEFT	U022	49	1				
					D1941189	SEAL:OPTICAL WRITING UNIT:UPPER:LEFT	U022	49	1				
					D1941189	SEAL:OPTICAL WRITING UNIT:U	U022	49	1				

Design Change List

Number	Title	Set	Old Part		New Part		Index No.		Q'ty	Interchg		Reason	Cut-in S/N
			P/N	Name	P/N	Name	Group	ID		Indiv.	Set		
		-				PPER:LEFT							
					D1941189	SEAL:OPTICAL WRITING UNIT:U PPER:LEFT	U022	49	1				
					D1941189	SEAL:OPTICAL WRITING UNIT:U PPER:LEFT	U022	49	1				
201508-02	1508 Modification	-			D1941190	SEAL:OPTICAL WRITING UNIT:U PPER:RIGHT	U022	50	1				
					D1941190	SEAL:OPTICAL WRITING UNIT:U PPER:RIGHT	U022	50	1				
					D1941190	SEAL:OPTICAL WRITING UNIT:U PPER:RIGHT	U022	50	1				
					D1941190	SEAL:OPTICAL WRITING UNIT:U PPER:RIGHT	U022	50	1				
					D1941190	SEAL:OPTICAL WRITING UNIT:U PPER:RIGHT	U022	50	1				
201508-03	1508 Modification	-			D1942927	STOPPER:LEVE R:5MM	U001	67	1				
201508-04	1508 Modification	-	D1944324	COVER:ROLLER: POLISH	D1944325	COVER:ROLLER: POLISH:PRINTIN G	U015_S006	232	1	O/O			
201508-06	1508 Modification	A			D1945267	HARNESS:OZON E:FAN:FRONT:IO B	E5(1/3)		1				

Design Change List

Number	Title	Set	Old Part		New Part		Index No.		Q'ty	Interchg		Reason	Cut-in S/N
			P/N	Name	P/N	Name	Group	ID		Indiv.	Set		
201508-07	1508 Modification	A			D1945269	HARNESS:OZONE:FAN:FRONT	D5(1/3)		1				
201508-08	1508 Modification	A			D1945298	HARNESS:OZONE:POWER SUPPLY UNIT:5:CONNECTING	H7(1/3)		1				
201509-01	1509 Modification	-	D1944019	(-NA):FUSING UNIT:208V:ASS'Y	D1944020	(-NA):FUSING UNIT:208V:ASS'Y	U015	183	1	X/O			
201509-02	1509 Modification	-	D1944029	(-AA,-EU,-CHN):FUSING UNIT:230V:ASS'Y	D1944030	(-AA,-EU,-CHN):FUSING UNIT:230V:ASS'Y	U015	184	1	X/O			
			D1944029	(-AA,-EU,-CHN):FUSING UNIT:230V:ASS'Y	D1944030	(-AA,-EU,-CHN):FUSING UNIT:230V:ASS'Y	U015	184	1	X/O			
			D1944029	(-AA,-EU,-CHN):FUSING UNIT:230V:ASS'Y	D1944030	(-AA,-EU,-CHN):FUSING UNIT:230V:ASS'Y	U015	184	1	X/O			
201509-03	1509 Modification	-	D0744302	PLAIN SHAFT BEARING:ROLLER:REAR	AE031076	BUSHING:DIA4	U015_S005	157	1	O/O			
201509-04	1509 Modification	-	M0774200	MECHANICAL ROLLER CLUTCH:ROLLER	AE031075	PLAIN SHAFT BEARING:DIA4:MECHANICAL ROLLER CLUTCH	U015_S005	242	1	O/O			
201509-05	1509 Modification	-	D1944267	BRACKET:GRIP:REAR	D1944268	BRACKET:GRIP:REAR	U015_S001	219	1	X/O			
							U015_S002	219	1				
							U015_S003	219	1				
							U015_S004	219	1				
201509-06	1509 Modification	-	D0742786	GUIDE PLATE:CONNECTING:LAR	D1942786	GUIDE PLATE:CONNECTING:LAR	U013_S001	152	1	X/O			

Design Change List

Number	Title	Set	Old Part		New Part		Index No.		Q'ty	Interchg		Reason	Cut-in S/N
			P/N	Name	P/N	Name	Group	ID		Indiv.	Set		
		-		GE CAPACITY T RAY:LOWER		GE CAPACITY T RAY:LOWER							
201509-07	1509 Modification	-	D0744670	BRACKET:DUPL EX:REVERSE:SE NSOR	M2054908	BRACKET:DUPL EX:REVERSE:SE NSOR	U016	132	1	O/O			
201509-08	1509 Modification	-			D1947124	DUCT:PCU:FRO NT:4ST:ASS'Y	U021	128	1				
					D1947124	DUCT:PCU:FRO NT:4ST:ASS'Y	U021	128	1				
					D1947124	DUCT:PCU:FRO NT:4ST:ASS'Y	U021	128	1				
					D1947124	DUCT:PCU:FRO NT:4ST:ASS'Y	U021	128	1				
201509-09	1509 Modification	-			D1941761	SHEET:INDICATI NG HOLE ON A B OARD:NICE:GRA Y:ASS'Y	SPECIAL T OOLS	13	1				
201509-10	1509 Modification	-			D1941764	SHEET:INDICATI NG HOLE ON A B OARD:NICE:BLA CK:ASS'Y	SPECIAL T OOLS	14	1				
201509-11	1509 Modification	-			D1941766	COVER:NICE:BL ACK	SPECIAL T OOLS	15	1				
201509-12	1509 Modification	-			D1941767	COVER:NICE:WH ITE	SPECIAL T OOLS	16	1				
201509-13	1509 Modification	A			D1945299	HARNESS:OZON E:LIQUID COOLI NG:BOX:CONNE CTING	D1(1/3)		1				
201507-01	1507 Modification	-	D1943766	INNER COVER:M	D1943776	INNER COVER:M	U007	126	1	X/O			

Design Change List

Number	Title	Set	Old Part		New Part		Index No.		Q'ty	Interchg		Reason	Cut-in S/N
			P/N	Name	P/N	Name	Group	ID		Indiv.	Set		
		-		OTOR:TONER H OPPER:TONER S SUPPLY		OTOR:TONER H OPPER:TONER S SUPPLY							
201507-02	1507 Modification	-			D1944306	BRACKET:SENS OR:ON-OFF	U015_S001	246	1				
							U015_S002	246	1				
							U015_S003	246	1				
							U015_S004	246	1				
201507-03	1507 Modification	A	D1942703	SWING UNIT:AS S'Y	D1942704	SWING UNIT:AS S'Y	U013_S001 _S002	227	1	X/O			
201507-04	1507 Modification	A	D0747837	DECAL:MISFEED REMOVAL	D1944497	DECAL:MISFEED REMOVAL:DE	U001_S004	41	1	X/O			
201507-05	1507 Modification	-	D1941462	HEXAGON HEAD BOLT:DOUBLE S CREW:M4X10	D1941224	HEXAGON HEAD SCREW:M4X10: WASHER:DIA9:A SS'Y	U020	94	1	O/O			
			D1941462	HEXAGON HEAD BOLT:DOUBLE S CREW:M4X10	D1941224	HEXAGON HEAD SCREW:M4X10: WASHER:DIA9:A SS'Y	U020	94	1	O/O			
201507-06	1507 Modification	-	D1947800	SUPPORTING PL ATE:DOOR:FRO NT LEFT:ASS'Y	D1947801	SUPPORTING PL ATE:DOOR:FRO NT LEFT:ASS'Y	U001_S004	62	1	O/O			
201507-07	1507 Modification	-			D1942841	SEPARATION PL ATE:CONTACT I MAGE SENSOR: DUCT	U013_S001	282	1				
201506-01	1506 Modification	A	D1942959	SHEET:OPPOSE D:CONTACT IMA GE SENSOR	D1942850	SHEET:OPPOSE D:CONTACT IMA GE SENSOR	U013_S001 _S002	231	1	X/O			
201506-02	1506 Modification	A	D1942966	SHEET:OPPOSE	D1942851	SHEET:OPPOSE	U013_S001	234	1	X/O			

Design Change List

Number	Title	Set	Old Part		New Part		Index No.		Q'ty	Interchg		Reason	Cut-in S/N
			P/N	Name	P/N	Name	Group	ID		Indiv.	Set		
				D:CONTACT IMAGE SENSOR:LONG		D:CONTACT IMAGE SENSOR:LONG	_S002						
201506-03	1506 Modification	A			D1942852	SHEET:OPPOSE D:CONTACT IMAGE SENSOR:STAY	U013_S001	277	1				
201506-04	1506 Modification	A			D1942853	SHEET:OPPOSE D:CONTACT IMAGE SENSOR:DUCT:LEFT	U013_S001	278	1				
201506-05	1506 Modification	A			D1942854	SHEET:OPPOSE D:CONTACT IMAGE SENSOR:DUCT	U013_S001	279	1				
201506-06	1506 Modification	A			D1942855	SHEET:SEPARATION PLATE:CONTACT IMAGE SENSOR:DUCT	U013_S001	280	1				
201506-07	1506 Modification	A			D1942977	SEPARATION PLATE:CONTACT IMAGE SENSOR:DUCT	U013_S001	281	1				
201506-08	1506 Modification	-	D1945296	HARNESS:DC:POWER SUPPLY UNIT:5:CONNECTING	D1945294	HARNESS:DC:POWER SUPPLY UNIT:5:CONNECTING	H6(1/3)		1	X/O			
201506-09	1506 Modification	-	D1945369	HARNESS:INTERMEDIATE TRANSFER:REAR	D1945395	HARNESS:INTERMEDIATE TRANSFER:REAR	E1(2/3)		1	X/O			

Design Change List

Number	Title	Set	Old Part		New Part		Index No.		Q'ty	Interchg		Reason	Cut-in S/N
			P/N	Name	P/N	Name	Group	ID		Indiv.	Set		
201506-10	1506 Modification	-	D1948514	LIQUID COOLING :PT:ASS'Y	D1948515	LIQUID COOLING :PT:TAURUS-C2: ASS'Y	U020_S005	111	1	X/O			
201506-11	1506 Modification	-	D1947550	LEFT REAR FEN CE	D1797544	SIDE FENCE:TA NDEM LCT:LEFT REAR:ASS'Y	U006_S005	345	1	X/O			
			D1947550	LEFT REAR FEN CE	D1797544	SIDE FENCE:TA NDEM LCT:LEFT REAR:ASS'Y	U006_S006	345	1	X/O			
			D1947550	LEFT REAR FEN CE	D1797544	SIDE FENCE:TA NDEM LCT:LEFT REAR:ASS'Y	U006_S007	345	1	X/O			
			D1947550	LEFT REAR FEN CE	D1797544	SIDE FENCE:TA NDEM LCT:LEFT REAR:ASS'Y	U006_S008	345	1	X/O			
201506-12	1506 Modification	-	D1947464	GUIDE PLATE:FE ED PAPER AGAI N:ASS'Y	D1947469	GUIDE PLATE:FE ED PAPER AGAI N:ASS'Y	U006_S015	340	1	X/O			
201506-13	1506 Modification	-	D1941464	DRUM STAY:DC MOTOR:DRIVE	D1941466	DRUM STAY:DC MOTOR:DRIVE:P RESS FIT	U009	129	1	X/O			
201506-15	1506 Modification	-	D6833661	GUIDE PLATE:C ONTACT IMAGE SENSOR:ENTRA NCE:ASS'Y	D6833662	GUIDE PLATE:C ONTACT IMAGE SENSOR:ENTRA NCE:ASS'Y	U003_S001 _S009	196	1	X/O			
201506-16	1506 Modification	-			D1949905	FUSING BRACKE T SET	U015_S001	245	1				
					D1949905	FUSING BRACKE T SET	U015_S002	245	1				
					D1949905	FUSING BRACKE T SET	U015_S003	245	1				

Design Change List

Number	Title	Set	Old Part		New Part		Index No.		Q'ty	Interchg		Reason	Cut-in S/N
			P/N	Name	P/N	Name	Group	ID		Indiv.	Set		
		-				T SET							
		-			D1949905	FUSING BRACKET SET	U015_S004	245	1				
201505-01	1505 Modification	-			D2035453	(D203/D204):PCB:RFID-AFE:S	U007_S024	150	1				
201505-02	1505 Modification	-	D0743722	(D203/D204):COIL SPRING:DRIVE SUB-UNIT:TONE R SUPPLY UNIT	D2033528	(D203/D204):COIL SPRING:DRIVE SUB-UNIT:TONE R SUPPLY UNIT	U007_S025	63	1	X/O			
201505-03	1505 Modification	-	D2033520	(D203/D204):DRIVE UNIT:TONER BOTTLE:5ST:ASSY	D2033521	(D203/D204):DRIVE UNIT:TONER BOTTLE:5ST:ASSY	U007_S025	140	1	X/O			
201505-04	1505 Modification	-	AA000290	DECAL:POSITIONING DISPLAY:SCREW:PET			U015_S006	243	1				
			AA000290	DECAL:POSITIONING DISPLAY:SCREW:PET			U015_S006	243	1				
201505-05	1505 Modification	-	M2054487	DECAL:GRIP:WEB			U015_S006	244	1				
			M2054487	DECAL:GRIP:WEB			U015_S006	244	1				
201505-06	1505 Modification	-			D1941168	COVER:SHIELD GLASS	U022	40	1				
					D1941168	COVER:SHIELD GLASS	U022	40	1				
					D1941168	COVER:SHIELD GLASS	U022	40	1				
					D1941168	COVER:SHIELD GLASS	U022	40	1				

Design Change List

Number	Title	Set	Old Part		New Part		Index No.		Q'ty	Interchg		Reason	Cut-in S/N
			P/N	Name	P/N	Name	Group	ID		Indiv.	Set		
		-				GLASS							
					D1941168	COVER:SHIELD GLASS	U022	40	1				
201505-07	1505 Modification	-			D1797303	(-EU):COVER:FR ONT:ASS'Y	U002_S003 _S001	78	1	X/O			
201504-01	1504 Modification	-			AA000313	DECAL:CAUTION :INSERT:PAPER FEED SUB-UNIT	U006_S005 _S001	361	1				
					AA000313	DECAL:CAUTION :INSERT:PAPER FEED SUB-UNIT	U006_S006 _S001	361	1				
					AA000313	DECAL:CAUTION :INSERT:PAPER FEED SUB-UNIT	U006_S007 _S001	361	1				
					AA000313	DECAL:CAUTION :INSERT:PAPER FEED SUB-UNIT	U006_S008 _S001	361	1				
201504-02	1504 Modification	-			D1947983	(CHN):POWER S UPPLY CODE:DE CAL:ASS'Y	U023_S012 U023_S013	47 47	1 1				
201503-01	1503 Modification	-	AX640201	FAN:MM60:DC 3. 12W	AX640207	FAN:MM60	U014_S001	14	3	X/O			
201503-02	1503 Modification	-	D1942301	PCDU:ASS'Y	D1942303	PCU:ASS'Y	U008	90	1	O/O			
			D1942301	PCDU:ASS'Y	D1942303	PCU:ASS'Y	U008	90	1	O/O			
201502-01	1502 Modification	A	D1943859	INNER COVER:IN TERMEDIATE TR ANSFER:LEFT	D1943860	INNER COVER:IN TERMEDIATE TR ANSFER:LEFT	U009	139	1	X/O			
201502-02	1502 Modification	A	B1326763	BRACKET:CONN ECTOR:LEFT	D1316511	BRACKET:CONN ECTOR:LEFT	U006	173	1	O/O			
201502-03	1502 Modification	A	08030058	STEPPED SCRE	AA143797	CONNECTOR GU	U006	360	2	X/O			

Design Change List

Number	Title	Set	Old Part		New Part		Index No.		Q'ty	Interchg		Reason	Cut-in S/N
			P/N	Name	P/N	Name	Group	ID		Indiv.	Set		
				W		IDE PIN							
201502-04	1502 Modification	-			D1946248	DECAL:INNER C OVER:INTERME DIATE TRANSFE R	U009	221	1				
					D1946248	DECAL:INNER C OVER:INTERME DIATE TRANSFE R	U009	221	1				
					D1946248	DECAL:INNER C OVER:INTERME DIATE TRANSFE R	U009	221	1				
					D1946248	DECAL:INNER C OVER:INTERME DIATE TRANSFE R	U009	221	1				
201502-05	1502 Modification	-			B2342399	BOLT - M3X6	U009	219	1				
201502-06	1502 Modification	-	AA143797	CONNECTOR GU IDE PIN	G1787515	CONNECTOR GU IDE PIN:CONNEC TOR	U022	63	1	X/O			
			AA143797	CONNECTOR GU IDE PIN	G1787515	CONNECTOR GU IDE PIN:CONNEC TOR	U022	63	1	X/O			
201502-07	1502 Modification	-	03604008N	SCREW - M4X8	D1946236	HEXAGON HEAD SCREW:WASHE R:M4X10:ASS'Y	U009	8	1	X/O			
			03604008N	SCREW - M4X8	D1946236	HEXAGON HEAD SCREW:WASHE R:M4X10:ASS'Y	U009	8	1	X/O			

Design Change List

Number	Title	Set	Old Part		New Part		Index No.		Q'ty	Interchg		Reason	Cut-in S/N
			P/N	Name	P/N	Name	Group	ID		Indiv.	Set		
201502-08	1502 Modification	-			D1955100	SD-CARD:NICE:LEO:ASS'Y	U019	58	1				
201502-09	1502 Modification	-			D1946222	GUIDE:TRANSPORT:INTERMEDIATE TRANSFER:5.0-:ASS'Y	U009	220	1				
201501-03	1501 Modification	A			D1797302	COVER:FRONT:ASS'Y	U002_S001	77	1				
							U002_S002	77	1				
201501-04	1501 Modification	A	D1797312	(-AA,-NA):COVER:FRONT			U002_S001	49	1	X/X			
201501-05	1501 Modification	A	D1797322	(-AA,-NA):COVER:FRONT RIGHT			U002_S001	52	1	X/X			
201510-01	1510 Modification	-			D1944413	GUIDE:FIX:SHEET:CING	U016_S001	223	1				
201510-02	1510 Modification	-			D6832913	SHEET:SENSOR:SEPARATION	U003_S001	265	2				
201510-03	1510 Modification	-	D0742850	GUIDE PLATE:VERTICAL TRANSPORT:RIGHT	D1942860	GUIDE PLATE:VERTICAL TRANSPORT:RIGHT:PEEN	U013_S001	162	1	O/O			
201510-04	1510 Modification	-	D1944211	STRIPPER PLATE:ASS'Y	D1944209	STRIPPER PLATE:ASS'Y	U015_S001	211	1	X/O			
			D1944211	STRIPPER PLATE:ASS'Y	D1944209	STRIPPER PLATE:ASS'Y	U015_S002	211	1	X/O			
			D1944211	STRIPPER PLATE:ASS'Y	D1944209	STRIPPER PLATE:ASS'Y	U015_S003	211	1	X/O			
			D1944211	STRIPPER PLATE:ASS'Y	D1944209	STRIPPER PLATE:ASS'Y	U015_S004	211	1	X/O			

Design Change List

Number	Title	Set	Old Part		New Part		Index No.		Q'ty	Interchg		Reason	Cut-in S/N
			P/N	Name	P/N	Name	Group	ID		Indiv.	Set		
201510-05	1510 Modification	-			AX660905	DC FAN MOTOR: DC24V:MM120:P WM CONTROL:1 8W	U020	119	1				
					AX660905	DC FAN MOTOR: DC24V:MM120:P WM CONTROL:1 8W	U020	119	1				
					AX660905	DC FAN MOTOR: DC24V:MM120:P WM CONTROL:1 8W	U020	119	1				
201511-01	1511 Modification	-			D1943496	STAND:INNER C OVER:RECEPTA CLE:TONER SUP PLY	U007	151	1				
201511-02	1511 Modification	-			D2033493	HOLDER:RECEP TACLE:TONER S UPPLY UNIT:5ST :ASS'Y	U007	153	1				
201511-03	1511 Modification	-			D1947152	FAN:PCU:UPPER FRONT:ASS'Y	U021	134	2				
201511-04	1511 Modification	-			D1947127	DUCT:PCU:FRO NT:4ST:ASS'Y	U021_S001	131	1				
							U021_S002	131	1				
							U021_S003	131	1				
							U021_S004	131	1				
201511-05	1511 Modification	-			D1947042	DUCT:PCU:UPPE R FRONT:SERVI CE:ASS'Y	U021	129	1				
					D1947042	DUCT:PCU:UPPE	U021	129	1				

Design Change List

Number	Title	Set	Old Part		New Part		Index No.		Q'ty	Interchg		Reason	Cut-in S/N
			P/N	Name	P/N	Name	Group	ID		Indiv.	Set		
		-				R FRONT:SERVI CE:ASS'Y							
201511-06	1511 Modification	-			D1947144	BRACKET:DUCT: PCU:UPPER FRO NT:AUXILIARY	U021	133	1				
					D1947144	BRACKET:DUCT: PCU:UPPER FRO NT:AUXILIARY	U021	133	1				
					D1947144	BRACKET:DUCT: PCU:UPPER FRO NT:AUXILIARY	U021	133	1				
					D1947144	BRACKET:DUCT: PCU:UPPER FRO NT:AUXILIARY	U021	133	1				
201511-07	1511 Modification	-			D1947103	DUCT:PCU:UPPE R FRONT:SST:A SS'Y	U021	130	1				
201511-08	1511 Modification	-			D1947129	DUCT:PCU:FRO NT:5ST:ASS'Y	U021	132	1				

