

Pro 8200EX/8200S/8210S/8220S
(D270/D271/D272)
Parts Catalog

Parts change information sample

 **Add**

 **Update**

 **Delete**

Model	Product Code	PC Style
RICOH Pro 8200EX	D270	3D
RICOH Pro 8200S	D270	
RICOH Pro 8210S	D271	
RICOH Pro 8220S	D272	
Decurl Unit DU5050	D3DR	3D
ADF Double-feed Detection kit Type-S7	D3DS	3D
Booklet Finisher SR5060	D734	3D
Finisher SR5050	D735	3D
Multi-Folding Unit FD5020	D740	3D
Multi Bypass Tray BY5010	D517	3D
Multi Bypass Banner Sheet Tray Type S3	D517	3D
LCIT RT5080	D732	3D
LCIT RT5070	D733	3D
Cover Interposer Tray CI5030	D738	3D
High Capacity Stacker SK5030	D776	3D
Roll-Away Cart Type 5010	D456	3D
Vacuum Feed LCIT RT5100	D777	3D
Bridge Unit BU5010	D778	3D
Multi Bypass Attachment Kit for Vacuum Feed LCIT Type S3	D777	3D
Printer Controller EB-34	D3DT	2D
Printer Controller EB-34	D3DT	2D
Copy Connector Type 3260	B328	2D
Optional Counter Interface Unit Type A	B870	2D
Key Counter Bracket Type 1027	B452	2D
IEEE 1284 Interface Board Type A	B679	2D
IEEE 802.11a/g/n Interface Unit Type M2	D164	2D
PostScript3 Unit Type S1	D3DV	2D
IPDS Unit Type S1	D3DV	2D
File Format Converter Type E	D377	2D
Copy Data Security Unit	D640	2D
OCR Unit Type M2	D166	2D

Unit All



U001
EXTERIOR



U002
OPERATION

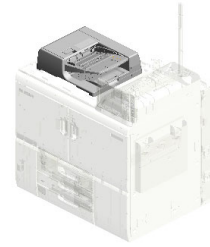

U003
ADF

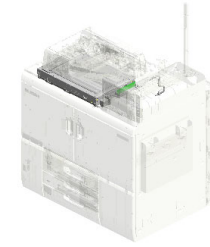

U004
SCANNER

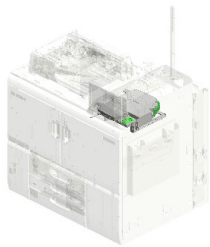

U005
LASER UNIT

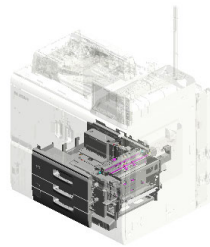

U006
PAPER FEED:PAPER BANK

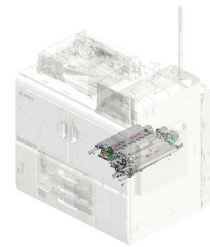

U007
PAPER FEED

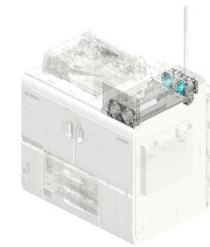

U008
TONER SUPPLY

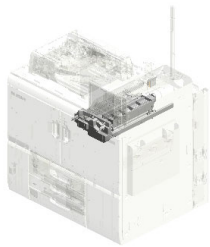

U009
PCU

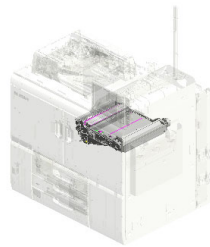

U010
ITB UNIT

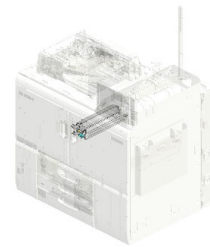

U011
ITB CLEANING

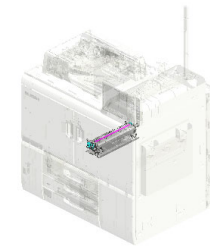

U012
TRANSFER/SEPARATION

Unit All

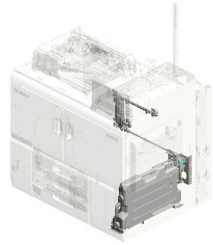

U013
USED TONER

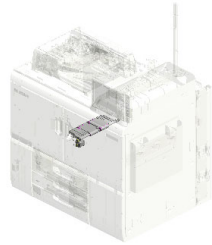

U014
SEPARATION/TRANSPORT

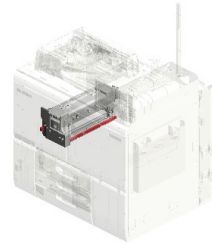

U015
FUSING

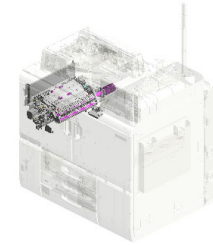

U016
PAPER EXIT

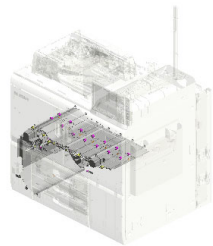

U017
DUPLEX

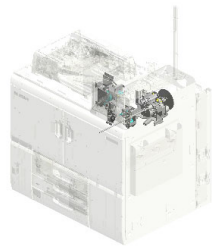

U018
MAIN DRIVE

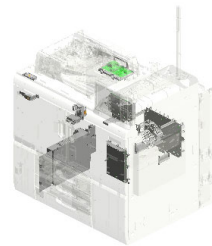

U019
ELECTRICAL

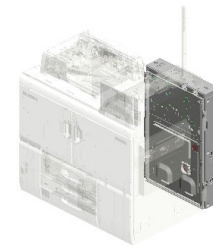

U020
CONTROLLER

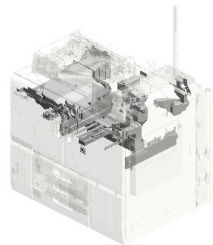

U021
AIR COOLING

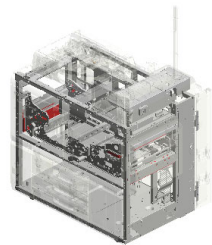

U022
MAIN FRAME

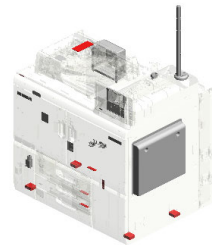

U023
ACCESSORIES

U001.EXTERIOR

U001 S002
D1791454
DOOR:TONER SUPPLY:ASS'
Y

U001 S006
D0BX1550
INNER COVER:INTERMEDIA
TE TRANSFER:ASS'Y

U001 S001
D2701449
COVER:TONER SUPPLY:UPP
ER:ASS'Y

U001 S003
D0BX1506
SUPPORTING PLATE:DOOR:
FRONT RIGHT:ASS'Y

U001 S004
D0BX1488
SUPPORTING PLATE:DOOR:
FRONT LEFT:ASS'Y

U001 S005
D0BX1427
COVER:MAIN:REAR:SUB-AS
SY

U001	U002	U003	U004	U005	U006	U007	U008	U009	U010	U011	U012	U013	U014	U015	U016	U017	U018	U019	U020	U021
------	------	------	------	------	------	------	------	------	------	------	------	------	------	------	------	------	------	------	------	------

U001 EXTERIOR



- 5.04544010N (x7) TAPPING SCREW: ROUND POINT:4X10
- 12.52062686 SNAP RING
- 7.08025330 (x77) PAN HEAD WITH COLLAR TAPPING SCREW:PF:4X10
- 6.07050040N (x24) WASHER:DIA4
- 18.C2672944 (x2) SCREW:ACTUATOR SURFACE OF PAPER SENSOR

- 19.D0743829 (x2) DECAL:POSITIONING DISPLAY:TCRU



- 16.B2342390 (x4) FLANGED HEXAGONAL HEAD BOLT: M4X8



- 14.AC020152 (x6) LENS:LED:3



- 15.AC020153 (x3) LENS:LED:4



- 21.D0747828 CAP:CONNECTOR



- 20.D0747782 (x2) GRIP:DOOR:FRONT
- 9.11050511 HARNESS CLAMP - LWS-0306ZC
- 1.03540080N (x5) SCREW:M4X8
- 3.04514008N (x58) TAPPING SCREW: 4X8
- 2.03604008N (x6) SCREW - M4X8



- 8.09543025N (x2) SCREW:POLISHED ROUND/SPRING:M3X25



- 16.B2342390 (x3) FLANGED HEXAGONAL HEAD BOLT: M4X8



- 17.C1012360 (x2) SNAP RING

- 11.12042612 (x2) MICRO SWITCH:D3 V-16506-3C25

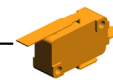

- 1.03540080N (x 3) SCREW:M4X8
- 3.04514008N (x 4) TAPPING SCREW:4X8

- 13.AA143797 CONNECTOR GUI DE PIN

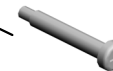

- 4.04544008Q (x2) TAPPING SCREW - M4X8



- 10.11050723 CLAMPS:WES-0507

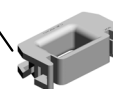

U001 EXTERIOR



- 31.D1791451 CAP:KEY COUNT
ER
- 35.D1791460 (x2)
HINGE:DOOR:TON
ER SUPPLY
- 45.D1791497 DOOR:FRONT RIG
HT:UPPER
- 37.D1791470 BRACKET:COVER:
FRONT UPPER
- 36.D1791469 COVER:FRONT UP
PER

28.D1791443
COVER:UPPER RI
GHT

23.D0747830
COVER:LARGE CA
PACITY TRAY

30.D1791446
COVER:UPPER RE
AR

22.D0747829
(x4)
CAP:JOINT:LARGE
CAPACITY TRAY

24.D0747831
COVER:CONNECT
OR:LARGE CAPACI
TY TRAY

26.D0747861
HINGE:RIGHT LOW
ER:ASS'Y

41.D1791483
(x2)
LEVER:SAFETY S
WITCH

43.D1791487
DUCT:DOOR:FRO
NT LEFT:ASS'Y

42.D1791485
DOOR:FRONT LEF
T:LOWER

25.D0747854
HINGE:LEFT LOWE
R:ASS'Y

38.D1791471
LEVER:SAFETY S
WITCH

39.D1791476
BRACKET:SAFETY
SWITCH

29.D1791444
COVER:UPPER FR
ONT

27.D1791442
COVER:DC_SW

40.D1791477
SHIELD PLATE:SA
FETY SWITCH

U001 EXTERIOR

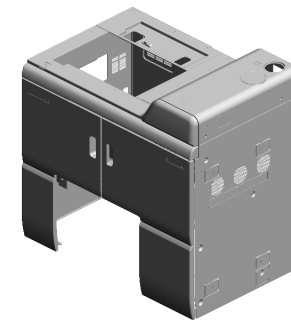

- 46.D1791499 CAP:MM22
- 57.D1791583 (x2) SEAL:PLATE:MAGNET CATCH
- 56.D1791582 (x2) PLATE:MAGNET CATCH
- 51.D1791526 STAY:SAFETY SWITCH
- 78.D2701566 INNER COVER:LEFT UPPER

53.D1791533
HINGE:RIGHT UPPER

72.D2701542
(x3)
DECAL:H-TEMP WARNING:PAPER FEED:ABS

69.D2701538
INNER COVER:PULL OUT:RIGHT

50.D1791514
COVER:MAIN:RIGHT

47.D1791500
DOOR:FRONT RIGHT:LOWER

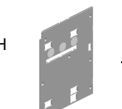
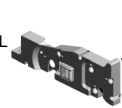

55.D1791572
(x2)
BRACKET:EARTH:DOOR:LOWER

54.D1791571
(x2)
BRACKET:EARTH:DOOR:MIDDLE

75.D2701562
INNER COVER:REVERSE SUB-UNIT:UPPER

76.D2701563
INNER COVER:REVERSE SUB-UNIT:LOWER

77.D2701564
DECAL:TOTAL COUNDER:ABS

79.D2701567
DECAL:MAIN SWITCH:ABS

52.D1791531
HINGE:LEFT UPPER

71.D2701541
DECAL:H-TEMP WARNING:EXIT:FUSING:ABS

64.D2701481
DOOR:FRONT LEFT:UPPER

70.D2701540
INNER COVER:PULL OUT:LEFT

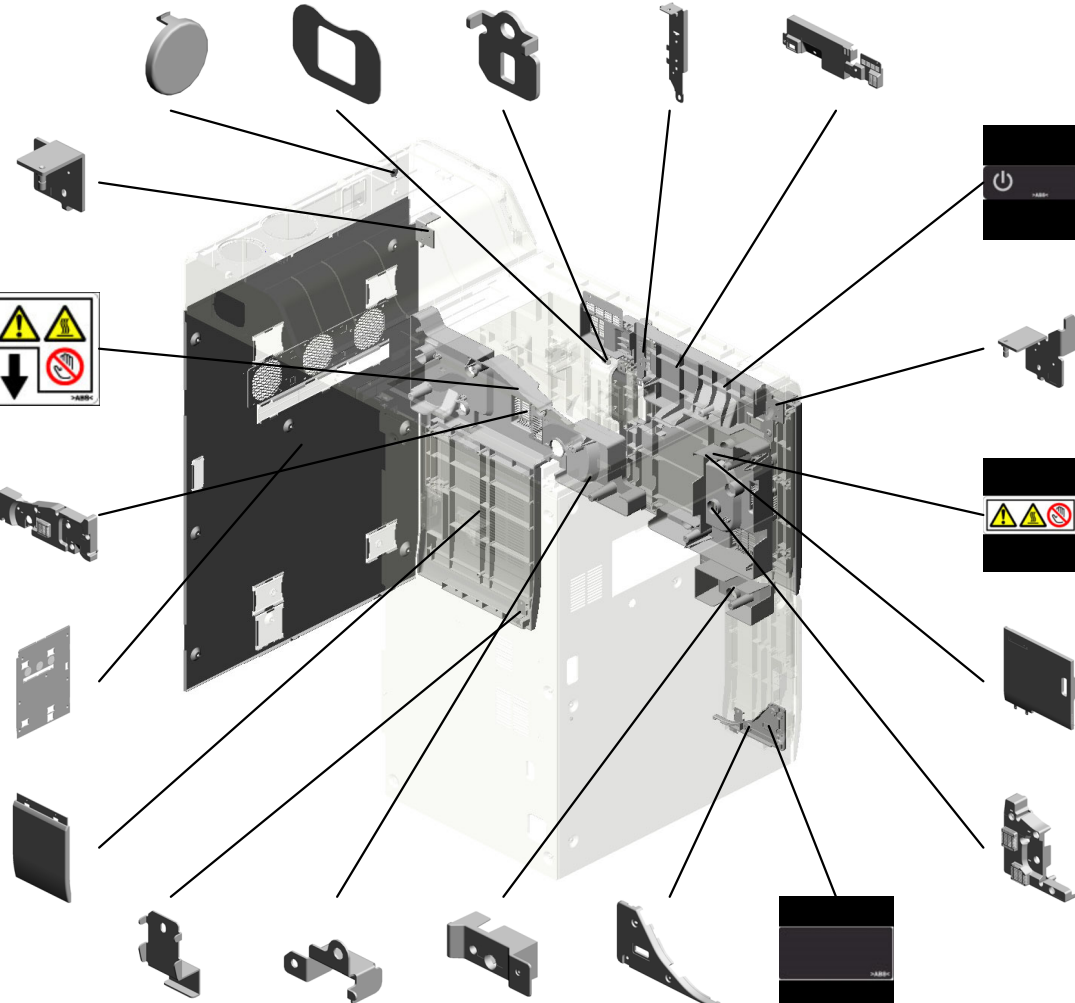

U001 EXTERIOR

92.D2706949 SHEET:COVER:MAIN:RIGHT
201704-21

87.D5481243 STAND:UN LOCK

80.D2701568 DECAL:POSITIONING DISPLAY:TCRU
:ABS



91.D2706948 SHEET:SCREW:FILTER
201704-20

82.D2701573 [B] DECAL:B2
201704-01 X/O

81.D2701571 DECAL:B1

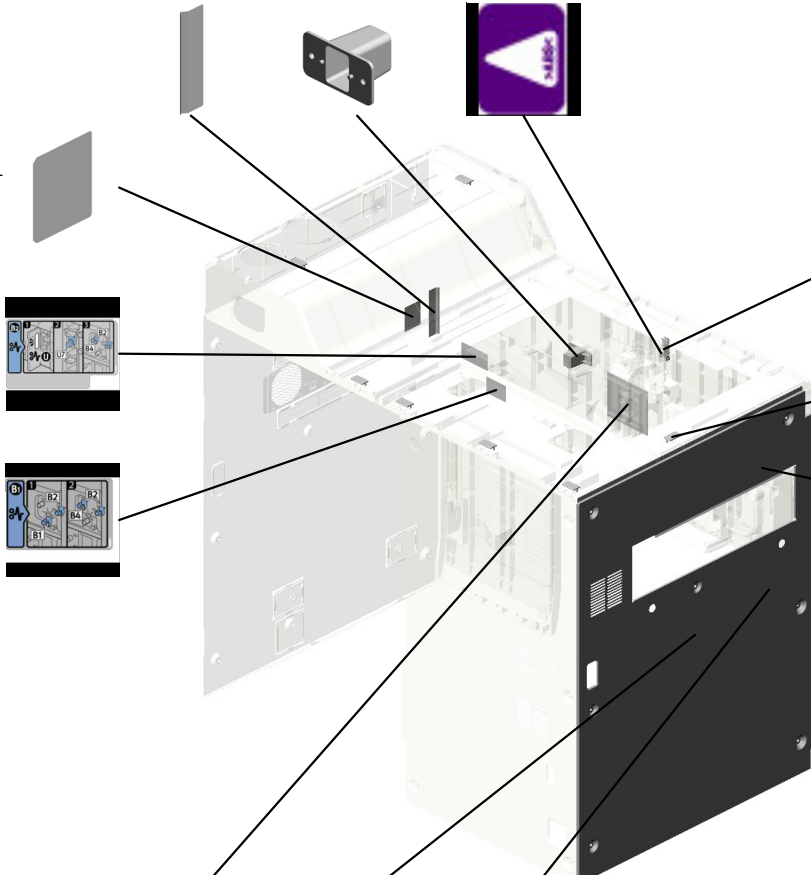

93.D2701191 DECAL:PICK-UP PAPER JAM:OPERATION PANEL:ENGLISH
201708-01



103.D0BX1508 [A] COVER:MAIN:LEFT
202105-01 O/O



84.D2701586 DECAL:E



89.G1781602 ARM:SAFETY SWITCH:UPPER:ASSY



90.M0447747 (x7) CAP:COVER:REAR

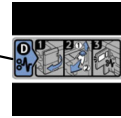

83.D2701585 DECAL:D1

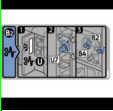
 D2701508 [A] COVER:MAIN:LEFT 202105-01 O/O	 D2701572 [B] DECAL:B2 201704-01 X/O
---	--

U001_S001
COVER:TONER SUPPLY:UPPER:ASS'Y

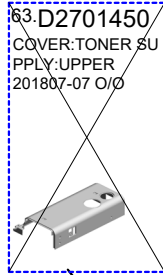

U001	U002	U003	U004	U005	U006	U007	U008	U009	U010	U011	U012	U013	U014	U015	U016	U017	U018	U019	U020	U021
------	------	------	------	------	------	------	------	------	------	------	------	------	------	------	------	------	------	------	------	------

U001_S002
DOOR:TONER SUPPLY:ASS'Y

7.08025330 (x8)
PAN HEAD WITH COLLAR TAPPING SCREW:PF:4X10

60.D1793366
DECAL:REPLACEMENT INDICATION:TONER BOTTLE

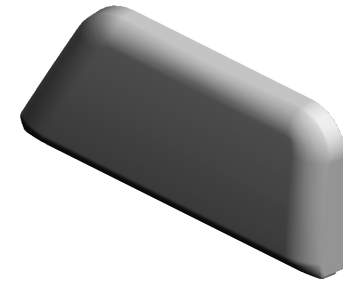

32.D1791454
DOOR:TONER SUPPLY:ASS'Y

33.D1791456
SUPPORTING PLATE:HINGE:DOOR:TONER SUPPLY

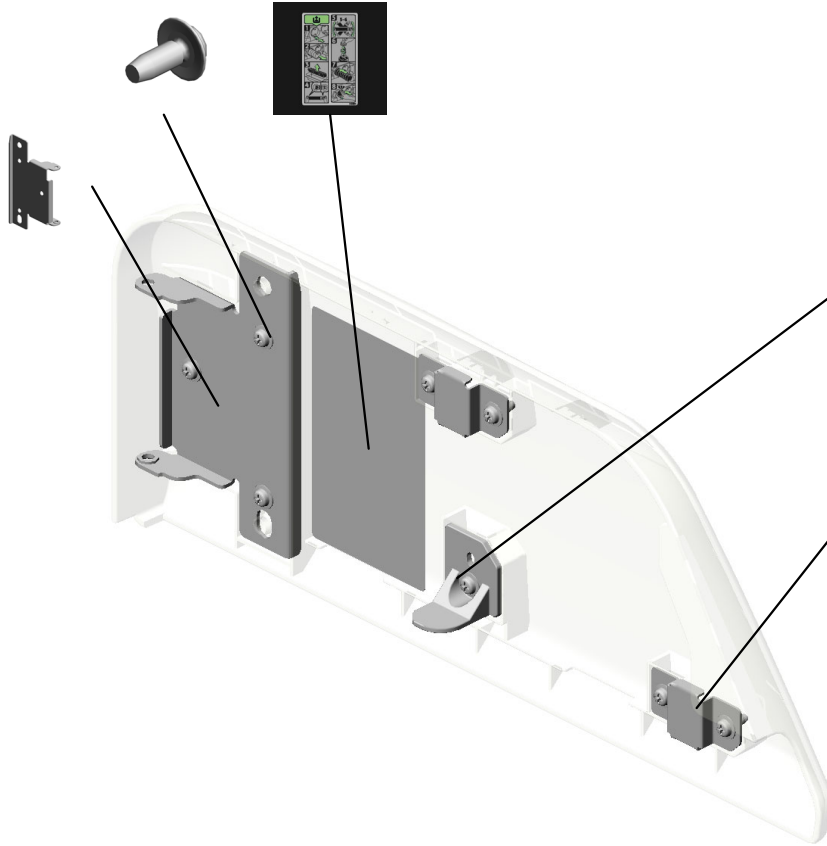

86.D3551333
SHIELDING PLATE:SAFETY SWITCH:DOOR

34.D1791457 (x2)
MAGNET CATCH PLATE:DOOR:TONER SUPPLY

U001_S003

SUPPORTING PLATE:DOOR:FRONT RIGHT:ASS'Y

62.D1796914
SEAL:INNER COVE
R:DEVELOPMENT:
COOLING

99.D2701584
DECAL:MISFEED R
EMOVAL:LOCATIO
N
202001-02 O/O

61.D1796913
SEAL:INNER COVE
R:OPTICAL WRITIN
G MD:COOLING



96.D0BX1506

[A]
SUPPORTING PLA
TE:DOOR:FRONT
RIGHT:ASS'Y
201808-03 O/O

100.D2701591
DECAL:MISFEED R
EMOVAL:ABC
202001-03 O/O

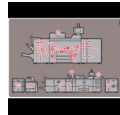
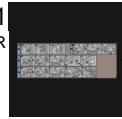

67.D2701509
BRACKET:SUPPO
RTING PLATE:DOO
R:FRONT RIGHT



1.03540080N
(x12)
SCREW:M4X8



48.D1791505
STOPPER:GUIDE P
LATE:VERTICAL T
RANSPORT



D1791506
[A]
SUPPORTING PLA
TE:DOOR:FRONT
RIGHT:ASS'Y
201808-03 O/O

U001	U002	U003	U004	U005	U006	U007	U008	U009	U010	U011	U012	U013	U014	U015	U016	U017	U018	U019	U020	U021
------	------	------	------	------	------	------	------	------	------	------	------	------	------	------	------	------	------	------	------	------

U001_S004
SUPPORTING PLATE:DOOR:FRONT LEFT:ASS'Y

88.D7414595
DECAL:PAPER EXI
T SUB-UNIT:MISFE
ED REMOVAL



44.D1791490
BRACKET:SUPPO
RTING PLATE:DOO
R:FRONT LEFT

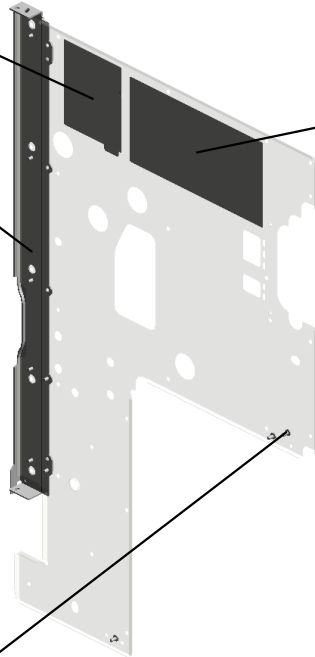

85.D2701592
DECAL:MISFEED R
EMOVAL:DEZ:ABS

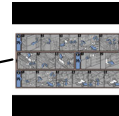

1.03540080N
(x10)
SCREW:M4X8

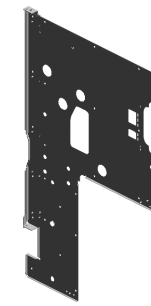

97.D0BX1488
[A]
SUPPORTING PLA
TE:DOOR:FRONT L
EFT:ASS'Y
201809-01 O/O

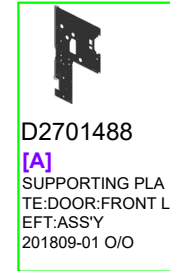

D2701488
[A]
SUPPORTING PLA
TE:DOOR:FRONT L
EFT:ASS'Y
201809-01 O/O

U001_S005
COVER:MAIN:REAR:SUB-ASS'Y

102.D0BX1516
COVER:MAIN:REA
R:PEEN
202011-01 X/O

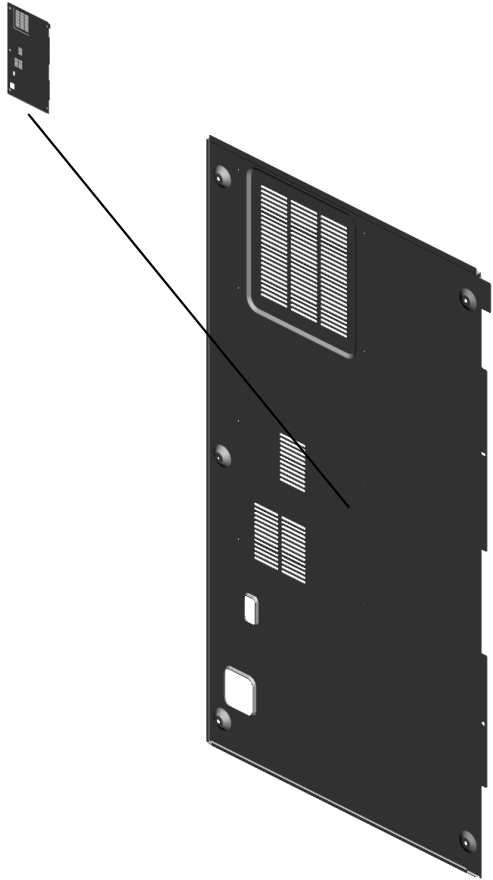

101.D0BX1427
COVER:MAIN:REA
R:SUB-ASS'Y
202011-02

U001	U002	U003	U004	U005	U006	U007	U008	U009	U010	U011	U012	U013	U014	U015	U016	U017	U018	U019	U020	U021
------	------	------	------	------	------	------	------	------	------	------	------	------	------	------	------	------	------	------	------	------

U001_S006
INNER COVER:INTERMEDIATE TRANSFER:ASS'Y

74.D2701546
DECAL:PULL OUT:
MIDDLE:ABS

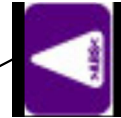
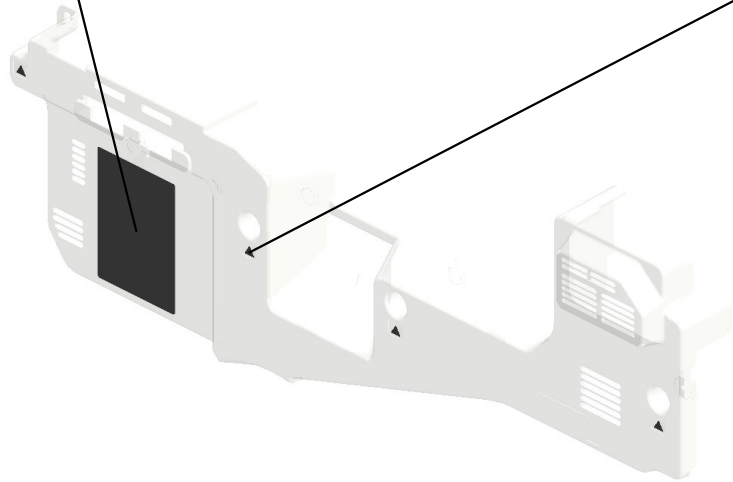

80.D2701568
(x4)
DECAL:POSITIONI
NG DISPLAY:TCRU
:ABS

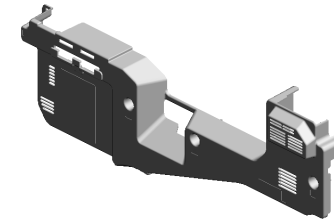

98.D0BX1550
[A]
INNER COVER:INT
ERMEDIATE TRAN
SFER:ASS'Y
201812-07 O/O

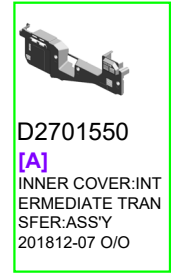

D2701550
[A]
INNER COVER:INT
ERMEDIATE TRAN
SFER:ASS'Y
201812-07 O/O

U002.OPERATION

U002 S001
D2707230
(NA):OPERATION PANEL:AS
S'Y

U002 S002
D2707232
(CHN/EU,AA,TWN,KOR):OPE
RATION PANEL:ASS'Y

U002 S003
D2707231
(CHN/EU,AA,TWN,KOR):OPE
RATION PANEL:ASS'Y

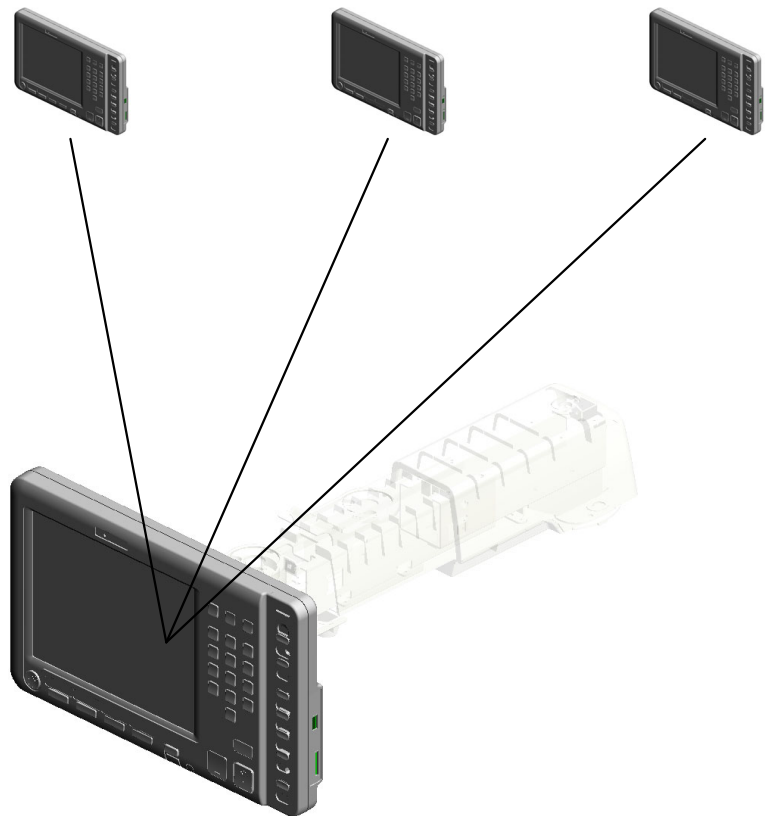

U002_S001.(NA):OPERATION PANEL:ASS'Y

U002 S001 S001
D1797302
(NA):COVER:FRONT:ASS'Y



U001	U002	U003	U004	U005	U006	U007	U008	U009	U010	U011	U012	U013	U014	U015	U016	U017	U018	U019	U020	U021
------	-------------	------	------	------	------	------	------	------	------	------	------	------	------	------	------	------	------	------	------	------

U002_S002.(CHN/EU,AA,TWN,KOR):OPERATION PANEL:ASS'Y

U002 S002 S001
D1797304
(CHN/EU,AA,TWN,KOR):COV
ER:FRONT:ASS'Y



U001	U002	U003	U004	U005	U006	U007	U008	U009	U010	U011	U012	U013	U014	U015	U016	U017	U018	U019	U020	U021
------	-------------	------	------	------	------	------	------	------	------	------	------	------	------	------	------	------	------	------	------	------

U002_S003.(CHN/EU,AA,TWN,KOR):OPERATION PANEL:ASS'Y

U002 S003 S001
D1797304
(CHN/EU,AA,TWN,KOR):COV
ER:FRONT:ASS'Y



U001	U002	U003	U004	U005	U006	U007	U008	U009	U010	U011	U012	U013	U014	U015	U016	U017	U018	U019	U020	U021
------	-------------	------	------	------	------	------	------	------	------	------	------	------	------	------	------	------	------	------	------	------

U002 OPERATION

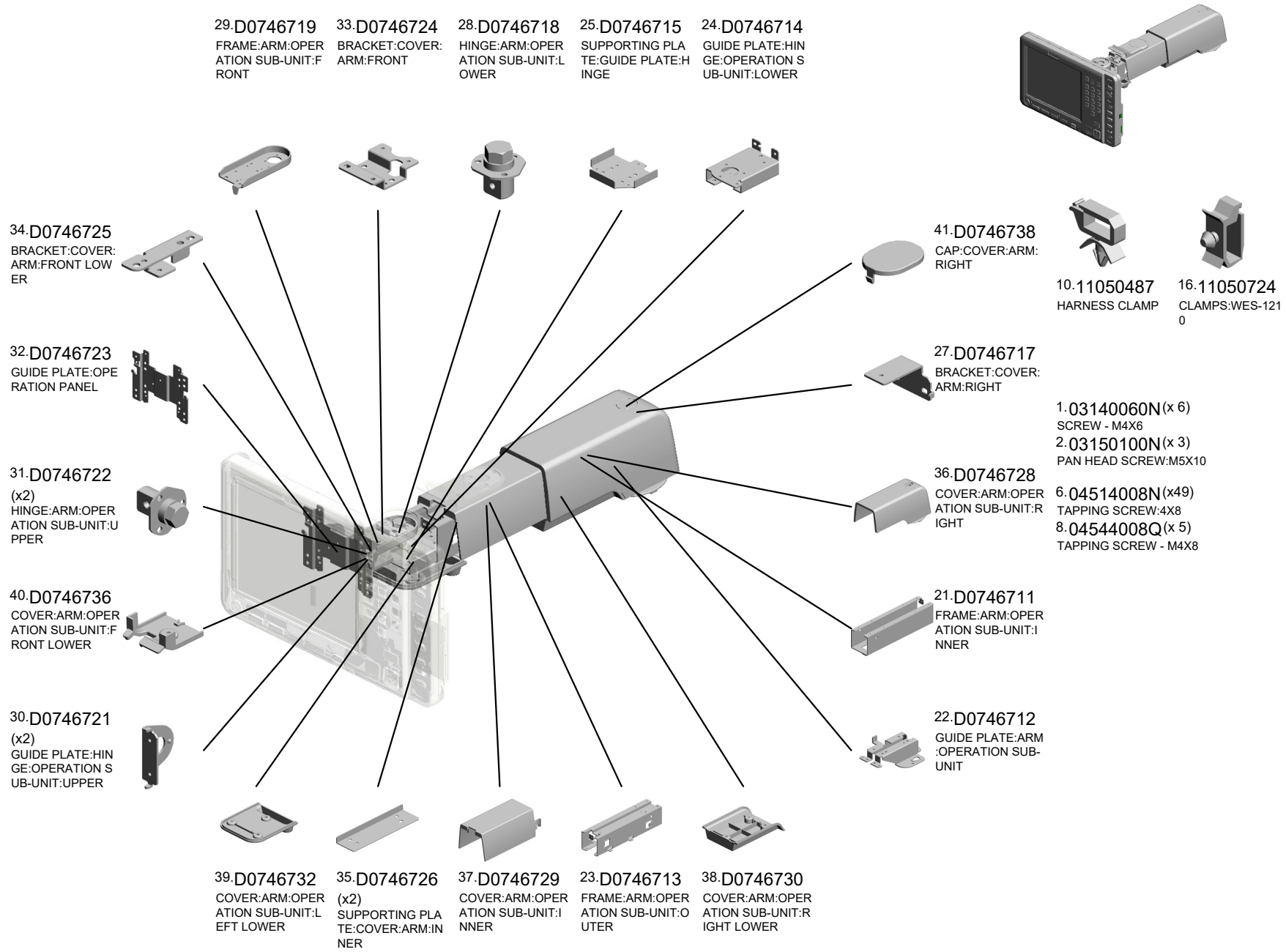

U002 OPERATION

46.D1797220 74.D0BX1594
COVER:ARM:OPERATION SUB-UNIT:FRONT
HOLDER:HINGE:OPERATION SUB-UNIT:LOWER
201902-01 O/O



42.D0746739
HOLDER:HINGE:OPERATION SUB-UNIT:UPPER



62.D1946737
CAP:COVER:ARM:FRONT



47.D1797233
COVER:ARM:OPERATION SUB-UNIT:FRONT

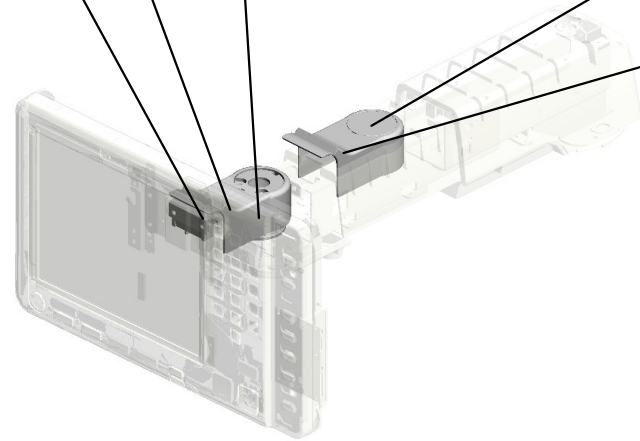
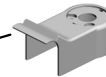

U002_S001
(NA):OPERATION PANEL:ASS'Y

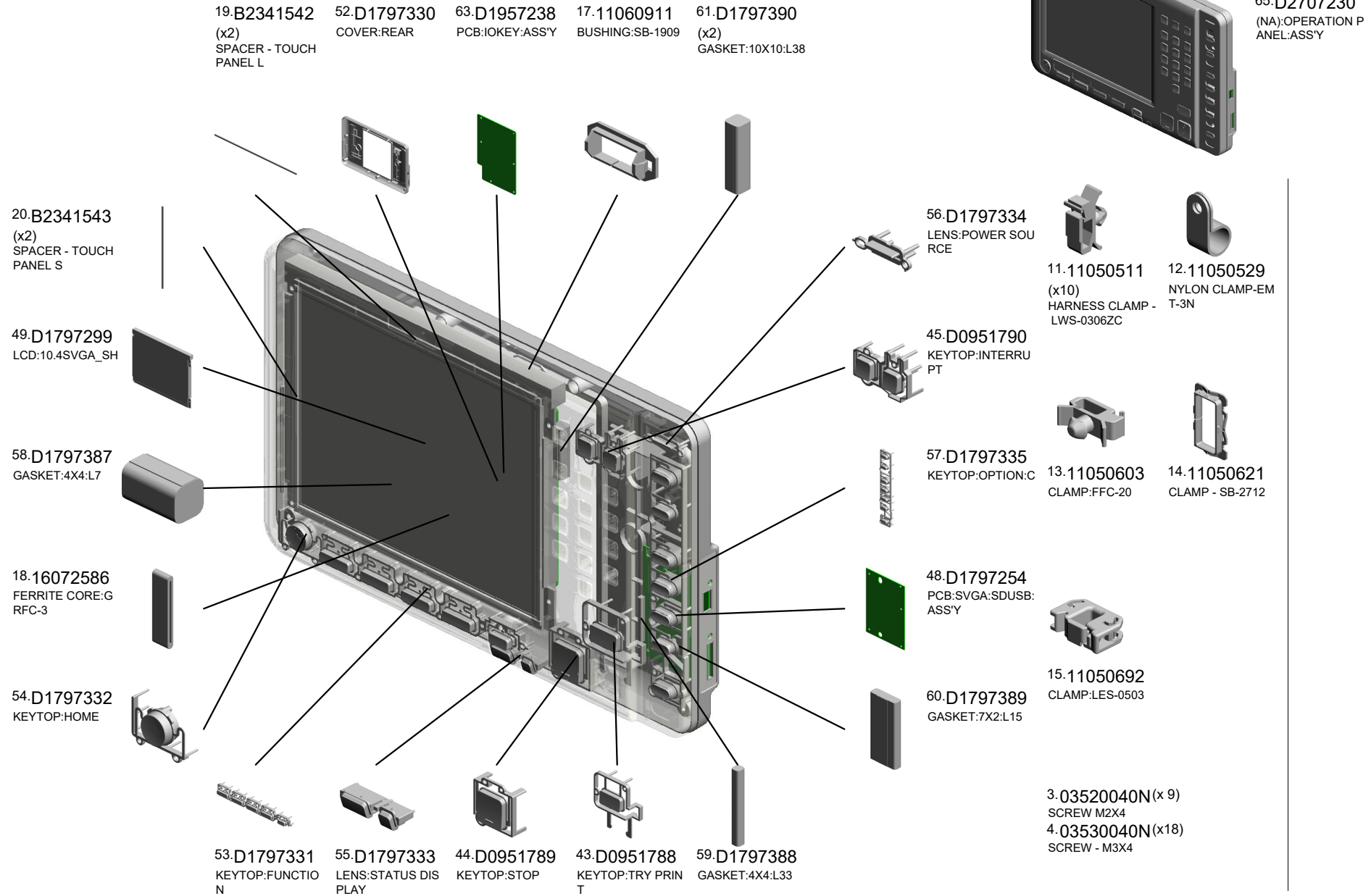

U002_S001
 (NA):OPERATION PANEL:ASS'Y

73.M0771800 TOUCH PANEL:10.4INCH
 68.D2707250 PCB:LCDCAR2FT:ASS'Y
 72.M0771769 KEYTOP:RESET SWITCH



65.D2707230
 (NA):OPERATION PANEL:ASS'Y

69.M0771766
 KNOB:VARIABLE RESISTOR

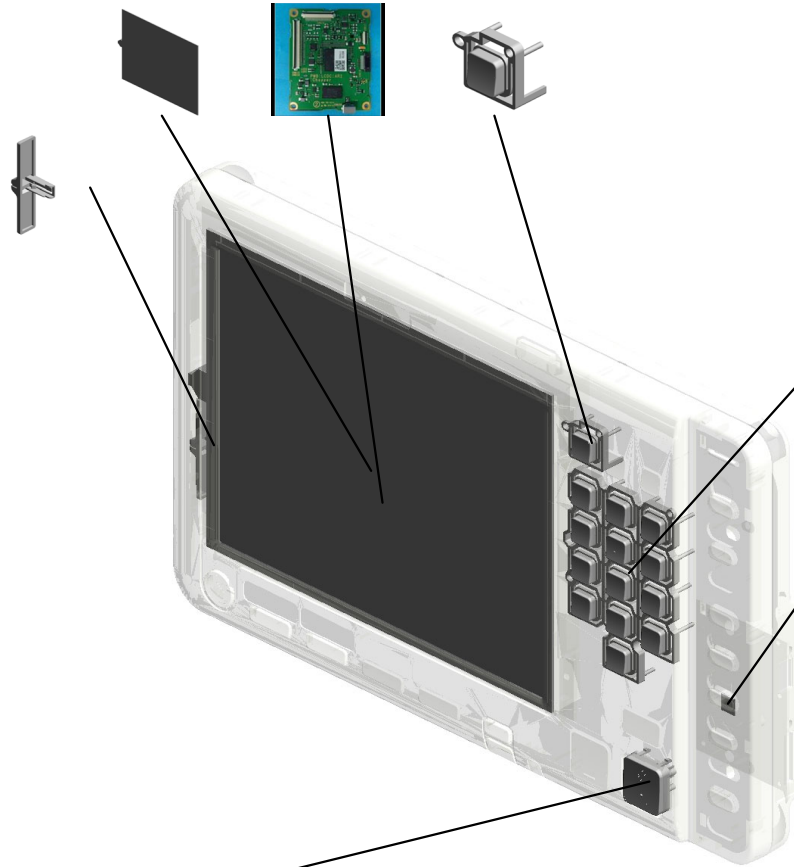

70.M0771767
 KEYTOP:START

71.M0771768
 KEYTOP:10KEY

64.D1957245
 ABSORPTION SHEET:LCD

5.04503010N(x36)
 TAPPING SCREW - M3X10

7.04523010P(x 4)
 BINDING SELF-TAPPING SCREW:3X10

9.09544008N(x 3)
 SCREW - M4X8

U002_S001_S001
(NA):COVER:FRONT:ASS'Y



50.D1797302
(NA):COVER:FRON
T:ASS'Y

5.04503010N(x 2)
TAPPING SCREW - M3X10

U001	U002	U003	U004	U005	U006	U007	U008	U009	U010	U011	U012	U013	U014	U015	U016	U017	U018	U019	U020	U021
------	------	------	------	------	------	------	------	------	------	------	------	------	------	------	------	------	------	------	------	------

U002_S002
 (CHN/EU,AA,TWN,KOR):OPERATION PANEL:ASS'Y



67.D2707232
 (CHN/EU,AA,TWN,
 KOR):OPERATION
 PANEL:ASS'Y

- 19.B2341542 (x2) SPACER - TOUCH PANEL L
- 49.D1797299 LCD:10.4SVGA_SH
- 52.D1797330 COVER:REAR
- 17.11060911 BUSHING:SB-1909
- 61.D1797390 (x2) GASKET:10X10:L38

20.B2341543 (x2) SPACER - TOUCH PANEL S

58.D1797387 GASKET:4X4:L7

14.11050621 CLAMP - SB-2712

54.D1797332 KEYTOP:HOME

53.D1797331 KEYTOP:FUNCTION

55.D1797333 LENS:STATUS DISPLAY

44.D0951789 KEYTOP:STOP

18.16072586 FERRITE CORE:GRFC-3

43.D0951788 KEYTOP:TRY PRINT

59.D1797388 GASKET:4X4:L33

56.D1797334 LENS:POWER SOURCE

45.D0951790 KEYTOP:INTERRUPT

57.D1797335 KEYTOP:OPTION:C

48.D1797254 PCB:SVGA:SDUSB:ASS'Y

60.D1797389 GASKET:7X2:L15



11.11050511 (x10) HARNESS CLAMP - LWS-0306ZC



12.11050529 NYLON CLAMP-EM T-3N



13.11050603 CLAMP:FFC-20



15.11050692 CLAMP:LES-0503

3.03520040N(x 9) SCREW M2X4

4.03530040N(x18) SCREW - M3X4

5.04503010N(x36) TAPPING SCREW - M3X10

7.04523010P(x 4) BINDING SELF-TAPPING SCREW:3X10

9.09544008N(x 3) SCREW - M4X8

U002_S002
 (CHN/EU,AA,TWN,KOR):OPERATION PANEL:ASS'Y

73.M0771800 63.D1957238
 TOUCH PANEL:10. PCB:IOKEY:ASS'Y
 4INCH



67.D2707232
 (CHN/EU,AA,TWN,
 KOR):OPERATION
 PANEL:ASS'Y

69.M0771766
 KNOB:VARIABLE R
 ESISTOR



68.D2707250
 PCB:LCD CAR2FT:AS
 SS'Y

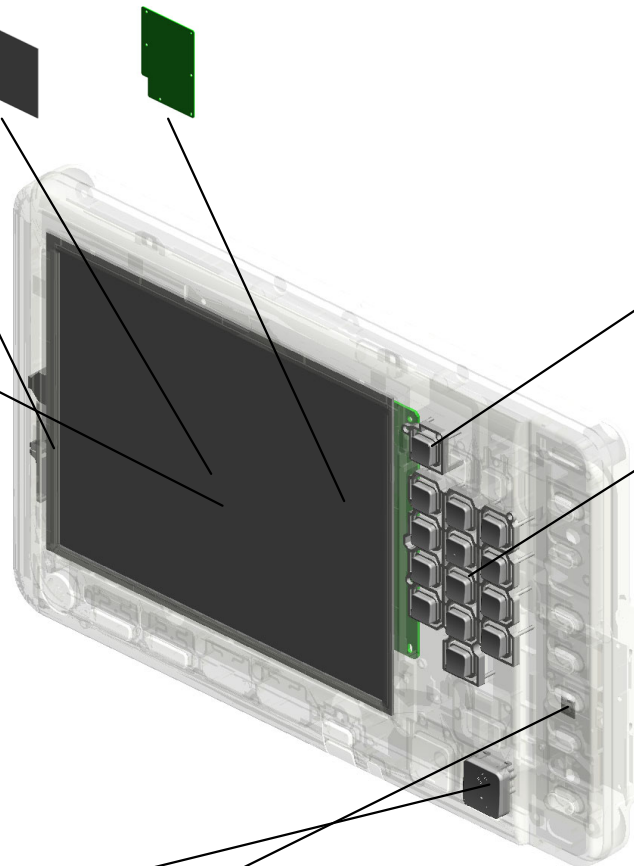

72.M0771769
 KEYTOP:RESET S
 WITCH



71.M0771768
 KEYTOP:10KEY



70.M0771767
 KEYTOP:START



64.D1957245
 ABSORPTION SHE
 ET:LCD



U002_S002_S001
(CHN/EU,AA,TWN,KOR):COVER:FRONT:ASS'Y



51.D1797304
(CHN/EU,AA,TWN,
KOR):COVER:FRO
NT:ASS'Y

5.04503010N(x 2)
TAPPING SCREW - M3X10

U001	U002	U003	U004	U005	U006	U007	U008	U009	U010	U011	U012	U013	U014	U015	U016	U017	U018	U019	U020	U021
------	------	------	------	------	------	------	------	------	------	------	------	------	------	------	------	------	------	------	------	------

U002_S003
(CHN/EU,AA,TWN,KOR):OPERATION PANEL:ASS'Y

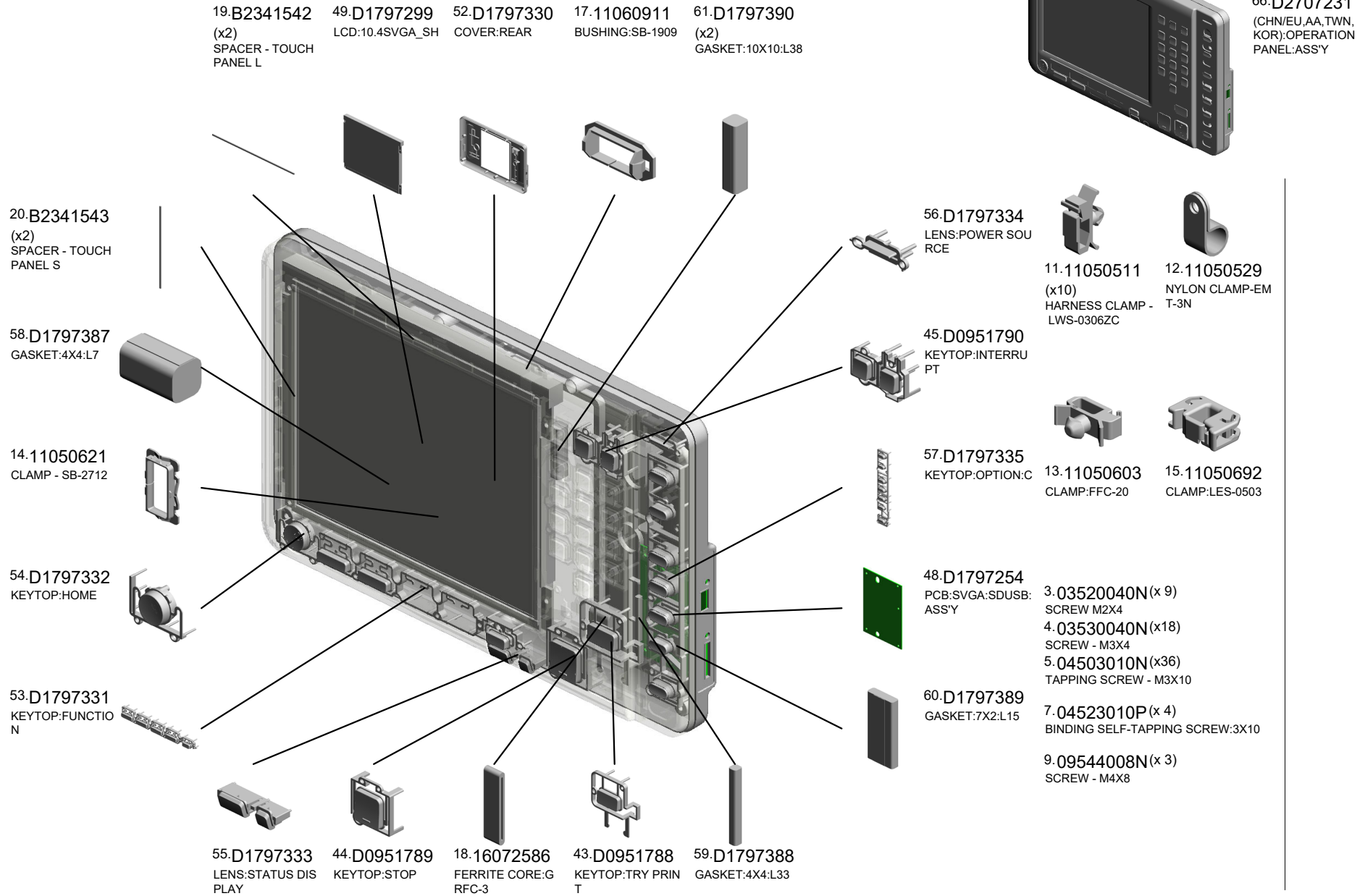

U002_S003
 (CHN/EU,AA,TWN,KOR):OPERATION PANEL:ASS'Y

73.M0771800 63.D1957238
 TOUCH PANEL:10. PCB:IOKEY:ASS'Y
 4INCH



66.D2707231
 (CHN/EU,AA,TWN,
 KOR):OPERATION
 PANEL:ASS'Y

69.M0771766
 KNOB:VARIABLE R
 ESISTOR



68.D2707250
 PCB:LCD CAR2FT: A
 SS'Y

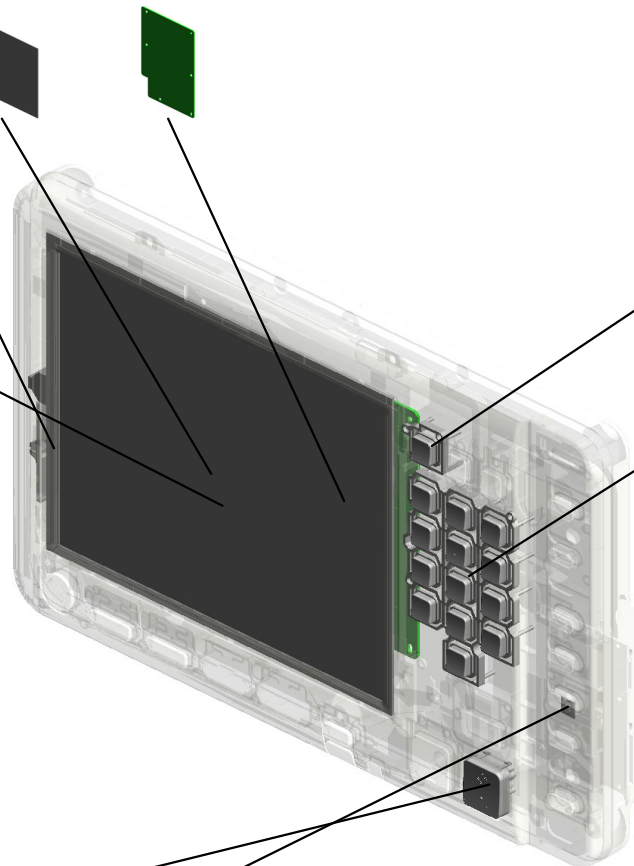

72.M0771769
 KEYTOP:RESET S
 WITCH



71.M0771768
 KEYTOP:10KEY



70.M0771767
 KEYTOP:START



64.D1957245
 ABSORPTION SHE
 ET:LCD



U002_S003_S001
(CHN/EU,AA,TWN,KOR):COVER:FRONT:ASS'Y



51.D1797304
(CHN/EU,AA,TWN,
KOR):COVER:FRO
NT:ASS'Y

5.04503010N(x 2)
TAPPING SCREW - M3X10

U001	U002	U003	U004	U005	U006	U007	U008	U009	U010	U011	U012	U013	U014	U015	U016	U017	U018	U019	U020	U021
------	------	------	------	------	------	------	------	------	------	------	------	------	------	------	------	------	------	------	------	------

U003.ADF

U003 S001
D1941202
ADF:SINAI-B:ASS'Y

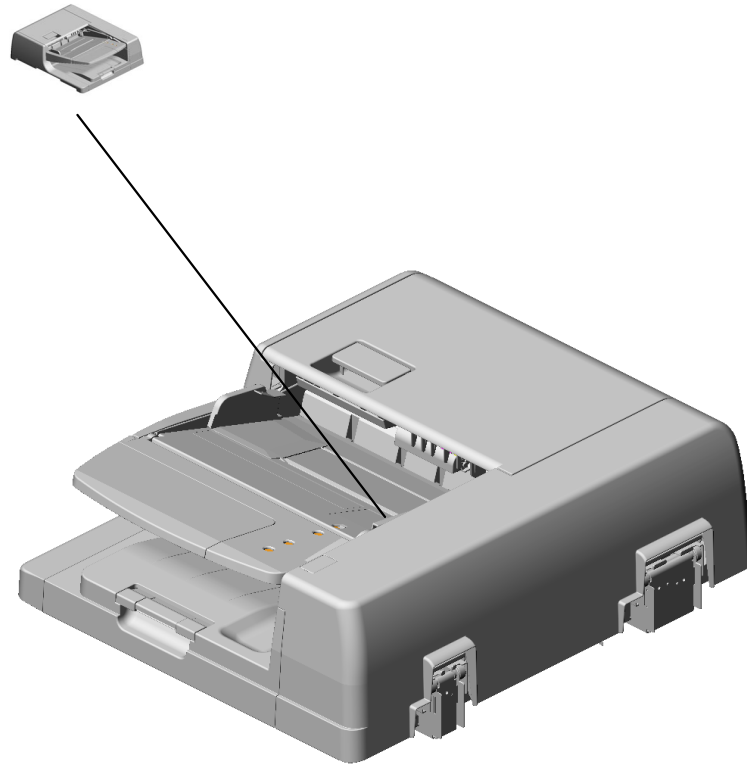

U001	U002	U003	U004	U005	U006	U007	U008	U009	U010	U011	U012	U013	U014	U015	U016	U017	U018	U019	U020	U021
------	------	------	------	------	------	------	------	------	------	------	------	------	------	------	------	------	------	------	------	------

U003_S001.ADF:SINAI-B:ASS'Y

U003 S001 S007
D7312202
SHAFT:SEPARATION:ASS'Y

U003 S001 S004
D6831680
CAM:PICKUP

U003 S001 S001
D6831620
SHAFT:SEPARATION:DRIVE:
INPUT:SUB-ASS'Y

U003 S001 S006
D6832210
ROLLER:MIDDLE:DRIVE

U003 S001 S003
D6831640
SHAFT:INPUT:PAPER FEED:
SUB-ASS'Y

U003 S001 S005
D6832110
ROLLER:PULL OUT:DRIVE

U003 S001 S002
D6831632
SHAFT:REVERSE ROLLER:S
UB-ASS'Y

U003 S001 S010
D6833150
ROLLER:SCANNING:EXIT:DR
IVE:ASS'Y

U003 S001 S008
AX040254
DC MOTOR:RISING TRAY:AS
S'Y:1.007W:BRUSH

U003 S001 S011
D6830361
GUIDE:EXIT:LOWER:ASS'Y

U003 S001 S012
D6833710
ROLLER:CONTACT IMAGE S
ENSOR:EXIT:DRIVE:PRESS
FIT

U003 S001 S009
D3B03810
GUIDE PLATE:EXIT:UPPER:A
SS'Y

U001	U002	U003	U004	U005	U006	U007	U008	U009	U010	U011	U012	U013	U014	U015	U016	U017	U018	U019	U020	U021
------	------	------	------	------	------	------	------	------	------	------	------	------	------	------	------	------	------	------	------	------

U003_S001.ADF:SINAI-B:ASS'Y

U003 S001 S015
D7314370
COVER:PAPER FEED:ASS'Y

U003 S001 S013
D6833411
GUIDE:SCANNING:ENTRANC
E:LOWER:SUB-ASS'Y

U003 S001 S016
D7314510
COVER:LOWER:ASS'Y

U003 S001 S014
D3B04730
PRESSURE PLATE:ASS'Y

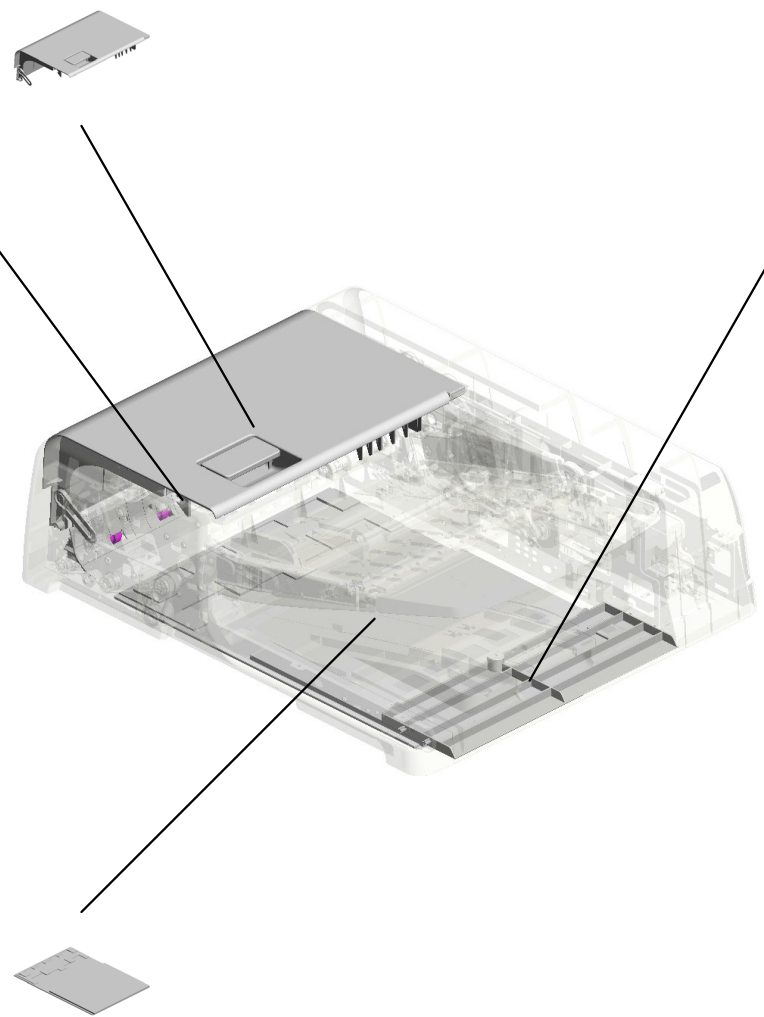

U001	U002	U003	U004	U005	U006	U007	U008	U009	U010	U011	U012	U013	U014	U015	U016	U017	U018	U019	U020	U021
------	------	------	------	------	------	------	------	------	------	------	------	------	------	------	------	------	------	------	------	------

U003_S001_S007.SHAFT:SEPARATION:ASS'Y

U003 S001 S007 S001
D6832240
GUIDE:PAPER FEED:ENTRA
NCE:INNER BACK:ASS'Y

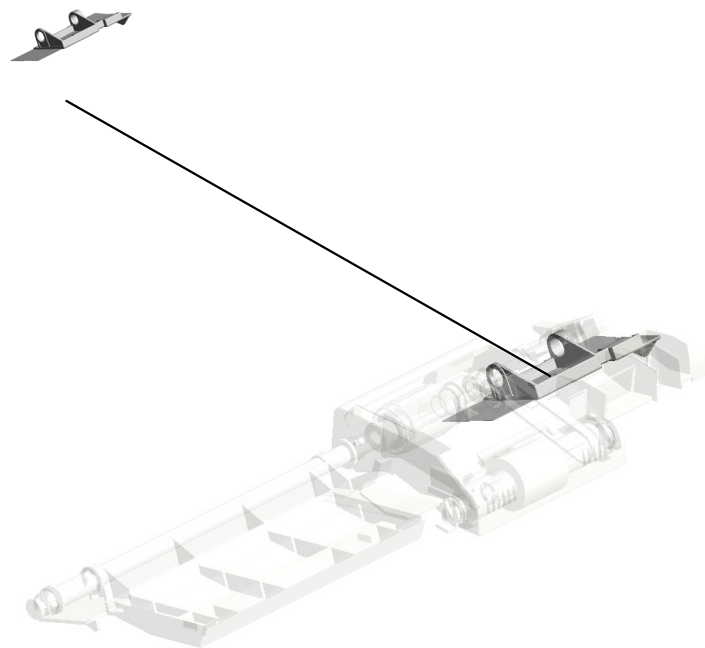

U001	U002	U003	U004	U005	U006	U007	U008	U009	U010	U011	U012	U013	U014	U015	U016	U017	U018	U019	U020	U021
------	------	------	------	------	------	------	------	------	------	------	------	------	------	------	------	------	------	------	------	------

U003_S001_S011.GUIDE:EXIT:LOWER:ASS'Y

U003 S001 S011 S001
D5433631
ROLLER:SCANNING:BEHIND
:ASSY

U003 S001 S011 S003
D6833662
GUIDE PLATE:CONTACT IMA
GE SENSOR:ENTRANCE:AS
S'Y

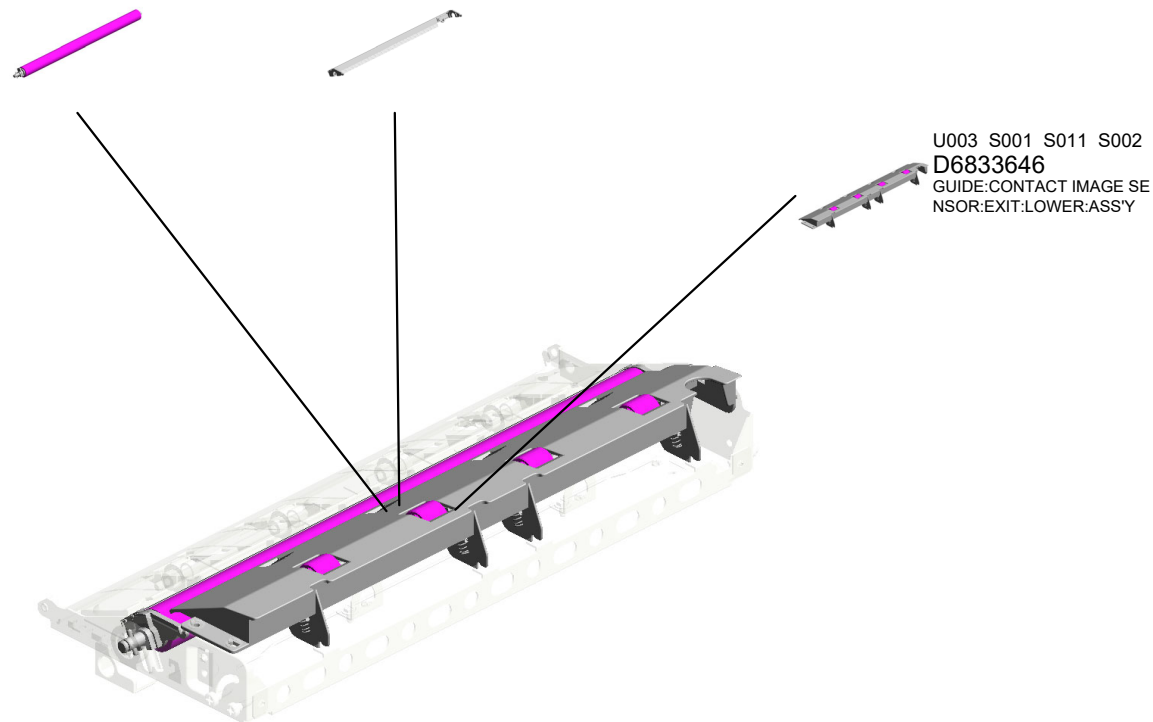

U001	U002	U003	U004	U005	U006	U007	U008	U009	U010	U011	U012	U013	U014	U015	U016	U017	U018	U019	U020	U021
------	------	------	------	------	------	------	------	------	------	------	------	------	------	------	------	------	------	------	------	------

U003
ADF

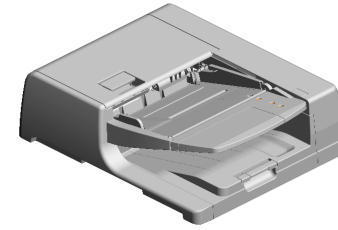

41.A8597211
(x2)
STEPPED SCREW

3.04514008N(x 2)
TAPPING SCREW:4X8
20.09514010N(x 2)
SCREW:POLISHED ROUND:M4X10

U003_S001
ADF:SINAI-B:ASS'Y

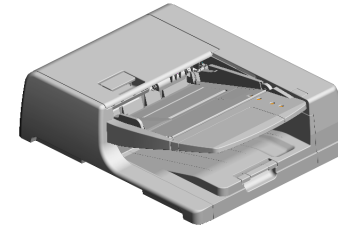

296.D1941202
[A]
ADF:SINAI-B:ASS'Y
202302-01 O/O

- 21.11050487 (x2) HARNESS CLAMP
- 22.11050508 (x9) HARNESS CLAMP - LWS-0711
- 16.08025299 TAPPING SCREW - M3X8
- 1.03530060N (x2) BIND SCREW - M3 X6
- 12.07200040E (x3) RETAINING RING - M4

7.04543006N (x8) TAPPING SCREW: ROUND POINT:3X6

23.11050551 CLAMP:LES-0505

17.08050103 (x2) RETAINING RINGS -E:SILENCER:DIA3

15.07433808 (x3) RADIAL BALL BEA RING:DIA8XDIA16X5

19.08050106 (x6) RETAINING RINGS -E:SILENCER:DIA6

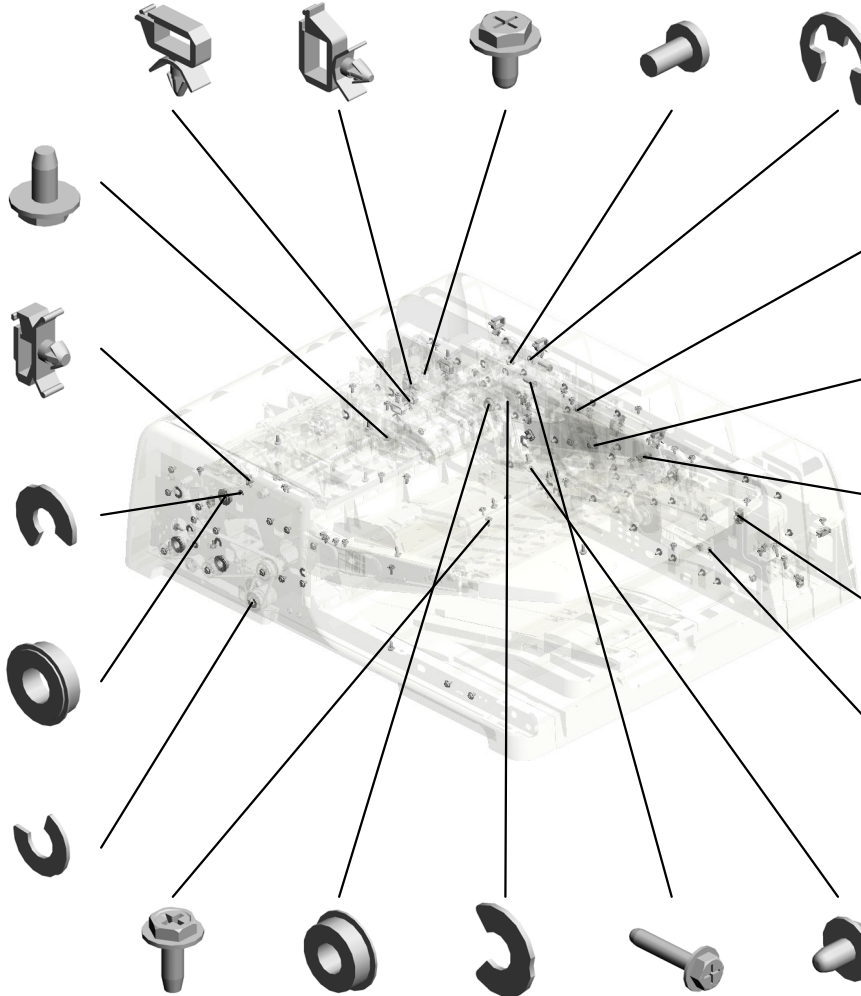

- 10.04583008N (x21) HEXAGON HEAD TAPPING SCREW:3 X8
- 14.07433806 RADIAL BALL BEA RING:DIA6XDIA13X5
- 18.08050104 (x9) RETAINING RINGS -E:SILENCER:DIA4
- 9.04543014Q (x4) TAPPING SCREW: 3X14
- 6.04543005N (x2) HEXAGON HEAD TAPPING SCREW:ROUND POINT:3X5

24.11050692 (x5) CLAMP:LES-0503

8.04543006Q (x103) TAPPING SCREW - M3X6

25.11050723 (x2) CLAMPS:WES-0507

26.11050724 CLAMPS:WES-1210

11.07200030E RETAINING RING - M3

18.08050104 (x2) RETAINING RINGS -E:SILENCER:DIA4

22.11050508 HARNESS CLAMP - LWS-0711

27.11050758 (x6) CLAMP:LWSM-0306A

30.16072256 FERRITE CORE:K3 NFR-08-ABK0

88.B8301135 SCREW

102.D5224906 (x2) STEPPED SCREW: M3:DIA6:1.7MM:ROUND POINT

271.11050760 CLAMP:LWSM-0511A

U003_S001
ADF:SINAI-B:ASS'Y

- 35.A4221063 SEAL - 0.7X13X20
- 33.54472681 SNAP RING
- 36.A5482139 PULLEY
- 27.11050758 (x13) CLAMP:LWSM-030 6A
- 57.AA082101 (x6) BUSHING - 6X10X6

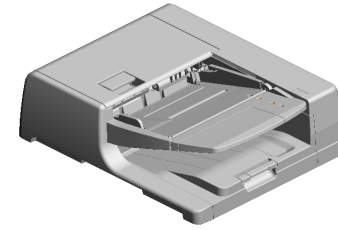

296.D1941202
[A]
ADF:SINAI-B:ASS'Y
202302-01 O/O

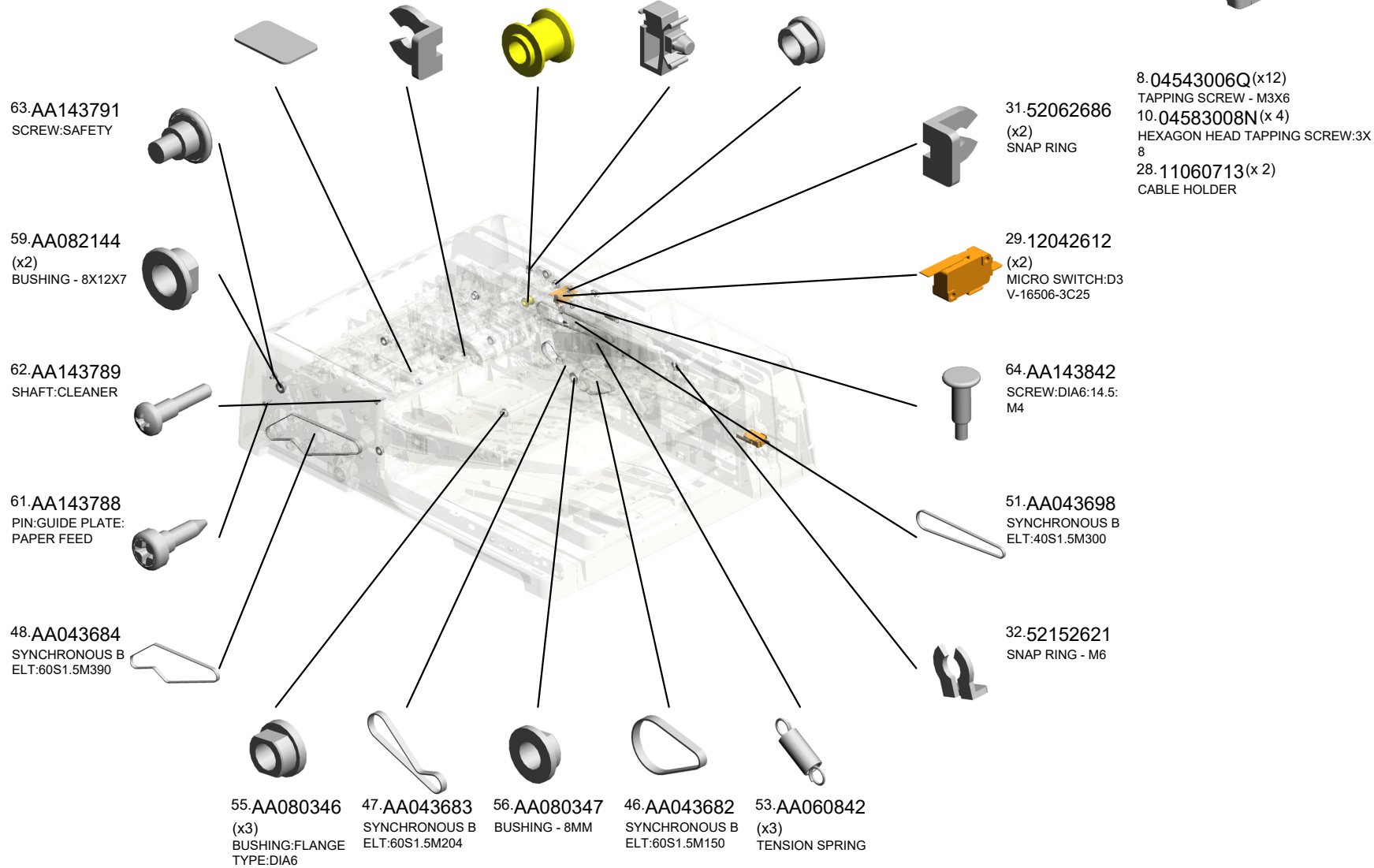

U003_S001
ADF:SINAI-B:ASS'Y

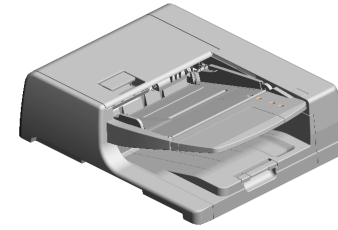

296.D1941202
[A]
ADF:SINAI-B:ASS'Y
202302-01 O/O

71.B0434645 (x4) SPRING - 2N
101.D4123145 TENSION SPRING: LEVER:MISFEED R EMOVAL
91.D3AZ1762 BRACKET:MOTOR: MIDDLE
105.D5431625 GEAR:Z24:SEPARA TION
104.D5431313 COMPRESSION SP RING:HINGE:LEFT

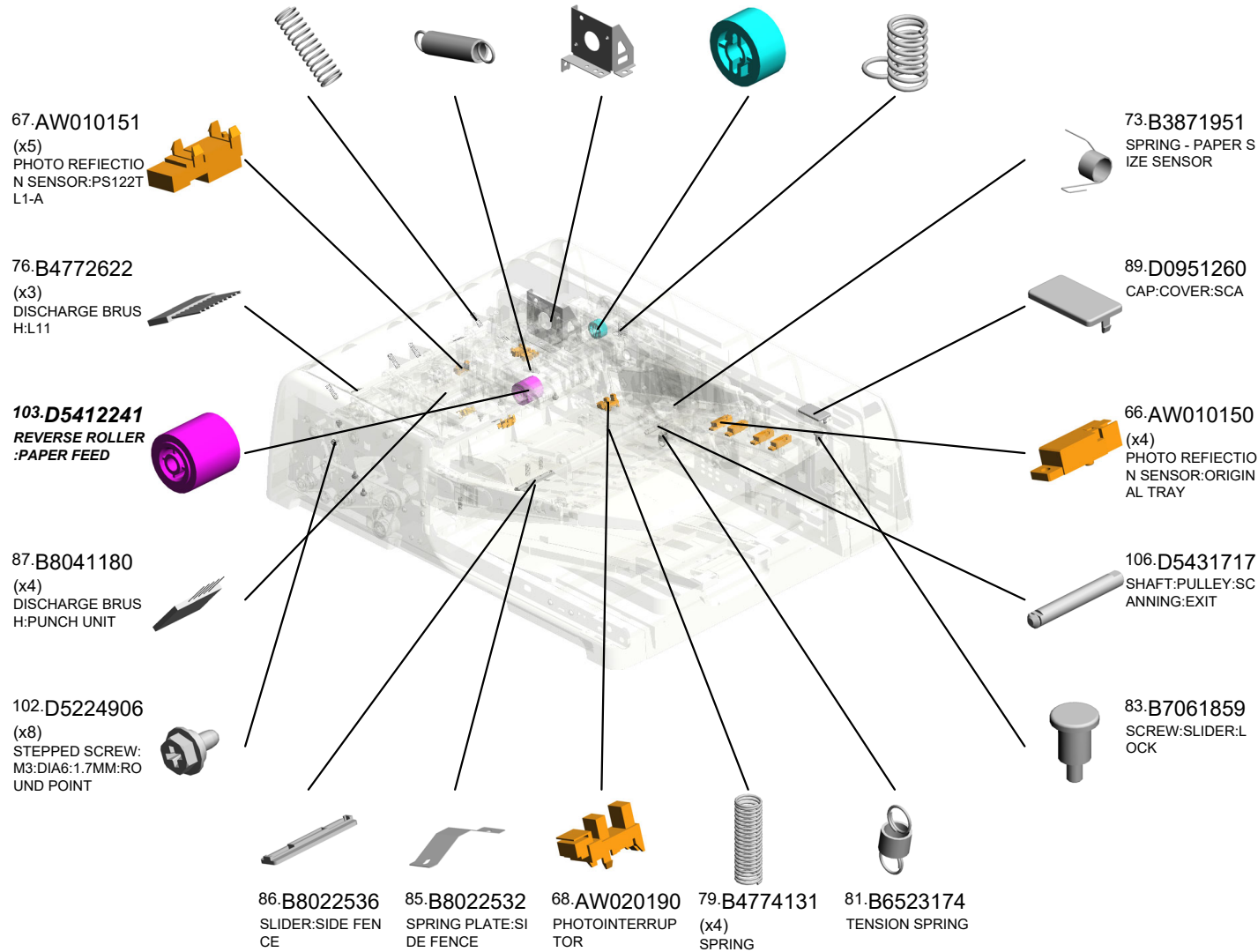

U003_S001
ADF:SINAI-B:ASS'Y

- 134.D6831642 TIMING PULLEY:IDLER:PULL OUT
- 135.D6831643 GEAR:INPUT:PAPER FEED
- 122.D6831387 TENSION SPRING:ON OFF DETECTOR:PAPER FEED
- 120.D6831385 BRACKET:SAFETY SWITCH:PAPER FEED
- 121.D6831386 SHAFT:CONTACT POINT:ON OFF DETECTOR:PAPER FEED

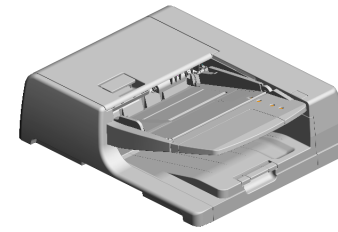

296.D1941202
[A]
ADF:SINAI-B:ASS'Y
202302-01 O/O

112.D5434382
(x2)
COMPRESSION SPRING:PULL OUT

113.D5434393
(x6)
CUSHION:GUIDE PLATE:ENTRANCE:PAPER FEED:INNER BACK

114.D5435125
(x2)
SPRING PLATE:CONTACT IMAGE SENSOR

107.D5431821
TIMING PULLEY:T3/3/24

108.D5431822
FLANGE:DIA24

109.D5433314
(x4)
SHEET:SCANNING:ENTRANCE:MIDDLE

132.D6831635
GEAR:REVERSE ROLLER:DRIVE

129.D6831617
DC MOTOR:ASSY:20W:BRUSHLESS

127.D6831614
BRACKET:MOTOR:PAPER FEED

115.D6421454
FEELER:APS

128.D6831615
STAY:MOTOR:PAPER FEED

119.D6831362
COMPRESSION SPRING:HINGE:RIGHT

124.D6831414
SPRING PLATE:SAFETY SWITCH

123.D6831413
BRACKET:SAFETY SWITCH

125.D6831415
FEELER:SENSOR:ON OFF DETECTOR

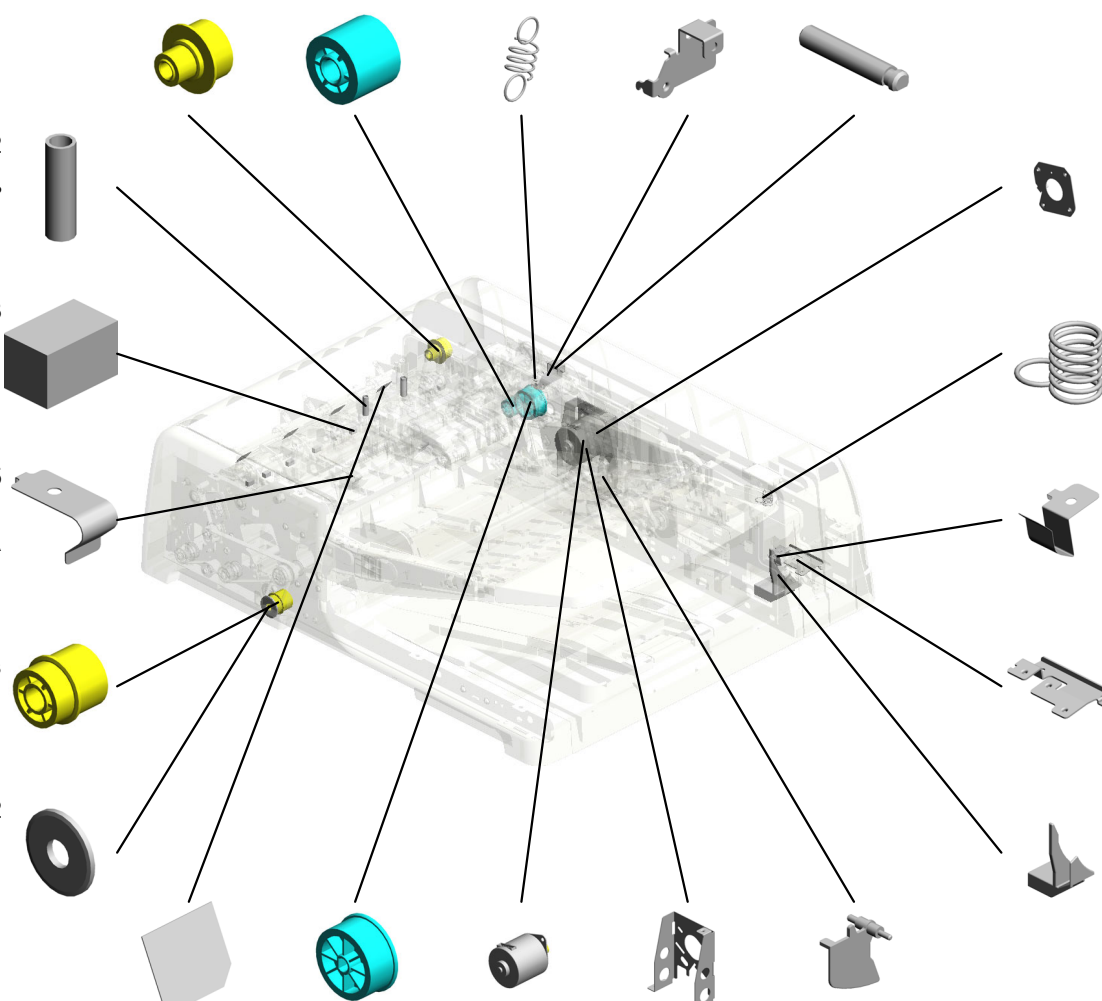

U003_S001
ADF:SINAI-B:ASS'Y

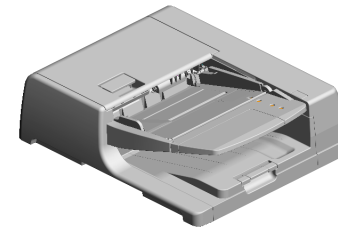

296.D1941202
[A]
ADF:SINAI-B:ASS'Y
202302-01 O/O

156.D6832112 (x2) TIMING PULLEY:ROLLER:PULL OUT:DRIVE
141.D6831691 GEAR:PAPER FEE D:COUPLING
138.D6831675 DC STEPPER MOTOR:DIA42:T15:S2M:ASS'Y
137.D6831671 BRACKET:MOTOR:PICK UP
140.D6831682 TIMING PULLEY:PICKUP:DRIVE

144.D6831766 (x2) DC MOTOR:10W:BRUSHLESS

159.D6832222 STOPPER:SHAFT:SEPARATION:DRIVE

153.D6831856 TENSION SPRING:TENSION:SCANNING:FRONT

151.D6831851 BRACKET:TENSIONER:SCANNING:FRONT

152.D6831855 TIMING PULLEY:TENSIONER:SCANNING:FRONT

150.D6831845 (x2) PULLEY:IDLER:DIA14

149.D6831841 BRACKET:TENSIONER:SCANNING:INNER BACK

146.D6831813 TIMING PULLEY:COUPLING:SCANNING:INNER BACK

145.D6831811 BRACKET:MOTOR:SCANNING:EXIT

147.D6831814 TIMING PULLEY:COUPLING:EXIT

136.D6831644 SPACER:SHAFT:INPUT:PAPER FEED

148.D6831822 (x2) DC MOTOR:20W:SCANNING:20W:BRUSHLESS

142.D6831711 BRACKET:MOTOR:PULL OUT

143.D6831718 (x2) STAY:MOTOR:PULL OUT

154.D6831912 BRACKET:HINGE:RIGHT

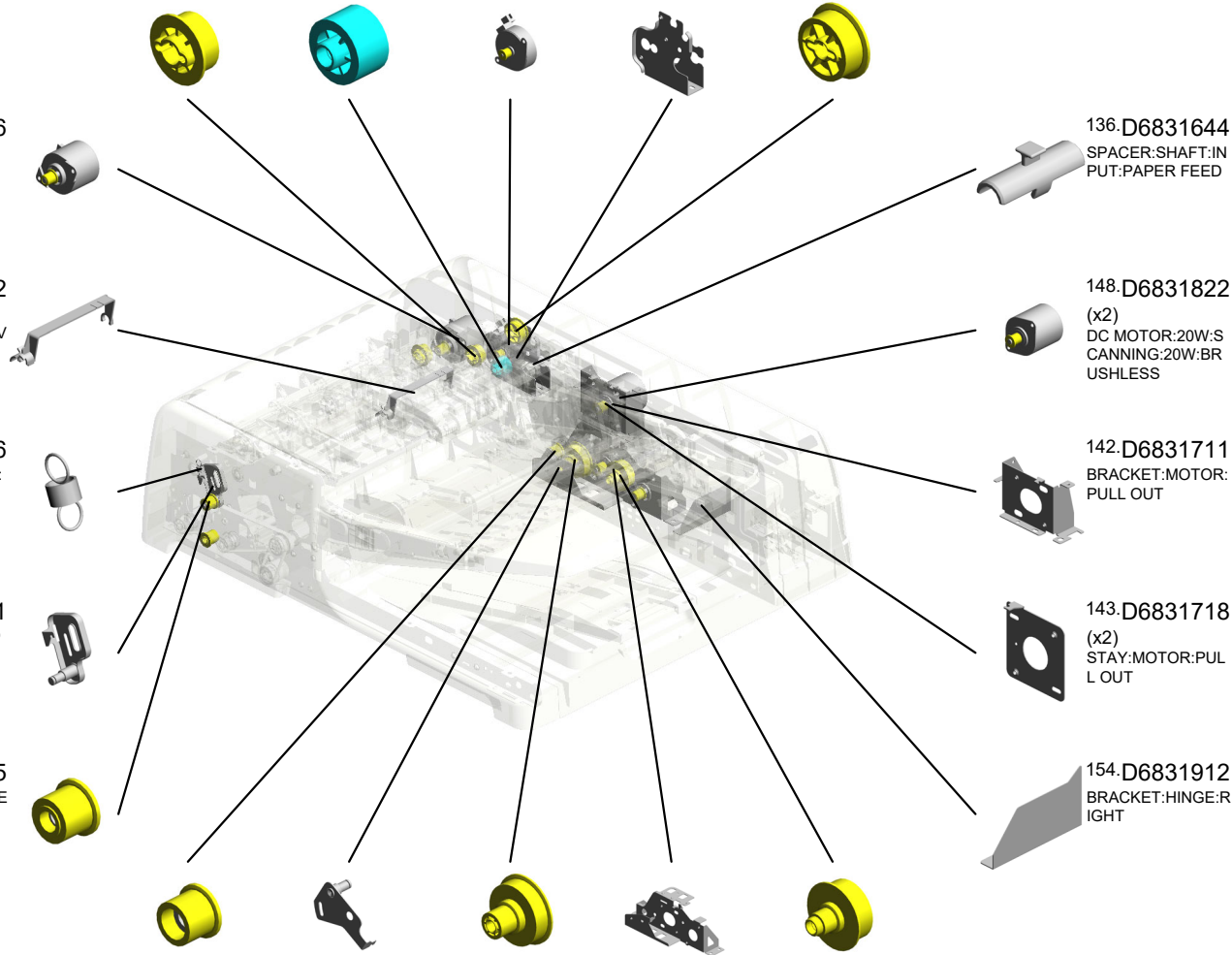

U003_S001
ADF:SINAI-B:ASS'Y

- 174.D6832510 GUIDE PLATE:PAPER FEED:LOWER: ASS'Y
- 191.D6833251 GROUND PLATE:ROLLER
- 186.D6832913 (x2) SHEET:SENSOR:SEPARATION
- 173.D6832417 SHEET:ENTRANCE:SEPARATION PAD
- 171.D6832311 TORQUE LIMITER MECHANICAL CLUTCH:SEPARATOR

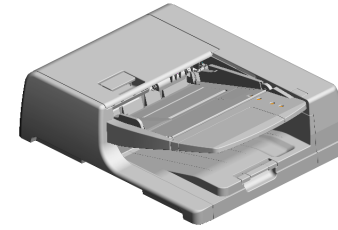

296.D1941202
[A]
ADF:SINAI-B:ASS'Y
202302-01 O/O

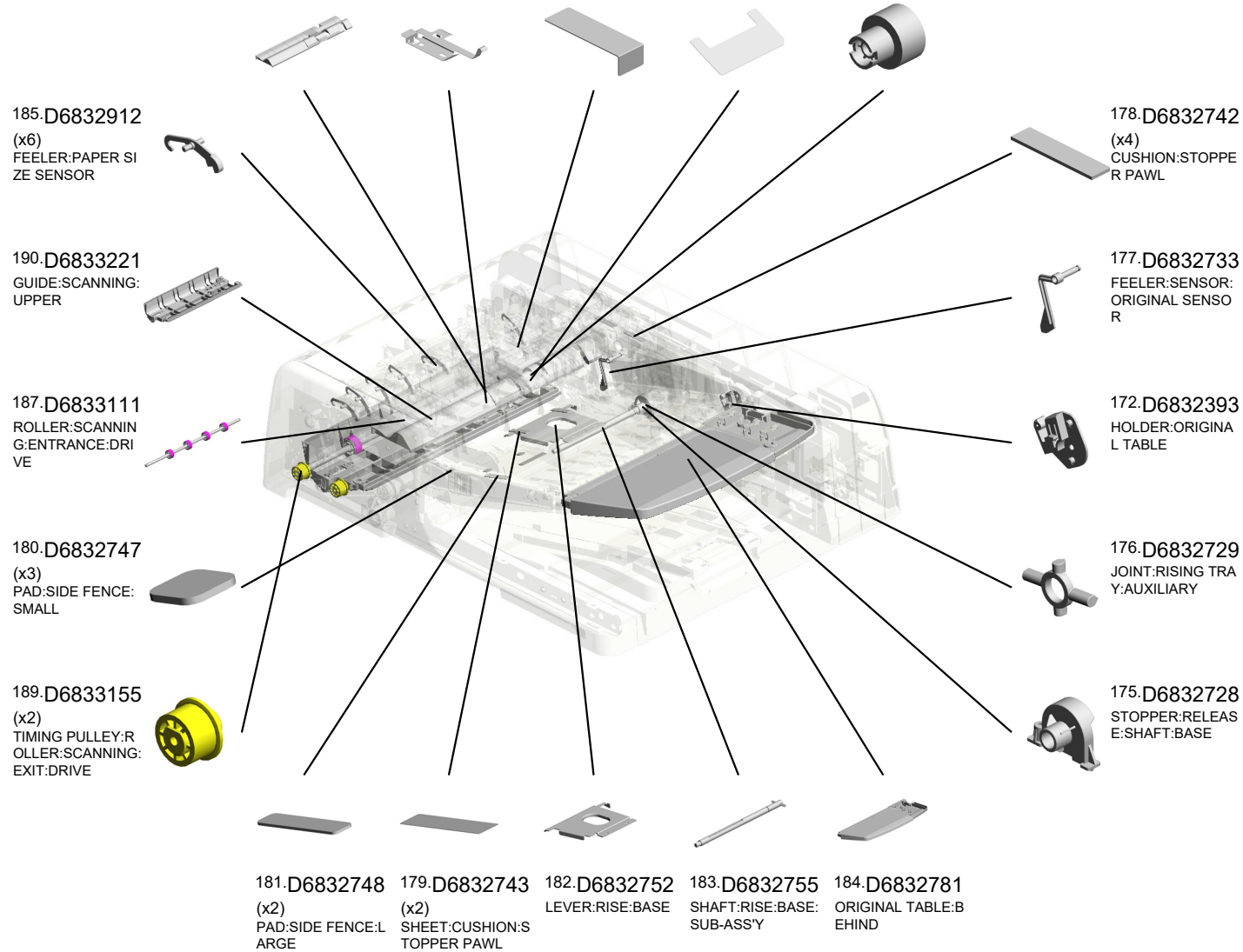

U003_S001
ADF:SINAI-B:ASS'Y

- 205.D6833645 (x2) ROLLER:MIDDLE:DRIVEN
- 220.D6834328 BRACKET:GUIDE:PAPER FEED:INNER BACK
- 225.D6834350 DRIVEN ROLLER:PULL OUT
- 221.D6834341 BRACKET:PULL OUT:DRIVEN
- 224.D6834345 DISCHARGE BRUSH:EXIT:L37

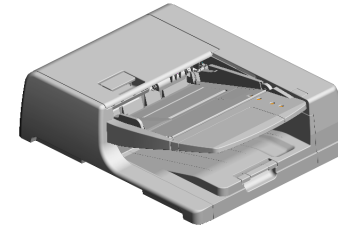

296.D1941202
[A]
ADF:SINAI-B:ASS'Y
202302-01 O/O

218.D6834323
SHAFT:CONTACT POINT:GUIDE:PAPER FEED

219.D6834325
BRACKET:GUIDE:PAPER FEED:FRONT

199.D6833510
SHAFT:LEVER:MISFEED REMOVAL:ASSY

197.D6833421
BASE:SCANNING:ENTRANCE:LOWER

198.D6833422 (x2)
LEVER:PRESSURE RELEASE

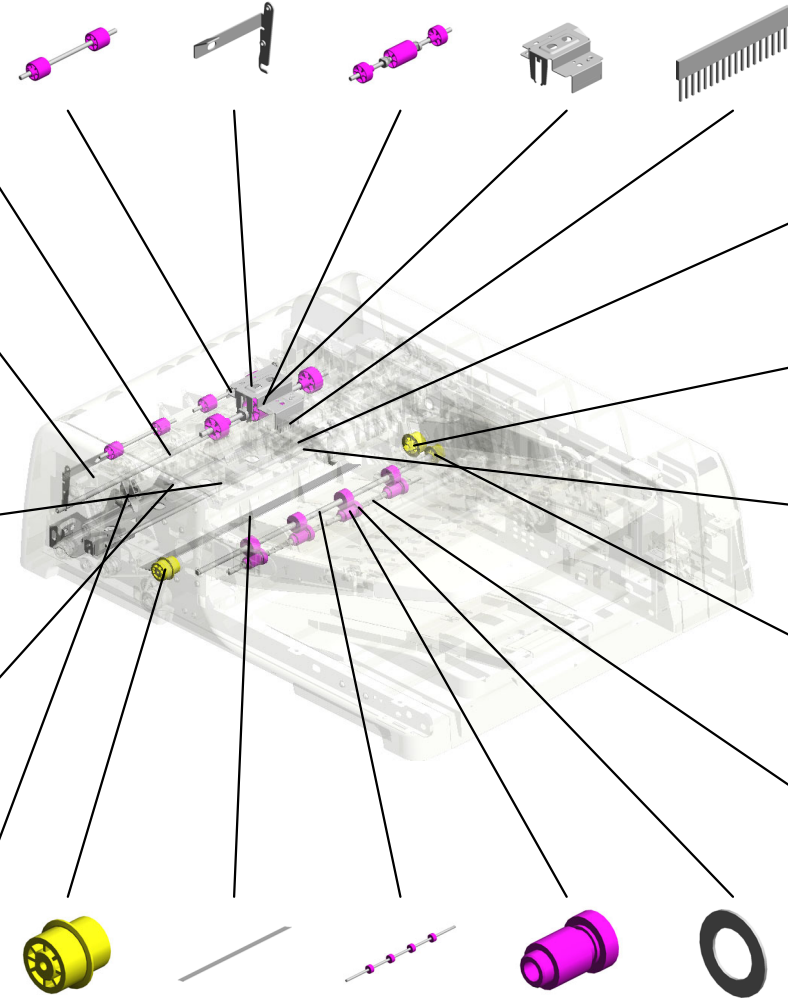

193.D6833311 (x2)
BRACKET:GUIDE:SCANNING:UPPER

212.D6833714
TIMING PULLEY:ROLLER:CIS:EXIT:DRIVE

195.D6833361 (x2)
SPRING PLATE:GUIDE PLATE:SCANNING

217.D6833915
TIMING PULLEY:ROLLER:EXIT:DRIVE

232.D6834421 (x2)
SHAFT:EXIT:DRIVE

- 213.D6833715 TIMING PULLEY:ROLLER:CIS:EXIT:FRONT
- 192.D6833260 SHEET:SCANNING:EXIT:UPPER:ASSY
- 216.D6833911 ROLLER:EXIT:DRIVE
- 233.D6834430 (x4) ROLLER:EXIT:DRIVE
- 231.D6834414 (x4) SPACER:EXIT ROLLER

U003_S001
ADF:SINAI-B:ASS'Y

245.D7312746 SIDE FENCE:ORIGINAL TABLE
 240.D6842412 (x2) PAD:STOPPER:ORIGINAL
 244.D7312734 COVER:LOWER:BASE
 246.D7312751 RAIL:SIDE FENCE
 236.D6835111 GUIDE:HARNESS:MAIN

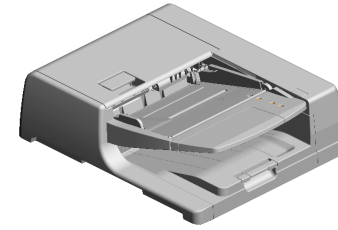

296.D1941202
 [A] ADF:SINAI-B:ASS'Y
 202302-01 O/O

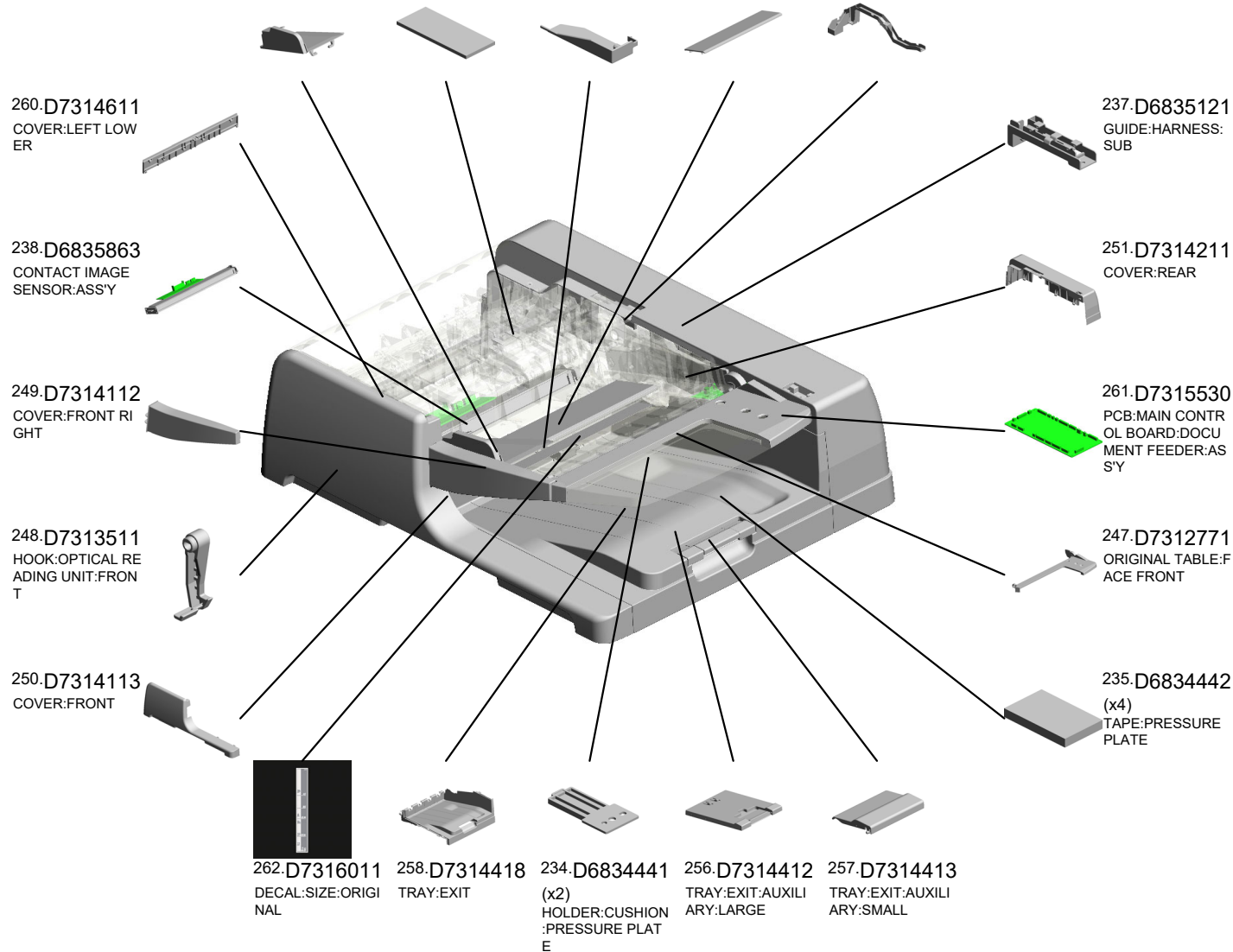

U003_S001
ADF:SINAI-B:ASS'Y

286.07922061C 285.07922054C 276.AW020234 289.07922080C 291.07922076C
 SYNCHRONOUS B SYNCHRONOUS B (x9) SYNCHRONOUS B SYNCHRONOUS B
 ELT:40S2M122:CR ELT:40S2M108:CR PHOTOINTERRUPT TOR:GP1A173LCS ELT:40S2M160:CR ELT:40S2M152:CR
 202105-07 O/O 202105-09 O/O 201904-05 O/O 202105-12 O/O 202106-01 O/O

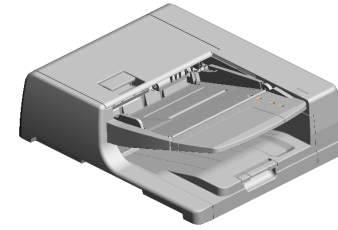

296.D1941202
 [A]
 ADF:SINAI-B:ASS'Y
 202302-01 O/O

267.G0602652
 (x4)
 BUSHING - M4



266.D7316241
 DECAL:STOPPER:
 SEPARATION UNIT



284.D7313390
 GUIDE PLATE:SCA
 NNING:CONTACT:0
 .6MM:PEEN
 202006-03 X/O



265.D7316051
 DECAL:DESIGN SK
 ETCH:MISFEED RE
 MOVAL:P



288.07922079C
 SYNCHRONOUS B
 ELT:40S2M158:CR
 202105-11 O/O



270.D7312731
 BASE:ORIGINAL T
 ABLE



273.D3B01320
 HINGE:LEFT:ASS'Y
 201812-08 X/O

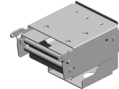

278.D3FF2852
 COVER:SENSOR



292.07922129C
 SYNCHRONOUS B
 ELT:40S2M258:CR
 202210-02 O/O



287.07922063C
 SYNCHRONOUS B
 ELT:40S2M126:CR
 202105-08 O/O



277.D3FF2851
 SENSOR COVER:P
 HOTOINTERRUPT
 OR

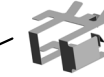

290.07922101C
 SYNCHRONOUS B
 ELT:40S2M202:CR
 202105-10 O/O



264.D7316041
 DECAL:BASE:ORIG
 INAL

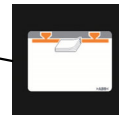

263.D7316031
 DECAL:SET:ORIG
 INAL TABLE



274.D3B01350
 HINGE:RIGHT:ASS'
 Y
 201902-03 X/O



U003_S001
ADF:SINAI-B:ASS'Y

294.D3FF1451
HOLDER:FEELER:
APS
202211-02 O/O

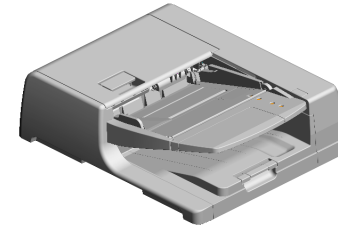
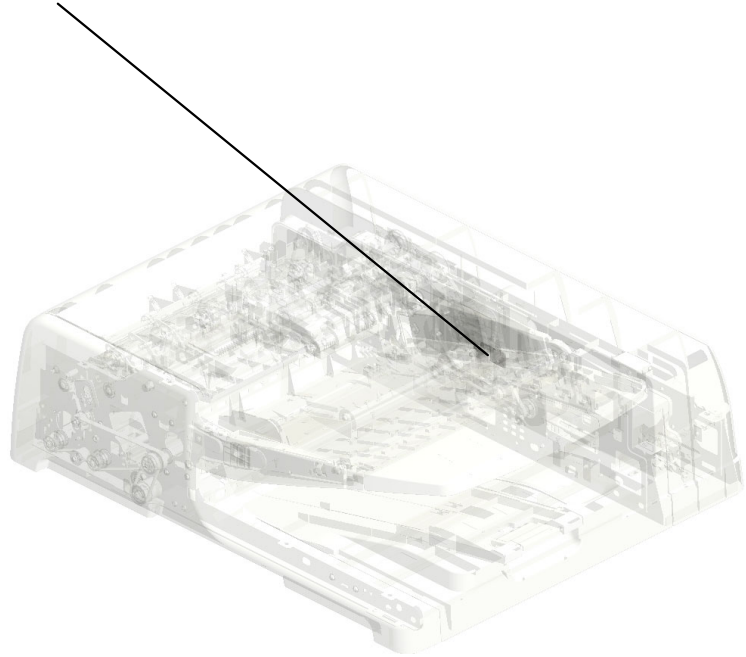
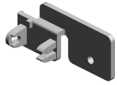

296.D1941202
[A]
ADF:SINAI-B:ASS'Y
202302-01 O/O



D1941201
[A]
ADF:ASS'Y
202302-01 O/O

U003_S001_S001
SHAFT:SEPARATION:DRIVE:INPUT:SUB-ASS'Y

57-AA082101
BUSHING - 6X10X6

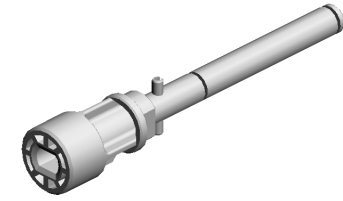

130-D6831620
SHAFT:SEPARATI
ON:DRIVE:INPUT:S
UB-ASS'Y

U001	U002	U003	U004	U005	U006	U007	U008	U009	U010	U011	U012	U013	U014	U015	U016	U017	U018	U019	U020	U021
------	------	------	------	------	------	------	------	------	------	------	------	------	------	------	------	------	------	------	------	------

U003_S001_S002
SHAFT:REVERSE ROLLER:SUB-ASS'Y

12.07200040E
RETAINING RING -
M4

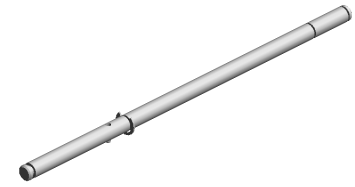
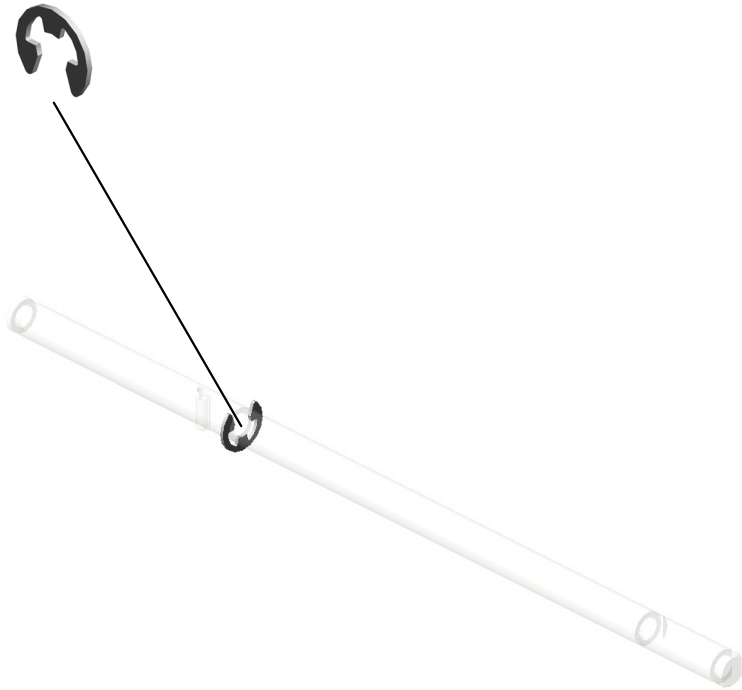

131.D6831632
SHAFT:REVERSE
ROLLER:SUB-ASS'
Y

U001	U002	U003	U004	U005	U006	U007	U008	U009	U010	U011	U012	U013	U014	U015	U016	U017	U018	U019	U020	U021
------	------	------	------	------	------	------	------	------	------	------	------	------	------	------	------	------	------	------	------	------

U003_S001_S003

SHAFT:INPUT:PAPER FEED:SUB-ASS'Y

12.07200040E
RETAINING RING -
M4

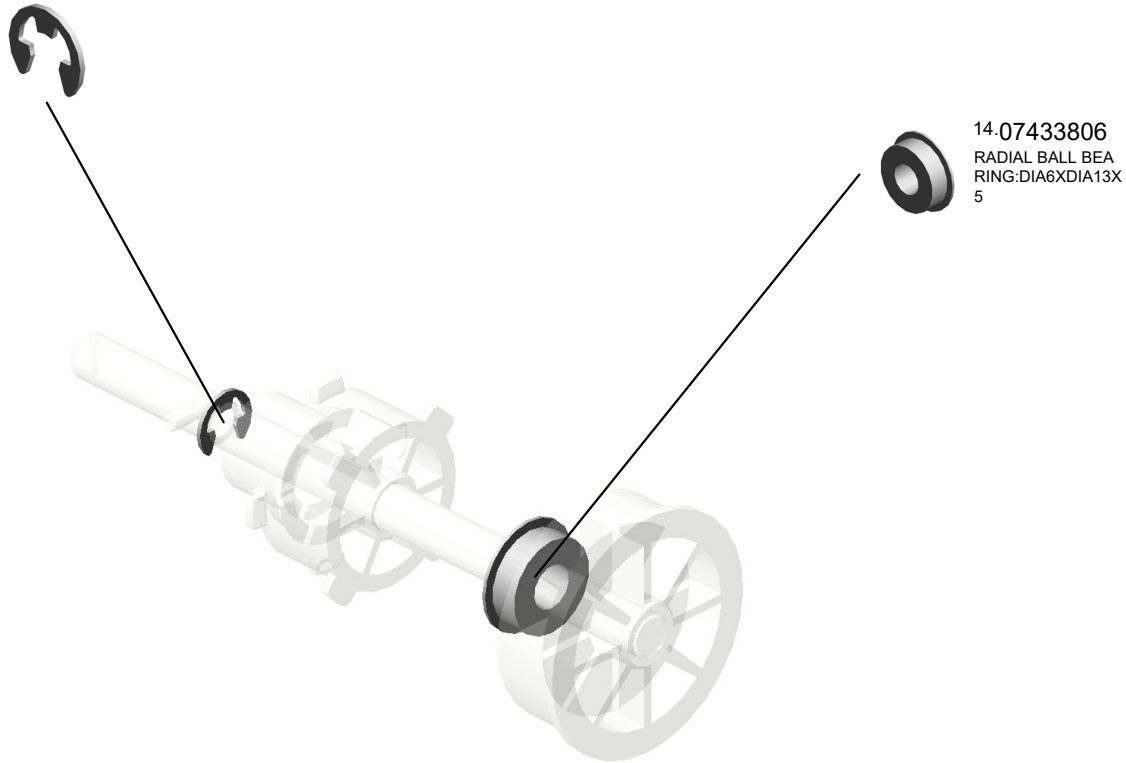
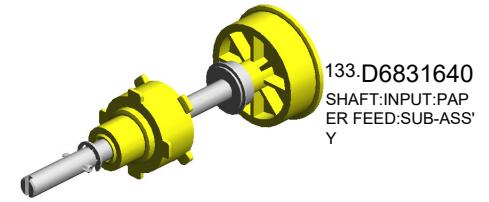

U001	U002	U003	U004	U005	U006	U007	U008	U009	U010	U011	U012	U013	U014	U015	U016	U017	U018	U019	U020	U021
------	------	------	------	------	------	------	------	------	------	------	------	------	------	------	------	------	------	------	------	------

U003_S001_S004
CAM:PICKUP

57-AA082101
BUSHING - 6X10X6

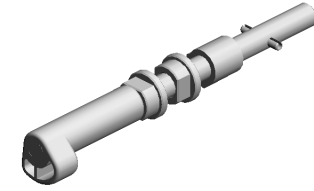

139-D6831680
CAM:PICKUP

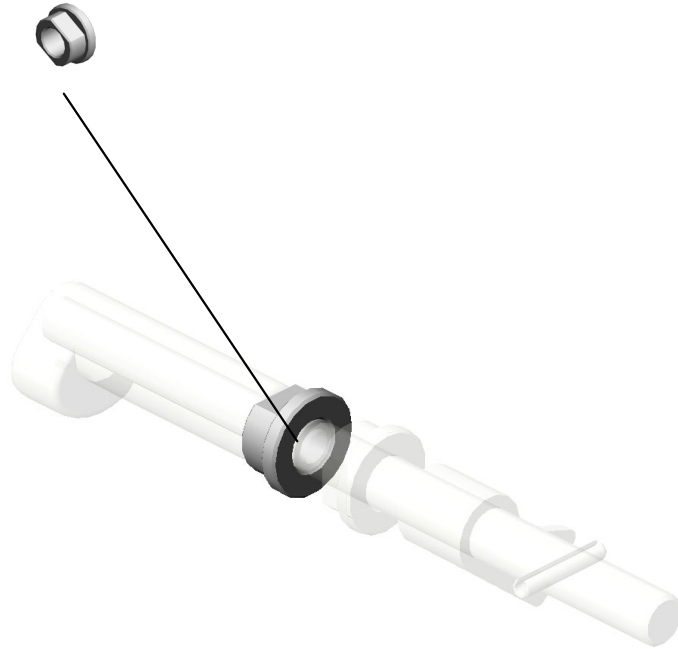

U001	U002	U003	U004	U005	U006	U007	U008	U009	U010	U011	U012	U013	U014	U015	U016	U017	U018	U019	U020	U021
------	------	------	------	------	------	------	------	------	------	------	------	------	------	------	------	------	------	------	------	------

U003_S001_S005
ROLLER:PULL OUT:DRIVE

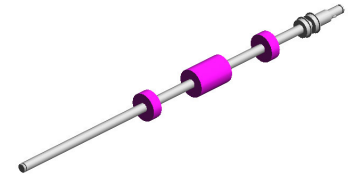

155.D6832110
ROLLER:PULL OUT
:DRIVE

U001	U002	U003	U004	U005	U006	U007	U008	U009	U010	U011	U012	U013	U014	U015	U016	U017	U018	U019	U020	U021
------	------	------	------	------	------	------	------	------	------	------	------	------	------	------	------	------	------	------	------	------

U003_S001_S006
ROLLER:MIDDLE:DRIVE

58-AA082104
BUSHING - 8X12X7

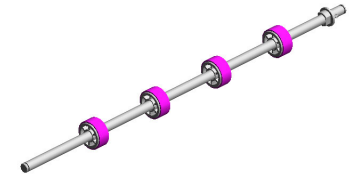
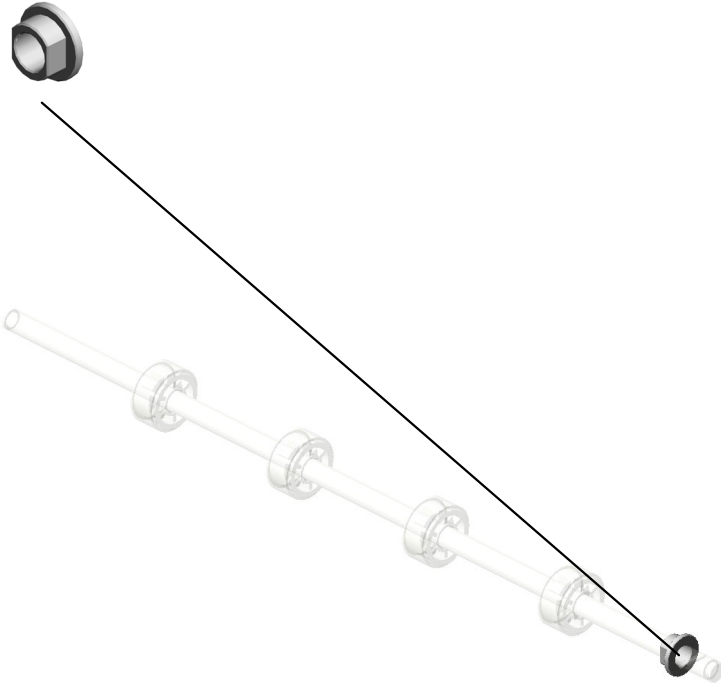

157-D6832210
ROLLER:MIDDLE:D
RIVE

U001	U002	U003	U004	U005	U006	U007	U008	U009	U010	U011	U012	U013	U014	U015	U016	U017	U018	U019	U020	U021
------	------	------	------	------	------	------	------	------	------	------	------	------	------	------	------	------	------	------	------	------

U003_S001_S007
SHAFT:SEPARATION:ASS'Y

- 13.07200060E RETAINING RING - M6
- 160.D6832224 GUIDE:PAPER FEED:ENTRANCE:FRO NT
- 37.A6281225 (x4) BUSHING - 8MM
- 84.B7892114 PAPER FEED BELT ROLLER
- 158.D6832221 GEAR:IDLER:Z18

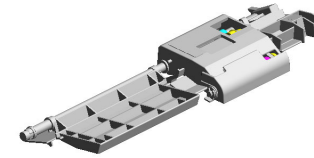

280.D7312202
[A]
SHAFT:SEPARATI
ON:ASS'Y
202003-04 O/O

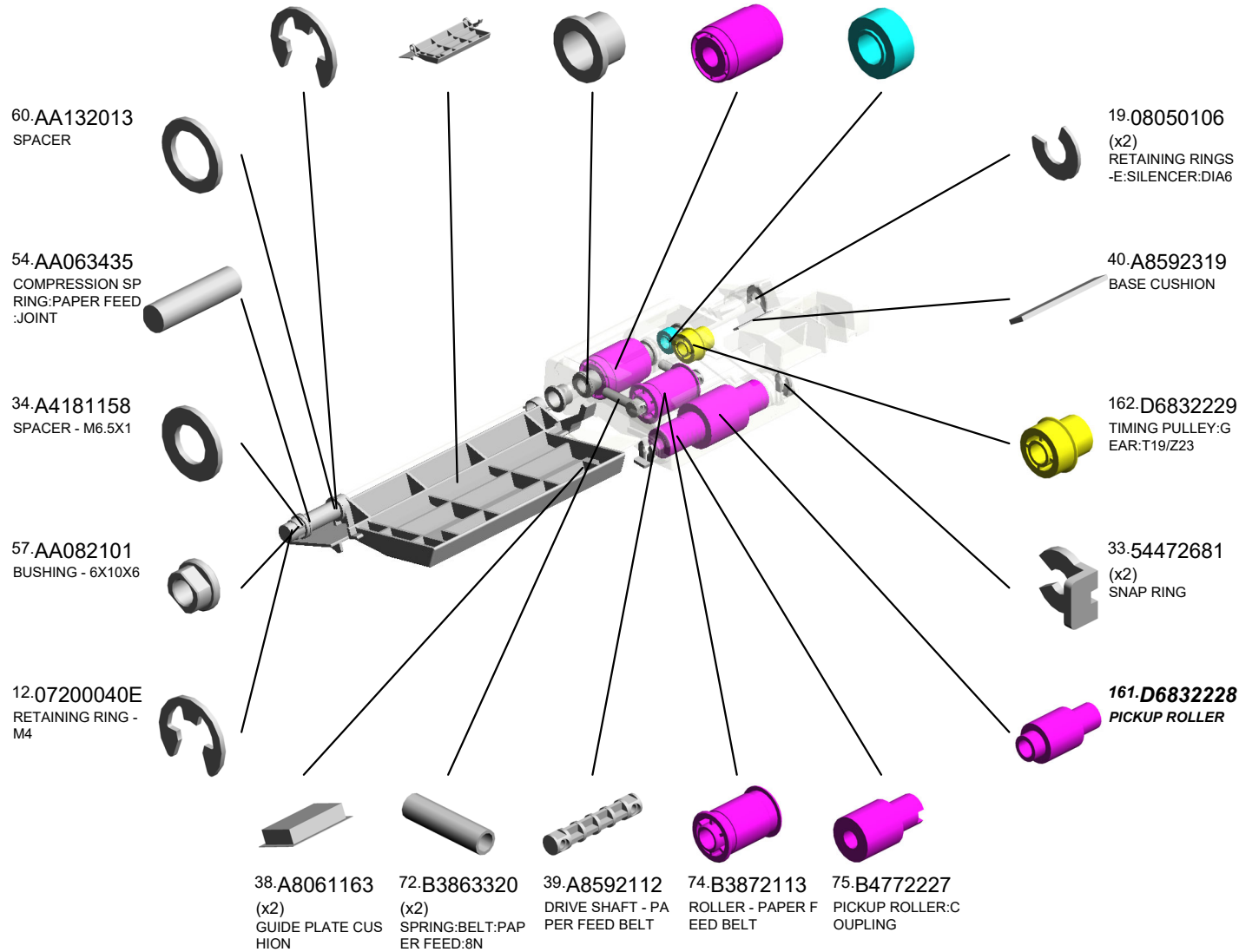

U001	U002	U003	U004	U005	U006	U007	U008	U009	U010	U011	U012	U013	U014	U015	U016	U017	U018	U019	U020	U021
------	------	------	------	------	------	------	------	------	------	------	------	------	------	------	------	------	------	------	------	------

U003_S001_S007
SHAFT:SEPARATION:ASS'Y

282.D3FF2233 BRACKET:PAPER FEED BELT
202006-01 X/O

163.D6832231 BRACKET:PICKUP

170.D6832272 LEVER:PICKUP ROLLER:RISE

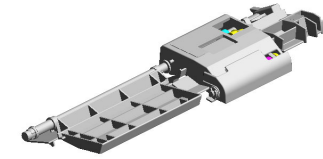

280.D7312202
[A]
SHAFT:SEPARATION:ASS'Y
202003-04 O/O

279.D3FF6071
DECAL:CAUTION:ORIGINAL:PICK-UP PAPER JAM
201911-03



239.D6842171
PAPER FEED BELT

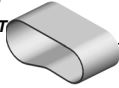

275.D3FF2219
GUIDE:PAPER FEED BELT:FRONT
201902-04 O/O

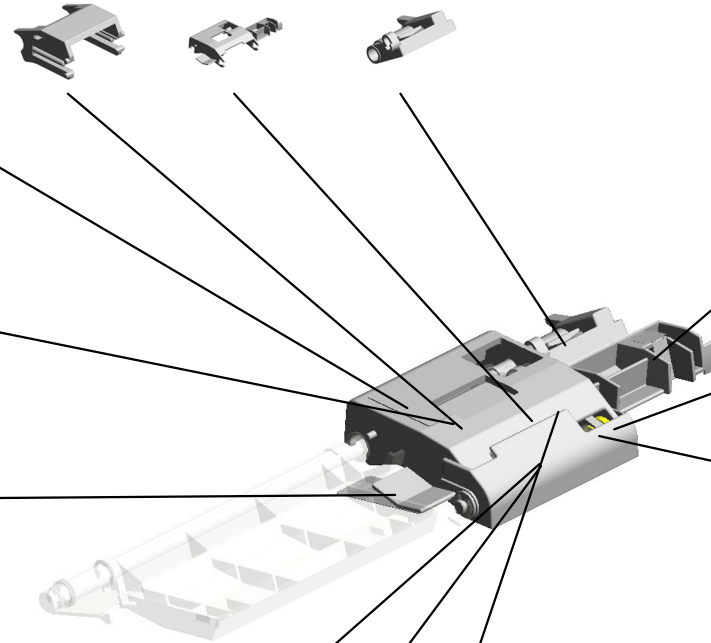

167.D6832236
SHEET:BRACKET:PICKUP:INNER BACK



268.H0602126
(x2)
BUSHING - M6X7



164.D6832232
TIMING PULLEY:PICKUP:T21



243.D7312239
COVER:PICKUP ROLLER



166.D6832235
SHAFT:PICKUP:SUB-ASS'Y



295.07922065C
SYNCHRONOUS BELT:40S2M130:CR
202301-04 O/O



D7312200
[A]
SHAFT:SEPARATION:ASS'Y
202003-04 O/O

U003_S001_S007_S001
GUIDE:PAPER FEED:ENTRANCE:INNER BACK:ASS'Y

169.D6832242
SHEET:GUIDE:PAP
ER FEED:INNER B
ACK

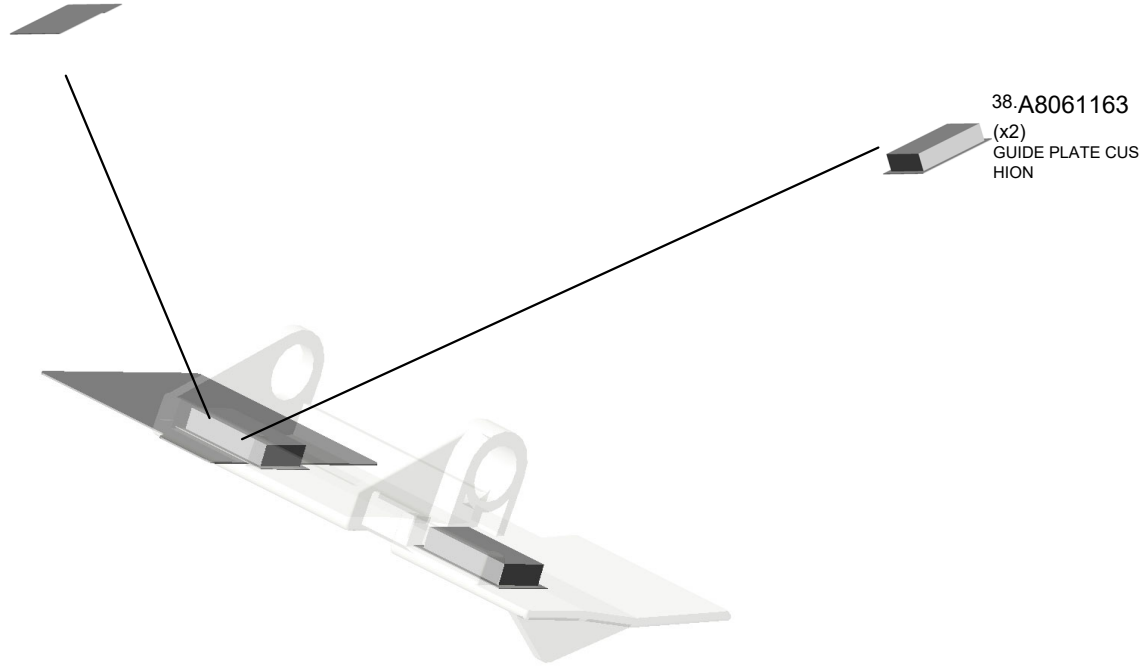
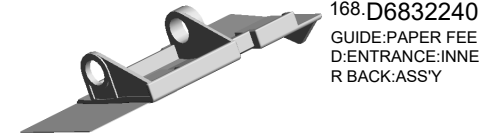

U001	U002	U003	U004	U005	U006	U007	U008	U009	U010	U011	U012	U013	U014	U015	U016	U017	U018	U019	U020	U021
------	------	------	------	------	------	------	------	------	------	------	------	------	------	------	------	------	------	------	------	------

U003_S001_S008
DC MOTOR:RISING TRAY:ASS'Y:1.007W:BRUSH

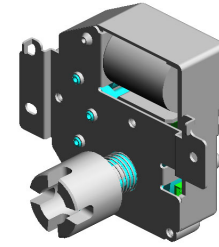

70:AX040254
DC MOTOR:RISING
TRAY:ASS'Y:1.007
W:BRUSH

5:04523010N(x 4)
BINDING SELF-TAPPING SCREW:3X10

U001	U002	U003	U004	U005	U006	U007	U008	U009	U010	U011	U012	U013	U014	U015	U016	U017	U018	U019	U020	U021
------	------	------	------	------	------	------	------	------	------	------	------	------	------	------	------	------	------	------	------	------

U003_S001_S009
GUIDE PLATE:EXIT:UPPER:ASS'Y

215.D6833812
DISCHARGE BRUS
H:EXIT

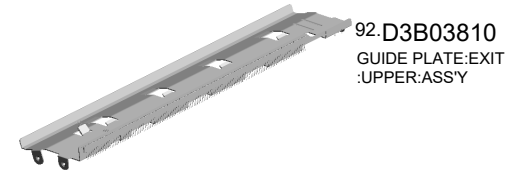

92.D3B03810
GUIDE PLATE:EXIT
:UPPER:ASS'Y

87.B8041180
(x2)
DISCHARGE BRUS
H:PUNCH UNIT

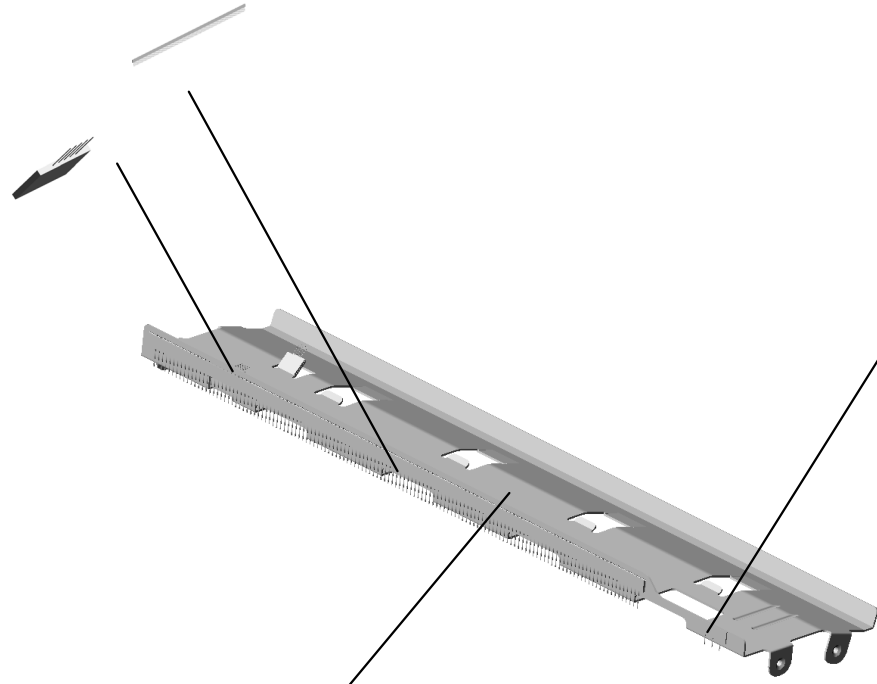

241.D6902425
DISCHARGE BRUS
H:SHORT:FRONT

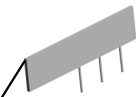

214.D6833811
GUIDE PLATE:EXIT
:UPPER



U001	U002	U003	U004	U005	U006	U007	U008	U009	U010	U011	U012	U013	U014	U015	U016	U017	U018	U019	U020	U021
------	------	------	------	------	------	------	------	------	------	------	------	------	------	------	------	------	------	------	------	------

U003_S001_S010
ROLLER:SCANNING:EXIT:DRIVE:ASS'Y

58-AA082104
(x2)
BUSHING - 8X12X7

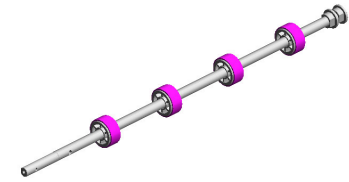

188-D6833150
ROLLER:SCANNIN
G:EXIT:DRIVE:ASS'
Y



13-07200060E
RETAINING RING -
M6

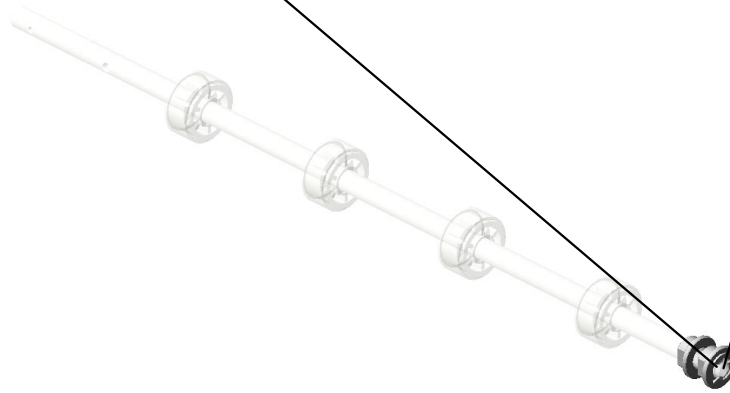

U001	U002	U003	U004	U005	U006	U007	U008	U009	U010	U011	U012	U013	U014	U015	U016	U017	U018	U019	U020	U021
------	------	------	------	------	------	------	------	------	------	------	------	------	------	------	------	------	------	------	------	------

U003_S001_S011
GUIDE:EXIT:LOWER:ASS'Y

- 61.AA143788 (x2) PIN:GUIDE PLATE: PAPER FEED
- 201.D6833621 GUIDE:EXIT:LOWE R:SUB-ASS'Y
- 87.B8041180 (x4) DISCHARGE BRUS H:PUNCH UNIT
- 35.A4221063 SEAL - 0.7X13X20

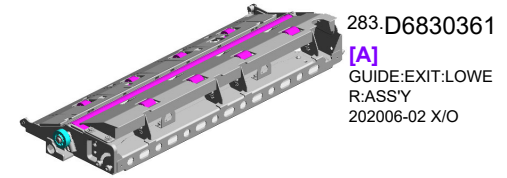

- 283.D6830361 [A] GUIDE:EXIT:LOWE R:ASS'Y 202006-02 X/O

- 111.D5433635 GEAR:ROLLER:SC ANNING:BEHIND



- 18.08050104 RETAINING RINGS -E:SILENCER:DIA4



- 206.D6833651 COVER:SCANNING :EXIT

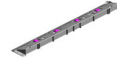

- 99.D4122653 BUSHING:DIA6



- 100.D4122669 (x2) TENSION SPRING: GUIDE PLATE:PRE SSURE:2N



- 78.B4774129 (x2) SPRING - 12N

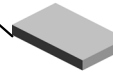

- 235.D6834442 (x4) TAPE:PRESSURE PLATE



- 8.04543006Q (x7) TAPPING SCREW - M3X6



- 200.D6833616 (x2) BRACKET:DISCHA RGE BRUSH



- D6830360 [A] GUIDE:EXIT:LOWE R:ASS'Y 202006-02 X/O

U003_S001_S011_S001
ROLLER:SCANNING:BEHIND:ASS'Y

99.D4122653
BUSHING:DIA6

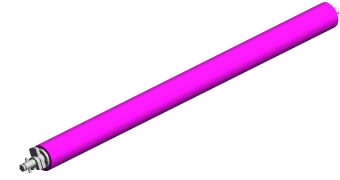

110.D5433631
ROLLER:SCANNIN
G:BEHIND:ASS'Y

U001	U002	U003	U004	U005	U006	U007	U008	U009	U010	U011	U012	U013	U014	U015	U016	U017	U018	U019	U020	U021
------	------	------	------	------	------	------	------	------	------	------	------	------	------	------	------	------	------	------	------	------

U003_S001_S011_S002
 GUIDE:CONTACT IMAGE SENSOR:EXIT:LOWER:ASS'Y

205.D6833645
 (x2)
 ROLLER:MIDDLE:D
 RIVEN

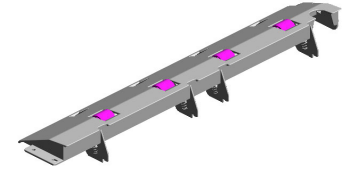

281.D6833646
 [A]
 GUIDE:CONTACT I
 MAGE SENSOR:EX
 IT:LOWER:ASS'Y
 202004-02 X/O

267.G0602652
 (x4)
 BUSHING - M4

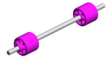

203.D6833643
 (x4)
 COMPRESSION SP
 RING:CONTACT IM
 AGE SENSOR:EXIT

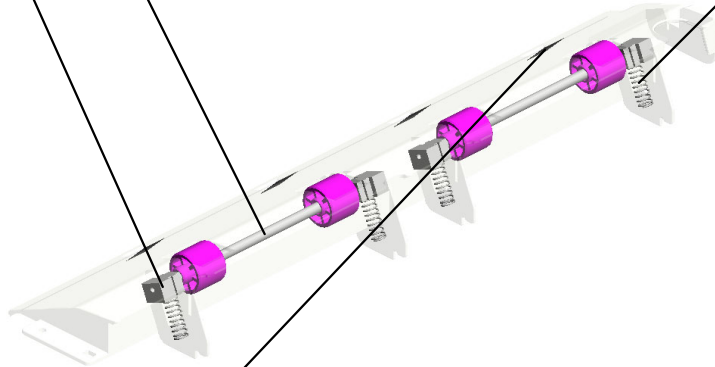

D6833641
 [A]
 GUIDE:CONTACT I
 MAGE SENSOR:EX
 IT:LOWER:ASS'Y
 202004-02 X/O

204.D6833644
 (x4)
 SHEET:GUIDE:CO
 NTACT IMAGE SEN
 SOR:EXIT:LOWER

U001	U002	U003	U004	U005	U006	U007	U008	U009	U010	U011	U012	U013	U014	U015	U016	U017	U018	U019	U020	U021
------	------	------	------	------	------	------	------	------	------	------	------	------	------	------	------	------	------	------	------	------

U003_S001_S011_S003

GUIDE PLATE:CONTACT IMAGE SENSOR:ENTRANCE:ASS'Y

215.D6833812 DISCHARGE BRUSH:EXIT
209.D6833667 LEVER:GUIDE PLATE:CONTACT IMAGE SENSOR:REAR

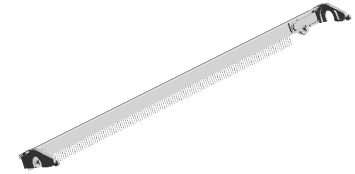

207.D6833662 GUIDE PLATE:CONTACT IMAGE SENSOR:ENTRANCE:ASS'Y

208.D6833666 LEVER:GUIDE PLATE:CONTACT IMAGE SENSOR:FRONT

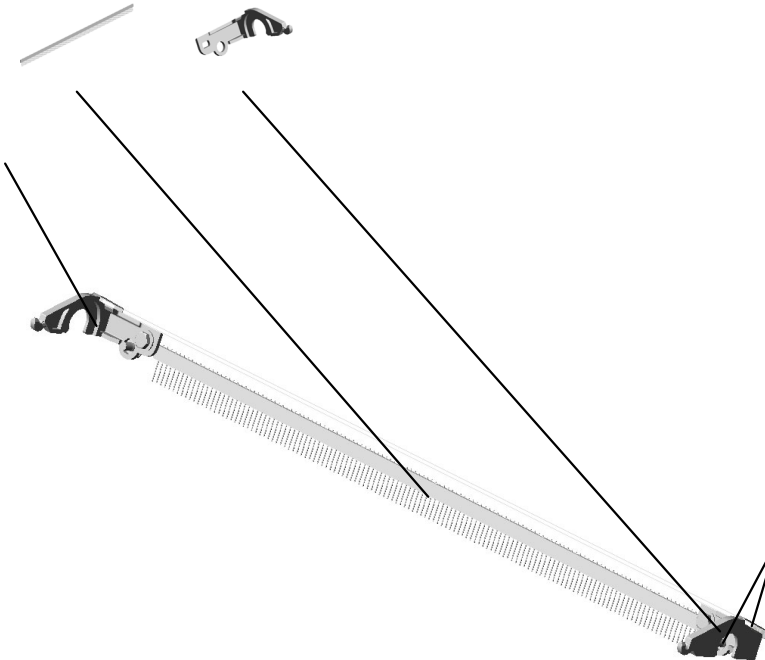

210.D6833668 (x2) SPACER:GUIDE PLATE:CONTACT IMAGE SENSOR:ENTRANCE

2.03603006N (x4) SCREW - M3X6

U001	U002	U003	U004	U005	U006	U007	U008	U009	U010	U011	U012	U013	U014	U015	U016	U017	U018	U019	U020	U021
------	------	------	------	------	------	------	------	------	------	------	------	------	------	------	------	------	------	------	------	------

U003_S001_S012

ROLLER:CONTACT IMAGE SENSOR:EXIT:DRIVE:PRESS FIT

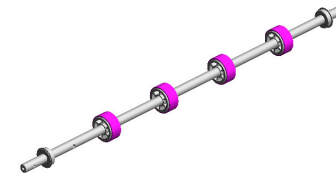

211.D6833710
ROLLER:CONTACT
IMAGE SENSOR:E
XIT:DRIVE:PRESS
FIT

U001	U002	U003	U004	U005	U006	U007	U008	U009	U010	U011	U012	U013	U014	U015	U016	U017	U018	U019	U020	U021
------	------	------	------	------	------	------	------	------	------	------	------	------	------	------	------	------	------	------	------	------

U003_S001_S013
GUIDE:SCANNING:ENTRANCE:LOWER:SUB-ASS'Y

109.D5433314
(x4)
SHEET:SCANNING:
ENTRANCE:MIDDLE

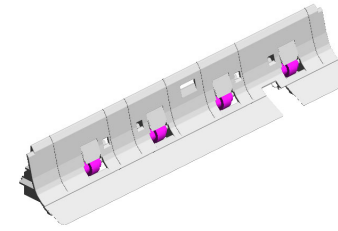

196.D6833411
GUIDE:SCANNING:
ENTRANCE:LOWER:
SUB-ASS'Y

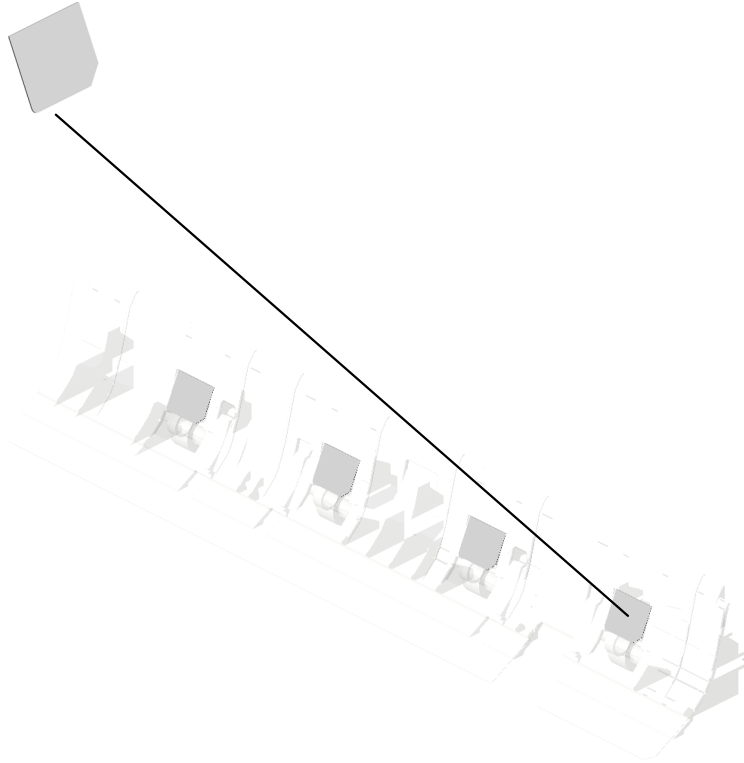

U001	U002	U003	U004	U005	U006	U007	U008	U009	U010	U011	U012	U013	U014	U015	U016	U017	U018	U019	U020	U021
------	------	------	------	------	------	------	------	------	------	------	------	------	------	------	------	------	------	------	------	------

U003_S001_S014
PRESSURE PLATE:ASS'Y

93.D3B04711 98.D3B04725
GUIDE PLATE:PRE CUSHION:PRESSU
SSURE PLATE:LEF RE PLATE:SMALL
T:ASS'Y

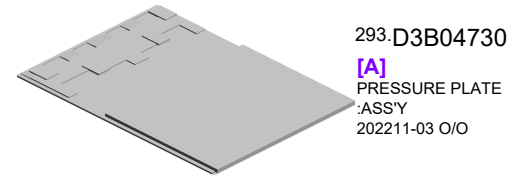

293.D3B04730
[A]
PRESSURE PLATE
:ASS'Y
202211-03 O/O

96.D3B04722
(x4)
CUSHION:TAPE:SMALL

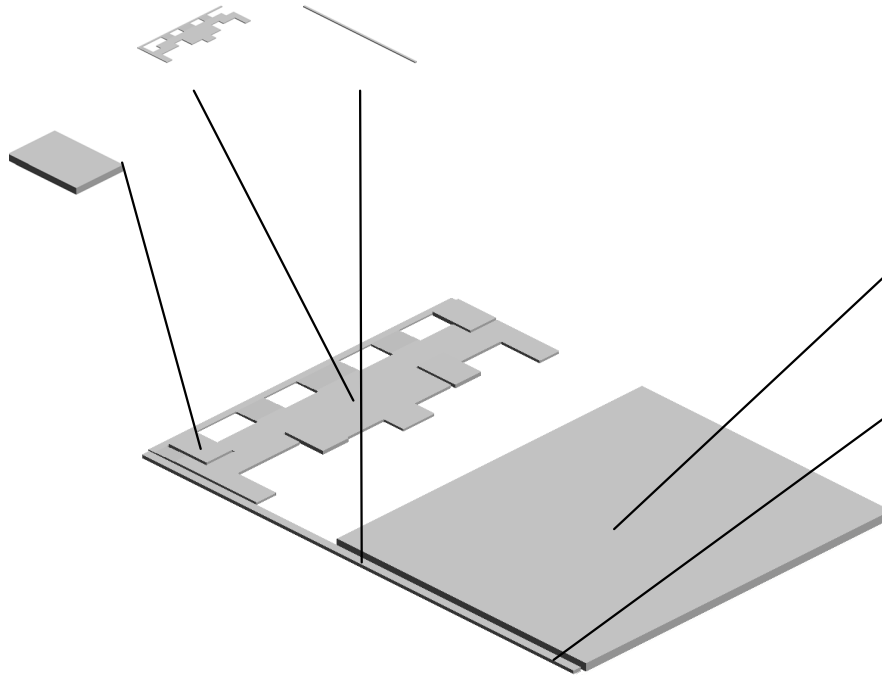

97.D3B04724
CUSHION:PRESSURE PLATE:LARGE

272.D0A46099
SHEET:PRESSURE PLATE:SMALL
201809-04 O/O



D3B04720
[A]
PRESSURE PLATE
:ASS'Y
202211-03 O/O

U001	U002	U003	U004	U005	U006	U007	U008	U009	U010	U011	U012	U013	U014	U015	U016	U017	U018	U019	U020	U021
------	------	------	------	------	------	------	------	------	------	------	------	------	------	------	------	------	------	------	------	------

U003_S001_S015
COVER:PAPER FEED:ASS'Y

226.D6834351 LINK:STOPPER:COVER:PAPER FEED
 77.B4774117 SPRING
 65.AA143846 TAPPING SCREW: M3X6
 227.D6834361 SHAFT:CONTACT POINT:GRIP

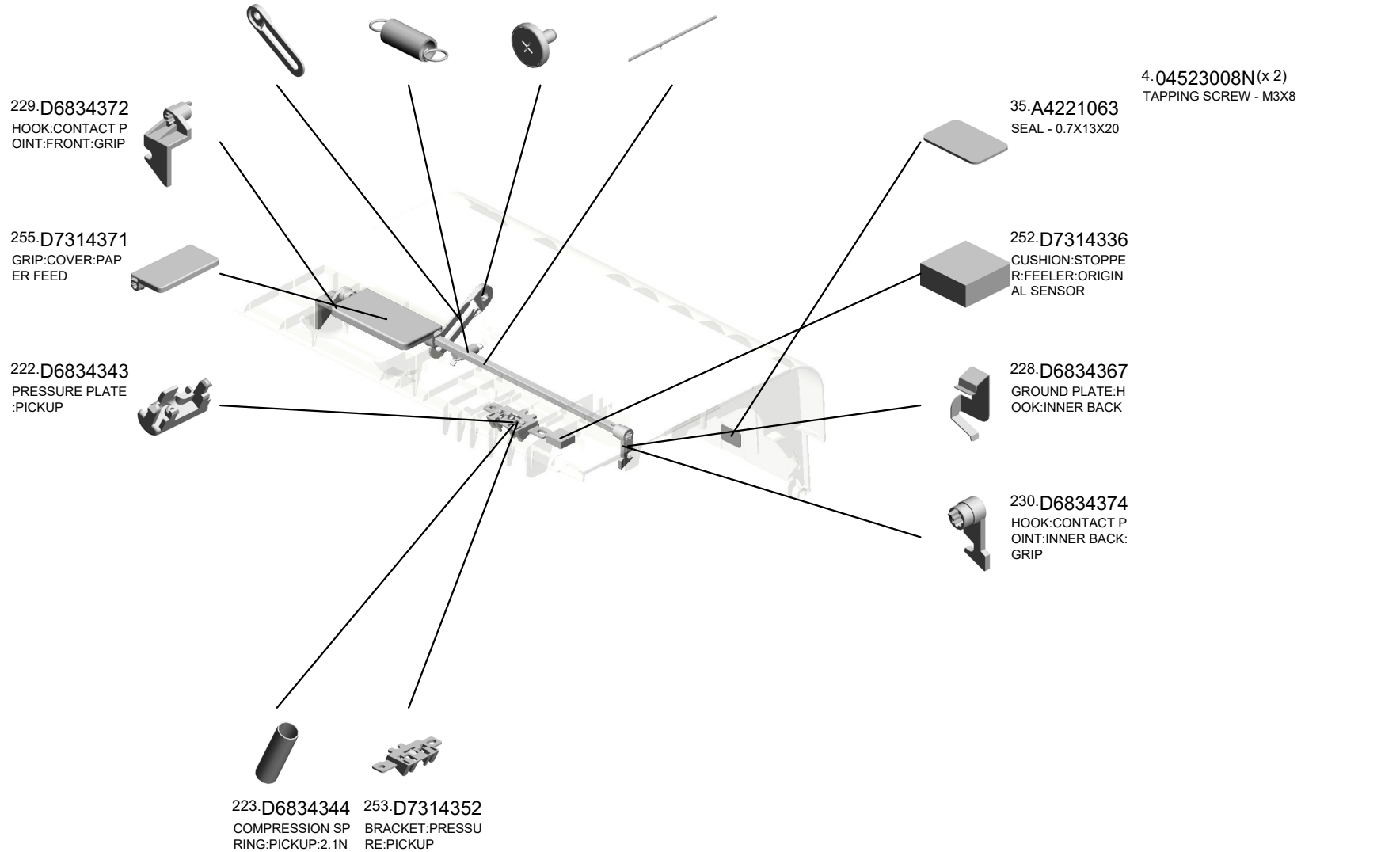
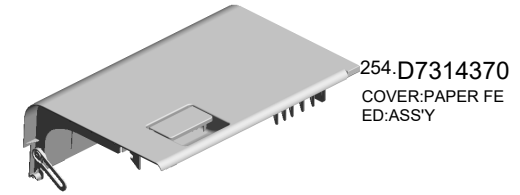

U003_S001_S016
COVER:LOWER:ASS'Y

235.D6834442
(x2)
TAPE:PRESSURE
PLATE

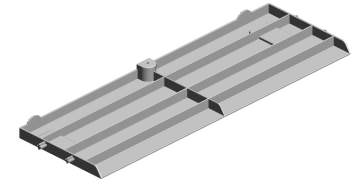
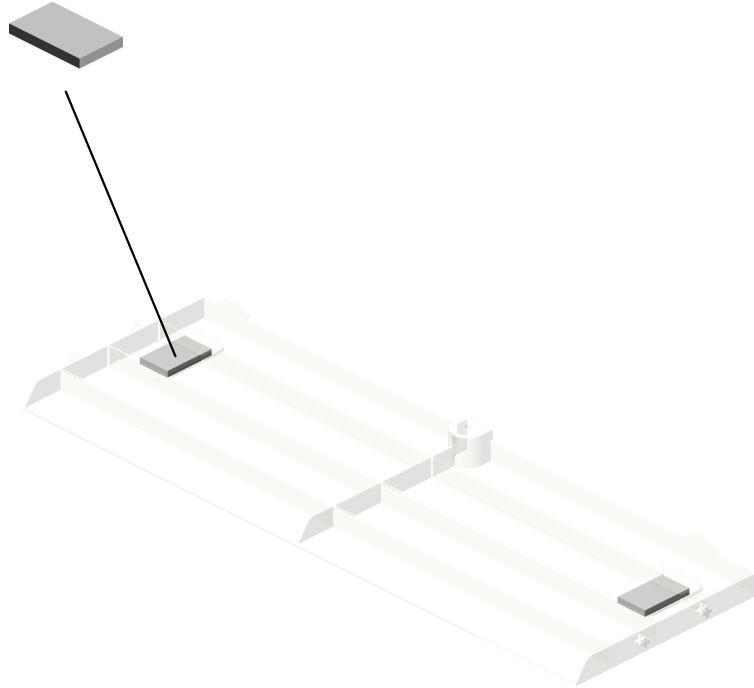

259.D7314510
COVER:LOWER:AS
SY

U001	U002	U003	U004	U005	U006	U007	U008	U009	U010	U011	U012	U013	U014	U015	U016	U017	U018	U019	U020	U021
------	------	------	------	------	------	------	------	------	------	------	------	------	------	------	------	------	------	------	------	------

U004.SCANNER

U004 S003
D1491721
ILLUMINATION UNIT:LED-B:A
SS'Y

U004 S001
D1381731
LENSBLOCK SMD:SERVICE
PARTS:ASS'Y

U004 S004
D1361776
CARRIAGE:NO.2:ASS'Y

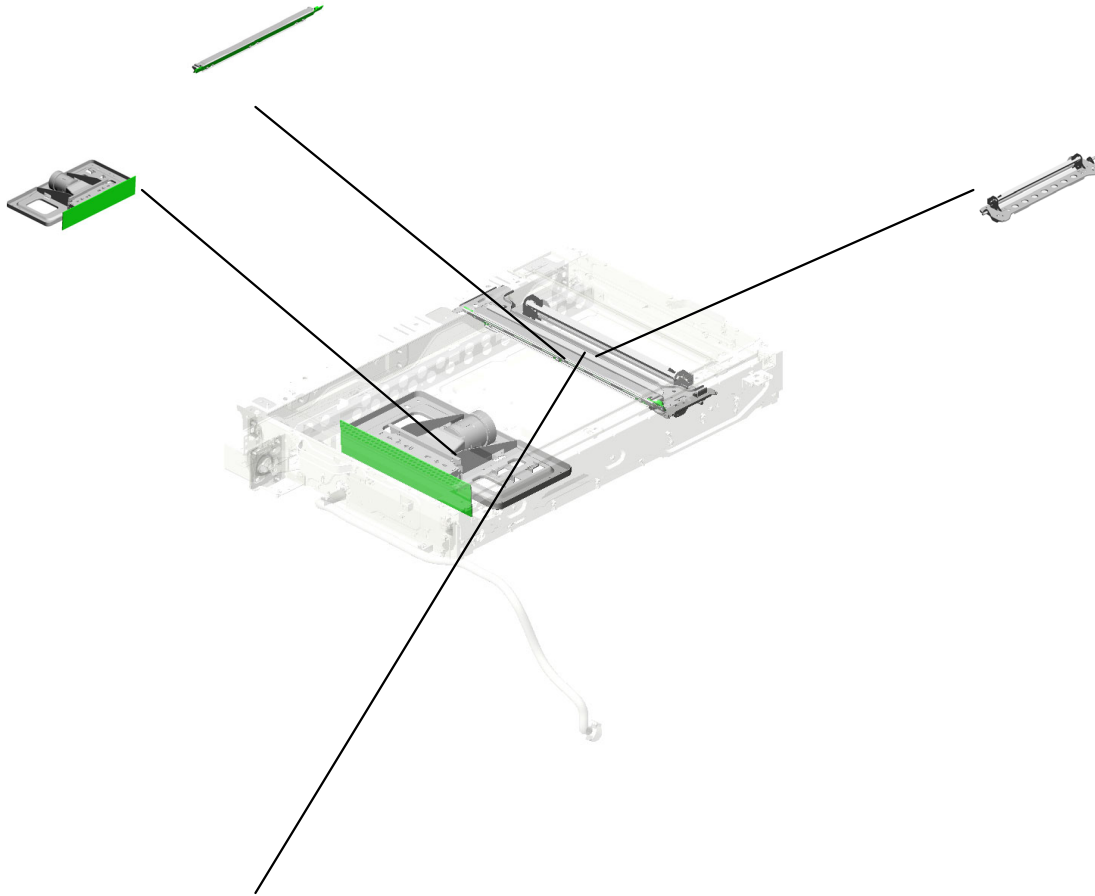

U004 S002
D1361751
CARRIAGE:NO.1:ASS'Y

U001	U002	U003	U004	U005	U006	U007	U008	U009	U010	U011	U012	U013	U014	U015	U016	U017	U018	U019	U020	U021
------	------	------	-------------	------	------	------	------	------	------	------	------	------	------	------	------	------	------	------	------	------

U004 SCANNER

- 14.11050761 (x2) CLAMP:LWS-0511A
- 20.AW010134 (x2) ORIGINAL SENSOR - 48MM
- 10.08046123 (x7) HEXAGONAL BOLT :W/WASHER:M3X8
- 17.A2501752 EXPOSURE GLASS
- 7.07200040E (x2) RETAINING RING - M4

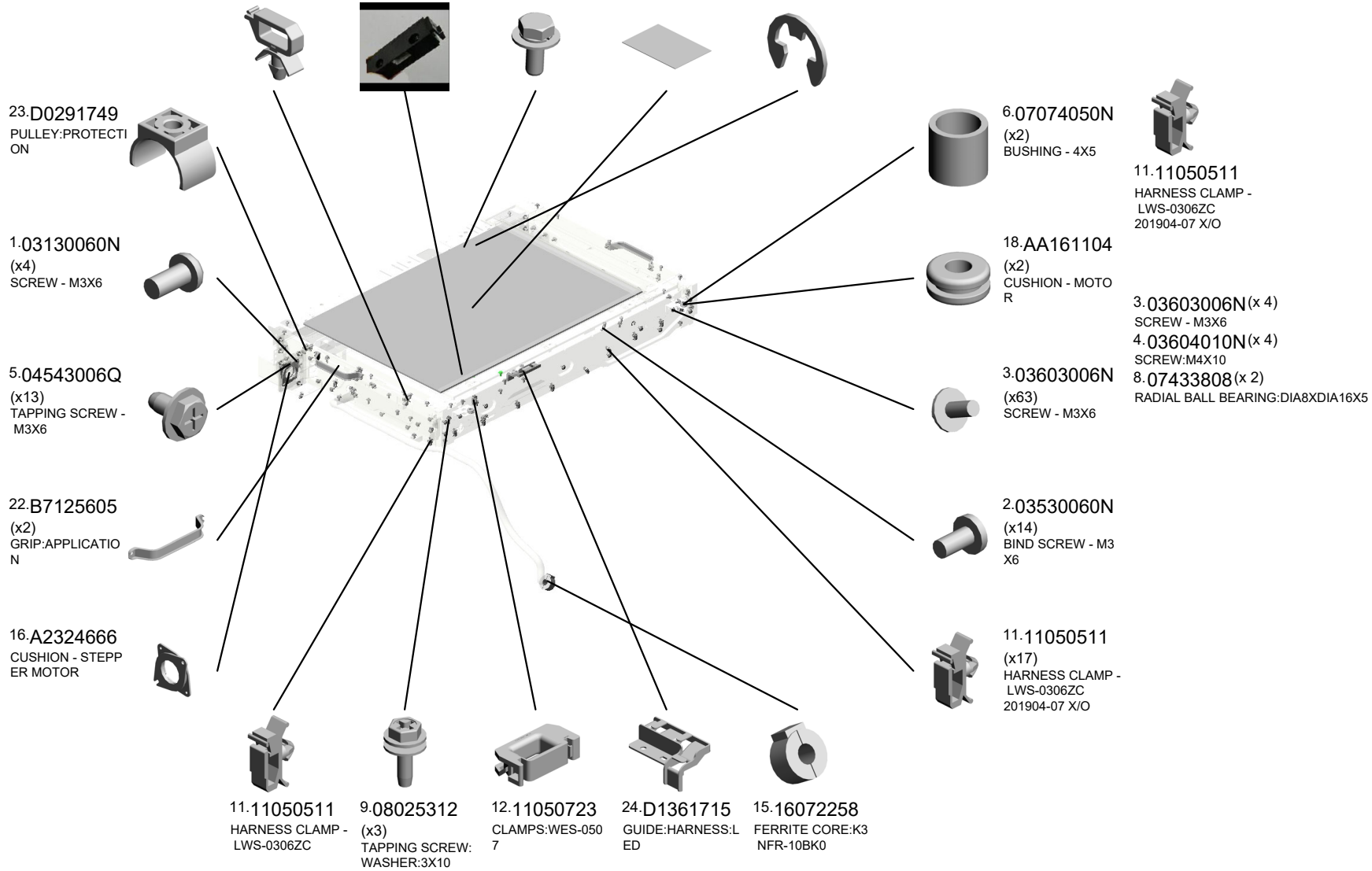
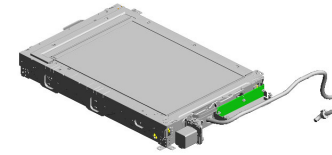

U004 SCANNER

- 41.D1361802 TIMING PULLEY:65
- 45.D1361810 (x2) TENSION SPRING: TENSION:11N
- 44.D1361809 (x2) BRACKET:TENSIO N
- 43.D1361806 (x2) DRIVE WERE:DIA1
- 28.D1361758 (x2) CLAMP:WIRE

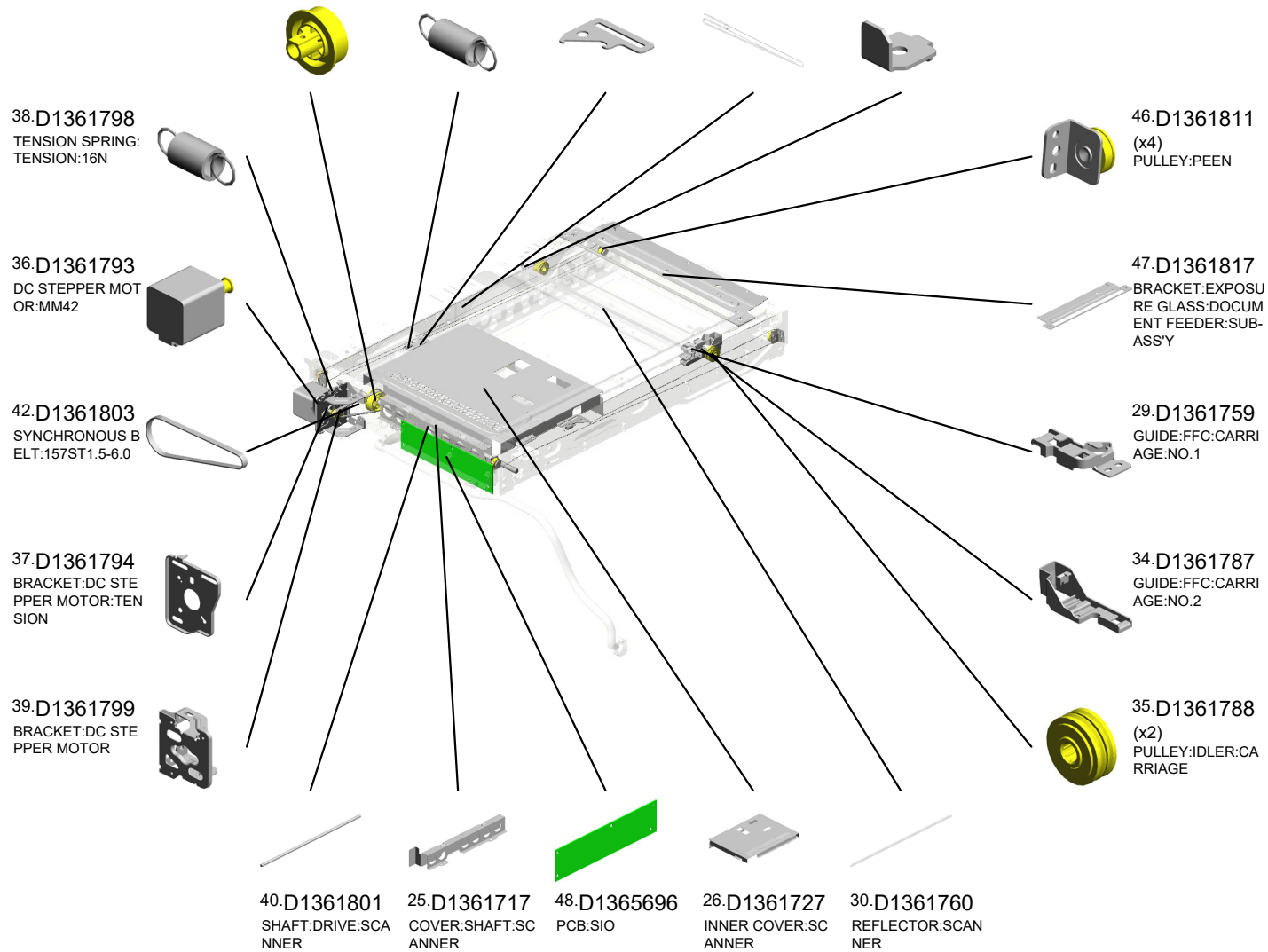
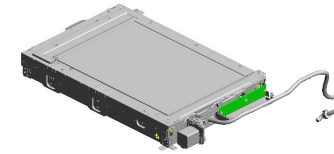

U004 SCANNER

- 50.D1441085 (x5) STEPPED SCREW: M3
- 57.D1791764 (NA):SCALE:LEFT: ASS'Y
- 56.D1791763 (x2) (CHN/EU,AA,TWN, KOR):SCALE:LEFT: ASS'Y
- 58.D1791768 EXPOSURE GLASS :DOCUMENT FEED ER
- 59.D1791777 COVER:EXPOSUR E GLASS:DOCUME NT FEEDER

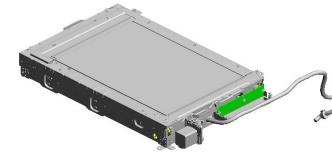

- 54.D1491804 (x2) HOLDER:EXPOSURE GLASS:SCANNER

- 51.D1491715 PULLEY:DRIVE WHEEL:FRONT

- 55.D1491805 (x4) HOLDER:EXPOSURE GLASS

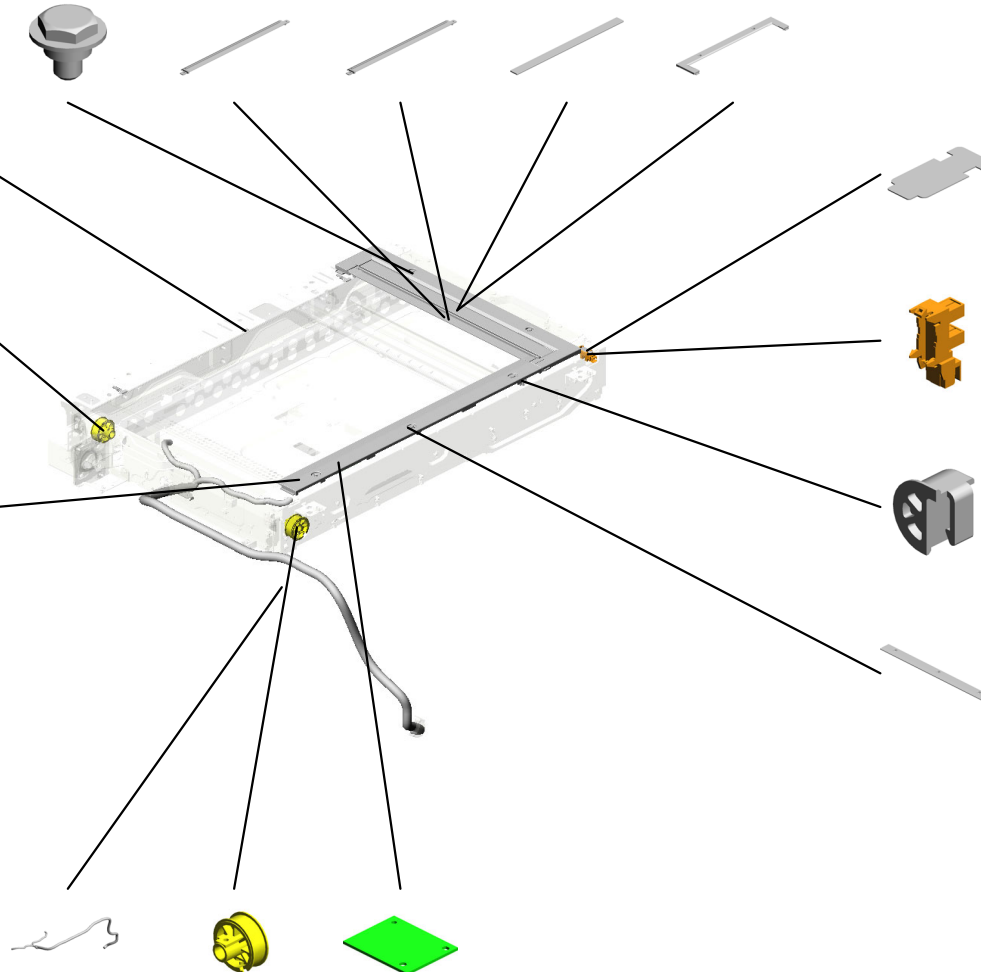

- 64.G5701225 SENSOR SHIELDING PLATE

- 68.GW020024 PHOTOINTERRUPTOR:LG2A24BL1:GF 202211-01 O/O

- 65.M0261778 GUIDE:FFC

- 60.D1791789 SCALE:REAR:PRINTING

- 61.D1795824 INTERFACE CABLE:SCANNER:IMAGING PROCESSING UNIT:ASS'Y
- 52.D1491717 PULLEY:DRIVE WHEEL:REAR
- 67.D1945126 PCB:IDB 201910-03 O/O

U004_S001
LENSBLOCK SMD:SERVICE PARTS:ASS'Y

3.03603006N
(x4)
SCREW - M3X6

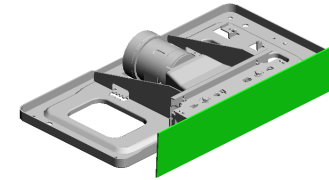

49.D1381731
LENSBLOCK SMD:
SERVICE PARTS:A
SS'Y

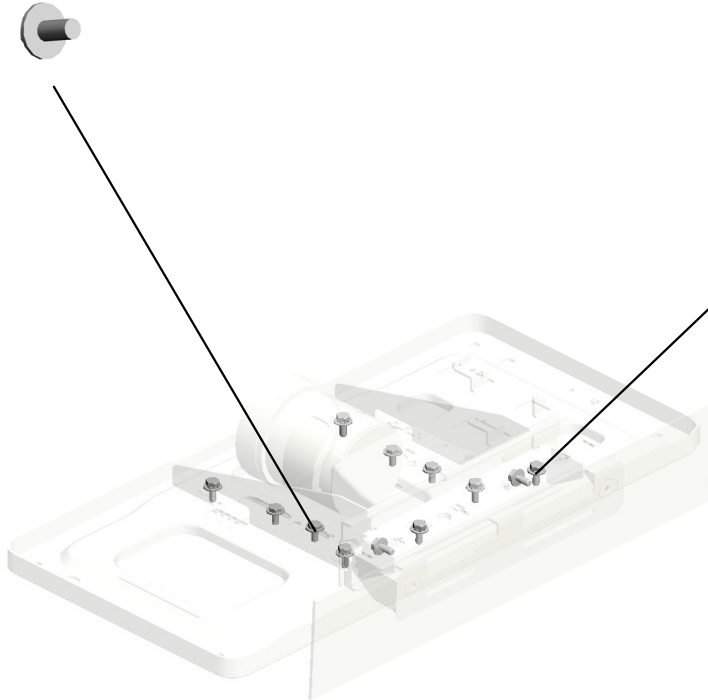

10.08046123
(x8)
HEXAGONAL BOLT
:WASHER:M3X8

2.03530060N (x 2)
BIND SCREW - M3X6

U001	U002	U003	U004	U005	U006	U007	U008	U009	U010	U011	U012	U013	U014	U015	U016	U017	U018	U019	U020	U021
------	------	------	------	------	------	------	------	------	------	------	------	------	------	------	------	------	------	------	------	------

U004_S002
CARRIAGE:NO.1:ASS'Y

66.M0261815
(x2)
CLAMP:MIRROR:N
O.1



27.D1361751
CARRIAGE:NO.1:A
SS'Y

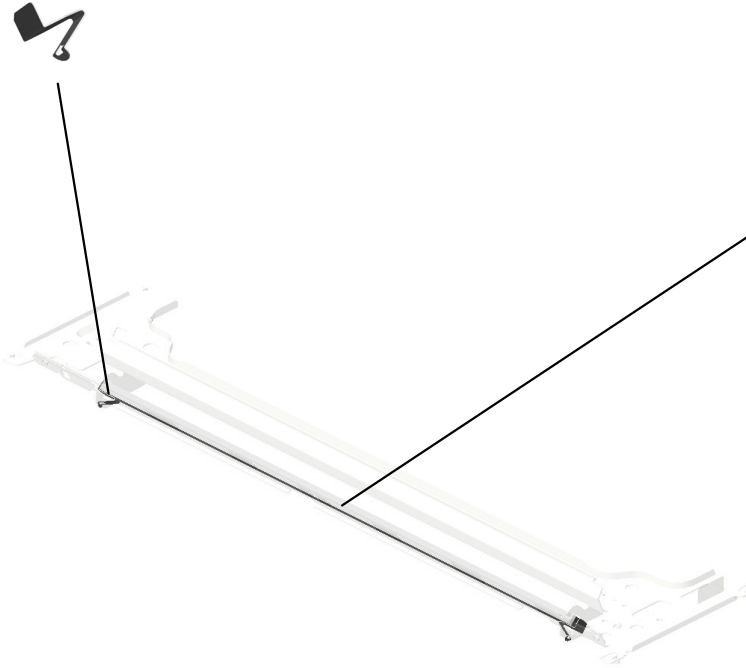

19.AC030211
MIRROR:NO.1

U001	U002	U003	U004	U005	U006	U007	U008	U009	U010	U011	U012	U013	U014	U015	U016	U017	U018	U019	U020	U021
------	------	------	------	------	------	------	------	------	------	------	------	------	------	------	------	------	------	------	------	------

U004_S003
ILLUMINATION UNIT:LED-B:ASS'Y

2.03530060N
(x3)
BIND SCREW - M3
X6

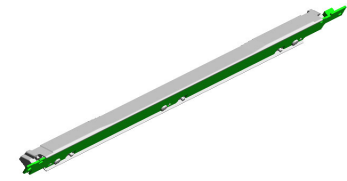

53.D1491721
ILLUMINATION UNI
T:LED-B:ASS'Y



U001	U002	U003	U004	U005	U006	U007	U008	U009	U010	U011	U012	U013	U014	U015	U016	U017	U018	U019	U020	U021
------	------	------	-------------	------	------	------	------	------	------	------	------	------	------	------	------	------	------	------	------	------

U004_S004
CARRIAGE:NO.2:ASS'Y

32.D1361784 33.D1361785
MIRROR:NO.2:ASS'Y MIRROR:NO.3:ASS'Y



31.D1361776
CARRIAGE:NO.2:ASS'Y

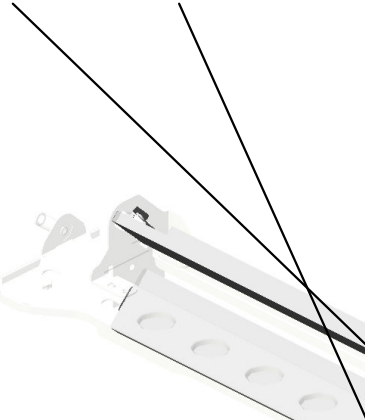

63.G4042810
(x4)
SPRING PLATE - 2
ND MIRROR

U001	U002	U003	U004	U005	U006	U007	U008	U009	U010	U011	U012	U013	U014	U015	U016	U017	U018	U019	U020	U021
------	------	------	------	------	------	------	------	------	------	------	------	------	------	------	------	------	------	------	------	------

U005.LASER UNIT

U005 S001
D2701901
OPTICAL WRITING UNIT:ASS
Y

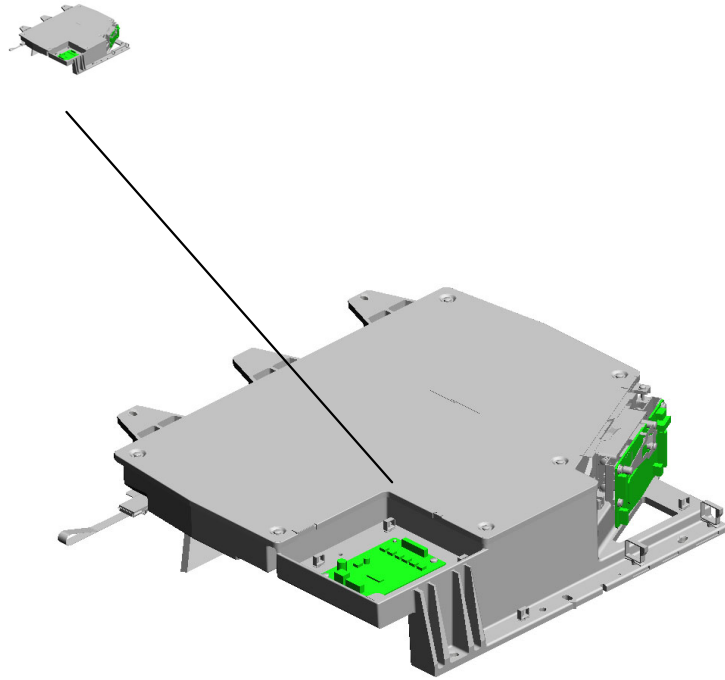

U001	U002	U003	U004	U005	U006	U007	U008	U009	U010	U011	U012	U013	U014	U015	U016	U017	U018	U019	U020	U021
------	------	------	------	-------------	------	------	------	------	------	------	------	------	------	------	------	------	------	------	------	------

U005
LASER UNIT

9.16072256
FERRITE CORE:K3
NFR-08-ABK0

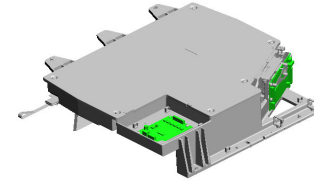

4.03604012N
(x4)
SCREW:M4X12

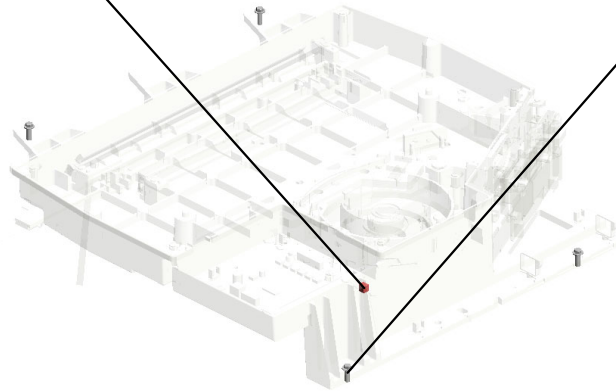

U001	U002	U003	U004	U005	U006	U007	U008	U009	U010	U011	U012	U013	U014	U015	U016	U017	U018	U019	U020	U021
------	------	------	------	------	------	------	------	------	------	------	------	------	------	------	------	------	------	------	------	------

U005_S001
OPTICAL WRITING UNIT:ASS'Y

12.G0291980 1.03530060N 10.D0144192
DECAL - LD (x40) CLAMP:HARNESS
BIND SCREW - M3
X6

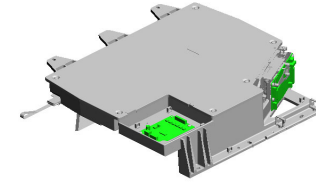

11.D2701901
OPTICAL WRITING
UNIT:ASS'Y

5.04523008N
(x2)
TAPPING SCREW -
M3X8



13.11050759
(x7)
CLAMP:LWSM-060
5A
202310-04 O/O

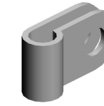

7.11050528
(x2)
NYLON CLAMP - E
MT-2N



14.11050764
(x2)
CLAMP:LWS-1316A
202310-05 O/O

1.03530060N(x 2)
BIND SCREW - M3X6
3.03603008N(x 2)
SCREW:M3X8

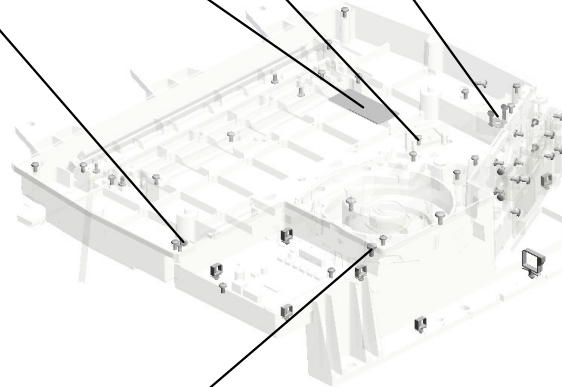

2.03540080N
(x3)
SCREW:M4X8

U006.PAPER FEED:PAPER BANK

U006 S008
D2706541
SHAFT:DRIVE:FEED:ASS'Y

U006 S009
D2706541
SHAFT:DRIVE:FEED:ASS'Y

U006 S010
D2706541
SHAFT:DRIVE:FEED:ASS'Y

U006 S012
D2236233
DC SOLENOID:COUPLING:ASS'Y

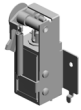

U006 S007
AX040199
DC MOTOR:RISING TRAY:ASS'Y

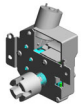

U006 S011
D2236231
DC SOLENOID:LOCK:ASS'Y



U006 S004
D0747681
(NA):HEAT SINK:HEATER:UPPER:ASS'Y



U006 S005
D1797525
STOPPER:REGISTRATION:TRANSDUCER:ASS'Y



U006 S001
D0BX7631
PAPER TRAY:UNIVERSAL:SUB-ASS'Y

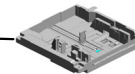

U006 S006
AX040199
DC MOTOR:RISING TRAY:ASS'Y

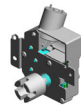

U006 S002
D0BX7631
PAPER TRAY:UNIVERSAL:SUB-ASS'Y

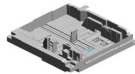

U006 S003
B1406226
(NA):HEAT SINK:HEATER:LOWER:ASS'Y

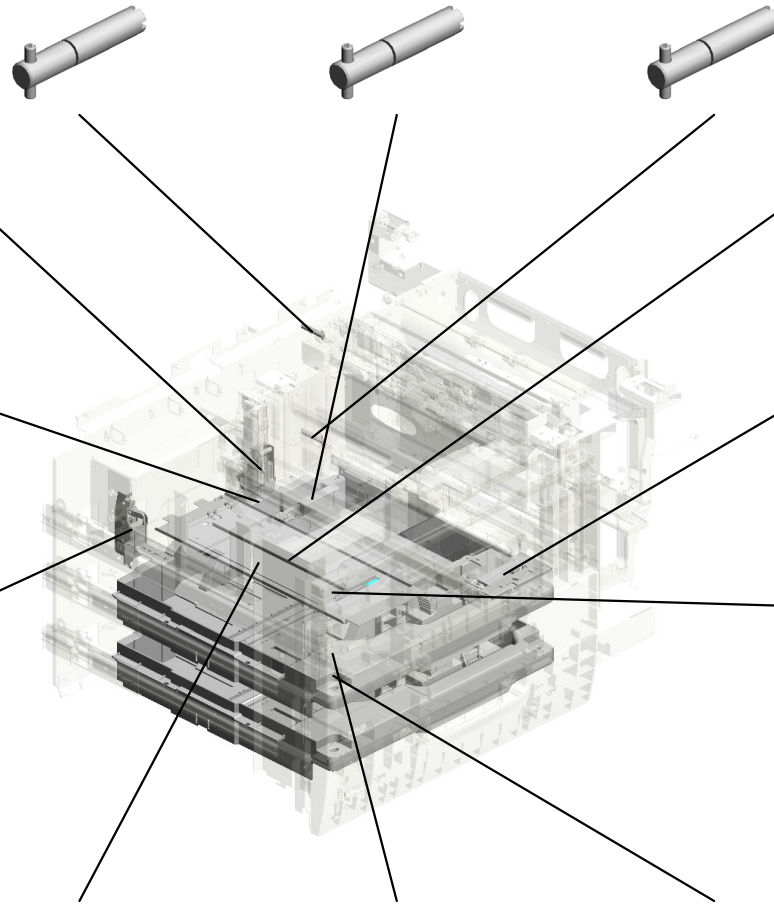
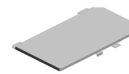

U006.PAPER FEED:PAPER BANK

U006 S018
D2707559
(NA):TANDEM LCT:LEFT:ASSY

U006 S017
D2706647
(NA):TANDEM LCT:RIGHT:ASSY

U006 S015
D2706628
PAPER FEED UNIT:PAPER BANK:ASSY

U006 S020
D2707558
(EU,AA,TWN,KOR):TANDEM LCT:LEFT:ASSY

U006 S022
D2706688
(CHN):TANDEM LCT:LEFT:ASSY

U006 S013
D0BX6771
GUIDE PLATE:OPEN AND CLOSE:VERTICAL TRANSPORT:LOWER:ASSY

U006 S019
D2706646
(EU,AA,TWN,KOR):TANDEM LCT:RIGHT:ASSY

U006 S014
D2706628
PAPER FEED UNIT:PAPER BANK:ASSY

U006 S021
D2706687
(CHN):TANDEM LCT:RIGHT:ASSY

U006 S016
D2706628
PAPER FEED UNIT:PAPER BANK:ASSY

U001	U002	U003	U004	U005	U006	U007	U008	U009	U010	U011	U012	U013	U014	U015	U016	U017	U018	U019	U020	U021
------	------	------	------	------	------	------	------	------	------	------	------	------	------	------	------	------	------	------	------	------

U006_S001.PAPER TRAY:UNIVERSAL:SUB-ASS'Y

U006 S001 S003
D1316777
SIDE FENCE:FRONT:ASS'Y

U006 S001 S001
D0BX6780
TRAY BOTTOM PLATE:ASS'Y

U006 S001 S002
D1316775
SIDE FENCE:REAR:ASS'Y

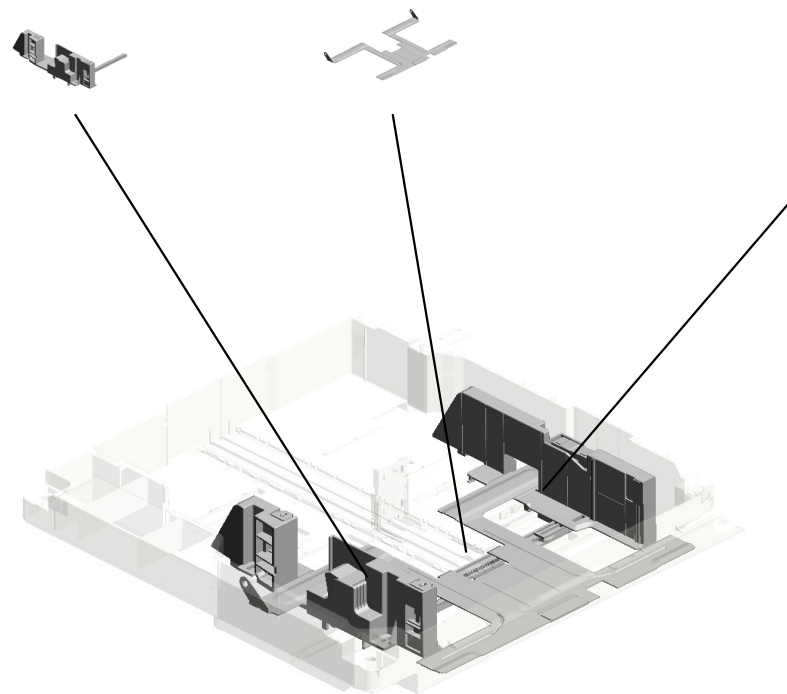

U001	U002	U003	U004	U005	U006	U007	U008	U009	U010	U011	U012	U013	U014	U015	U016	U017	U018	U019	U020	U021
------	------	------	------	------	-------------	------	------	------	------	------	------	------	------	------	------	------	------	------	------	------

U006_S002.PAPER TRAY:UNIVERSAL:SUB-ASS'Y

U006 S002 S003
D1316777
SIDE FENCE:FRONT:ASS'Y

U006 S002 S001
D0BX6780
TRAY BOTTOM PLATE:ASS'Y

U006 S002 S002
D1316775
SIDE FENCE:REAR:ASS'Y

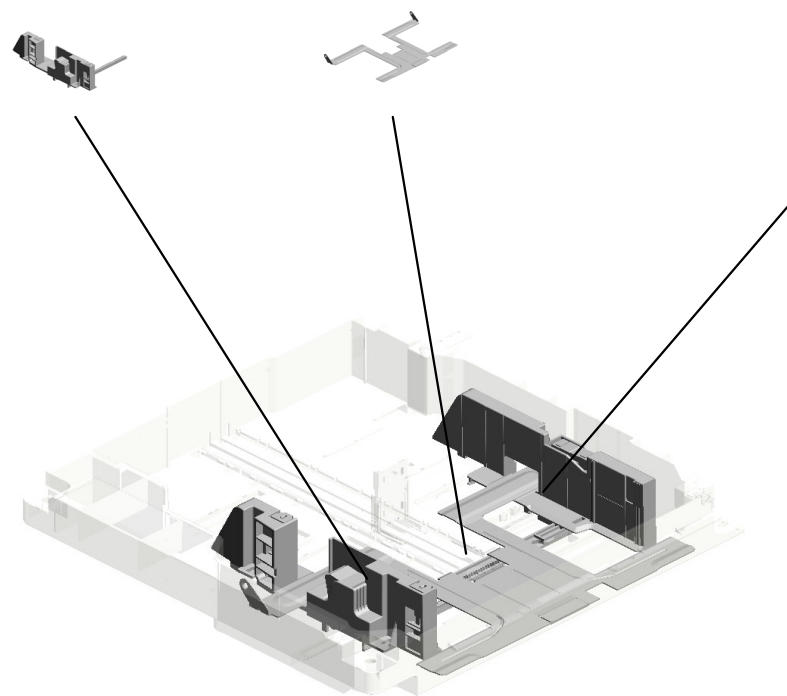

U001	U002	U003	U004	U005	U006	U007	U008	U009	U010	U011	U012	U013	U014	U015	U016	U017	U018	U019	U020	U021
------	------	------	------	------	-------------	------	------	------	------	------	------	------	------	------	------	------	------	------	------	------

U006_S013.GUIDE PLATE:OPEN AND CLOSE:VERTICAL TRANSPORT:LOWER:ASS'Y

U006 S013 S002
D3553840
BRACKET:DETENT:ASS'Y

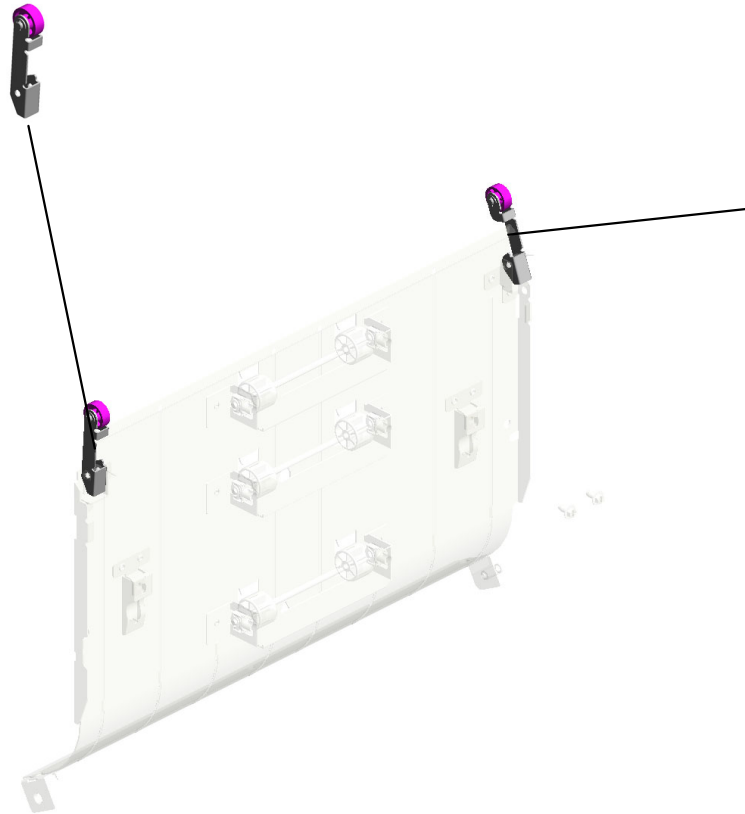

U006 S013 S001
D3553810
BRACKET:DETENT:RIGHT:A
SS'Y

U001	U002	U003	U004	U005	U006	U007	U008	U009	U010	U011	U012	U013	U014	U015	U016	U017	U018	U019	U020	U021
------	------	------	------	------	-------------	------	------	------	------	------	------	------	------	------	------	------	------	------	------	------

U006_S014.PAPER FEED UNIT:PAPER BANK:ASS'Y

U006 S014 S002
D0BX6282
SWING UNIT:PICKUP ROLLE
R:ASSY

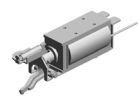

U006 S014 S001
D0747527
SHAFT:FEED:ASS'Y

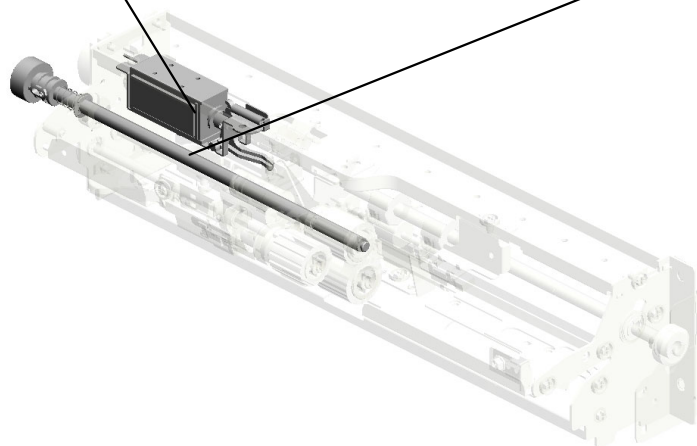

U001	U002	U003	U004	U005	U006	U007	U008	U009	U010	U011	U012	U013	U014	U015	U016	U017	U018	U019	U020	U021
------	------	------	------	------	-------------	------	------	------	------	------	------	------	------	------	------	------	------	------	------	------

U006_S015.PAPER FEED UNIT:PAPER BANK:ASS'Y

U006 S015 S002
D0BX6282
SWING UNIT:PICKUP ROLLE
R:ASSY



U006 S015 S001
D0747527
SHAFT:FEED:ASS'Y

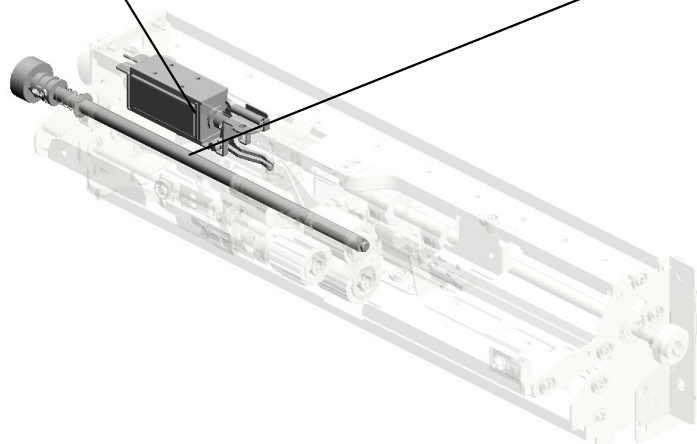

U001	U002	U003	U004	U005	U006	U007	U008	U009	U010	U011	U012	U013	U014	U015	U016	U017	U018	U019	U020	U021
------	------	------	------	------	-------------	------	------	------	------	------	------	------	------	------	------	------	------	------	------	------

U006_S016.PAPER FEED UNIT:PAPER BANK:ASS'Y

U006 S016 S002
D0BX6282
SWING UNIT:PICKUP ROLLE
R:ASSY



U006 S016 S001
D0747527
SHAFT:FEED:ASS'Y

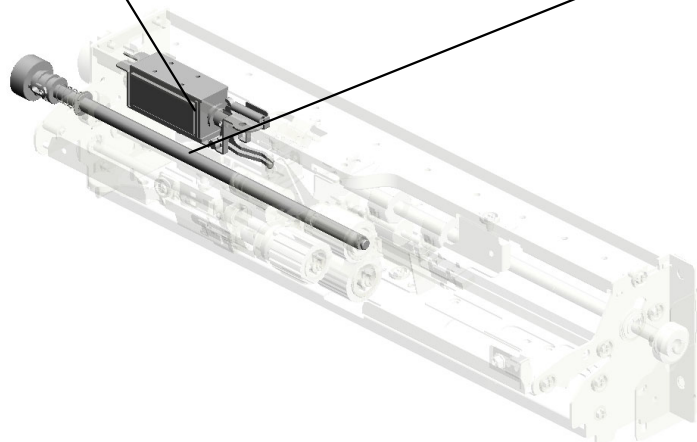

U001	U002	U003	U004	U005	U006	U007	U008	U009	U010	U011	U012	U013	U014	U015	U016	U017	U018	U019	U020	U021
------	------	------	------	------	-------------	------	------	------	------	------	------	------	------	------	------	------	------	------	------	------

U006_S017.(NA):TANDEM LCT:RIGHT:ASS'Y

U006 S017 S002
D2236722
DC SOLENOID:END FENCE:F
RONT:ASS'Y

U006 S017 S003
D2236732
DC SOLENOID:END FENCE:
REAR:ASS'Y



U006 S017 S001
B2346691
SIDE FENCE:TANDEM LCT:R
IGHT:ASS'Y

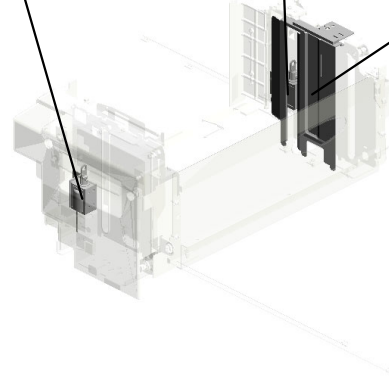

U001	U002	U003	U004	U005	U006	U007	U008	U009	U010	U011	U012	U013	U014	U015	U016	U017	U018	U019	U020	U021
------	------	------	------	------	-------------	------	------	------	------	------	------	------	------	------	------	------	------	------	------	------

U006_S018.(NA):TANDEM LCT:LEFT:ASS'Y

U006 S018 S002
D2707544
SIDE FENCE:TANDEM LCT:L
LEFT REAR:ASS'Y

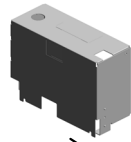

U006 S018 S001
D0747596
(NA/EU,AA,TWN,KOR):TRAY
BOTTOM PLATE:LEFT MIDDLE:ASS'Y

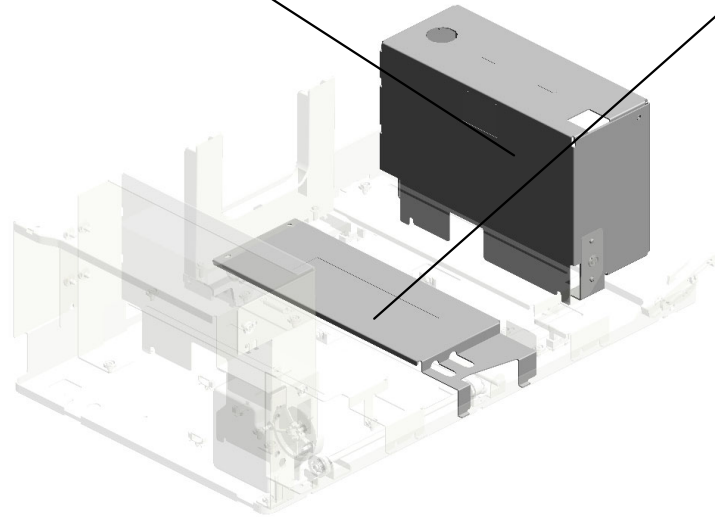

U001	U002	U003	U004	U005	U006	U007	U008	U009	U010	U011	U012	U013	U014	U015	U016	U017	U018	U019	U020	U021
------	------	------	------	------	-------------	------	------	------	------	------	------	------	------	------	------	------	------	------	------	------

U006_S019.(EU,AA,TWN,KOR):TANDEM LCT:RIGHT:ASS'Y

U006 S019 S002
D2236722
DC SOLENOID:END FENCE:F
RONT:ASS'Y

U006 S019 S003
D2236732
DC SOLENOID:END FENCE:
REAR:ASS'Y



U006 S019 S001
B2346691
SIDE FENCE:TANDEM LCT:R
IGHT:ASS'Y

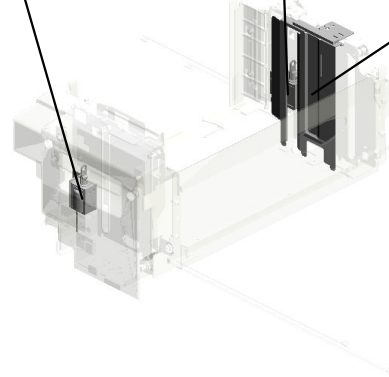

U001	U002	U003	U004	U005	U006	U007	U008	U009	U010	U011	U012	U013	U014	U015	U016	U017	U018	U019	U020	U021
------	------	------	------	------	-------------	------	------	------	------	------	------	------	------	------	------	------	------	------	------	------

U006_S020.(EU,AA,TWN,KOR):TANDEM LCT:LEFT:ASS'Y

U006 S020 S002
D2707544
SIDE FENCE:TANDEM LCT:L
LEFT REAR:ASS'Y

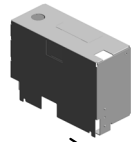

U006 S020 S001
D0747596
(NA/EU,AA,TWN,KOR):TRAY
BOTTOM PLATE:LEFT MIDDLE
REAR:ASS'Y

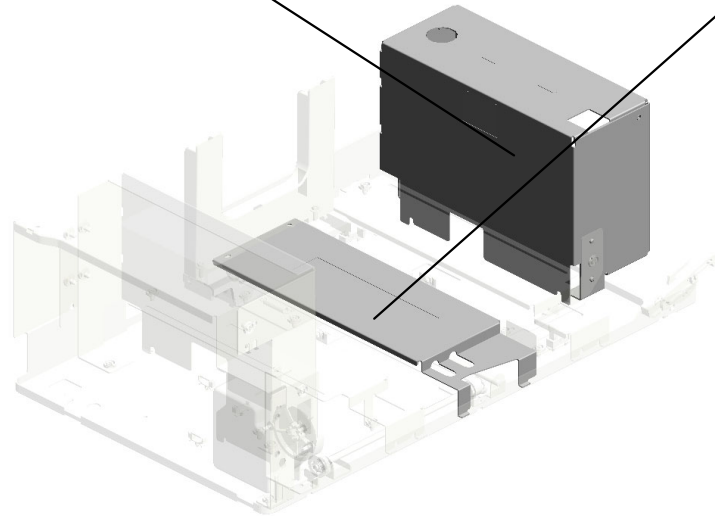
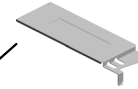

U001	U002	U003	U004	U005	U006	U007	U008	U009	U010	U011	U012	U013	U014	U015	U016	U017	U018	U019	U020	U021
------	------	------	------	------	-------------	------	------	------	------	------	------	------	------	------	------	------	------	------	------	------

U006_S021.(CHN):TANDEM LCT:RIGHT:ASS'Y

U006 S021 S003
D2236732
DC SOLENOID:END FENCE:
REAR:ASS'Y

U006 S021 S001
B2346691
SIDE FENCE:TANDEM LCT:R
IGHT:ASS'Y

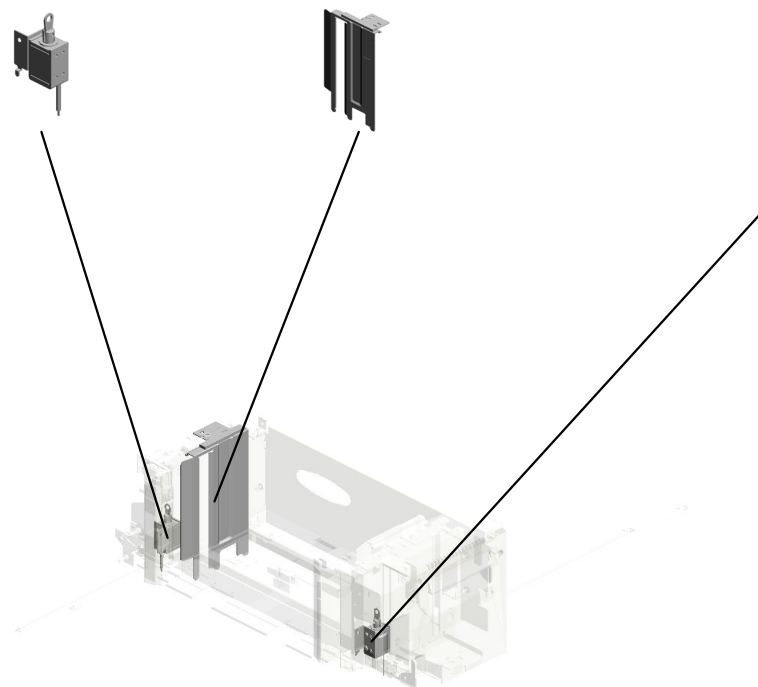

U006 S021 S002
D2236722
DC SOLENOID:END FENCE:F
RONT:ASS'Y

U001	U002	U003	U004	U005	U006	U007	U008	U009	U010	U011	U012	U013	U014	U015	U016	U017	U018	U019	U020	U021
------	------	------	------	------	-------------	------	------	------	------	------	------	------	------	------	------	------	------	------	------	------

U006_S022.(CHN):TANDEM LCT:LEFT:ASS'Y

U006 S022 S001
D2707544
SIDE FENCE:TANDEM LCT:L
LEFT REAR:ASS'Y

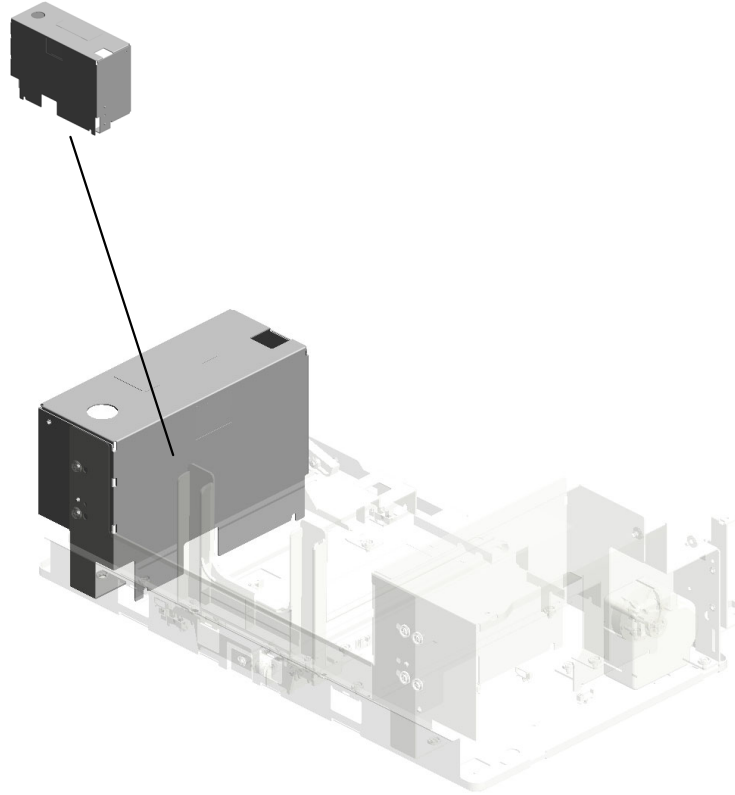

U001	U002	U003	U004	U005	U006	U007	U008	U009	U010	U011	U012	U013	U014	U015	U016	U017	U018	U019	U020	U021
------	------	------	------	------	-------------	------	------	------	------	------	------	------	------	------	------	------	------	------	------	------

U006 PAPER FEED:PAPER BANK

- 32.07200060E (x21) RETAINING RING - M6
- 34.07413708 (x6) BALL BEARING - 8 X12X3.5MM
- 36.07433808 (x6) RADIAL BALL BEA RING: DIA8XDIA16X 5 201807-03 O/O
- 29.07080080N WASHER-DIA8
- 36.07433808 (x12) RADIAL BALL BEA RING: DIA8XDIA16X 5

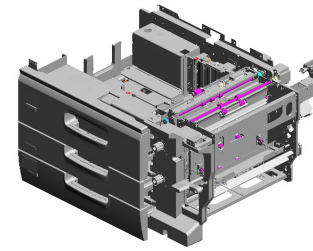

15.04514006N
(x12)
TAPPING SCREW - 4X6



17.04514010N
(x16)
TAPPING SCREW: 4X10



5.03540040N
(x2)
SCREW-M4X4



38.08025220
(x2)
TAPPING SCREW - M4X8



6.03540060N
(x15)
SCREW-M4X6

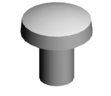

10.04503008N
(x6)
TAPPING SCREW - M3X8



31.07200040E
(x18)
RETAINING RING - M4



20.04524010N
(x9)
BINDING SELF-TAPPING SCREW: 4X 10



16.04514008N
(x73)
TAPPING SCREW: 4X8



7.03603006N
(x5)
SCREW - M3X6



37.08010237
(x3)
HEXAGONAL BOLT :DOUBLE SCREW: M4X12



13.04513006N
(x59)
TAPPING SCREW - 3X6



11.04504008N
(x18)
TAPPING SCREW - M4X8

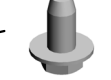

25.04544008Q
(x76)
TAPPING SCREW - M4X8



14.04513010N
(x4)
TAPPING SCREW: 3X10



39.08046123
(x2)
HEXAGONAL BOLT :W/WASHER: M3X8



47.11050487
HARNESS CLAMP



50.11050511
(x3)
HARNESS CLAMP - LWS-0306ZC

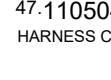

51.11050516
CLAMP

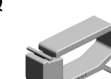

7.03603006N (x 2)
SCREW - M3X6
13.04513006N (x 4)
TAPPING SCREW - 3X6

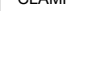

40.08050088
(x4)
RETAINING RING - M6



U006 PAPER FEED:PAPER BANK

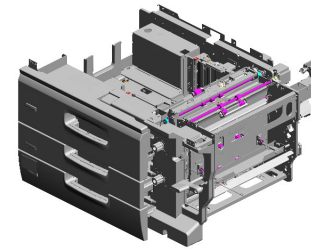

- 47.11050487 (x13) HARNESS CLAMP
- 45.09514006N (x18) SCREW:POLISHED ROUND:M4X6
- 64.A2324666 CUSHION - STEPPER MOTOR
- 60.54472681 (x4) SNAP RING
- 92.AA063694 (x2) COMPRESSION SPRING:HANDLE

- 49.11050490 (x3) HARNESS CLAMP - IWS-2218

- 51.11050516 (x11) CLAMP

- 56.11050724 CLAMPS:WES-1210

- 90.AA063268 (x2) CONNECTOR SPRING

- 54.11050692 (x12) CLAMP:LES-0503

- 50.11050511 (x19) HARNESS CLAMP - LWS-0306ZC

- 55.11050723 CLAMPS:WES-0507

- 52.11050534 (x6) CLAMP

- 41.08050089 (x4) RETAINING RING - M4

- 82.AA043325 TIMING BELT - B40 S2M250

- 91.AA063693 (x2) COMPRESSION SPRING:PRESSURE:DRIVEN ROLLER

- 81.AA043324 TIMING BELT - B40 S2M152

- 43.08053386 (x2) BUSHING - 8MM

- 59.52152621 SNAP RING - M6

- 62.67542866 (x2) ROLLER - POSITIONING GUIDE

- 16.04514008N (x4) TAPPING SCREW:4X8
- 23.04543006Q (x1) TAPPING SCREW - M3X6
- 25.04544008Q (x5) TAPPING SCREW - M4X8

U006 PAPER FEED:PAPER BANK

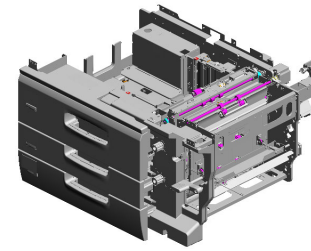

- 102.AA143550 (x2) SCREW:DIA4:M3
- 110.AA161180 (x7) CUSHION:DC STEPPER MOTOR
- 96.AA080346 (x2) BUSHING:FLANGE TYPE:DIA6
- 131.AF022165 TRANSPORT ROLLER - DRIVEN
- 98.AA084059 (x2) BALL BEARING HOLDER

99.AA132203
SPACER - 6MM

105.AA143797
(x2)
CONNECTOR GUIDE PIN

101.AA140912
(x2)
SCREW - 8X14X2.8

103.AA143569
(x4)
SCREW

140.AW500010
(x2)
PUSH SWITCH

127.AF020740
(x2)
TRANSPORT ROLLER:VERTICAL TRANSPORT:DRIVE

94.AA066667
SPRING:STRIPPER PLATE:FRONT

93.AA063695
(x8)
COMPRESSION SPRING:GRIP

106.AA143810
(x2)
DEVELOPMENT COVER SCREW

107.AA148778
(x2)
SHAFT:ARM:PLATE

116.AB017725
(x2)
GEAR/TIMING PULLEY - 20Z/20T

95.AA080265
(x2)
BUSHING:6X8X5

117.AB017726
(x2)
GEAR/TIMING PULLEY - 20Z/20T

135.AG050101
(x2)
KNOB - MISFEED REMOVAL

124.AC020153
(x3)
LENS:LED:4

U006
PAPER FEED:PAPER BANK

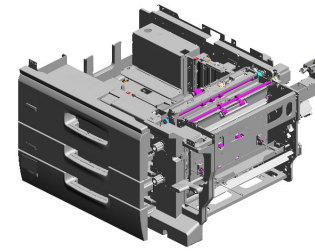

- 166.B1326764 BRACKET:CONNE
CTOR:RIGHT
- 143.AX040276 (x7)
STEPPER MOTOR:
MM56:TRANSPOR
T
- 183.B2346141 POSITIONING SLE
EVE - INNER BACK
- 198.B2346506 (x6)
TIMING PULLEY - 3
0T
- 199.B2346508 (x7)
TENSION SPRING

153.B0656769
LOCK ARM

165.B1326726
BRACKET:ARM:AS
SY

146.B0656136
(x3)
TRAY LOCK ARM

186.B2346198
COVER - SPAPER
SIZE SENSOR

141.AW500045
(x2)
PUSH SWITCH

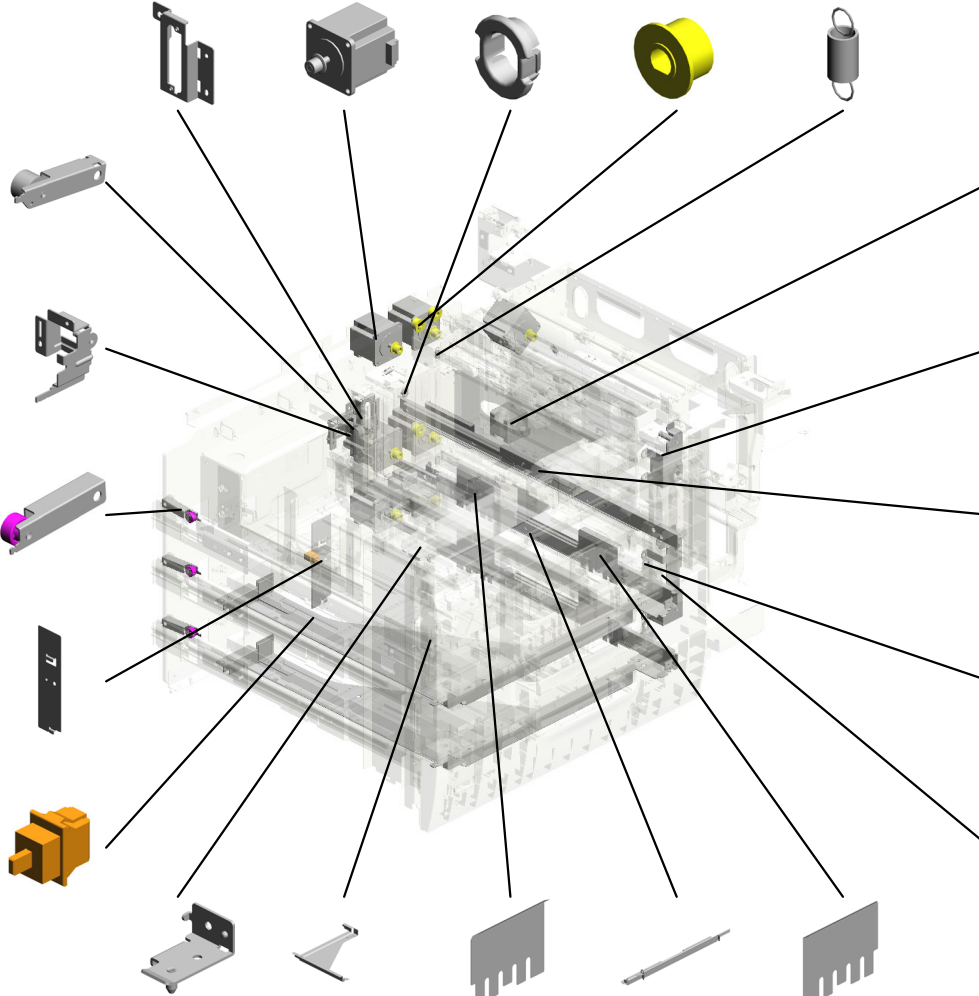

144.AX040279
STEPPER MOTOR:
PAPER TRANSPOR
T MD:MM42

193.B2346455
BRACKET - UPPER

175.B1327591
RAIL:PAPER TRAY:
ASSY

185.B2346188
(x2)
SLIDE SLEEVE PO
SITIONING

194.B2346475
BRACKET - LOWE
R

- 182.B2346120 (x2)
BRACKET:POSITIO
NING:PAPER TRAY
- 151.B0656591 (x2)
PAPER TRAY HOL
DER BASE
- 196.B2346497 (x2)
GUIDE:REAR:PAPE
R TRAY
- 184.B2346181 (x2)
GUIDE RAIL - RIGH
T
- 195.B2346495 (x2)
GUIDE:FRONT:PAP
ER TRAY

U006 PAPER FEED:PAPER BANK

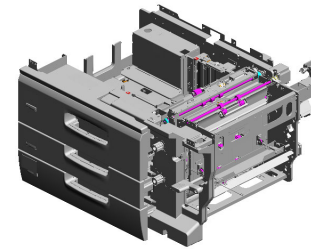

- 204.B2346533 (x3) TIMING BELT - S2 M152
- 201.B2346530 (x3) BRACKET
- 203.B2346532 (x3) TIGHTENER BRACKET
- 200.B2346514 (x3) TIMING BELT - S2 M126
- 206.B2346542 (x3) GRIP DRIVE SHAFT

- 202.B2346531 (x3) TIGHTENER BRACKET

- 235.D0596121 (x2) SPRING:CONNECTOR:TANDEM LCT

- 217.B2476753 LOCK SPRING - LARGE

- 218.B2476754 LOCK SPRING - SMALL

- 243.D0596591 (x2) SPRING:PAPER TRAY:LOCK

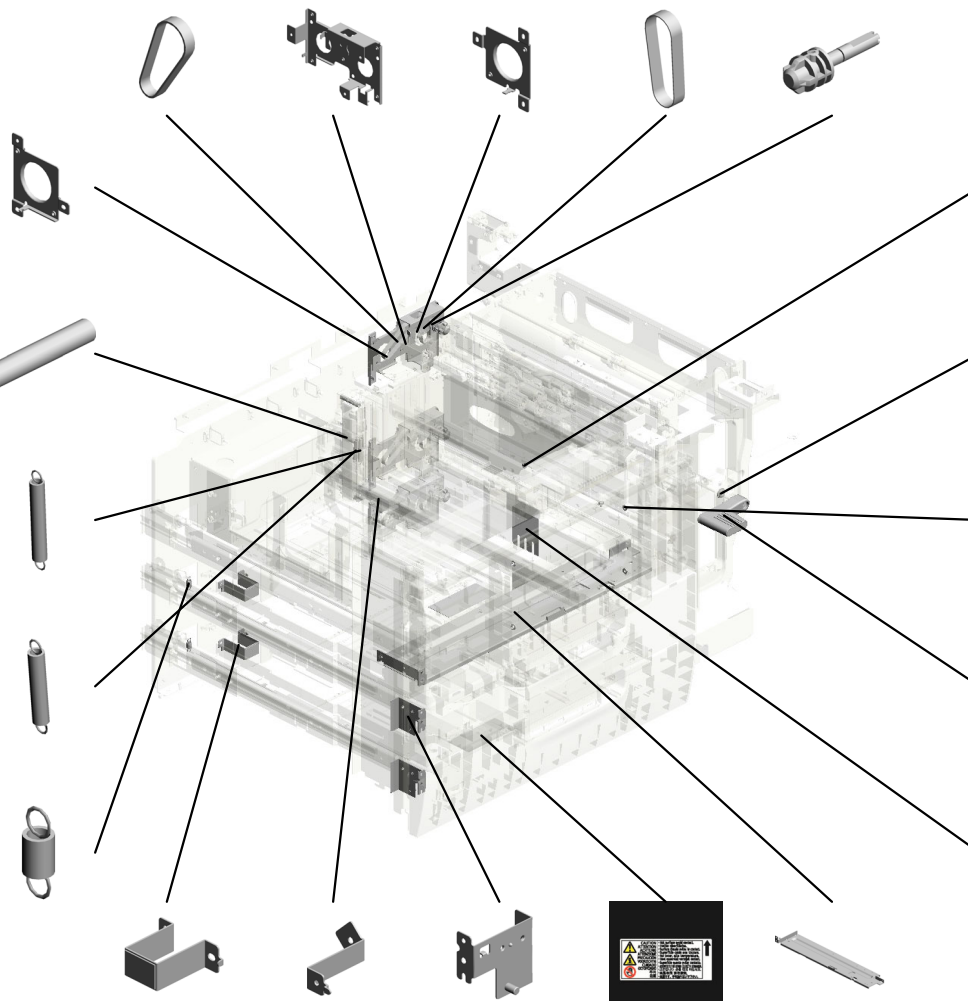

- 233.D0592399 (x2) FLANGED HEXAGONAL HEAD BOLT: M3*4

- 227.C2693566 BUSHING:MM8:PRESSURE:DRIVE

- 223.B8343312 (x4) COLLAR

- 222.B3033682 MISFEED REMOVAL KNOB

- 242.D0596496 (x2) GUIDE:MIDDLE:PAPER TRAY

- 238.D0596172 (x2) HARNESS CLAMP PAPER TRAY STOPPER
- 207.B2346565 HARNESS CLAMP BRACKET
- 237.D0596170 (x2) BRACKET:SLIDE RAIL:PAPER TRAY:2:ASSY
- 231.D0462862 (x2) (NA):DECAL:H-TEMP WARNING:HEATER
- 236.D0596169 STAY:TANDEM LC T:ASSY



U006 PAPER FEED:PAPER BANK

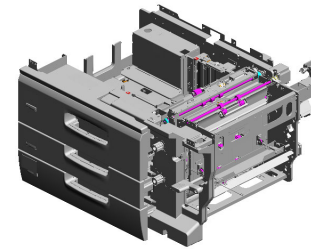

- 258.D0747333 STAY:SLIDE RAIL:LEFT FRONT:NO.1
- 254.D0743173 (x5) TIMING PULLEY:S2M:25T
- 271.D0747446 BRACKET:DC STEPPER MOTOR:TRANSPORT UNIT
- 247.D0596664 GUIDE:MIDDLE:PAPER TRAY
- 270.D0747433 (x2) STUD:HANDLE:RELEASE:ASSY

257.D0747331
STAY:SLIDE RAIL:LEFT INNER REAR:NO.1:PEEN

256.D0747330
SLIDE RAIL:LEFT:NO.1

259.D0747335
(x2)
STAY:SLIDE RAIL:LEFT:NO.2

260.D0747349
(x4)
COMPRESSION SPRING:BRACKET:SENSOR:PAPER SIZE SENSOR

253.D0626692
(x2)
SLIDE RAIL:PAPER TRAY:LEFT:SUB-ASSY

251.D0596721
(x2)
STOPPER:PAPER TRAY

267.D0747392
DECAL:PAPER TRAY:NO.1

268.D0747393
DECAL:PAPER TRAY:NO.2

278.D0747567
BRACKET:ARM:LINK:LEFT

277.D0747563
BRACKET:SLIDER:GRIP

269.D0747431
STAY:HANDLE:ASSY

261.D0747381
DECAL:VERTICAL TRANSPORT:A1

275.D0747561
GRIP:UPPER

276.D0747562
GRIP:LOWER

252.D0596725
(x2)
BRACKET:STOPPER:PAPER TRAY:RIGHT:PEEN

U006 PAPER FEED:PAPER BANK

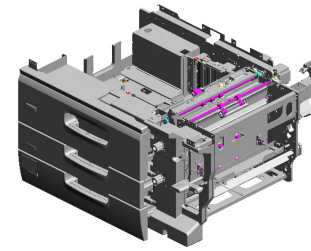

300.D1796758 SYNCHRONOUS B ELT:80S2M216
 297.D1796753 BRACKET:JOINT:PROTECT
 307.D1796768 SHAFT:JOINT:CONNECTING:ASS'Y
 299.D1796757 SHAFT:DRIVE
 298.D1796756 BRACKET:CONNECTING:JOINT

304.D1796764 SYNCHRONOUS B ELT:80S2M242

303.D1796763 SYNCHRONOUS B ELT:80S2M300

296.D1796751 BRACKET:STM:MM56:TRANSPORT:LENGTHWISE

302.D1796762 SYNCHRONOUS B ELT:60S2M166

286.D1316511 BRACKET:CONNECTOR:LEFT

290.D1796726 (x3) COVER:LED:MAIN
 289.D1796643 RAIL:TANDEM LCT:MIDDLE:ASS'Y
 282.D0747603 (x2) PLATE:GRIP:PAPER TRAY:NO.2
 284.D0747607 (x2) ARM:PAPER TRAY:GRIP
 283.D0747606 (x2) GRIP:PAPER TRAY:NO.2

305.D1796765 TRANSPORT ROLLER:VERTICAL TRANSPORT:DRIVE:EXIT

309.D1796775 GUIDE PLATE:OPEN AND CLOSE:VERTICAL TRANSPORT:UPPER

306.D1796766 TRANSPORT ROLLER:VERTICAL TRANSPORT:DRIVE:CONNECTING

301.D1796761 SYNCHRONOUS B ELT:60S2M226

279.D0747573 (x2) BRACKET:ARM:PLATE

U006 PAPER FEED:PAPER BANK

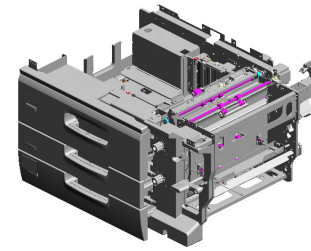

- 316.D1796797 COMPRESSION SPRING:JOINT:TRANSPORT
- 310.D1796777 TORSION SPRING:GUIDE PLATE:OPEN AND CLOSE:UPPER
- 312.D1796783 GUIDE PLATE:VERTICAL TRANSPORT:F1:LOWER
- 315.D1796790 GUIDE PLATE:VERTICAL TRANSPORT:F2:LOWER
- 311.D1796781 GUIDE PLATE:VERTICAL TRANSPORT:F1

313.D1796784
GUIDE PLATE:VERTICAL TRANSPORT:F3

326.D1797550
COVER:PAPER TRAY:NO.1:UPPER

329.D1797564
BRACKET:SLIDER:GRIP:UPPER

324.D1797540
(x8)
SCREW:DIA6:M4X3:ADHESIVE

327.D1797561
ARM:LINK:LEFT

320.D1797519
(x2)
BRACKET:STOPPER:PAPER TRAY

319.D1797518
(x2)
SHAFT:STOPPER:PAPER TRAY

317.D1797512
COVER:PAPER TRAY:NO.2

318.D1797513
COVER:PAPER TRAY:NO.3

331.D1797573
BRACKET:ARM:UNLOCK

328.D1797562
ARM:LINK:RIGHT

330.D1797566
BRACKET:ARM:LINK:RIGHT

334.D1797579
COVER:GRIP:INNER BACK

323.D1797533
(x2)
JOINT:LINK:UNLOCK:PEEN

333.D1797576
(x2)
ARM:LINK:UNLOCK

U006 PAPER FEED:PAPER BANK

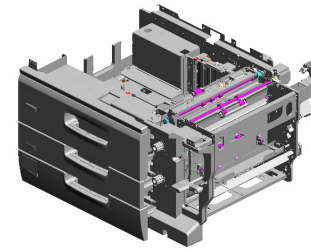

- 378.G1784912 (x5) PULLEY:S2M:30T
- 371.D3553844 (x4) SHOE:HANDLE:RE LEASE
- 380.GW010007 (x4) PHOTO REFLECTI ON SENSOR:EXIT
- 383.11050760 (x2) CLAMP:LWSM-051 1A 202310-01
- 385.D2706453 (x2) SHAFT:MISFEED R EMOVAL 201805-02 O/O

340.D1947346
DC MOTOR:RISE:T ANDEM LCT:ASSY: 19.2W:BRUSH



335.D1797581
STAY:COVER:TAN DEM LCT



364.D2707531
COVER:PAPER TR AY:NO.1



362.D2706725
COVER:GUARD:HA RNESS

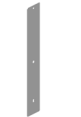

374.D5165200 (x6) PCB:LED:ASSY



337.D1797591 (x3) PLATE:TRANSPAR ENT:LED



339.D1797597 (x3) COVER:LED



373.D5161326
DECAL:PAPER TR AY:DESIGN SKETC H:3



338.D1797596 (x3) DIFFUSION PLATE: LED

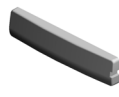

393.B0656589 (x2) LEFT SUPPORT PL ATE



349.D2416290 (x3) LED:RED



350.D2701570
DECAL:A2/A3

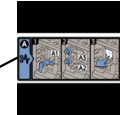

336.D1797586
STOPPER:TANDE M LCT



394.D2707574
SHAFT:ARM:UN LO CK 201902-05 O/O



383.11050760 (x4) CLAMP:LWSM-051 1A 202310-02 O/O

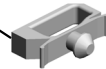

U006
PAPER FEED:PAPER BANK

413.AA043737 412.D0BX6786
TIMING BELT:60S2 GUIDE PLATE:VER
M188 TICAL TRANSPOR
202003-02 O/O T:F2:PEEN
202002-01 X/O

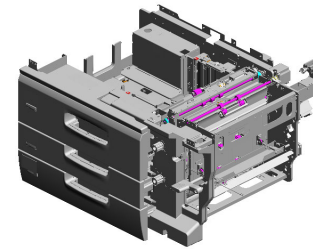

397.D0BX6648
COIL SPRING:TAN
DEM TRAY:LOCK
201903-03 O/O

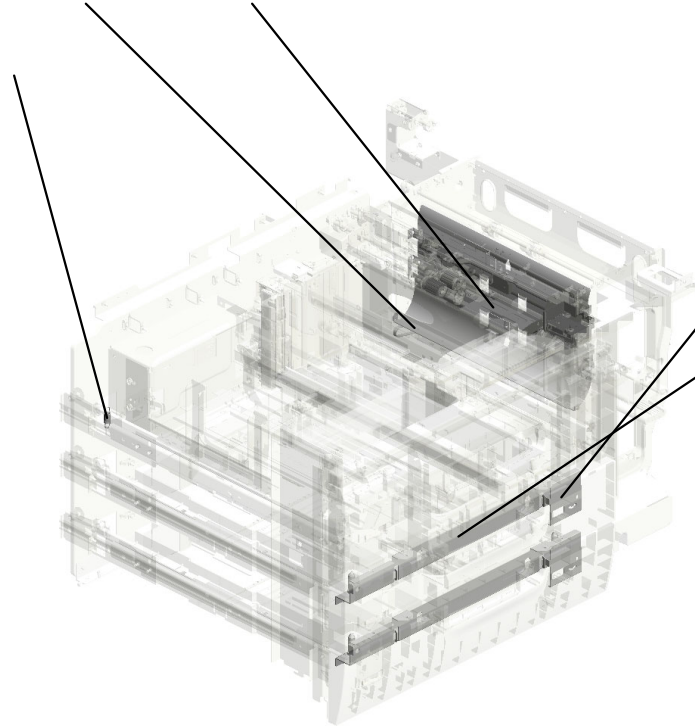

404.D1796626
(x2)
SUPPORTING PLA
TE:RIGHT:HOLDER
:PAPER TRAY



403.D1796619
(x2)
STAY:HOLDER:PA
PER TRAY:ASS'Y

U006_S001
PAPER TRAY:UNIVERSAL:SUB-ASS'Y

230.D0146785 SPRING PLATE:AR
M:END FENCE:LO
CK
126.AF017033 END FENCE
178.B1816780 LINK:END FENCE:
PAPER SIZE SENS
OR:ASS'Y
179.B1816789 LINK:SIDE FENCE:
PAPER SIZE SENS
OR
168.B1326797 SIDE FENCE:REAR
:AUXILIARY

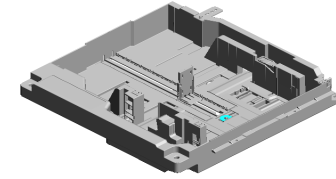

406.D0BX7631
[A]
PAPER TRAY:UNIV
ERSAL:SUB-ASS'Y
201907-14 X/O

150.B0656545
(x2)
DECAL - POSITION
ING

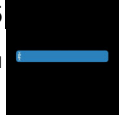

343.D1947635
ARM:END FENCE:L
OCK



266.D0747390
DECAL:PAPER SE
T DIRECTION:PAP
ER TRAY



229.D0146784
SPRING PLATE:EN
D FENCE



169.B1326798
SPRING PLATE:PA
PER TRAY:EARTH



88.AA060961
TENSION SPRING:
SIDE FENCE:REAR



32.07200060E
(x2)
RETAINING RING -
M6



11.04504008N
(x3)
TAPPING SCREW -
M4X8



113.AB012327
GEAR:16Z



216.B2476695
GUIDE:MISFEED R
EMOVAL:PAPER T
RAY



197.B2346498
(x2)
SHEET:TRAY BOT
TOM PLATE



148.B0656524
BOTTOM PLATE LI
FT SHAFT



8.03604008N
(x2)
SCREW - M4X8



149.B0656526
LIFT LEVER

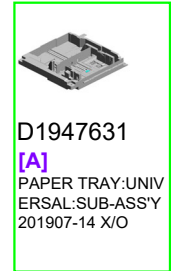
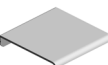

D1947631
[A]
PAPER TRAY:UNIV
ERSAL:SUB-ASS'Y
201907-14 X/O

U006_S001_S001
TRAY BOTTOM PLATE:ASS'Y

396.AF013029
PAD:BASE
201903-01 X/O

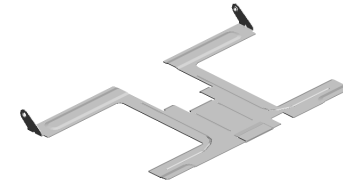
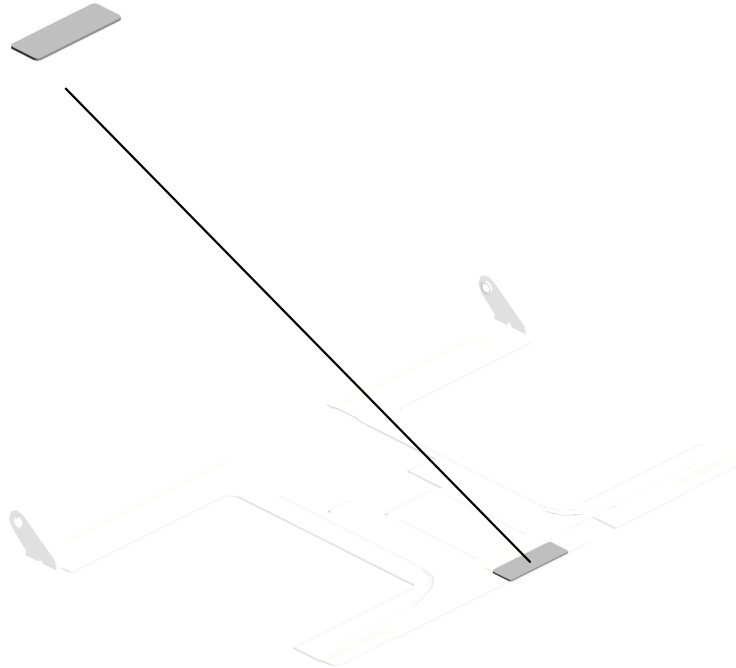

401.D0BX6780
[A]
TRAY BOTTOM PL
ATE:ASS'Y
201904-01 X/O

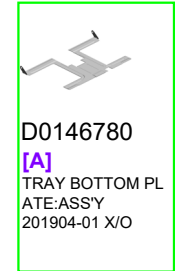

D0146780
[A]
TRAY BOTTOM PL
ATE:ASS'Y
201904-01 X/O

U001	U002	U003	U004	U005	U006	U007	U008	U009	U010	U011	U012	U013	U014	U015	U016	U017	U018	U019	U020	U021
------	------	------	------	------	-------------	------	------	------	------	------	------	------	------	------	------	------	------	------	------	------

U006_S001_S002
SIDE FENCE:REAR:ASS'Y

69.A2672857 78.AA001597
SPRING PLATE - SI DE FENCE DECAL:SIDE FENCE:REAR

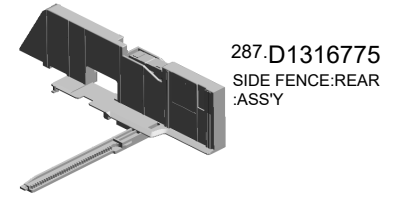

70.A2672859
SIDE FENCE STOP PER

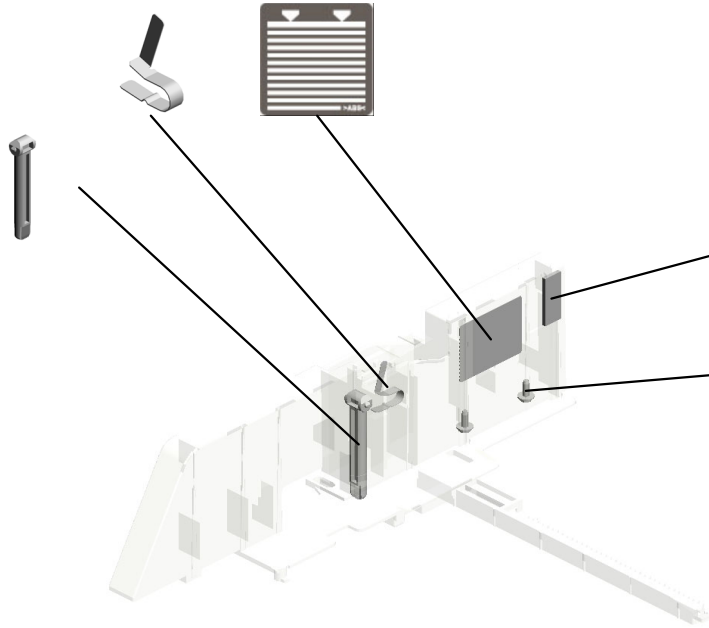

181.B2342864
PAD:CLEANER

10.04503008N
(x2)
TAPPING SCREW - M3X8

U001	U002	U003	U004	U005	U006	U007	U008	U009	U010	U011	U012	U013	U014	U015	U016	U017	U018	U019	U020	U021
------	------	------	------	------	-------------	------	------	------	------	------	------	------	------	------	------	------	------	------	------	------

U006_S001_S003
SIDE FENCE:FRONT:ASS'Y

167.B1326791 181.B2342864
(x2) PAD:CLEANER
PLATE:SIDE FENCE

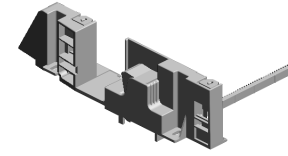

288.D1316777
SIDE FENCE:FRONT:
T:ASS'Y

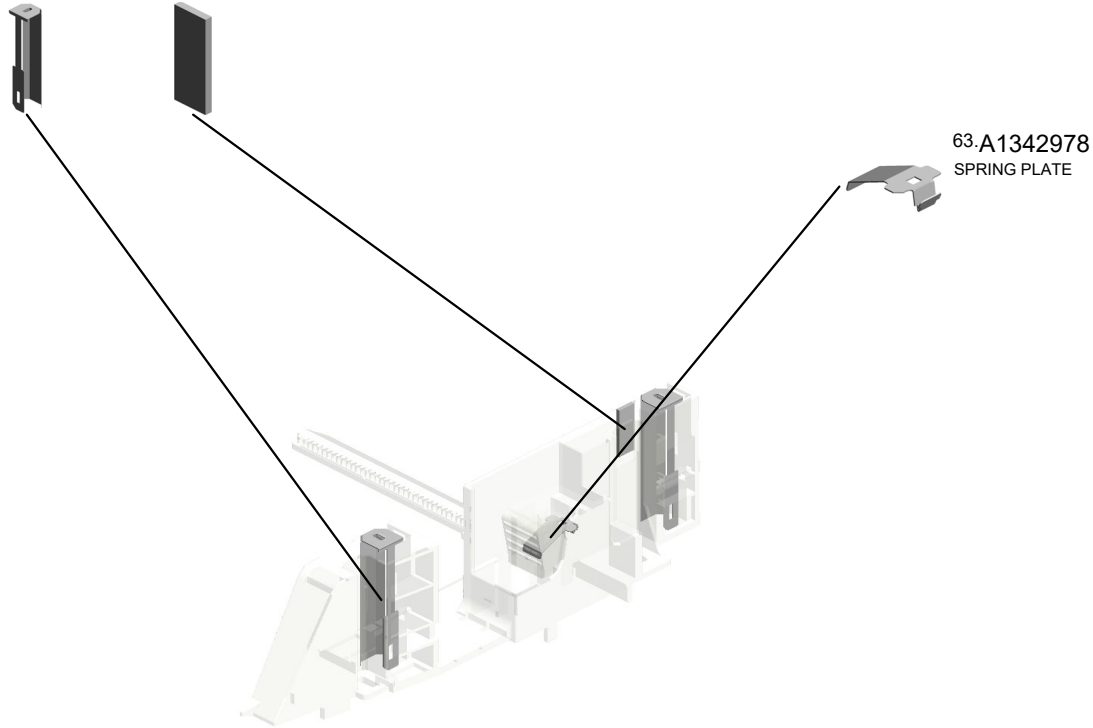

U001	U002	U003	U004	U005	U006	U007	U008	U009	U010	U011	U012	U013	U014	U015	U016	U017	U018	U019	U020	U021
------	------	------	------	------	-------------	------	------	------	------	------	------	------	------	------	------	------	------	------	------	------

U006_S002
PAPER TRAY:UNIVERSAL:SUB-ASS'Y

230.D0146785 SPRING PLATE:AR
M:END FENCE:LO
CK
126.AF017033 END FENCE
178.B1816780 LINK:END FENCE:
PAPER SIZE SENS
OR:ASS'Y
179.B1816789 LINK:SIDE FENCE:
PAPER SIZE SENS
OR
168.B1326797 SIDE FENCE:REAR
:AUXILIARY

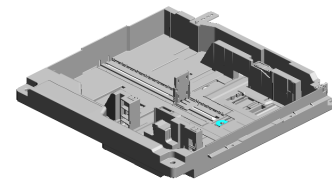

406.D0BX7631
[A]
PAPER TRAY:UNIV
ERSAL:SUB-ASS'Y
201907-14 X/O

150.B0656545
(x2)
DECAL - POSITION
ING



343.D1947635
ARM:END FENCE:L
OCK



266.D0747390
DECAL:PAPER SE
T DIRECTION:PAP
ER TRAY



229.D0146784
SPRING PLATE:EN
D FENCE



169.B1326798
SPRING PLATE:PA
PER TRAY:EARTH



88.AA060961
TENSION SPRING:
SIDE FENCE:REAR



32.07200060E
(x2)
RETAINING RING -
M6



11.04504008N
(x3)
TAPPING SCREW -
M4X8



113.AB012327
GEAR:16Z



216.B2476695
GUIDE:MISFEED R
EMOVAL:PAPER T
RAY



197.B2346498
(x2)
SHEET:TRAY BOT
TOM PLATE



148.B0656524
BOTTOM PLATE LI
FT SHAFT



8.03604008N
(x2)
SCREW - M4X8



149.B0656526
LIFT LEVER

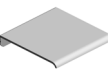

D1947631
[A]
PAPER TRAY:UNIV
ERSAL:SUB-ASS'Y
201907-14 X/O

U006_S002_S001
TRAY BOTTOM PLATE:ASS'Y

396.AF013029
PAD:BASE
201903-01 X/O

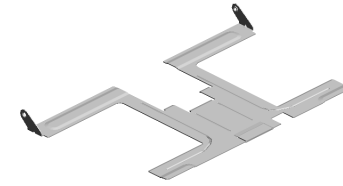
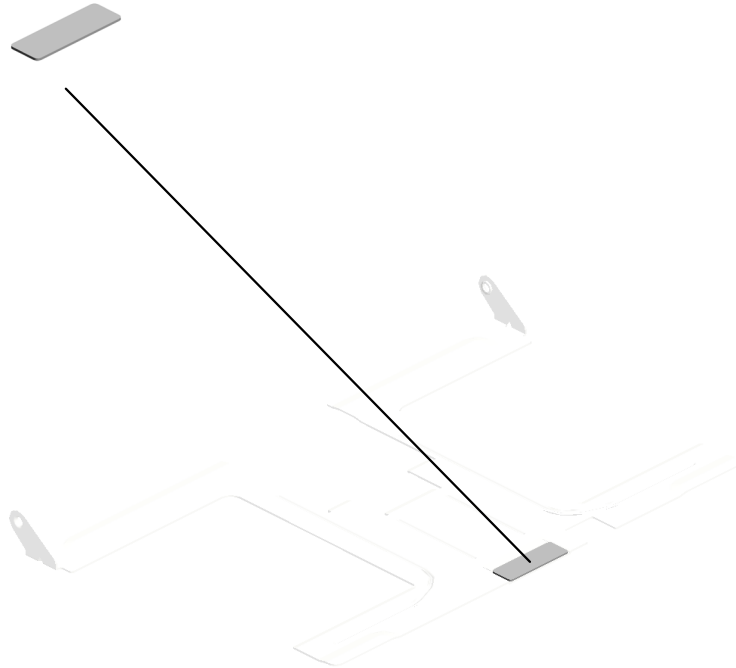

401.D0BX6780
[A]
TRAY BOTTOM PL
ATE:ASS'Y
201904-01 X/O

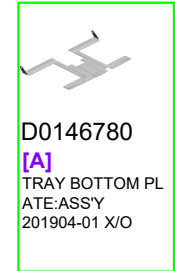

D0146780
[A]
TRAY BOTTOM PL
ATE:ASS'Y
201904-01 X/O

U001	U002	U003	U004	U005	U006	U007	U008	U009	U010	U011	U012	U013	U014	U015	U016	U017	U018	U019	U020	U021
------	------	------	------	------	-------------	------	------	------	------	------	------	------	------	------	------	------	------	------	------	------

U006_S002_S002
SIDE FENCE:REAR:ASS'Y

69.A2672857 78.AA001597
SPRING PLATE - SI DE FENCE DECAL:SIDE FENCE:REAR

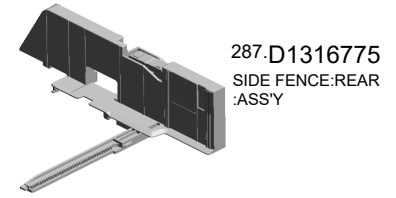

70.A2672859
SIDE FENCE STOP PER

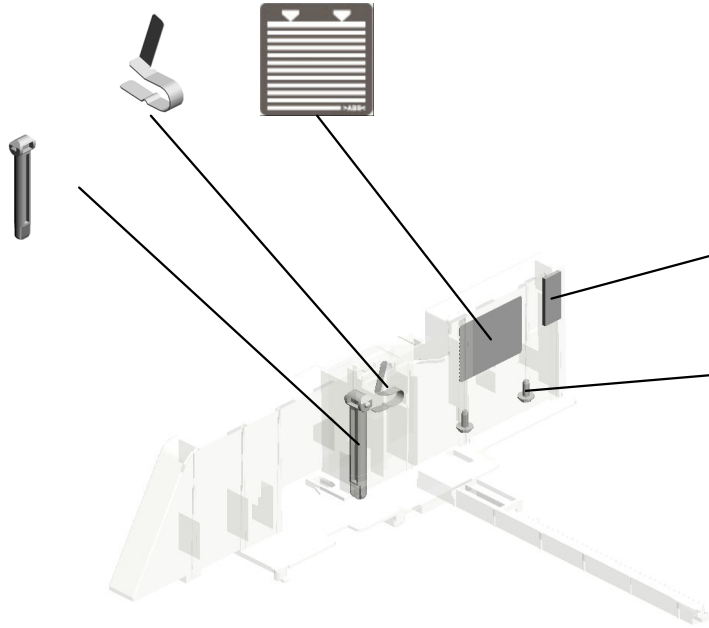

181.B2342864
PAD:CLEANER

10.04503008N
(x2)
TAPPING SCREW - M3X8

U001	U002	U003	U004	U005	U006	U007	U008	U009	U010	U011	U012	U013	U014	U015	U016	U017	U018	U019	U020	U021
------	------	------	------	------	-------------	------	------	------	------	------	------	------	------	------	------	------	------	------	------	------

U006_S002_S003
SIDE FENCE:FRONT:ASS'Y

167.B1326791 181.B2342864
(x2) PAD:CLEANER
PLATE:SIDE FENCE

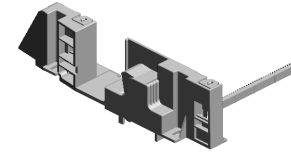

288.D1316777
SIDE FENCE:FRONT:
T:ASS'Y

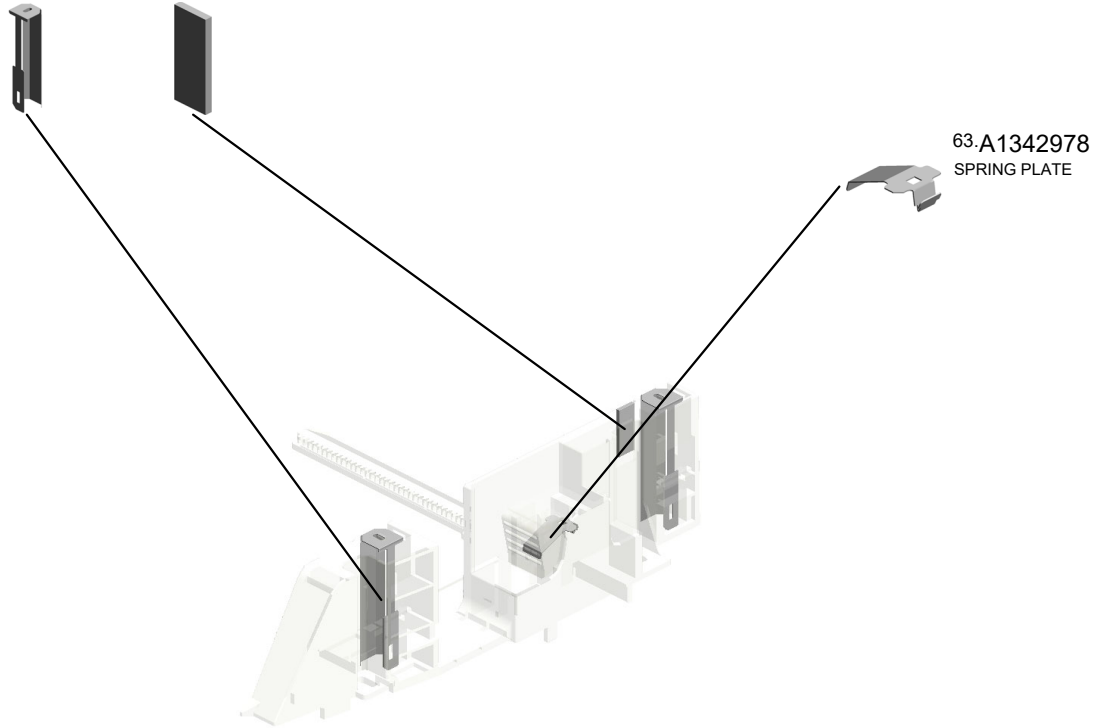

U001	U002	U003	U004	U005	U006	U007	U008	U009	U010	U011	U012	U013	U014	U015	U016	U017	U018	U019	U020	U021
------	------	------	------	------	-------------	------	------	------	------	------	------	------	------	------	------	------	------	------	------	------

U006_S003
(NA):HEAT SINK:HEATER:LOWER:ASS'Y

51.11050516 145.AX400178
CLAMP (NA):HEATER:240V
:18W:UPPER

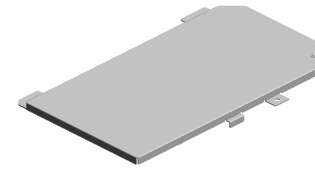

177.B1406226
(NA):HEAT SINK:H
EATER:LOWER:AS
SY

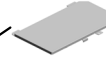

176.B1406221
HEAT SINK:HEATE
R:LOWER:SUB-AS
SY

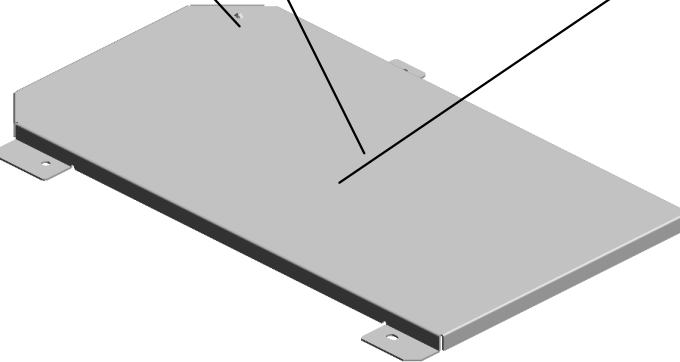

U001	U002	U003	U004	U005	U006	U007	U008	U009	U010	U011	U012	U013	U014	U015	U016	U017	U018	U019	U020	U021
------	------	------	------	------	-------------	------	------	------	------	------	------	------	------	------	------	------	------	------	------	------

U006_S004
(NA):HEAT SINK:HEATER:UPPER:ASS'Y

55.11050723 51.11050516
CLAMPS:WES-050 (x2)
7 CLAMP



285.D0747681
(NA):HEAT SINK:H
EATER:UPPER:AS
SY

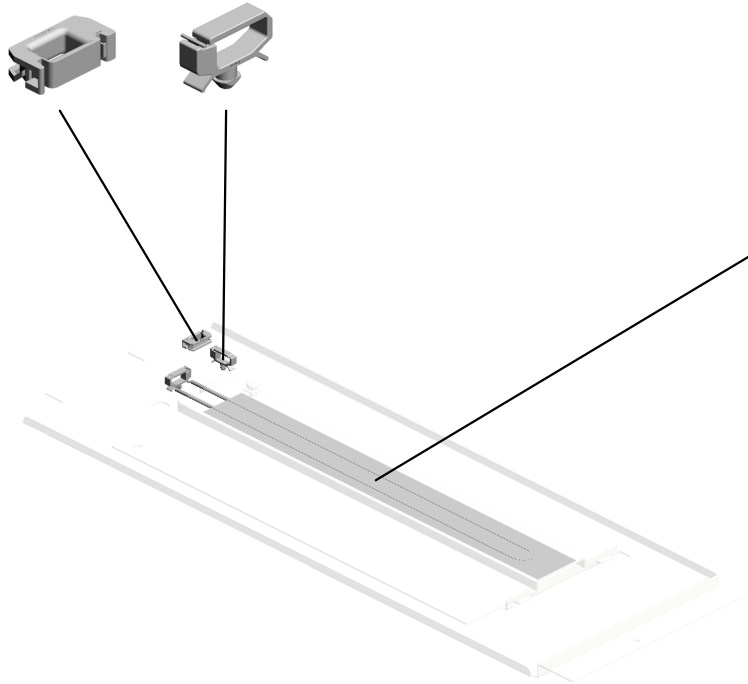

145.AX400178
(NA):HEATER:240V
:18W:UPPER

U001	U002	U003	U004	U005	U006	U007	U008	U009	U010	U011	U012	U013	U014	U015	U016	U017	U018	U019	U020	U021
------	------	------	------	------	-------------	------	------	------	------	------	------	------	------	------	------	------	------	------	------	------

U006_S005
STOPPER:REGISTRATION:TANDEM LCT:ASS'Y

16.04514008N
TAPPING SCREW:
4X8

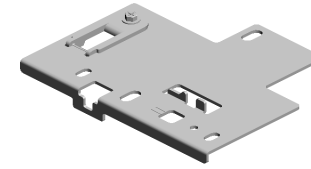

321.D1797525
STOPPER:REGIST
RATION:TANDEM L
CT:ASS'Y



322.D1797528
CAP:STOPPER:RE
GISTRATION

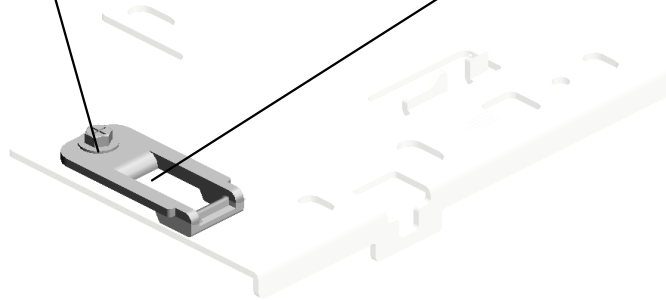

U001	U002	U003	U004	U005	U006	U007	U008	U009	U010	U011	U012	U013	U014	U015	U016	U017	U018	U019	U020	U021
------	------	------	------	------	-------------	------	------	------	------	------	------	------	------	------	------	------	------	------	------	------

U006_S006
DC MOTOR:RISING TRAY:ASS'Y

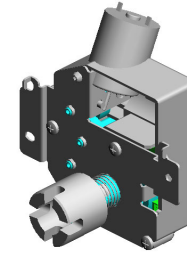

142:AX040199
DC MOTOR:RISING
TRAY:ASS'Y

19:04523010N(x 4)
BINDING SELF-TAPPING SCREW:3X10

U001	U002	U003	U004	U005	U006	U007	U008	U009	U010	U011	U012	U013	U014	U015	U016	U017	U018	U019	U020	U021
------	------	------	------	------	------	------	------	------	------	------	------	------	------	------	------	------	------	------	------	------

U006_S007
DC MOTOR:RISING TRAY:ASS'Y

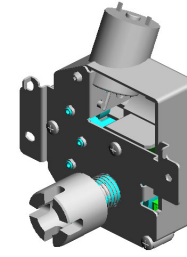

142:AX040199
DC MOTOR:RISING
TRAY:ASS'Y

19:04523010N(x 4)
BINDING SELF-TAPPING SCREW:3X10

U001	U002	U003	U004	U005	U006	U007	U008	U009	U010	U011	U012	U013	U014	U015	U016	U017	U018	U019	U020	U021
------	------	------	------	------	------	------	------	------	------	------	------	------	------	------	------	------	------	------	------	------

U006_S008
SHAFT:DRIVE:FEED:ASS'Y

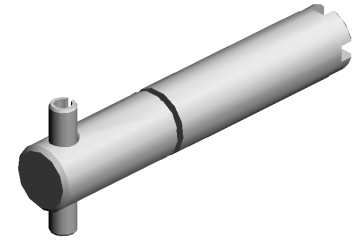

386.D2706541
[A]
SHAFT:DRIVE:FEE
D:ASS'Y
201805-03 O/O



B2346541
[A]
FEED DRIVE SHAF
T
201805-03 O/O

U001	U002	U003	U004	U005	U006	U007	U008	U009	U010	U011	U012	U013	U014	U015	U016	U017	U018	U019	U020	U021
------	------	------	------	------	------	------	------	------	------	------	------	------	------	------	------	------	------	------	------	------

U006_S009
SHAFT:DRIVE:FEED:ASS'Y

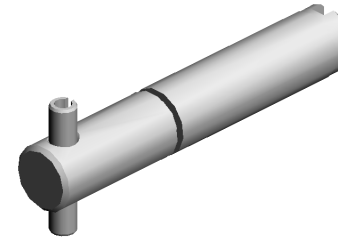

386.D2706541
[A]
SHAFT:DRIVE:FEE
D:ASS'Y
201805-03 O/O



B2346541
[A]
FEED DRIVE SHAF
T
201805-03 O/O

U001	U002	U003	U004	U005	U006	U007	U008	U009	U010	U011	U012	U013	U014	U015	U016	U017	U018	U019	U020	U021
------	------	------	------	------	------	------	------	------	------	------	------	------	------	------	------	------	------	------	------	------

U006_S010
SHAFT:DRIVE:FEED:ASS'Y

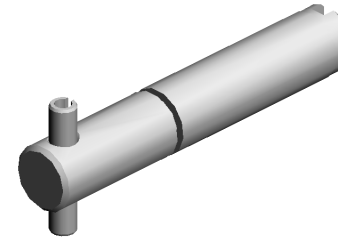

386.D2706541
[A]
SHAFT:DRIVE:FEE
D:ASS'Y
201805-03 O/O



B2346541
[A]
FEED DRIVE SHAF
T
201805-03 O/O

U001	U002	U003	U004	U005	U006	U007	U008	U009	U010	U011	U012	U013	U014	U015	U016	U017	U018	U019	U020	U021
------	------	------	------	------	------	------	------	------	------	------	------	------	------	------	------	------	------	------	------	------

U006_S011
DC SOLENOID:LOCK:ASS'Y

1.03130040N 10.04503008N
SCREW:M3X4 TAPPING SCREW -
M3X8

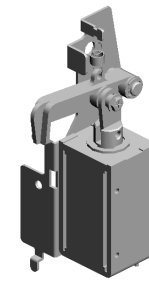

344.D2236231
DC SOLENOID:LO
CK:ASS'Y

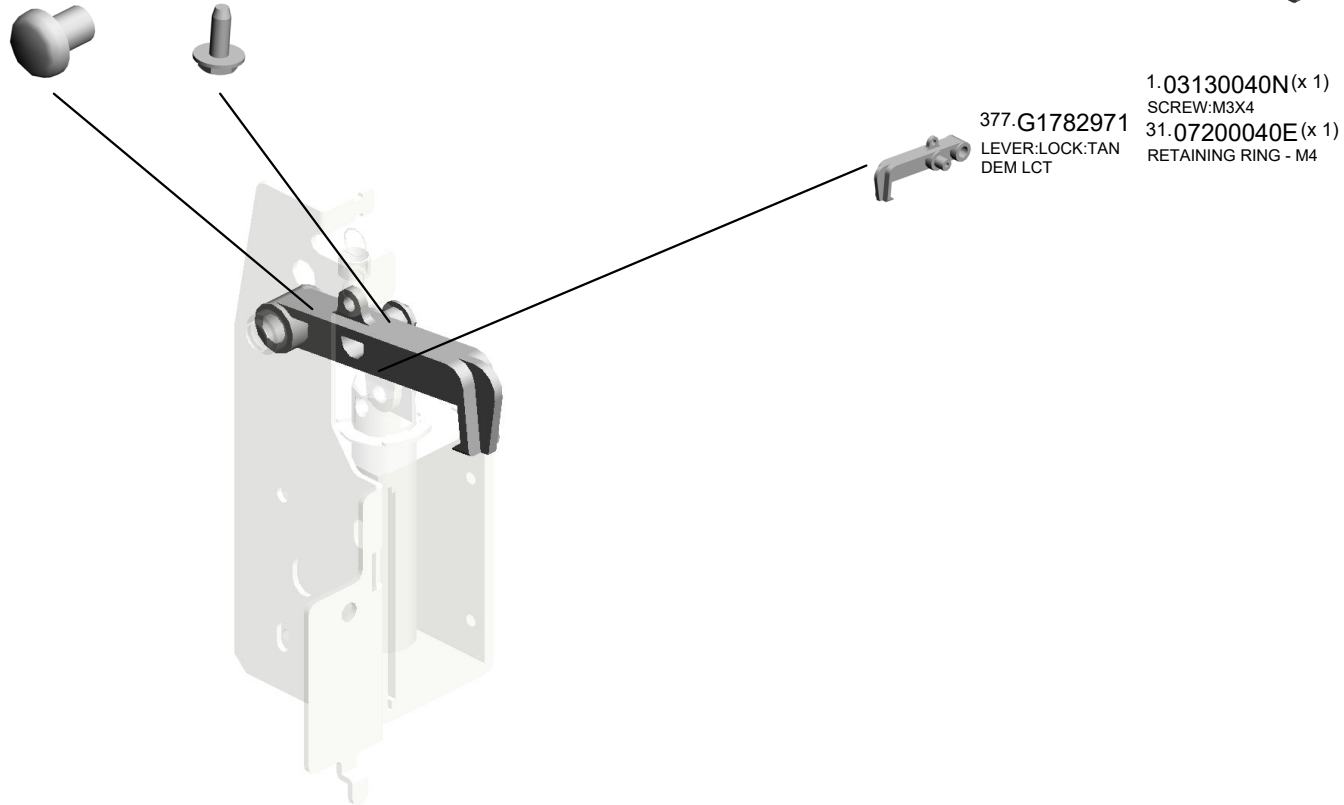

U001	U002	U003	U004	U005	U006	U007	U008	U009	U010	U011	U012	U013	U014	U015	U016	U017	U018	U019	U020	U021
------	------	------	------	------	-------------	------	------	------	------	------	------	------	------	------	------	------	------	------	------	------

U006_S012
DC SOLENOID:COUPLING:ASS'Y

31.07200040E
RETAINING RING -
M4

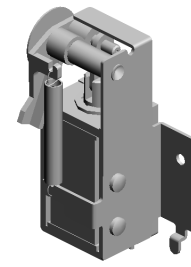
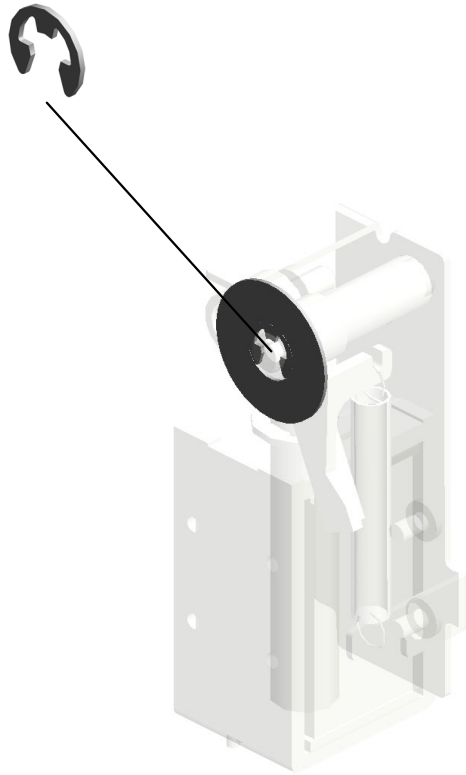

345.D2236233
DC SOLENOID:CO
UPLING:ASS'Y

U001	U002	U003	U004	U005	U006	U007	U008	U009	U010	U011	U012	U013	U014	U015	U016	U017	U018	U019	U020	U021
------	------	------	------	------	-------------	------	------	------	------	------	------	------	------	------	------	------	------	------	------	------

U006_S013

GUIDE PLATE:OPEN AND CLOSE:VERTICAL TRANSPORT:LOWER:ASS'Y

131.AF022165 (x3) TRANSPORT ROLLER - DRIVEN
98.AA084059 (x6) BALL BEARING HOLDER
91.AA063693 (x6) COMPRESSION SPRING:PRESSURE-DRIVEN ROLLER

30.07200030E (x2) RETAINING RING - M3

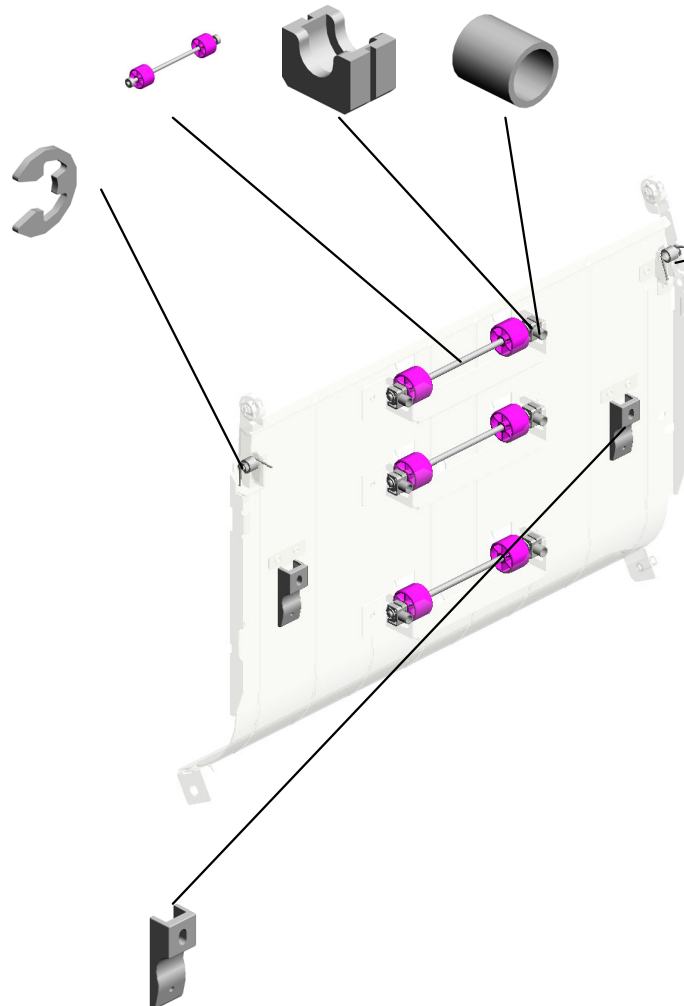

392.D0BX6795 (x2) HOLDER:STAY:GUIDE PLATE 201901-02 O/O

372.D3553858 (x2) TORSION SPRING:GUIDE PLATE:16N

16.04514008N (x2) TAPPING SCREW:4X8

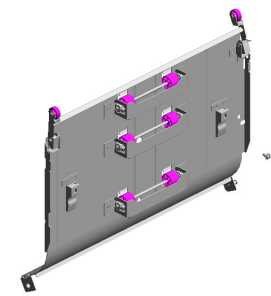

415.D0BX6771

[A] GUIDE PLATE:OPEN AND CLOSE:VERTICAL TRANSPORT:LOWER:ASS'Y 202110-02 O/O

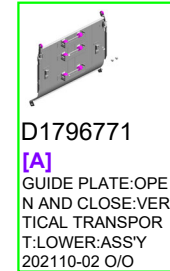

D1796771

[A] GUIDE PLATE:OPEN AND CLOSE:VERTICAL TRANSPORT:LOWER:ASS'Y 202110-02 O/O

U001	U002	U003	U004	U005	U006	U007	U008	U009	U010	U011	U012	U013	U014	U015	U016	U017	U018	U019	U020	U021
------	------	------	------	------	-------------	------	------	------	------	------	------	------	------	------	------	------	------	------	------	------

U006_S013_S001
BRACKET:DETENT:RIGHT:ASS'Y

30.07200030E 367.D3551196
(x2) ROLLER:DETENT
RETAINING RING -
M3

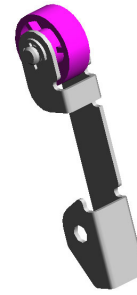
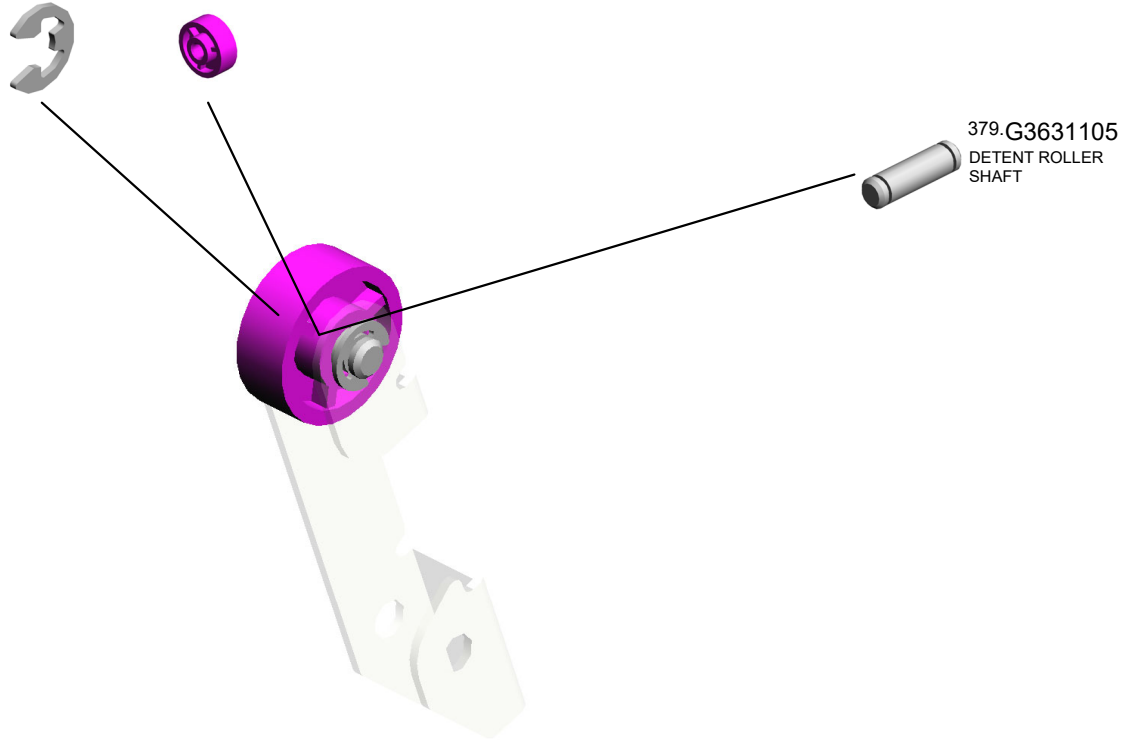

368.D3553810
BRACKET:DETENT
:RIGHT:ASS'Y

U001	U002	U003	U004	U005	U006	U007	U008	U009	U010	U011	U012	U013	U014	U015	U016	U017	U018	U019	U020	U021
------	------	------	------	------	-------------	------	------	------	------	------	------	------	------	------	------	------	------	------	------	------

U006_S013_S002
BRACKET:DETENT:ASS'Y

367.D3551196 379.G3631105
ROLLER:DETENT DETENT ROLLER
SHAFT



370.D3553840
BRACKET:DETENT
:ASS'Y

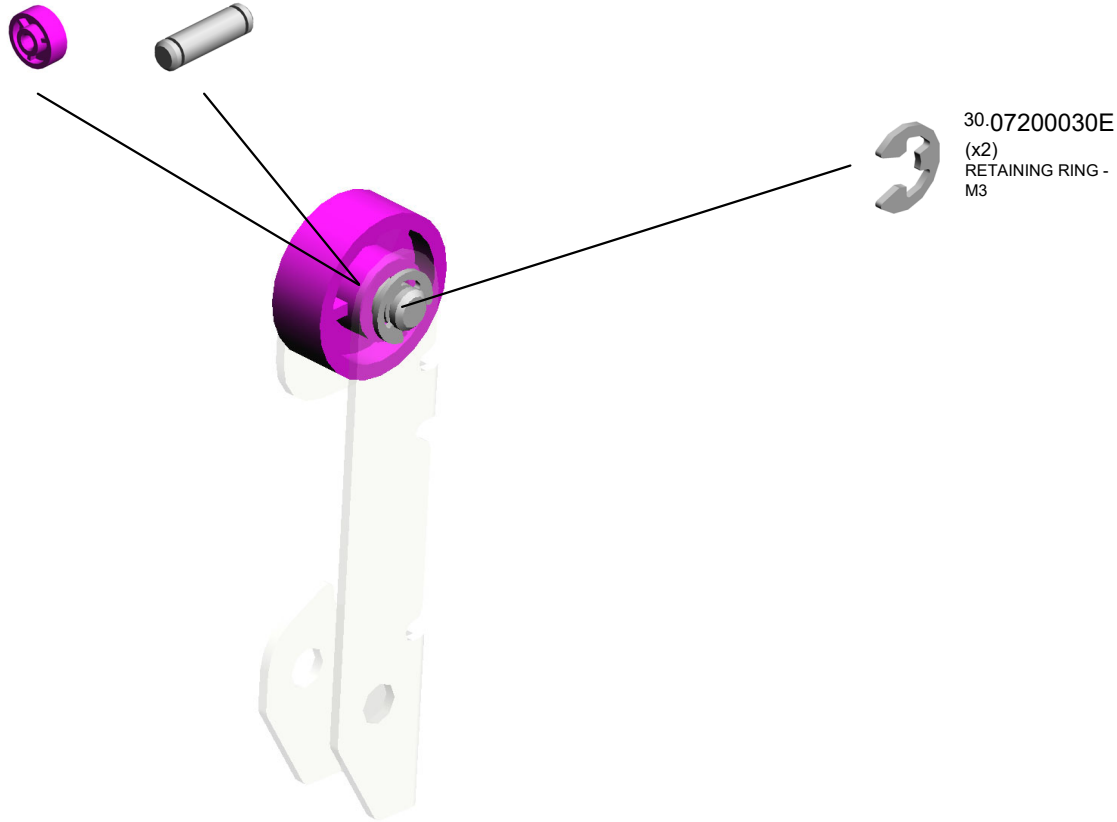

U001	U002	U003	U004	U005	U006	U007	U008	U009	U010	U011	U012	U013	U014	U015	U016	U017	U018	U019	U020	U021
------	------	------	------	------	-------------	------	------	------	------	------	------	------	------	------	------	------	------	------	------	------

U006_S014
PAPER FEED UNIT:PAPER BANK:ASS'Y

- 36.07433808 (x2) RADIAL BALL BEARING: DIA8XDIA16X5 201807-03 O/O
- 112.AB011591 GEAR: REVERSE
- 40.08050088 (x2) RETAINING RING - M6
- 84.AA060523 PICK-UP PRESSURE SPRING
- 9.04340060N (x3) PAN SELF-TAPPING SCREW: M4X6

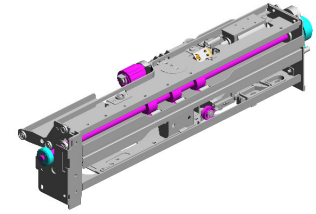

382.D2706628
PAPER FEED UNIT
:PAPER BANK:ASS'
Y

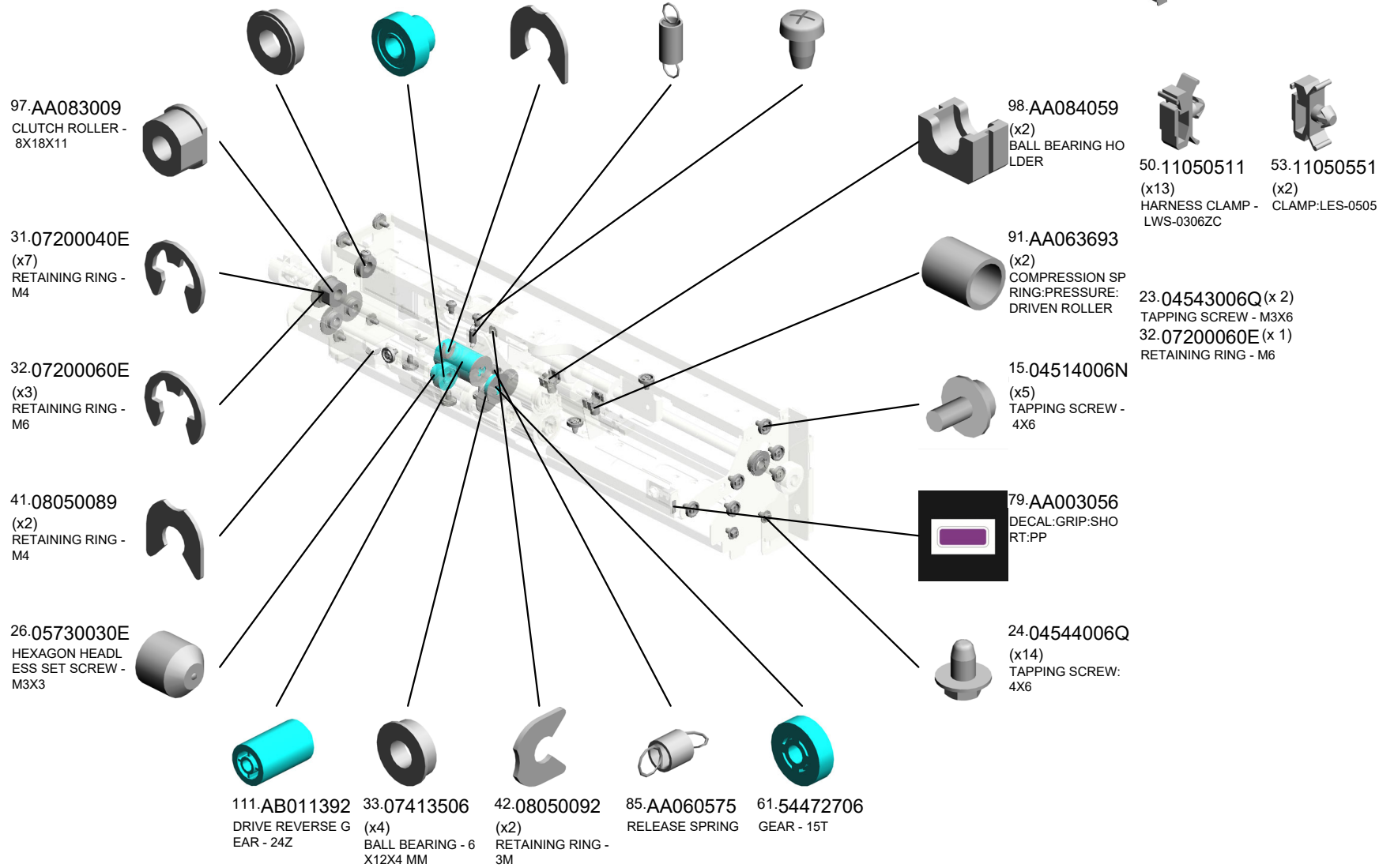

U006_S014
PAPER FEED UNIT:PAPER BANK:ASS'Y

- 118.AB017771 GEAR:TRANSPORT ROLLER:INPUT:Z23/Z28
- 190.B2346275 PICKUP ARM
- 240.D0596277 COVER:GEAR:PAPER FEED ROLLER
- 191.B2346288 BSENSOR BRACKET - SENSOR
- 180.B2342624 BALL BEARING - 8 X12X5

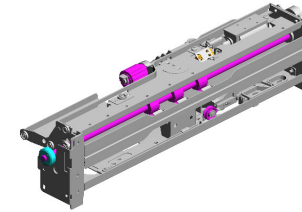

382.D2706628
PAPER FEED UNIT
:PAPER BANK:ASS'
Y

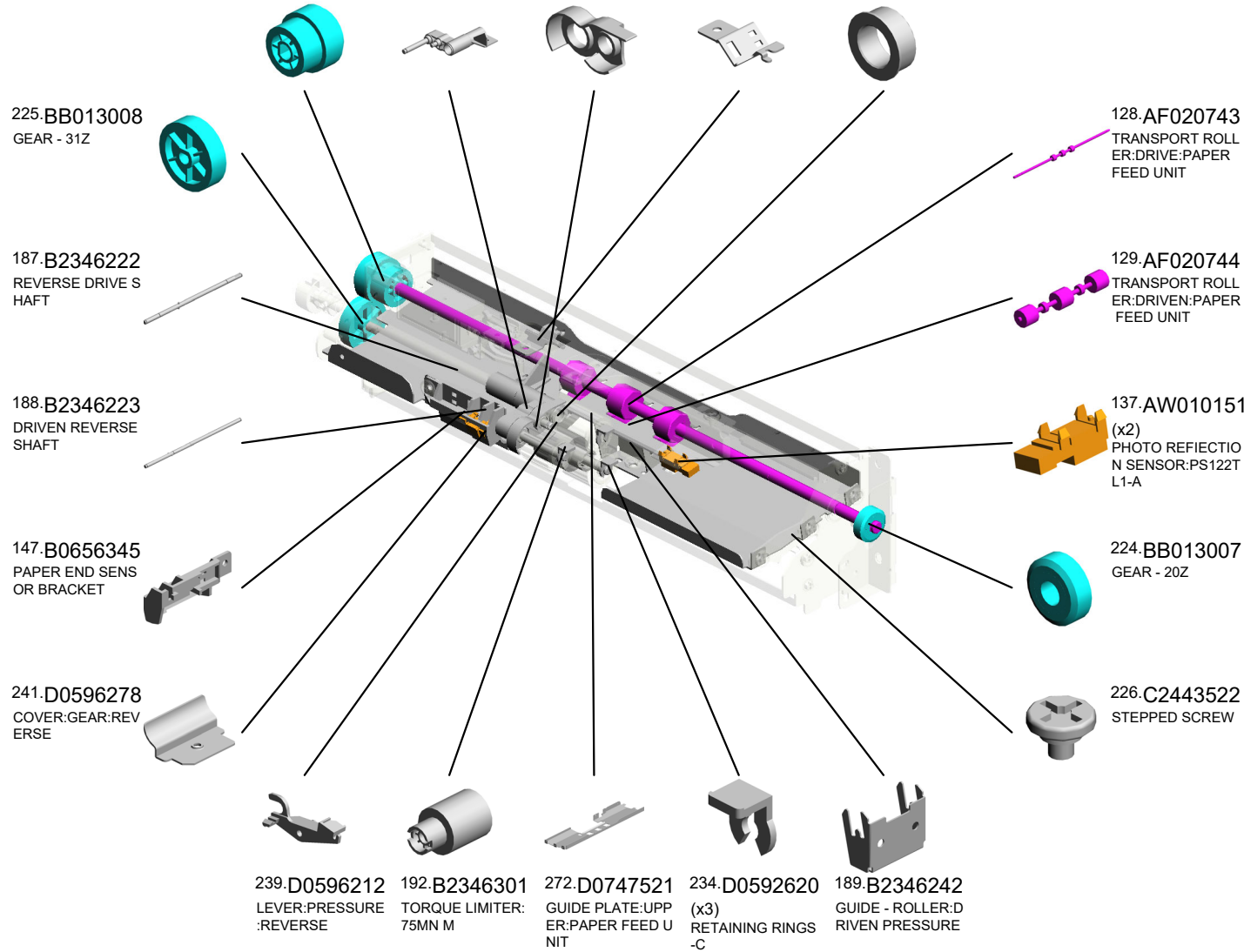

U006_S014

PAPER FEED UNIT:PAPER BANK:ASS'Y

- 294.D1796738 SLIDER:CAM:REVERSE
- 395.GW020024 PHOTOINTERRUPTOR:LG2A24BL1:GF 202211-01 O/O
- 293.D1796737 LEVER:PRESSURE RELEASE:REVERSE
- 399.AF031098 PAPER FEED ROLLER:FEED**
- 417.AF031140 (EPDM):PAPER FEED ROLLER:FEED 202206-03

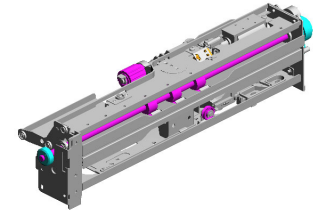

382.D2706628 PAPER FEED UNIT :PAPER BANK:ASS'Y

295.D1796739 LEVER:REVERSE:PRESSURE RELEASE:JOINT

291.D1796731 LEVER:PRESSURE:SLIDER

292.D1796734 BRACKET:SLIDER:CAM

419.AF030173 (EPDM):(For standard use):PAPER FEED ROLLER:PICKUP 202301-01 O/O

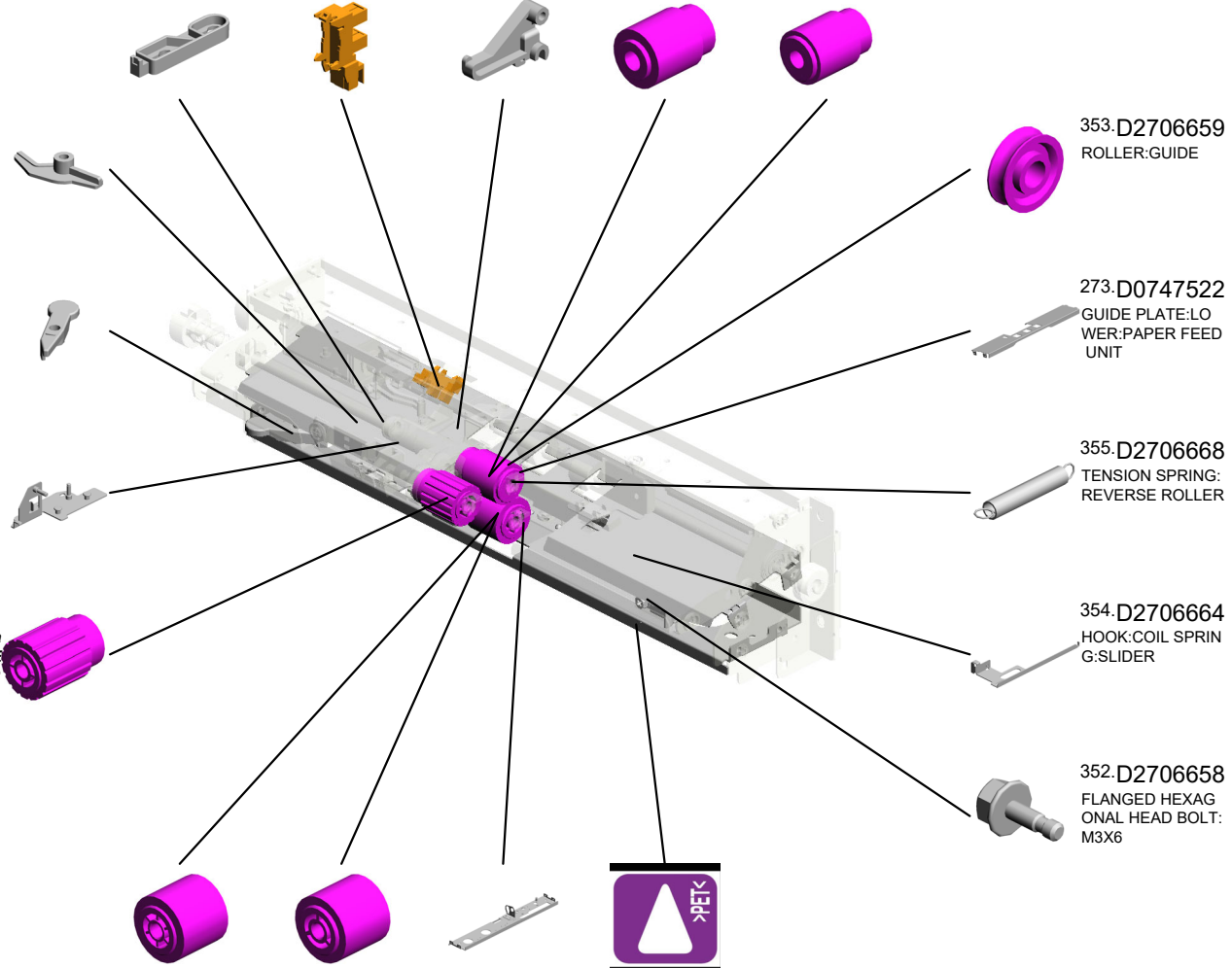

- 400.AF032098 PAPER FEED ROLLER:SEPARATE**
- 418.AF032140 (EPDM):PAPER FEED ROLLER:SEPARATE 202206-04
- 363.D2706740 STAY:REVERSE:ASSY
- 414.AA000290 DECAL:POSITIONING DISPLAY:SCREEN:PET 202102-02 O/O

353.D2706659 ROLLER:GUIDE

273.D0747522 GUIDE PLATE:LOWER:PAPER FEED UNIT

355.D2706668 TENSION SPRING:REVERSE ROLLER

354.D2706664 HOOK:COIL SPRING:SLIDER

352.D2706658 FLANGED HEXAGONAL HEAD BOLT: M3X6



U001	U002	U003	U004	U005	U006	U007	U008	U009	U010	U011	U012	U013	U014	U015	U016	U017	U018	U019	U020	U021
------	------	------	------	------	------	------	------	------	------	------	------	------	------	------	------	------	------	------	------	------

U006_S014_S001
SHAFT:FEED:ASS'Y

27.06230160E
SPRING PIN - 3X16
MM

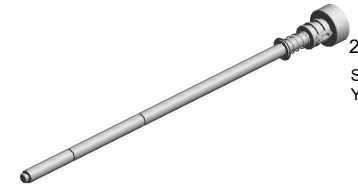

274.D0747527
SHAFT:FEED:ASS'
Y

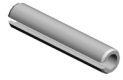

32.07200060E
RETAINING RING -
M6



U001	U002	U003	U004	U005	U006	U007	U008	U009	U010	U011	U012	U013	U014	U015	U016	U017	U018	U019	U020	U021
------	------	------	------	------	-------------	------	------	------	------	------	------	------	------	------	------	------	------	------	------	------

U006_S014_S002
SWING UNIT:PICKUP ROLLER:ASS'Y

4-03530040N
(x2)
SCREW - M3X4

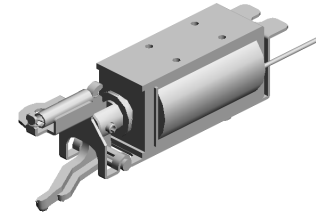
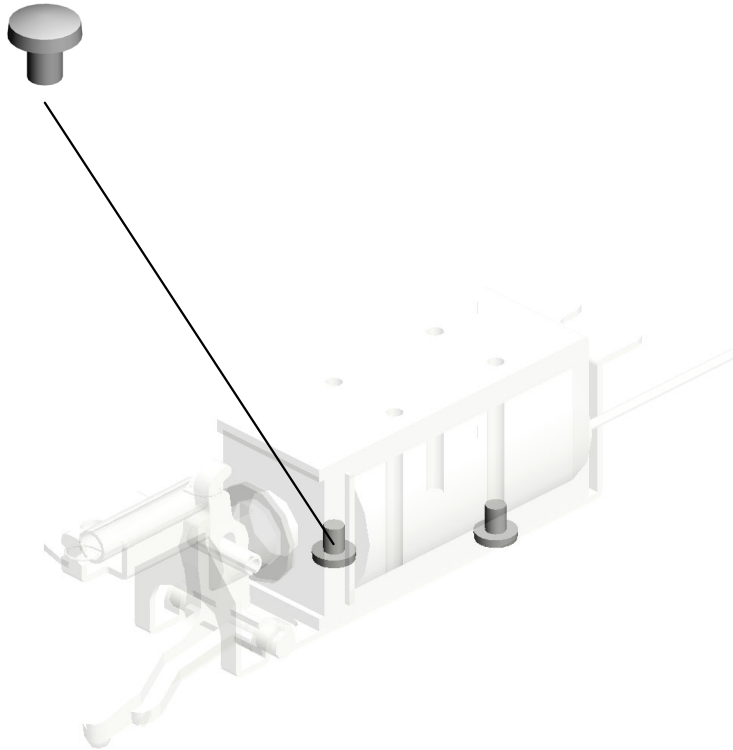

420.D0BX6282
[A]
SWING UNIT:PICK
UP ROLLER:ASS'Y
202301-05 O/O



D2706282
[A]
SWING UNIT:PICK
UP ROLLER:ASS'Y
202301-05 O/O

U001	U002	U003	U004	U005	U006	U007	U008	U009	U010	U011	U012	U013	U014	U015	U016	U017	U018	U019	U020	U021
------	------	------	------	------	-------------	------	------	------	------	------	------	------	------	------	------	------	------	------	------	------

U006_S015
PAPER FEED UNIT:PAPER BANK:ASS'Y

- 36.07433808 (x2) RADIAL BALL BEARING: DIA8XDIA16X5 201807-03 O/O
- 26.05730030E HEXAGON HEADLESS SET SCREW - M3X3
- 40.08050088 (x2) RETAINING RING - M6
- 84.AA060523 PICK-UP PRESSURE SPRING
- 9.04340060N (x3) PAN SELF-TAPPING SCREW:M4X6

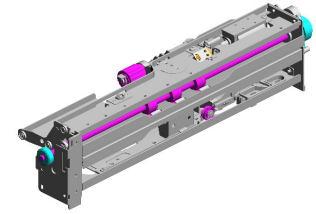

382.D2706628
PAPER FEED UNIT
:PAPER BANK:ASS'
Y

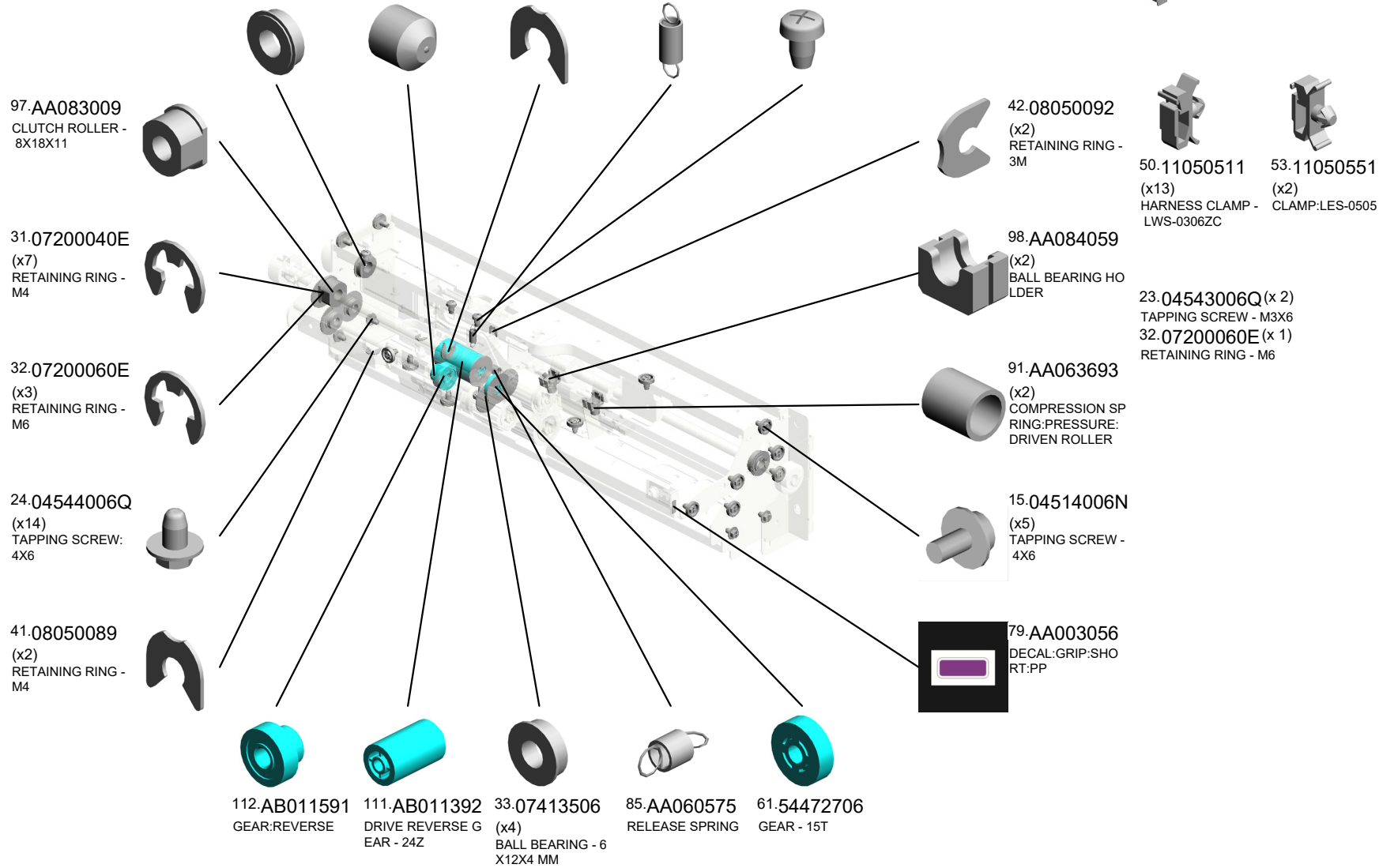

U001	U002	U003	U004	U005	U006	U007	U008	U009	U010	U011	U012	U013	U014	U015	U016	U017	U018	U019	U020	U021
------	------	------	------	------	------	------	------	------	------	------	------	------	------	------	------	------	------	------	------	------

U006_S015
 PAPER FEED UNIT:PAPER BANK:ASS'Y

- 118.AB017771 GEAR:TRANSPORT ROLLER:INPUT:Z23/Z28
- 190.B2346275 PICKUP ARM
- 240.D0596277 COVER:GEAR:PAPER FEED ROLLER
- 191.B2346288 BSENSOR BRACKET - SENSOR
- 180.B2342624 BALL BEARING - 8 X12X5

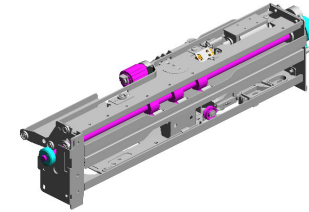

382.D2706628
 PAPER FEED UNIT
 :PAPER BANK:ASS'
 Y

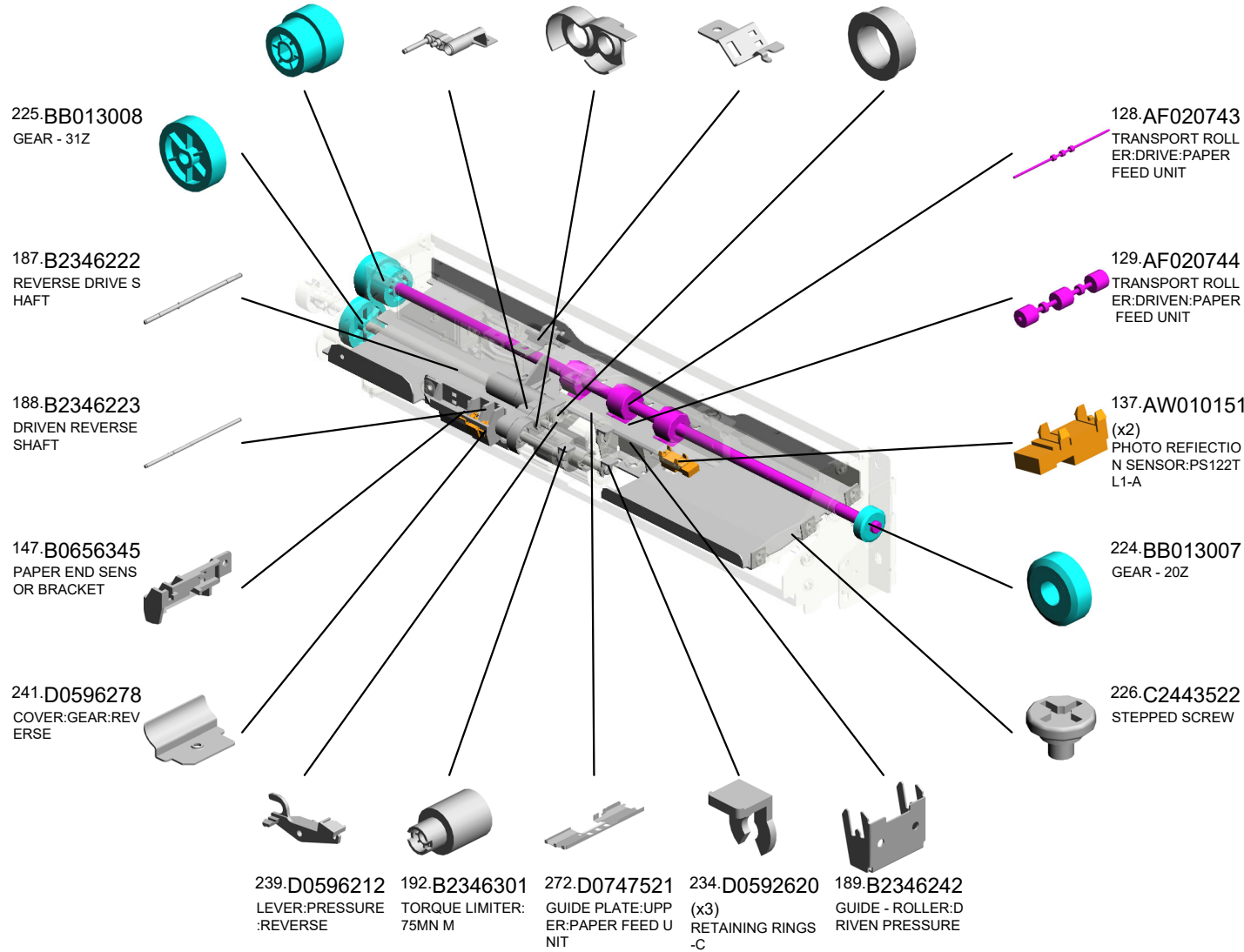

U006_S015
PAPER FEED UNIT:PAPER BANK:ASS'Y

294.D1796738 SLIDER:CAM:REVERSE
395.GW020024 PHOTOINTERRUPTOR:LG2A24BL1:GF
202211-01 O/O
293.D1796737 LEVER:PRESSURE RELEASE:REVERSE
399.AF031098 PAPER FEED ROLLER:FEED
417.AF031140 (EPDM):PAPER FEED ROLLER:FEED
202206-03

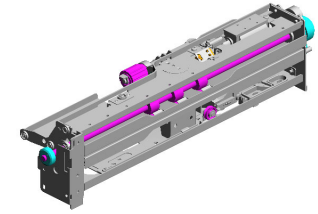

382.D2706628 PAPER FEED UNIT :PAPER BANK:ASS'Y

295.D1796739 LEVER:REVERSE:PRESSURE RELEASE:JOINT

291.D1796731 LEVER:PRESSURE:SLIDER

292.D1796734 BRACKET:SLIDER:CAM

419.AF030173 (EPDM):(For standard use):PAPER FEED ROLLER:PICKUP
202301-01 O/O

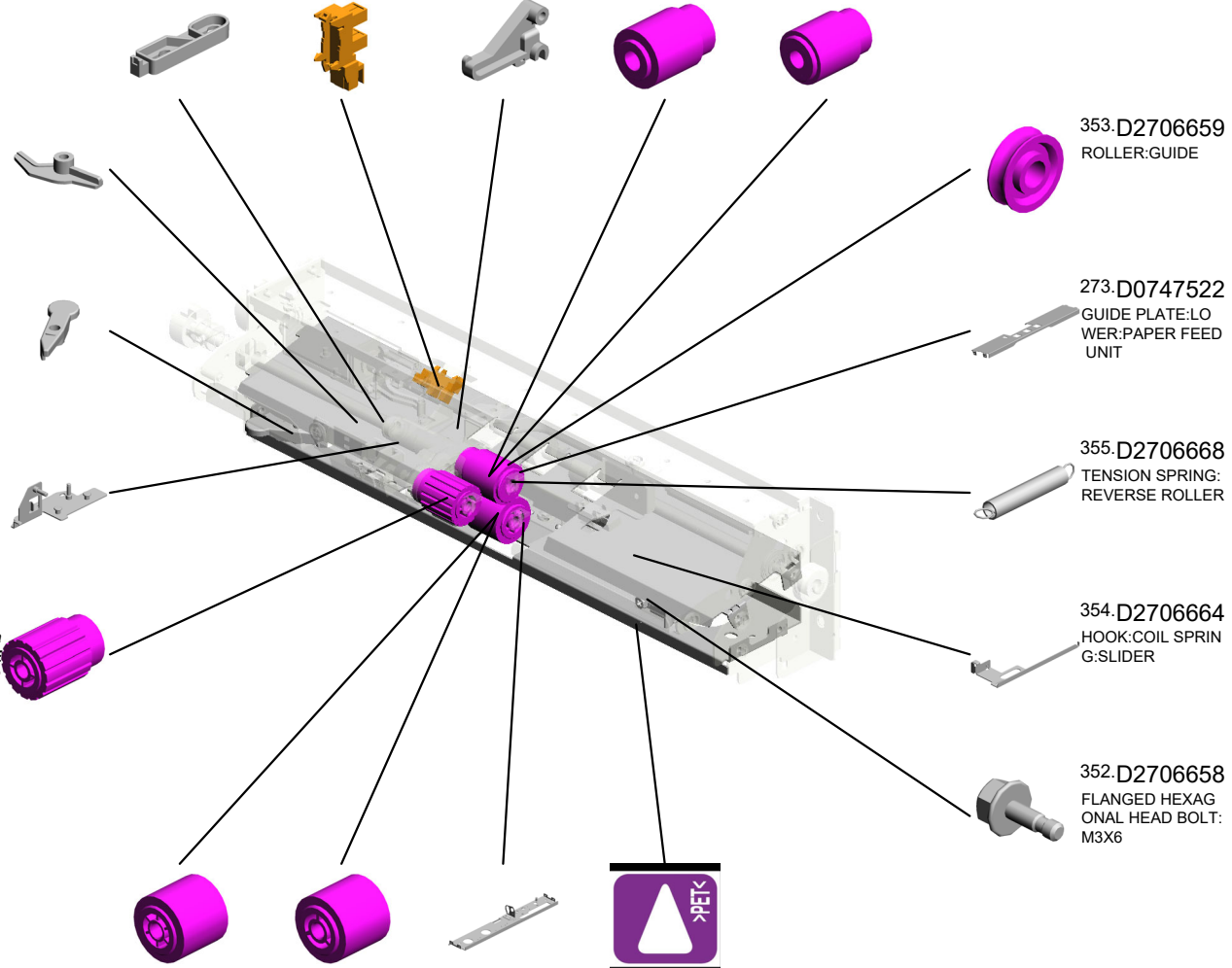

400.AF032098 PAPER FEED ROLLER:SEPARATE
418.AF032140 (EPDM):PAPER FEED ROLLER:SEPARATE
202206-04
363.D2706740 STAY:REVERSE:ASSY
414.AA000290 DECAL:POSITIONING DISPLAY:SCREEN:PET
202102-02 O/O

353.D2706659 ROLLER:GUIDE

273.D0747522 GUIDE PLATE:LOWER:PAPER FEED UNIT

355.D2706668 TENSION SPRING:REVERSE ROLLER

354.D2706664 HOOK:COIL SPRING:SLIDER

352.D2706658 FLANGED HEXAGONAL HEAD BOLT:M3X6



U001	U002	U003	U004	U005	U006	U007	U008	U009	U010	U011	U012	U013	U014	U015	U016	U017	U018	U019	U020	U021
------	------	------	------	------	------	------	------	------	------	------	------	------	------	------	------	------	------	------	------	------

U006_S015_S001
SHAFT:FEED:ASS'Y

27.06230160E
SPRING PIN - 3X16
MM

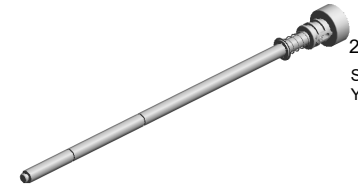

274.D0747527
SHAFT:FEED:ASS'
Y

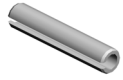

32.07200060E
RETAINING RING -
M6



U001	U002	U003	U004	U005	U006	U007	U008	U009	U010	U011	U012	U013	U014	U015	U016	U017	U018	U019	U020	U021
------	------	------	------	------	-------------	------	------	------	------	------	------	------	------	------	------	------	------	------	------	------

U006_S015_S002
SWING UNIT:PICKUP ROLLER:ASS'Y

4-03530040N
(x2)
SCREW - M3X4

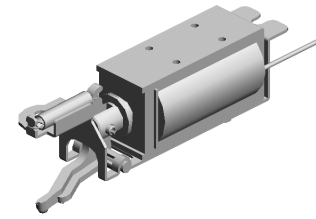
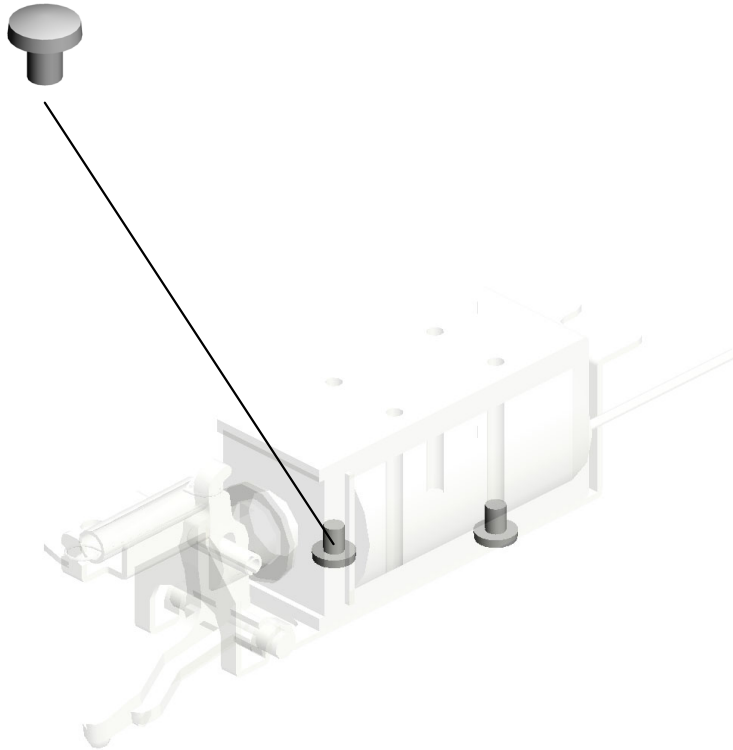

420.D0BX6282
[A]
SWING UNIT:PICK
UP ROLLER:ASS'Y
202301-05 O/O



D2706282
[A]
SWING UNIT:PICK
UP ROLLER:ASS'Y
202301-05 O/O

U001	U002	U003	U004	U005	U006	U007	U008	U009	U010	U011	U012	U013	U014	U015	U016	U017	U018	U019	U020	U021
------	------	------	------	------	-------------	------	------	------	------	------	------	------	------	------	------	------	------	------	------	------

U006_S016

PAPER FEED UNIT:PAPER BANK:ASS'Y

- 36.07433808 (x2) RADIAL BALL BEARING: DIA8XDIA16X5 201807-03 O/O
- 40.08050088 (x2) RETAINING RING - M6
- 111.AB011392 DRIVE REVERSE GEAR - 24Z
- 84.AA060523 PICK-UP PRESSURE SPRING
- 42.08050092 (x2) RETAINING RING - 3M

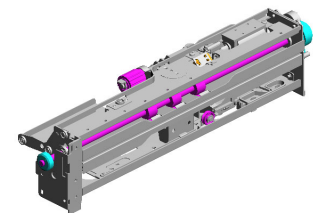

382.D2706628
PAPER FEED UNIT
:PAPER BANK:ASS'
Y

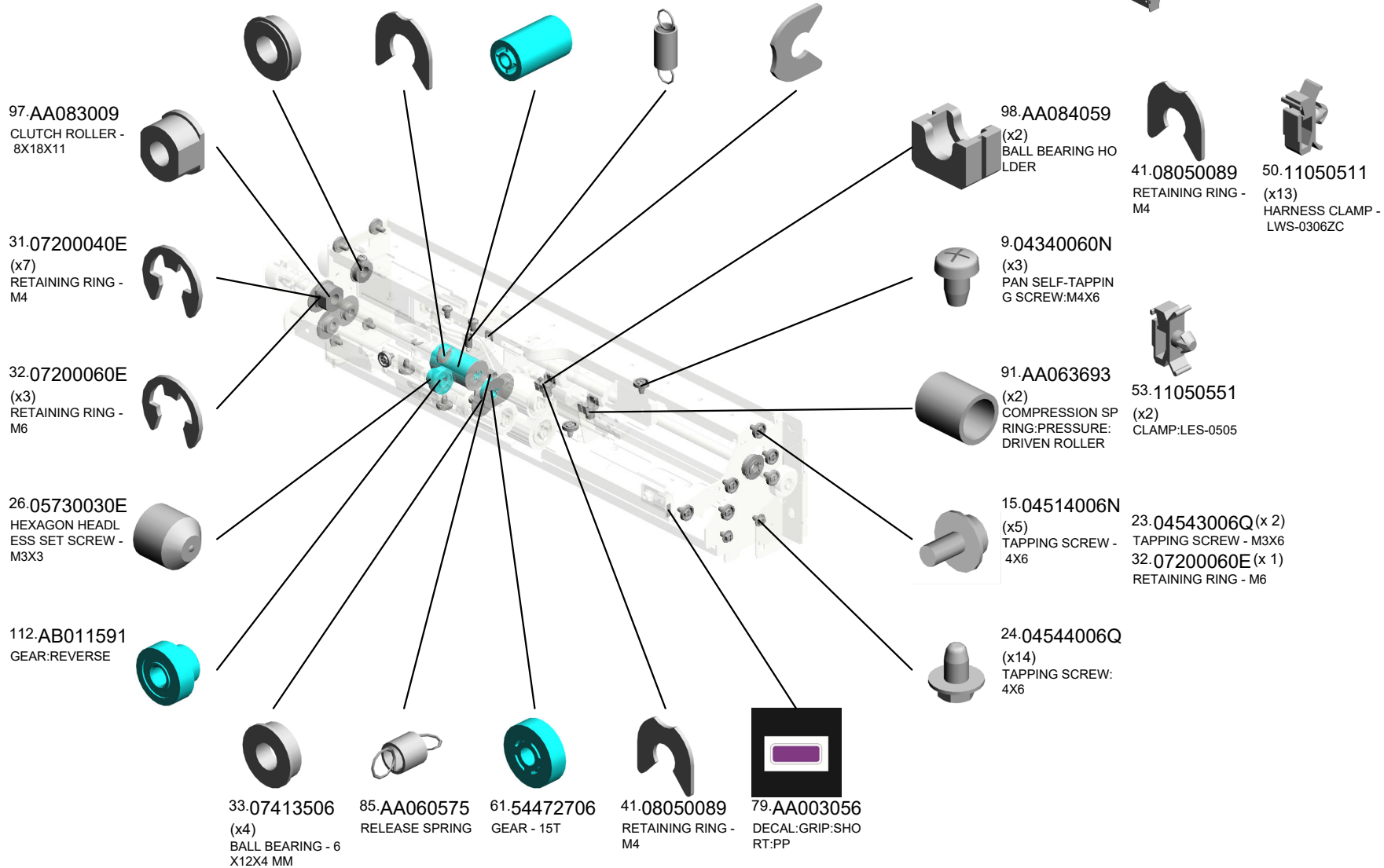

U001	U002	U003	U004	U005	U006	U007	U008	U009	U010	U011	U012	U013	U014	U015	U016	U017	U018	U019	U020	U021
------	------	------	------	------	------	------	------	------	------	------	------	------	------	------	------	------	------	------	------	------

U006_S016
 PAPER FEED UNIT:PAPER BANK:ASS'Y

- 118.AB017771 GEAR:TRANSPORT ROLLER:INPUT:Z23/Z28
- 190.B2346275 PICKUP ARM
- 240.D0596277 COVER:GEAR:PAPER FEED ROLLER
- 191.B2346288 BSENSOR BRACKET - SENSOR
- 180.B2342624 BALL BEARING - 8 X12X5

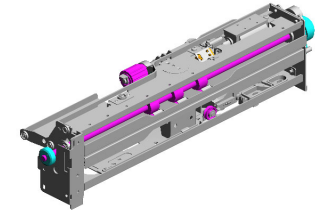

382.D2706628
 PAPER FEED UNIT
 :PAPER BANK:ASS'
 Y

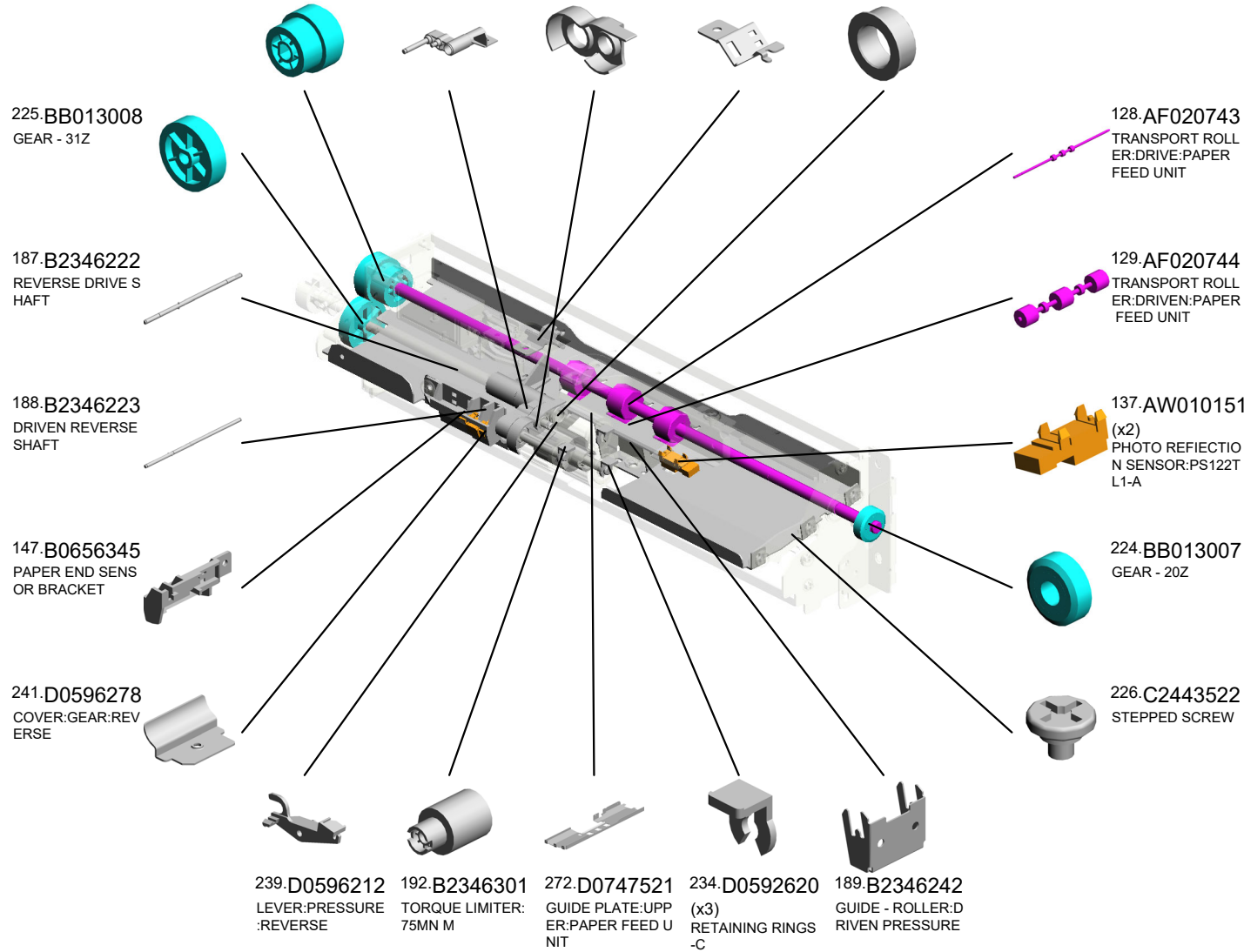

U006_S016
PAPER FEED UNIT:PAPER BANK:ASS'Y

294.D1796738 SLIDER:CAM:REVERSE
395.GW020024 PHOTOINTERRUPTOR:LG2A24BL1:GF
202211-01 O/O
293.D1796737 LEVER:PRESSURE RELEASE:REVERSE
399.AF031098 PAPER FEED ROLLER:FEED
417.AF031140 (EPDM):PAPER FEED ROLLER:FEED
202206-03

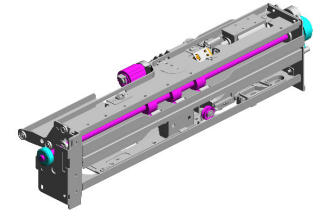

382.D2706628 PAPER FEED UNIT :PAPER BANK:ASS'Y

295.D1796739 LEVER:REVERSE:PRESSURE RELEASE:JOINT

291.D1796731 LEVER:PRESSURE:SLIDER

292.D1796734 BRACKET:SLIDER:CAM

419.AF030173 (EPDM):(For standard use):PAPER FEED ROLLER:PICKUP
202301-01 O/O

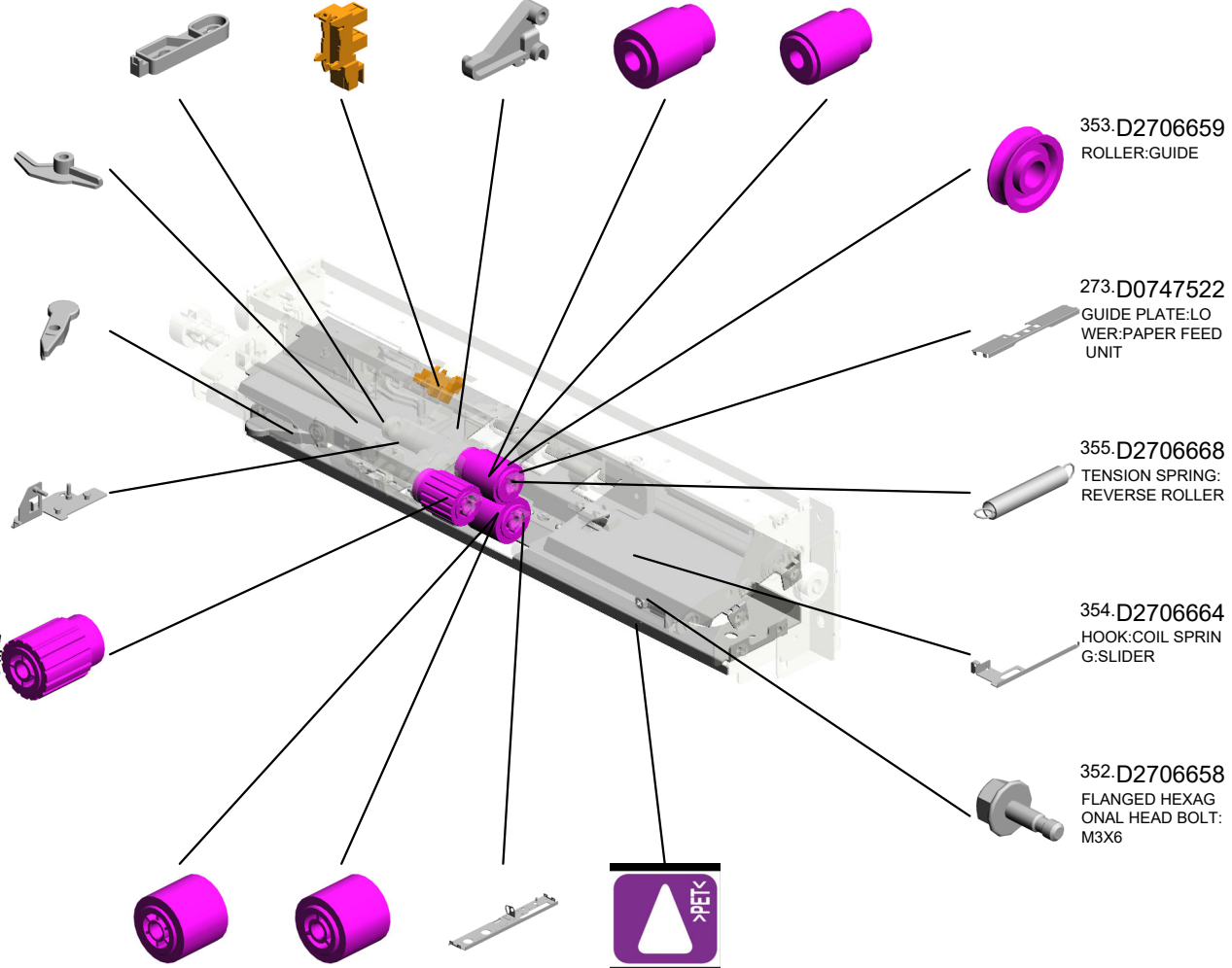

400.AF032098 PAPER FEED ROLLER:SEPARATE
418.AF032140 (EPDM):PAPER FEED ROLLER:SEPARATE
202206-04
363.D2706740 STAY:REVERSE:ASSY
414.AA000290 DECAL:POSITIONING DISPLAY:SCREEN:PET
202102-02 O/O

353.D2706659 ROLLER:GUIDE

273.D0747522 GUIDE PLATE:LOWER:PAPER FEED UNIT

355.D2706668 TENSION SPRING:REVERSE ROLLER

354.D2706664 HOOK:COIL SPRING:SLIDER

352.D2706658 FLANGED HEXAGONAL HEAD BOLT: M3X6



U001	U002	U003	U004	U005	U006	U007	U008	U009	U010	U011	U012	U013	U014	U015	U016	U017	U018	U019	U020	U021
------	------	------	------	------	------	------	------	------	------	------	------	------	------	------	------	------	------	------	------	------

U006_S016_S001
SHAFT:FEED:ASS'Y

27.06230160E
SPRING PIN - 3X16
MM

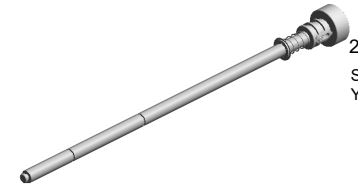

274.D0747527
SHAFT:FEED:ASS'
Y

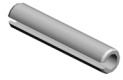

32.07200060E
RETAINING RING -
M6



U001	U002	U003	U004	U005	U006	U007	U008	U009	U010	U011	U012	U013	U014	U015	U016	U017	U018	U019	U020	U021
------	------	------	------	------	-------------	------	------	------	------	------	------	------	------	------	------	------	------	------	------	------

U006_S016_S002
SWING UNIT:PICKUP ROLLER:ASS'Y

4.03530040N
(x2)
SCREW - M3X4

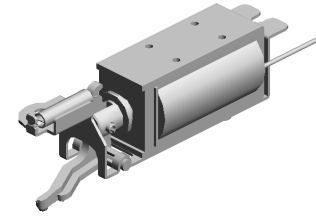
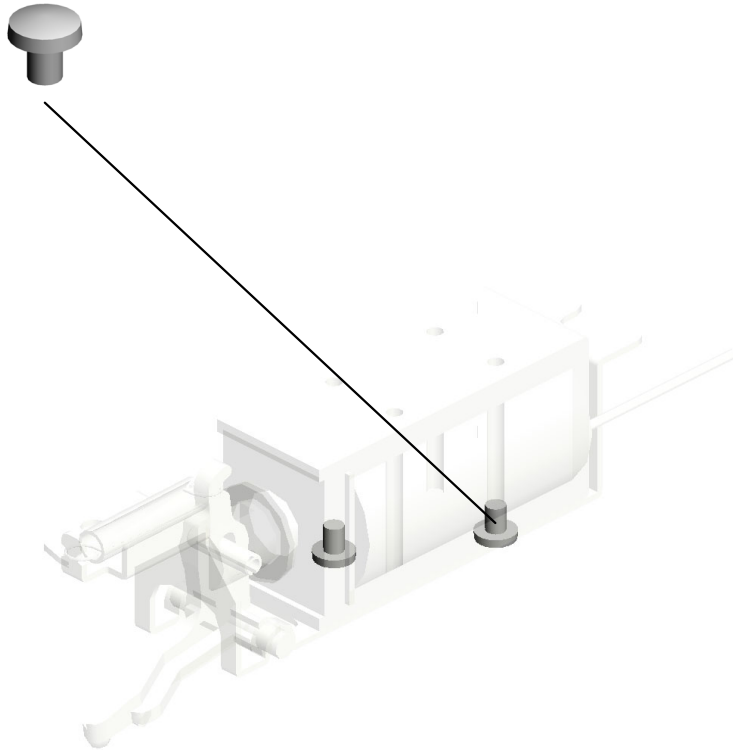

420.D0BX6282
[A]
SWING UNIT:PICK
UP ROLLER:ASS'Y
202301-05 O/O



D2706282
[A]
SWING UNIT:PICK
UP ROLLER:ASS'Y
202301-05 O/O

U001	U002	U003	U004	U005	U006	U007	U008	U009	U010	U011	U012	U013	U014	U015	U016	U017	U018	U019	U020	U021
------	------	------	------	------	-------------	------	------	------	------	------	------	------	------	------	------	------	------	------	------	------

U006_S017
(NA):TANDEM LCT:RIGHT:ASS'Y

- 68.A2486713 (x2) HOOK - TENSION SPRING
- 86.AA060757 (x2) TENSION SPRING - LONG
- 45.09514006N (x4) SCREW:POLISHED ROUND:M4X6
- 67.A2486695 (x4) GUIDE - PULLEY
- 44.09513006N SCREW - M3X6

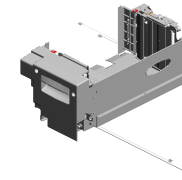

407.D2706647
[A]
(NA):TANDEM LCT:
RIGHT:ASS'Y
201907-15 X/O

11.04504008N
(x2)
TAPPING SCREW - M4X8



31.07200040E
(x8)
RETAINING RING - M4



52.11050534
(x7)
CLAMP



73.A2946690
FEELER - PAPER H EIGHT SENSOR



48.11050488
(x4)
HARNES CLAMP



16.04514008N
(x16)
TAPPING SCREW: 4X8



2.03130080N
(x2)
PAN HEAD SCREW :M3X8



22.04534008N
BINDING SELF TAP PING SCREW:4X8



32.07200060E
(x2)
RETAINING RING - M6



28.06330200G
(x2)
PIN - M3X20

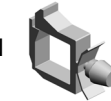
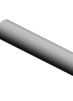

48.11050488
(x2)
HARNES CLAMP



50.11050511
(x2)
HARNES CLAMP - LWS-0306ZC



52.11050534
CLAMP

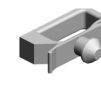

383.11050760
CLAMP:LWSM-051 1A

25.04544008Q
(x14)
TAPPING SCREW - M4X8

65.A2486687
RIGHT DRIVE SHA FT

3.03130120N
PAN HEAD SCREW :M3X12

66.A2486694
(x3)
WIRE RING

57.50530223
(x3)
BUSHING - 8MM



U006_S017
(NA):TANDEM LCT:RIGHT:ASS'Y

120.AB032058 (x2) WIRE PULLEY - M10
 121.AB032719 (x2) PULLEY - M10
 159.B0656870 (x2) STAY -RIGHTBASE
 171.B1327550 (x2) COVER:PULLEY:DRIVE WERE
 164.B0706684 LEVER:RELEASE:RIGHT EAR

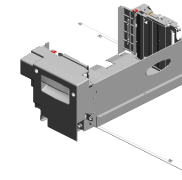

407.D2706647
 [A]
 (NA):TANDEM LCT:
 RIGHT:ASS'Y
 201907-15 X/O

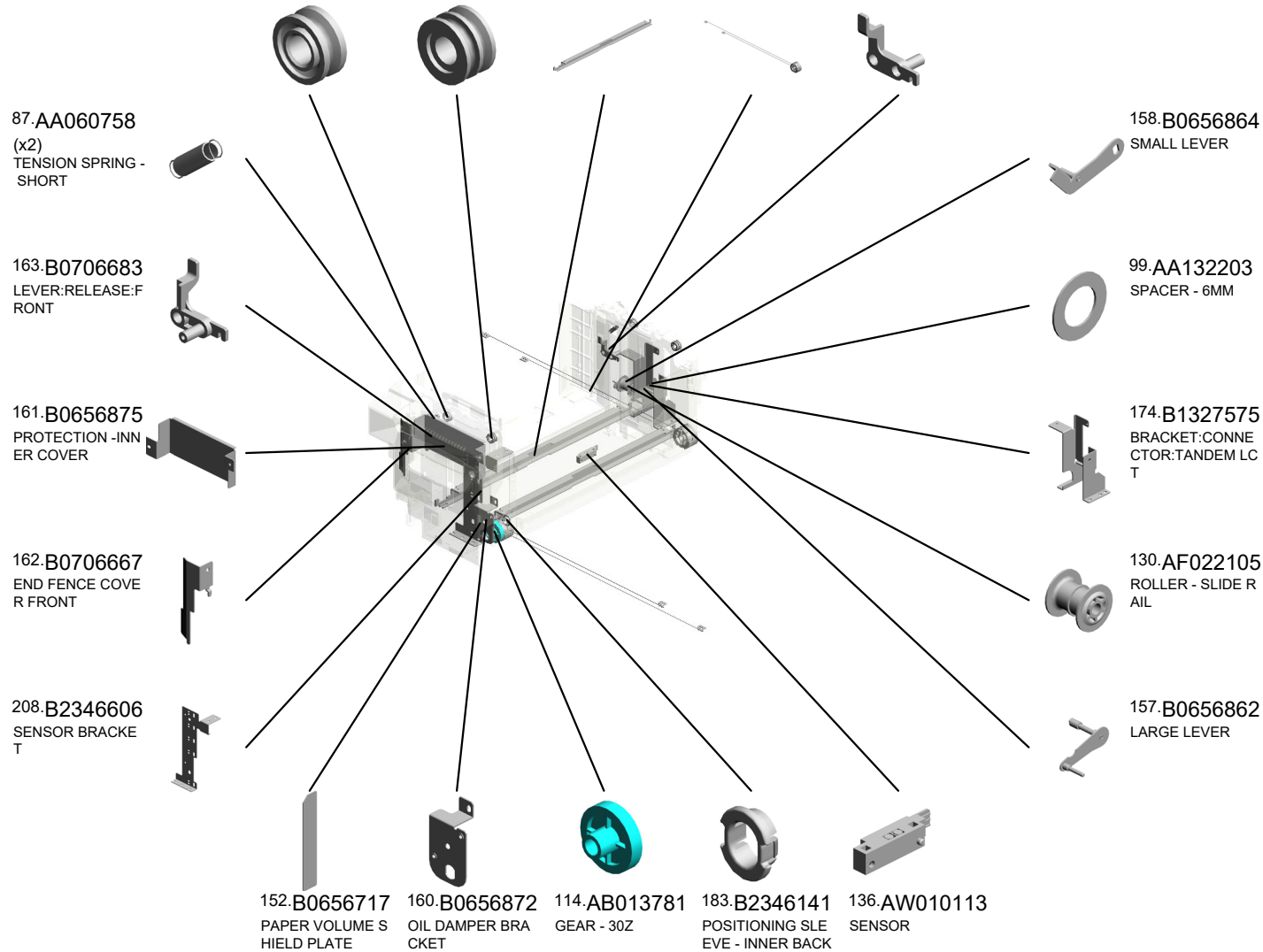

U006_S017
(NA):TANDEM LCT:RIGHT:ASS'Y

395.GW020024 (x9) PHOTOINTERRUPTOR:LG2A24BL1:GF 201902-08 O/O
 209.B2346612 END FENCE - FRONT
 356.D2706678 (x2) COVER:CUSHION
 264.D0747388 DECAL:PAPER SE T DIRECTION:TANDEM LCT:RIGHT
 381.D0146627 BRACKET:ON OFF DETECTOR:REAR

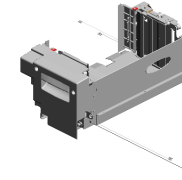

407.D2706647
 [A]
 (NA):TANDEM LCT:RIGHT:ASS'Y
 201907-15 X/O

391.AA161178 (x2) CUSHION:BASE:TANDEM LCT:SMALL 201812-05 O/O

250.D0596712 INNER COVER:TANDEM LCT

262.D0747385 DECAL:CAUTION CHART:TANDEM LCT

398.D0BX6677 ROLLER:SLIDE RAIL:FRONT 201903-02 O/O

212.B2346686 SIDE FENCE - RIGHT FRONT

219.B2476901 OIL DAMPER:FALL

255.D0746497 (x2) DECAL:POSITIONING DISPLAY:TCR

405.D0BX7595 (NA/EU,AA,TWN,KOR):BASE:TANDEM LCT:RIGHT:ADHESION 201907-13 X/O

210.B2346625 END FENCE - REAR

216.B2476695 GUIDE:MISFEED REMOVAL:PAPER TRAY

215.B2476672 GUIDE:INTERLOCK:TANDEM LCT

249.D0596668 SIDE PLATE:SIDE:TANDEM LCT

390.AA161177 CUSHION:BASE:TANDEM LCT:LARGE 201812-04 O/O



D2706685
 [A]
 (NA):TANDEM LCT:RIGHT:ASS'Y
 201907-15 X/O

U001	U002	U003	U004	U005	U006	U007	U008	U009	U010	U011	U012	U013	U014	U015	U016	U017	U018	U019	U020	U021
------	------	------	------	------	-------------	------	------	------	------	------	------	------	------	------	------	------	------	------	------	------

U006_S017_S001
SIDE FENCE:TANDEM LCT:RIGHT:ASS'Y

77-AA001509
DECAL:SIDE FENC
E:16X30

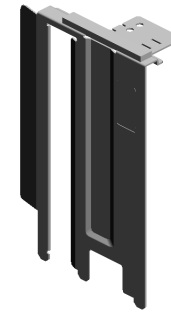
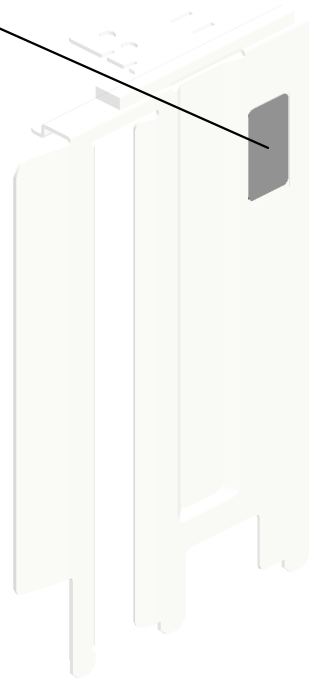

213-B2346691
SIDE FENCE:TAND
EM LCT:RIGHT:AS
SY

U001	U002	U003	U004	U005	U006	U007	U008	U009	U010	U011	U012	U013	U014	U015	U016	U017	U018	U019	U020	U021
------	------	------	------	------	-------------	------	------	------	------	------	------	------	------	------	------	------	------	------	------	------

U006_S017_S002
DC SOLENOID:END FENCE:FRONT:ASS'Y

1-03130040N
(x2)
SCREW:M3X4

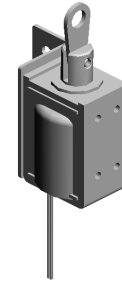

346-D2236722
DC SOLENOID:EN
D FENCE:FRONT:A
SS'Y

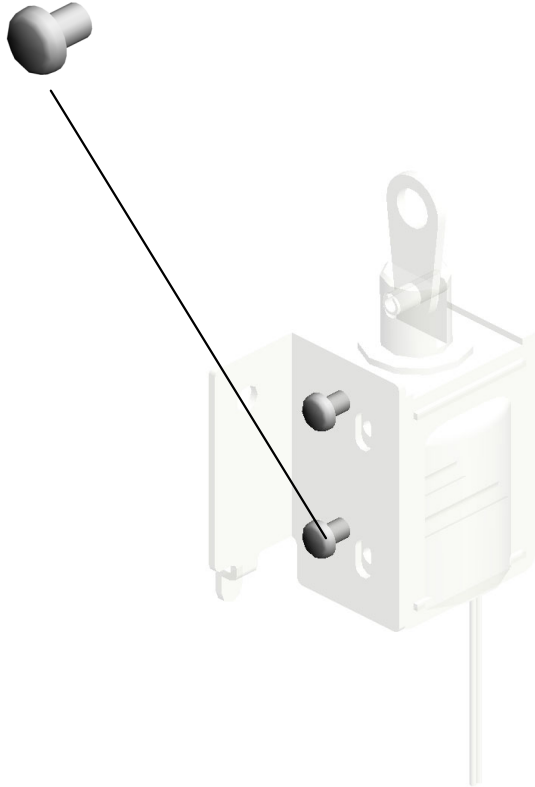

U001	U002	U003	U004	U005	U006	U007	U008	U009	U010	U011	U012	U013	U014	U015	U016	U017	U018	U019	U020	U021
------	------	------	------	------	-------------	------	------	------	------	------	------	------	------	------	------	------	------	------	------	------

U006_S017_S003
DC SOLENOID:END FENCE:REAR:ASS'Y

1-03130040N
(x2)
SCREW:M3X4

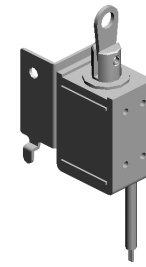

347.D2236732
DC SOLENOID:EN
D FENCE:REAR:AS
S'Y

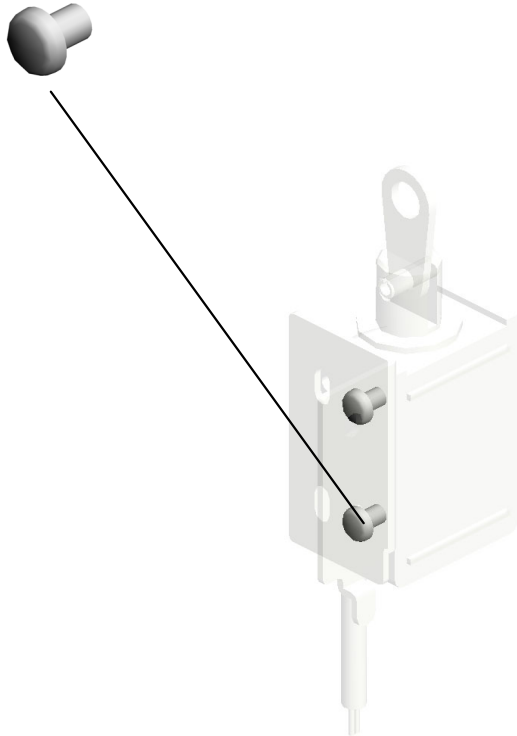

U001	U002	U003	U004	U005	U006	U007	U008	U009	U010	U011	U012	U013	U014	U015	U016	U017	U018	U019	U020	U021
------	------	------	------	------	-------------	------	------	------	------	------	------	------	------	------	------	------	------	------	------	------

U006_S018
(NA):TANDEM LCT:LEFT:ASS'Y

- 123.AB033085 TIMING PULLEY - 1 5T
- 31.07200040E (x5) RETAINING RING - M4
- 154.B0656823 TIMING BELT COVER
- 11.04504008N (x2) TAPPING SCREW - M4X8
- 89.AA060987 TENSION SPRING: TIMING BELT:10N

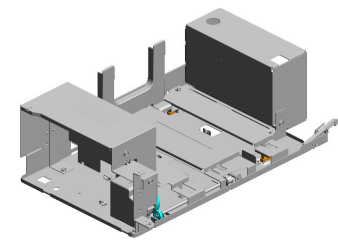

411.D2707559
[A]
(NA):TANDEM LCT:
LEFT:ASS'Y
201911-02 O/O

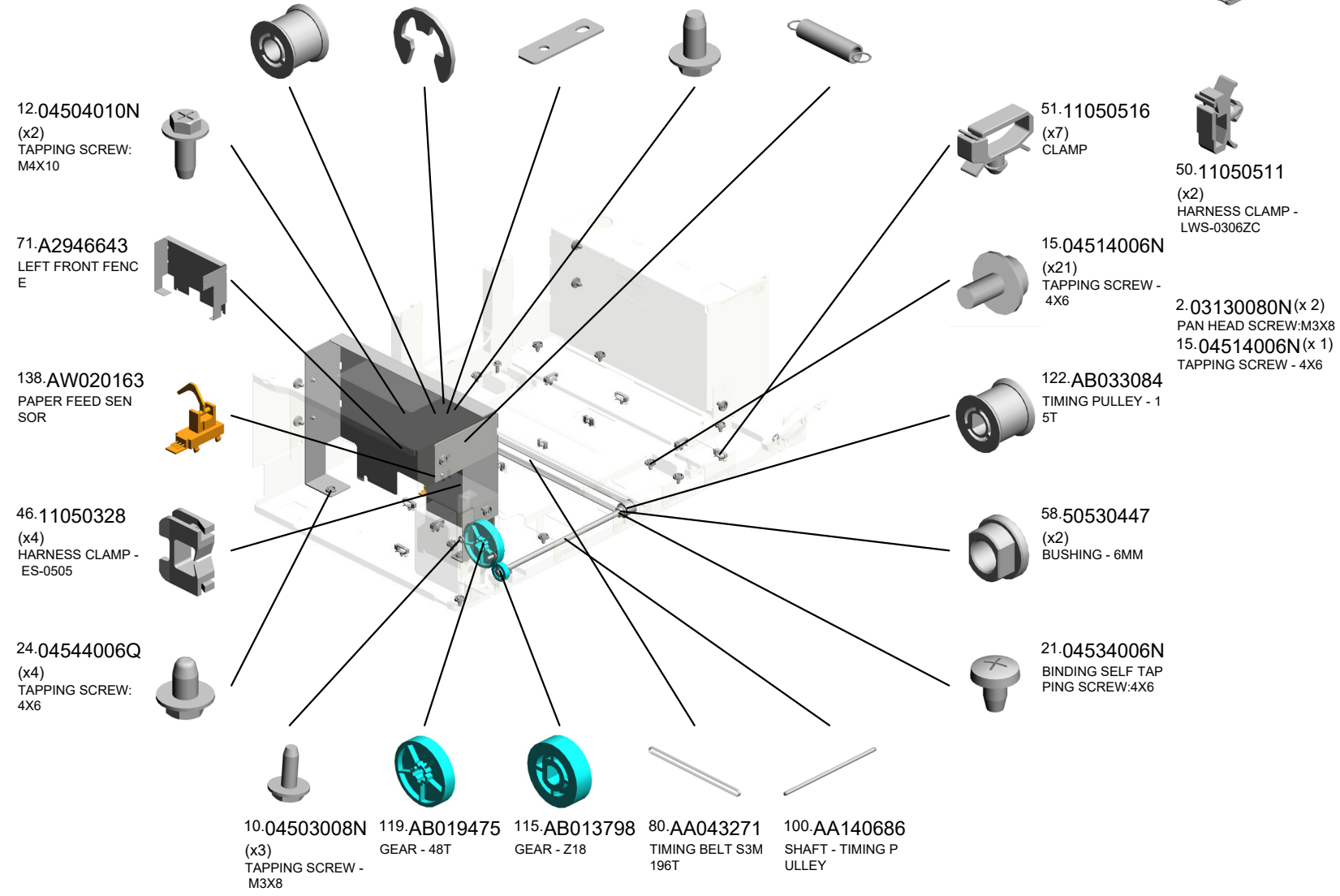

U001	U002	U003	U004	U005	U006	U007	U008	U009	U010	U011	U012	U013	U014	U015	U016	U017	U018	U019	U020	U021
------	------	------	------	------	------	------	------	------	------	------	------	------	------	------	------	------	------	------	------	------

U006_S018
(NA):TANDEM LCT:LEFT:ASS'Y

- 341.D1947552 SIDE PLATE:TANDEM LCT:LEFT SIDEWAYS
- 172.B1327561 BACK FENCE:LEFT
- 173.B1327564 SLIDER:BACK FENCE:LEFT
- 361.D2706721 COVER:GUARD:HA RNESS
- 220.B2476950 SHAFT:SLIDER:BA CK FENCE

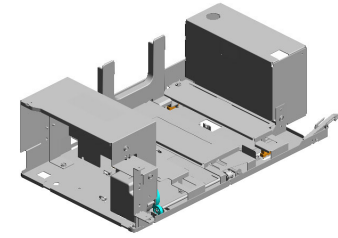

411.D2707559
[A]
(NA):TANDEM LCT:
LEFT:ASS'Y
201911-02 O/O

409.D2707389
DECAL:PAPER SE T DIRECTION:TANDEM LCT:LEFT
201909-02 O/O



421.D0EZ6646
INNER COVER:TANDEM LCT:LEFT
202311-02 O/O

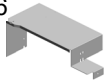

221.B2476951
BRACKET:PULLEY:DRIVEN:ASS'Y

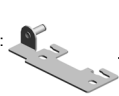

214.B2347540
TRAY BOTTOM PLATE:LEFT FRONT



170.B1327541
TRAY BOTTOM PLATE:LEFT REAR



244.D0596620
LEVER:COUPLING:LEFT



246.D0596659
SUPPORTING PLATE:SIDE FENCE:LEFT



395.GW020024
(x2)
PHOTOINTERRUPTOR:LG2A24BL1:GF
201902-08 O/O



156.B0656831
SENSOR BRACKET



- 348.D2236747 DC MOTOR:TANDEM LCT:19.2W:BRUSH
- 248.D0596665 BRACKET:DC MOTOR:LEFT:ASS'Y
- 155.B0656830 PULLEY BRACKET

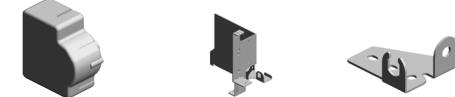

D0BX7557
[A]
(NA):TANDEM LCT:
LEFT:ASS'Y
201911-02 O/O

U006_S018_S001
(NA/EU,AA,TWN,KOR):TRAY BOTTOM PLATE:LEFT MIDDLE:ASS'Y

263.D0747387
(NA/EU,AA,TWN,K
OR):DECAL:BASE:
TANDEM LCT:LEFT

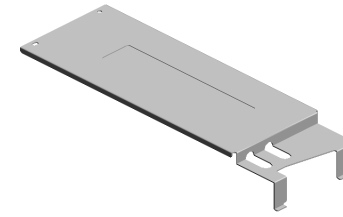
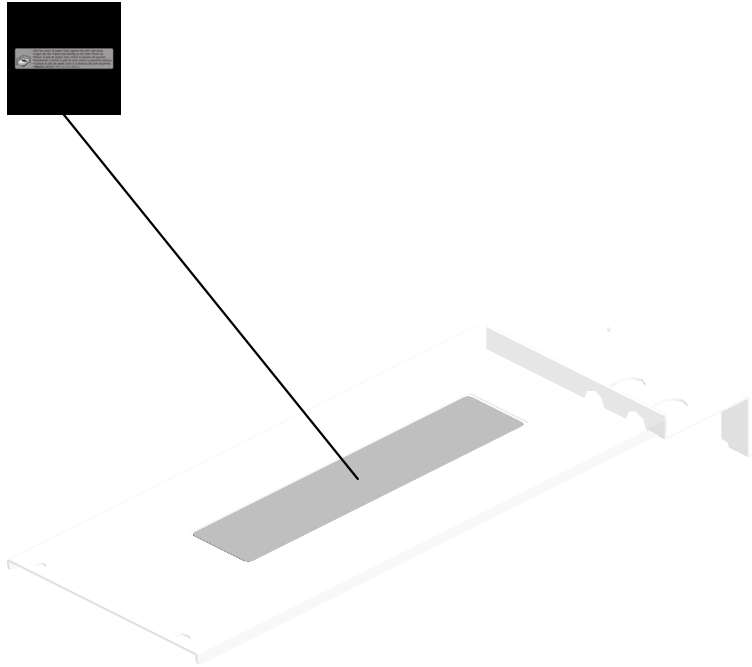

281.D0747596
(NA/EU,AA,TWN,K
OR):TRAY BOTTO
M PLATE:LEFT MID
DLE:ASS'Y

U001	U002	U003	U004	U005	U006	U007	U008	U009	U010	U011	U012	U013	U014	U015	U016	U017	U018	U019	U020	U021
------	------	------	------	------	-------------	------	------	------	------	------	------	------	------	------	------	------	------	------	------	------

U006_S018_S002
SIDE FENCE:TANDEM LCT:LEFT REAR:ASS'Y

76-AA001508
DECAL:SIDE FENC
E:40X30

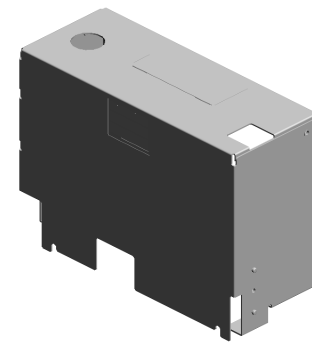
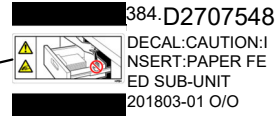
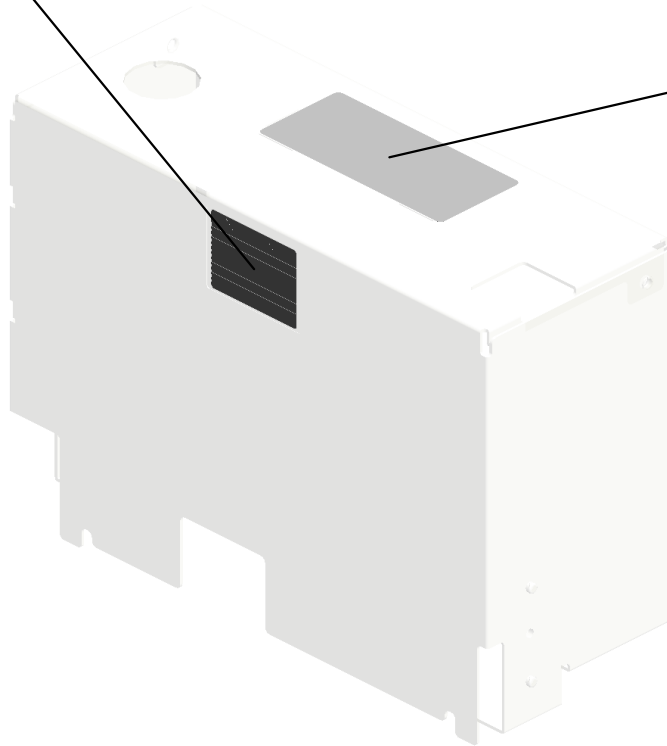

389-D2707544
[A]
SIDE FENCE:TAND
EM LCT:LEFT REA
R:ASS'Y
201809-03 O/O

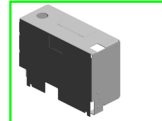

D1797544
[A]
SIDE FENCE:TAND
EM LCT:LEFT REA
R:ASS'Y
201809-03 O/O

U006_S019
 (EU,AA,TWN,KOR):TANDEM LCT:RIGHT:ASS'Y

24.04544006Q (x8) TAPPING SCREW: 4X6
 68.A2486713 (x2) HOOK - TENSION SPRING
 18.04523006N (x4) BINDING SELF-TAPPING SCREW:3X6
 67.A2486695 (x4) GUIDE - PULLEY
 44.09513006N SCREW - M3X6

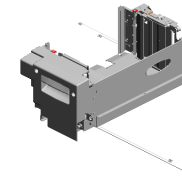

408-D2706646
 [A]
 (EU,AA,TWN,KOR):
 TANDEM LCT:RIGHT:
 ASS'Y
 201909-01 X/O

11.04504008N
 (x2)
 TAPPING SCREW - M4X8



45.09514006N
 (x4)
 SCREW:POLISHED ROUND:M4X6



31.07200040E
 (x8)
 RETAINING RING - M4



52.11050534
 (x7)
 CLAMP



48.11050488
 (x4)
 HARNESS CLAMP



16.04514008N
 (x14)
 TAPPING SCREW: 4X8



2.03130080N
 (x2)
 PAN HEAD SCREW :M3X8



22.04534008N
 BINDING SELF TAPPING SCREW:4X8



32.07200060E
 (x2)
 RETAINING RING - M6



28.06330200G
 (x2)
 PIN - M3X20

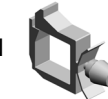
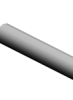

48.11050488
 (x2)
 HARNESS CLAMP



50.11050511
 (x2)
 HARNESS CLAMP - LWS-0306ZC



52.11050534
 CLAMP

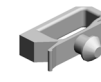

383.11050760
 CLAMP:LWSM-051 1A

65.A2486687
 RIGHT DRIVE SHAFT

3.03130120N
 PAN HEAD SCREW :M3X12

25.04544008Q (x6)
 TAPPING SCREW - M4X8

66.A2486694 (x3)
 WIRE RING

57.50530223 (x3)
 BUSHING - 8MM



U006_S019
 (EU,AA,TWN,KOR):TANDEM LCT:RIGHT:ASS'Y

120.AB032058 (x2) WIRE PULLEY - M10
 121.AB032719 (x2) PULLEY - M10
 159.B0656870 (x2) STAY -RIGHTBASE
 171.B1327550 (x2) COVER:PULLEY:DRIVE WERE
 164.B0706684 LEVER:RELEASE:RIGHT EAR

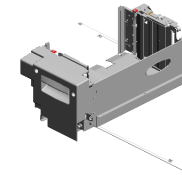

408.D2706646
 [A]
 (EU,AA,TWN,KOR):
 TANDEM LCT:RIGHT:
 ASS'Y
 201909-01 X/O

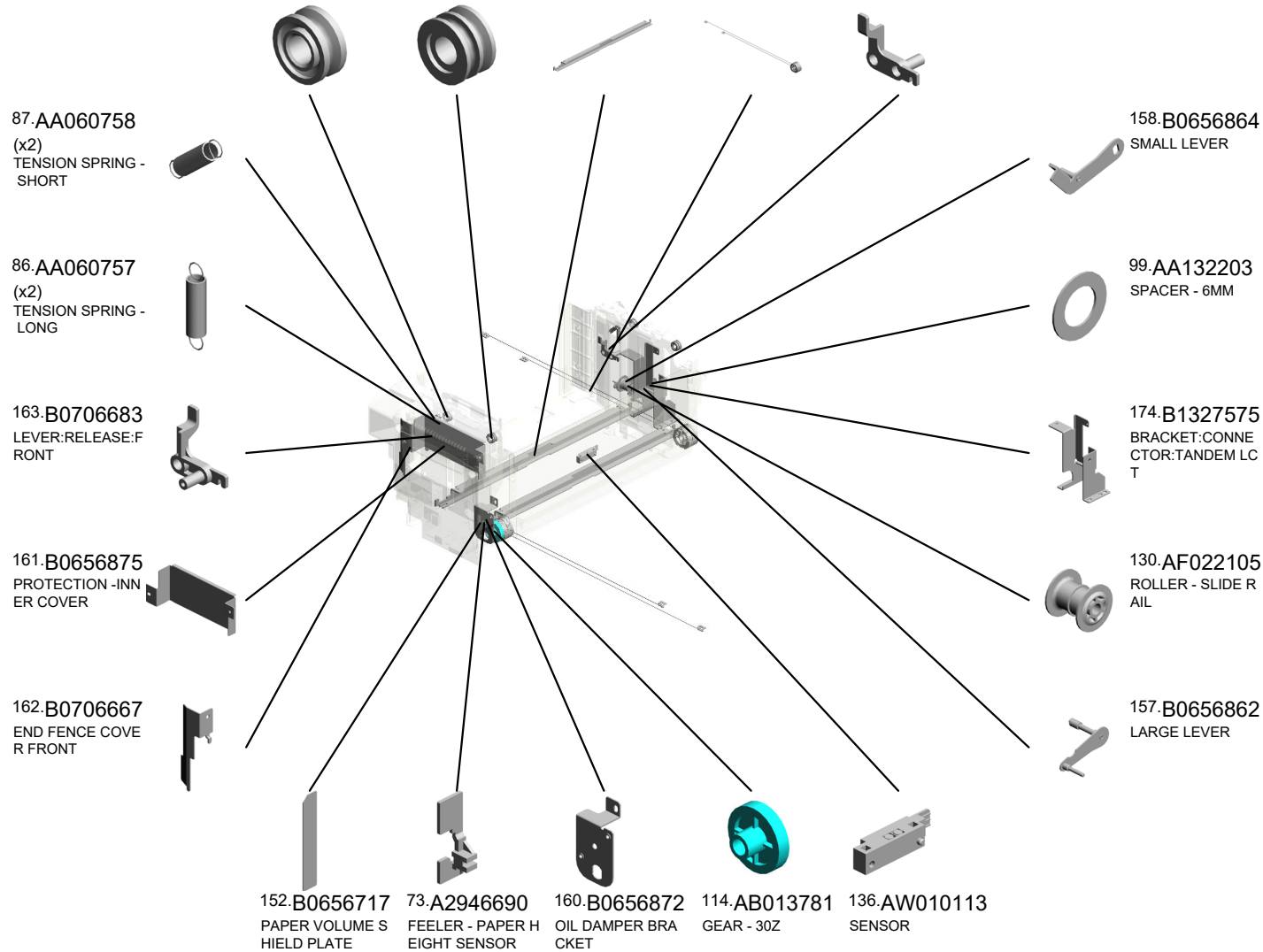

U006_S019
 (EU,AA,TWN,KOR):TANDEM LCT:RIGHT:ASS'Y

- 211.B2346630 (x2) (CHN/EU,AA,TWN,KOR):GUIDE PLATE - END FENCE
- 356.D2706678 (x2) COVER:CUSHION
- 264.D0747388 DECAL:PAPER SE T DIRECTION:TANDEM LCT:RIGHT
- 212.B2346686 SIDE FENCE - RIG HT FRONT
- 381.D0146627 BRACKET:ON OFF DETECTOR:REAR

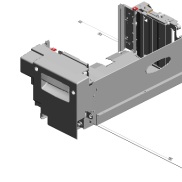

408.D2706646
 [A]
 (EU,AA,TWN,KOR):
 TANDEM LCT:RIGH
 T:ASS'Y
 201909-01 X/O

395.GW020024
 (x9)
 PHOTOINTERRUPTOR:LG2A24BL1:GF
 201902-08 O/O



209.B2346612
 END FENCE - FRONT



250.D0596712
 INNER COVER:TANDEM LCT



262.D0747385
 DECAL:CAUTION CHART:TANDEM LCT

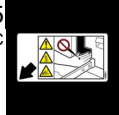

398.D0BX6677
 ROLLER:SLIDE RAIL:FRONT
 201903-02 O/O

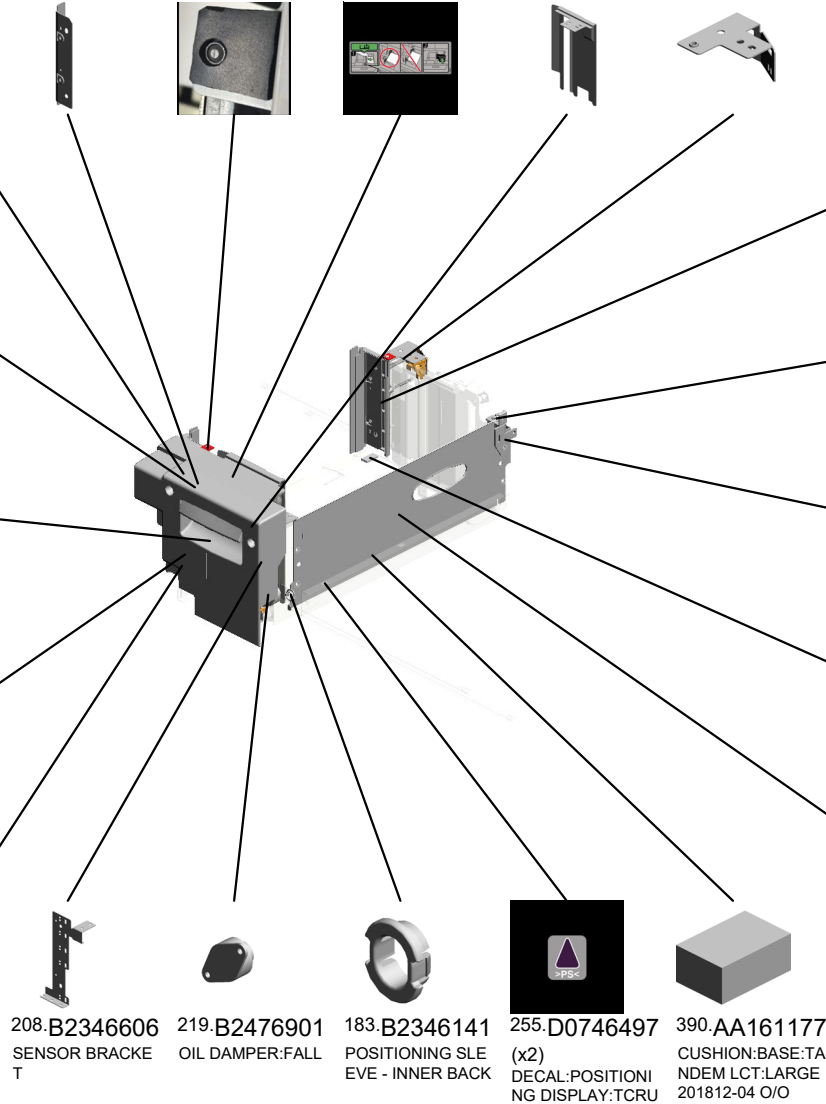
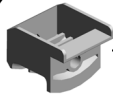

210.B2346625
 END FENCE - REAR



216.B2476695
 GUIDE:MISFEED REMOVAL:PAPER TRAY

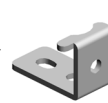

215.B2476672
 GUIDE:INTERLOCK:TANDEM LCT



391.AA161178
 (x2)
 CUSHION:BASE:TANDEM LCT:SMALL
 201812-05 O/O

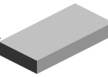

249.D0596668
 SIDE PLATE:SIDE:TANDEM LCT

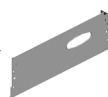

208.B2346606
 SENSOR BRACKET



219.B2476901
 OIL DAMPER:FALL



183.B2346141
 POSITIONING SLIDE - INNER BACK



255.D0746497
 (x2)
 DECAL:POSITIONING DISPLAY:TCRU



390.AA161177
 CUSHION:BASE:TANDEM LCT:LARGE
 201812-04 O/O



U006_S019
(EU,AA,TWN,KOR):TANDEM LCT:RIGHT:ASS'Y

405.D0BX7595
(NA/EU,AA,TWN,KOR):BASE:TANDEM LCT:RIGHT:ADHESION
201907-13 X/O

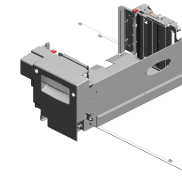
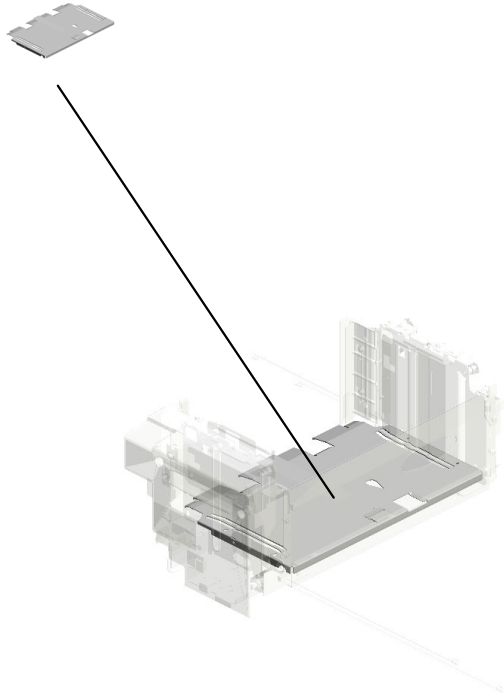

408.D2706646
[A]
(EU,AA,TWN,KOR):
TANDEM LCT:RIGHT:ASS'Y
201909-01 X/O



D2706680
[A]
(EU,AA,TWN,KOR):
TANDEM LCT:RIGHT:ASS'Y
201909-01 X/O

U001	U002	U003	U004	U005	U006	U007	U008	U009	U010	U011	U012	U013	U014	U015	U016	U017	U018	U019	U020	U021
------	------	------	------	------	-------------	------	------	------	------	------	------	------	------	------	------	------	------	------	------	------

U006_S019_S001
SIDE FENCE:TANDEM LCT:RIGHT:ASS'Y

77-AA001509
DECAL:SIDE FENC
E:16X30

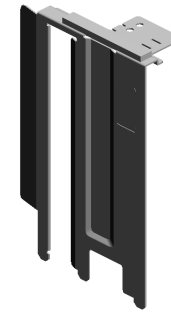
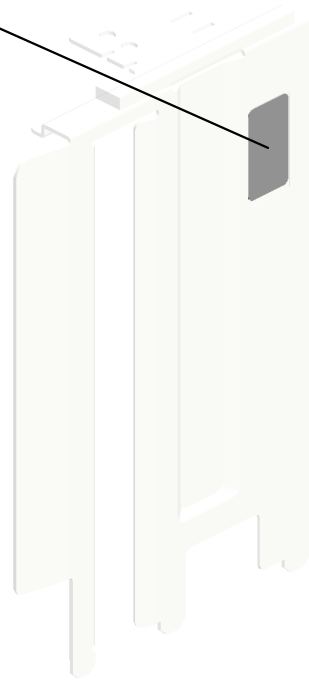

213-B2346691
SIDE FENCE:TAND
EM LCT:RIGHT:AS
SY

U001	U002	U003	U004	U005	U006	U007	U008	U009	U010	U011	U012	U013	U014	U015	U016	U017	U018	U019	U020	U021
------	------	------	------	------	-------------	------	------	------	------	------	------	------	------	------	------	------	------	------	------	------

U006_S019_S002
DC SOLENOID:END FENCE:FRONT:ASS'Y

1-03130040N
(x2)
SCREW:M3X4

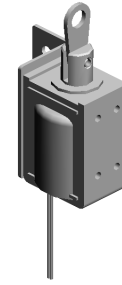

346-D2236722
DC SOLENOID:EN
D FENCE:FRONT:A
SS'Y

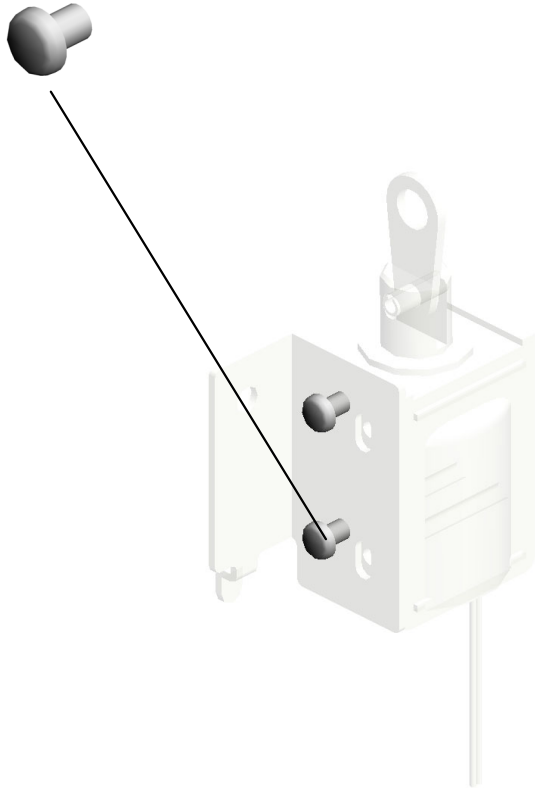

U001	U002	U003	U004	U005	U006	U007	U008	U009	U010	U011	U012	U013	U014	U015	U016	U017	U018	U019	U020	U021
------	------	------	------	------	-------------	------	------	------	------	------	------	------	------	------	------	------	------	------	------	------

U006_S019_S003
DC SOLENOID:END FENCE:REAR:ASS'Y

1-03130040N
(x2)
SCREW:M3X4

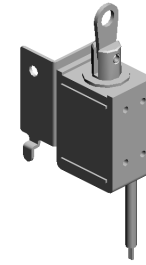

347.D2236732
DC SOLENOID:EN
D FENCE:REAR:AS
S'Y

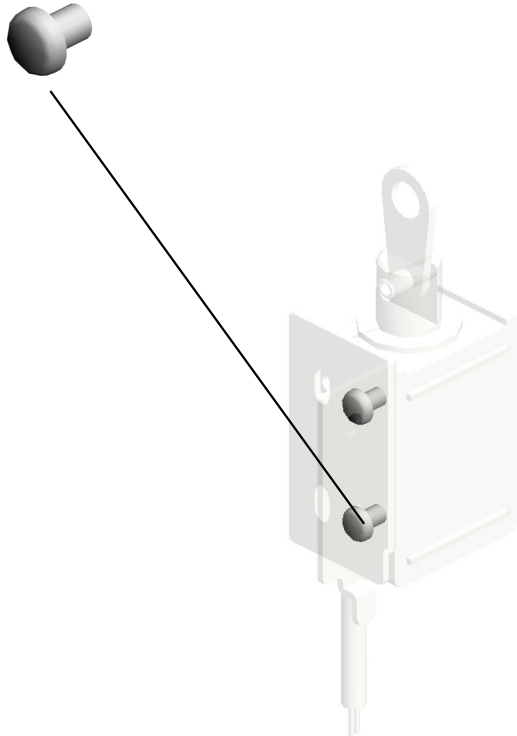

U001	U002	U003	U004	U005	U006	U007	U008	U009	U010	U011	U012	U013	U014	U015	U016	U017	U018	U019	U020	U021
------	------	------	------	------	-------------	------	------	------	------	------	------	------	------	------	------	------	------	------	------	------

U006_S020
(EU,AA,TWN,KOR):TANDEM LCT:LEFT:ASS'Y

- 31.07200040E (x5) RETAINING RING - M4
- 154.B0656823 (x6) TIMING BELT COVER
- 11.04504008N (x2) TAPPING SCREW - M4X8
- 89.AA060987 TENSION SPRING: TIMING BELT:10N
- 80.AA043271 TIMING BELT S3M 196T

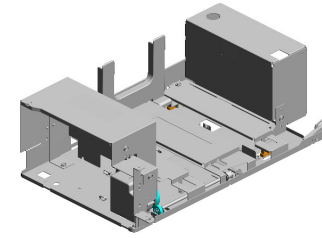

410.D2707558
[A]
(EU,AA,TWN,KOR):
TANDEM LCT:LEFT
:ASS'Y
201911-01 O/O

12.04504010N
(x2)
TAPPING SCREW:
M4X10



123.AB033085
TIMING PULLEY - 1
5T



71.A2946643
LEFT FRONT FENCE



138.AW020163
PAPER FEED SENSOR



10.04503008N
(x3)
TAPPING SCREW -
M3X8



24.04544006Q
(x3)
TAPPING SCREW:
4X6



119.AB019475
GEAR - 48T



115.AB013798
GEAR - Z18



100.AA140686
SHAFT - TIMING P
ULLEY



21.04534006N
BINDING SELF TAP
PING SCREW:4X6



46.11050328
(x4)
HARNES CLAMP -
ES-0505



50.11050511
(x2)
HARNES CLAMP -
LWS-0306ZC



51.11050516
(x7)
CLAMP



2.03130080N(x 2)
PAN HEAD SCREW:M3X8
24.04544006Q(x 1)
TAPPING SCREW:4X6

15.04514006N
(x22)
TAPPING SCREW -
4X6



122.AB033084
TIMING PULLEY - 1
5T



58.50530447
(x2)
BUSHING - 6MM



U001	U002	U003	U004	U005	U006	U007	U008	U009	U010	U011	U012	U013	U014	U015	U016	U017	U018	U019	U020	U021
------	------	------	------	------	------	------	------	------	------	------	------	------	------	------	------	------	------	------	------	------

U006_S020
(EU,AA,TWN,KOR):TANDEM LCT:LEFT:ASS'Y

- 341.D1947552 SIDE PLATE:TANDEM LCT:LEFT SIDEWAYS
- 172.B1327561 BACK FENCE:LEFT
- 173.B1327564 SLIDER:BACK FENCE:LEFT
- 361.D2706721 COVER:GUARD:HANDNESS
- 220.B2476950 SHAFT:SLIDER:BACK FENCE

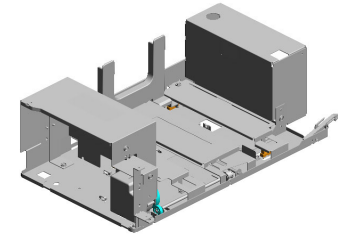

410.D2707558
[A]
(EU,AA,TWN,KOR):
TANDEM LCT:LEFT
:ASS'Y
201911-01 O/O

409.D2707389
DECAL:PAPER SE
T DIRECTION:TAN
DEM LCT:LEFT
201909-02 O/O



421.D0EZ6646
INNER COVER:TA
NDEM LCT:LEFT
202311-02 O/O

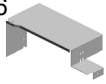

221.B2476951
BRACKET:PULLEY:
DRIVEN:ASS'Y

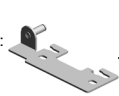

214.B2347540
TRAY BOTTOM PL
ATE:LEFT FRONT

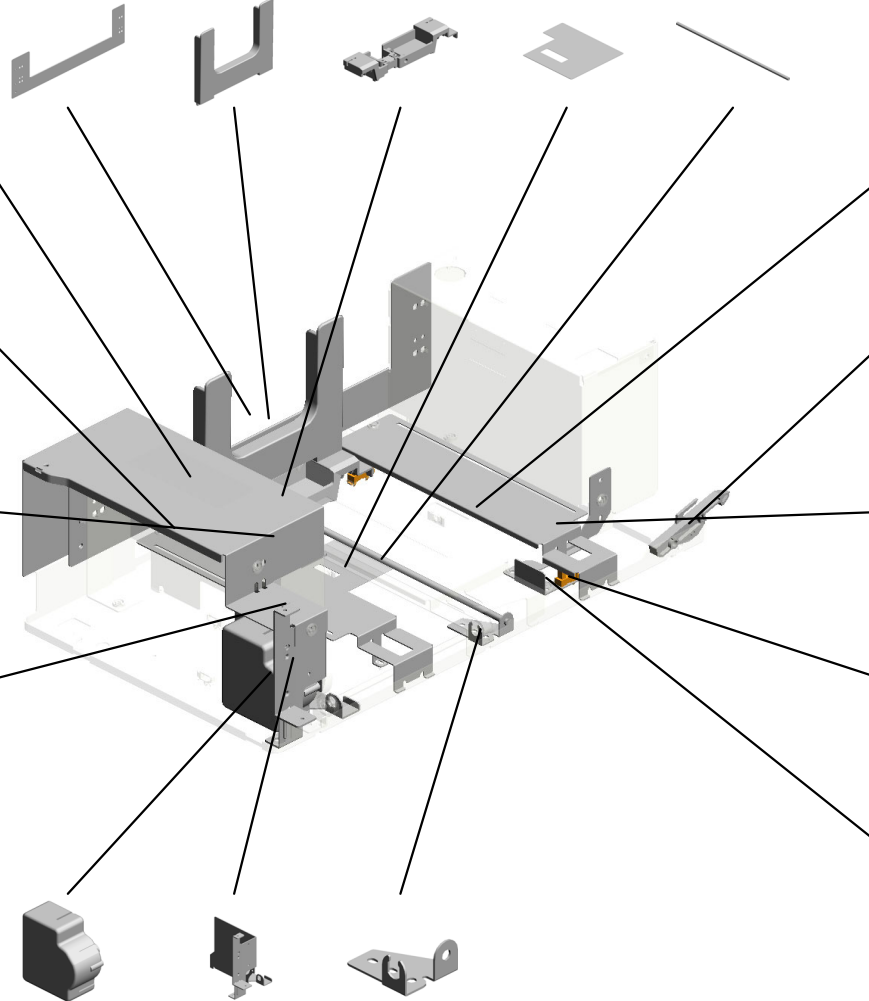

170.B1327541
TRAY BOTTOM PL
ATE:LEFT REAR



244.D0596620
LEVER:COUPLING:
LEFT



246.D0596659
SUPPORTING PLA
TE:SIDE FENCE:LE
FT



395.GW020024
(x2)
PHOTOINTERRUP
TOR:LG2A24BL1:G
F
201902-08 O/O



156.B0656831
SENSOR BRACK
ET



- 348.D2236747 DC MOTOR:TANDEM LCT:19.2W:BRUSH
- 248.D0596665 BRACKET:DC MOTOR:LEFT:ASS'Y
- 155.B0656830 PULLEY BRACKET



D2707556
[A]
(EU,AA,TWN,KOR):
TANDEM LCT:LEFT
:ASS'Y
201911-01 O/O

U006_S020_S001
(NA/EU,AA,TWN,KOR):TRAY BOTTOM PLATE:LEFT MIDDLE:ASS'Y

263.D0747387
(NA/EU,AA,TWN,K
OR):DECAL:BASE:
TANDEM LCT:LEFT

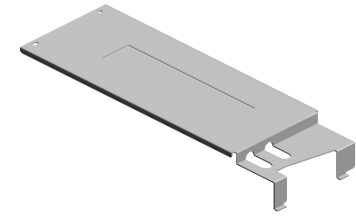
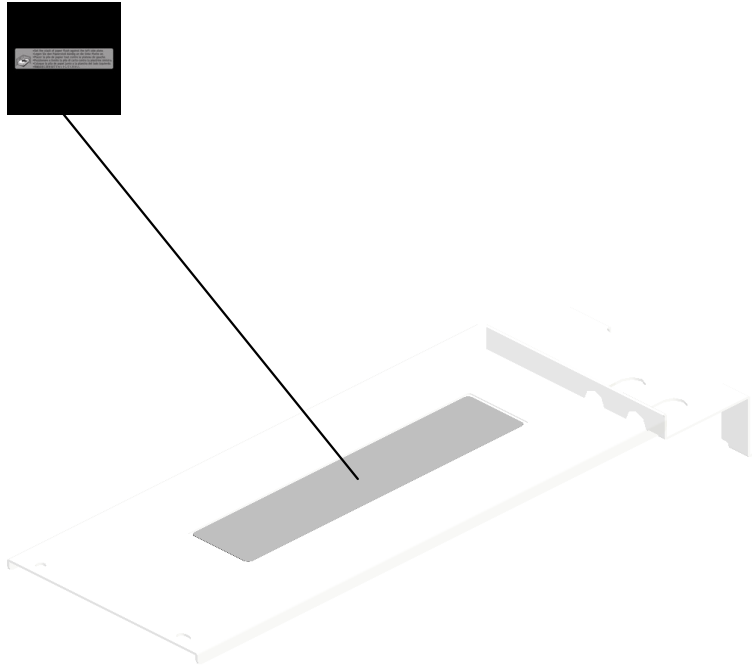

281.D0747596
(NA/EU,AA,TWN,K
OR):TRAY BOTTO
M PLATE:LEFT MID
DLE:ASS'Y

U001	U002	U003	U004	U005	U006	U007	U008	U009	U010	U011	U012	U013	U014	U015	U016	U017	U018	U019	U020	U021
------	------	------	------	------	-------------	------	------	------	------	------	------	------	------	------	------	------	------	------	------	------

U006_S020_S002
SIDE FENCE:TANDEM LCT:LEFT REAR:ASS'Y

76-AA001508
DECAL:SIDE FENC
E:40X30

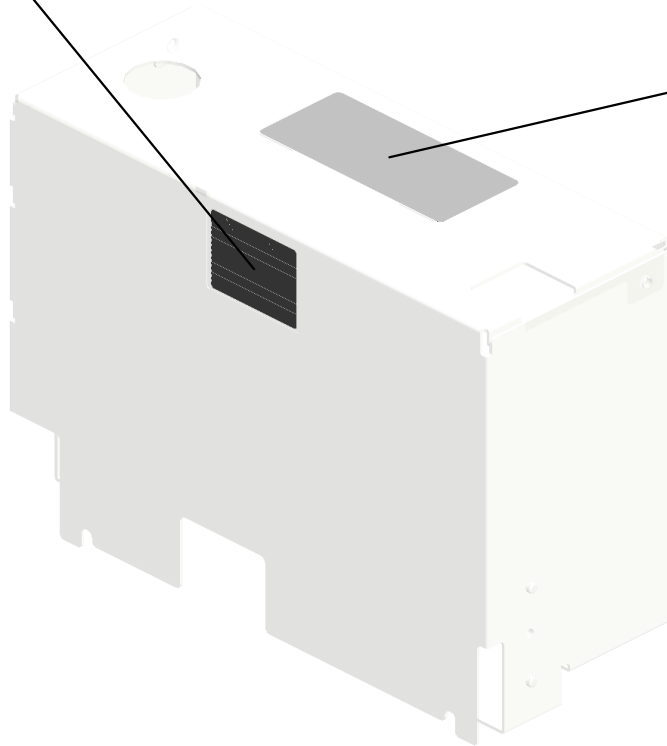

384.D2707548
DECAL:CAUTION:INSERT:PAPER FEED SUB-UNIT
201803-01 O/O

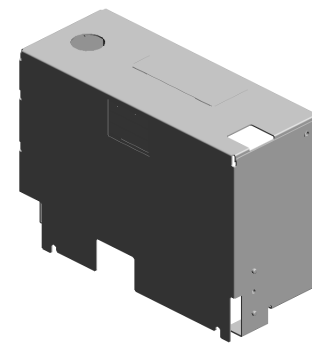
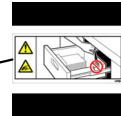

389.D2707544
[A]
SIDE FENCE:TANDEM LCT:LEFT REAR:ASS'Y
201809-03 O/O



D1797544
[A]
SIDE FENCE:TANDEM LCT:LEFT REAR:ASS'Y
201809-03 O/O

U006_S021
(CHN):TANDEM LCT:RIGHT:ASS'Y

67.A2486695 (x4) GUIDE - PULLEY
 28.06330200G (x2) PIN - M3X20
 57.50530223 (x3) BUSHING - 8MM
 16.04514008N (x14) TAPPING SCREW:
 22.04534008N BINDING SELF TAP PING SCREW:4X8

359.D2706687
(CHN):TANDEM LC
T:RIGHT:ASS'Y

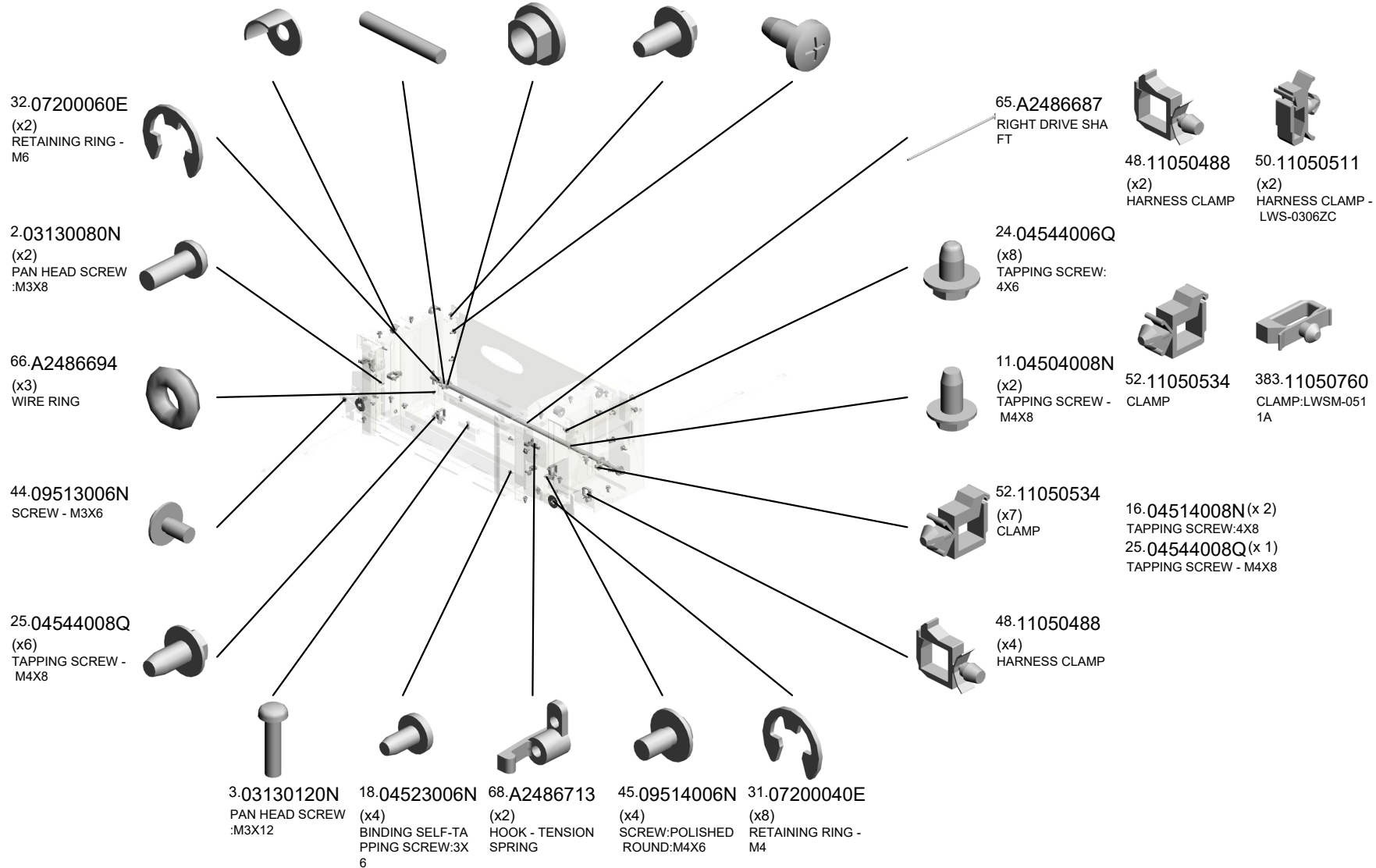
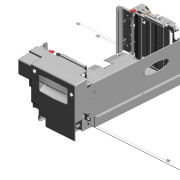

U001	U002	U003	U004	U005	U006	U007	U008	U009	U010	U011	U012	U013	U014	U015	U016	U017	U018	U019	U020	U021
------	------	------	------	------	------	------	------	------	------	------	------	------	------	------	------	------	------	------	------	------

U006_S021
(CHN):TANDEM LCT:RIGHT:ASS'Y

164.B0706684 LEVER:RELEASE:R
EAR
136.AW010113 SENSOR
159.B0656870 (x2)
STAY -RIGHTBASE
87.AA060758 (x2)
TENSION SPRING -
SHORT
120.AB032058 (x2)
WIRE PULLEY - M1
0

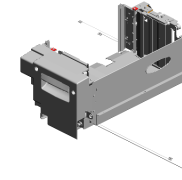

359.D2706687
(CHN):TANDEM LC
T:RIGHT:ASS'Y

99.AA132203
SPACER - 6MM



157.B0656862
LARGE LEVER



130.AF022105
ROLLER - SLIDE R
AIL



158.B0656864
SMALL LEVER



171.B1327550
(x2)
COVER:PULLEY:DRIVE WERE



174.B1327575
BRACKET:CONNECTOR:TANDEM LC
T



162.B0706667
END FENCE COVER FRONT



163.B0706683
LEVER:RELEASE:FRONT



86.AA060757 (x2)
TENSION SPRING - LONG



152.B0656717
PAPER VOLUME S
HIELD PLATE



121.AB032719
(x2)
PULLEY - M10



161.B0656875
PROTECTION -INNER COVER



160.B0656872
OIL DAMPER BRACKET



114.AB013781
GEAR - 30Z



73.A2946690
FEELER - PAPER HEIGHT SENSOR



U001	U002	U003	U004	U005	U006	U007	U008	U009	U010	U011	U012	U013	U014	U015	U016	U017	U018	U019	U020	U021
------	------	------	------	------	------	------	------	------	------	------	------	------	------	------	------	------	------	------	------	------

U006_S021
(CHN):TANDEM LCT:RIGHT:ASS'Y

216.B2476695 GUIDE:MISFEED R
EMOVAL:PAPER T
RAY

215.B2476672 GUIDE:INTERLOCK
:TANDEM LCT

390.AA161177 CUSHION:BASE:TA
NDEM LCT:LARGE
201812-04 O/O

356.D2706678 (x2)
COVER:CUSHION

249.D0596668 SIDE PLATE:SIDE:
TANDEM LCT

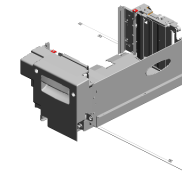

359.D2706687
(CHN):TANDEM LC
T:RIGHT:ASS'Y

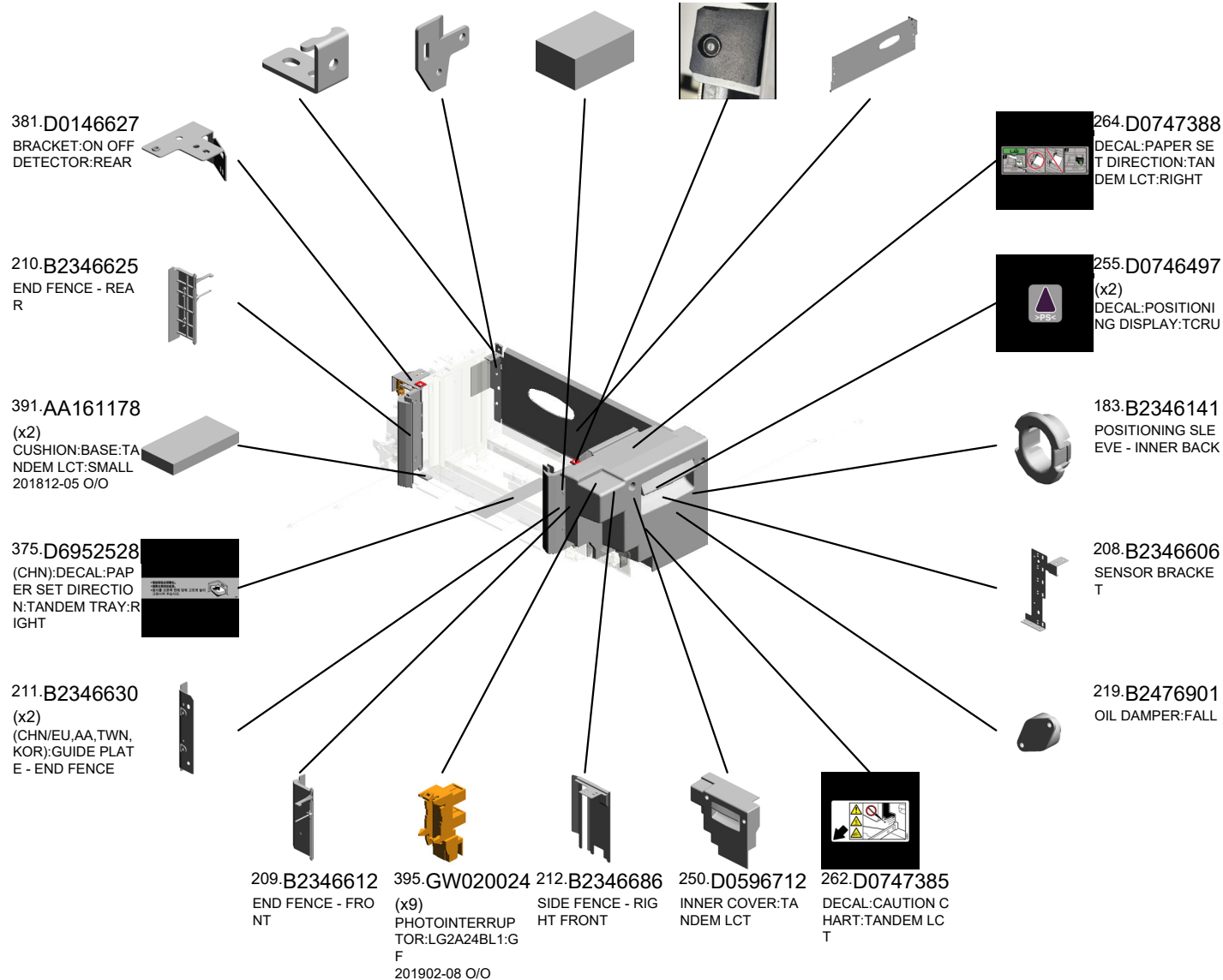

U006_S021
(CHN):TANDEM LCT:RIGHT:ASS'Y

398.D0BX6677
ROLLER:SLIDE RAI
L:FRONT
201903-02 O/O

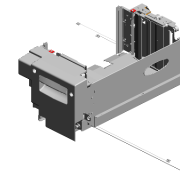

359.D2706687
(CHN):TANDEM LC
T:RIGHT:ASS'Y

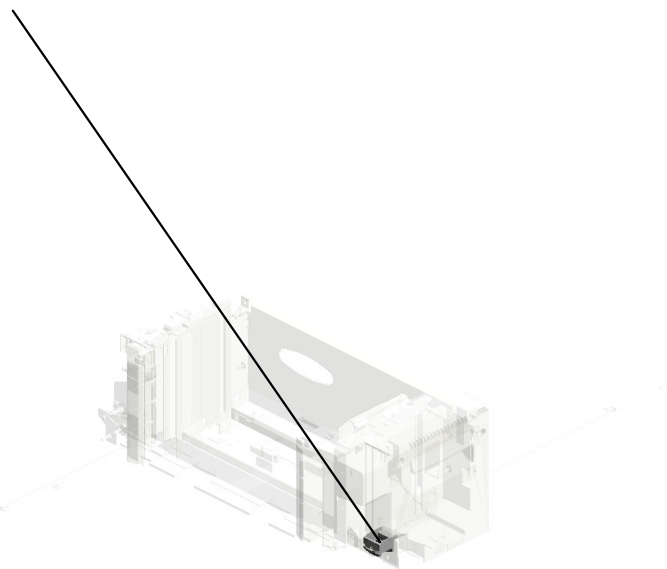
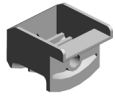

U001	U002	U003	U004	U005	U006	U007	U008	U009	U010	U011	U012	U013	U014	U015	U016	U017	U018	U019	U020	U021
------	------	------	------	------	-------------	------	------	------	------	------	------	------	------	------	------	------	------	------	------	------

U006_S021_S001
SIDE FENCE:TANDEM LCT:RIGHT:ASS'Y

77-AA001509
DECAL:SIDE FENC
E:16X30

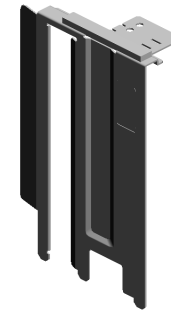
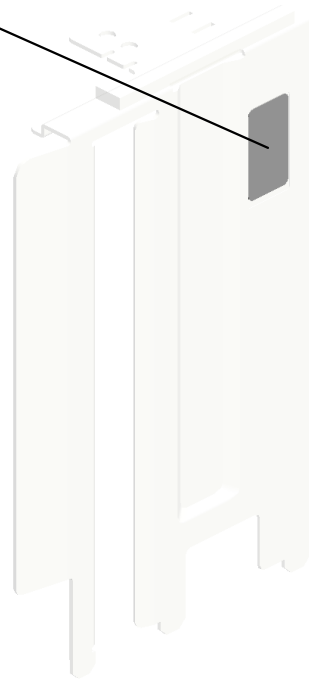

213-B2346691
SIDE FENCE:TAND
EM LCT:RIGHT:AS
SY

U001	U002	U003	U004	U005	U006	U007	U008	U009	U010	U011	U012	U013	U014	U015	U016	U017	U018	U019	U020	U021
------	------	------	------	------	-------------	------	------	------	------	------	------	------	------	------	------	------	------	------	------	------

U006_S021_S002
DC SOLENOID:END FENCE:FRONT:ASS'Y

1-03130040N
(x2)
SCREW:M3X4

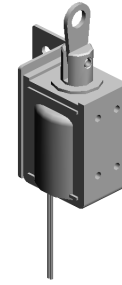

346-D2236722
DC SOLENOID:EN
D FENCE:FRONT:A
SS'Y

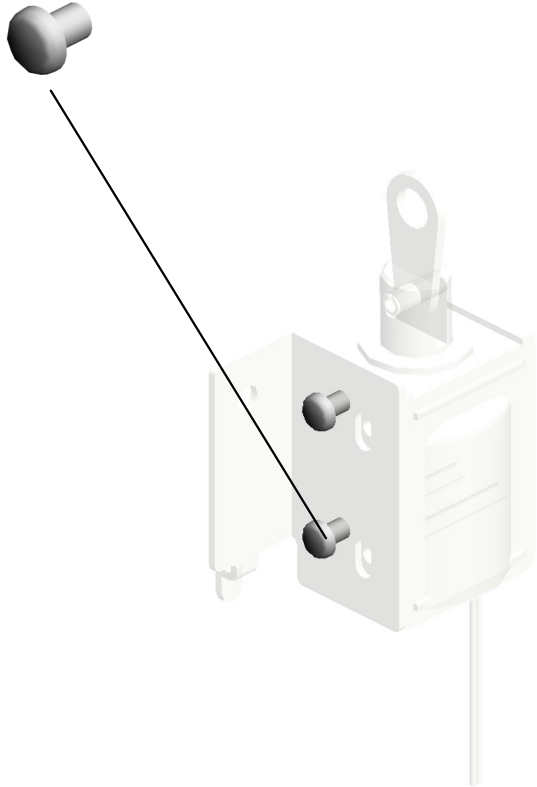

U001	U002	U003	U004	U005	U006	U007	U008	U009	U010	U011	U012	U013	U014	U015	U016	U017	U018	U019	U020	U021
------	------	------	------	------	-------------	------	------	------	------	------	------	------	------	------	------	------	------	------	------	------

U006_S021_S003
DC SOLENOID:END FENCE:REAR:ASS'Y

1-03130040N
(x2)
SCREW:M3X4

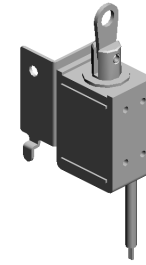

347.D2236732
DC SOLENOID:EN
D FENCE:REAR:AS
S'Y

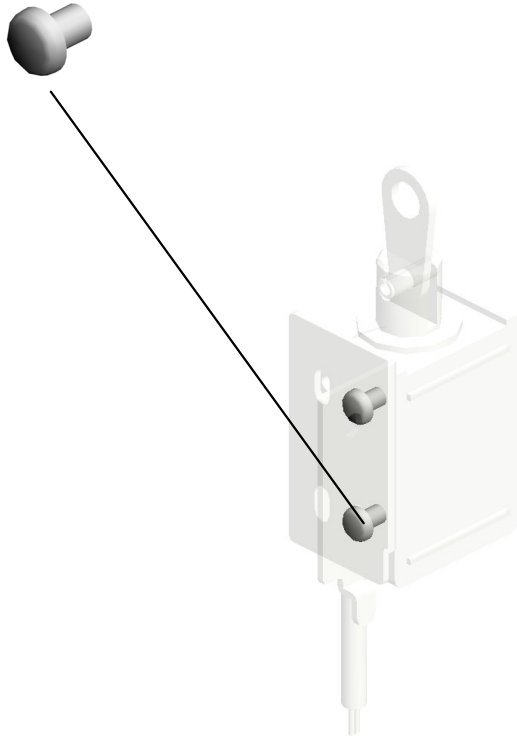

U001	U002	U003	U004	U005	U006	U007	U008	U009	U010	U011	U012	U013	U014	U015	U016	U017	U018	U019	U020	U021
------	------	------	------	------	-------------	------	------	------	------	------	------	------	------	------	------	------	------	------	------	------

U006_S022
(CHN):TANDEM LCT:LEFT:ASS'Y

- 46.11050328 (x4) HARNESS CLAMP - ES-0505
- 12.04504010N (x2) TAPPING SCREW: M4X10
- 51.11050516 (x7) CLAMP
- 15.04514006N (x22) TAPPING SCREW - 4X6
- 80.AA043271 TIMING BELT S3M 196T

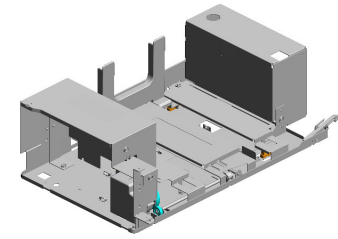

360.D2706688
(CHN):TANDEM LC
T:LEFT:ASSY

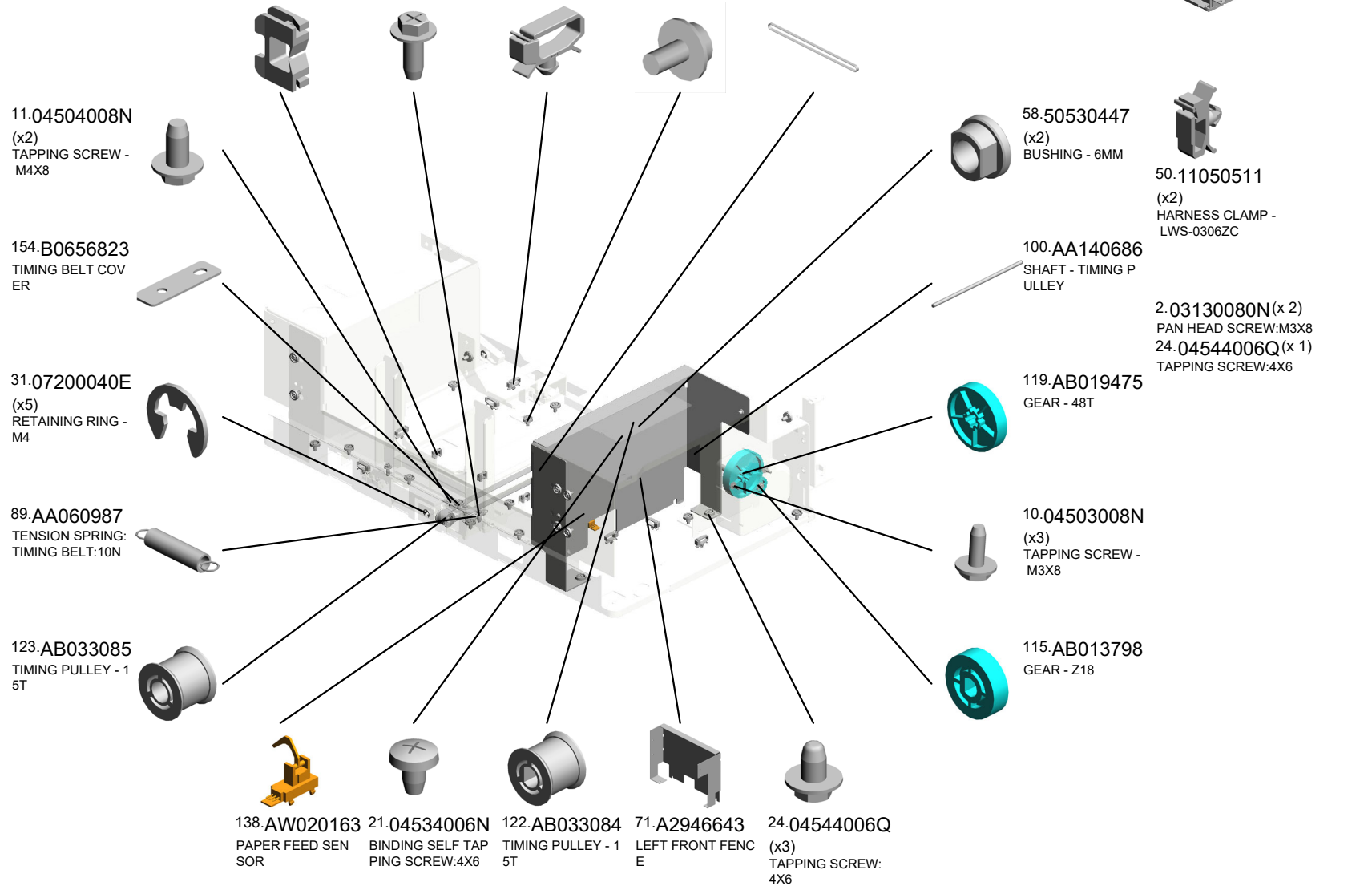

U001	U002	U003	U004	U005	U006	U007	U008	U009	U010	U011	U012	U013	U014	U015	U016	U017	U018	U019	U020	U021
------	------	------	------	------	------	------	------	------	------	------	------	------	------	------	------	------	------	------	------	------

U006_S022
(CHN):TANDEM LCT:LEFT:ASS'Y

- 244.D0596620 LEVER:COUPLING:LEFT
- 246.D0596659 SUPPORTING PLATE:SIDE FENCE:LEFT
- 376.D6952529 (CHN):DECAL:PAPER SET DIRECTION:TANDEM TRAY:LEFT
- 395.GW020024 (x2) PHOTOINTERRUPTOR:LG2A24BL1:GF 201902-08 O/O
- 156.B0656831 SENSOR BRACKET

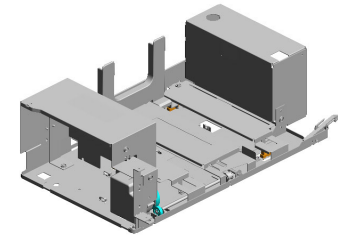

- 360.D2706688 (CHN):TANDEM LCT:LEFT:ASSY

- 170.B1327541 TRAY BOTTOM PLATE:LEFT REAR

- 172.B1327561 BACK FENCE:LEFT

- 341.D1947552 SIDE PLATE:TANDEM LCT:LEFT SIDEWAYS

- 173.B1327564 SLIDER:BACK FENCE:LEFT

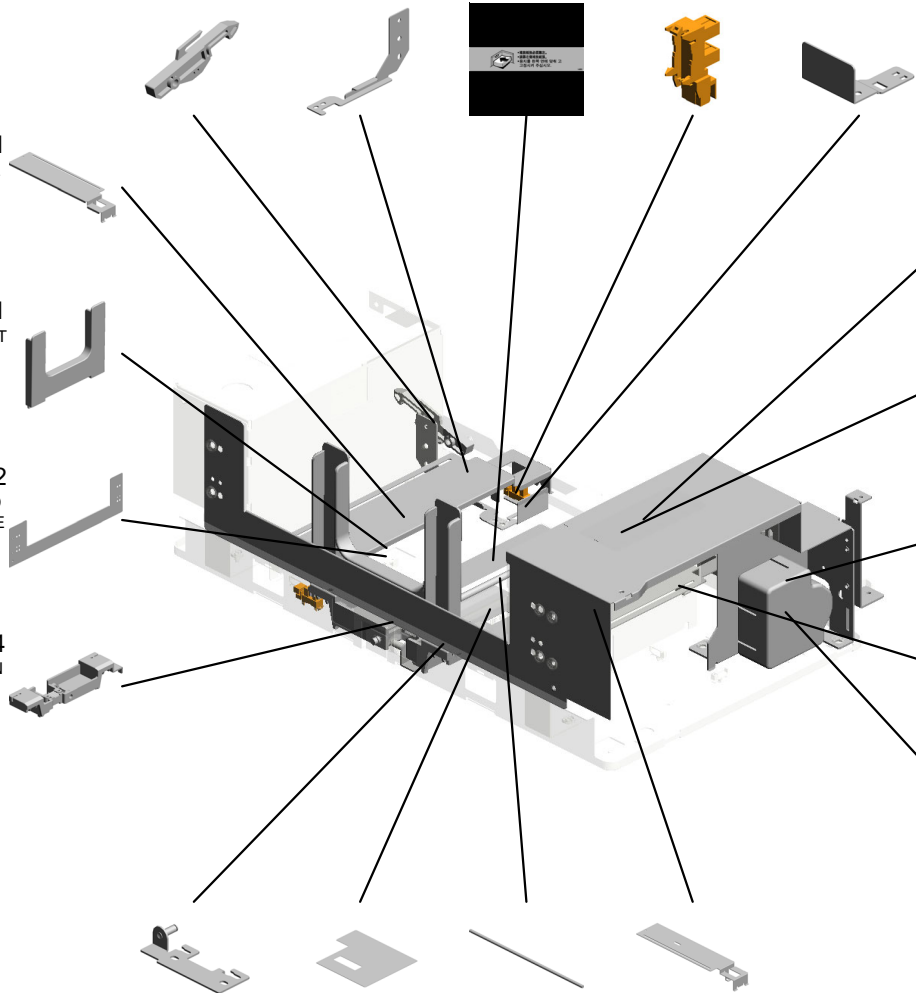

- 409.D2707389 DECAL:PAPER SET DIRECTION:TANDEM LCT:LEFT 201909-02 O/O

- 155.B0656830 PULLEY BRACKET

- 248.D0596665 BRACKET:DC MOTOR:LEFT:ASSY

- 421.D0EZ6646 INNER COVER:TANDEM LCT:LEFT 202311-02 O/O

- 348.D2236747 DC MOTOR:TANDEM LCT:19.2W:BRUSH

- 221.B2476951 BRACKET:PULLEY:DRIVEN:ASSY
- 361.D2706721 COVER:GUARD:HAZARDNESS
- 220.B2476950 SHAFT:SLIDER:BACK FENCE
- 214.B2347540 TRAY BOTTOM PLATE:LEFT FRONT

U006_S022_S001
SIDE FENCE:TANDEM LCT:LEFT REAR:ASS'Y

76-AA001508
DECAL:SIDE FENC
E:40X30

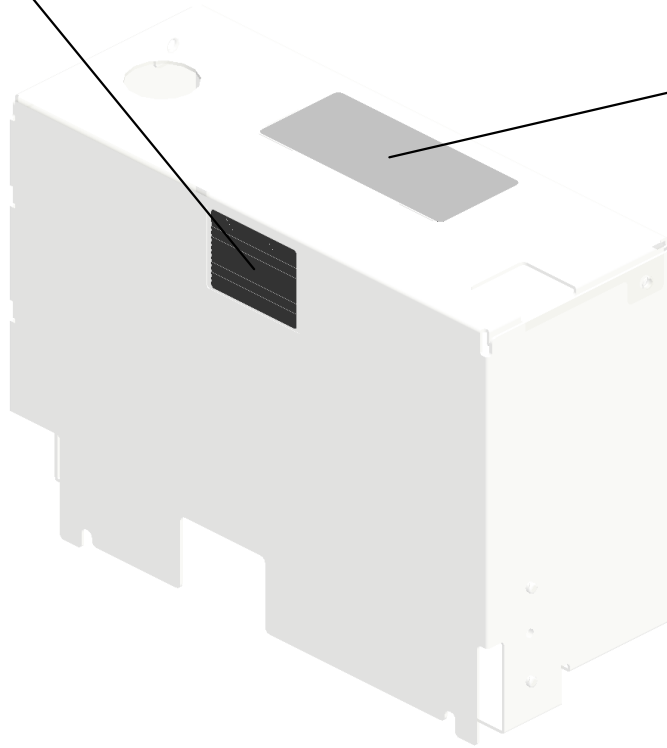

384.D2707548
DECAL:CAUTION:INSERT:PAPER FEED SUB-UNIT
201803-01 O/O

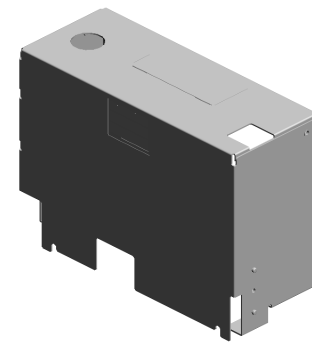
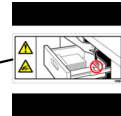

389.D2707544
[A]
SIDE FENCE:TANDEM LCT:LEFT REAR:ASS'Y
201809-03 O/O



D1797544
[A]
SIDE FENCE:TANDEM LCT:LEFT REAR:ASS'Y
201809-03 O/O

U001	U002	U003	U004	U005	U006	U007	U008	U009	U010	U011	U012	U013	U014	U015	U016	U017	U018	U019	U020	U021
------	------	------	------	------	-------------	------	------	------	------	------	------	------	------	------	------	------	------	------	------	------

U007.PAPER FEED

U007 S002
D1792703
TRANSPORT ROLLER:CONNECTING:LARGE CAPACITY T
RAY:PRESS FIT

U007 S001
D1792702
TIMING ROLLER:REGISTRATION:DRIVE

U007 S004
D2702771
ARM:REGISTRATION:TIMING
:ASSY

U007 S007
D1792758
GEAR:Z41:TIMING PULLEY:TY
41

U007 S003
D1792704
TRANSPORT ROLLER:CONNECTING:MAIN

U007 S006
D1792758
GEAR:Z41:TIMING PULLEY:TY
41

U007 S010
D0742739
PRESSURE ROLLER:TRANSPORT ROLLER:SHIFT:DRIVE
N

U007 S012
D0742739
PRESSURE ROLLER:TRANSPORT ROLLER:SHIFT:DRIVE
N

U007 S005
D2702766
TIMING ROLLER:TRANSFER:DRIVE

U007 S009
D0742739
PRESSURE ROLLER:TRANSPORT ROLLER:SHIFT:DRIVE
N

U007 S008
D0742681
SHAFT:CAM:SHIFT

U007 S011
D0742739
PRESSURE ROLLER:TRANSPORT ROLLER:SHIFT:DRIVE
N

U001	U002	U003	U004	U005	U006	U007	U008	U009	U010	U011	U012	U013	U014	U015	U016	U017	U018	U019	U020	U021
------	------	------	------	------	------	------	------	------	------	------	------	------	------	------	------	------	------	------	------	------

U007.PAPER FEED

U007 S014
D1792705
TRANSPORT ROLLER:SHIFT
:TRAILING EDGE

U007 S015
D2705422
PCB:DRB

U007 S013
D2702602
REGISTRATION ROLLER:GA
TE:ASS'Y

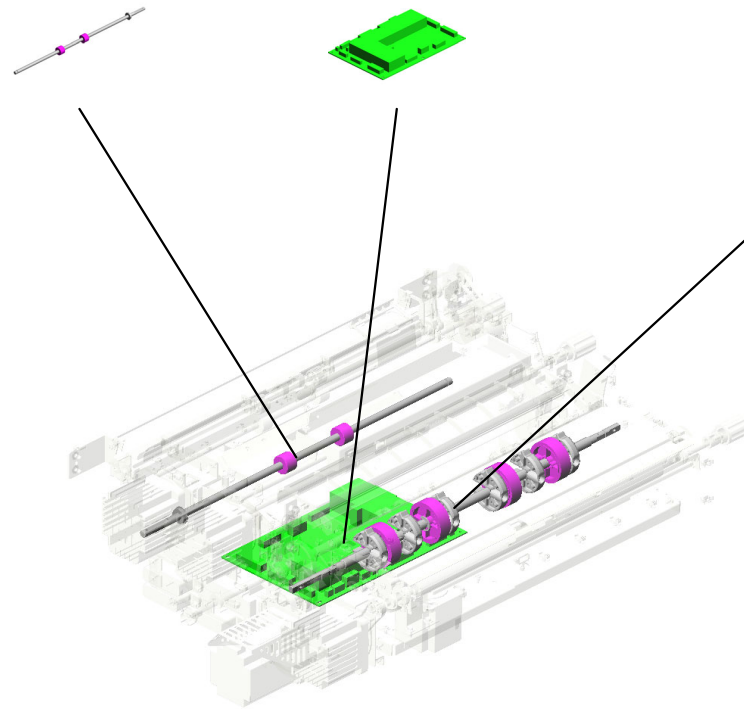

U001	U002	U003	U004	U005	U006	U007	U008	U009	U010	U011	U012	U013	U014	U015	U016	U017	U018	U019	U020	U021
------	------	------	------	------	------	------	------	------	------	------	------	------	------	------	------	------	------	------	------	------

U007 PAPER FEED

- 11.04544008Q (x2) TAPPING SCREW - M4X8
- 18.07403808 (x4) BALL BEARING - 8 X16X5MM
- 7.04513006N (x101) TAPPING SCREW - 3X6
- 20.07413708 (x2) BALL BEARING - 8 X12X3.5MM
- 2.03530060N (x9) BIND SCREW - M3 X6

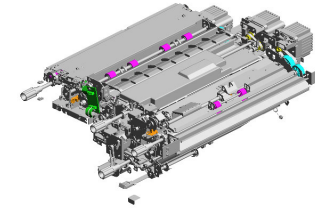

- 8.04514008N (x4) TAPPING SCREW: 4X8

- 6.03604008N (x31) SCREW - M4X8

- 9.04543006Q (x28) TAPPING SCREW - M3X6

- 4.03603006N (x8) SCREW - M3X6

- 10.04543008Q (x6) TAPPING SCREW: 3X8

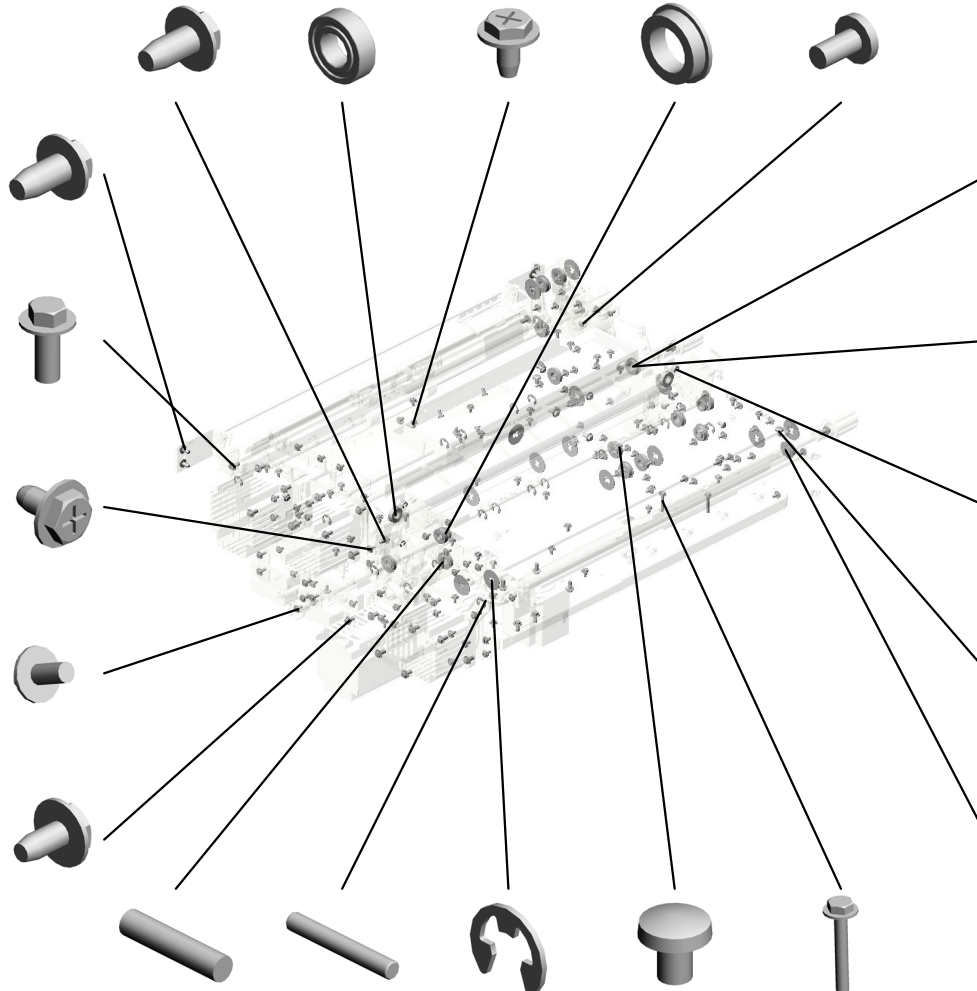

- 13.06330140G (x2) PARALLEL PIN - 3X14
- 12.06320140G PARALLEL PIN
- 15.07200040E (x14) RETAINING RING - M4
- 1.03530040N SCREW - M3X4
- 5.03603020N (x2) SCREW:M3X20

- 16.07200060E (x33) RETAINING RING - M6

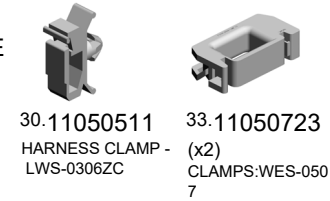

- 30.11050511 HARNESS CLAMP - LWS-0306ZC
- 33.11050723 (x2) CLAMPS:WES-0507

- 21.07433808 (x13) RADIAL BALL BEARING: DIA8X DIA16X 5

- 14.07200030E (x4) RETAINING RING - M3

- 3.03540060N (x2) SCREW-M4X6

- 22.08050088 (x2) RETAINING RING - M6

- 4.03603006N (x 2) SCREW - M3X6
- 9.04543006Q (x 2) TAPPING SCREW - M3X6
- 16.07200060E (x 1) RETAINING RING - M6

U007 PAPER FEED

- 36.54472681 SNAP RING
- 30.11050511 (x55) HARNESS CLAMP - LWS-0306ZC
- 43.AA066403 TORSION SPRING: GUIDE PLATE:FRO NT
- 32.11050692 (x6) CLAMP:LES-0503
- 40.AA061192 (x2) TENSION SPRING: TIMING ROLLER

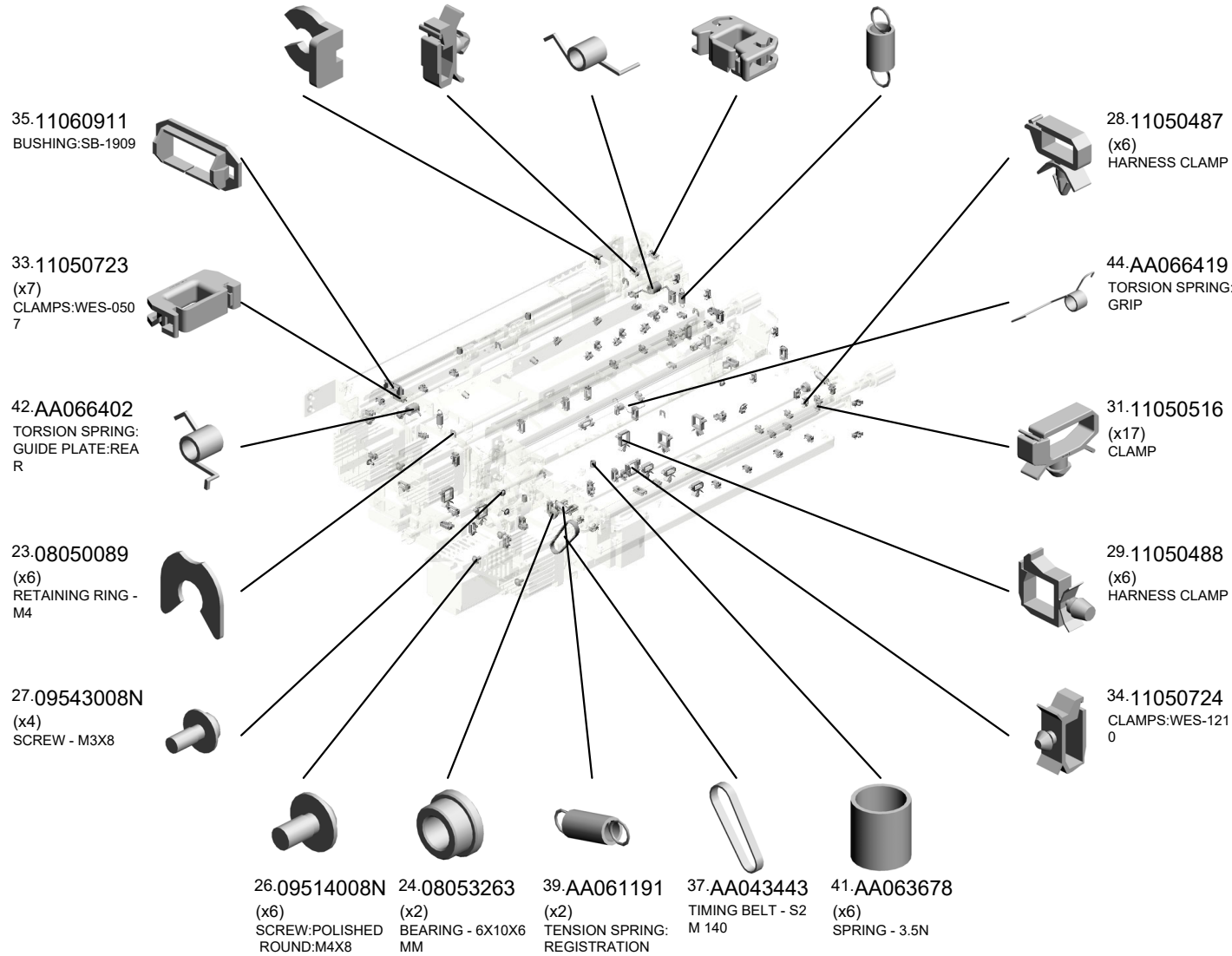
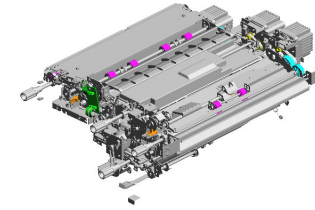

U007 PAPER FEED

- 50.AA120150 DISCHARGE BRUS
H:REVERSE:17MM
- 65.B2346424 RELEASE GRIP
- 45.AA080346 (x2)
BUSHING:FLANGE
TYPE:DIA6
- 58.AG070513 MAGNET CATCH
- 61.AX040280 (x2)
STEPPER MOTOR:
DRIVE

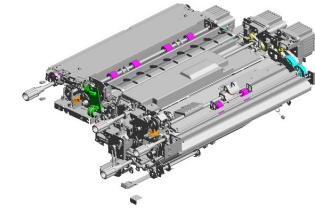

- 54.AB030842 TIMING PULLEY:S2
M:30T



- 47.AA082144 (x6)
BUSHING - 8X12X7



- 55.AF022167 (x3)
TRANSPORT ROLLER - DRIVEN



- 48.AA084059 (x6)
BALL BEARING HOLDER

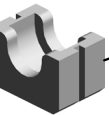

- 53.AB014243 (x2)
GEAR:IDLER:Z30



- 63.AX060424 DC STEPPER MOT
OR:MM56XL76



- 60.AX040276 (x3)
STEPPER MOTOR:
MM56:TRANSPOR
T



- 52.AA161180 (x4)
CUSHION:DC STE
PPER MOTOR



- 62.AX040297 (x2)
STEPPER MOTOR:
MM56:TRANSPOR
T



- 57.AG051141 RELEASE LEVER



- 56.AG050100 (x4)
KNOB - TRANSPOR
RT ROLLER



- 64.B2345280 PCB CRB



- 49.AA120127 (x2)
DISCHARGE BRUS
H:FUSING



- 46.AA082104 (x2)
BUSHING - 8X12X7



- 51.AA143812 SCREW - SCALE



U007 PAPER FEED

- 68.B2382675 (x2) REGISTRATION ROLLER BUSHING
- 79.D0742799 GUIDE PLATE:CONNECTION:LCT:LOWER
- 80.D0742938 GUIDE PLATE:CONNECTION:LARGE CAPACITY TRAY:UPPER
- 85.D0746165 PULLEY:ON-OFF-BELT TENSIONER
- 83.D0742970 CAM:GUIDE PLATE:OPEN AND CLOSE

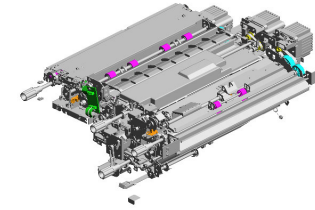

- 81.D0742942 PIN:GUIDE PLATE:CONNECTION:LARGE CAPACITY TRAY:UPPER

- 70.B8341648 TIMING BELT - B60 S2M120

- 71.BB013040 (x2) GEAR:SHIFT:ROLLER:Z30

- 69.B8301135 SCREW

- 87.D0931266 DECAL:WARNING (HIGH TEMPERATURE):LENGTHWISE

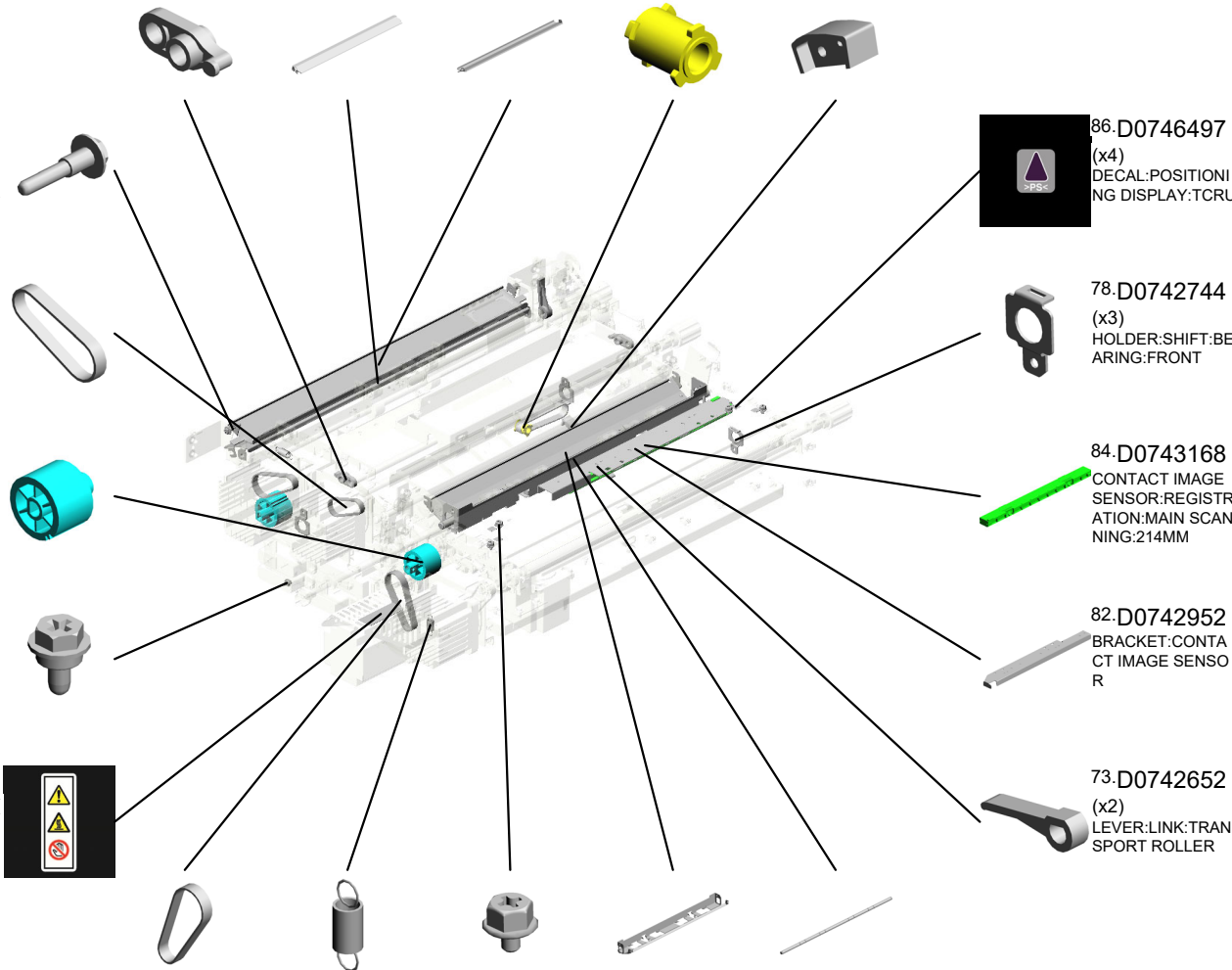

- 86.D0746497 (x4) DECAL:POSITIONING DISPLAY:TCRU

- 78.D0742744 (x3) HOLDER:SHIFT:BEARING:FRONT

- 84.D0743168 CONTACT IMAGE SENSOR:REGISTRATION:MAIN SCANNING:214MM

- 82.D0742952 BRACKET:CONTACT IMAGE SENSOR

- 73.D0742652 (x2) LEVER:LINK:TRANSPORT ROLLER

- 67.B2346533 (x3) TIMING BELT - S2 M152
- 66.B2346508 (x2) TENSION SPRING
- 72.D0592399 (x4) FLANGED HEXAGONAL HEAD BOLT: M3*4
- 89.D1792631 GUIDE PLATE:SHIFT:REGISTRATION:UPPER
- 88.D1792621 SHAFT:DRIVEN ROLLER:SHIFT

U007 PAPER FEED

- 97.D1792666 GUIDE PLATE:REGISTRATION:TIMING:UPPER
- 110.D1792727 SHAFT:TIMING ROLLER:REGISTRATION:DRIVEN
- 98.D1792670 GUIDE PLATE:REGISTRATION:TIMING:LOWER
- 99.D1792675 COVER:REGISTRATION:DOUBLE FEE D SENSOR
- 100.D1792684 REGISTRATION GUIDE:OPEN AND CLOSE

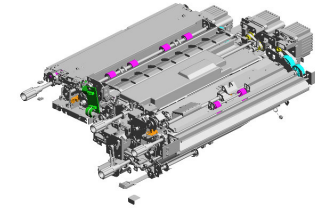

103.D1792691
(x2)
TENSION SPRING:PRESSURE ROLLER



96.D1792661
BRACKET:GUIDE PLATE:INNER BACK:CIS



115.D1792760
COVER:MOTOR



112.D1792754
(x2)
BRACKET:DC STEPPER MOTOR:PAPER FEED



113.D1792757
(x2)
TIGHTENER:BRACKET:DC STEPPER MOTOR



111.D1792751
(x2)
BRACKET:DC STEPPER MOTOR:PAPER FEED:TIMING



104.D1792698
COMPRESSION SPRING:SHIFT



90.D1792642
HOLDER:SHIFT:BEARING:REAR



102.D1792689
COVER:REGISTRATION:EXIT



109.D1792711
TIMING ROLLER:TRANSFER:DRIVEN:PRESS FIT



95.D1792660
BRACKET:GUIDE PLATE:FRONT:CIS



91.D1792643
(x2)
CAM:REGISTRATION:GATE:RELEASE



93.D1792648
PLATE:ADJUSTING PIN



101.D1792685
CASE:REMOVE PAPER DUST:ASSY



94.D1792651
GUIDE PLATE:REGISTRATION:EXIT



U007 PAPER FEED

- 139.D1792946 SHAFT:CAM:ON-OFF:LARGE CAPACITY TRAY
- 137.D1792943 (x2) BRACKET:CAM:ON-OFF
- 138.D1792944 (x2) DISC:ON-OFF:SENSOR
- 129.D1792891 GUIDE PIN:SHIFT:TRAILING EDGE
- 127.D1792861 BRACKET:OPEN AND CLOSE:LARGE CAPACITY TRAY

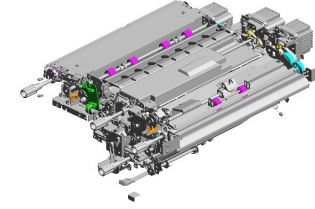

135.D1792933
SHAFT:LINK:ON-OFF:CONNECTING:LARGE CAPACITY TRAY

123.D1792814
(x2)
GUIDE:SHIFT:TRAILING EDGE

122.D1792809
GUIDE PLATE:SHIFT:LEFT LOWER

121.D1792791
BRACKET:DRAWER:MAIN PAPER SMD

133.D1792909
JOINT:CONNECTING:DRIVEN

134.D1792932
(x2)
ARM:ON-OFF:TRANSPORT ROLLER

118.D1792768
TIMING PULLEY:S2M:30T

130.D1792901
GUIDE PLATE:CONNECTING:DUPLIX:EXIT

136.D1792934
SHAFT:LINK:ON-OFF:CONNECTING

120.D1792783
COVER:BASE:MAIN PAPER SMD

125.D1792817
BRACKET:SHIFT:SYNCHRONOUS BELT

116.D1792763
(x2)
CAM:REGISTRATION:TIMING

128.D1792872
BRACKET:DC STEPPER MOTOR:TRAILING EDGE

140.D1792947
SHAFT:CAM:ON-OFF:MAIN

117.D1792764
SHAFT:CAM:REGISTRATION:TIMING

U007 PAPER FEED

161.D2702851 GUIDE PLATE:CONNECTING:OPEN/CLOSE
 159.D2702802 STAY:SHIFT:TRAILING EDGE
 148.D1795435 PCB:URRB
 141.D1792948 (x2) CAM:TRANSPORT ROLLER:ON-OFF
 142.D1792952 BRACKET:DC STEPPER MOTOR:DRIVEN:ON-OFF

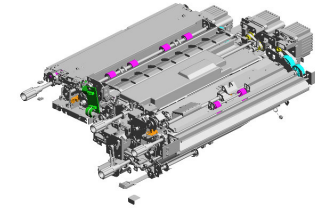

147.D2702986 BRACKET:GUIDE PLATE:CONNECTING:LARGE CAPACITY TRAY 201704-09 O/O

160.D2702810 GUIDE PLATE:SHIFT:RIGHT UPPER:PEEN

143.D1792960 GUIDE PLATE:OPEN AND CLOSE:MAIN:CONNECTING

150.D2702622 (x2) TENSION SPRING: 48N

163.D4342535 TORSION SPRING: PROOF TRAY

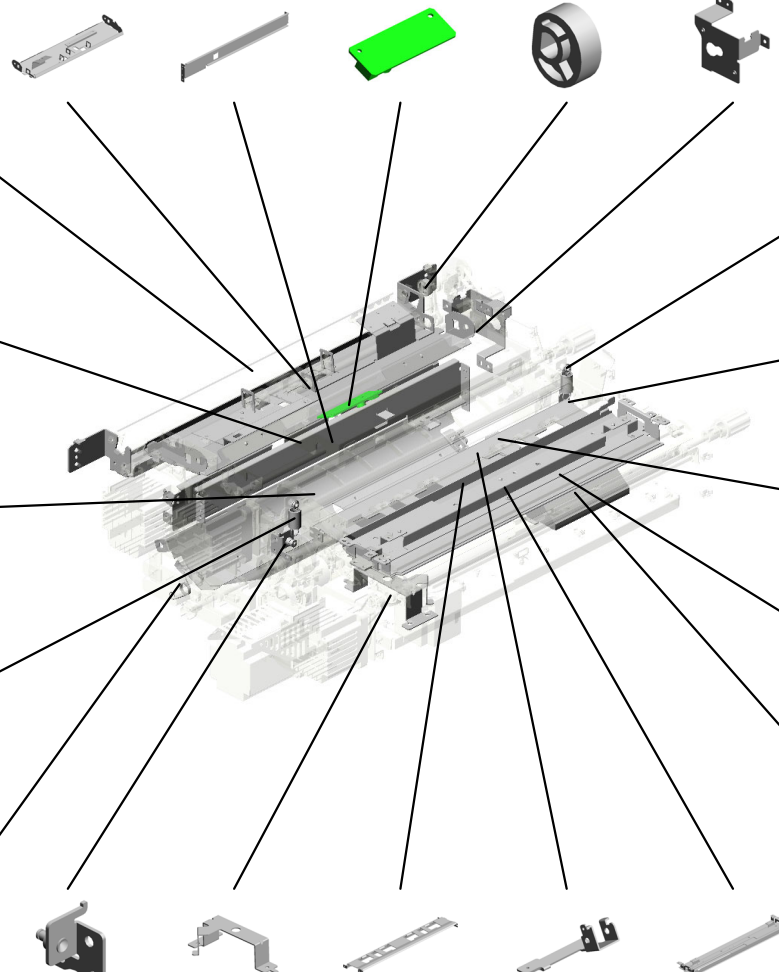

154.D2702637 (x4) COLOR:4M

152.D2702634 BRACKET:HOOK:COIL SPRING:FRONT:PEEN

145.D1792964 GUIDE:MAIN:CONNECTING:OPEN AND CLOSE

155.D2702641 DUCT:SHIFT:CIS

158.D2702786 DUCT:FAN:CONTACT IMAGE SENSOR

151.D2702632 BRACKET:HOOK:COIL SPRING:REAR:PEEN

149.D1942945 HOLDER:CAM:SHIFT

153.D2702636 GUIDE PLATE:SHIFT:REGISTRATION:LOWER

144.D1792963 BRACKET:GRIP:OPEN AND CLOSE:GUIDE PLATE

156.D2702656 GUIDE PLATE:REGISTRATION:CIS

U007 PAPER FEED

- 165.G0602296 (x4) BALL BEARING:8X16X5MM
- 168.G1787660 (x2) PRESSURE ROLLER:TRANSPORT ROLLER
- 169.G1787664 (x12) SPACER
- 164.D7315310 PCB:URTB:DOCUMENT FEEDER:ASSY
- 185.GW020024 (x4) PHOTOINTERRUPTOR:LG2A24BL1:GF 201902-08 O/O

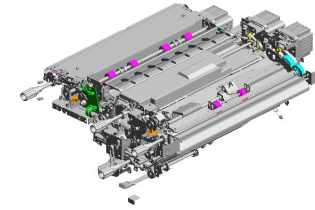

178.D0BX2856
GUIDE PLATE:CONNECTING:LARGE CAPACITY TRAY:PEEN
201805-01 O/O

186.D2702816
SHAFT:TRAILING EDGE:SHIFT
202003-05 O/O

167.G1784900 (x3)
COVER:DC STEPPER MOTOR:MM56

182.D0BX2902
GUIDE PLATE:CONNECTING:UPPER:PEEN
201811-04 X/X

166.G0703088 (x2)
SPACER:DEVELOPMENT ROLLER

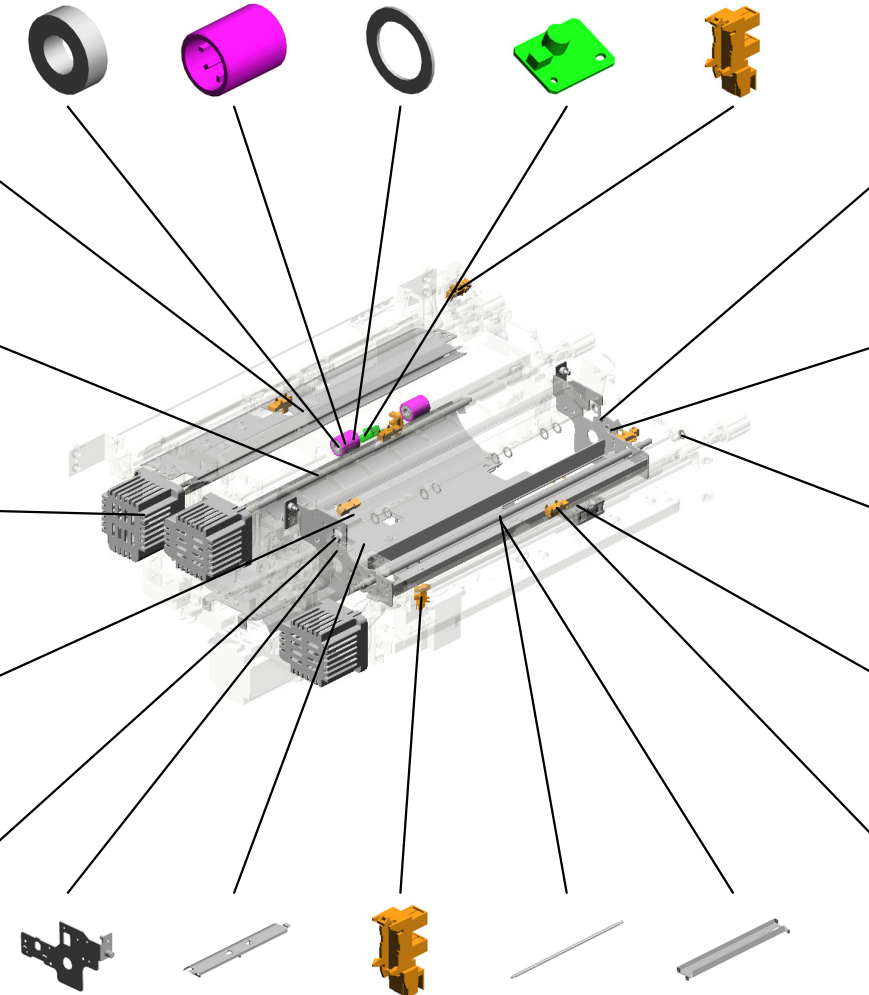

181.D2702624
SIDE PLATE:SHIFT:REGISTRATION:FRONT:PEEN

176.M2057311
DISC:GATE:REGISTRATION:HOME POSITION SENSOR

172.H5194238 (x2)
SPACER:ROLLER:CONNECTING

171.GX640028
FAN MOTOR DC24V 1.92W

170.GW010007 (x5)
PHOTO REFLECTION SENSOR:EXIT

184.D2702627
SIDE PLATE:SHIFT:REGISTRATION:REAR:PEEN

180.D0BX2906
GUIDE PLATE:CONNECTING:LOWER:PEEN
201808-01 O/O

185.GW020024
PHOTOINTERRUPTOR:LG2A24BL1:GF
202211-01 O/O

177.D2702647
SHAFT:SHIFT
201803-02 O/O

183.D2702644
STAY:SHIFT:REGISTRATION:ASSY

U007 PAPER FEED

192.D2702965 193.07922074C
 SHAFT:GUIDE PLATE:OPEN AND CLOSE
 SE 202102-04 O/O
 SYNCHRONOUS BELT:40S2M148:CR
 202108-02 O/O

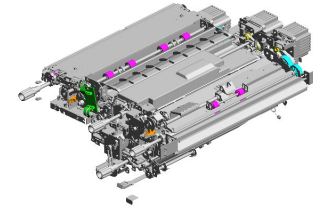

191.D2702744
 BRACKET:HOLDER FOR SHAFT
 202006-06



190.D2702743
 HOLDER:SHAFT:ARM
 202006-05

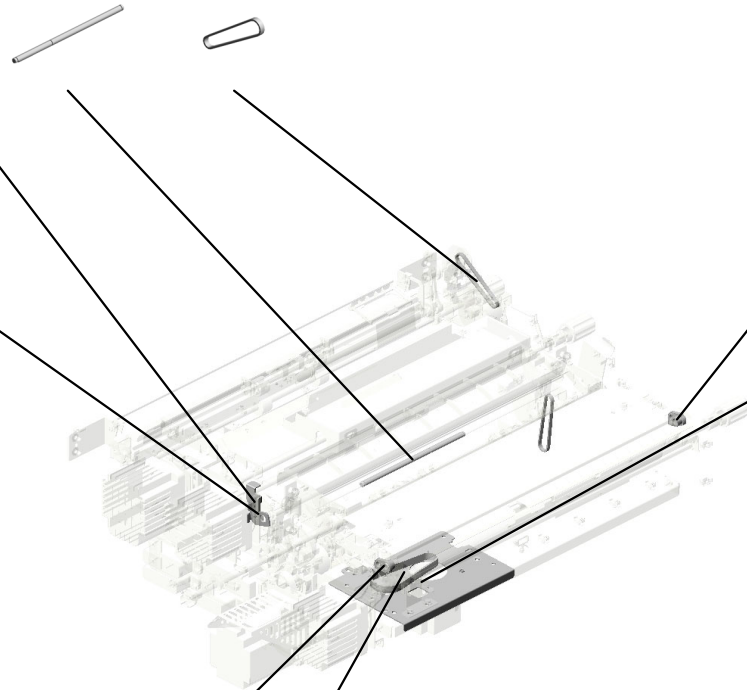

194.M0EB4670
 RADIAL BALL BEARING:REGISTRATION:DRIVEN:FRONT
 202301-03 O/O



188.D0BX2679
 HOLDER:DC STEP PER MOTOR:SHIFT
 202005-01 O/O



195.M0EB4671 189.AA043727
 RADIAL BALL BEARING:REGISTRATION:DRIVEN:REAR
 202301-02 O/O
 SYNCHRONOUS BELT:80S2M190
 202006-04 O/O



U007_S001
TIMING ROLLER:REGISTRATION:DRIVE

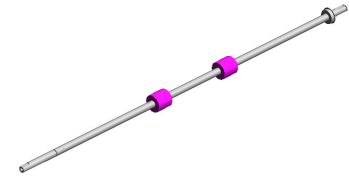

105.D1792702
TIMING ROLLER:R
EGISTRATION:DRI
VE

U001	U002	U003	U004	U005	U006	U007	U008	U009	U010	U011	U012	U013	U014	U015	U016	U017	U018	U019	U020	U021
------	------	------	------	------	------	------	------	------	------	------	------	------	------	------	------	------	------	------	------	------

U007_S002

TRANSPORT ROLLER:CONNECTING:LARGE CAPACITY TRAY:PRESS FIT

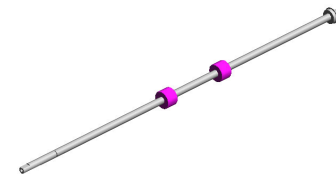

106.D1792703
TRANSPORT ROLLER:CONNECTING:
LARGE CAPACITY TRAY:PRESS FIT

U001	U002	U003	U004	U005	U006	U007	U008	U009	U010	U011	U012	U013	U014	U015	U016	U017	U018	U019	U020	U021
------	------	------	------	------	------	------	------	------	------	------	------	------	------	------	------	------	------	------	------	------

U007_S003
TRANSPORT ROLLER:CONNECTING:MAIN

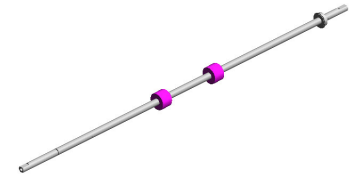

107.D1792704
TRANSPORT ROLLER:CONNECTING:MAIN

U001	U002	U003	U004	U005	U006	U007	U008	U009	U010	U011	U012	U013	U014	U015	U016	U017	U018	U019	U020	U021
------	------	------	------	------	------	------	------	------	------	------	------	------	------	------	------	------	------	------	------	------

U007_S004
ARM:REGISTRATION:TIMING:ASS'Y

16.07200060E
(x6)
RETAINING RING -
M6

18.07403808
(x2)
BALL BEARING - 8
X16X5MM



179.D2702771
[A]
ARM:REGISTRATI
ON:TIMING:ASS'Y
201805-04 O/O

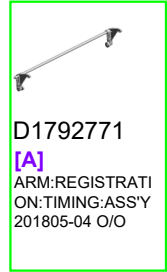

D1792771
[A]
ARM:REGISTRATI
ON:TIMING:ASS'Y
201805-04 O/O

U001	U002	U003	U004	U005	U006	U007	U008	U009	U010	U011	U012	U013	U014	U015	U016	U017	U018	U019	U020	U021
------	------	------	------	------	------	------	------	------	------	------	------	------	------	------	------	------	------	------	------	------

U007_S005
TIMING ROLLER:TRANSFER:DRIVE

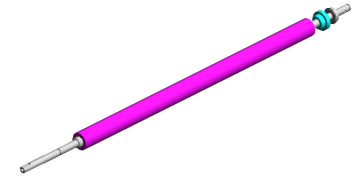

157.D2702766
TIMING ROLLER:T
RANSFER:DRIVE

U001	U002	U003	U004	U005	U006	U007	U008	U009	U010	U011	U012	U013	U014	U015	U016	U017	U018	U019	U020	U021
------	------	------	------	------	------	------	------	------	------	------	------	------	------	------	------	------	------	------	------	------

U007_S006
GEAR:Z41:TIMING PULLEY:T41

18.07403808
(x2)
BALL BEARING - 8
X16X5MM

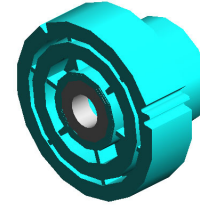

114.D1792758
GEAR:Z41:TIMING
PULLEY:T41

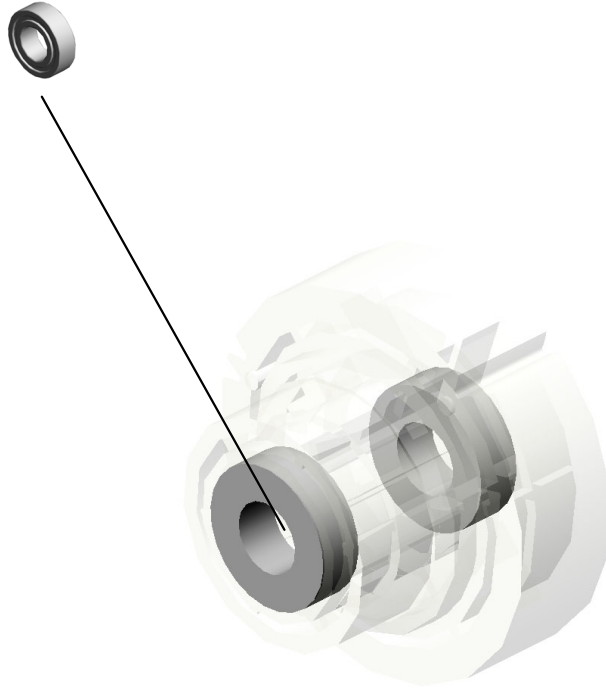

U001	U002	U003	U004	U005	U006	U007	U008	U009	U010	U011	U012	U013	U014	U015	U016	U017	U018	U019	U020	U021
------	------	------	------	------	------	------	------	------	------	------	------	------	------	------	------	------	------	------	------	------

U007_S007
GEAR:Z41:TIMING PULLEY:T41

18.07403808
(x2)
BALL BEARING - 8
X16X5MM

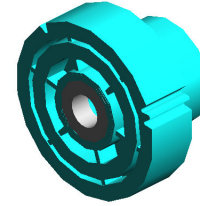

114.D1792758
GEAR:Z41:TIMING
PULLEY:T41

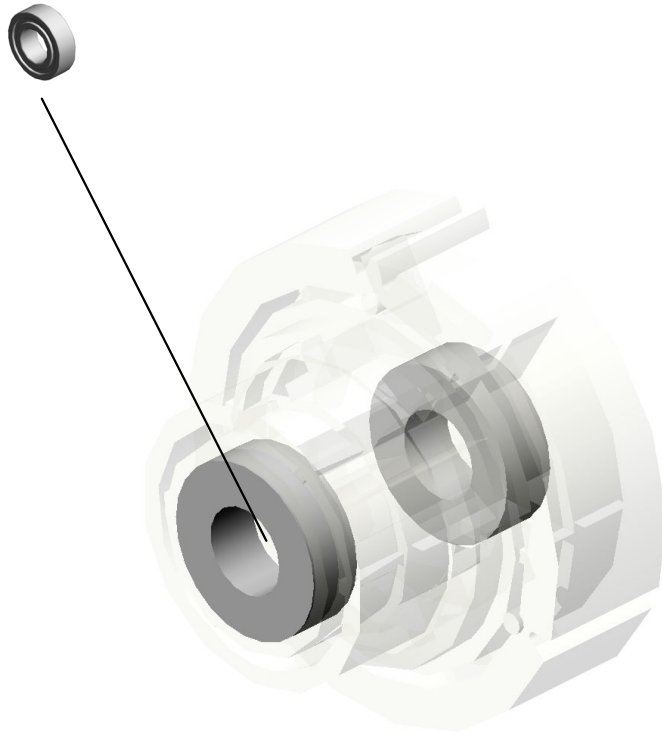

U001	U002	U003	U004	U005	U006	U007	U008	U009	U010	U011	U012	U013	U014	U015	U016	U017	U018	U019	U020	U021
------	------	------	------	------	------	------	------	------	------	------	------	------	------	------	------	------	------	------	------	------

U007_S008
SHAFT:CAM:SHIFT

19.07413706
BALL BEARING - 6
X10X3

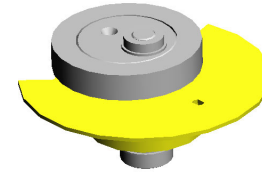

75.D0742681
SHAFT:CAM:SHIFT



U001	U002	U003	U004	U005	U006	U007	U008	U009	U010	U011	U012	U013	U014	U015	U016	U017	U018	U019	U020	U021
------	------	------	------	------	------	------	------	------	------	------	------	------	------	------	------	------	------	------	------	------

U007_S009
PRESSURE ROLLER:TRANSPORT ROLLER:SHIFT:DRIVEN

165.G0602296
(x2)
BALL BEARING:8X
16X5MM

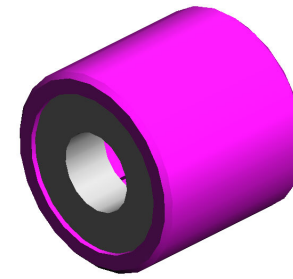
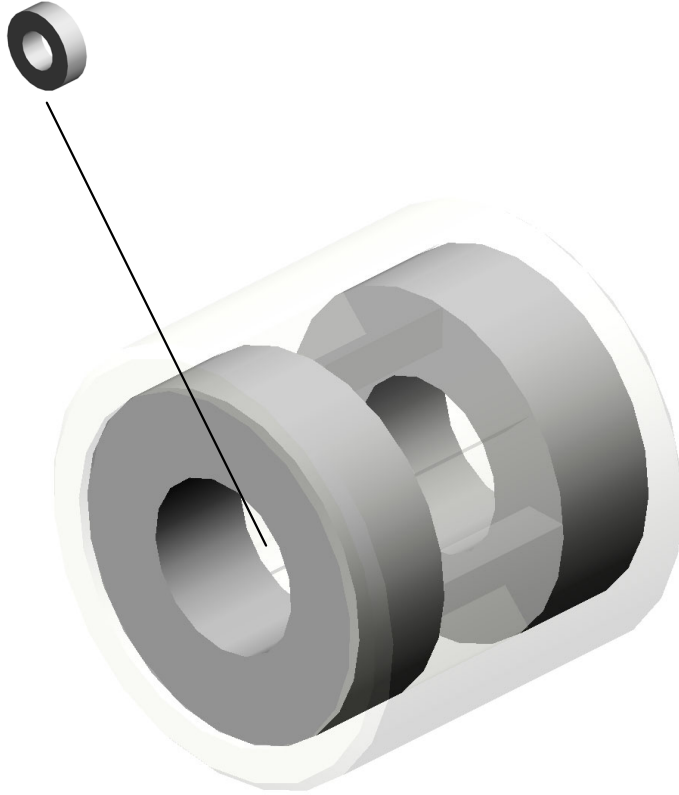

77.D0742739
PRESSURE ROLLER:
TRANSPORT ROLLER:
SHIFT:DRIVEN

U001	U002	U003	U004	U005	U006	U007	U008	U009	U010	U011	U012	U013	U014	U015	U016	U017	U018	U019	U020	U021
------	------	------	------	------	------	------	------	------	------	------	------	------	------	------	------	------	------	------	------	------

U007_S010
PRESSURE ROLLER:TRANSPORT ROLLER:SHIFT:DRIVEN

165.G0602296
(x2)
BALL BEARING:8X
16X5MM

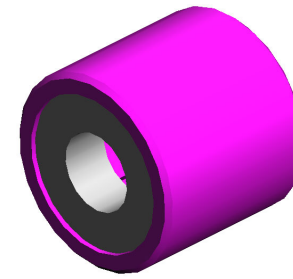
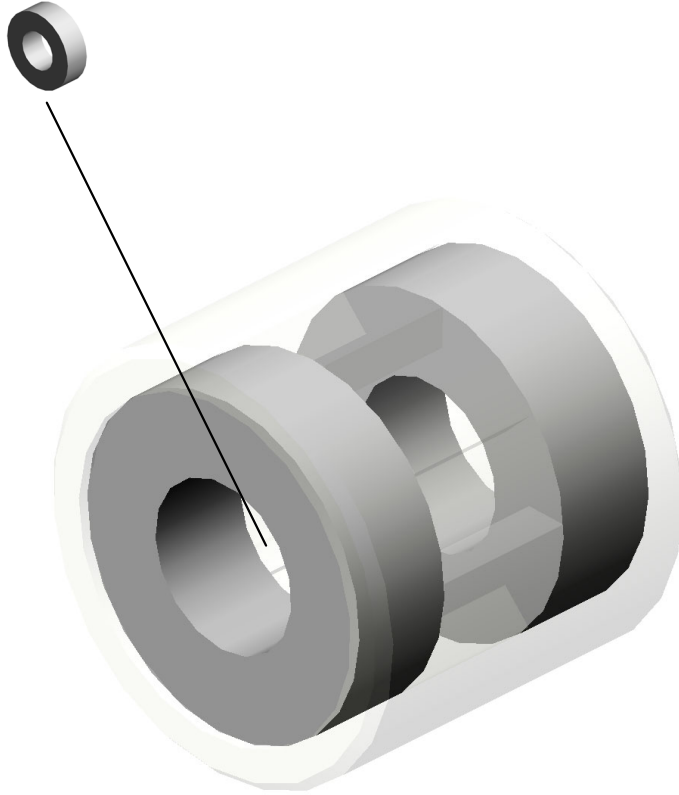

77.D0742739
PRESSURE ROLLER:
TRANSPORT ROLLER:
SHIFT:DRIVEN

U001	U002	U003	U004	U005	U006	U007	U008	U009	U010	U011	U012	U013	U014	U015	U016	U017	U018	U019	U020	U021
------	------	------	------	------	------	------	------	------	------	------	------	------	------	------	------	------	------	------	------	------

U007_S011
PRESSURE ROLLER:TRANSPORT ROLLER:SHIFT:DRIVEN

165.G0602296
(x2)
BALL BEARING:8X
16X5MM

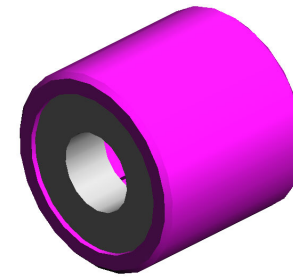
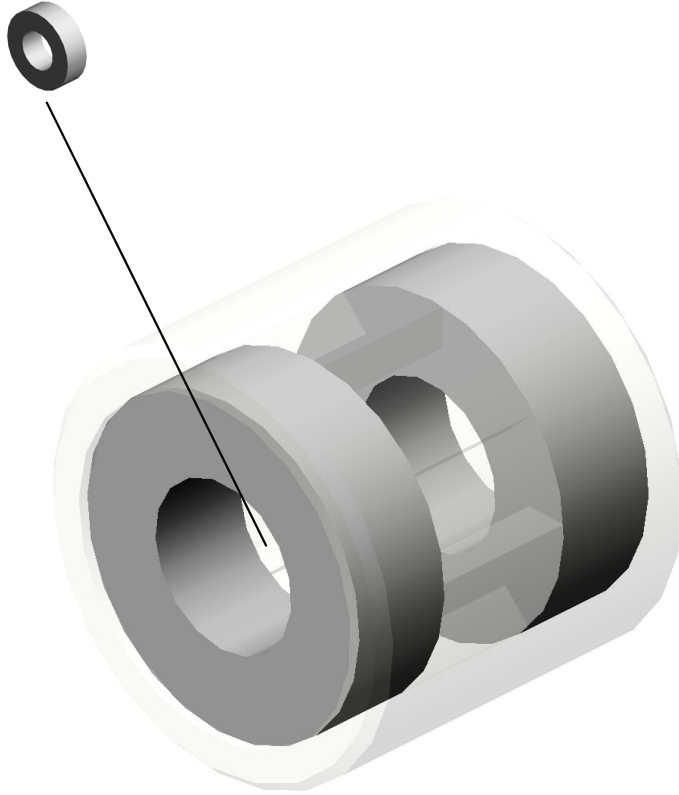

77.D0742739
PRESSURE ROLLER:
TRANSPORT ROLLER:
SHIFT:DRIVEN

U001	U002	U003	U004	U005	U006	U007	U008	U009	U010	U011	U012	U013	U014	U015	U016	U017	U018	U019	U020	U021
------	------	------	------	------	------	------	------	------	------	------	------	------	------	------	------	------	------	------	------	------

U007_S012
PRESSURE ROLLER:TRANSPORT ROLLER:SHIFT:DRIVEN

165.G0602296
(x2)
BALL BEARING:8X
16X5MM

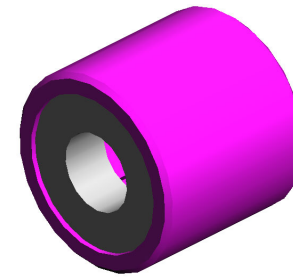
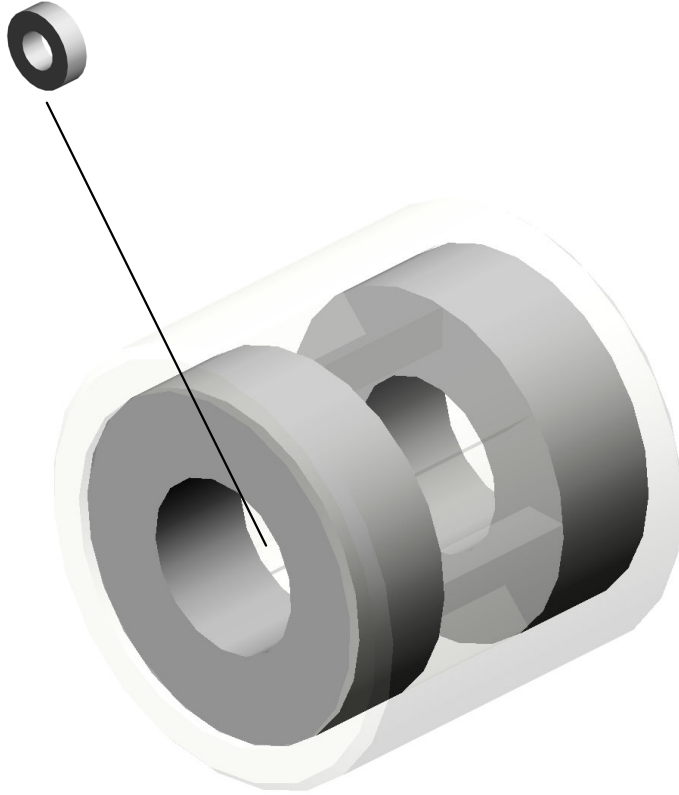

77.D0742739
PRESSURE ROLLER:
TRANSPORT ROLLER:
SHIFT:DRIVEN

U001	U002	U003	U004	U005	U006	U007	U008	U009	U010	U011	U012	U013	U014	U015	U016	U017	U018	U019	U020	U021
------	------	------	------	------	------	------	------	------	------	------	------	------	------	------	------	------	------	------	------	------

U007_S013
REGISTRATION ROLLER:GATE:ASS'Y

17.07200080E
(x4)
RETAINING RING -
M8

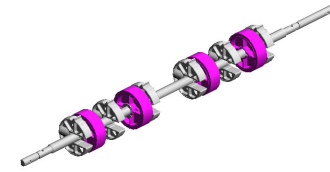
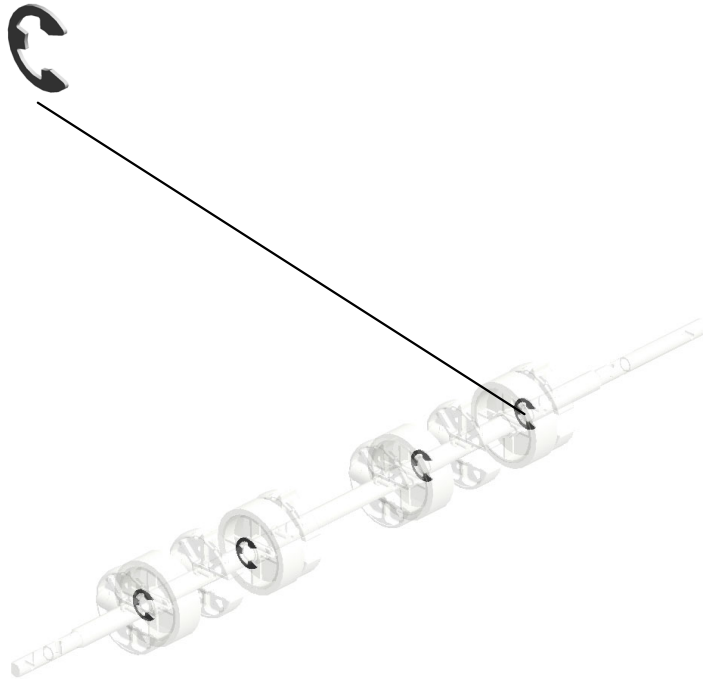

187.D2702602
[A]
REGISTRATION R
OLLER:GATE:ASS'
Y
202004-01 X/O

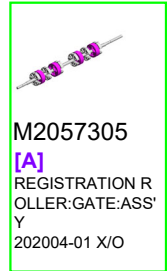

M2057305
[A]
REGISTRATION R
OLLER:GATE:ASS'
Y
202004-01 X/O

U001	U002	U003	U004	U005	U006	U007	U008	U009	U010	U011	U012	U013	U014	U015	U016	U017	U018	U019	U020	U021
------	------	------	------	------	------	------	------	------	------	------	------	------	------	------	------	------	------	------	------	------

U007_S014
TRANSPORT ROLLER:SHIFT:TRAILING EDGE

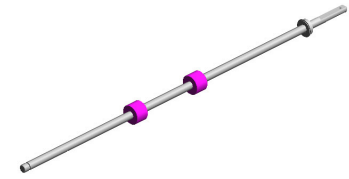

108.D1792705
TRANSPORT ROLLER:SHIFT:TRAILING EDGE

U001	U002	U003	U004	U005	U006	U007	U008	U009	U010	U011	U012	U013	U014	U015	U016	U017	U018	U019	U020	U021
------	------	------	------	------	------	------	------	------	------	------	------	------	------	------	------	------	------	------	------	------

U007_S015
PCB:DRB

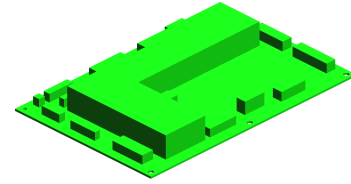

162.D2705422
PCB:DRB

25.09503006N(x 2)
SCREW:SPRING WASHER:M3X6

U001	U002	U003	U004	U005	U006	U007	U008	U009	U010	U011	U012	U013	U014	U015	U016	U017	U018	U019	U020	U021
------	------	------	------	------	------	------	------	------	------	------	------	------	------	------	------	------	------	------	------	------

U008.TONER SUPPLY

U008 S005
D1793334
CASE:TONER BANK:ASS'Y

U008 S006
D1793344
DC MOTOR:TONER BOTTLE:
ASS'Y:BRUSH:5.85W

U008 S002
D1793370
INNER COVER:TONER BANK
:ASS'Y

U008 S004
D1793344
DC MOTOR:TONER BOTTLE:
ASS'Y:BRUSH:5.85W

U008 S003
D1793334
CASE:TONER BANK:ASS'Y

U008 S001
D1793201
TONER SUPPLY UNIT:TONE
R HOPPER:ASS'Y

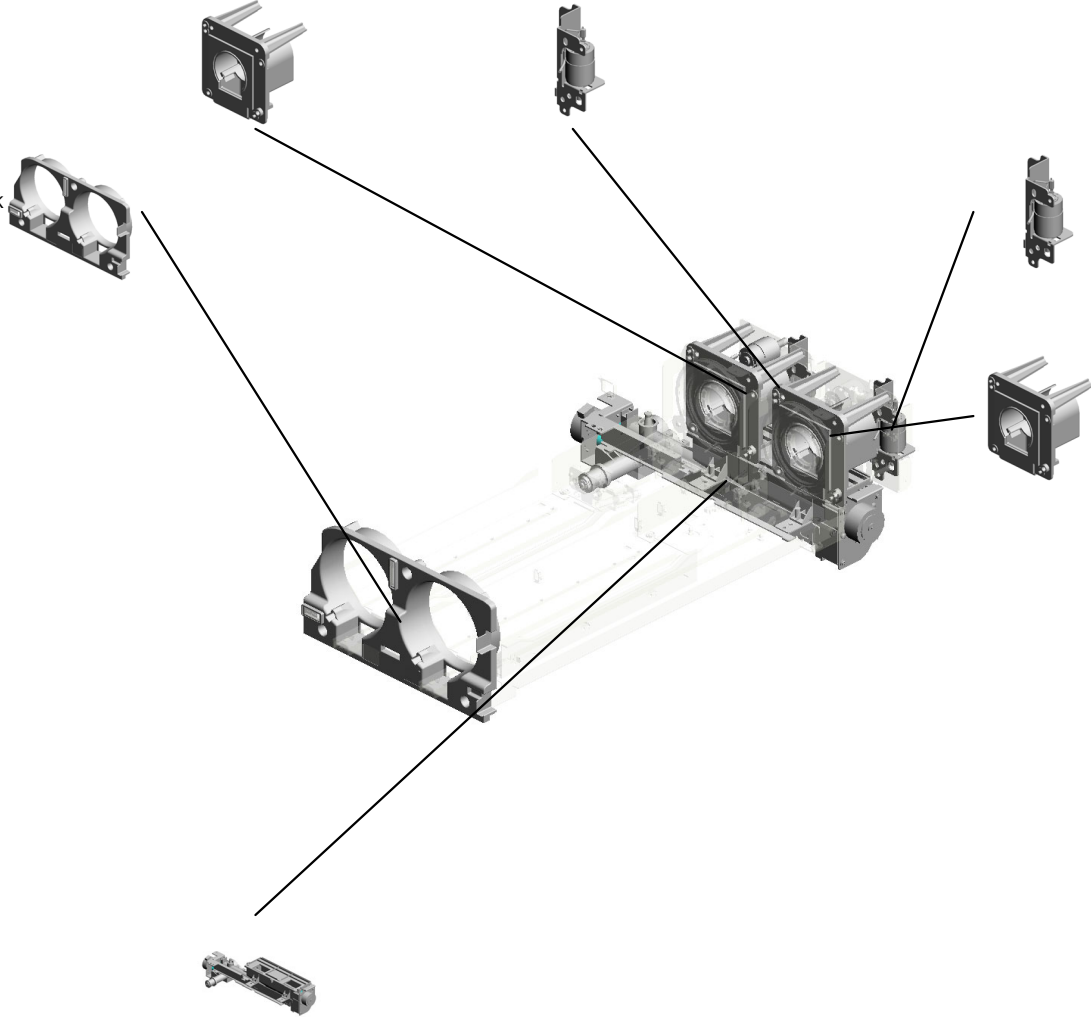

U001	U002	U003	U004	U005	U006	U007	U008	U009	U010	U011	U012	U013	U014	U015	U016	U017	U018	U019	U020	U021
------	------	------	------	------	------	------	------	------	------	------	------	------	------	------	------	------	------	------	------	------

U008 TONER SUPPLY

- 18.11050489 HARNESS CLAMP - LWS 1316
- 10.04514008N (x26) TAPPING SCREW: 4X8
- 13.07200040E (x10) RETAINING RING - M4
- 6.04504012N (x6) TAPPING SCREW: 4X12
- 1.03125060N (x4) SCREW - M2.5X6

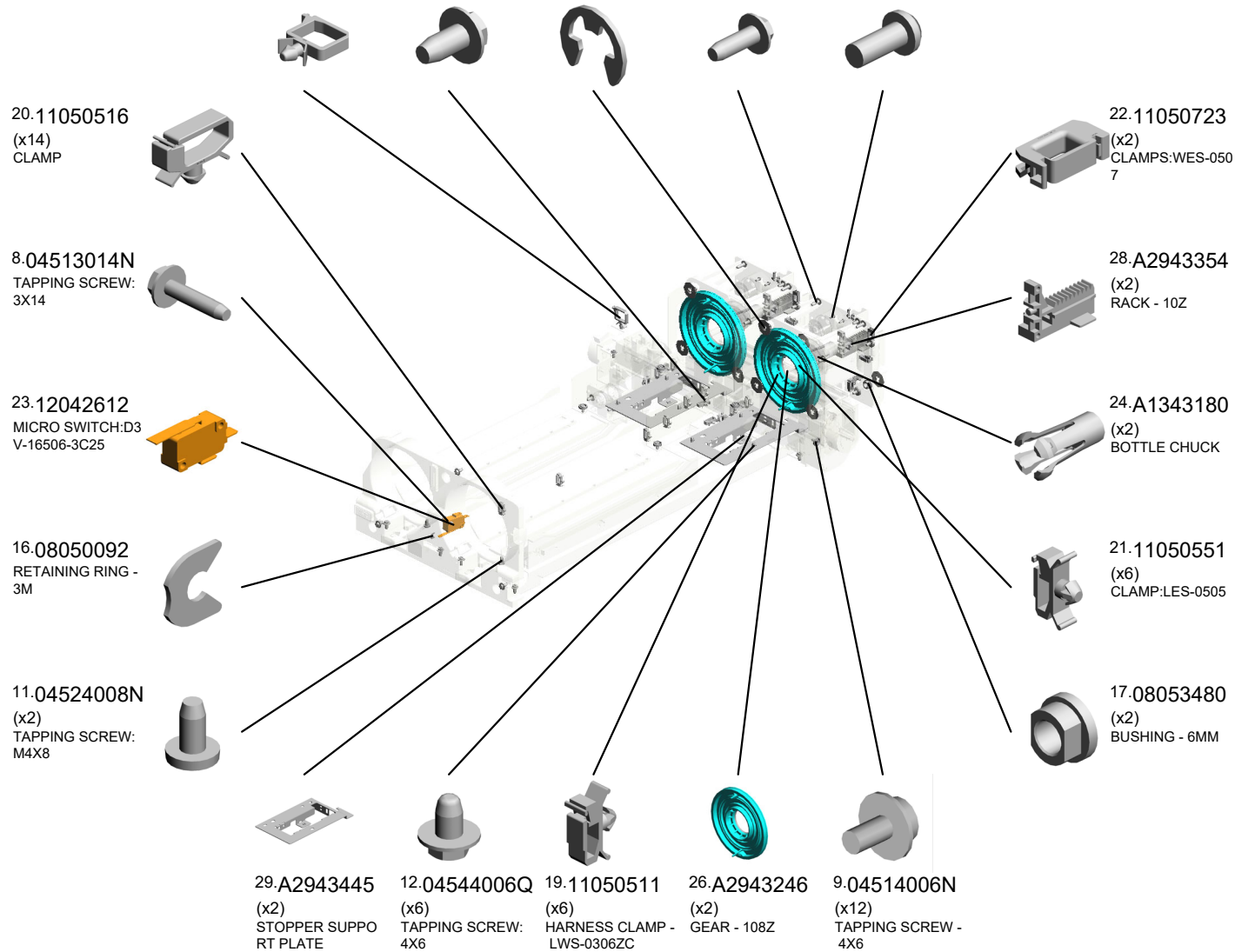
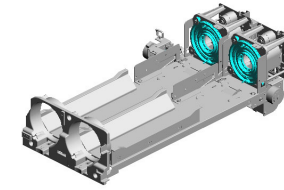

U008 TONER SUPPLY

- 45.AB012005 (x4) GEAR - 13Z
- 44.AA152299 (x2) BOTTLE HOLD SE
AL
- 38.AA063392 (x2) CHUCK SPRING
- 43.AA143816 (x2) FLAT SCREW:CHU
CK:BOTTLE
- 49.AB017515 (x2) DOUBLE GEAR - 1
2/23Z

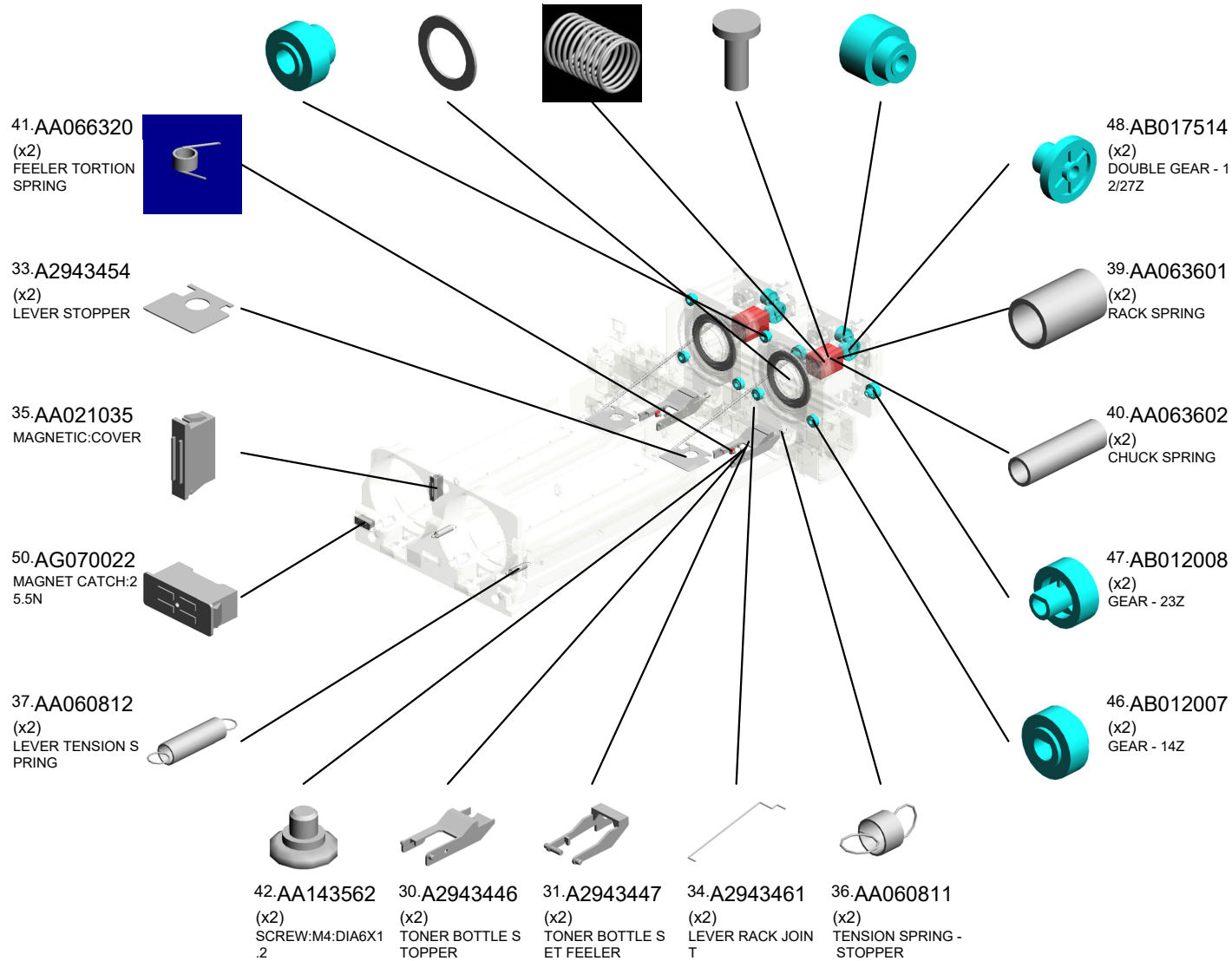
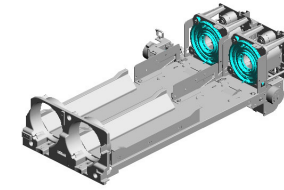

U008 TONER SUPPLY

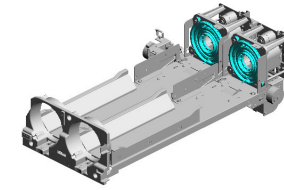

- 65.D1793275 (x2) COIL SPRING:SHUTTER:TONER SUPPLY
- 63.D1793271 CASE:SHUTTER:TONER SUPPLY
- 64.D1793272 SHUTTER:TONER SUPPLY:ASSY
- 66.D1793276 TONER CATCHPAN:TONER SUPPLY
- 79.D1793361 (x2) BRACKET:JOINT:REAR:LEVER

78.D1793355 (x4) GUIDE PLATE:TONER BANK:SIDE PLATE

84.D1793377 TORSION SPRING:SAFETY SWITCH:TONER SUPPLY UNIT

82.D1793373 BRACKET:SAFETY SWITCH:TONER SUPPLY UNIT

83.D1793376 LEVER:SAFETY SWITCH:TONER SUPPLY UNIT:ASSY

88.D1943566 (x2) GRIP:LEVER:BASE:TONER BANK

76.D1793346 (x2) DC MOTOR:DRIVE:TONER BOTTLE:ASSY:5.85W:BRUSH

52.B2343356 (x2) JOINT:CHUCK:TONER BOTTLE

85.D1793380 (x2) CASE:TONER BANK:REAR

94.GW020024 (x4) PHOTOINTERRUPTOR:LG2A24BL1:GF 201902-08 O/O

87.D1793384 (x2) SEAL:CASE:TONER BANK:LEFT

93.D0BX3451 (x2) LEVER:TONER BOTTLE:PEEN 201812-02 O/O

73.D1793339 (x2) GROUND PLATE:BOTTOM:TONER SUPPLY UNIT

69.D1793332 (x2) SIDE PLATE:TONER BANK

68.D1793322 (x2) SLIDER:TONER BANK:ASSY

92.D2703310 (x2) SHAFT:DRIVE:TONER BOTTLE:DIA6 201809-05 O/O

U001	U002	U003	U004	U005	U006	U007	U008	U009	U010	U011	U012	U013	U014	U015	U016	U017	U018	U019	U020	U021
------	------	------	------	------	------	------	------	------	------	------	------	------	------	------	------	------	------	------	------	------

U008 TONER SUPPLY

96.D0BX3342
(x2)
BRACKET:CHUCK:
TONER BANK:PEE
N
202010-01 O/O

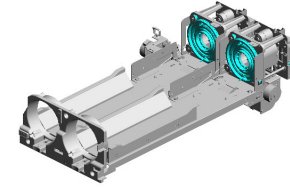

98.D0BX3383
(x2)
SEAL:CASE:TONE
R BANK:REAR
202402-01 O/O

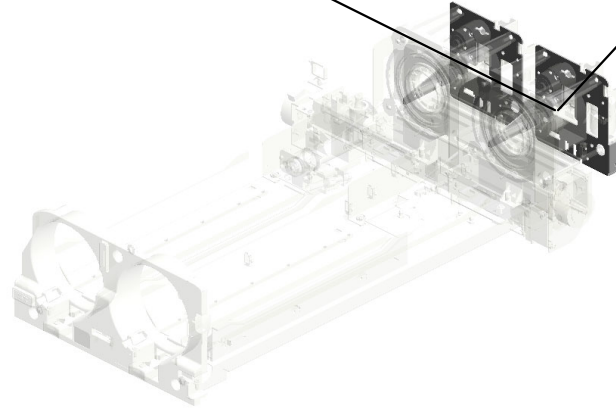

U001	U002	U003	U004	U005	U006	U007	U008	U009	U010	U011	U012	U013	U014	U015	U016	U017	U018	U019	U020	U021
------	------	------	------	------	------	------	-------------	------	------	------	------	------	------	------	------	------	------	------	------	------

U008_S001

TONER SUPPLY UNIT:TONER HOPPER:ASS'Y

- 2.03530060N (x4) BIND SCREW - M3 X6
- 54.D1793234 GEAR:TRANSPORT SCREW:LONG:TONER SUPPLY
- 59.D1793254 (x2) GEAR:IDLER:FEED:TONER SUPPLY:2
- 57.D1793252 COVER:GEAR:TONER SUPPLY
- 25.A2941163 (x2) GEAR - 30Z

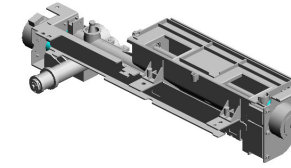

- 53.D1793201 TONER SUPPLY UNIT:TONER HOPPER:ASS'Y

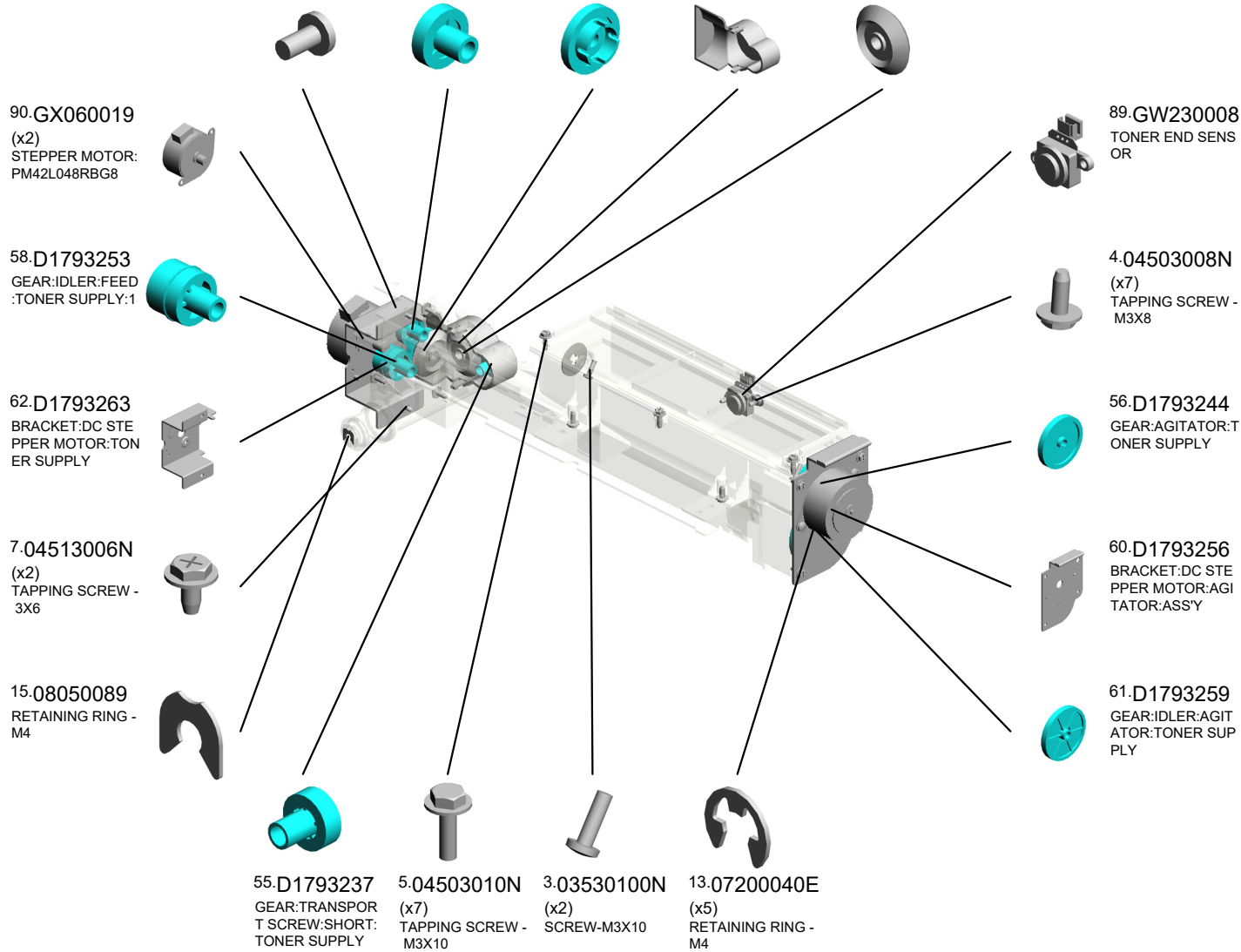

U001	U002	U003	U004	U005	U006	U007	U008	U009	U010	U011	U012	U013	U014	U015	U016	U017	U018	U019	U020	U021
------	------	------	------	------	------	------	------	------	------	------	------	------	------	------	------	------	------	------	------	------

U008_S002
INNER COVER:TONER BANK:ASS'Y

80.D1793367
DECAL:DESIGN SK
ETCH:TONER BOT
TLE

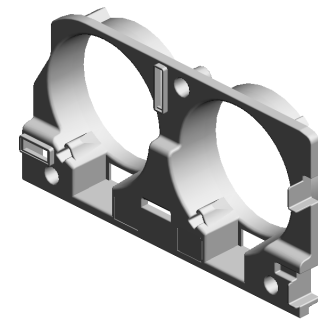

81.D1793370
INNER COVER:TO
NER BANK:ASS'Y

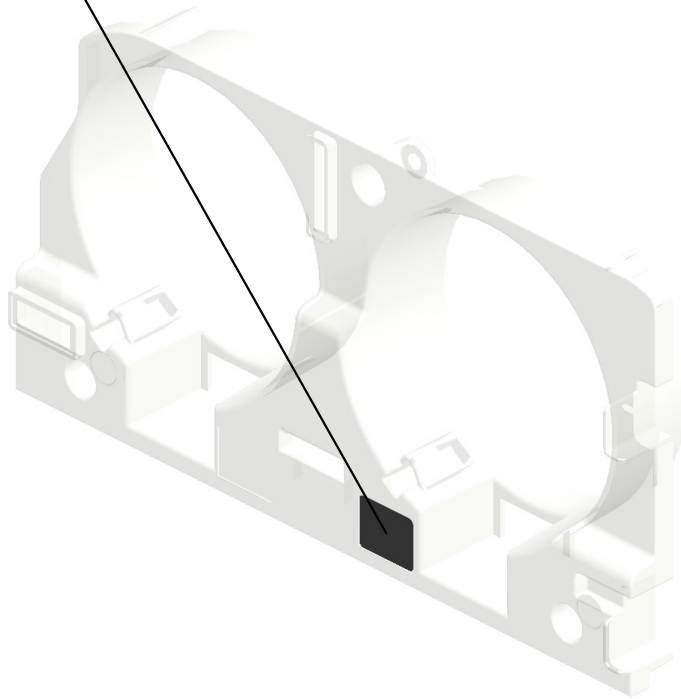
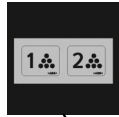

U001	U002	U003	U004	U005	U006	U007	U008	U009	U010	U011	U012	U013	U014	U015	U016	U017	U018	U019	U020	U021
------	------	------	------	------	------	------	-------------	------	------	------	------	------	------	------	------	------	------	------	------	------

U008_S003
CASE:TONER BANK:ASS'Y

27.A2943319
CASE CUSHION

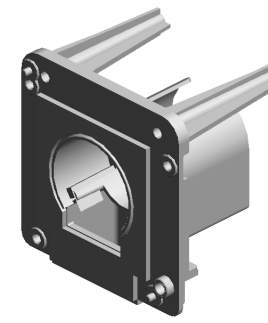

70.D1793334
CASE:TONER BAN
K:ASS'Y

97.D2703336
SEAL:CASE:TONE
R BANK:FRONT
202012-01 O/O

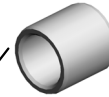

14.07330608
PLAIN SHAFT BEA
RING:DIA6X8

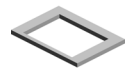

95.D2703335
SEAL:CASE:TONE
R BANK:LOWER
202001-01 O/O

U001	U002	U003	U004	U005	U006	U007	U008	U009	U010	U011	U012	U013	U014	U015	U016	U017	U018	U019	U020	U021
------	------	------	------	------	------	------	------	------	------	------	------	------	------	------	------	------	------	------	------	------

U008_S004
DC MOTOR:TONER BOTTLE:ASS'Y:BRUSH:5.85W

77:D1793347 76:D1793346
SEAL:BRACKET:R DC MOTOR:DRIVE:
ACK TONER BOTTLE:A
SS'Y:5.85W:BRUSH

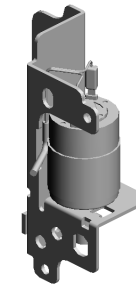

75:D1793344
DC MOTOR:TONER
BOTTLE:ASS'Y:BRUSH:5.85W

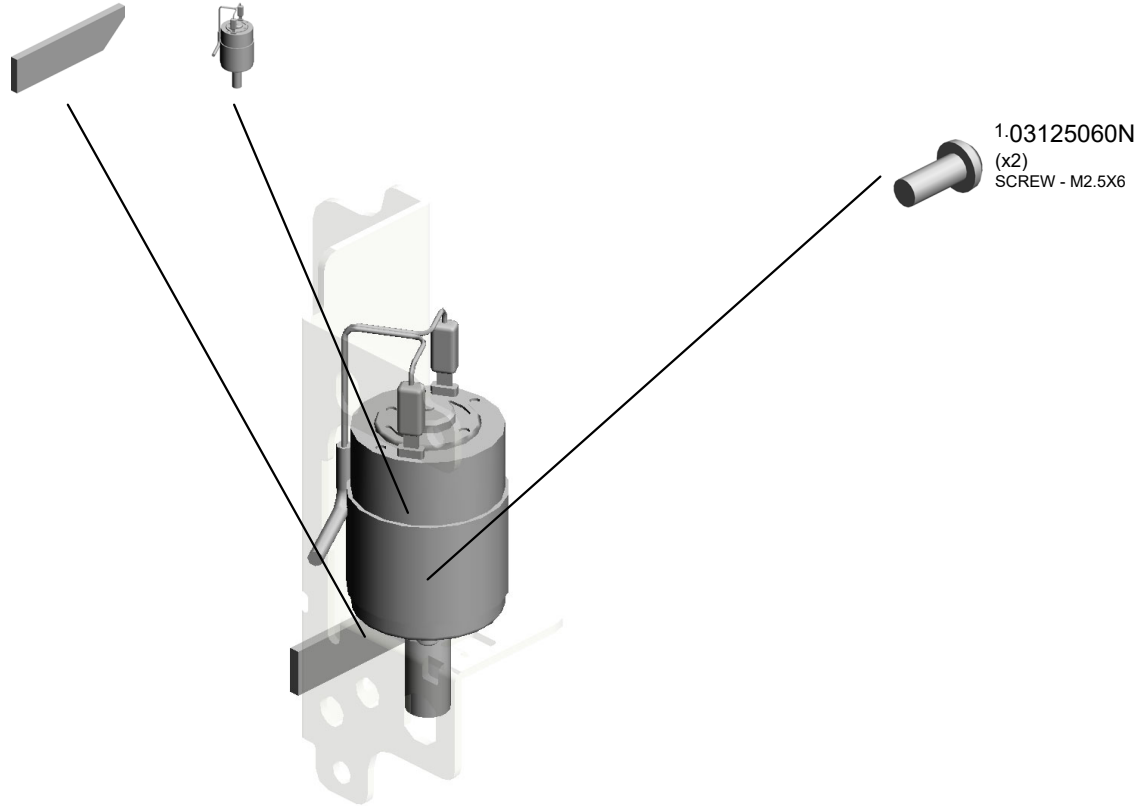

U001	U002	U003	U004	U005	U006	U007	U008	U009	U010	U011	U012	U013	U014	U015	U016	U017	U018	U019	U020	U021
------	------	------	------	------	------	------	-------------	------	------	------	------	------	------	------	------	------	------	------	------	------

U008_S005
CASE:TONER BANK:ASS'Y

27.A2943319
CASE CUSHION

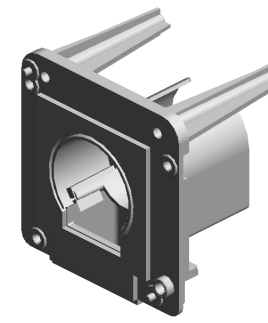

70.D1793334
CASE:TONER BAN
K:ASS'Y

97.D2703336
SEAL:CASE:TONE
R BANK:FRONT
202012-01 O/O

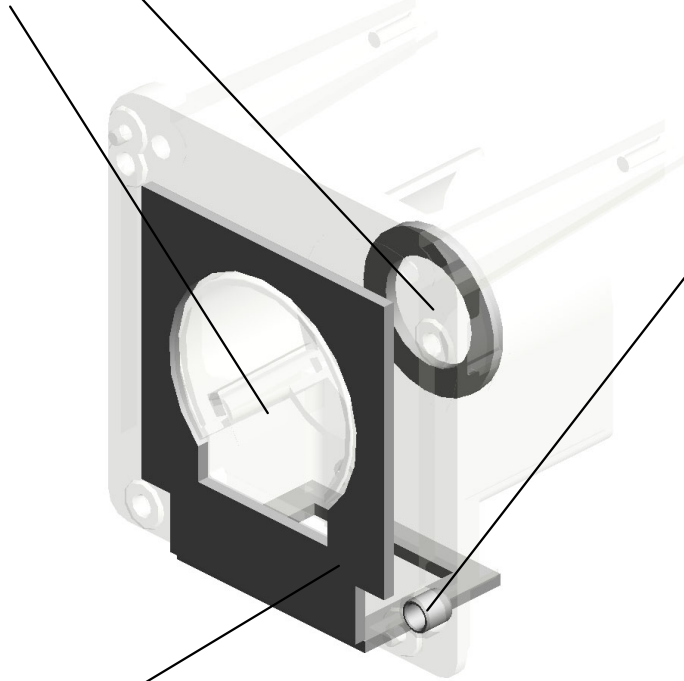

14.07330608
PLAIN SHAFT BEA
RING:DIA6X8



95.D2703335
SEAL:CASE:TONE
R BANK:LOWER
202001-01 O/O

U001	U002	U003	U004	U005	U006	U007	U008	U009	U010	U011	U012	U013	U014	U015	U016	U017	U018	U019	U020	U021
------	------	------	------	------	------	------	-------------	------	------	------	------	------	------	------	------	------	------	------	------	------

U008_S006

DC MOTOR:TONER BOTTLE:ASS'Y:BRUSH:5.85W

76.D1793346 77.D1793347
DC MOTOR:DRIVE: SEAL:BRACKET:R
TONER BOTTLE:A ACK
SS'Y:5.85W:BRUSH

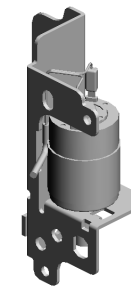

75.D1793344
DC MOTOR:TONE
R BOTTLE:ASS'Y:B
RUSH:5.85W

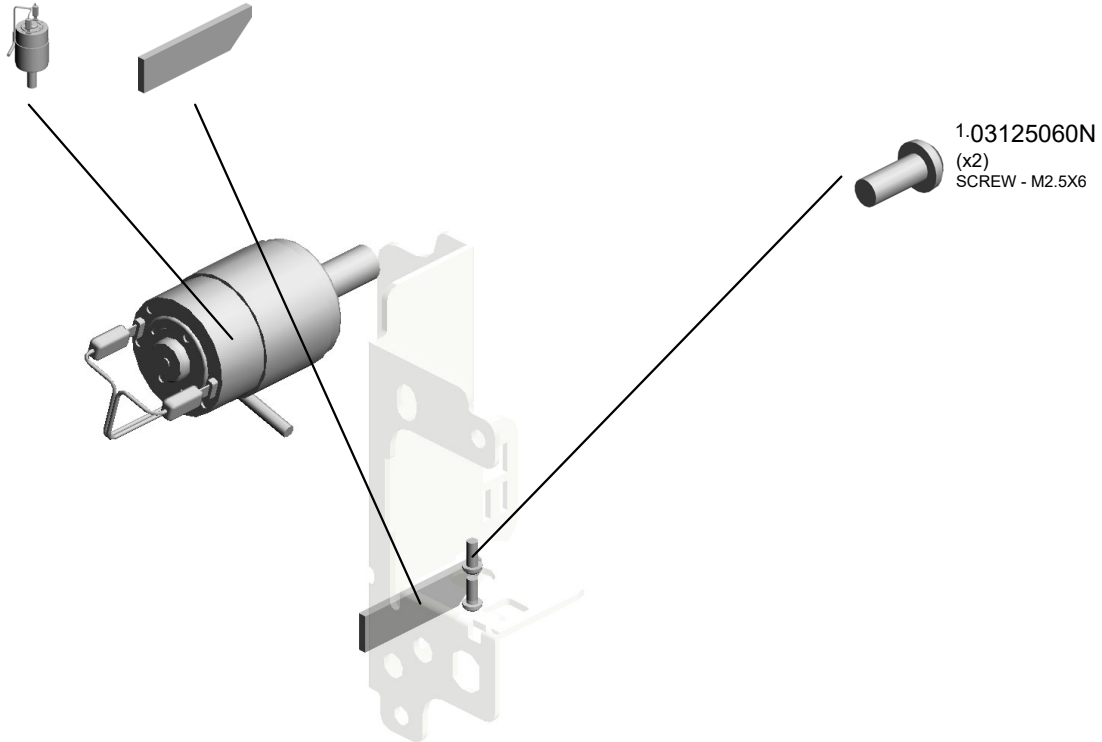

U001	U002	U003	U004	U005	U006	U007	U008	U009	U010	U011	U012	U013	U014	U015	U016	U017	U018	U019	U020	U021
------	------	------	------	------	------	------	------	------	------	------	------	------	------	------	------	------	------	------	------	------

U009.PCU

U009 S004
D0BX2432
SERVICE PARTS:DEVELOPM
ENT UNIT:C3:ASS'Y

U009 S006
D2702214
DUCT:CHARGE UNIT:ASS'Y

U009 S003
D0BX2440
INNER COVER:PCU:ASS'Y

U009 S005
D1792239
SHAFT:CLEANER:CHARGE:D
RIVE:ASS'Y

U009 S002
D0BX2255
CHARGE CORONA

U009 S001
D1793504
CLEANING UNIT:ASS'Y

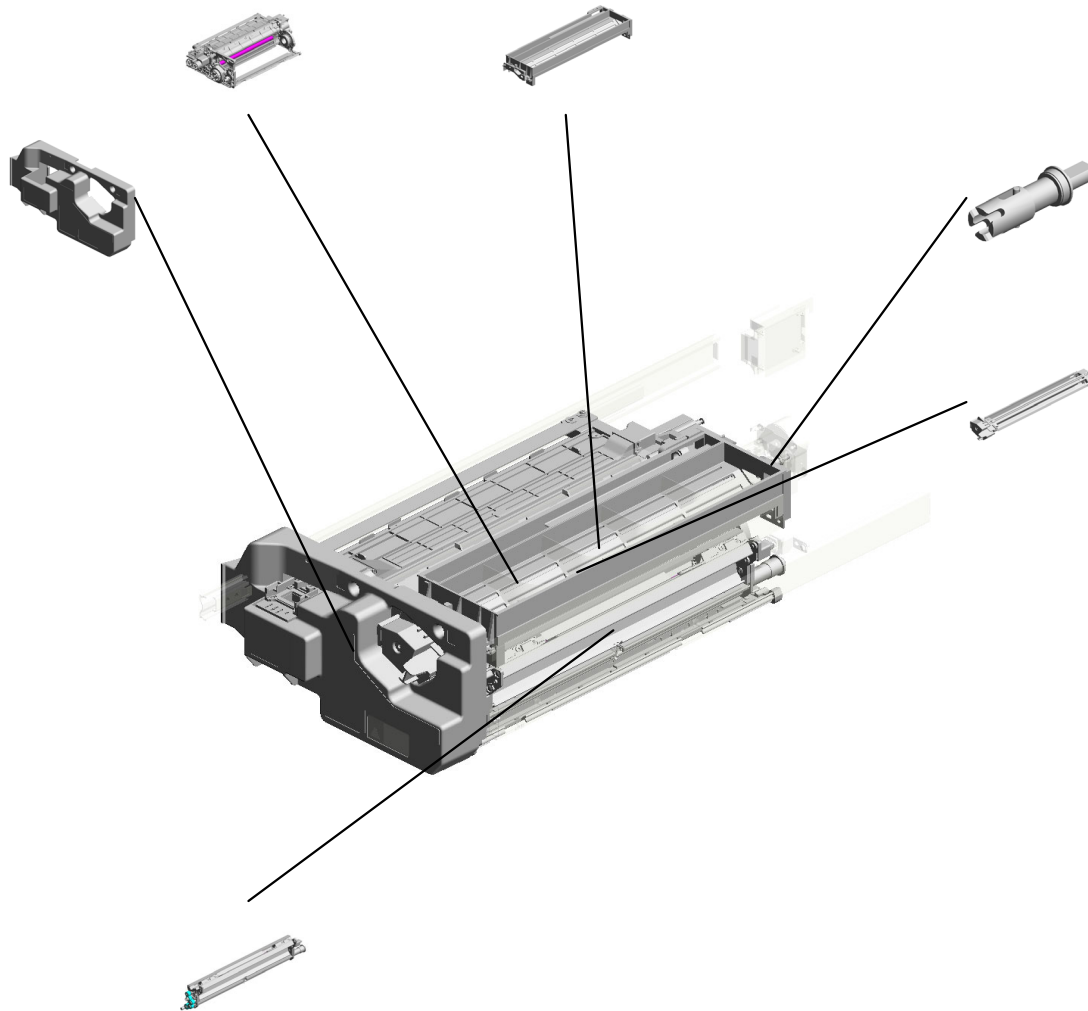

U009_S001.CLEANING UNIT:ASS'Y

U009 S001 S001
D1793535
GEAR SET:CLEANING UNIT:
SERVICE PARTS

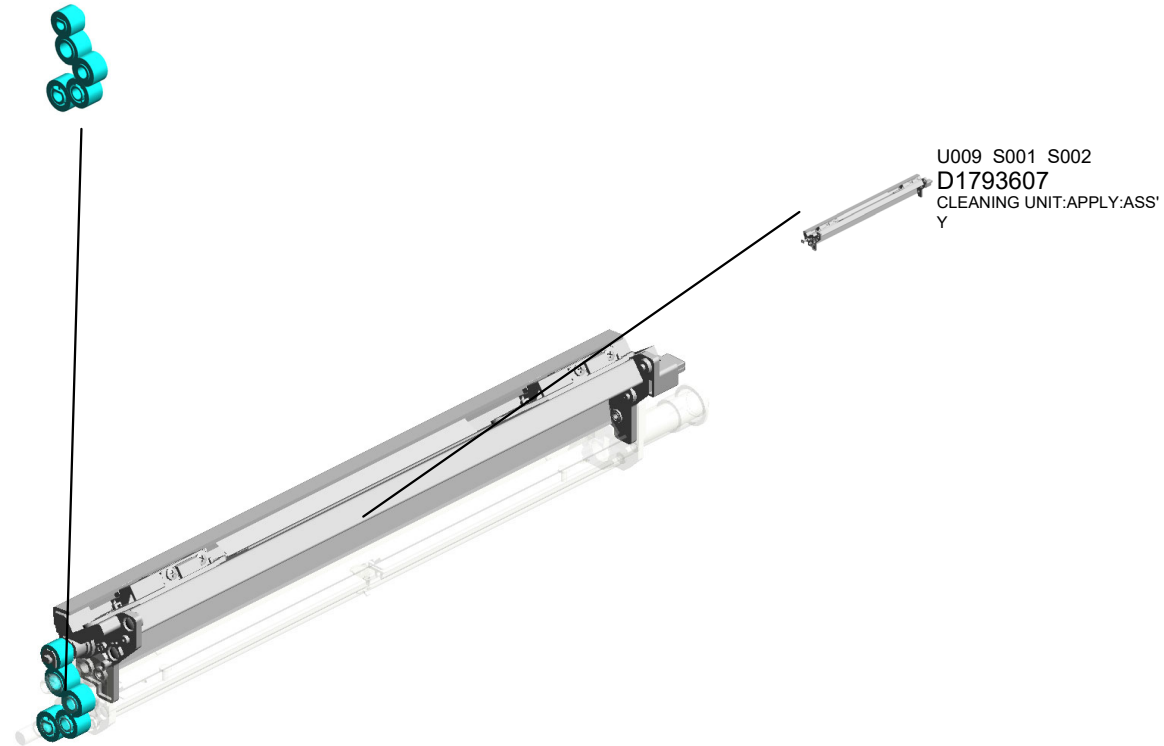

U009 S001 S002
D1793607
CLEANING UNIT:APPLY:ASS'
Y

U001	U002	U003	U004	U005	U006	U007	U008	U009	U010	U011	U012	U013	U014	U015	U016	U017	U018	U019	U020	U021
------	------	------	------	------	------	------	------	------	------	------	------	------	------	------	------	------	------	------	------	------

U009_S001_S002.CLEANING UNIT:APPLY:ASS'Y

U009 S001 S002 S001
D1793681
HOLDER:COVER:COATING B
AR:ASS'Y



U001	U002	U003	U004	U005	U006	U007	U008	U009	U010	U011	U012	U013	U014	U015	U016	U017	U018	U019	U020	U021
------	------	------	------	------	------	------	------	------	------	------	------	------	------	------	------	------	------	------	------	------

U009_S002.CHARGE CORONA

U009 S002 S001
D1792256
COVER:CHARGE CORONA:A
SSY



U009 S002 S002
G1782570
SCREW SHAFT:CHARGE CO
RONA:ASSY

U001	U002	U003	U004	U005	U006	U007	U008	U009	U010	U011	U012	U013	U014	U015	U016	U017	U018	U019	U020	U021
------	------	------	------	------	------	------	------	------	------	------	------	------	------	------	------	------	------	------	------	------

U009
PCU

- 6.03540120N (x2) SCREW M4X12
- 11.04503008N (x10) TAPPING SCREW - M3X8
- 17.04533006N (x2) TAPPING SCREW - M3X6
- 2.03530060N (x3) BIND SCREW - M3 X6
- 33.B7005804 STEPPER MOTOR: DIA42:Z17:ASS'Y

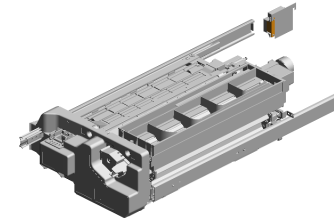

39.D0743829
DECAL:POSITIONI
NG DISPLAY:TCRU



59.D1792417
HOLDER:ELECTRI
C POTENTIAL SEN
SOR



58.D1792416
STAY:ELECTRIC P
OTENTIAL SENSO
R



54.D1792370
GRIP:DRUM:ASS'Y



55.D1792376
HOLDER:DRUM:TA
KE OFF:FRONT



18.04543006Q
TAPPING SCREW -
M3X6

15.04514008N (x5)
TAPPING SCREW:
4X8

34.D0592469 (x4)
SCREW:ROUND P
OINT:M4X6

56.D1792377
HOLDER:DRUM:TA
KE OFF:REAR

57.D1792411 (x2)
SLIDE RAIL:PCU



47.D1792237
HOLDER:MOTOR:C
HARGE

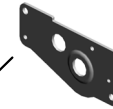

32.B2342390 (x3)
FLANGED HEXAG
ONAL HEAD BOLT:
M4X8

34.D0592469 (x2)
SCREW:ROUND P
OINT:M4X6

23.07413706
BALL BEARING - 6
X10X3



48.D1792238
SOCKET:CHARGE

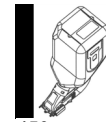

150.D1799640
DEVELOPER BLAC
K
201903-06 O/O

50.D1792246
SEAL:DUCT:SIDE P
LATE:REAR



38.D0742577
CONNECTOR:DRA
WER:4POLE:REC



U009
PCU

149.GW020024 **104.D1799510** 109.D2702247 61.D1792421 116.G1781313
 PHOTOINTERRUPTOR:LG2A24BL1:GF 201902-08 O/O
OPC Drum
 DUCT:SIDE PLATE ELECTRIC POTENTIAL SENSOR SPRING:PLATE:RIGHT:CHARGE

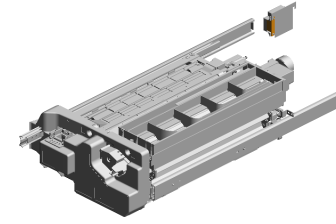

153.AW140027
 TEMPERATURE & HUMIDITY SENSOR
 201907-05 O/O



64.D1792469
 KNOB SCREW:DRUM



106.D2701399
 DECAL:LASER DIO
 DE:ABS
 202401-02

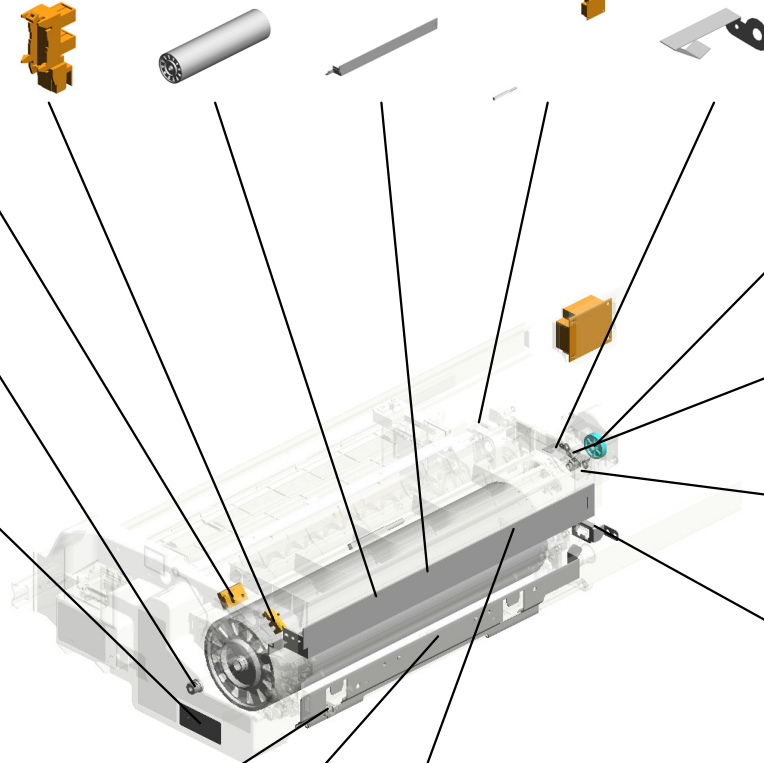

114.G1781282
 GEAR:CHARGE:CL
 EANER:Z51



115.G1781311
 (x3)
 TERMINAL:CHARGE



117.G1781316
 SPRING:PLATE:LE
 FT:CHARGE



62.D1792427
 BRACKET:DRAWER:
 CLEANING UNIT



60.D1792419
 STOPPER:SLIDE RAIL:
 PCU:PEEN



145.D1792412
 HOLDER:SLIDE RAIL:
 PCU:RIGHT



78.D1793131
 RECEPTACLE:DEVELOPMENT VIAS:
 ASSY



U009_S001
CLEANING UNIT:ASS'Y

87.D1793561
SHAFT:CLEANING
BLADE:FRONT

91.D1793581
BLADE:CLEANING:
ASS'Y

89.D1793571
BRACKET:CLEANING
BLADE:ASS'Y

80.D1793525
TONER COLLECTI
ON COIL:CLEANIN
G:ASSY



79.D1793504
CLEANING UNIT:ASSY

92.D1793589
RETAINING RINGS
-E:GUIDE

22.07200040E
RETAINING RING -
M4

25.08050089
(x2)
RETAINING RING -
M4

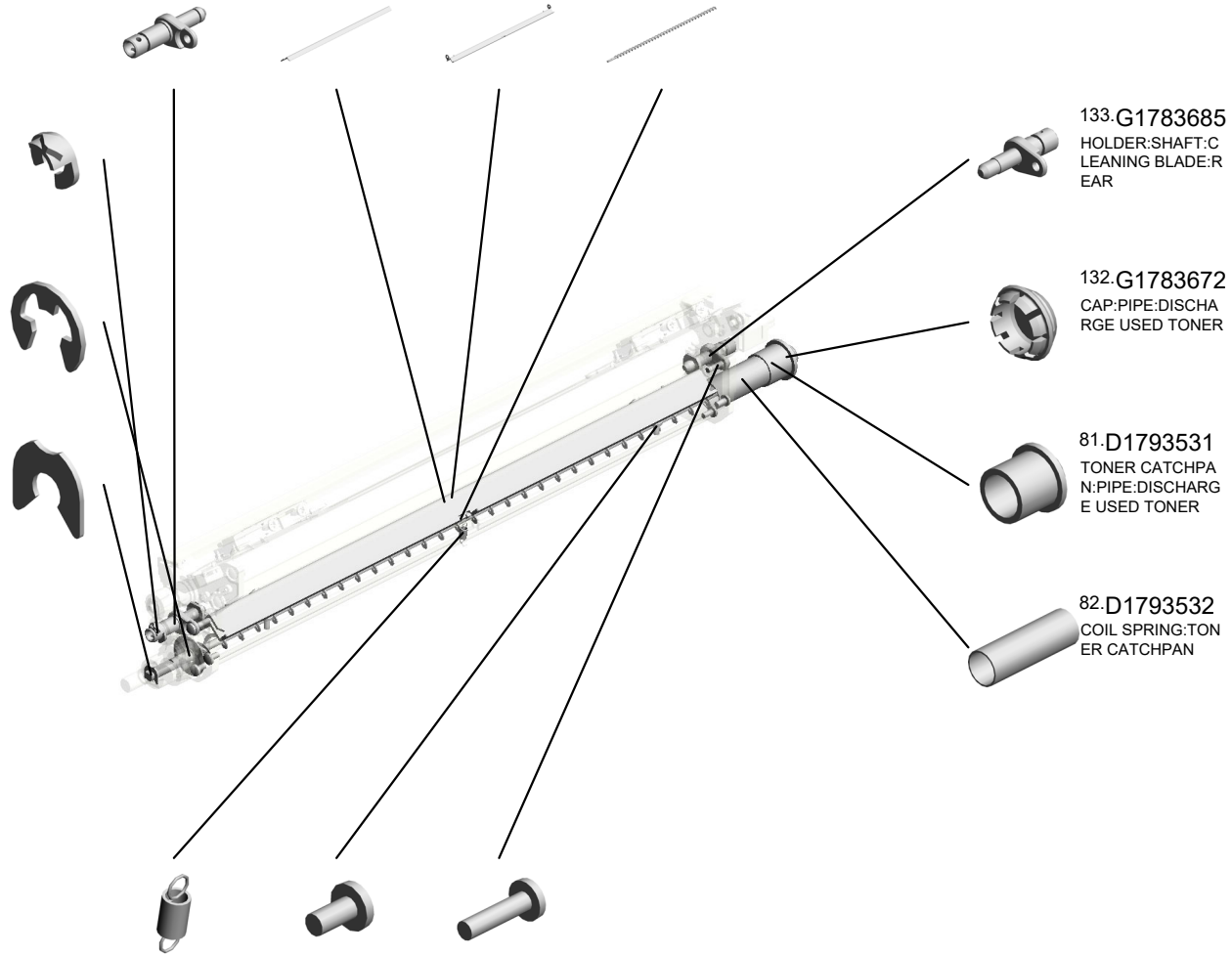

133.G1783685
HOLDER:SHAFT:CLEANING
BLADE:REAR

132.G1783672
CAP:PIPE:DISCHARGE
USED TONER

81.D1793531
TONER CATCHPAN:
PIPE:DISCHARGE
USED TONER

82.D1793532
COIL SPRING:TONER
CATCHPAN

90.D1793576
TENSION SPRING:
CLEANING BLADE:
6N

2.03530060N
(x8)
BIND SCREW - M3
X6

5.03530120N
(x2)
SCREW M3X12

U001	U002	U003	U004	U005	U006	U007	U008	U009	U010	U011	U012	U013	U014	U015	U016	U017	U018	U019	U020	U021
------	------	------	------	------	------	------	------	------	------	------	------	------	------	------	------	------	------	------	------	------

U009_S001_S001
GEAR SET:CLEANING UNIT:SERVICE PARTS

98.D1793645 88.D1793564
GEAR:BRUSH ROLLER:Z15 GEAR:IDLER:Z17:UPPER

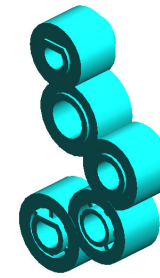

83.D1793535
GEAR SET:CLEANING UNIT:SERVICE PARTS

84.D1793536
GEAR:IDLER:Z16

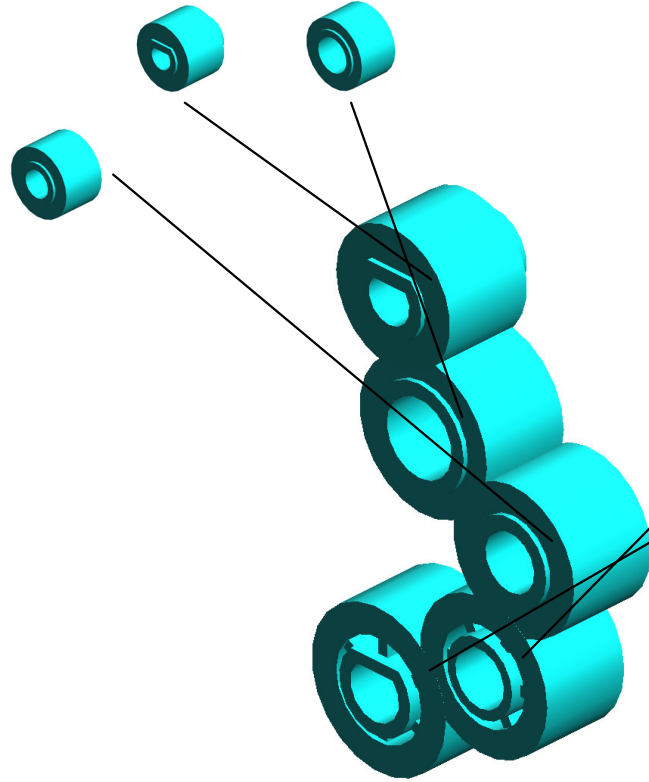

85.D1793537
GEAR:IDLER:Z17:LOWER

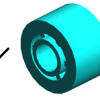

86.D1793538
GEAR:TONER COLLECTION COIL:Z18

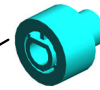

U001	U002	U003	U004	U005	U006	U007	U008	U009	U010	U011	U012	U013	U014	U015	U016	U017	U018	U019	U020	U021
------	------	------	------	------	------	------	------	------	------	------	------	------	------	------	------	------	------	------	------	------

U009_S001_S002
 CLEANING UNIT:APPLY:ASS'Y

100.D1793653 BLADE:APPLY:ASS'Y
 96.D1793635 COATING BAR:ASS'Y
 94.D1793621 COVER:COATING BAR
 37.D0742542 (x2) DECAL:GRIP



97.D1793641
 BRUSH ROLLER:APPLY:ASS'Y

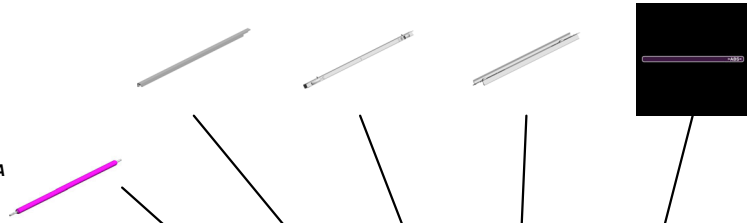

136.G1783734
 (x2)
 GUIDE PLATE:ARM



135.G1783713
 BUSHING:APPLY



25.08050089
 RETAINING RING - M4



95.D1793627 (x2) TENSION SPRING:COATING BAR:5N
 2.03530060N (x9) BIND SCREW - M3 X6
 99.D1793647 PLAIN SHAFT BEARING:APPLY:REAR ASS'Y
 101.D1793669 GROUND PLATE:APPLY



35.D0742459
 JOINT:CLEANING UNIT



139.J0155505
 DRAWER:CONNECTOR:USED DEVELOPER:PLUG

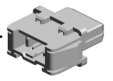

134.G1783707
 (x2)
 SHEET:COATING BAR:2



137.G1783781
 GUIDE:COATING BAR



2.03530060N (x 1)
 BIND SCREW - M3X6

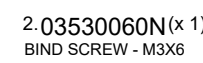

U009_S001_S002_S001
HOLDER:COVER:COATING BAR:ASS'Y

103.D1793689
GROUND PLATE:C
OVER:APPLY

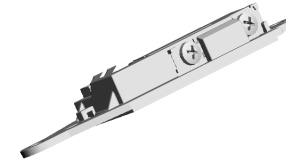

102.D1793681
HOLDER:COVER:C
OATING BAR:ASS'
Y

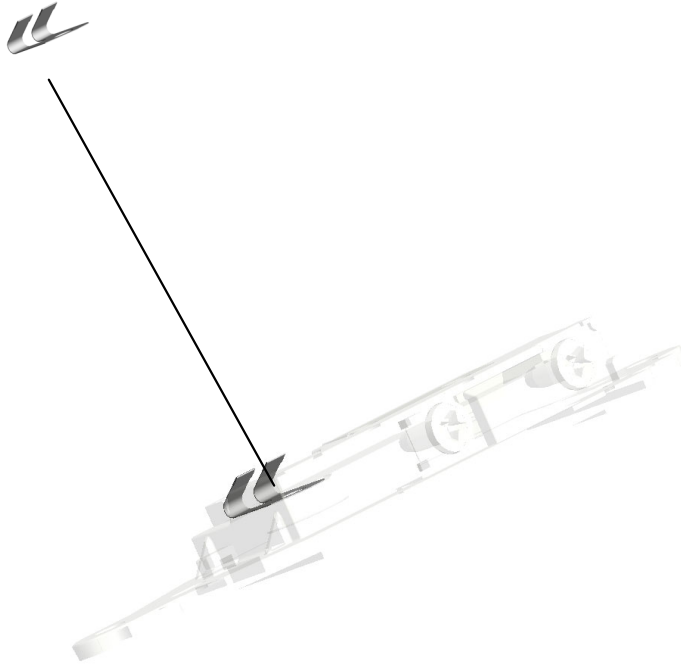

U001	U002	U003	U004	U005	U006	U007	U008	U009	U010	U011	U012	U013	U014	U015	U016	U017	U018	U019	U020	U021
------	------	------	------	------	------	------	------	------	------	------	------	------	------	------	------	------	------	------	------	------

U009_S001_S002_S002
HOLDER:COVER:COATING BAR:ASS'Y

103.D1793689
GROUND PLATE:C
OVER:APPLY

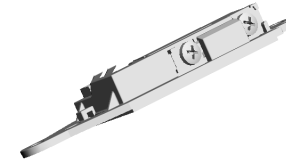

102.D1793681
HOLDER:COVER:C
OATING BAR:ASS'
Y

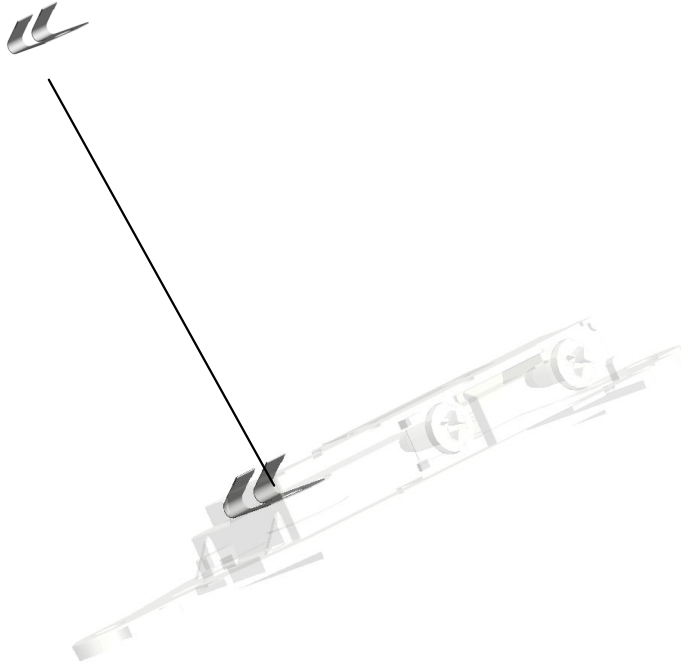

U001	U002	U003	U004	U005	U006	U007	U008	U009	U010	U011	U012	U013	U014	U015	U016	U017	U018	U019	U020	U021
------	------	------	------	------	------	------	------	------	------	------	------	------	------	------	------	------	------	------	------	------

U009_S002
CHARGE CORONA

- 124.G1782521 SLIDER:CLEANER:CHARGE CORONA:ASS'Y
- 125.G1782522 (x3) RING:SLIDER
- 152.D0BX2500 GRID:CHARGE CORONA 201904-11 O/O
- 46.D1792224 (x3) CORONA WIRE:CHARGE CORONA
- 45.D1792210 STAY:CORONA WIRE:RIGHT



- 151.D0BX2255 [A] CHARGE CORONA 201904-03 O/O

- 121.G1782510 (x3) CLEANER:CORONA WIRE:ASS'Y

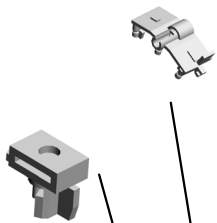

- 127.G1782605 (x3) TENSION SPRING:CORONA WIRE



- 122.G1782512 COVER:END BLOCK:FRONT



- 123.G1782516 END BLOCK:CHARGE CORONA:FRONT



- 120.G1782507 CLEANER:GRID:ASS'Y
- 40.D1792204 COVER:END BLOCK:REAR
- 119.G1782502 (x6) CUSHION:CORONA WIRE
- 43.D1792208 END BLOCK:CHARGE CORONA:REAR

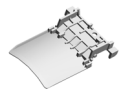

- 31.B2342125 (x3) SPRING - GRID

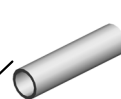

- 42.D1792206 STAY:GRID



- 41.D1792205 ELECTRODE PLATE:CASE:CHARGE



- 24.08050072 (x2) CS RING



- 44.D1792209 STAY:CORONA WIRE:LEFT



- 11.04503008N (x 5) TAPPING SCREW - M3X8
- 16.04523010N (x 1) BINDING SELF-TAPPING SCREW:3X10
- 21.07200025E (x 1) RETAINING RING - M2.5



- D1792255 [A] CHARGE CORONA 201904-03 O/O

U009_S002_S001
COVER:CHARGE CORONA:ASS'Y

51.D1792254
DECAL:CHARGE:G
RIP

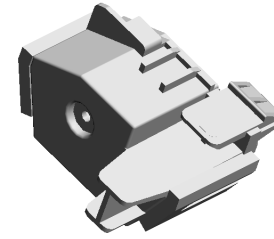
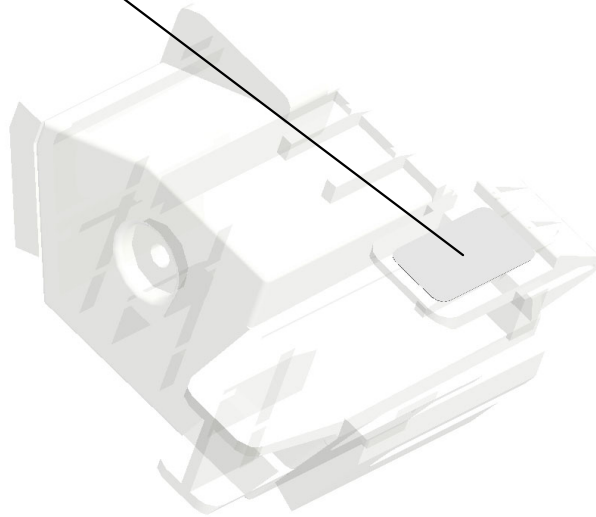

53.D1792256
COVER:CHARGE C
ORONA:ASS'Y

U001	U002	U003	U004	U005	U006	U007	U008	U009	U010	U011	U012	U013	U014	U015	U016	U017	U018	U019	U020	U021
------	------	------	------	------	------	------	------	------	------	------	------	------	------	------	------	------	------	------	------	------

U009_S002_S002
SCREW SHAFT:CHARGE CORONA:ASS'Y

21.07200025E
RETAINING RING -
M2.5

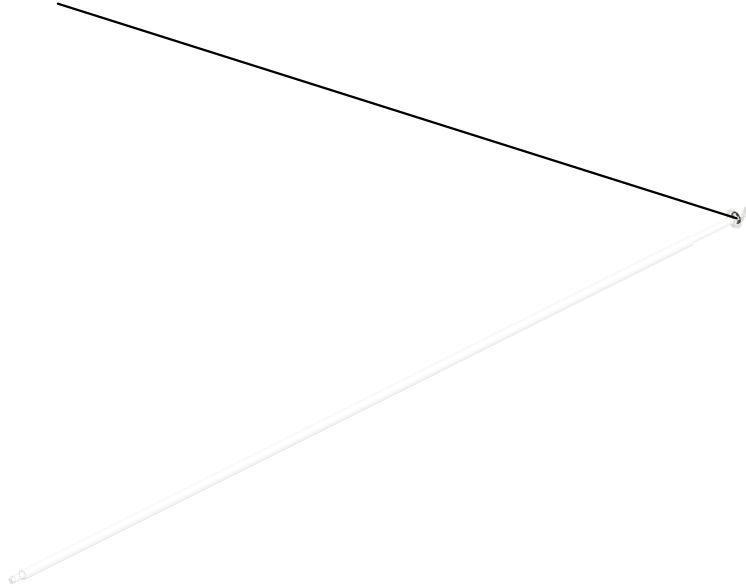

126.G1782570
SCREW SHAFT:CH
ARGE CORONA:AS
SY

U001	U002	U003	U004	U005	U006	U007	U008	U009	U010	U011	U012	U013	U014	U015	U016	U017	U018	U019	U020	U021
------	------	------	------	------	------	------	------	------	------	------	------	------	------	------	------	------	------	------	------	------

U009_S003
INNER COVER:PCU:ASS'Y

113.D2703136 107.D2701568
DECAL:DEVELOPM (x3)
ENT UNIT:CAUTIO DECAL:POSITIONI
N NG DISPLAY:TCRU
:ABS

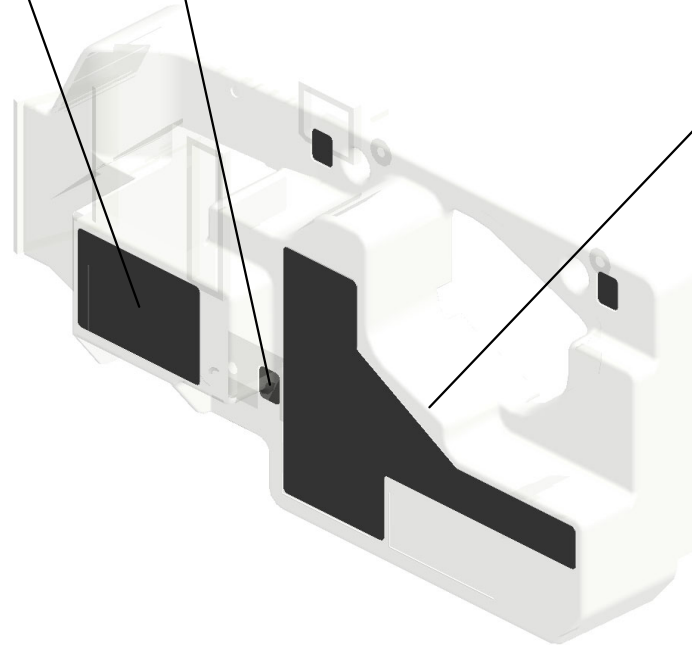

112.D2703134
DECAL:WARNING:
AROUND THE PHO
TOCONDUCTOR:A
BS

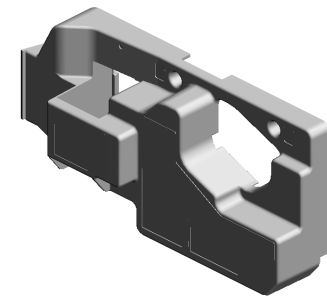

157.D0BX2440
[A]
INNER COVER:PC
U:ASS'Y
202401-01 O/O

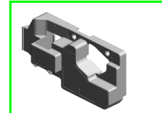

D2702440
[A]
INNER COVER:PC
U:ASS'Y
202401-01 O/O

U009_S004
 SERVICE PARTS:DEVELOPMENT UNIT:C3:ASS'Y

39.D0743829 DECAL:POSITIONING DISPLAY:TCRUNG
 13.04504012N (x12) TAPPING SCREW: 4X12
 9.03603010N (x4) SCREW:M3X10
 28.11050534 (x4) CLAMP
 5.03530120N (x2) SCREW M3X12

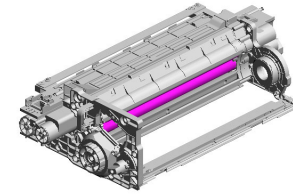

154.D0BX2432
 [A]
 SERVICE PARTS:DEVELOPMENT UNIT:C3:ASS'Y
 201908-01 O/O

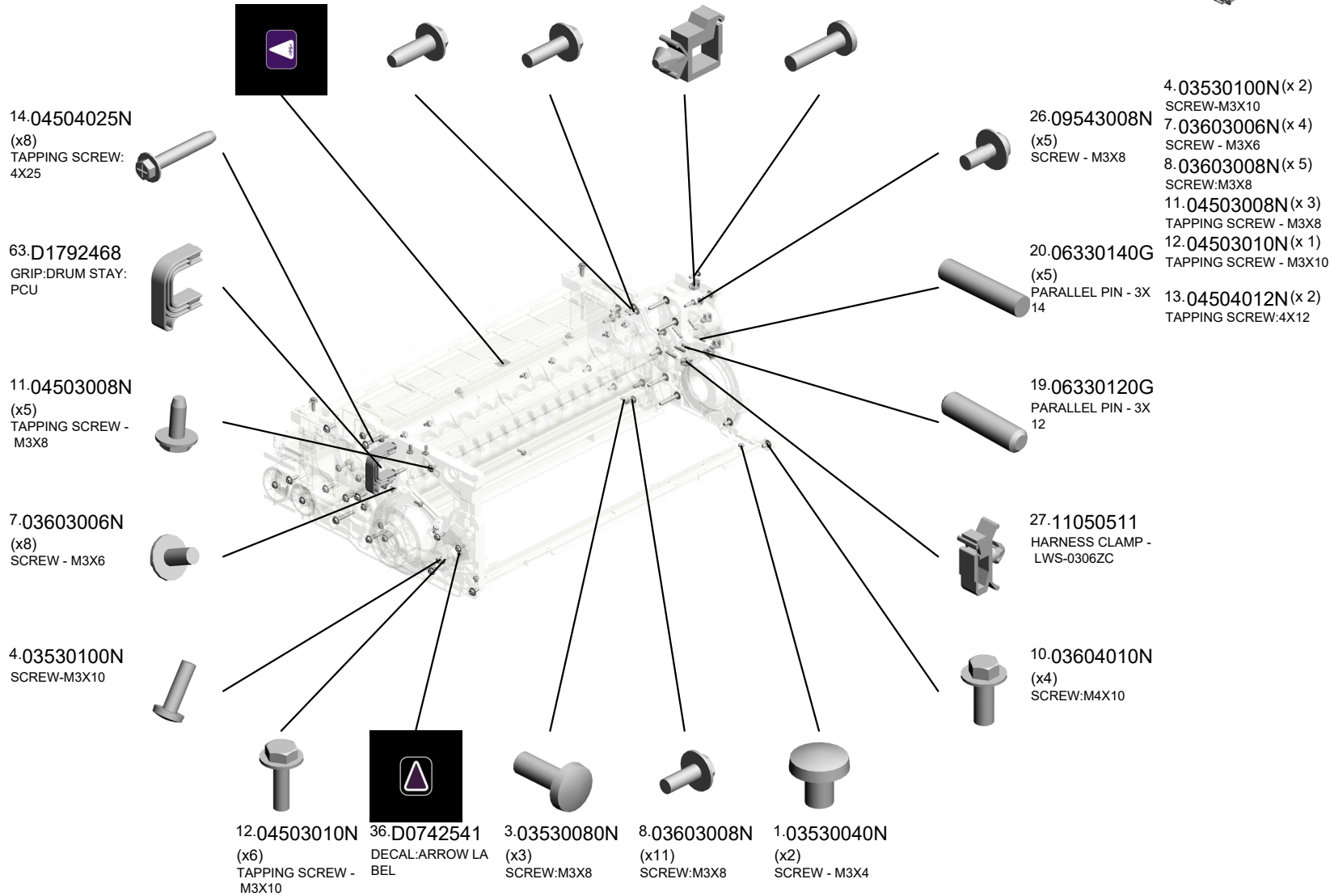

U001	U002	U003	U004	U005	U006	U007	U008	U009	U010	U011	U012	U013	U014	U015	U016	U017	U018	U019	U020	U021
------	------	------	------	------	------	------	------	------	------	------	------	------	------	------	------	------	------	------	------	------

- 76.D1793090 PLATE:GEAR:IDLER:ASS'Y
- 131.G1783475 SPONGE:COUPLING:TONER SUPPLY:DEVELOPMENT UNIT
- 143.D2703097 COVER:GEAR:DEVELOPMENT 201711-01 X/O
- 72.D1793073 GEAR:IDLER:TRANSPORT SCREW:UPPER:ASS'Y
- 69.D1793070 GEAR:TRANSPORT SCREW:NO.1

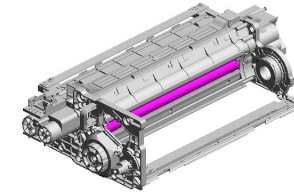

154.D0BX2432

[A]
SERVICE PARTS:DEVELOPMENT UNIT:C3:ASS'Y
201908-01 O/O

156.D0BX3075
FILTER:DEVELOPMENT
202102-01 O/O

68.D1793043
DUCT:FILTER:DEVELOPMENT:ASS'Y

75.D1793084
ENTRANCE SEAL:DEVELOPMENT:ASS'Y

146.D2703079
SERVICE PARTS:DEVELOPMENT:SENSING

140.D1792467
LEVER:POSITIONING:CLEANING

65.D1792474
DECAL:DIAL

67.D1792494
GROUND PLATE:STAY:PCU

155.D0BX2485
LED ARRAY:ASS'Y
201908-02 X/X

71.D1793072
GEAR:TRANSPORT SCREW:NO.3

129.G1783332
(x2)
GEAR:DEVELOPMENT ROLLER

138.GA000063
DECAL:DEVELOPMENT UNIT:DISPLAY

73.D1793074
GEAR:IDLER:TRANSPORT SCREW:LOWER:ASS'Y

130.G1783356
(x2)
GEAR:JOINT:DEVELOPMENT UNIT

70.D1793071
GEAR:TRANSPORT SCREW:NO.2

128.G1783330
GEAR:IDLER:DEVELOPMENT ROLLER:ASS'Y



D2702433
[A]
SERVICE PARTS:DEVELOPMENT UNIT:ASS'Y
201908-01 O/O

U001	U002	U003	U004	U005	U006	U007	U008	U009	U010	U011	U012	U013	U014	U015	U016	U017	U018	U019	U020	U021
------	------	------	------	------	------	------	------	------	------	------	------	------	------	------	------	------	------	------	------	------

U009_S005
SHAFT:CLEANER:CHARGE:DRIVE:ASS'Y

23.07413706
BALL BEARING - 6
X10X3

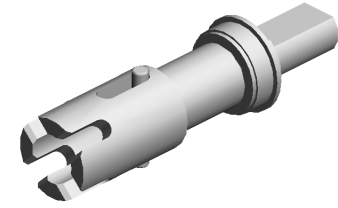

49.D1792239
SHAFT:CLEANER:
CHARGE:DRIVE:A
SS'Y



22.07200040E
RETAINING RING -
M4



U001	U002	U003	U004	U005	U006	U007	U008	U009	U010	U011	U012	U013	U014	U015	U016	U017	U018	U019	U020	U021
------	------	------	------	------	------	------	------	------	------	------	------	------	------	------	------	------	------	------	------	------

U009_S006
DUCT:CHARGE UNIT:ASS'Y

27.11050511
HARNESS CLAMP -
LWS-03062C

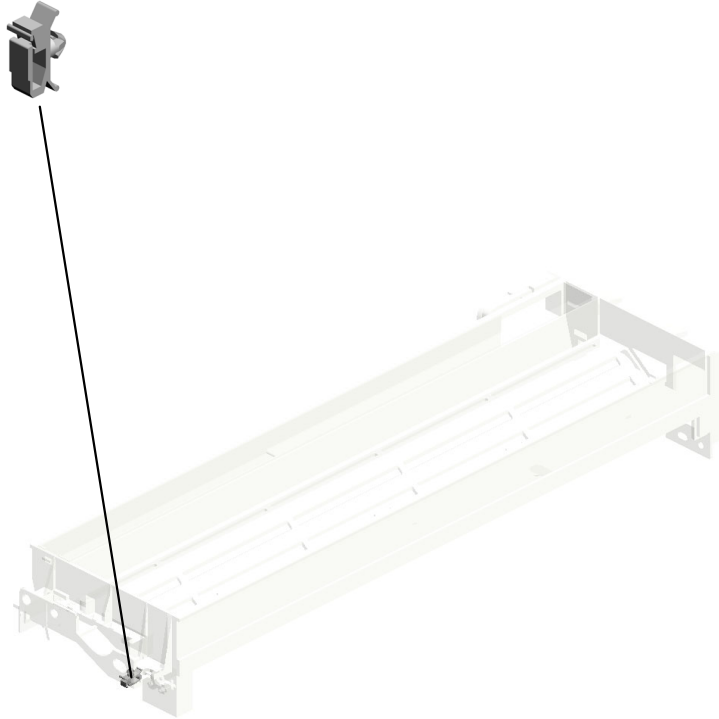

108.D2702214
DUCT:CHARGE UN
IT:ASS'Y

U001	U002	U003	U004	U005	U006	U007	U008	U009	U010	U011	U012	U013	U014	U015	U016	U017	U018	U019	U020	U021
------	------	------	------	------	------	------	------	------	------	------	------	------	------	------	------	------	------	------	------	------

U010.ITB UNIT

U010 S001
D2706002
TRANSFER UNIT:INTERMEDI
ATE TRANSFER:ASSY

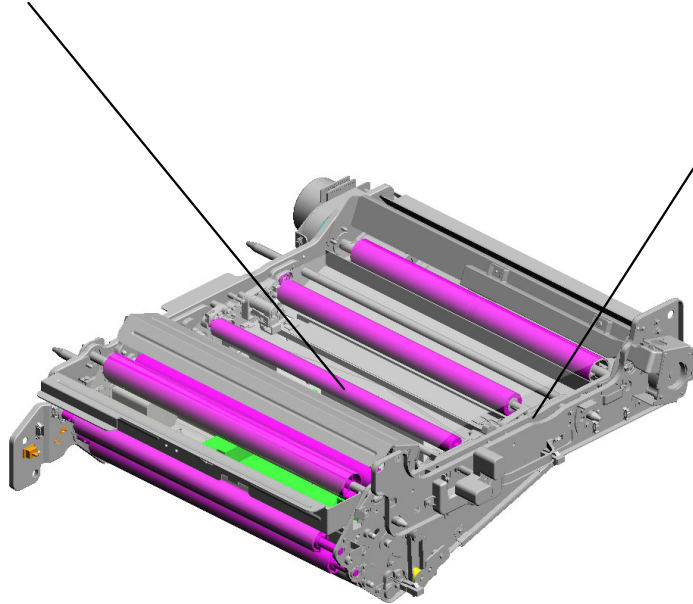
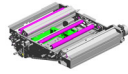

U010 S002
D2706170
DRUM STAY:INTERMEDIATE
TRANSFER:SUB-ASS'Y



U001	U002	U003	U004	U005	U006	U007	U008	U009	U010	U011	U012	U013	U014	U015	U016	U017	U018	U019	U020	U021
------	------	------	------	------	------	------	------	------	------	------	------	------	------	------	------	------	------	------	------	------

U010_S001.TRANSFER UNIT:INTERMEDIATE TRANSFER:ASS'Y

U010 S001 S001
D1796085
ROLLER:DRIVEN:INTERMEDI
ATE TRANSFER:ASS'Y

U010 S001 S002
D1796091
ROLLER:TENSION:ASS'Y

U010 S001 S003
D1796108
ROLLER:TRANSFER:PAPER:
FRONT:ASS'Y

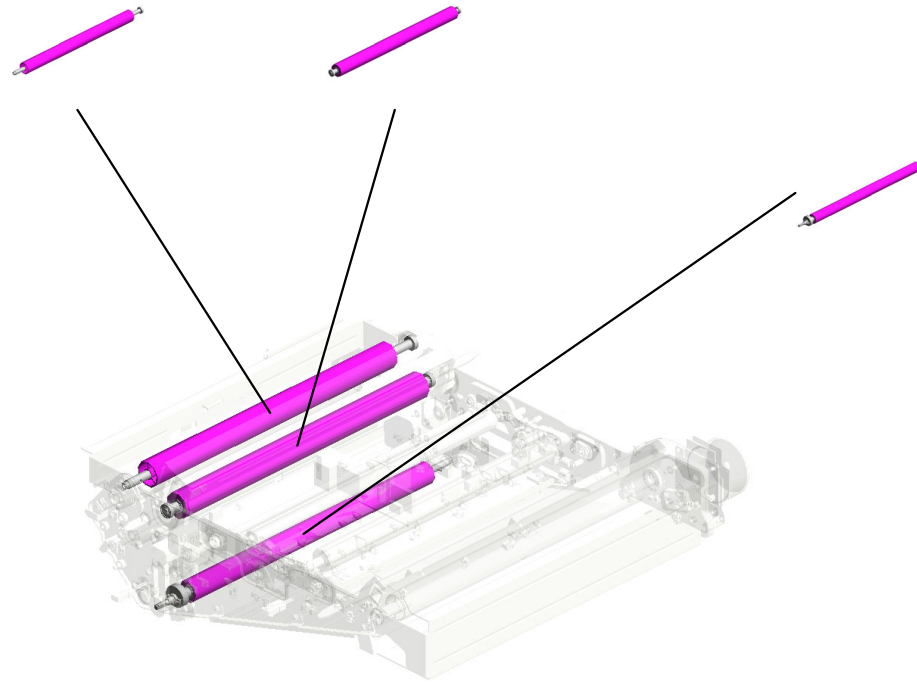

U001	U002	U003	U004	U005	U006	U007	U008	U009	U010	U011	U012	U013	U014	U015	U016	U017	U018	U019	U020	U021
------	------	------	------	------	------	------	------	------	------	------	------	------	------	------	------	------	------	------	------	------

U010
ITB UNIT

51.D0744351
(x4)
STEPPED SCREW:
DIA5.4DIA:DIA3.5:M
3

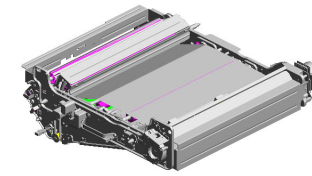

30.AA063463
(x4)
COMPRESSION SP
RING:DRAWER



6.03604008N
(x2)
SCREW - M4X8

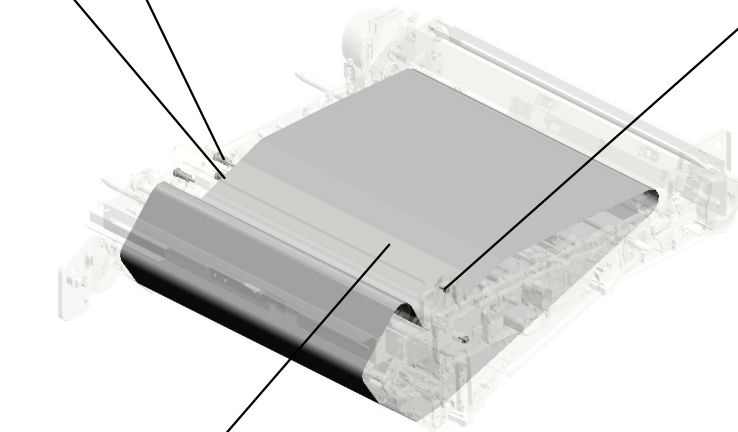

75.D1796050
FLAT BELT-TRANS
FER

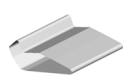

U001	U002	U003	U004	U005	U006	U007	U008	U009	U010	U011	U012	U013	U014	U015	U016	U017	U018	U019	U020	U021
------	------	------	------	------	------	------	------	------	------	------	------	------	------	------	------	------	------	------	------	------

U010_S001
TRANSFER UNIT:INTERMEDIATE TRANSFER:ASS'Y

7.04503008N (x4) TAPPING SCREW - M3X8
 13.07200080E (x4) RETAINING RING - M8
 18.09544008N (x5) SCREW - M4X8
 10.07200030E RETAINING RING - M3
 12.07200060E (x4) RETAINING RING - M6

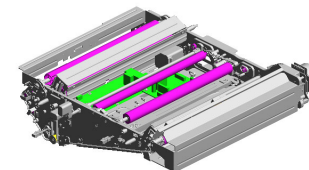

129-D2706002
 [A] TRANSFER UNIT:INTERMEDIATE TRANSFER:ASS'Y
 201907-08 O/O

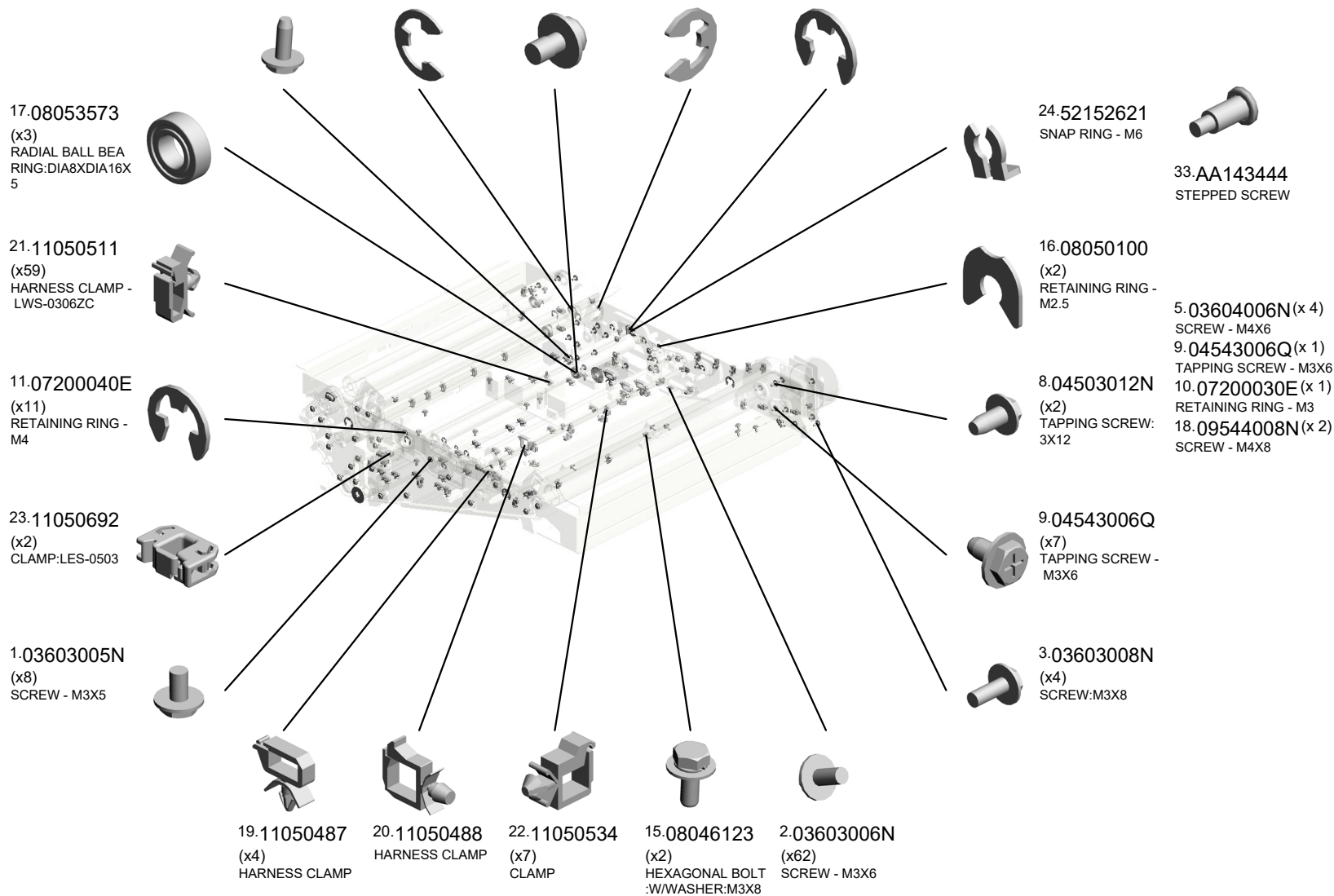

U001	U002	U003	U004	U005	U006	U007	U008	U009	U010	U011	U012	U013	U014	U015	U016	U017	U018	U019	U020	U021
------	------	------	------	------	------	------	------	------	------	------	------	------	------	------	------	------	------	------	------	------

U010_S001 TRANSFER UNIT:INTERMEDIATE TRANSFER:ASS'Y

- 42.AZ320194 POWER PACK:T1/T2
- 37.AW500045 PUSH SWITCH
- 28.AA061068 TENSION SPRING:BRACKET:DRIVEN ROLLER:INNER BACK
- 49.D0743878 HOLDER:RADIAL BALL BEARING:DRIVEN ROLLER:INNER BACK
- 34.AB032072 (x2) PULLEY:DRIVEN:WIRE

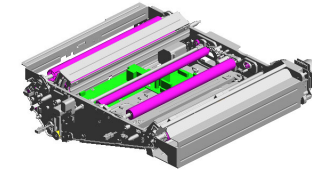

129.D2706002
[A]
TRANSFER UNIT:INTERMEDIATE TRANSFER:ASS'Y
201907-08 O/O

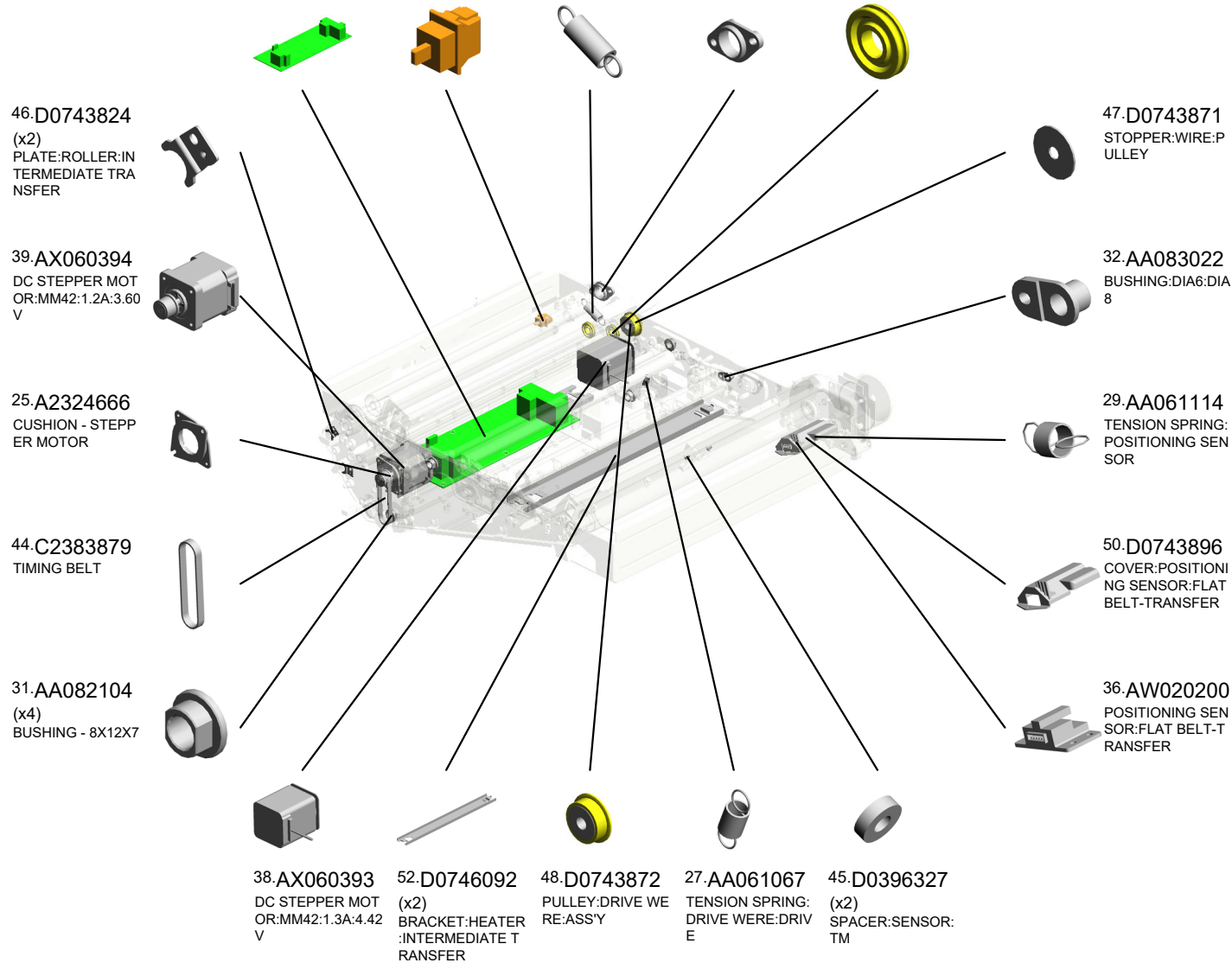

U010_S001
TRANSFER UNIT:INTERMEDIATE TRANSFER:ASS'Y

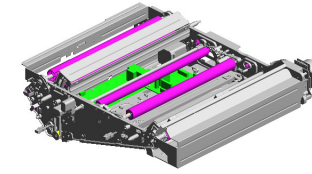

129-D2706002
[A]
TRANSFER UNIT:INTERMEDIATE TRANSFER:ASS'Y
201907-08 O/O

54.D0746134 PLAIN SHAFT BEARING:INSULATE
77.D1796057 ROLLER:TRANSFER:FRONT:ASSY
73.D1793144 COVER:INTERMEDIATE TRANSFER:LOWER
74.D1795412 PCB:TDRB
58.D0746147 TERMINAL:INTERMEDIATE TRANSFER

68.D1366183 GRIP:ON-OFF:INTERMEDIATE TRANSFER:TCRU

65.D1366099 TENSION SPRING:BRACKET:DC STEPPER MOTOR

53.D0746097 THERMOSTAT:INTERMEDIATE TRANSFER

66.D1366145 (x6) ROLLER:ON-OFF:INTERMEDIATE TRANSFER

67.D1366149 (x4) BUSHING:SLIDE RAIL:ON-OFF

79.D1796065 DRIVE ROLLER:INTERMEDIATE TRANSFER:ASSY

57.D0746146 BRACKET:BIAS:INTERMEDIATE TRANSFER

59.D0746161 COVER:BIAS:INTERMEDIATE TRANSFER

60.D0746180 COMPRESSION SPRING:BIAS:INTERMEDIATE TRANSFER

78.D1796062 (x2) TENSION SPRING:PRESSURE:INTERMEDIATE TRANSFER

61.D0746197 TERMINAL:CONNECTING:BIAS:INTERMEDIATE TRANSFER

71.D1791353 GEAR:DRIVE ROLLER:INTERMEDIATE TRANSFER

69.D1791351 DC MOTOR:DIA63:24V:28.4W

72.D1791354 HOLDER:MOTOR:INTERMEDIATE TRANSFER

70.D1791352 HOUSING:DRIVE UNIT:INTERMEDIATE TRANSFER

U001	U002	U003	U004	U005	U006	U007	U008	U009	U010	U011	U012	U013	U014	U015	U016	U017	U018	U019	U020	U021
------	------	------	------	------	------	------	------	------	------	------	------	------	------	------	------	------	------	------	------	------

U010_S001 TRANSFER UNIT:INTERMEDIATE TRANSFER:ASS'Y

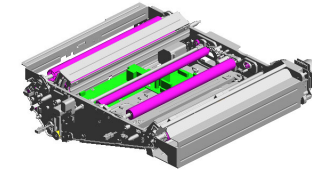

129.D2706002
[A]
TRANSFER UNIT:INTERMEDIATE TRANSFER:ASS'Y
201907-08 O/O

99.D1796147 (x2) CAM:ON-OFF:INTERMEDIATE TRANSFER
80.D1796080 (x2) ROLLER:OPPOSED:BELT CLEANING:ASS'Y
94.D1796140 LEVER:ON-OFF:ROLLER:FRONT
83.D1796094 CASE:TENSION:ROLLER
84.D1796095 SUPPORTING PLATE:CASE:TENSION:ROLLER

86.D1796098 (x2) COIL SPRING:PRESSURE:TENSION:INTERMEDIATE TRANSFER

85.D1796097 (x2) PLAIN SHAFT BEARING:RING:TENSION:ROLLER:INTERMEDIATE TRANSFER

91.D1796122 BRACKET:ON-OFF:TRANSFER ROLLER

100.D1796154 CASE:OPPOSED:TRANSFER ROLLER:FRONT

90.D1796119 PULLEY:ON-OFF:TRANSFER ROLLER

96.D1796143 (x2) ARM:LEVER:ON-OFF:ROLLER

97.D1796144 (x2) TENSION SPRING:SLIDE RAIL:TRANSFER

98.D1796146 SHAFT:ON-OFF:INTERMEDIATE TRANSFER

92.D1796125 CAM:ON-OFF:TRANSFER:PAPER:REAR

88.D1796112 DUCT:DENSITY SENSOR:INTERMEDIATE TRANSFER

95.D1796141 LEVER:ON-OFF:ROLLER:REAR

89.D1796117 BRACKET:DRAWER:INTERMEDIATE TRANSFER

101.D1796155 CASE:OPPOSED:TRANSFER ROLLER:REAR

102.D1796156 COVER:CASE:OPPOSED:TRANSFER ROLLER:REAR

93.D1796127 FEELER:ON-OFF:TRANSFER:PAPER

U010_S001
TRANSFER UNIT:INTERMEDIATE TRANSFER:ASS'Y

- 112.D1796188 BRACKET:COIL SPRING:MOTOR:POSITIONING CONTROL
- 111.D1796187 FEELER:POSITIONING CONTROL:DRIVE WERE
- 108.D1796182 BRACKET:POSITIONING CONTROL:DRIVEN ROLLER:REAR:ASS'Y
- 110.D1796186 DRIVE WERE:DRIVEN ROLLER
- 109.D1796185 BRACKET:MOTOR:POSITIONING CONTROL:DRIVEN ROLLER

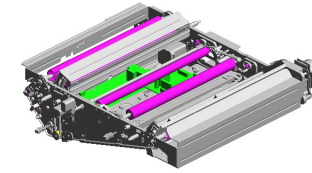

- 129.D2706002 **[A]** TRANSFER UNIT:INTERMEDIATE TRANSFER:ASS'Y 201907-08 O/O

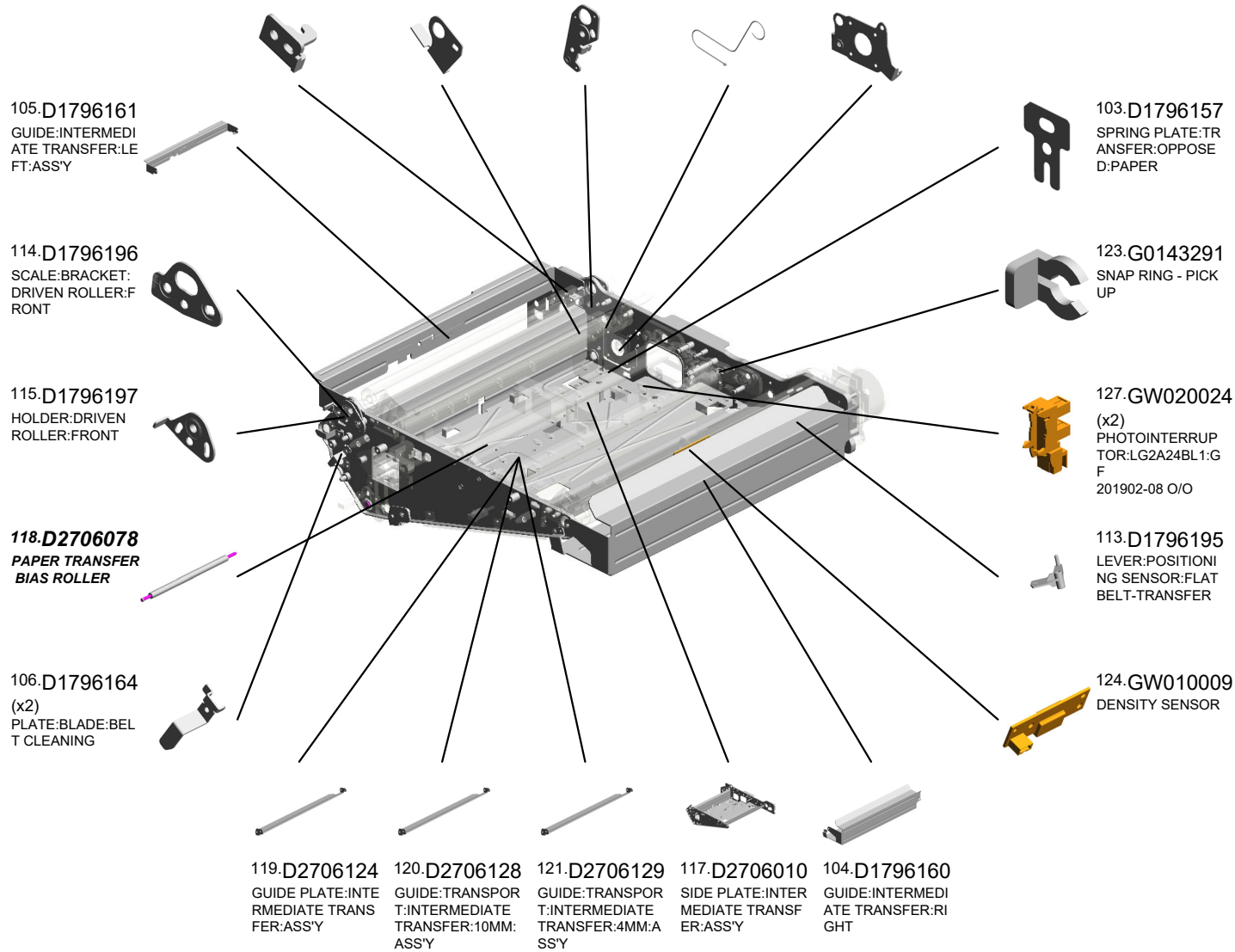

U001	U002	U003	U004	U005	U006	U007	U008	U009	U010	U011	U012	U013	U014	U015	U016	U017	U018	U019	U020	U021
------	------	------	------	------	------	------	------	------	------	------	------	------	------	------	------	------	------	------	------	------

U010_S001
TRANSFER UNIT:INTERMEDIATE TRANSFER:ASS'Y

128.D0BX6051 132.AA043725
 ROLLER:INTERME
 DIATE TRANSFER:
 ASS'Y M142
 201907-06 O/O 202108-01 O/O

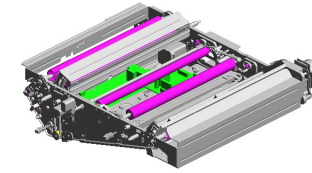

129.D2706002
 [A]
 TRANSFER UNIT:I
 NTERMEDIATE TR
 ANSFER:ASS'Y
 201907-08 O/O

130.D0A56044
 BRACKET:INTERM
 EDIATE TRANSFE
 R:FRONT
 202009-01 X/O



131.D0A56045
 BRACKET:INTERM
 EDIATE TRANSFE
 R:REAR
 202009-02 X/O

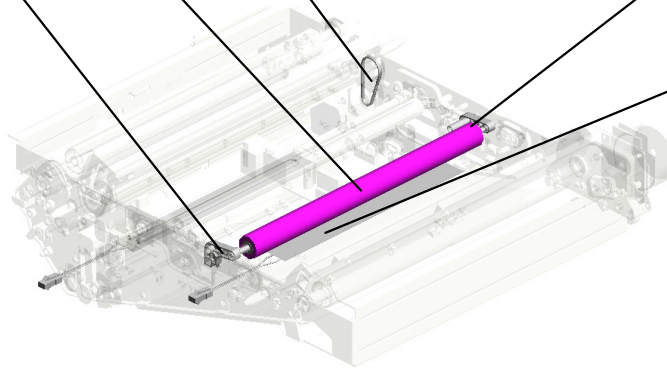

133.AX400275
 (x2)
 HEATER:230V:9W
 202210-01 O/O

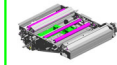

D2706001
 [A]
 TRANSFER UNIT:I
 NTERMEDIATE TR
 ANSFER:ASS'Y
 201907-08 O/O

U010_S001_S001
ROLLER:DRIVEN:INTERMEDIATE TRANSFER:ASS'Y

14.07403808
BALL BEARING - 8
X16X5MM

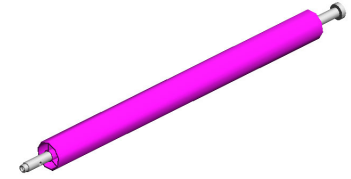

81.D1796085
ROLLER:DRIVEN:INTERMEDIATE TRANSFER:ASS'Y

U001	U002	U003	U004	U005	U006	U007	U008	U009	U010	U011	U012	U013	U014	U015	U016	U017	U018	U019	U020	U021
------	------	------	------	------	------	------	------	------	------	------	------	------	------	------	------	------	------	------	------	------

U010_S001_S002
ROLLER:TENSION:ASS'Y

17.08053573
(x2)
RADIAL BALL BEA
RING:DIA8XDIA16X
5

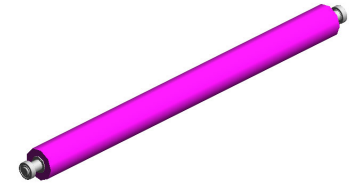

82.D1796091
ROLLER:TENSION:
ASS'Y

U001	U002	U003	U004	U005	U006	U007	U008	U009	U010	U011	U012	U013	U014	U015	U016	U017	U018	U019	U020	U021
------	------	------	------	------	------	------	------	------	------	------	------	------	------	------	------	------	------	------	------	------

U010_S001_S003
ROLLER:TRANSFER:PAPER:FRONT:ASS'Y

17.08053573
(x2)
RADIAL BALL BEA
RING:DIA8XDIA16X
5

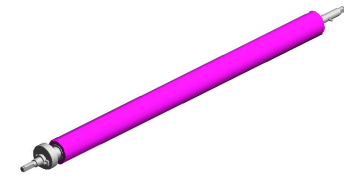

87.D1796108
ROLLER:TRANSFE
R:PAPER:FRONT:A
SS'Y

U001	U002	U003	U004	U005	U006	U007	U008	U009	U010	U011	U012	U013	U014	U015	U016	U017	U018	U019	U020	U021
------	------	------	------	------	------	------	------	------	------	------	------	------	------	------	------	------	------	------	------	------

U010_S002
 DRUM STAY:INTERMEDIATE TRANSFER:SUB-ASS'Y

2.03603006N (x6) SCREW - M3X6
 107.D1796173 SEAL:DUCT:DENSITY SENSOR
 63.D0747118 DUCT:INNER BACK:COOLING:POSITIONING SENSOR
 6.03604008N (x5) SCREW - M4X8

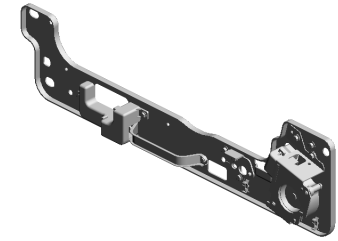

125.D2706170
 DRUM STAY:INTERMEDIATE TRANSFER:SUB-ASS'Y

43.B7125605
 GRIP:APPLICATION

122.D2706175
 INNER COVER:INTERMEDIATE TRANSFER:LEVER

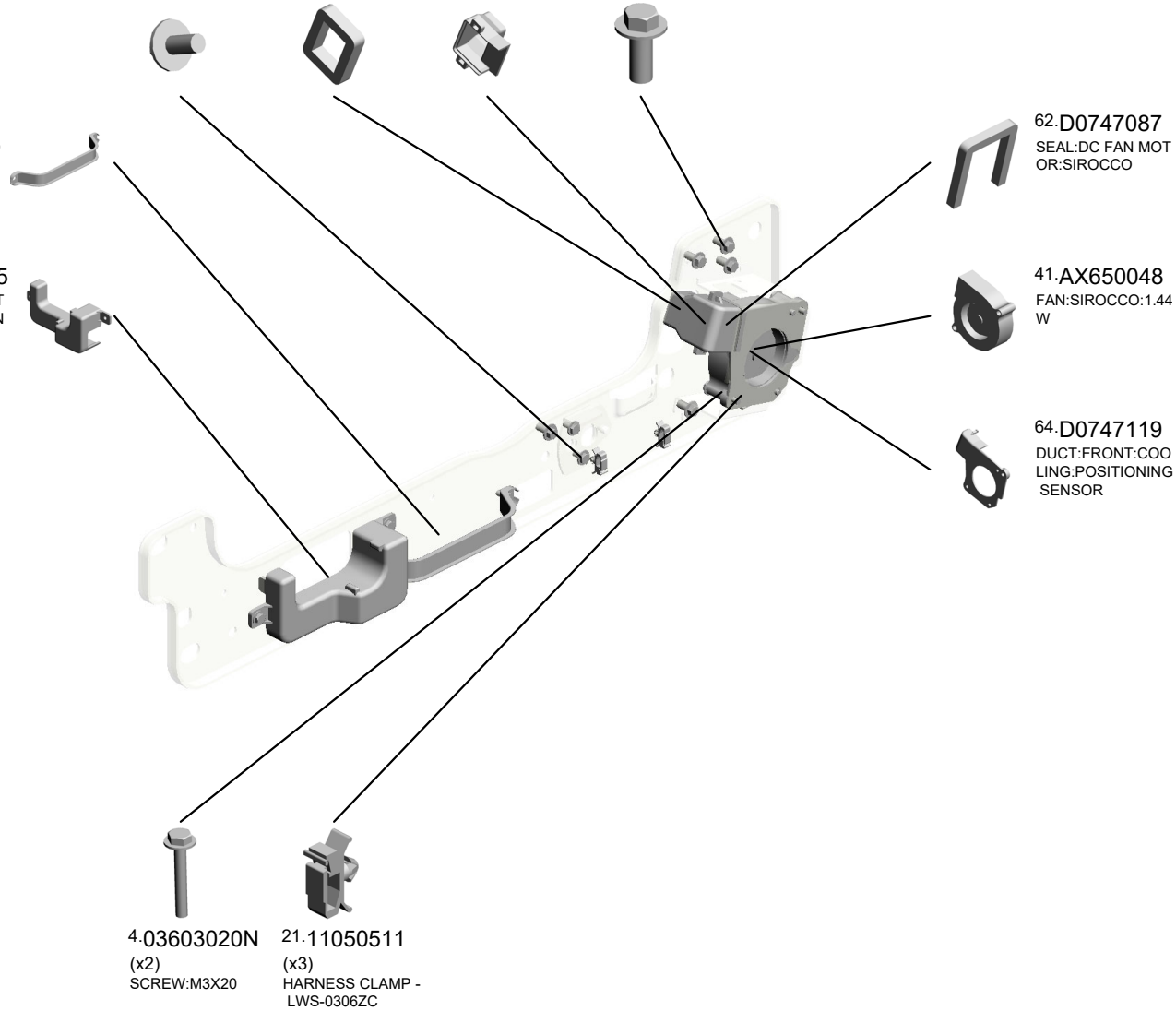

62.D0747087
 SEAL:DC FAN MOTOR:SIROCCO

41.AX650048
 FAN:SIROCCO:1.44W

64.D0747119
 DUCT:FRONT:COOLING:POSITIONING SENSOR

4.03603020N (x2) SCREW:M3X20

21.11050511 (x3) HARNESS CLAMP - LWS-0306ZC

U011.ITB CLEANING

U011 S001
D0BX6401
BELT CLEANING:ASS'Y

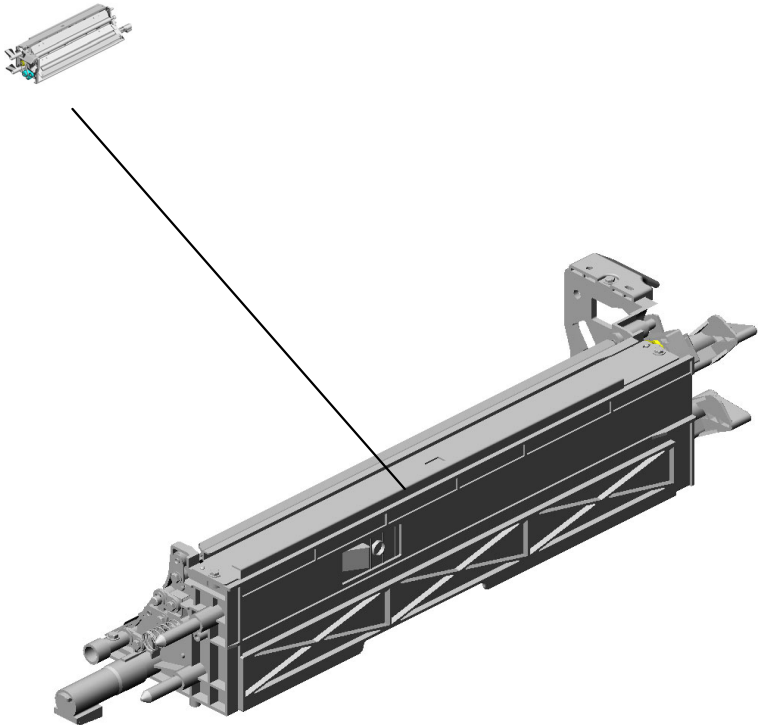

U001	U002	U003	U004	U005	U006	U007	U008	U009	U010	U011	U012	U013	U014	U015	U016	U017	U018	U019	U020	U021
------	------	------	------	------	------	------	------	------	------	------	------	------	------	------	------	------	------	------	------	------

U011_S001.BELT CLEANING:ASS'Y

U011 S001 S001
D0BX6450
COATING BAR:ASS'Y

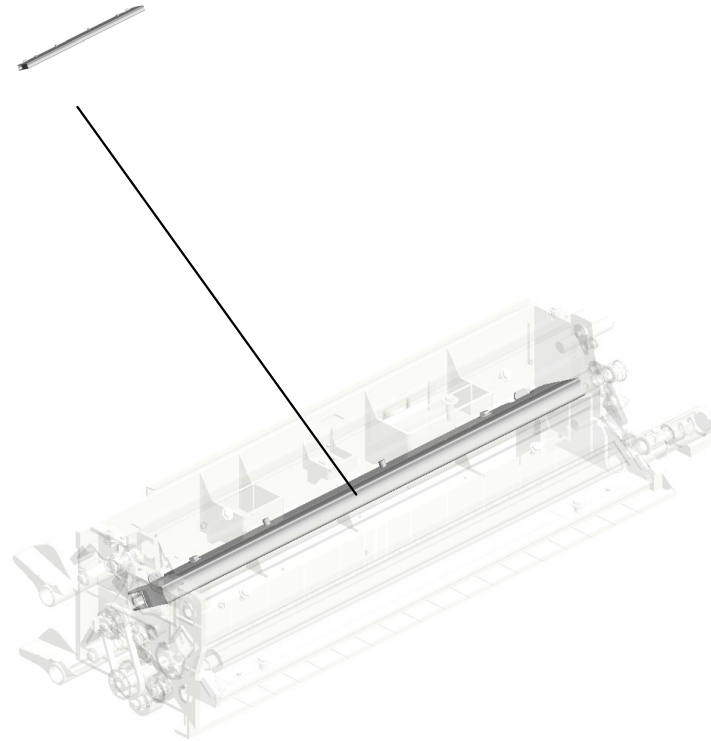

U001	U002	U003	U004	U005	U006	U007	U008	U009	U010	U011	U012	U013	U014	U015	U016	U017	U018	U019	U020	U021
------	------	------	------	------	------	------	------	------	------	------	------	------	------	------	------	------	------	------	------	------

U011
ITB CLEANING

9-B2342390
FLANGED HEXAG
ONAL HEAD BOLT:
M4X8

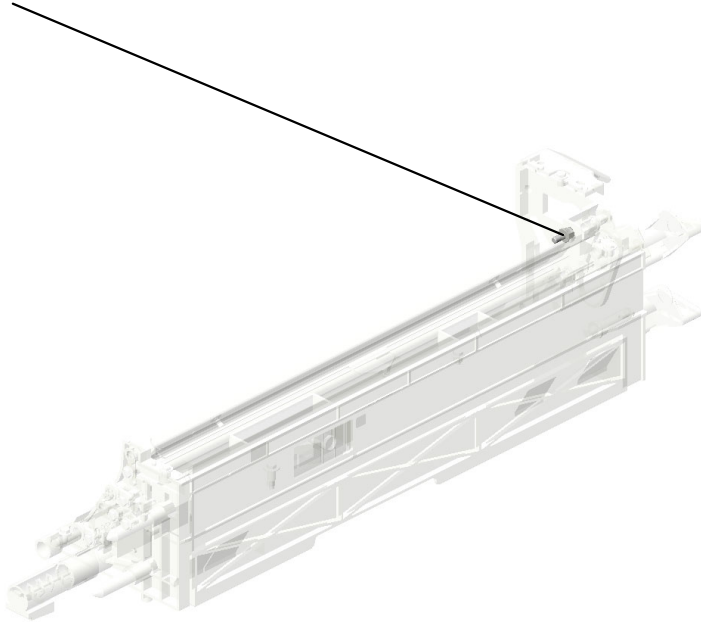
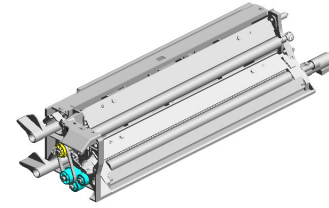

U001	U002	U003	U004	U005	U006	U007	U008	U009	U010	U011	U012	U013	U014	U015	U016	U017	U018	U019	U020	U021
------	------	------	------	------	------	------	------	------	------	------	------	------	------	------	------	------	------	------	------	------

U011_S001
BELT CLEANING:ASS'Y

- 8.B1322264 (x2) BUSHING:TERMINAL
- 18.D0746431 COIL SPRING:BLADE:CLEANING
- 17.D0746428 HOLDER:CLEANING:BELT CLEANING:ASS'Y
- 16.D0746424 **BLADE:CLEANING:BELT CLEANING:ASS'Y**
- 10.B5457506 SCREW:BUSHING

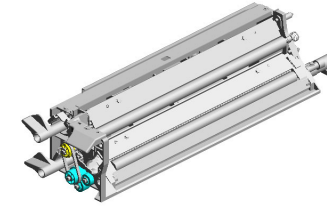

64.D0BX6401
[A]
BELT CLEANING:ASS'Y
202109-01 X/O

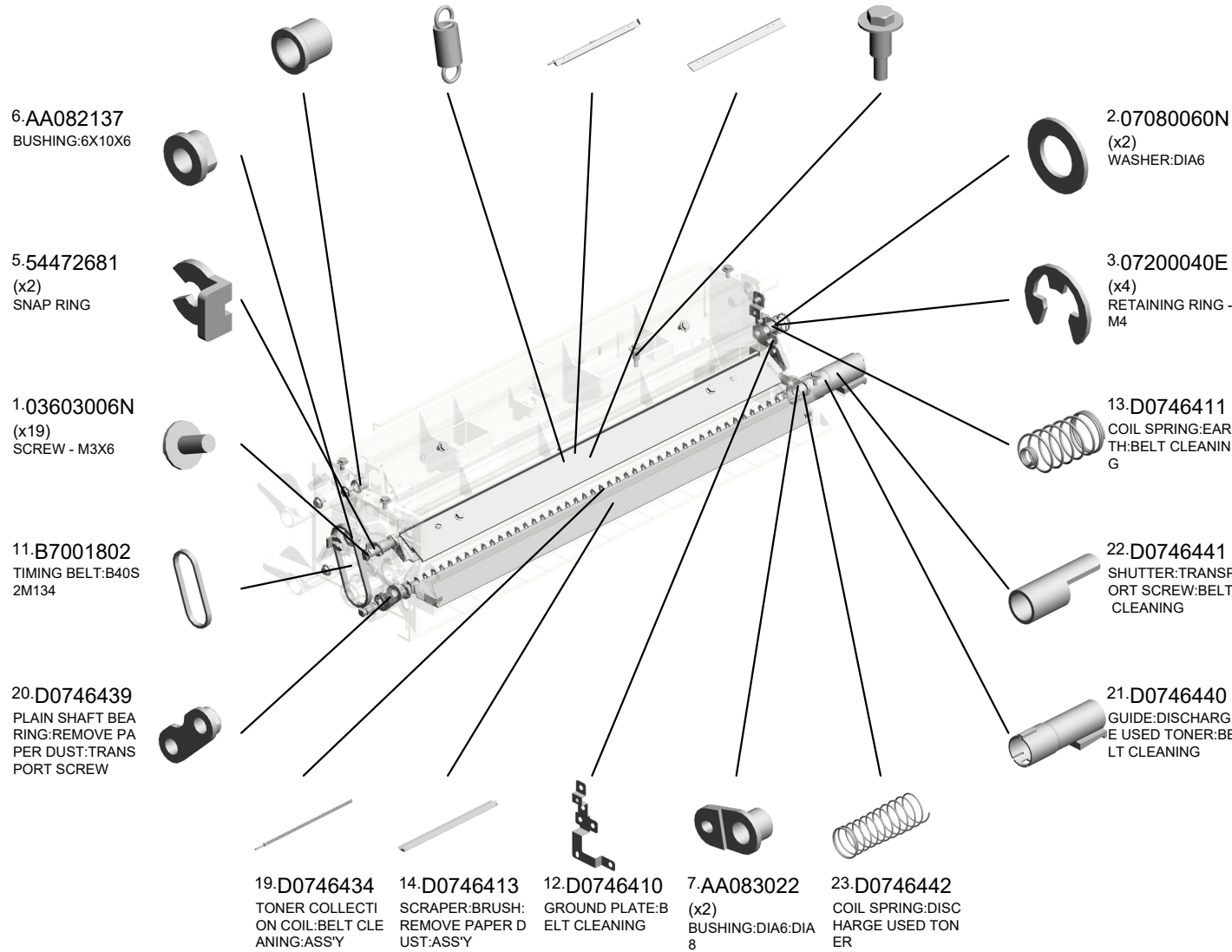

U001	U002	U003	U004	U005	U006	U007	U008	U009	U010	U011	U012	U013	U014	U015	U016	U017	U018	U019	U020	U021
------	------	------	------	------	------	------	------	------	------	------	------	------	------	------	------	------	------	------	------	------

U011_S001
BELT CLEANING:ASS'Y

- 31.D0746464 COIL SPRING:BLADE:APPLY:BELT CLEANING
- 34.D0746469 SLIDE RAIL:UPPER:BELT CLEANING
- 30.D0746461 HOLDER:APPLY:BELT CLEANING:ASS'Y
- 29.D0746457** **BLADE:APPLY:ASS'Y**
- 33.D0746468 STOPPER:CASE:BELT CLEANING

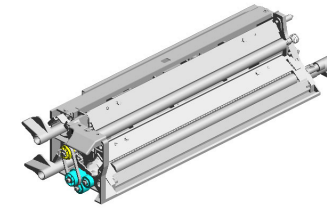

64.D0BX6401
[A]
BELT CLEANING:ASS'Y
202109-01 X/O

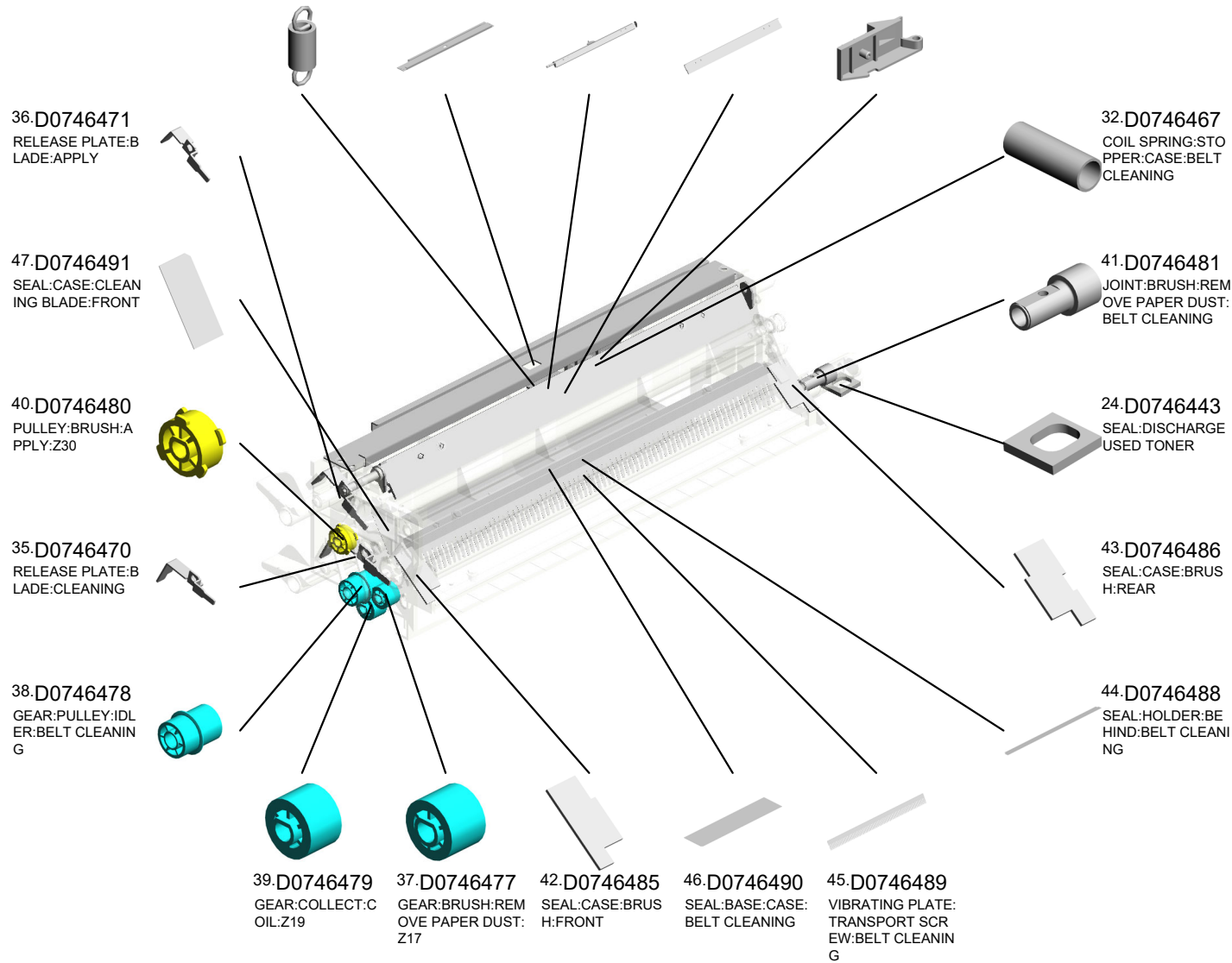

U001	U002	U003	U004	U005	U006	U007	U008	U009	U010	U011	U012	U013	U014	U015	U016	U017	U018	U019	U020	U021
------	------	------	------	------	------	------	------	------	------	------	------	------	------	------	------	------	------	------	------	------

U011_S001
BELT CLEANING:ASS'Y

50.D0746496 GRIP:BELT CLEANING
54.D1796413 SEAL:HOLDER:CLEANING BLADE:FRONT LOWER
66.D0BX6446 BRUSH:APPLY:BELT CLEANING
202110-03 X/O
51.D0746497 (x2) DECAL:POSITIONING DISPLAY:TCRU

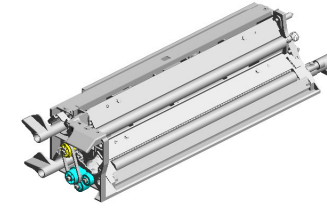

64.D0BX6401
[A]
BELT CLEANING:ASS'Y
202109-01 X/O

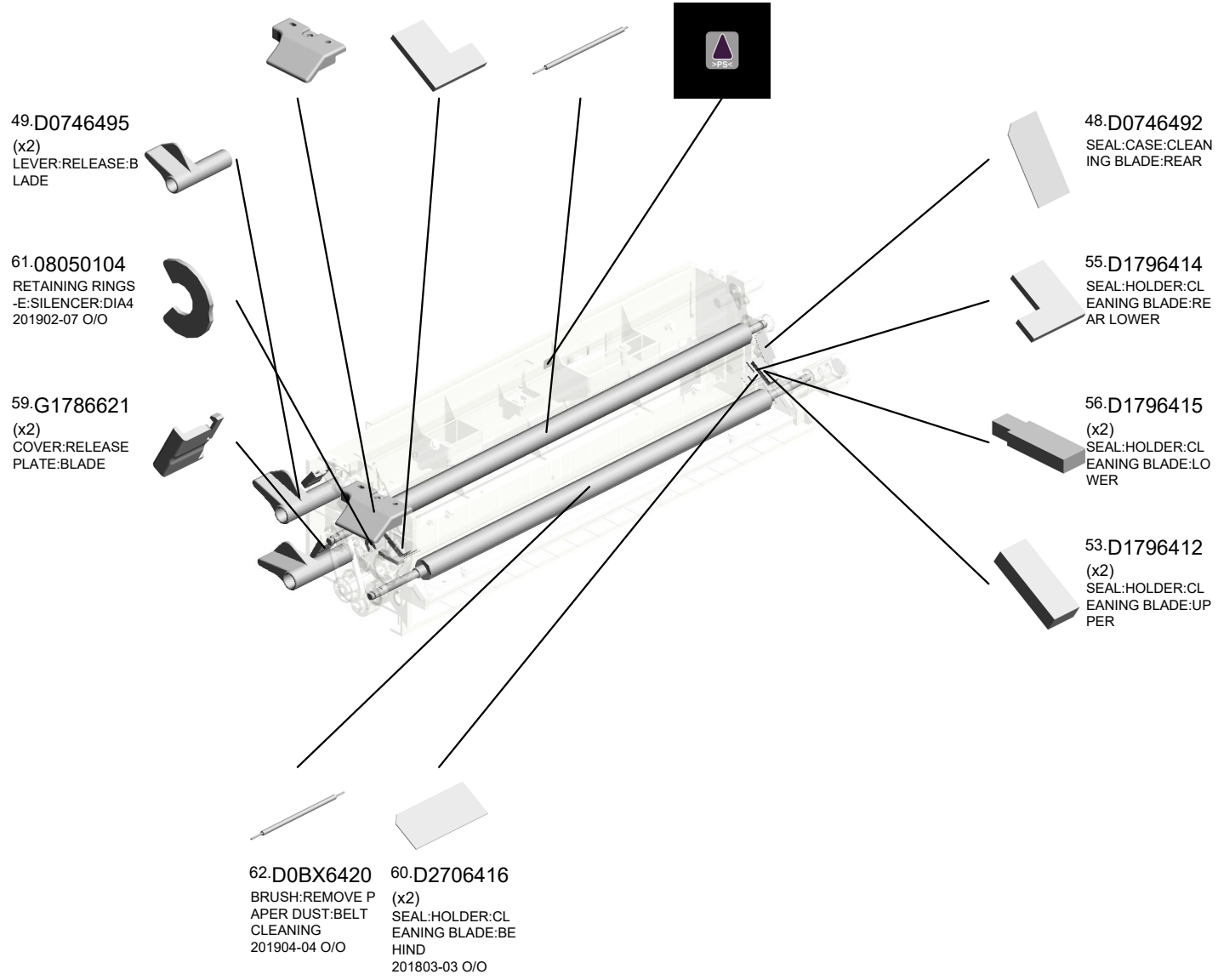

U001	U002	U003	U004	U005	U006	U007	U008	U009	U010	U011	U012	U013	U014	U015	U016	U017	U018	U019	U020	U021
------	------	------	------	------	------	------	------	------	------	------	------	------	------	------	------	------	------	------	------	------

U011_S001_S001
COATING BAR:ASS'Y

27.D0746454 58.G0801169
(x2) (x2)
ARM:COATING BA SCREW:M3
R:BELT CLEANING



67.D0BX6450
[A]
COATING BAR:AS
S'Y
202111-02 X/O



65.D0BX6455
COIL SPRING:COA
TING BAR
202109-02 X/O

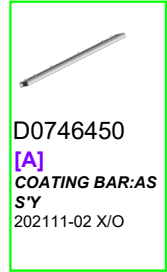

D0746450
[A]
COATING BAR:AS
S'Y
202111-02 X/O

U001	U002	U003	U004	U005	U006	U007	U008	U009	U010	U011	U012	U013	U014	U015	U016	U017	U018	U019	U020	U021
------	------	------	------	------	------	------	------	------	------	------	------	------	------	------	------	------	------	------	------	------

U012.TRANSFER/SEPARATION

U012 S002
D1796230
CASE:TERMINAL:SEPARATI
ON:ASSY

U012 S003
D1796350
TRANSFER/SEPARATION UN
IT:DRIVE:ASSY

U012 S001
D0BX6210
TRANSFER UNIT:ASSY

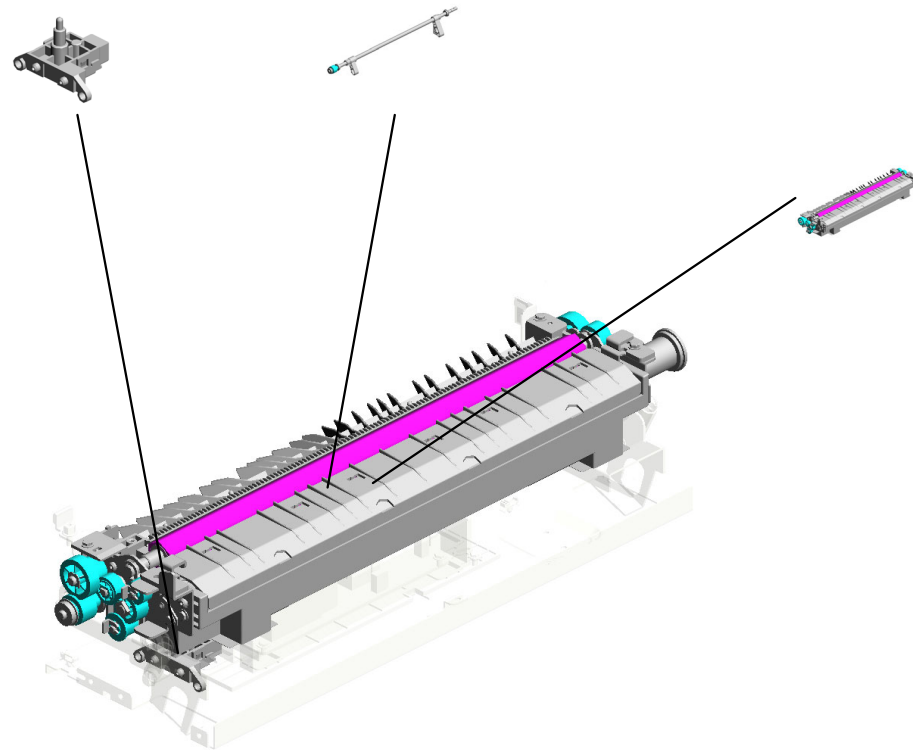

U001	U002	U003	U004	U005	U006	U007	U008	U009	U010	U011	U012	U013	U014	U015	U016	U017	U018	U019	U020	U021
------	------	------	------	------	------	------	------	------	------	------	------	------	------	------	------	------	------	------	------	------

U012_S001.TRANSFER UNIT:ASS'Y

U012 S001 S003
D2706230
SIDE PLATE:TRANSFER/SEP
ARATION UNIT:FRONT:ASS'
Y

U012 S001 S002
D0BX6310
SEPARATION CORONA:ASS'
Y

U012 S001 S001
D0BX6225
SIDE PLATE:TRANSFER/SEP
ARATION UNIT:REAR:ASS'Y

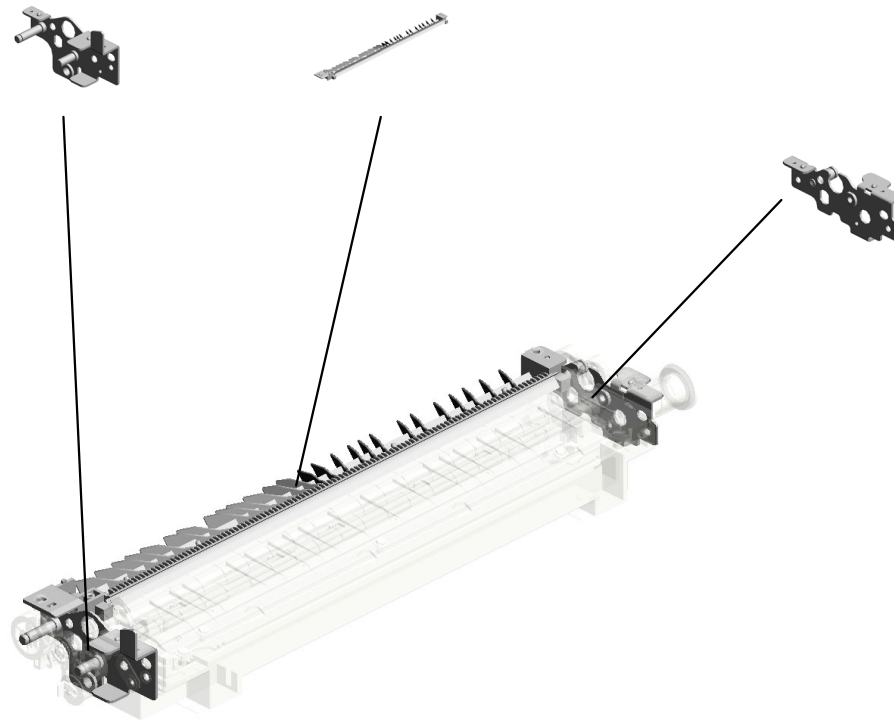

U001	U002	U003	U004	U005	U006	U007	U008	U009	U010	U011	U012	U013	U014	U015	U016	U017	U018	U019	U020	U021
------	------	------	------	------	------	------	------	------	------	------	------	------	------	------	------	------	------	------	------	------

U012 TRANSFER/SEPARATION

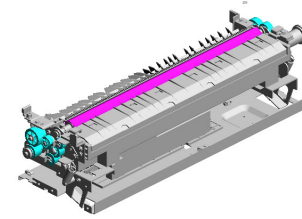
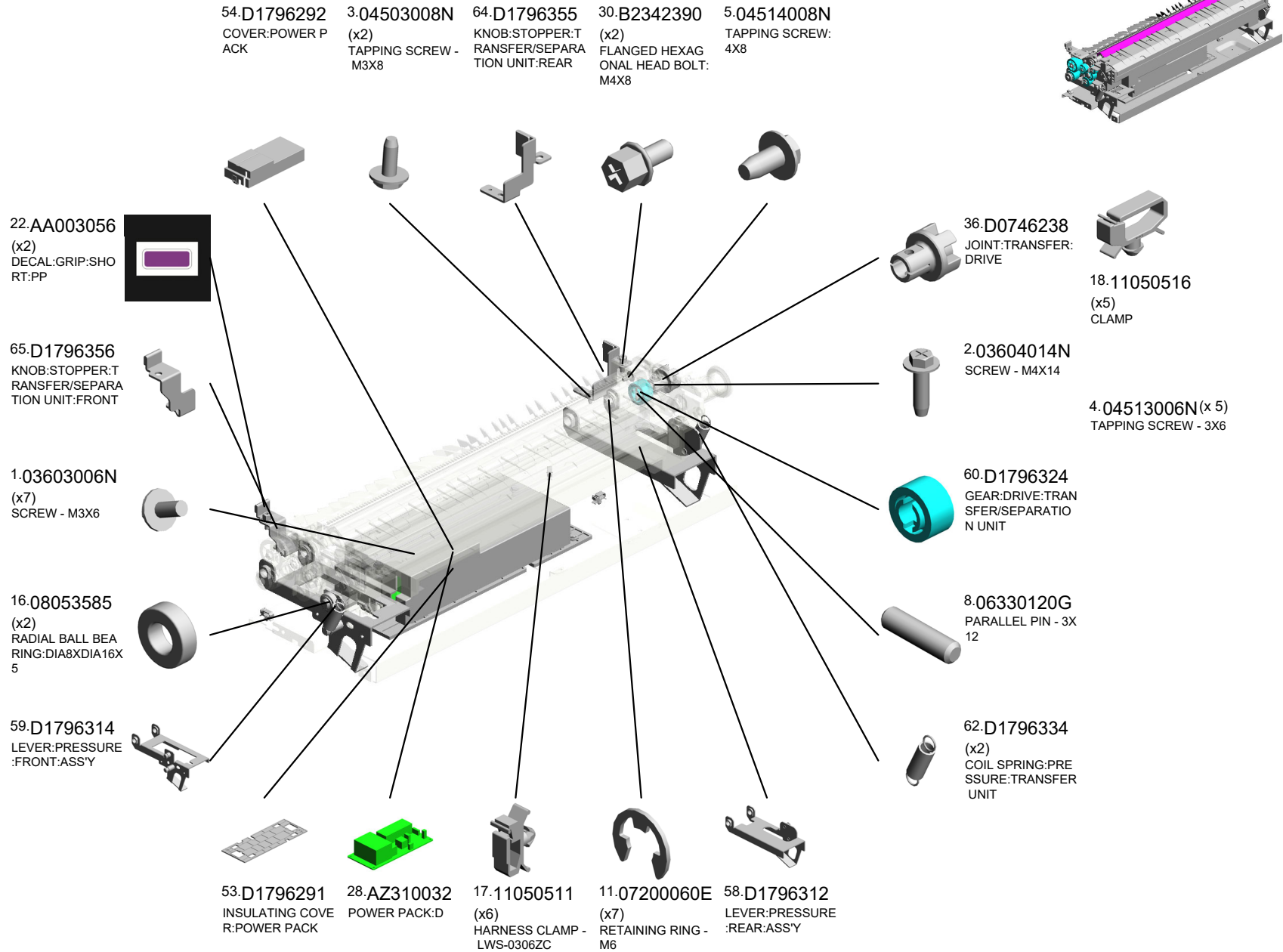

U012 TRANSFER/SEPARATION

83-AA000290 77-D2706333
(x2) SHAFT:LEVER:PRE
DECAL:POSITIONI SSURE:TRANSFER
NG DISPLAY:SCRE ROLLER
W:PET 201807-12 O/O
202102-02 O/O

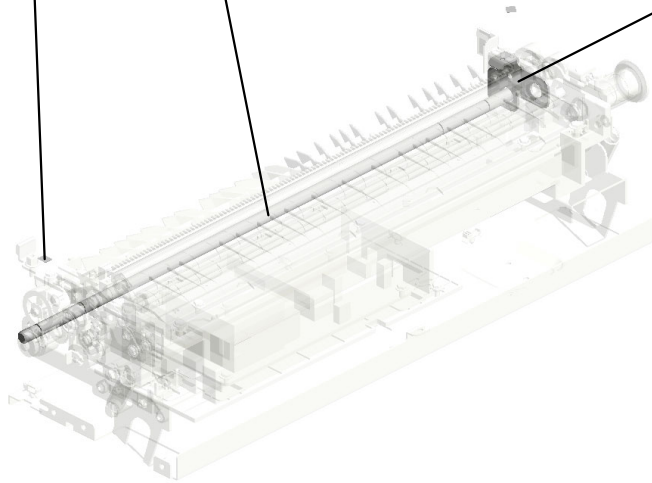

73-D2706350
BRACKET:SHAFT:
CONTACT POINT:T
RANSFER ROLLER
201708-03 X/O

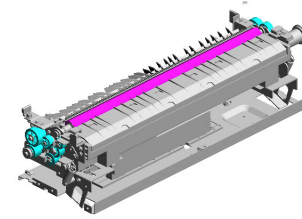

U001	U002	U003	U004	U005	U006	U007	U008	U009	U010	U011	U012	U013	U014	U015	U016	U017	U018	U019	U020	U021
------	------	------	------	------	------	------	------	------	------	------	------	------	------	------	------	------	------	------	------	------

U012_S001
TRANSFER UNIT:ASS'Y

- 11.07200060E RETAINING RING - M6
- 37.D0746241 (x2) DECAL:GRIP:TRANSFER/SEPARATION UNIT
- 31.D0146272 BUSHING:BRUSH:REAR
- 34.D0746228 ELECTRODE PLATE:FRAME
- 3.04503008N TAPPING SCREW - M3X8

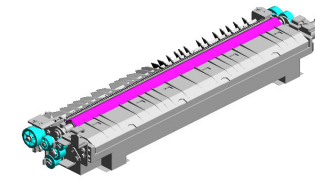

81.D0BX6210
[A]
TRANSFER UNIT:ASS'Y
201907-09 O/O

26.AB011125
GEAR:20/29Z

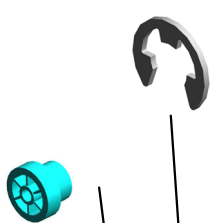

9.07010060N
WASHER DIA6



27.AB011126
GEAR:20Z



19.52062686
SNAP RING



15.08053568
RADIAL BALL BEARING: DIA8XDIA14X4



10.07200040E (x3)
RETAINING RING - M4



1.03603006N (x16)
SCREW - M3X6



39.D0746257
BRUSH ROLLER:APPLY:ASS'Y



6.04523008N (x2)
TAPPING SCREW - M3X8



23.AA080154
REAR BUSHING



20.52152621
SNAP RING - M6



7.04543008Q (x2)
TAPPING SCREW: 3X8



32.D0746216
SHUTTER:TONER OUTLET SUB-UNIT: SUB-ASS'Y



33.D0746219
COIL SPRING:SHUTTER:DISCHARGE USED TONER

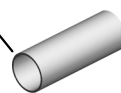

35.D0746235
CASE:TONER RECYCLING SUB-UNIT: SUB-ASS'Y



U001	U002	U003	U004	U005	U006	U007	U008	U009	U010	U011	U012	U013	U014	U015	U016	U017	U018	U019	U020	U021
------	------	------	------	------	------	------	------	------	------	------	------	------	------	------	------	------	------	------	------	------

U012_S001
TRANSFER UNIT:ASS'Y

49.D0746315
GEAR:BRUSH:APP
LY

44.D0746276
PIN:POSITIONING
PLATE:BLADE:TRA
NSFER ROLLER:ASS'Y

55.D1796298
(x2)
COIL SPRING:COA
TING BAR:2.2N

40.D0746265
BLADE:TRANSFER
ROLLER:ASS'Y

52.D1796280
(Sets part number:D
0746283 x2):GUIDE
PLATE:ENTRANC
E:LOWER:ASS'Y

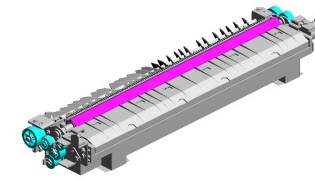

81.D0BX6210
[A]
TRANSFER UNIT:ASS'Y
201907-09 O/O

76.08053445
(x2)
BEARING - M6X10X
3
201807-13 X/O

47.D0746313
GEAR:IDLER:COLL
ECTION COIL

69.D2706360
GROUND PLATE:TR
ANSPORT SCRE
W:ASS'Y

48.D0746314
GEAR:COLLECTIO
N COIL

74.08050103
RETAINING RINGS
-E:SILENCER:DIA3
201807-05 O/O

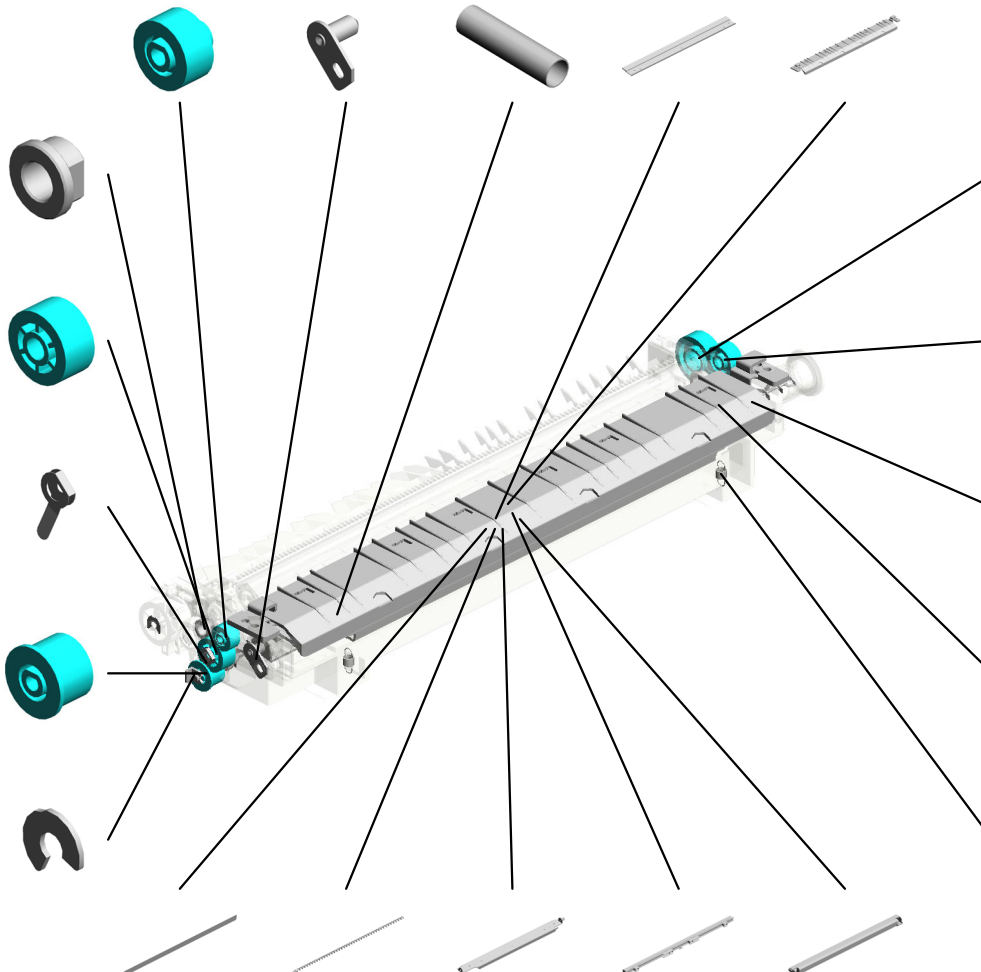

46.D0746312
GEAR:IDLER:TRAN
SFER ROLLER

57.D1796311
GEAR:TRANSFER
ROLLER

75.08050104
(x2)
RETAINING RINGS
-E:SILENCER:DIA4
201807-04 O/O

43.D0746274
(x2)
SEAL:HOLDER:UP
PER

45.D0746279
(x2)
COIL SPRING:BLA
DE:TRANSFER RO
LLER

42.D0746273
SEAL:HOLDER

68.D2706304
TRANSPORT SCR
EW:TRANSFER RO
LLER:ASS'Y

41.D0746270
HOLDER:BLADE:ASS'Y

71.G1786767
COATING BAR:TR
ANSFER ROLLER

70.G1784018
CASE:COATING BA
R:TRANSFER ROL
LER

U012_S001
TRANSFER UNIT:ASS'Y

85.D0746283 (x2)
(Set part number:D1796280):SHIELD:GUIDE PLATE:ENTRANCE:LOWER

78.D0BX6255
BRUSH ROLLER:TRANSFER ROLLER:ASS'Y
201812-06 X/X

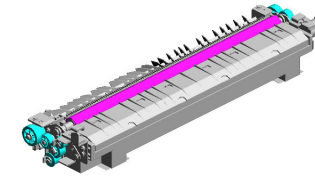

81.D0BX6210
[A]
TRANSFER UNIT:ASS'Y
201907-09 O/O

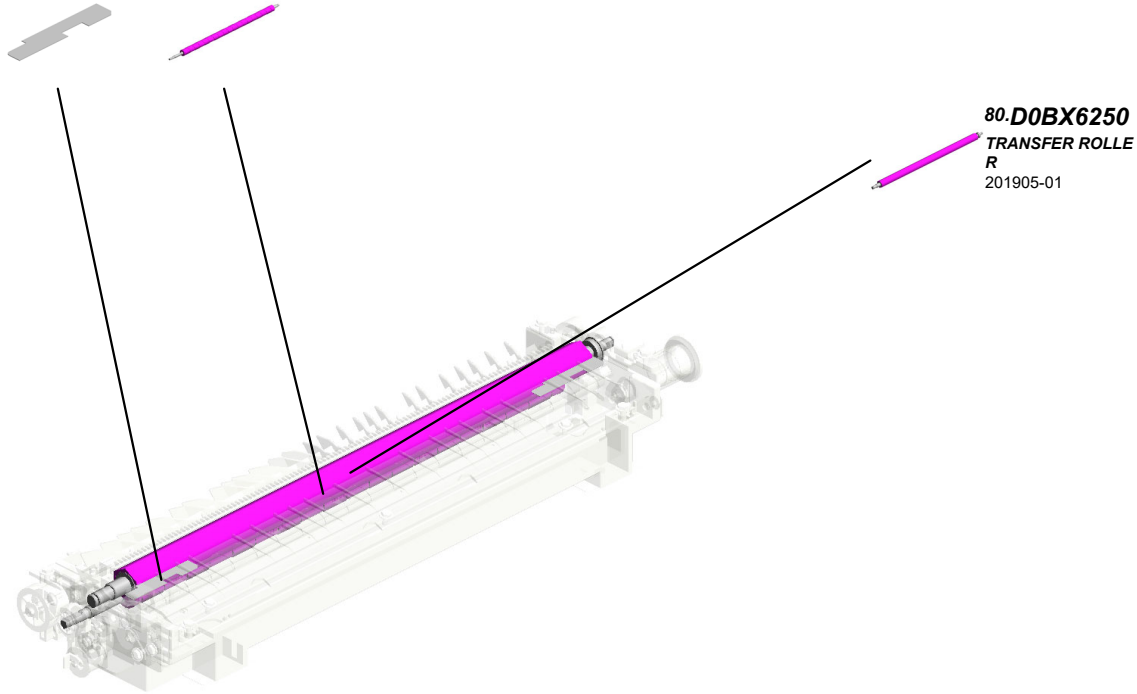

80.D0BX6250
TRANSFER ROLLER
201905-01



D2706211
[A]
TRANSFER UNIT:ASS'Y
201907-09 O/O

U012_S001_S001
SIDE PLATE:TRANSFER/SEPARATION UNIT:REAR:ASS'Y

29.B1202063
BUSHING - 4MM

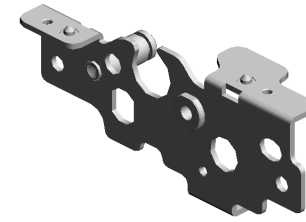
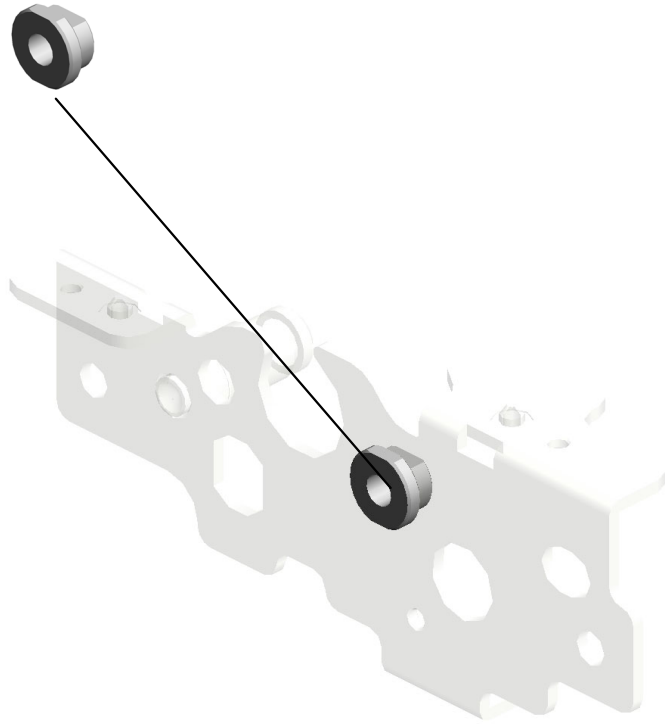

82.D0BX6225
SIDE PLATE:TRAN
SFER/SEPARATIO
N UNIT:REAR:ASS'
Y
201907-02

U001	U002	U003	U004	U005	U006	U007	U008	U009	U010	U011	U012	U013	U014	U015	U016	U017	U018	U019	U020	U021
------	------	------	------	------	------	------	------	------	------	------	------	------	------	------	------	------	------	------	------	------

U012_S001_S002
SEPARATION CORONA:ASS'Y

6.04523008N
TAPPING SCREW -
M3X8

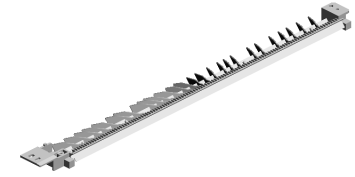

84.D0BX6310
[A]
SEPARATION COR
ONA:ASS'Y
202110-01 O/O



D1796310
[A]
SEPARATION COR
ONA:ASS'Y
202110-01 O/O

U001	U002	U003	U004	U005	U006	U007	U008	U009	U010	U011	U012	U013	U014	U015	U016	U017	U018	U019	U020	U021
------	------	------	------	------	------	------	------	------	------	------	------	------	------	------	------	------	------	------	------	------

U012_S001_S003
SIDE PLATE:TRANSFER/SEPARATION UNIT:FRONT:ASS'Y

24-AA082101
BUSHING - 6X10X6

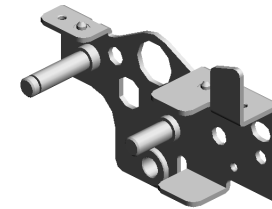
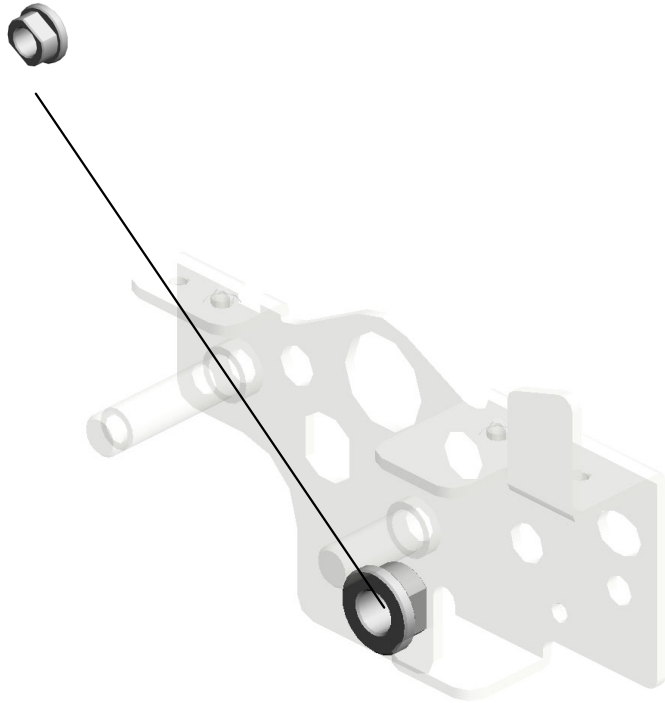

67-D2706230
SIDE PLATE:TRAN
SFER/SEPARATIO
N UNIT:FRONT:AS
S'Y

U001	U002	U003	U004	U005	U006	U007	U008	U009	U010	U011	U012	U013	U014	U015	U016	U017	U018	U019	U020	U021
------	------	------	------	------	------	------	------	------	------	------	------	------	------	------	------	------	------	------	------	------

U012_S002
CASE:TERMINAL:SEPARATION:ASS'Y

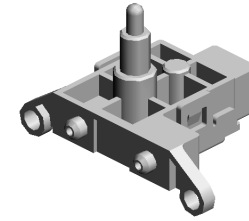

50.D1796230
CASE:TERMINAL:SEPARATION:ASS'Y

- 1.03603006N(x 2)
SCREW - M3X6
- 3.04503008N(x 1)
TAPPING SCREW - M3X8

U001	U002	U003	U004	U005	U006	U007	U008	U009	U010	U011	U012	U013	U014	U015	U016	U017	U018	U019	U020	U021
------	------	------	------	------	------	------	------	------	------	------	------	------	------	------	------	------	------	------	------	------

U012_S003
TRANSFER/SEPARATION UNIT:DRIVE:ASS'Y

12.07433808
(x2)
RADIAL BALL BEA
RING: DIA8XDIA16X
5



63.D1796350
TRANSFER/SEPARATION UNIT:DRIVE
:ASS'Y

U001	U002	U003	U004	U005	U006	U007	U008	U009	U010	U011	U012	U013	U014	U015	U016	U017	U018	U019	U020	U021
------	------	------	------	------	------	------	------	------	------	------	------	------	------	------	------	------	------	------	------	------

U013.USED TONER

U013 S001
D1796501
TONER OUTLET SUB-UNIT:P
CU:ASSY



U013 S002
D0BX6528
TONER OUTLET SUB-UNIT:V
ERTICAL TRANSPORT:MAIN:
ASSY



U013 S003
D1796461
TONER OUTLET SUB-UNIT:C
OLLECTION BOTTLE:ASSY



U013 S004
D2706570
COLLECTION BOTTLE:SERVI
CE PARTS:ASSY

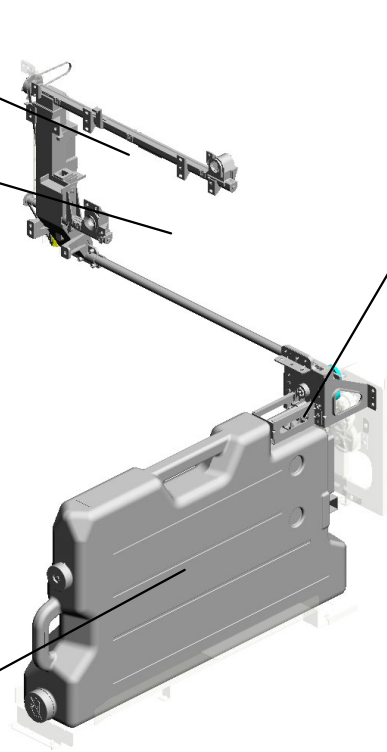
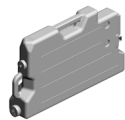

U001	U002	U003	U004	U005	U006	U007	U008	U009	U010	U011	U012	U013	U014	U015	U016	U017	U018	U019	U020	U021
------	------	------	------	------	------	------	------	------	------	------	------	------	------	------	------	------	------	------	------	------

U013 USED TONER

- 21.AB030877 TIMING PULLEY:Z5 1
- 29.D0746574 COVER:CAM:VERTICAL TRANSPORT
- 30.D0746575 SHAFT:CAM:VERTICAL TRANSPORT
- 31.D0746579 SEAL:COVER:CAM:VERTICAL TRANSPORT
- 34.D0746663 TORQUE LIMITER MECHANICAL CLUTCH:GEAR:Z63

2.04503008N
(x4)
TAPPING SCREW - M3X8

40.D1202829
TENSION SPRING: REGISTRATION:DRIVEN

6.04514008N
(x8)
TAPPING SCREW: 4X8

1.03603006N
SCREW - M3X6

12.11050534
(x2)
CLAMP

10.07200040E
(x4)
RETAINING RING - M4

13.11050723
CLAMPS:WES-050 7

27.AW500045
PUSH SWITCH

4.04513006N
(x12)
TAPPING SCREW - 3X6

24.AG071012
MAGNET CATCH:ASSY

37.D0746666
GEAR:IDLER:Z37/Z 28

35.D0746664
GEAR:IDLER:Z49/Z 27

38.D0746667
HOLDER:RADIAL BALL BEARING:JOINT

36.D0746665
GEAR:JOINT:COLLECTION BOTTLE:Z 65

33.D0746659
SHAFT:JOINT:COLLECTION BOTTLE: ASSY

59.11050511
HARNESS CLAMP - LWS-0306ZC 201708-06

6.04514008N(x14)
TAPPING SCREW:4X8

7.04543008Q(x 1)
TAPPING SCREW:3X8

58.04583008N(x 1)
HEXAGON HEAD TAPPING SCREW:3X 8

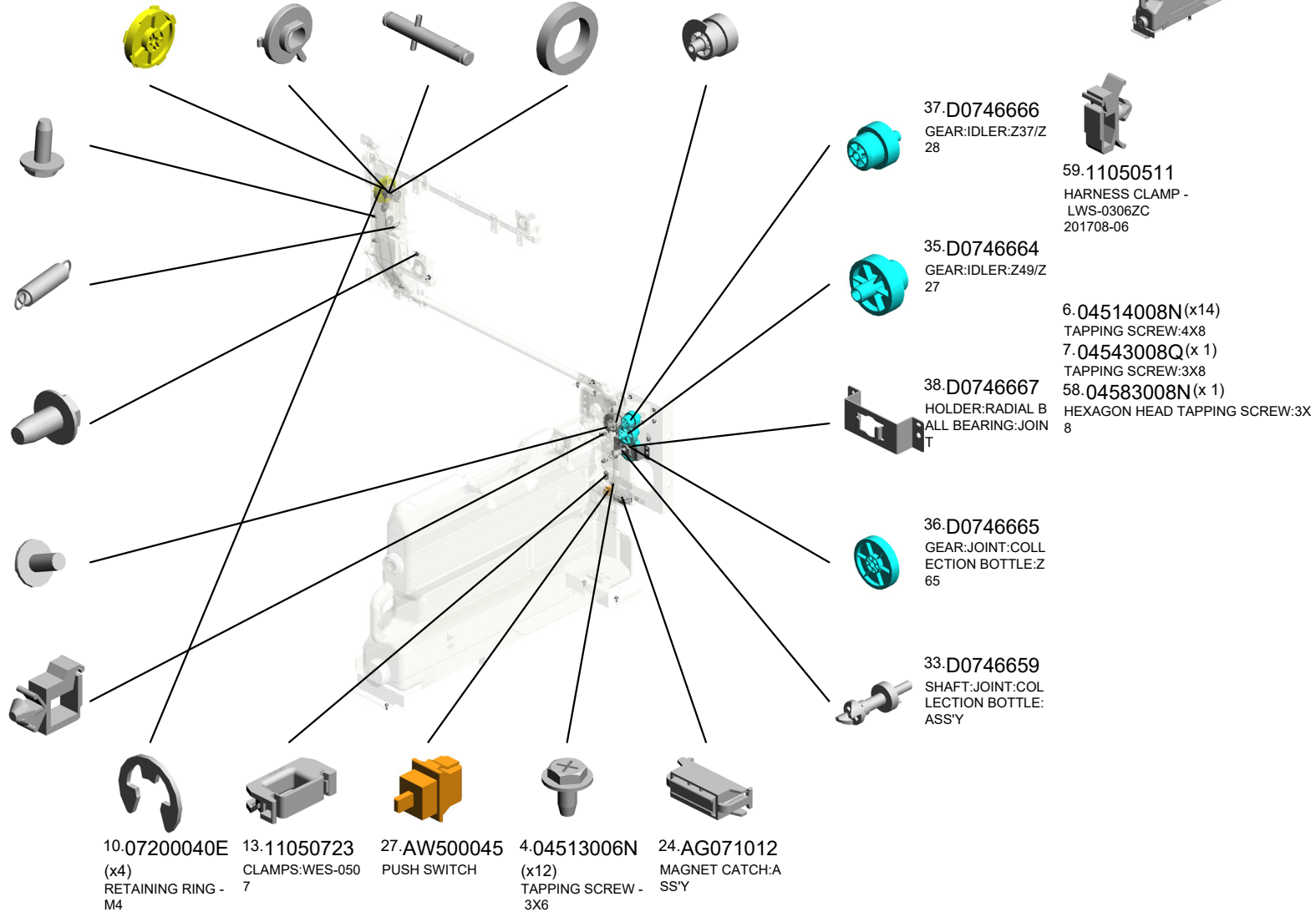

U013 USED TONER

64.GW020024 (x3) PHOTOINTERRUPTOR:LG2A24BL1:GF 201902-08 O/O
 55.D6831845 PULLEY:IDLER:DIA14
 57.GA082010 BUSHING:DIA6:DIA10:9
 51.D1796527 CAM:VERTICAL TRANSPORT:DIA15

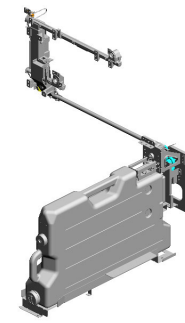

49.D1796523 BRACKET:VERTICAL TRANSPORT

50.D1796525 BRACKET:IDLER

65.07413506 BALL BEARING - 6 X12X4 MM 202105-03 X/O

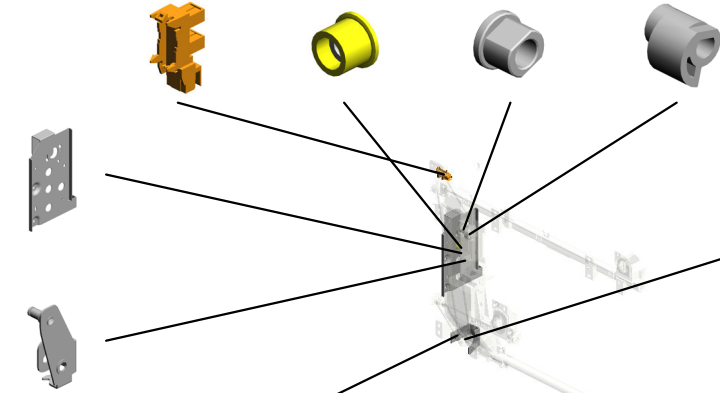

66.D0BX6521 BRACKET:TONER OUTLET SUB-UNIT:VERTICAL TRANSPORT:LOWER 202105-04 X/O

44.D1796472 COVER:TONER OUTLET SUB-UNIT:ASY

46.D1796487 DC MOTOR:BRUSHLESS:9.8W

45.D1796483 BRACKET:DRIVE SUB-UNIT:COLLECTION BOTTLE

62.D1055898 HOLDER:TEMPERATURE & HUMIDITY SENSOR 201804-03 X/O

63.AW140026 TEMPERATURE & HUMIDITY SENSOR 201902-02 O/O

U001	U002	U003	U004	U005	U006	U007	U008	U009	U010	U011	U012	U013	U014	U015	U016	U017	U018	U019	U020	U021
------	------	------	------	------	------	------	------	------	------	------	------	-------------	------	------	------	------	------	------	------	------

U013_S001
TONER OUTLET SUB-UNIT:PCU:ASS'Y

22.AB033118
TORQUE LIMITER
MECHANICAL CLU
TCH:TONER RECY
CLING SUB-UNIT



47.D1796501
TONER OUTLET S
UB-UNIT:PCU:ASS'
Y

11.08050089
RETAINING RING -
M4



42.D1791324
SYNCHRONOUS B
ELT:40S3M222

16.AA043342
SYNCHRONOUS B
ELT:40S3M666

U001	U002	U003	U004	U005	U006	U007	U008	U009	U010	U011	U012	U013	U014	U015	U016	U017	U018	U019	U020	U021
------	------	------	------	------	------	------	------	------	------	------	------	------	------	------	------	------	------	------	------	------

TONER OUTLET SUB-UNIT:VERTICAL TRANSPORT:MAIN:ASS'Y

14.A8063281 19.AA061177
 TIMING PULLEY - T TENSION SPRING:
 14 S3M VIBRATING PLATE:
 VERTICAL TRANSPORT



67.D0BX6528
 [A]
 TONER OUTLET S
 UB-UNIT:VERTICA
 L TRANSPORT:MAI
 N:ASS'Y
 202105-05 X/O

10.07200040E
 RETAINING RING -
 M4

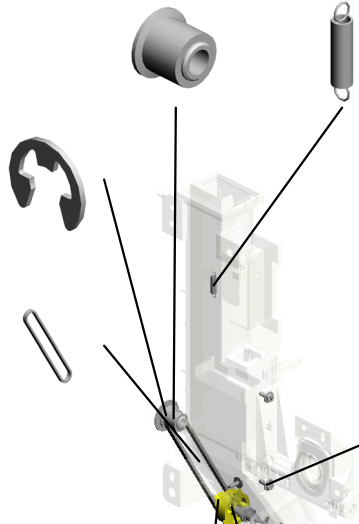

17.AA043659
 SYNCHRONOUS B
 ELT:40S3M231



3.04503010N
 (x7)
 TAPPING SCREW -
 M3X10

68.D0BX6552
 TRANSPORT SCR
 EW:TONER OUTLE
 T SUB-UNIT:LOWE
 R:ASS'Y
 202105-06 X/O



D1796528
 [A]
 TONER OUTLET S
 UB-UNIT:VERTICA
 L TRANSPORT:MAI
 N:ASS'Y
 202105-05 X/O

10.07200040E 23.AB033119
 RETAINING RING - TIMING PULLEY:Z2
 M4 5:Z14
 202105-02 X/O

U013_S003
 TONER OUTLET SUB-UNIT:COLLECTION BOTTLE:ASS'Y

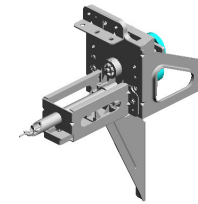

43.D1796461
 TONER OUTLET SUB-UNIT:COLLECTION BOTTLE:ASS'Y

4.04513006N (x4) TAPPING SCREW - 3X6
 8.06320140G PARALLEL PIN
 20.AB011540 GEAR:AGITATOR:DRIVE

18.AA061169
 TENSION SPRING:TONER CATCHPA
 N:DISCHARGE USED TONER

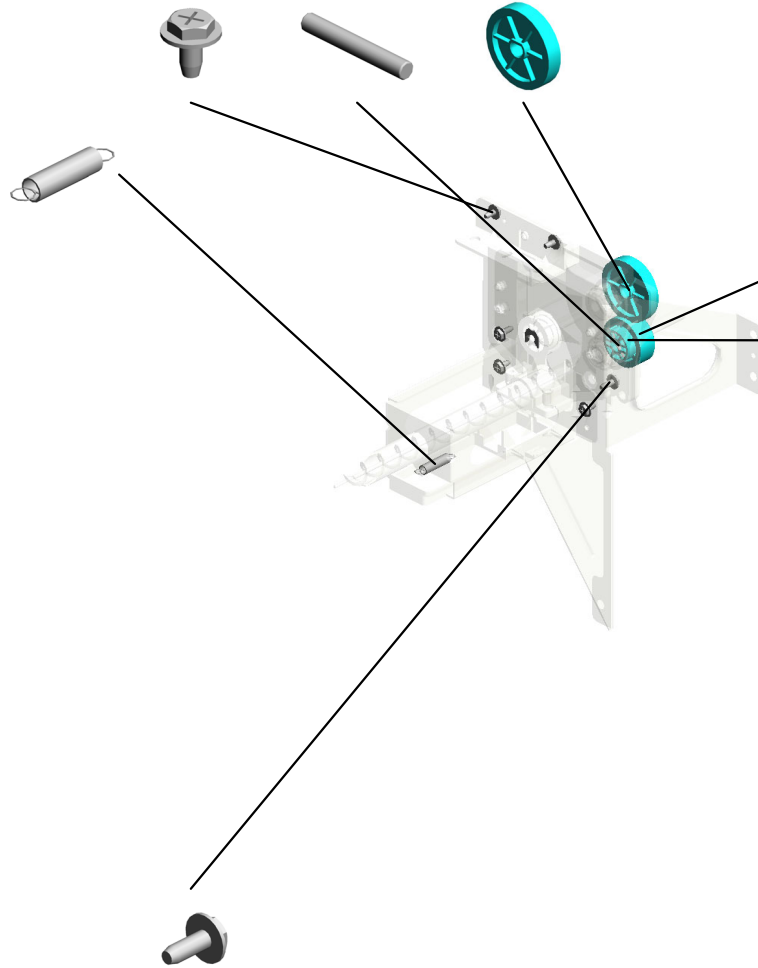

3.04503010N (x 7)
 TAPPING SCREW - M3X10

11.08050089
 (x3)
 RETAINING RING - M4

32.D0746643
 GEAR:TRANSPORT SCREW:COLLEC
 TION BOTTLE:SMALL:Z31

5.04513008N
 (x2)
 TAPPING SCREW - M3X8

U001	U002	U003	U004	U005	U006	U007	U008	U009	U010	U011	U012	U013	U014	U015	U016	U017	U018	U019	U020	U021
------	------	------	------	------	------	------	------	------	------	------	------	------	------	------	------	------	------	------	------	------

U013_S004
COLLECTION BOTTLE:SERVICE PARTS:ASS'Y

11.08050089 39.D0746697
RETAINING RING - M4 DECAL:COLLECTI
ON BOTTLE:GRIP:
FRONT

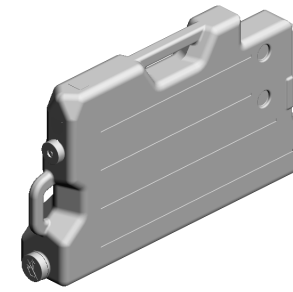

61.D2706570
[A]
COLLECTION BOT
TLE:SERVICE PAR
TS:ASSY
201802-02 O/O

41.D1363692
(x2)
DECAL:COLLECTI
ON BOTTLE:GRIP:
UPPER



3.04503010N
(x4)
TAPPING SCREW -
M3X10



15.AA036015
CAP:COLLECTION
BOTTLE

56.G1787819
SEAL:CAP:COLLEC
TION BOTTLE

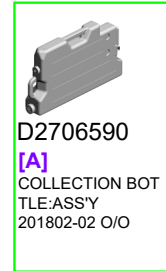

D2706590
[A]
COLLECTION BOT
TLE:ASSY
201802-02 O/O

U001	U002	U003	U004	U005	U006	U007	U008	U009	U010	U011	U012	U013	U014	U015	U016	U017	U018	U019	U020	U021
------	------	------	------	------	------	------	------	------	------	------	------	------	------	------	------	------	------	------	------	------

U014 SEPARATION/TRANSPORT

- 11.AF022064 (x2) TRANSPORT ROLLER:DRIVEN
- 8.11050511 (x10) HARNESS CLAMP - LWS-0306ZC
- 13.B1323861 PTB UNIT GUIDE PLATE
- 21.D0BX3862 SUPPORTING PLATE:VACUUM
- 3.04503006N (x2) TAPPING SCREW - M3X6

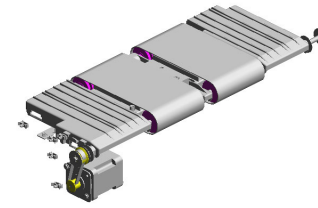

- 10.AA082173 (x2) PLAIN SHAFT BEARING:6X10X6

- 6.07200040E (x5) RETAINING RING - M4

- 7.07413706 (x2) BALL BEARING - 6X10X3

- 18.G1783870 TIMING PULLEY:T30

- 2.03603006N (x2) SCREW - M3X6

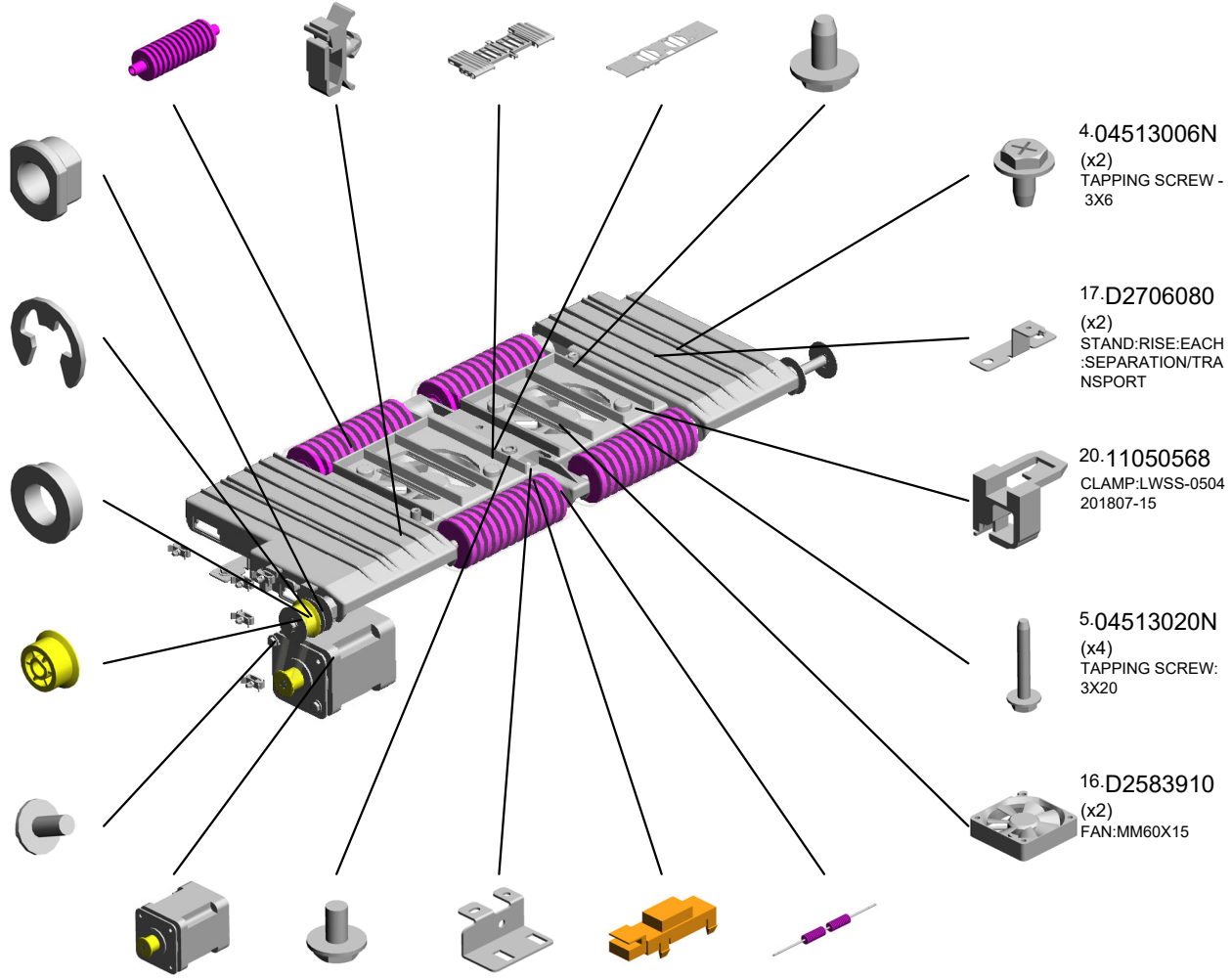

- 14.B1326655 STEPPER MOTOR: PAPER FEED UNIT:ASSY
- 1.03603005N (x3) SCREW - M3X5
- 22.D1793865 BRACKET:SENSOR:VACUUM
- 12.AW010147 PHOTO REFLECTION SENSOR
- 15.D1793851 TRANSPORT ROLLER:DRIVE

- 4.04513006N (x2) TAPPING SCREW - 3X6

- 17.D2706080 (x2) STAND:RISE:EACH:SEPARATION/TRANSPORT

- 20.11050568 CLAMP:LWSS-0504 201807-15

- 5.04513020N (x4) TAPPING SCREW: 3X20

- 16.D2583910 (x2) FAN:MM60X15

U014
SEPARATION/TRANSPORT

24.D0BX3833
(x2)
[A]
TRANSPORT BELT
202403-01 O/O

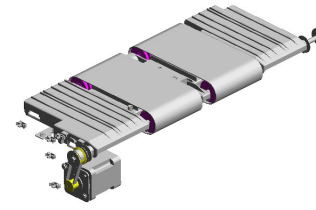
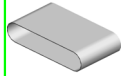

23.AA043726
SYNCHRONOUS B
ELT:60S2M134
202010-02 O/O

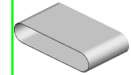

AA040033
[A]
TRANSPORT BELT
202403-01 O/O

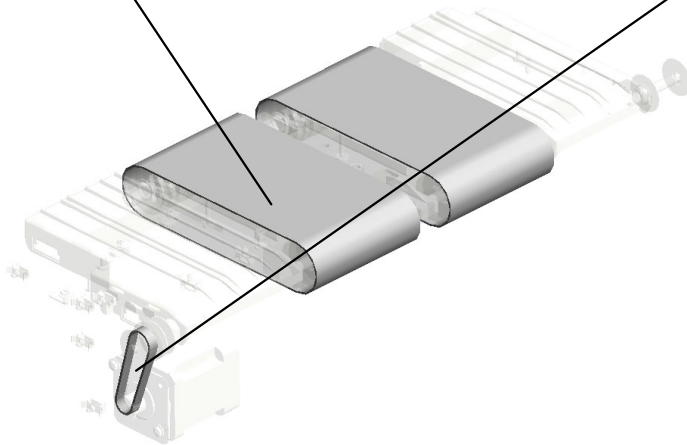

U015.FUSING

U015 S001
D2704417
(NA):FUSING UNIT:208V:ASS'
Y



U015 S003
D2704418
(CHN/EU,AA,TWN,KOR):FUSI
NG UNIT:220V:ASS'Y

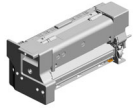

U015 S004
D2704418
(CHN/EU,AA,TWN,KOR):FUSI
NG UNIT:220V:ASS'Y

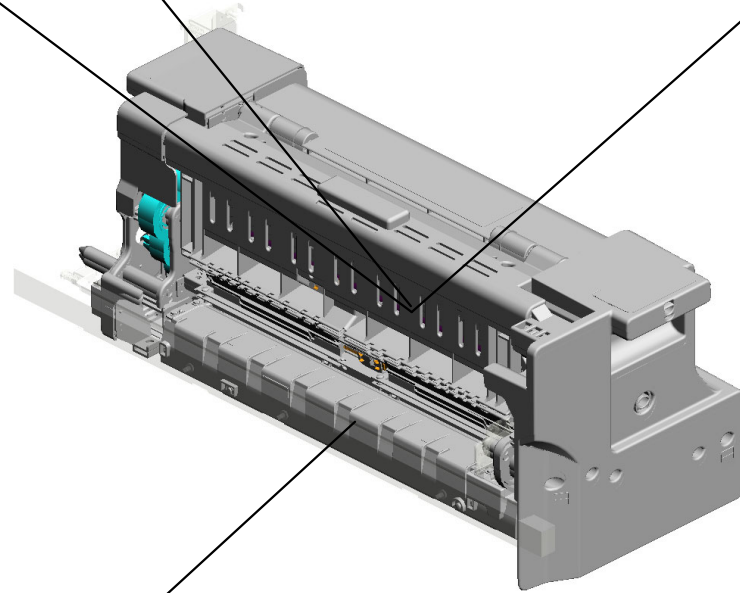

U015 S002
D2704311
WEB:CLEANING UNIT:ASS'Y

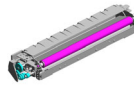

U001	U002	U003	U004	U005	U006	U007	U008	U009	U010	U011	U012	U013	U014	U015	U016	U017	U018	U019	U020	U021
------	------	------	------	------	------	------	------	------	------	------	------	------	------	------	------	------	------	------	------	------

U015_S001.(NA):FUSING UNIT:208V:ASS'Y

U015 S001 S002
D1794273
COVER:FUSING UNIT:FRONT:ASSY

U015 S001 S003
D1794285
COVER:FUSING UNIT:UPPER:ASSY

U015 S001 S004
BB013028
GEAR:IDLER:35Z:ASSY

U015 S001 S007
D2704290
DRIVE UNIT:WEB:CLEANING:ASSY

U015 S001 S005
AB014287
GEAR:IDLER:FUSING

U015 S001 S001
D1794271
COVER:FUSING UNIT:REAR:ASSY

U015 S001 S006
BB013038
GEAR:HOT ROLLER:ASSY

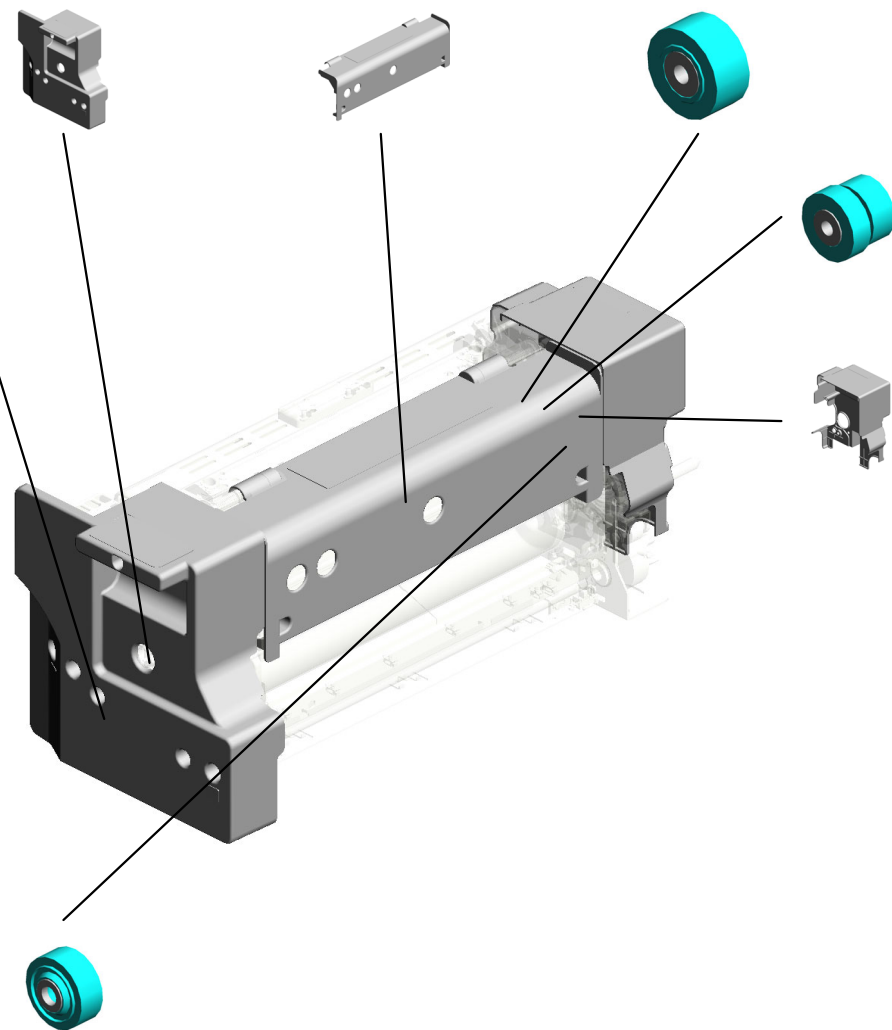

U001	U002	U003	U004	U005	U006	U007	U008	U009	U010	U011	U012	U013	U014	U015	U016	U017	U018	U019	U020	U021
------	------	------	------	------	------	------	------	------	------	------	------	------	------	------	------	------	------	------	------	------

U015_S002.WEB:CLEANING UNIT:ASS'Y

U015 S002 S001
D2704313
COVER:WEB:CLEANING FEL
T

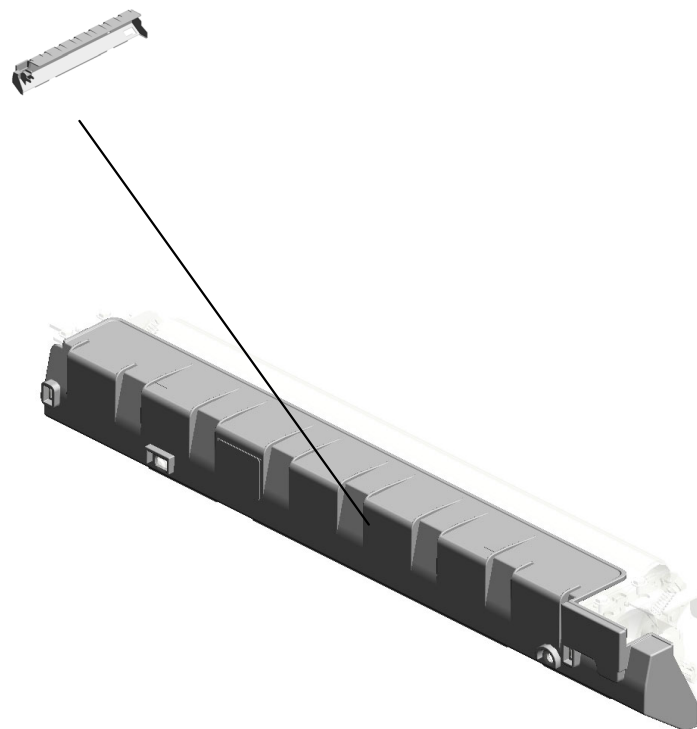

U001	U002	U003	U004	U005	U006	U007	U008	U009	U010	U011	U012	U013	U014	U015	U016	U017	U018	U019	U020	U021
------	------	------	------	------	------	------	------	------	------	------	------	------	------	------	------	------	------	------	------	------

U015_S003.(CHN/EU,AA,TWN,KOR):FUSING UNIT:220V:ASS'Y

U015 S003 S002
D1794273
COVER:FUSING UNIT:FRONT:ASSY

U015 S003 S003
D1794285
COVER:FUSING UNIT:UPPER:ASSY

U015 S003 S004
BB013028
GEAR:IDLER:35Z:ASSY

U015 S003 S007
D2704290
DRIVE UNIT:WEB:CLEANING:ASSY

U015 S003 S001
D1794271
COVER:FUSING UNIT:REAR:ASSY

U015 S003 S006
BB013038
GEAR:HOT ROLLER:ASSY

U015 S003 S005
AB014287
GEAR:IDLER:FUSING

U001	U002	U003	U004	U005	U006	U007	U008	U009	U010	U011	U012	U013	U014	U015	U016	U017	U018	U019	U020	U021
------	------	------	------	------	------	------	------	------	------	------	------	------	------	------	------	------	------	------	------	------

U015_S004.(CHN/EU,AA,TWN,KOR):FUSING UNIT:220V:ASS'Y

U015 S004 S002
D1794273
COVER:FUSING UNIT:FRONT:ASSY

U015 S004 S003
D1794285
COVER:FUSING UNIT:UPPER:ASSY

U015 S004 S004
BB013028
GEAR:IDLER:35Z:ASSY

U015 S004 S007
D2704290
DRIVE UNIT:WEB:CLEANING:ASSY

U015 S004 S001
D1794271
COVER:FUSING UNIT:REAR:ASSY

U015 S004 S006
BB013038
GEAR:HOT ROLLER:ASSY

U015 S004 S005
AB014287
GEAR:IDLER:FUSING

U001	U002	U003	U004	U005	U006	U007	U008	U009	U010	U011	U012	U013	U014	U015	U016	U017	U018	U019	U020	U021
------	------	------	------	------	------	------	------	------	------	------	------	------	------	------	------	------	------	------	------	------

U015 FUSING

35.AA063463 (x4) COMPRESSION SPRING: DRAWER
 142.D1794352 BRACKET: DRAWER: FUSING: UPPER: MAIN
 23.11050511 HARNESS CLAMP - LWS-0306ZC
 8.04514008N (x5) TAPPING SCREW: 4X8

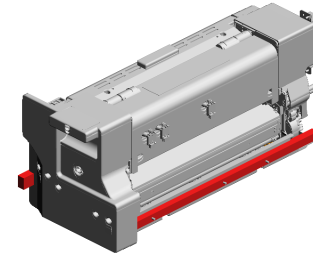

100.D0744351 (x4) STEPPED SCREW: DIA5.4DIA: DIA3.5: M3

143.D1794353 BRACKET: DRAWER: FUSING: LOWER: MAIN

22.11050487 HARNESS CLAMP

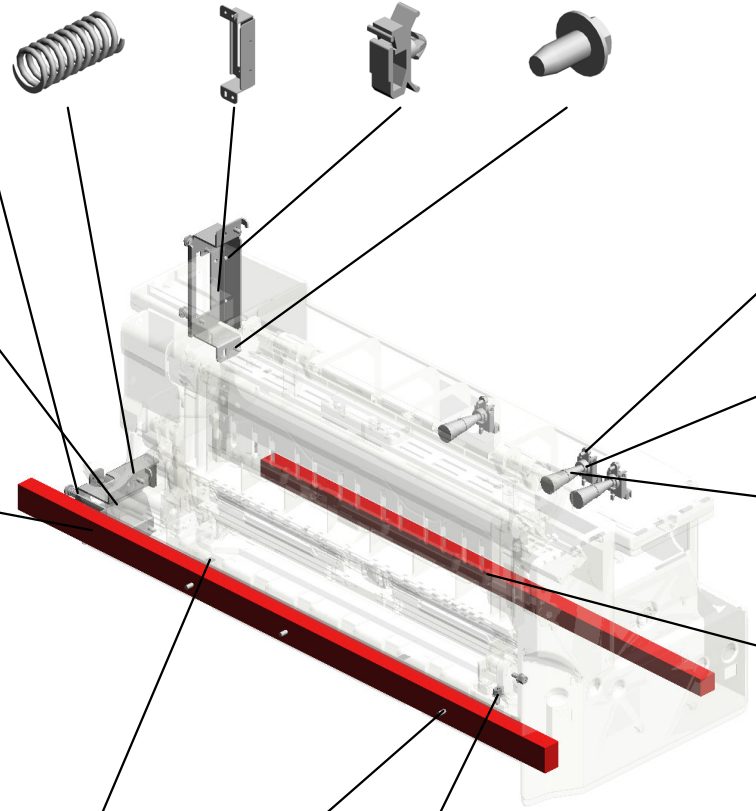

17.08046123 (x4) HEXAGONAL BOLT: W/WASHER: M3X8

23.11050511 (x2) HARNESS CLAMP - LWS-0306ZC

74.B2342390 FLANGED HEXAGONAL HEAD BOLT: M4X8

103.D1054365 (x3) HOLDER: THERMOPILE

2.03540060N (x4) SCREW-M4X6

165.AW100183 (x3) THERMOPILE 201804-01 O/O

39.AA070090 (x2) SLIDE RAIL: FUSING UNIT

102.D0746497 (x2) DECAL: POSITIONING DISPLAY: TCRU

3.03540080N (x6) SCREW: M4X8

74.B2342390 (x2) FLANGED HEXAGONAL HEAD BOLT: M4X8

U001	U002	U003	U004	U005	U006	U007	U008	U009	U010	U011	U012	U013	U014	U015	U016	U017	U018	U019	U020	U021
------	------	------	------	------	------	------	------	------	------	------	------	------	------	------	------	------	------	------	------	------

U015_S001
(NA):FUSING UNIT:208V:ASS'Y

- 10.07200030E RETAINING RING - M3
- 9.04543006Q (x11) TAPPING SCREW - M3X6
- 7.04503008N (x2) TAPPING SCREW - M3X8
- 25.11050551 (x2) CLAMP:LES-0505
- 6.03603010N (x2) SCREW:M3X10

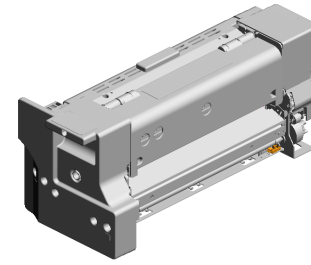

171-D2704417
[A]
(NA):FUSING UNIT:
208V:ASS'Y
201811-06 X/X

17.08046123
(x19)
HEXAGONAL BOLT
:W/WASHER:M3X8



11.07200040E
(x10)
RETAINING RING - M4



13.07250200E
(x2)
RETAINING RING C - M20



26.11050692
CLAMP:LES-0503



23.11050511
(x10)
HARNESS CLAMP - LWS-0306ZC

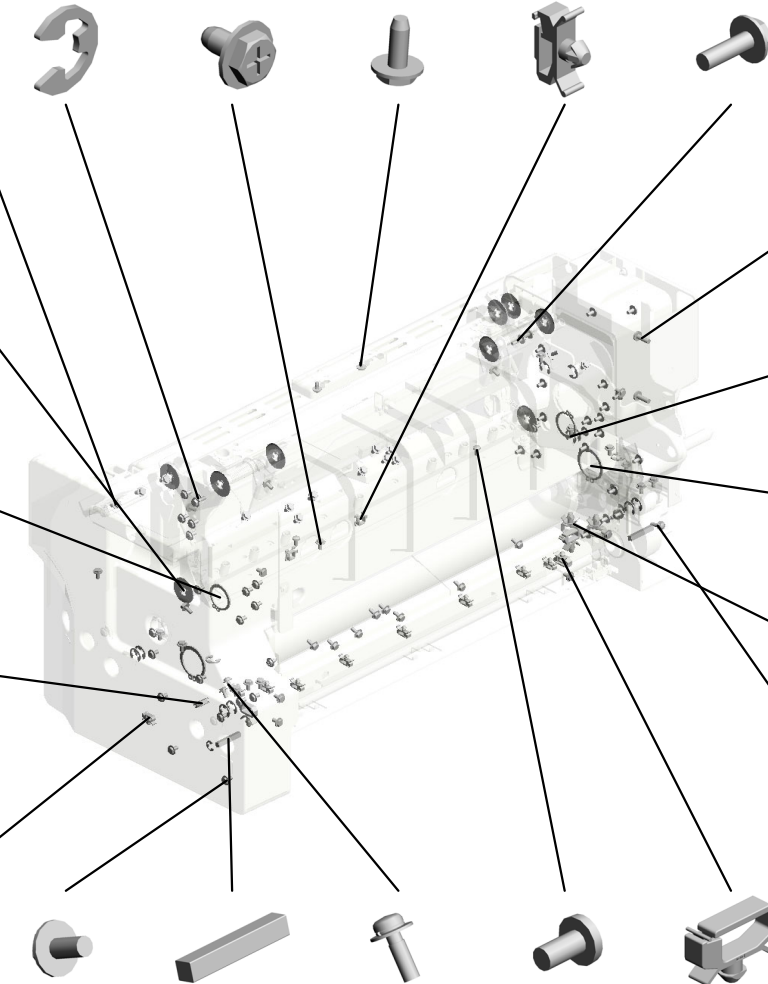

4.03540120N
(x2)
SCREW M4X12



17.08046123
(x12)
HEXAGONAL BOLT
:W/WASHER:M3X8



23.11050511
(x8)
HARNESS CLAMP - LWS-0306ZC



12.07200060E
(x13)
RETAINING RING - M6



15.07250250E
(x2)
RETAINING RING C - M25



24.11050516
(x2)
CLAMP



27.11050723
(x3)
CLAMPS:WES-0507

22.11050487
(x4)
HARNESS CLAMP



28.11050744
(x2)
CLAMP:F-LWS-0711



21.09543012N
SCREW - M3X12

5.03603006N
(x62)
SCREW - M3X6



18.09300404A
(x2)
PARALLEL KEY:4X25

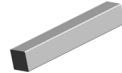

20.09543010N
(x2)
SCREW:POLISHED ROUND/SPRING:M3X10



1.03530060N
(x2)
BIND SCREW - M3 X6



24.11050516
CLAMP



1.03530060N(x 4)
BIND SCREW - M3X6
5.03603006N(x10)
SCREW - M3X6

U015_S001
(NA):FUSING UNIT:208V:ASS'Y

- 34.AA062352 (x2) TENSION SPRING: HEAT ROLLER
- 57.AE044075 (x5) STRIPPER PAWLS
- 59.AW010147 (x3) PHOTO REFLECTI ON SENSOR
- 28.11050744 CLAMP:F-LWS-071 1
- 40.AA082101 (x2) BUSHING - 6X10X6

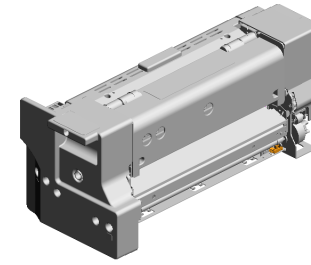

171-D2704417
[A]
(NA):FUSING UNIT:
208V:ASS'Y
201811-06 X/X

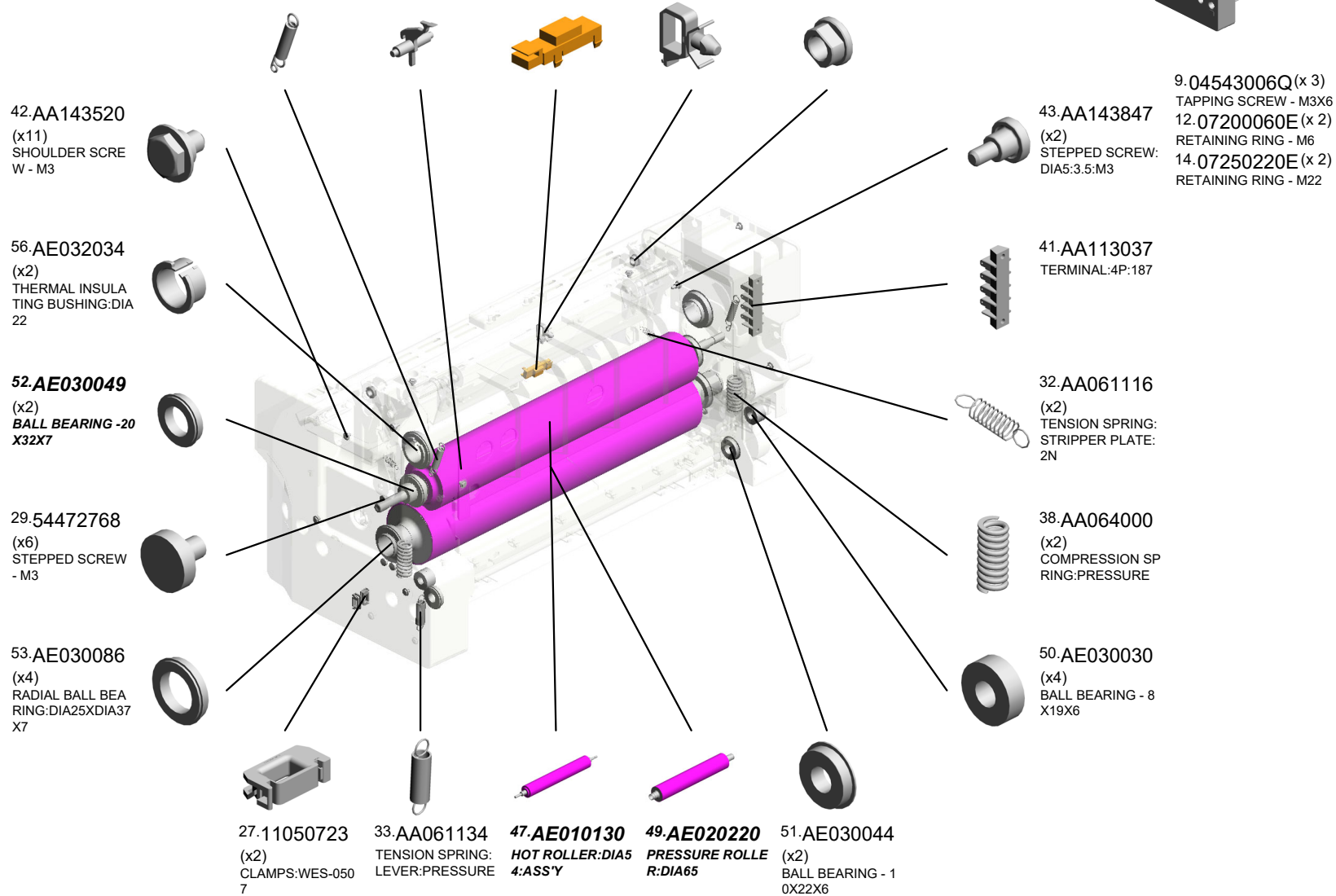

U015_S001
(NA):FUSING UNIT:208V:ASS'Y

- 67.AX450066 (NA):HEATER:HEAT ROLLER:205V:997WX3:INFRARED
- 70.B1324196 (x5) SPRING:PICK-OFF PAWL
- 73.B1324268 (x5) HOLDER:ROLLER: PICK-OFF PAWL
- 72.B1324265 (x5) ROLLER:PICK-OFF PAWL
- 71.B1324197 TORSION SPRING: LEVER

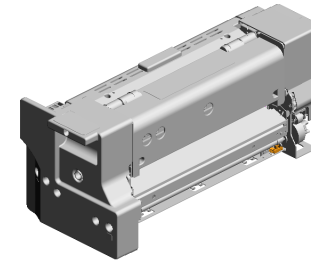

171.D2704417
[A]
(NA):FUSING UNIT:
208V:ASS'Y
201811-06 X/X

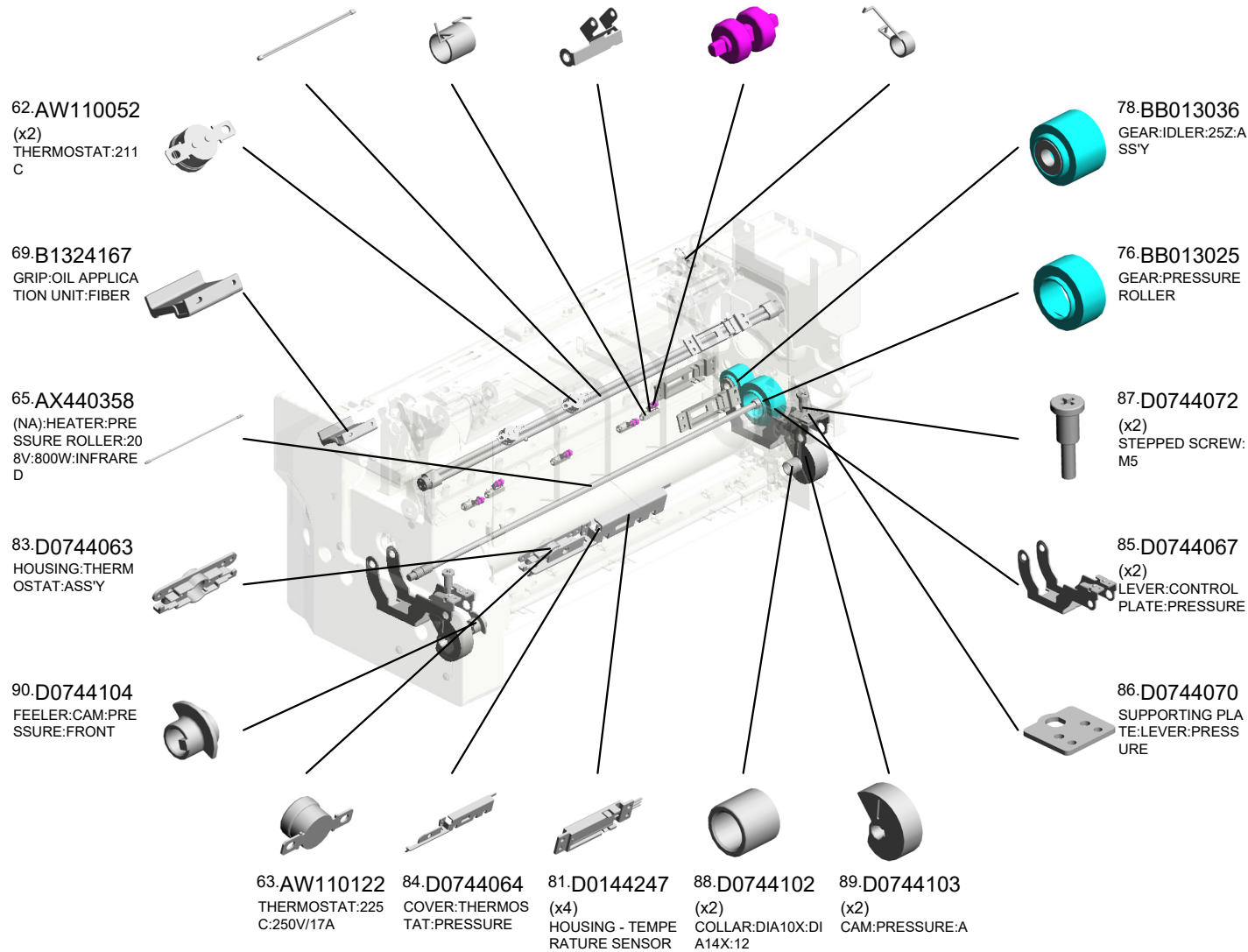

U015_S001
(NA):FUSING UNIT:208V:ASS'Y

- 93.D0744180 HOUSING:THERM
OSTAT:HEAT ROLL
ER:ASS'Y
- 94.D0744181 ELECTRODE PLAT
E:THERMOSTAT:H
EAT ROLLER:MIDD
LE
- 117.D1794114 GUIDE PLATE:FUSI
NG EXIT:LOWER
- 95.D0744182 ELECTRODE PLAT
E:THERMOSTAT:H
EAT ROLLER
- 115.D1794109 (x2)
ADJUSTING PIN:DI
SCHARGE BRUSH

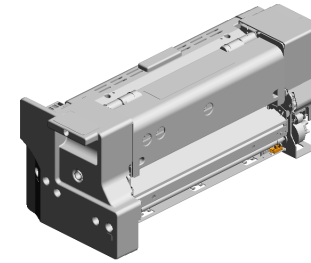

171.D2704417
[A]
(NA):FUSING UNIT:
208V:ASS'Y
201811-06 X/X

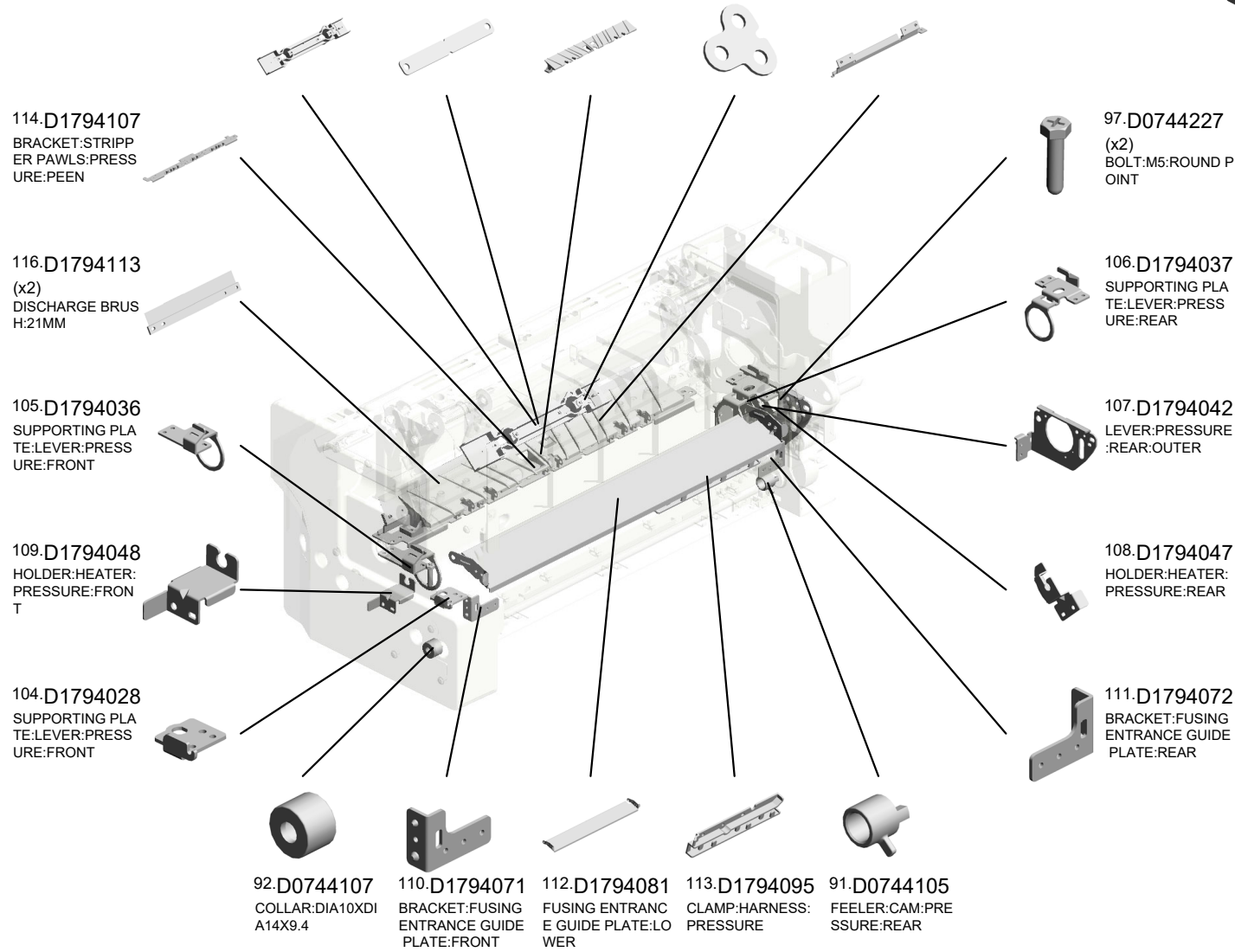

U015_S001
(NA):FUSING UNIT:208V:ASS'Y

- 130.D1794232 SHAFT:FUSING/PAPER EXIT UNIT
- 139.D1794279 COVER:FUSING/PAPER EXIT UNIT:ASS'Y
- 140.D1794283 GRIP:COVER:FUSING/PAPER EXIT UNIT:ASS'Y
- 128.D1794228 (x2) SUPPORTER:GUIDE PLATE:FUSING EXIT:UPPER
- 127.D1794224 LEVER:PAPER EXIT UNIT:REAR

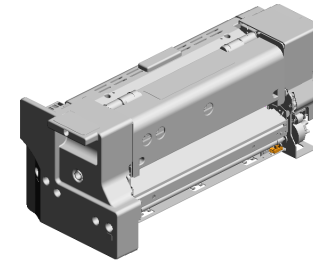

171.D2704417
[A]
(NA):FUSING UNIT:
208V:ASS'Y
201811-06 X/X

133.D1794255
GUIDE PLATE:FUSING EXIT:UPPER:ASS'Y

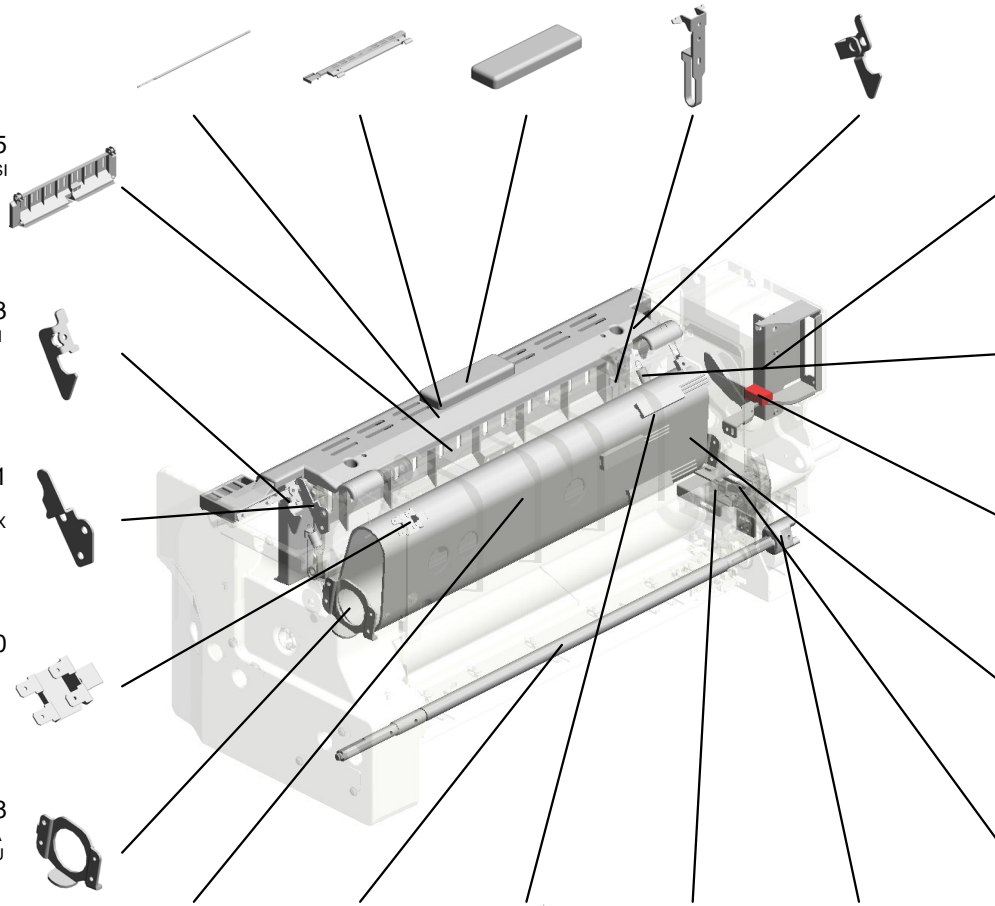

123.D1794213
BRACKET:DRAWER:UPPER

126.D1794223
LEVER:PAPER EXIT UNIT:FRONT

131.D1794235
(x2)
TENSION SPRING:FUSING/PAPER EXIT UNIT

129.D1794231
STOPPER:LEVER:FUSING/PAPER EXIT UNIT

121.D1794182
DISCHARGE BRUSH:HEAT ROLLER

120.D1794170
TAB:TERMINAL:187:4P

118.D1794147
SUPPORTING PLATE:SIDE PLATE:FUSING:REAR

119.D1794148
SUPPORTING PLATE:SIDE PLATE:FUSING:FRONT

125.D1794217
BRACKET:DRAWER:LOWER:AUXILIARY

- 122.D1794197 **FLAT BELT-FUSING**
DIA80:SEAL
- 145.D1944101 SHAFT:CAM:PRESSURE
- 144.D1795381 TEMPERATURE SENSOR:FUSING UNIT:UPPER:19PIN
- 124.D1794216 BRACKET:DRAWER:LOWER
- 146.D1944106 JOINT:CAM:PRESSURE

U001	U002	U003	U004	U005	U006	U007	U008	U009	U010	U011	U012	U013	U014	U015	U016	U017	U018	U019	U020	U021
------	------	------	------	------	------	------	------	------	------	------	------	------	------	------	------	------	------	------	------	------

U015_S001
(NA):FUSING UNIT:208V:ASS'Y

- 151.D2704181 HOLDER:HEATER:HEAT ROLLER:FRONT
- 153.D2704236 TORSION SPRING:FUSING/PAPER EXIT UNIT:FRONT
- 169.D2704239 STRIPPER PLATE:ASS'Y
201810-06 X/X
- 170.AE012048 HEAT ROLLER:DIA 39.2
201811-02 O/O
- 154.D2704237 TORSION SPRING:FUSING/PAPER EXIT UNIT:REAR

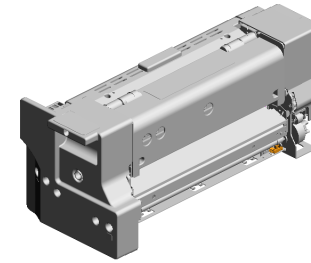

- 171.D2704417 [A] (NA):FUSING UNIT:208V:ASS'Y
201811-06 X/X

- 164.D0A53995 JOINT:KNOB:FUSING
201712-01 O/O

- 167.D1794055 SIDE PLATE:PRESSURE:FRONT:PEEN

- 173.GW020024 (x3) PHOTOINTERRUPTOR:LG2A24BL1:GF
201902-08 O/O

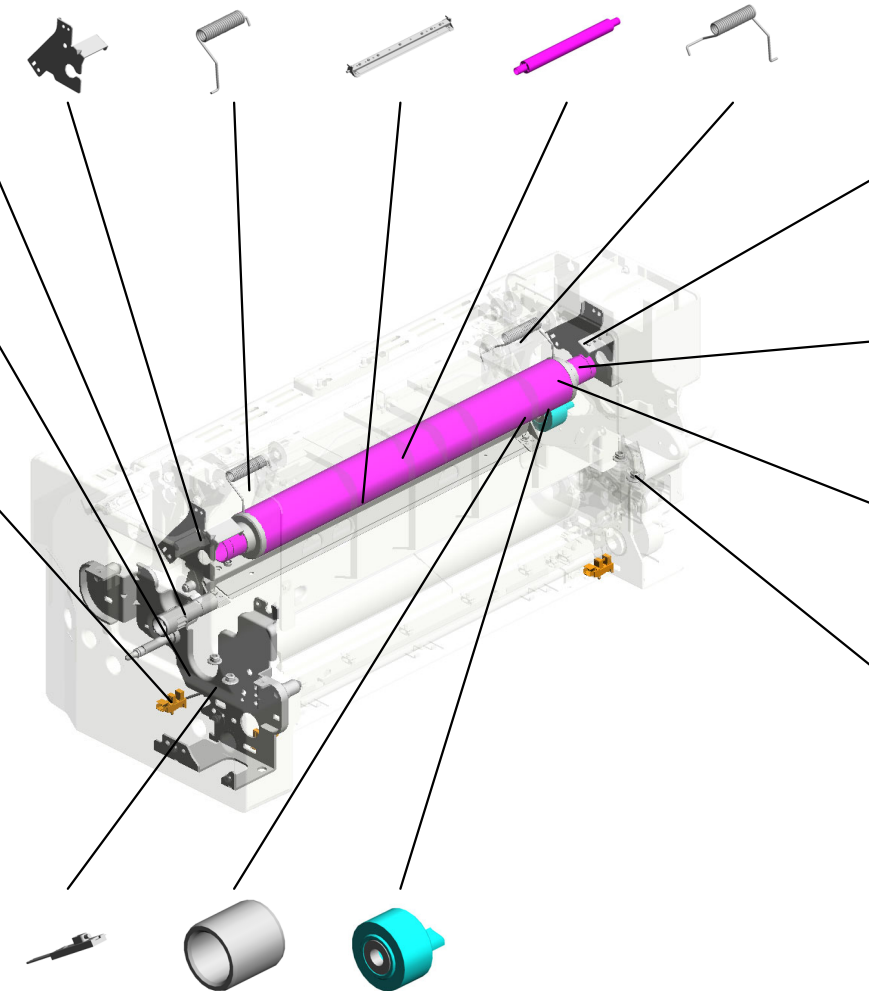

- 150.D2704180 HOLDER:HEATER:HEAT ROLLER:REAR

- 163.AA082115 PLAIN SHAFT BEARING RING:5X10X5

- 152.D2704185 (x2) RING:GUIDE:HEAT ROLLER:DIA39.2

- 147.D2704009 (x4) HOLDER:M5

- 160.D2705385 TEMPERATURE SENSOR:FUSING UNIT:LOWER:17PIN
- 168.07330610 (x2) BUSHING:DIA6X10
201810-05 X/X
- 162.D2709901 GEAR:FUSING UNIT:ASS'Y



- D2704017 [A] (NA):FUSING UNIT:208V:ASS'Y
201811-06 X/X

U015_S001_S001
COVER:FUSING UNIT:REAR:ASS'Y

138.D1794278
DECAL:FUSING UN
IT:TCRU

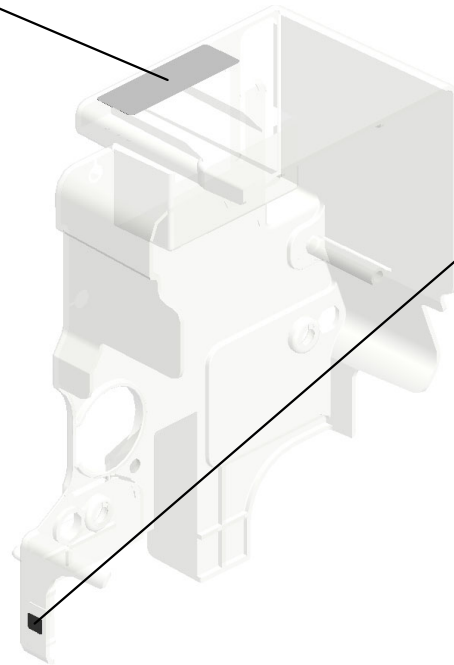
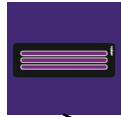

102.D0746497
DECAL:POSITIONI
NG DISPLAY:TCRU

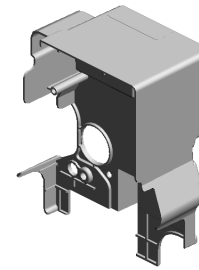

134.D1794271
COVER:FUSING U
NIT:REAR:ASS'Y

U001	U002	U003	U004	U005	U006	U007	U008	U009	U010	U011	U012	U013	U014	U015	U016	U017	U018	U019	U020	U021
------	------	------	------	------	------	------	------	------	------	------	------	------	------	------	------	------	------	------	------	------

U015_S001_S002
COVER:FUSING UNIT:FRONT:ASS'Y

99.D0744336
DECAL:WARNING (REMOVAL AND INSTALLATION);FUSING

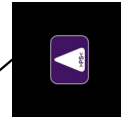
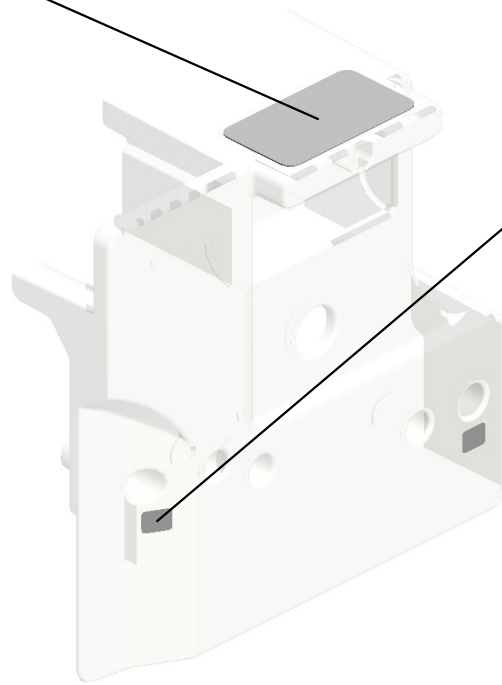

82.D0743829
(x2)
DECAL:POSITIONING DISPLAY:TCRU

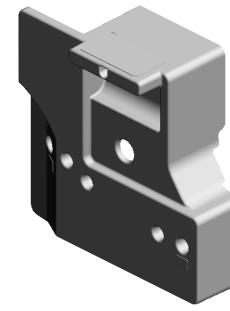

135.D1794273
COVER:FUSING UNIT:FRONT:ASSY

U001	U002	U003	U004	U005	U006	U007	U008	U009	U010	U011	U012	U013	U014	U015	U016	U017	U018	U019	U020	U021
------	------	------	------	------	------	------	------	------	------	------	------	------	------	------	------	------	------	------	------	------

U015_S001_S003
COVER:FUSING UNIT:UPPER:ASS'Y

166.D2704277
DECAL:H-TEMP W
ARNING:FUSING
201807-11 O/O

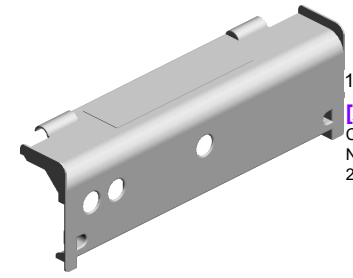
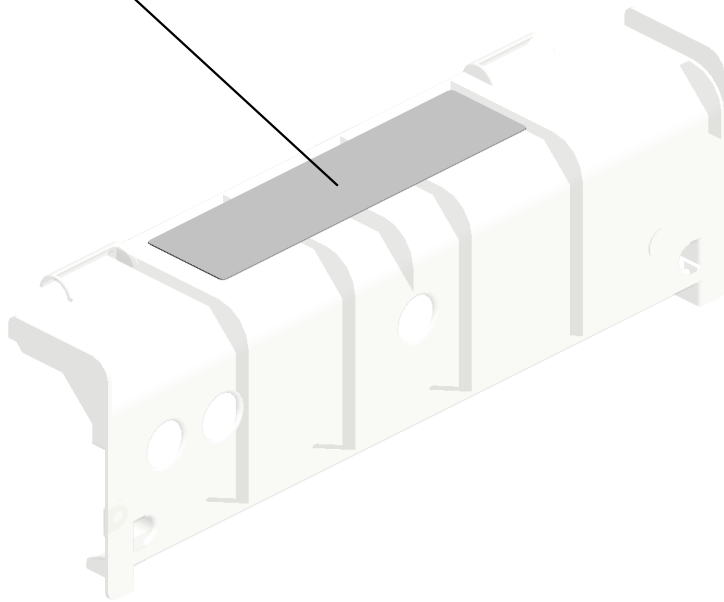

D1794285
[A]
COVER:FUSING U
NIT:UPPER:ASSY
201901-03 X/X



D1794275
[A]
COVER:FUSING U
NIT:UPPER:ASSY
201901-03 X/X

U001	U002	U003	U004	U005	U006	U007	U008	U009	U010	U011	U012	U013	U014	U015	U016	U017	U018	U019	U020	U021
------	------	------	------	------	------	------	------	------	------	------	------	------	------	------	------	------	------	------	------	------

U015_S001_S004
GEAR:IDLER:35Z:ASS'Y

50.AE030030
(x2)
BALL BEARING - 8
X19X6

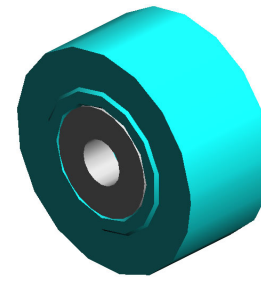
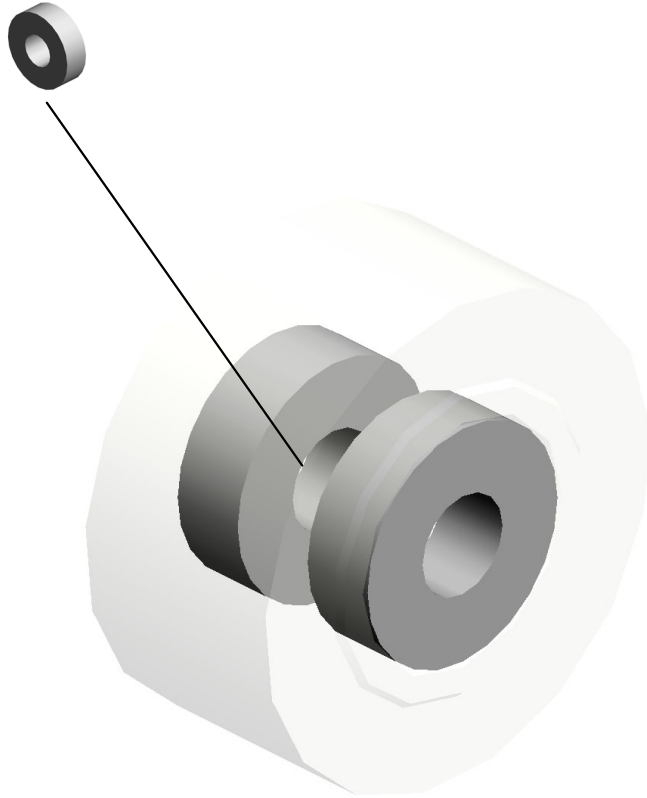

77.BB013028
GEAR:IDLER:35Z:A
SS'Y

U001	U002	U003	U004	U005	U006	U007	U008	U009	U010	U011	U012	U013	U014	U015	U016	U017	U018	U019	U020	U021
------	------	------	------	------	------	------	------	------	------	------	------	------	------	------	------	------	------	------	------	------

U015_S001_S005
GEAR:IDLER:FUSING

50.AE030030
(x2)
BALL BEARING - 8
X19X6

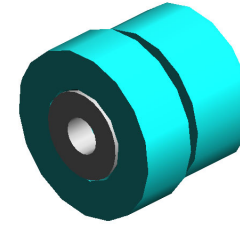
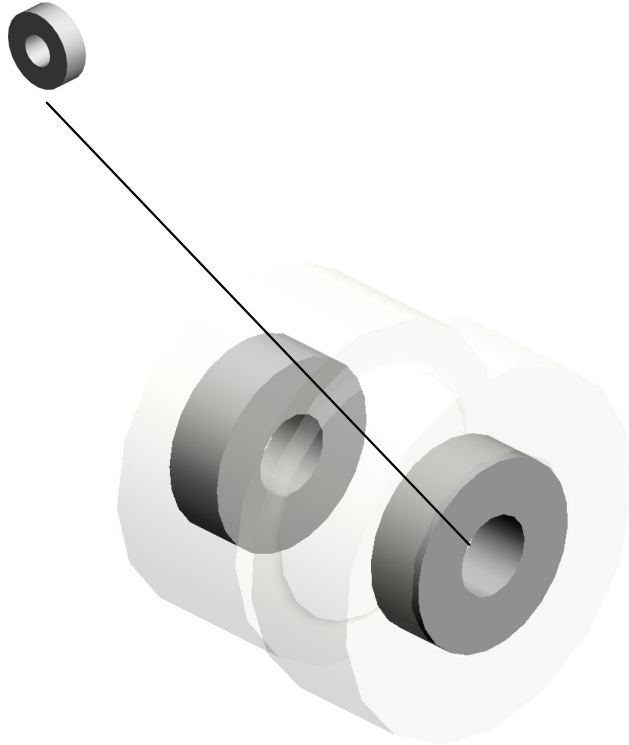

46.AB014287
GEAR:IDLER:FUSI
NG

U001	U002	U003	U004	U005	U006	U007	U008	U009	U010	U011	U012	U013	U014	U015	U016	U017	U018	U019	U020	U021
------	------	------	------	------	------	------	------	------	------	------	------	------	------	------	------	------	------	------	------	------

U015_S001_S006
GEAR:HOT ROLLER:ASS'Y

50.AE030030
BALL BEARING - 8
X19X6

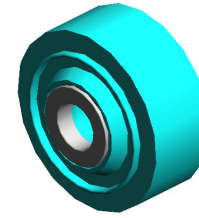

80.BB013038
GEAR:HOT ROLLE
R:ASS'Y

U001	U002	U003	U004	U005	U006	U007	U008	U009	U010	U011	U012	U013	U014	U015	U016	U017	U018	U019	U020	U021
------	------	------	------	------	------	------	------	------	------	------	------	------	------	------	------	------	------	------	------	------

U015_S001_S007
 DRIVE UNIT:WEB:CLEANING:ASS'Y

10.07200030E (x2) RETAINING RING - M3
 45.AB014229 (x4) COUPLEDGEAR - 17Z/32Z
 25.11050551 (x2) CLAMP:LES-0505

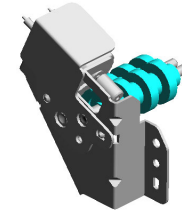

155.D2704290
 DRIVE UNIT:WEB:
 CLEANING:ASS'Y

55.AE031037
 (x4)
 BUSHING - M4

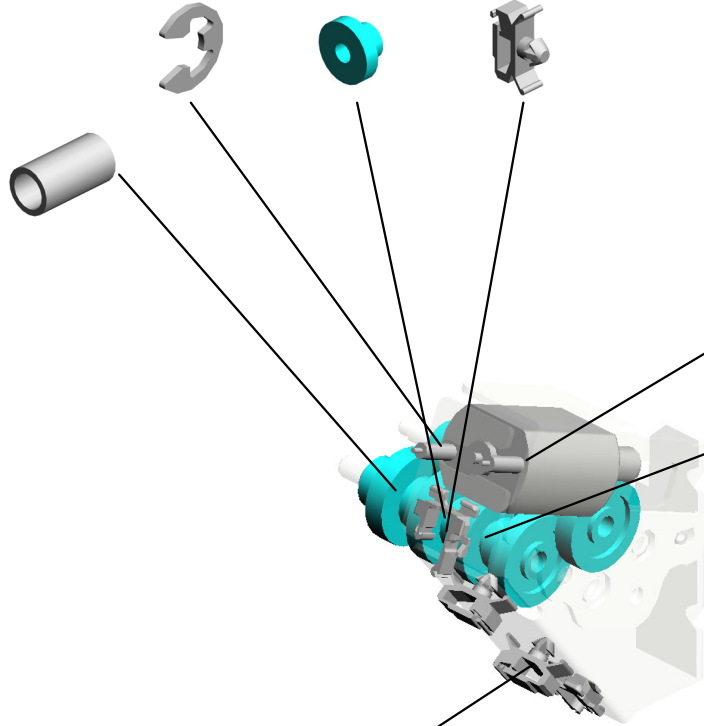

64.AX040300
 DC MOTOR:CLEAN
 ER:ASS'Y

23.11050511
 HARNESS CLAMP -
 LWS-0306ZC

31.A2944171
 (x4)
 COUPLED GEAR -
 17Z/32Z

23.11050511
 (x2)
 HARNESS CLAMP -
 LWS-0306ZC

U001	U002	U003	U004	U005	U006	U007	U008	U009	U010	U011	U012	U013	U014	U015	U016	U017	U018	U019	U020	U021
------	------	------	------	------	------	------	------	------	------	------	------	------	------	------	------	------	------	------	------	------

U015_S002
WEB:CLEANING UNIT:ASS'Y

36.AA063465 (x2) COMPRESSION SPRING:CLEANING FEELER:27N
 98.D0744302 PLAIN SHAFT BEARING RING:ROLLER:REAR
 58.AE045065 WEB:SUB-ASS'Y
 159.D2704343 ROLLER:PLATE

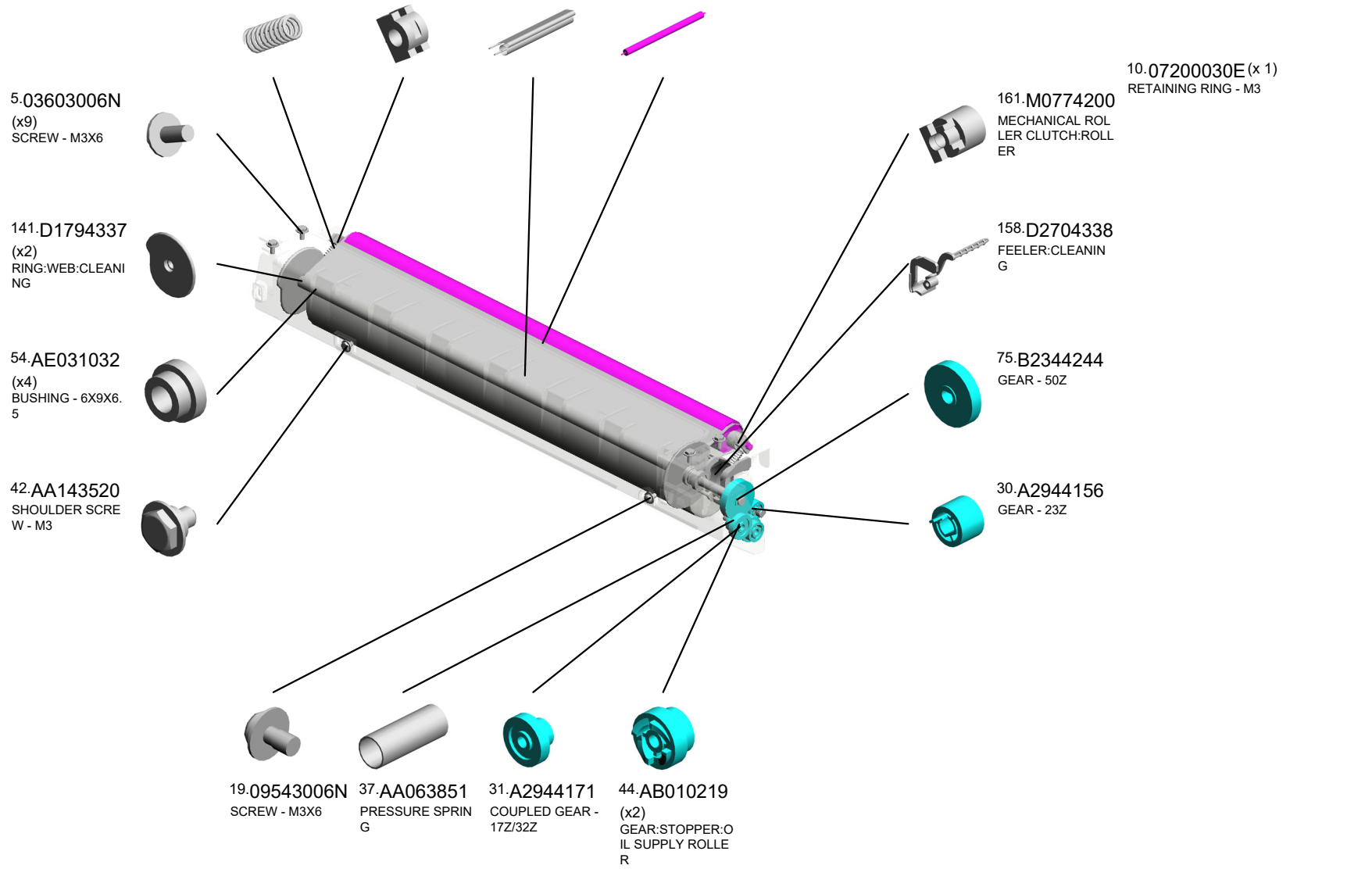
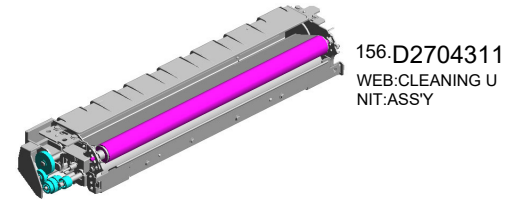

156.D2704311
WEB:CLEANING UNIT:ASS'Y

10.07200030E (x 1)
RETAINING RING - M3

5.03603006N
(x9)
SCREW - M3X6

141.D1794337
(x2)
RING:WEB:CLEANING

54.AE031032
(x4)
BUSHING - 6X9X6.5

42.AA143520
SHOULDER SCREW - M3

161.M0774200
MECHANICAL ROLLER CLUTCH:ROLLER

158.D2704338
FEELER:CLEANING

75.B2344244
GEAR - 50Z

30.A2944156
GEAR - 23Z

19.09543006N
SCREW - M3X6

37.AA063851
PRESSURE SPRING

31.A2944171
COUPLED GEAR - 17Z/32Z

44.AB010219
(x2)
GEAR:STOPPER:OIL SUPPLY ROLLER

U015_S002_S001
COVER:WEB:CLEANING FELT

101.D0744380
DECAL:H-TEMP W
ARNING:FUSING:
WEB

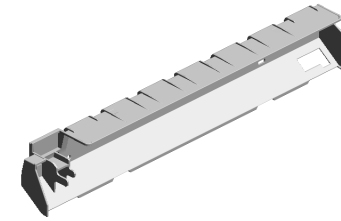

157.D2704313
COVER:WEB:CLEA
NING FELT

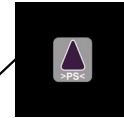
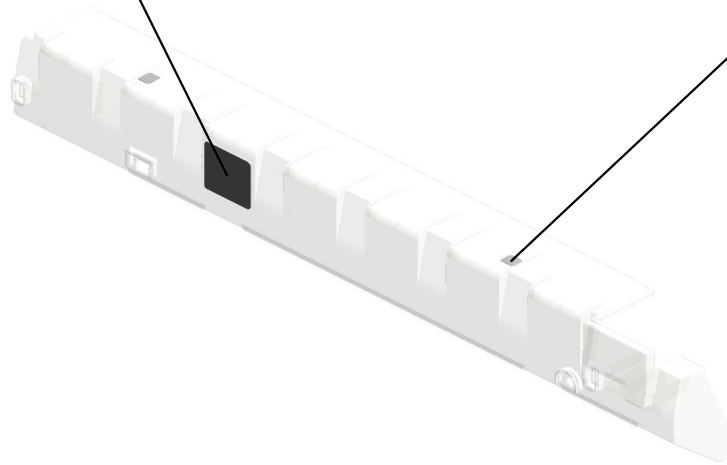

102.D0746497
(x2)
DECAL:POSITIONI
NG DISPLAY:TCRU

U001	U002	U003	U004	U005	U006	U007	U008	U009	U010	U011	U012	U013	U014	U015	U016	U017	U018	U019	U020	U021
------	------	------	------	------	------	------	------	------	------	------	------	------	------	------	------	------	------	------	------	------

U015_S003
(CHN/EU,AA,TWN,KOR):FUSING UNIT:220V:ASS'Y

- 10.07200030E RETAINING RING - M3
- 9.04543006Q (x11) TAPPING SCREW - M3X6
- 7.04503008N (x2) TAPPING SCREW - M3X8
- 25.11050551 (x2) CLAMP:LES-0505
- 6.03603010N (x2) SCREW:M3X10

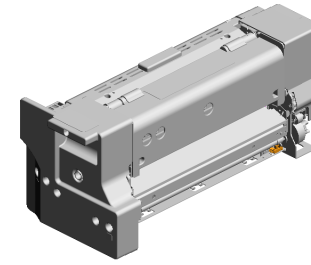

174-D2704418
[A]
(CHN/EU,AA,TWN,KOR):FUSING UNIT :220V:ASS'Y
202306-01 O/O

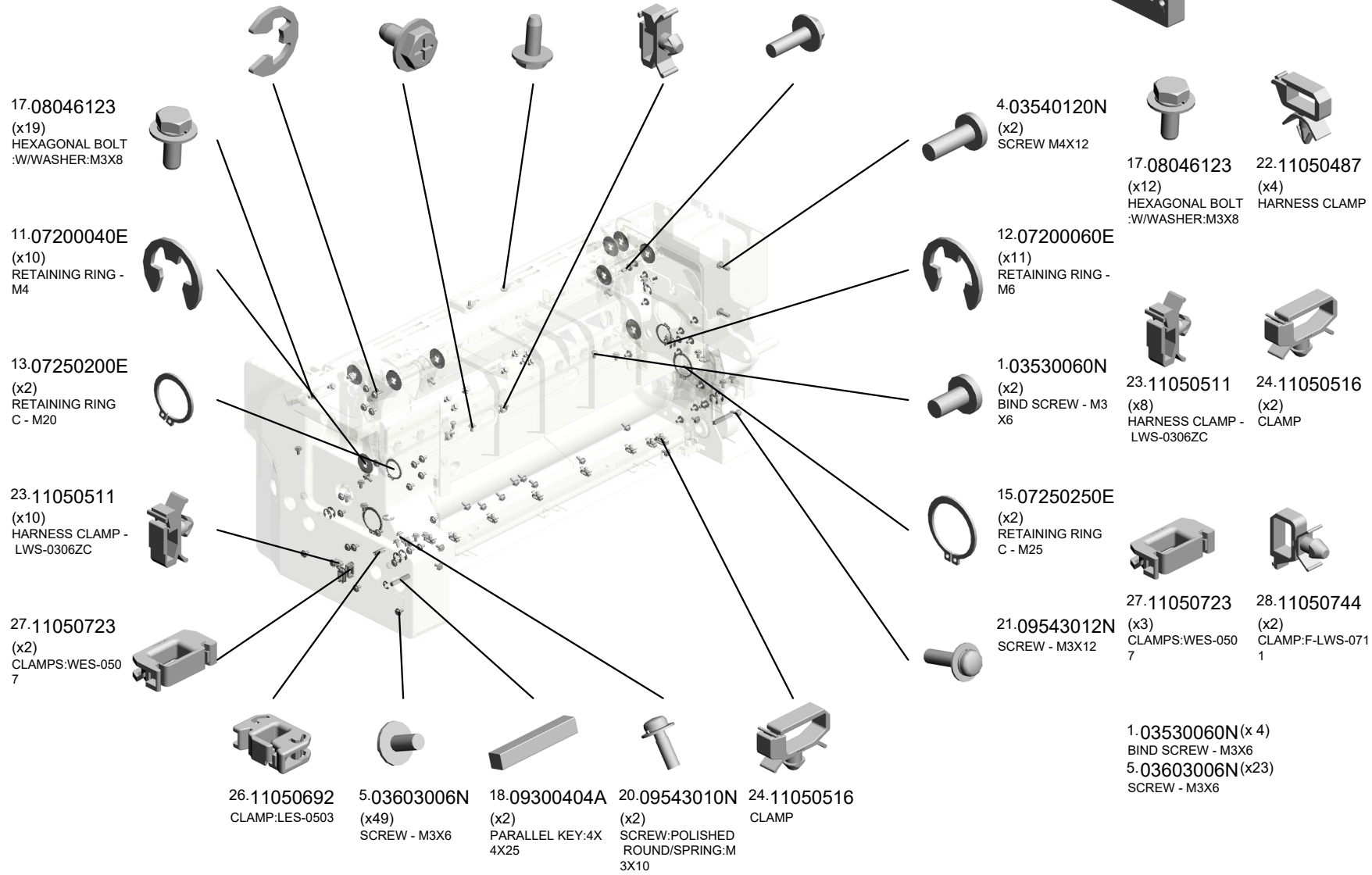

U015_S003
(CHN/EU,AA,TWN,KOR):FUSING UNIT:220V:ASS'Y

- 59.AW010147 (x3) PHOTO REFLECTI ON SENSOR
- 62.AW110052 (x2) THERMOSTAT:211 C
- 28.11050744 1 CLAMP:F-LWS-071
- 40.AA082101 (x2) BUSHING - 6X10X6
- 43.AA143847 (x2) STEPPED SCREW: DIA5:3.5:M3

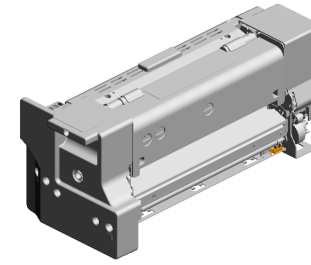

174-D2704418
[A]
(CHN/EU,AA,TWN,KOR):FUSING UNIT :220V:ASS'Y
202306-01 O/O

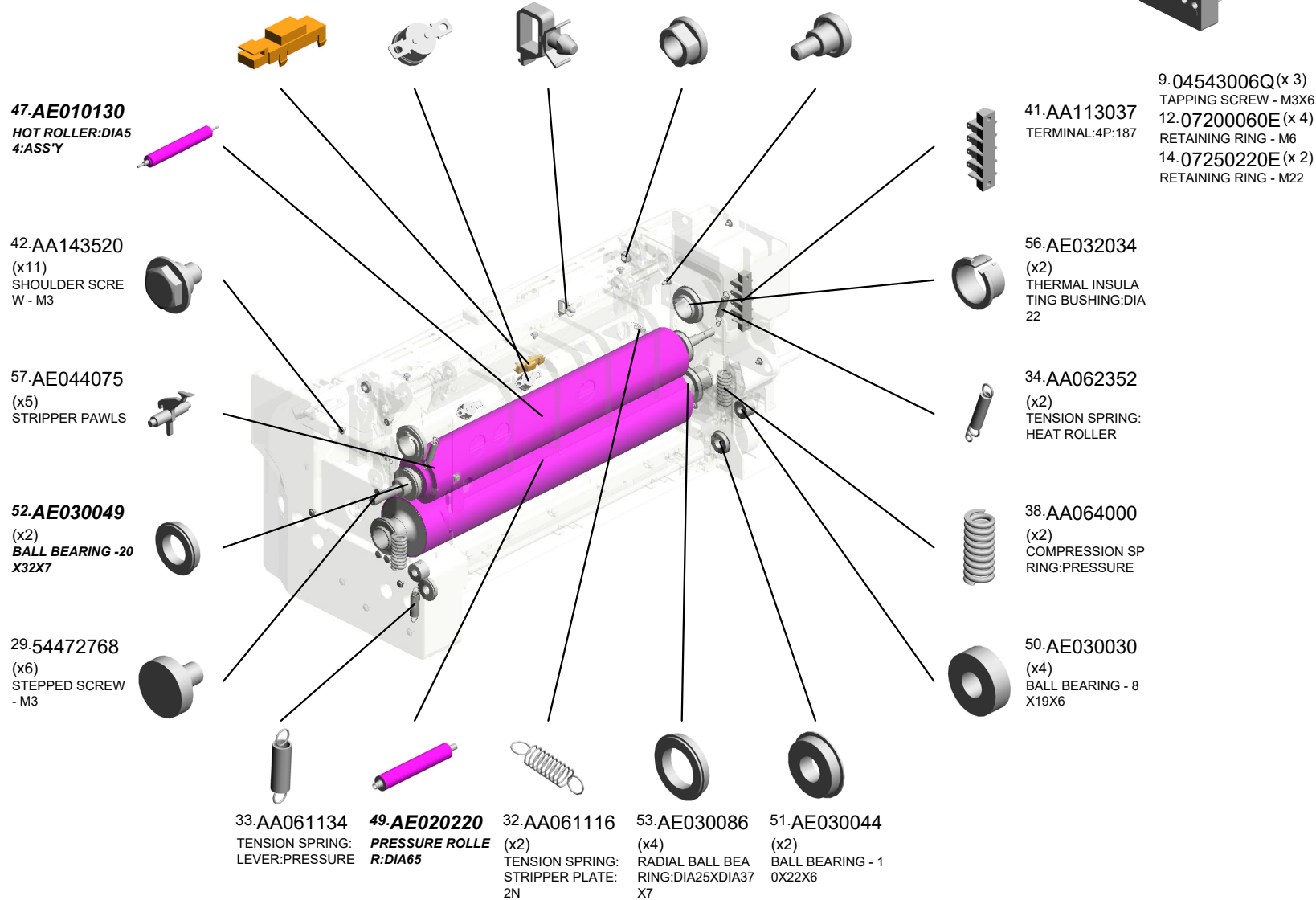

U015_S003
(CHN/EU,AA,TWN,KOR):FUSING UNIT:220V:ASS'Y

- 68.AX450067 (CHN/EU,AA,TWN,KOR):HEATER:HEAT ROLLER:227V:1070WX3:INFRARED
- 70.B1324196 (x5) SPRING:PICK-OFF PAWL
- 73.B1324268 (x5) HOLDER:ROLLER: PICK-OFF PAWL
- 72.B1324265 (x5) ROLLER:PICK-OFF PAWL
- 71.B1324197 TORSION SPRING: LEVER

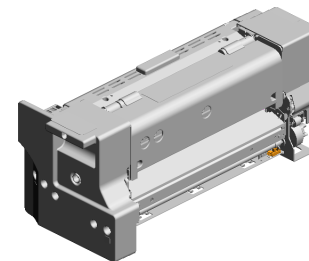

174-D2704418
[A]
(CHN/EU,AA,TWN,KOR):FUSING UNIT :220V:ASS'Y
202306-01 O/O

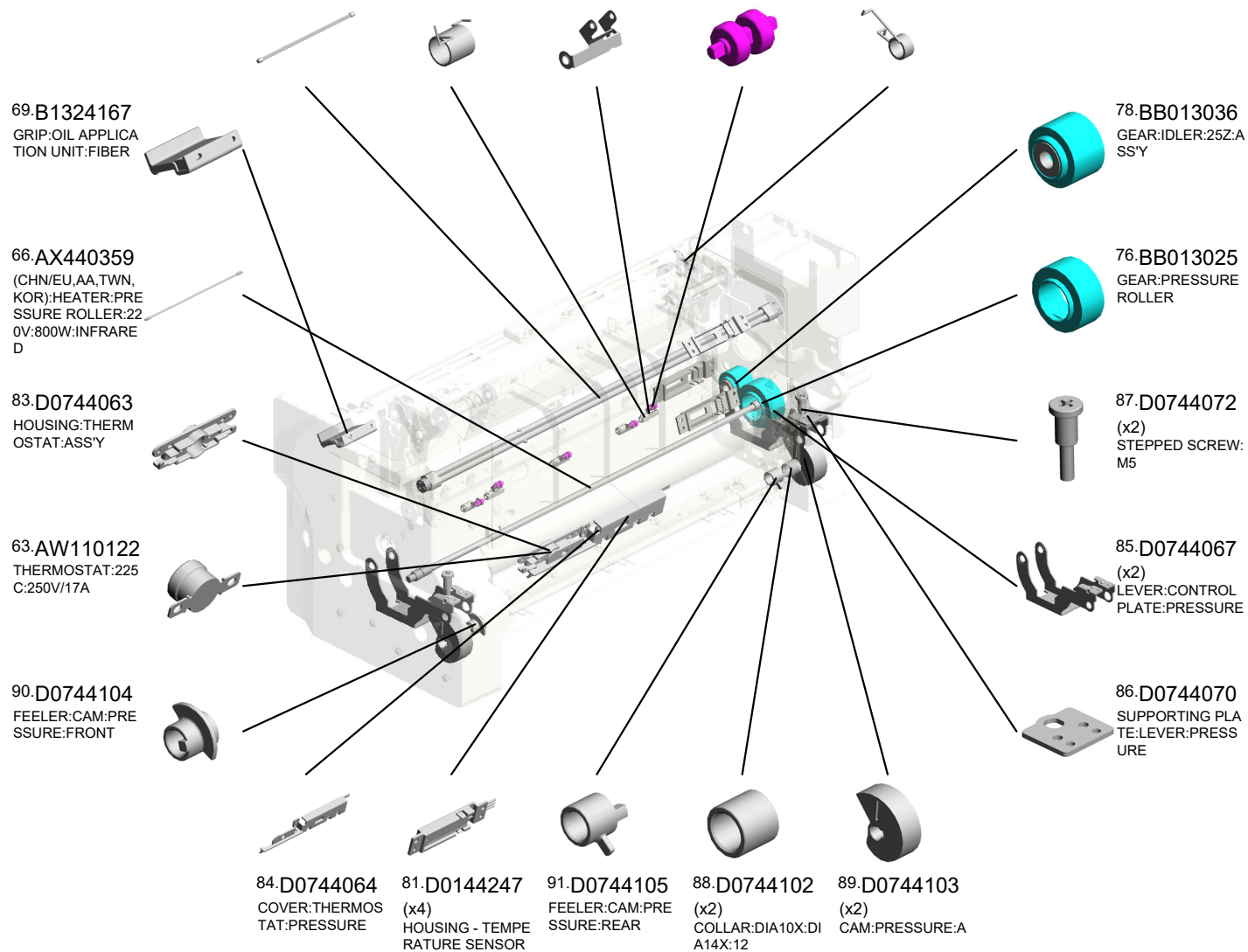

U001	U002	U003	U004	U005	U006	U007	U008	U009	U010	U011	U012	U013	U014	U015	U016	U017	U018	U019	U020	U021
------	------	------	------	------	------	------	------	------	------	------	------	------	------	------	------	------	------	------	------	------

U015_S003
(CHN/EU,AA,TWN,KOR):FUSING UNIT:220V:ASS'Y

- 93.D0744180 HOUSING:THERM
OSTAT:HEAT ROLL
ER:ASS'Y
- 94.D0744181 ELECTRODE PLAT
E:THERMOSTAT:H
EAT ROLLER:MIDD
LE
- 117.D1794114 GUIDE PLATE:FUSI
NG EXIT:LOWER
- 95.D0744182 ELECTRODE PLAT
E:THERMOSTAT:H
EAT ROLLER
- 115.D1794109 (x2)
ADJUSTING PIN:DI
SCHARGE BRUSH

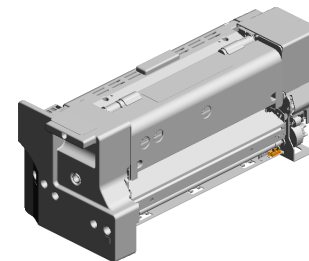

174.D2704418
[A]
(CHN/EU,AA,TWN,
KOR):FUSING UNIT
:220V:ASS'Y
202306-01 O/O

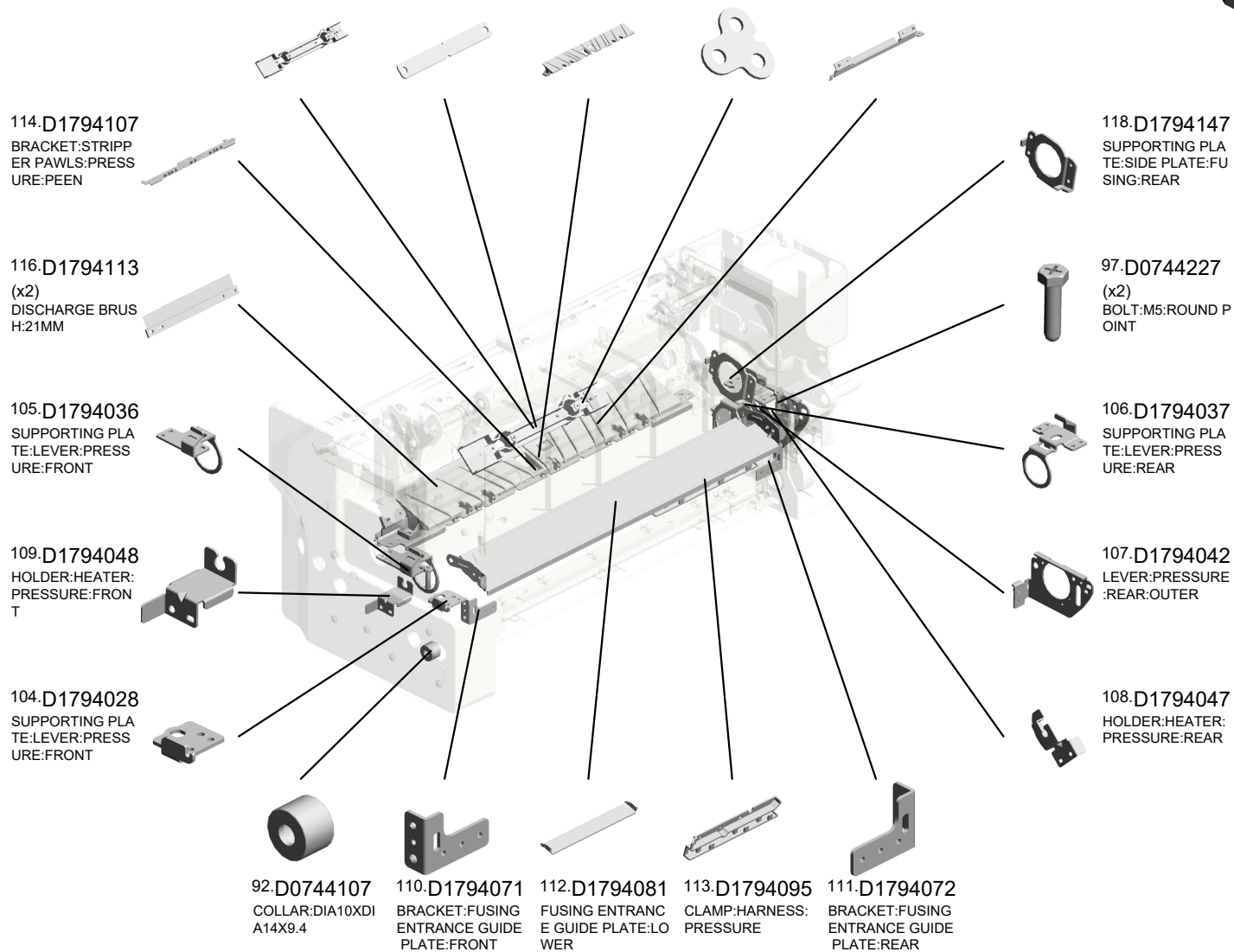

U015_S003
(CHN/EU,AA,TWN,KOR):FUSING UNIT:220V:ASS'Y

- 130.D1794232 SHAFT:FUSING/PAPER EXIT UNIT
- 139.D1794279 COVER:FUSING/PAPER EXIT UNIT:ASS'Y
- 140.D1794283 GRIP:COVER:FUSING/PAPER EXIT UNIT:ASS'Y
- 128.D1794228 (x2) SUPPORTER:GUIDE PLATE:FUSING EXIT:UPPER
- 127.D1794224 LEVER:PAPER EXIT UNIT:REAR

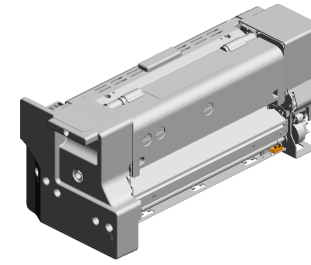

174.D2704418
[A]
(CHN/EU,AA,TWN,KOR):FUSING UNIT:220V:ASS'Y
202306-01 O/O

133.D1794255
GUIDE PLATE:FUSING EXIT:UPPER:ASS'Y



126.D1794223
LEVER:PAPER EXIT UNIT:FRONT



129.D1794231
STOPPER:LEVER:FUSING/PAPER EXIT UNIT



120.D1794170
TAB:TERMINAL:187:4P



119.D1794148
SUPPORTING PLATE:SIDE PLATE:FUSING:FRONT



122.D1794197
FLAT BELT-FUSING
G:DIA80:SEAL

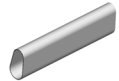

145.D1944101
SHAFT:CAM:PRESSURE



144.D1795381
TEMPERATURE SENSOR:FUSING UNIT:UPPER:19PIN



124.D1794216
BRACKET:DRAWER:LOWER

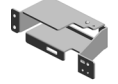

146.D1944106
JOINT:CAM:PRESSURE



123.D1794213
BRACKET:DRAWER:UPPER



131.D1794235
(x2)
TENSION SPRING:FUSING/PAPER EXIT UNIT



121.D1794182
DISCHARGE BRUSH:HEAT ROLLER

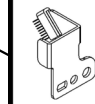

125.D1794217
BRACKET:DRAWER:LOWER:AUXILIARY



147.D2704009
(x4)
HOLDER:M5



U001	U002	U003	U004	U005	U006	U007	U008	U009	U010	U011	U012	U013	U014	U015	U016	U017	U018	U019	U020	U021
------	------	------	------	------	------	------	------	------	------	------	------	------	------	------	------	------	------	------	------	------

U015_S003
(CHN/EU,AA,TWN,KOR):FUSING UNIT:220V:ASS'Y

- | | | | |
|---|---|--|--|
| 153.D2704236 | 169.D2704239 | 170.AE012048 | 154.D2704237 |
| TORSION SPRING:
FUSING/PAPER EX
IT UNIT:FRONT | STRIPPER PLATE:
ASS'Y
201810-06 X/X | HEAT ROLLER:DIA
39.2
201811-02 O/O | TORSION SPRING:
FUSING/PAPER EX
IT UNIT:REAR |

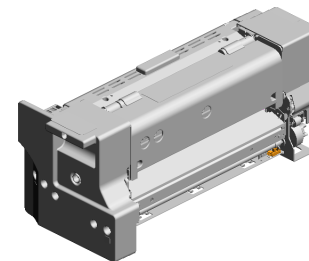

174.D2704418
[A]
(CHN/EU,AA,TWN,
KOR):FUSING UNIT
:220V:ASS'Y
202306-01 O/O

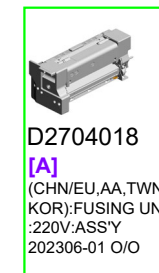
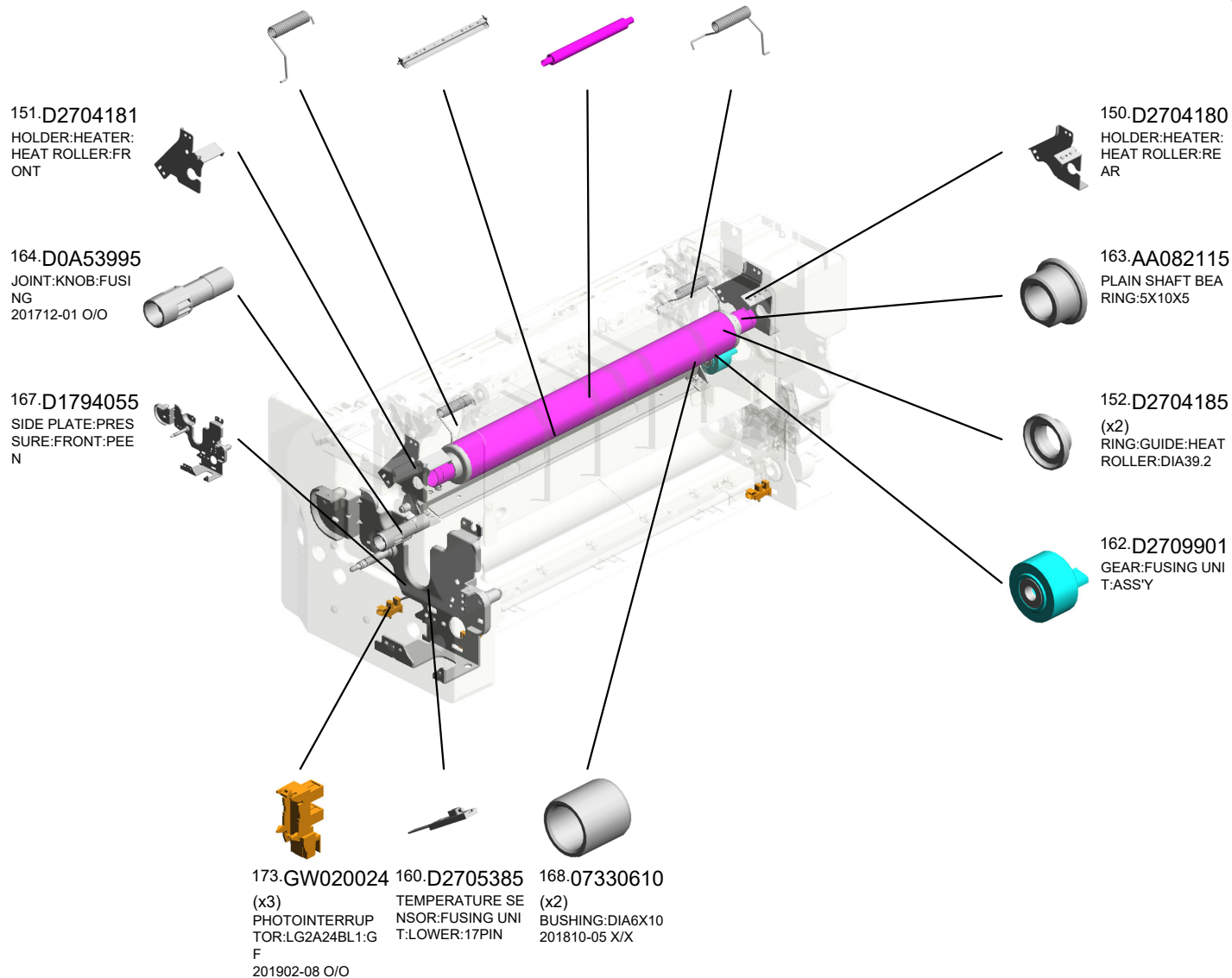

U015_S003_S001
COVER:FUSING UNIT:REAR:ASS'Y

138.D1794278
DECAL:FUSING UN
IT:TCRU

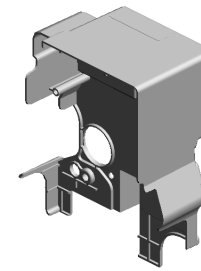
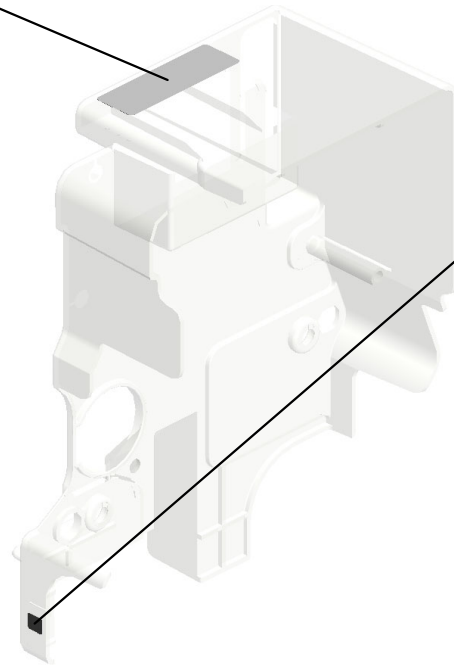

134.D1794271
COVER:FUSING U
NIT:REAR:ASS'Y



102.D0746497
DECAL:POSITIONI
NG DISPLAY:TCRU

U001	U002	U003	U004	U005	U006	U007	U008	U009	U010	U011	U012	U013	U014	U015	U016	U017	U018	U019	U020	U021
------	------	------	------	------	------	------	------	------	------	------	------	------	------	------	------	------	------	------	------	------

U015_S003_S002
COVER:FUSING UNIT:FRONT:ASS'Y

99.D0744336
DECAL:WARNING (REMOVAL AND INSTALLATION);FUSING

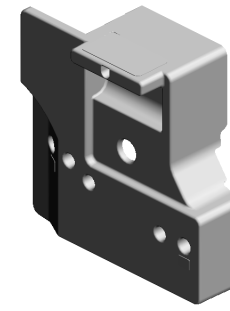
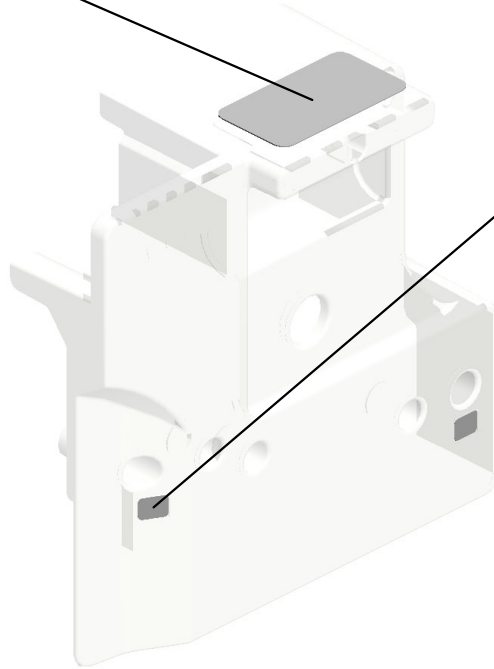

135.D1794273
COVER:FUSING UNIT:FRONT:ASSY

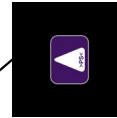

82.D0743829
(x2)
DECAL:POSITIONING DISPLAY:TCRU

U001	U002	U003	U004	U005	U006	U007	U008	U009	U010	U011	U012	U013	U014	U015	U016	U017	U018	U019	U020	U021
------	------	------	------	------	------	------	------	------	------	------	------	------	------	------	------	------	------	------	------	------

U015_S003_S003
COVER:FUSING UNIT:UPPER:ASS'Y

166.D2704277
DECAL:H-TEMP W
ARNING:FUSING
201807-11 O/O

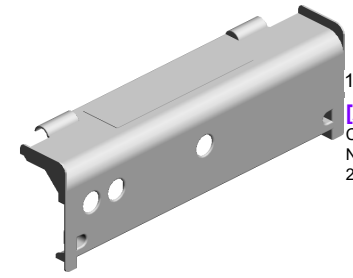
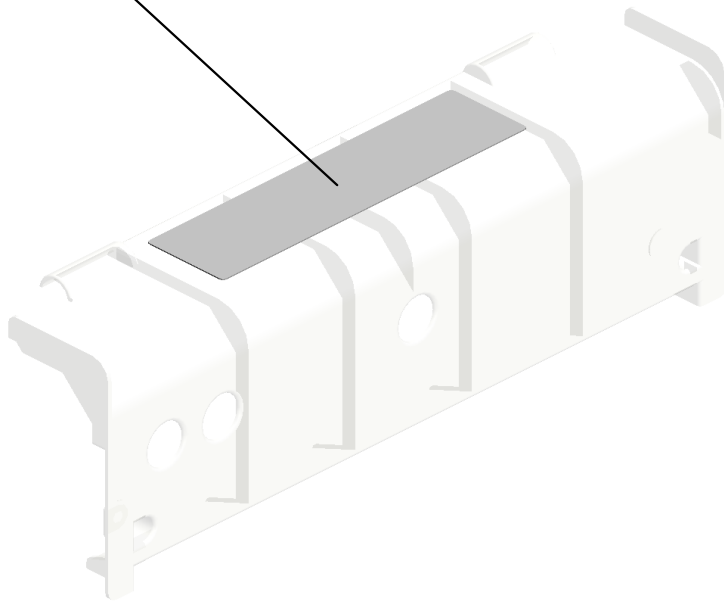

D1794285
[A]
COVER:FUSING U
NIT:UPPER:ASSY
201901-03 X/X



D1794275
[A]
COVER:FUSING U
NIT:UPPER:ASS'Y
201901-03 X/X

U001	U002	U003	U004	U005	U006	U007	U008	U009	U010	U011	U012	U013	U014	U015	U016	U017	U018	U019	U020	U021
------	------	------	------	------	------	------	------	------	------	------	------	------	------	------	------	------	------	------	------	------

U015_S003_S004
GEAR:IDLER:35Z:ASS'Y

50.AE030030
(x2)
BALL BEARING - 8
X19X6

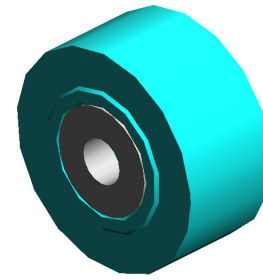
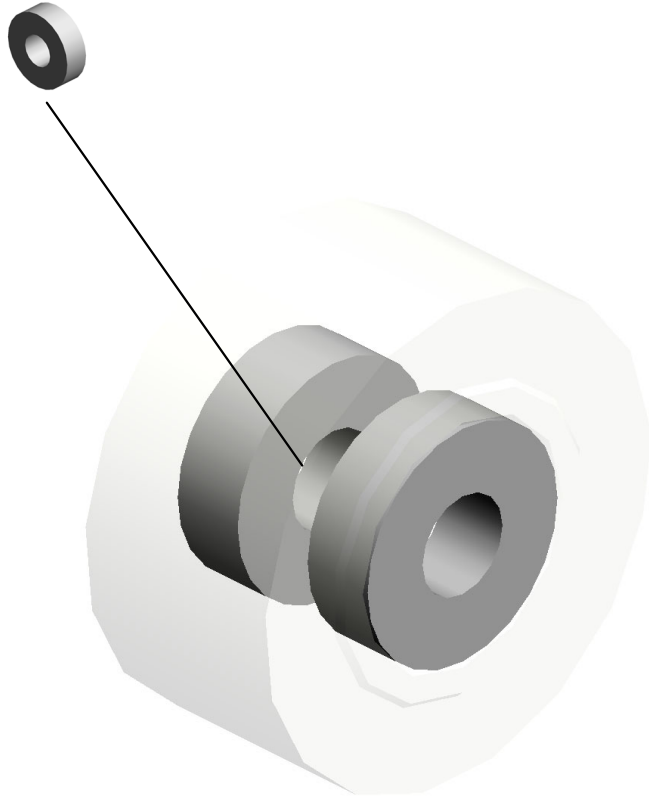

77.BB013028
GEAR:IDLER:35Z:A
SS'Y

U001	U002	U003	U004	U005	U006	U007	U008	U009	U010	U011	U012	U013	U014	U015	U016	U017	U018	U019	U020	U021
------	------	------	------	------	------	------	------	------	------	------	------	------	------	------	------	------	------	------	------	------

U015_S003_S005
GEAR:IDLER:FUSING

50.AE030030
(x2)
BALL BEARING - 8
X19X6

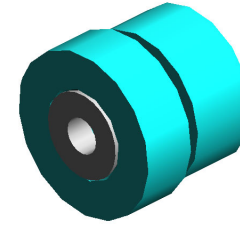
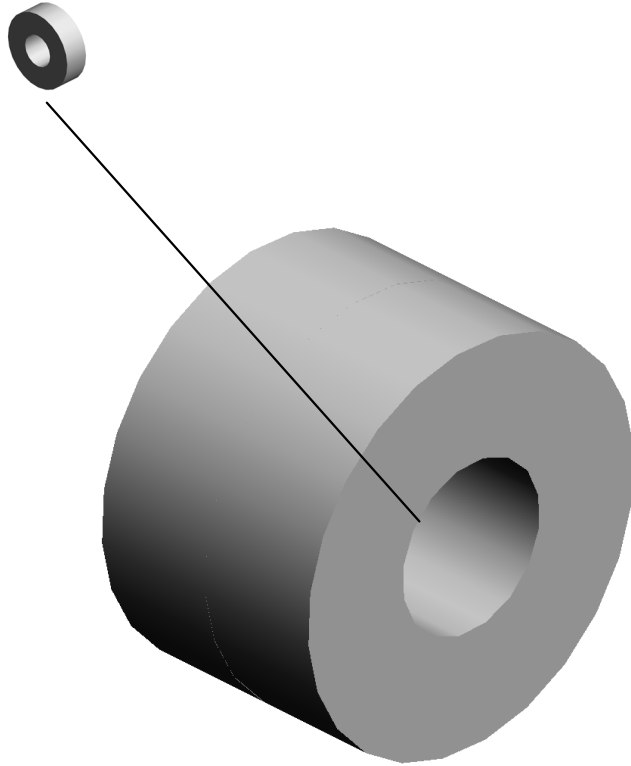

46.AB014287
GEAR:IDLER:FUSI
NG

U001	U002	U003	U004	U005	U006	U007	U008	U009	U010	U011	U012	U013	U014	U015	U016	U017	U018	U019	U020	U021
------	------	------	------	------	------	------	------	------	------	------	------	------	------	------	------	------	------	------	------	------

U015_S003_S006
GEAR:HOT ROLLER:ASS'Y

50.AE030030
BALL BEARING - 8
X19X6

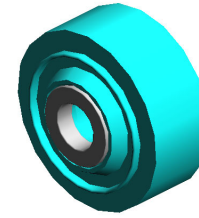

80.BB013038
GEAR:HOT ROLLE
R:ASS'Y

U001	U002	U003	U004	U005	U006	U007	U008	U009	U010	U011	U012	U013	U014	U015	U016	U017	U018	U019	U020	U021
------	------	------	------	------	------	------	------	------	------	------	------	------	------	------	------	------	------	------	------	------

U015_S003_S007
 DRIVE UNIT:WEB:CLEANING:ASS'Y

10.07200030E (x2) RETAINING RING - M3
 55.AE031037 (x4) BUSHING - M4
 64.AX040300 DC MOTOR:CLEANER:ASS'Y

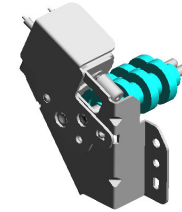

155.D2704290
 DRIVE UNIT:WEB:CLEANING:ASS'Y

45.AB014229 (x4) COUPLEDGEAR - 17Z/32Z



31.A2944171 (x4) COUPLED GEAR - 17Z/32Z



23.11050511 HARNESS CLAMP - LWS-0306ZC



25.11050551 (x2) CLAMP:LES-0505



23.11050511 (x2) HARNESS CLAMP - LWS-0306ZC

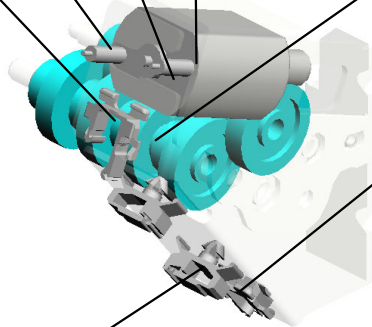

U015_S004
 (CHN/EU,AA,TWN,KOR):FUSING UNIT:220V:ASS'Y

- 9.04543006Q (x11) TAPPING SCREW - M3X6
- 7.04503008N (x2) TAPPING SCREW - M3X8
- 25.11050551 (x2) CLAMP:LES-0505
- 28.11050744 (1) CLAMP:F-LWS-071
- 6.03603010N (x2) SCREW:M3X10

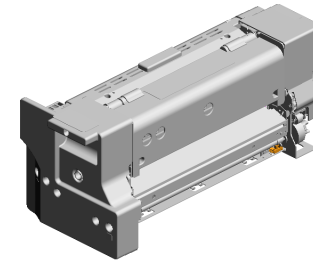

174-D2704418
 [A]
 (CHN/EU,AA,TWN,
 KOR):FUSING UNIT
 :220V:ASS'Y
 202306-01 O/O

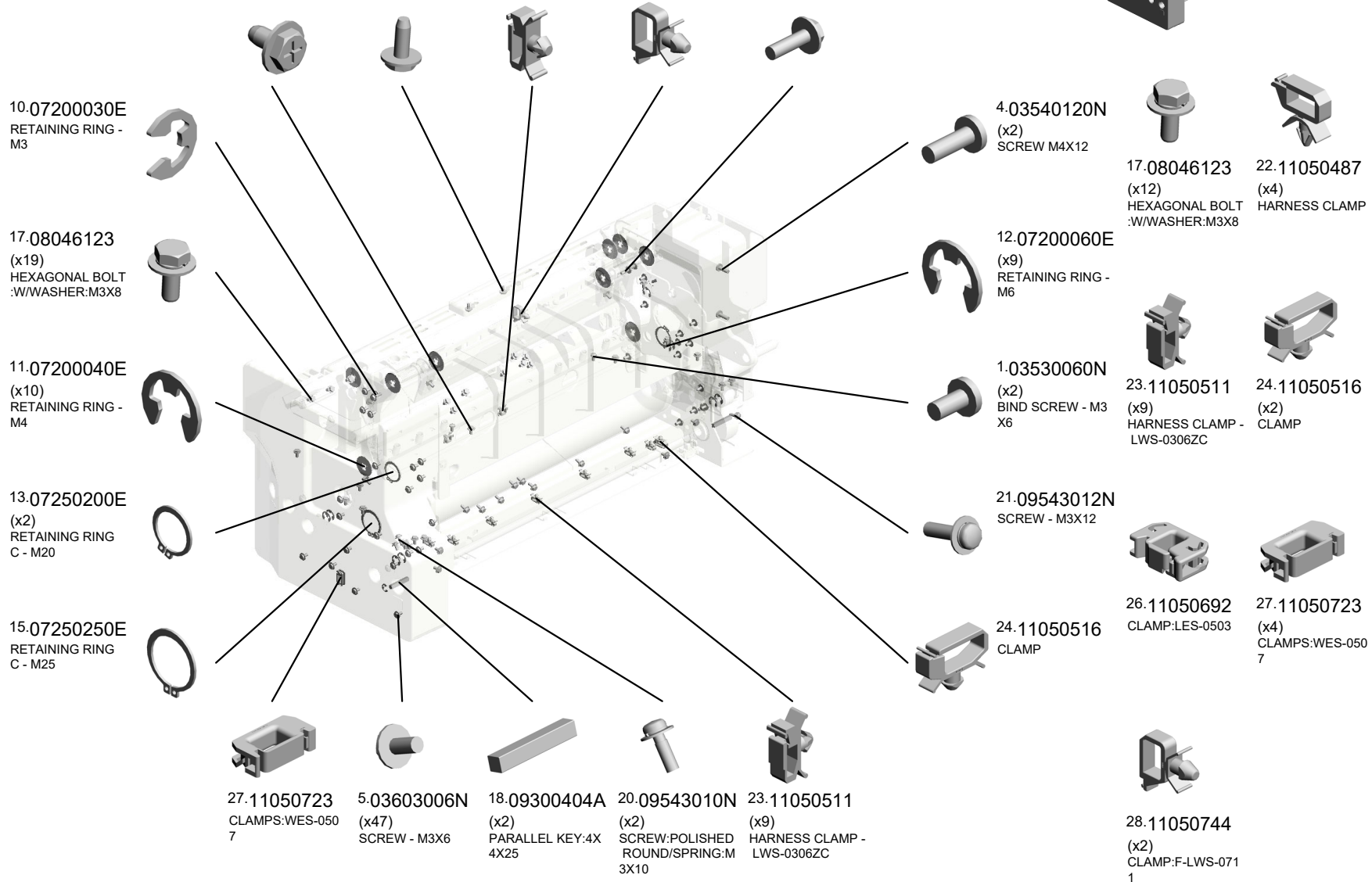

U015_S004
(CHN/EU,AA,TWN,KOR):FUSING UNIT:220V:ASS'Y

- 59.AW010147 (x3) PHOTO REFLECTI ON SENSOR
- 62.AW110052 (x2) THERMOSTAT:211 C
- 40.AA082101 (x2) BUSHING - 6X10X6
- 32.AA061116 (x2) TENSION SPRING: STRIPPER PLATE: 2N
- 43.AA143847 (x2) STEPPED SCREW: DIA5:3.5:M3

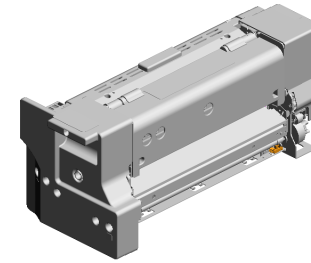

174-D2704418
[A]
(CHN/EU,AA,TWN, KOR):FUSING UNIT :220V:ASS'Y
202306-01 O/O

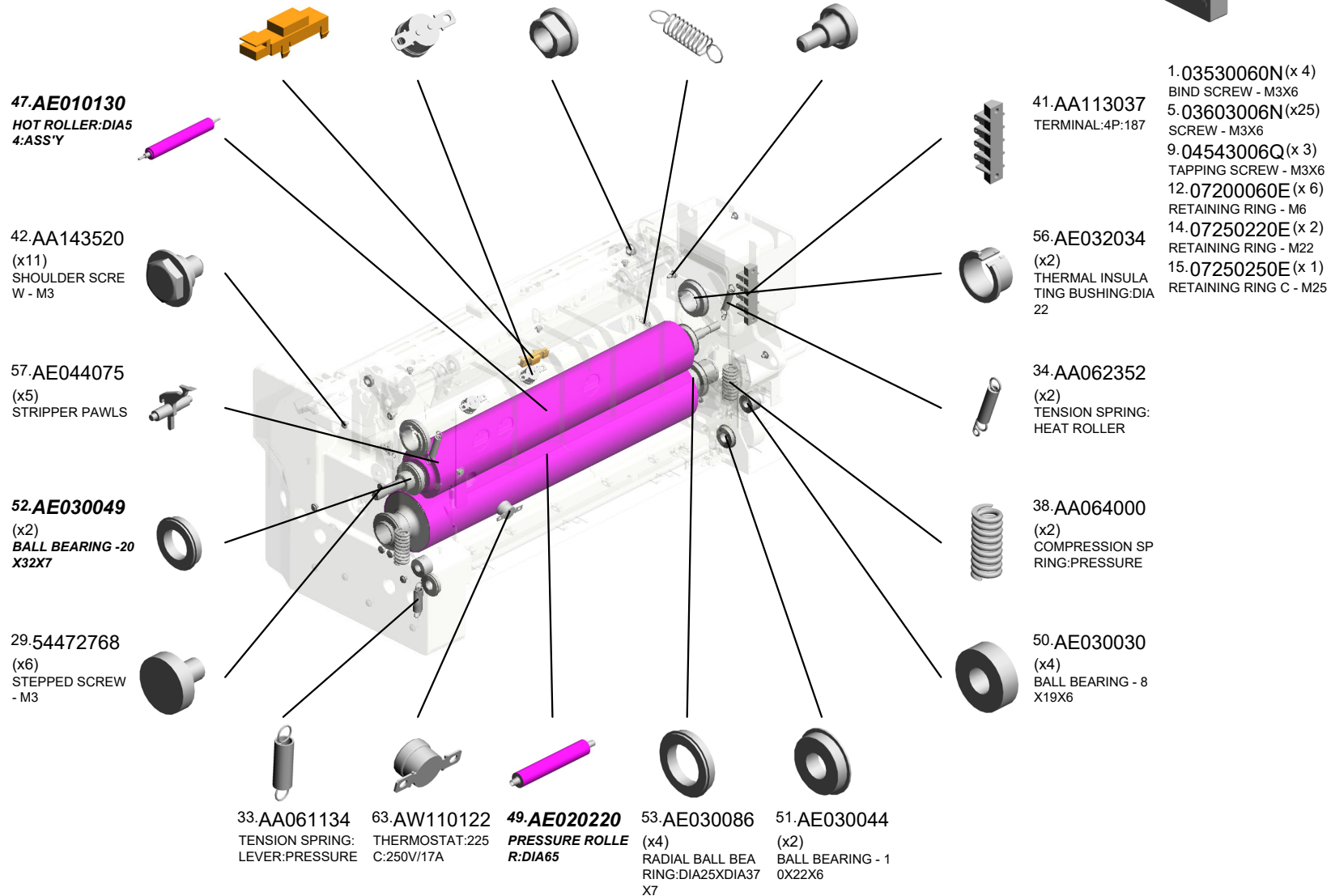

U015_S004
(CHN/EU,AA,TWN,KOR):FUSING UNIT:220V:ASS'Y

- 68.AX450067 (CHN/EU,AA,TWN,KOR):HEATER:HEAT ROLLER:227V:1070WX3:INFRARED
- 70.B1324196 (x5) SPRING:PICK-OFF PAWL
- 73.B1324268 (x5) HOLDER:ROLLER: PICK-OFF PAWL
- 72.B1324265 (x5) ROLLER:PICK-OFF PAWL
- 71.B1324197 TORSION SPRING: LEVER

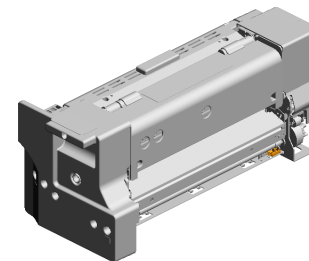

174-D2704418
[A]
(CHN/EU,AA,TWN,KOR):FUSING UNIT :220V:ASS'Y
202306-01 O/O

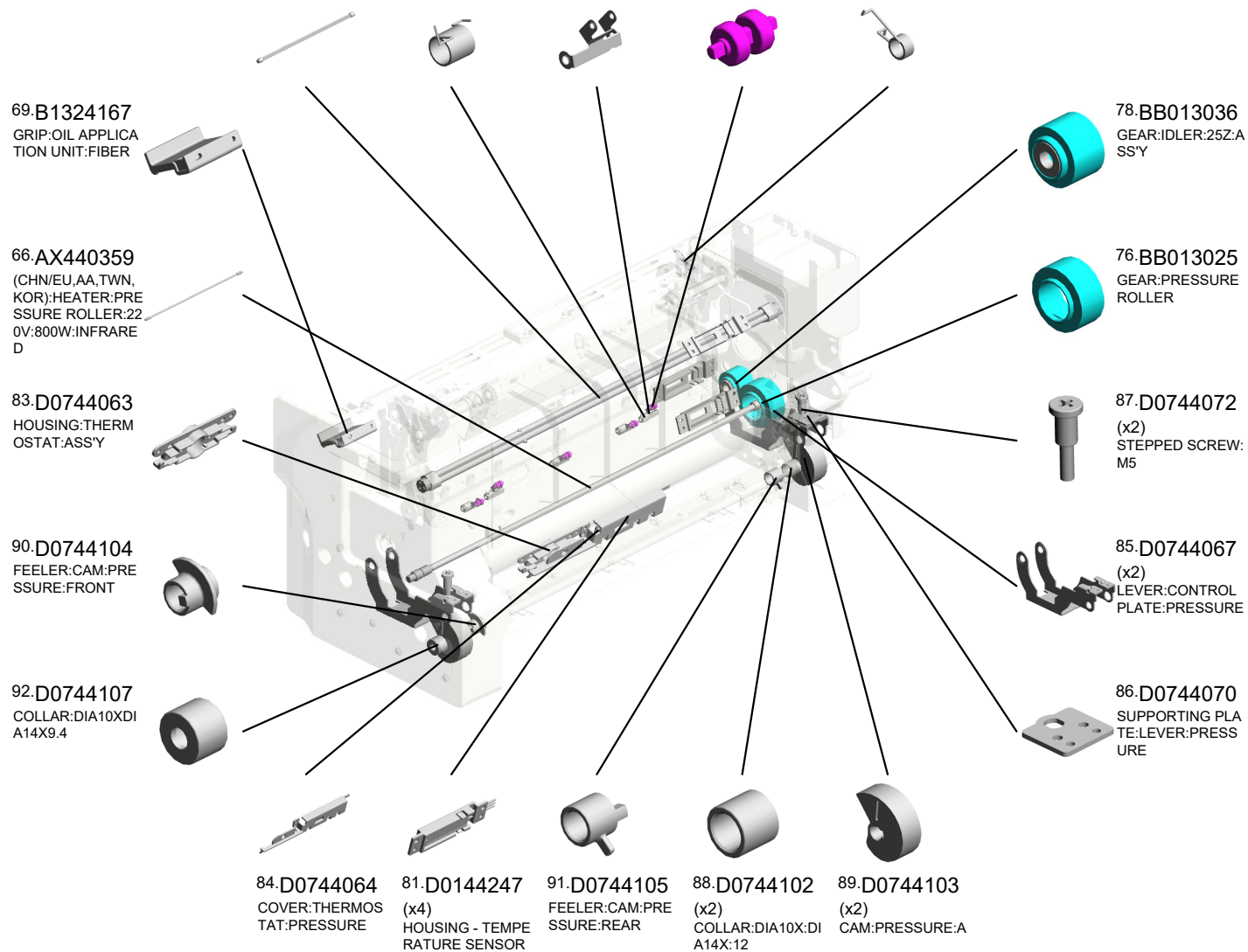

U015_S004
 (CHN/EU,AA,TWN,KOR):FUSING UNIT:220V:ASS'Y

- 93.D0744180 HOUSING:THERM
OSTAT:HEAT ROLL
ER:ASS'Y
- 94.D0744181 ELECTRODE PLAT
E:THERMOSTAT:H
EAT ROLLER:MIDD
LE
- 117.D1794114 GUIDE PLATE:FUSI
NG EXIT:LOWER
- 95.D0744182 ELECTRODE PLAT
E:THERMOSTAT:H
EAT ROLLER
- 115.D1794109 (x2)
ADJUSTING PIN:DI
SCHARGE BRUSH

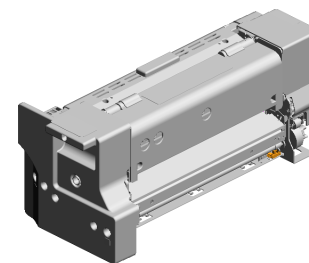

174.D2704418
 [A]
 (CHN/EU,AA,TWN,
 KOR):FUSING UNIT
 :220V:ASS'Y
 202306-01 O/O

114.D1794107
 BRACKET:STRIPP
 ER PAWLS:PRESS
 URE:PEEN

116.D1794113
 (x2)
 DISCHARGE BRUS
 H:21MM

119.D1794148
 SUPPORTING PLA
 TE:SIDE PLATE:FU
 SING:FRONT

105.D1794036
 SUPPORTING PLA
 TE:LEVER:PRESS
 URE:FRONT

109.D1794048
 HOLDER:HEATER:
 PRESSURE:FRON
 T

104.D1794028
 SUPPORTING PLA
 TE:LEVER:PRESS
 URE:FRONT

110.D1794071
 BRACKET:FUSING
 ENTRANCE GUIDE
 PLATE:FRONT

112.D1794081
 FUSING ENTRANC
 E GUIDE PLATE:LO
 WER

113.D1794095
 CLAMP:HARNES
 S:PRESSURE

111.D1794072
 BRACKET:FUSING
 ENTRANCE GUIDE
 PLATE:REAR

118.D1794147
 SUPPORTING PLA
 TE:SIDE PLATE:FU
 SING:REAR

97.D0744227
 (x2)
 BOLT:M5:ROUND P
 OINT

106.D1794037
 SUPPORTING PLA
 TE:LEVER:PRESS
 URE:REAR

107.D1794042
 LEVER:PRESSURE
 :REAR:OUTER

108.D1794047
 HOLDER:HEATER:
 PRESSURE:REAR

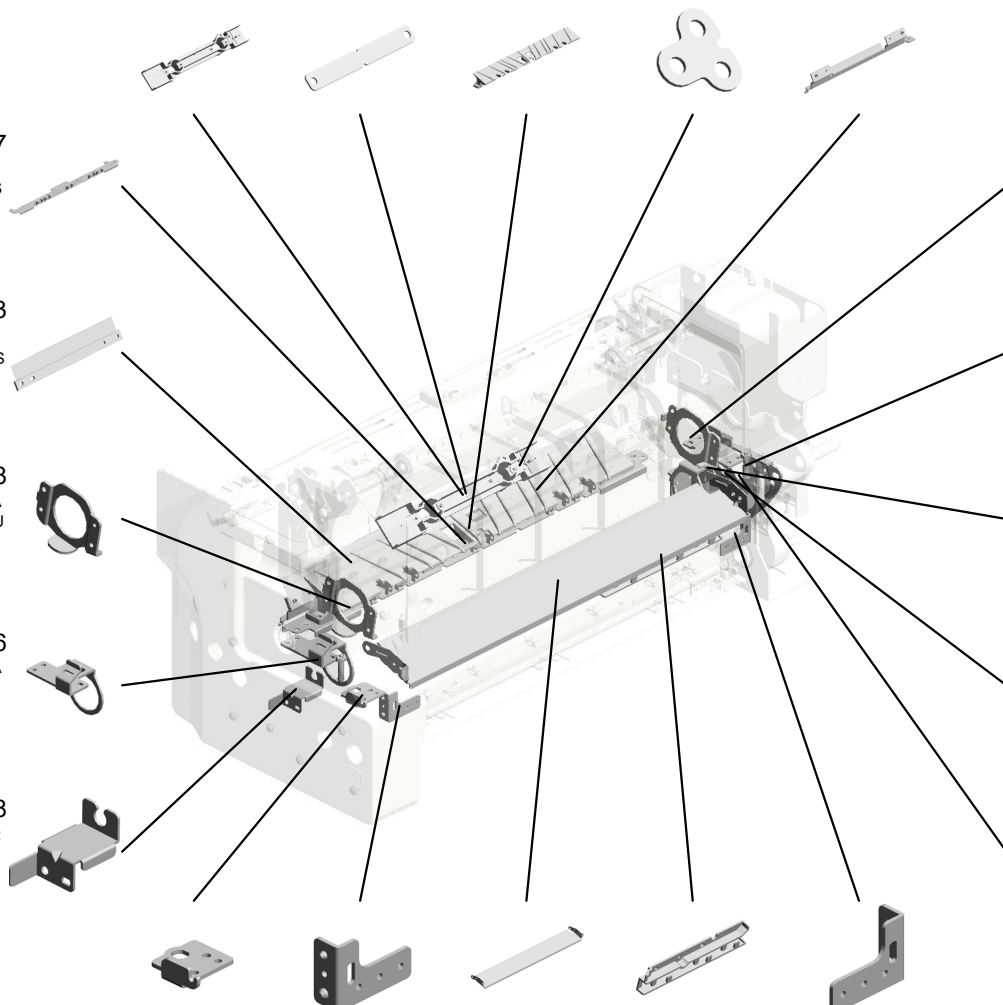

U015_S004
 (CHN/EU,AA,TWN,KOR):FUSING UNIT:220V:ASS'Y

- 139.D1794279 COVER:FUSING/PAPER EXIT UNIT:ASS'Y
- 140.D1794283 GRIP:COVER:FUSING/PAPER EXIT UNIT:ASS'Y
- 128.D1794228 (x2) SUPPORTER:GUIDE PLATE:FUSING EXIT:UPPER
- 127.D1794224 LEVER:PAPER EXIT UNIT:REAR
- 131.D1794235 (x2) TENSION SPRING:FUSING/PAPER EXIT UNIT

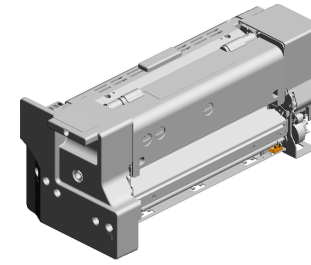

174.D2704418
 [A]
 (CHN/EU,AA,TWN,KOR):FUSING UNIT:220V:ASS'Y
 202306-01 O/O

130.D1794232
 SHAFT:FUSING/PAPER EXIT UNIT

133.D1794255
 GUIDE PLATE:FUSING EXIT:UPPER:ASS'Y

126.D1794223
 LEVER:PAPER EXIT UNIT:FRONT

129.D1794231
 STOPPER:LEVER:FUSING/PAPER EXIT UNIT

120.D1794170
 TAB:TERMINAL:187:4P

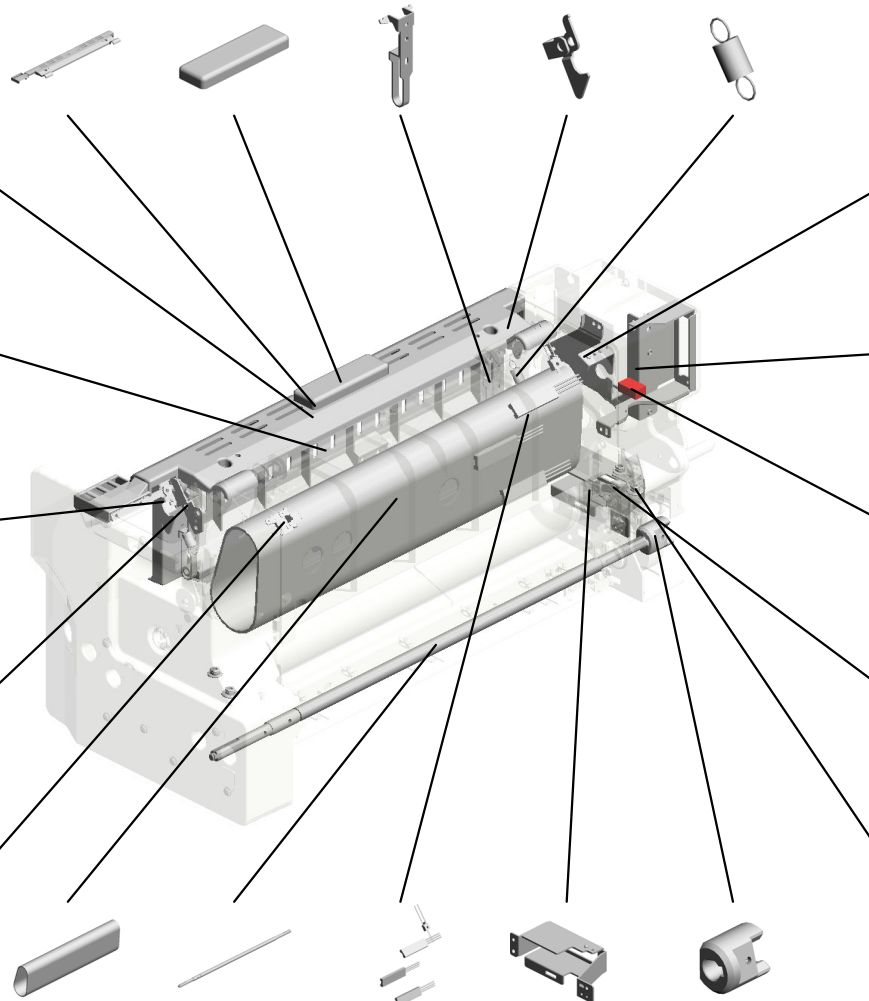

150.D2704180
 HOLDER:HEATER:HEAT ROLLER:REAR

123.D1794213
 BRACKET:DRAWER:UPPER

121.D1794182
 DISCHARGE BRUSH:HEAT ROLLER

125.D1794217
 BRACKET:DRAWER:LOWER:AUXILIARY

147.D2704009
 (x4)
 HOLDER:M5

- 122.D1794197 FLAT BELT-FUSING:SEAL
- 145.D1944101 SHAFT:CAM:PRESSURE
- 144.D1795381 TEMPERATURE SENSOR:FUSING UNIT:UPPER:19PIN
- 124.D1794216 BRACKET:DRAWER:LOWER
- 146.D1944106 JOINT:CAM:PRESSURE

U015_S004
(CHN/EU,AA,TWN,KOR):FUSING UNIT:220V:ASS'Y

- | | | | |
|---|---|--|--|
| 153.D2704236 | 169.D2704239 | 170.AE012048 | 154.D2704237 |
| TORSION SPRING:
FUSING/PAPER EX
IT UNIT:FRONT | STRIPPER PLATE:
ASS'Y
201810-06 X/X | HEAT ROLLER:DIA
39.2
201811-02 O/O | TORSION SPRING:
FUSING/PAPER EX
IT UNIT:REAR |

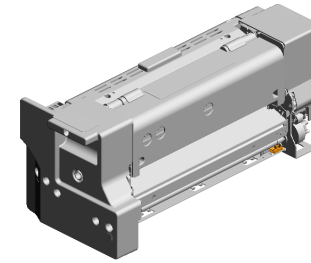

174.D2704418
[A]
(CHN/EU,AA,TWN,
KOR):FUSING UNIT
:220V:ASS'Y
202306-01 O/O

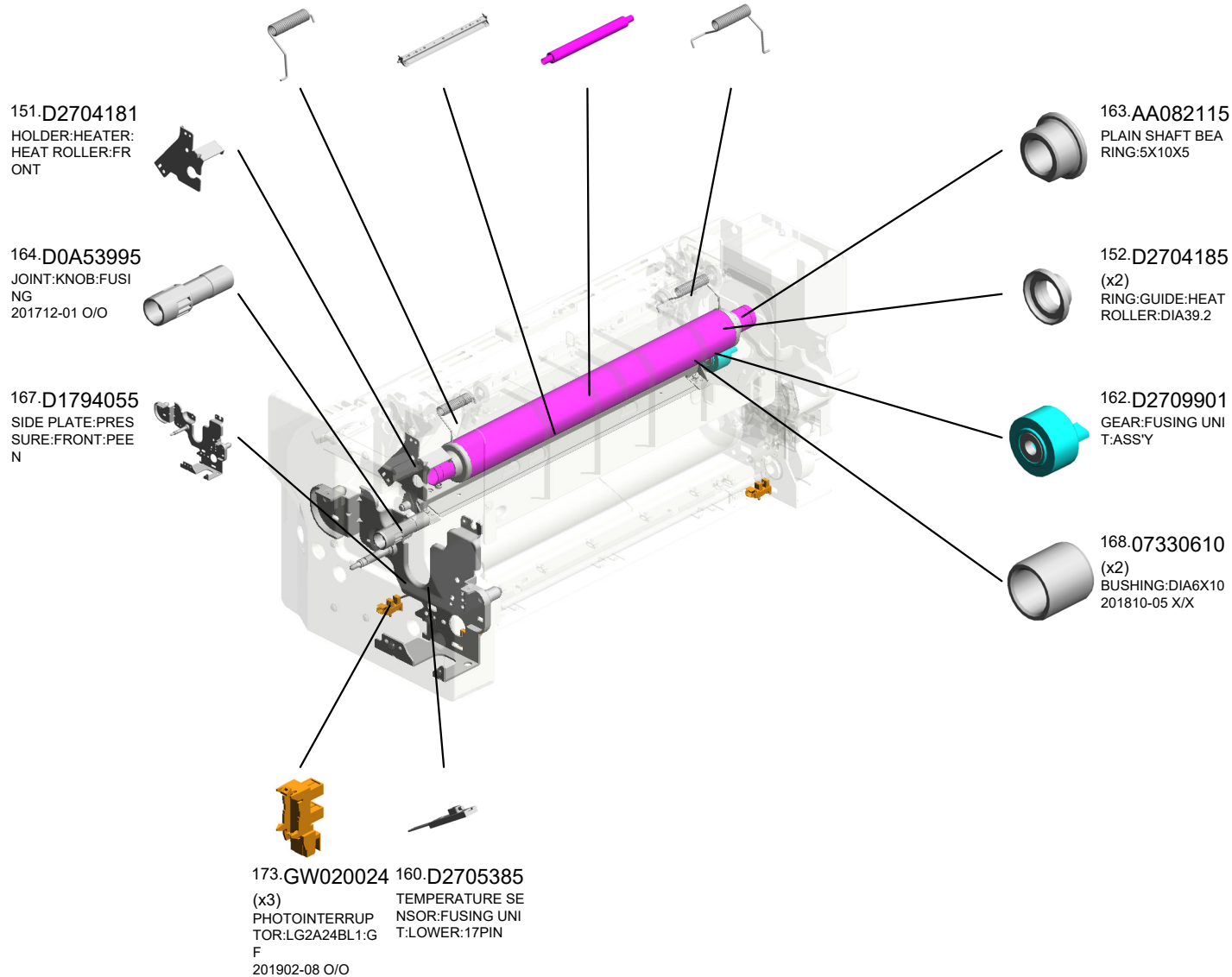

U001	U002	U003	U004	U005	U006	U007	U008	U009	U010	U011	U012	U013	U014	U015	U016	U017	U018	U019	U020	U021
------	------	------	------	------	------	------	------	------	------	------	------	------	------	------	------	------	------	------	------	------

U015_S004_S001
COVER:FUSING UNIT:REAR:ASS'Y

138.D1794278
DECAL:FUSING UN
IT:TCRU

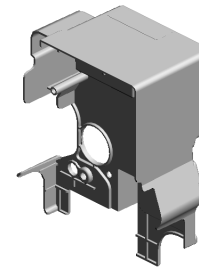
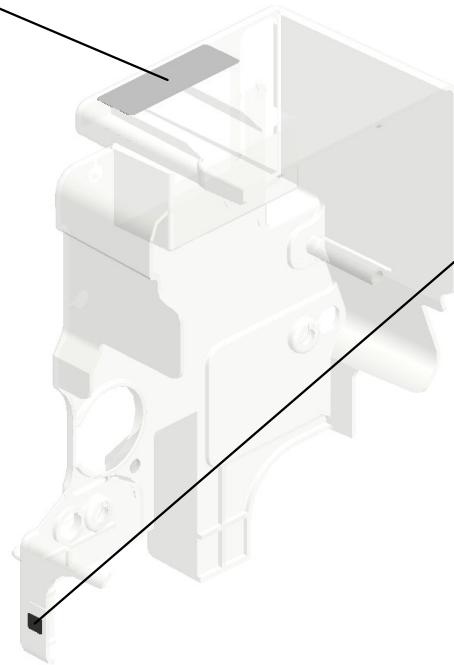

134.D1794271
COVER:FUSING U
NIT:REAR:ASS'Y



102.D0746497
DECAL:POSITIONI
NG DISPLAY:TCRU

U001	U002	U003	U004	U005	U006	U007	U008	U009	U010	U011	U012	U013	U014	U015	U016	U017	U018	U019	U020	U021
------	------	------	------	------	------	------	------	------	------	------	------	------	------	------	------	------	------	------	------	------

U015_S004_S002
COVER:FUSING UNIT:FRONT:ASS'Y

99.D0744336
DECAL:WARNING (REMOVAL AND INSTALLATION);FUSING

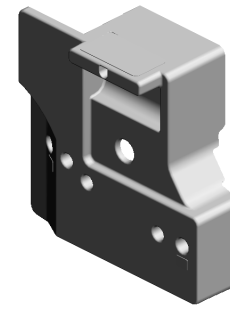
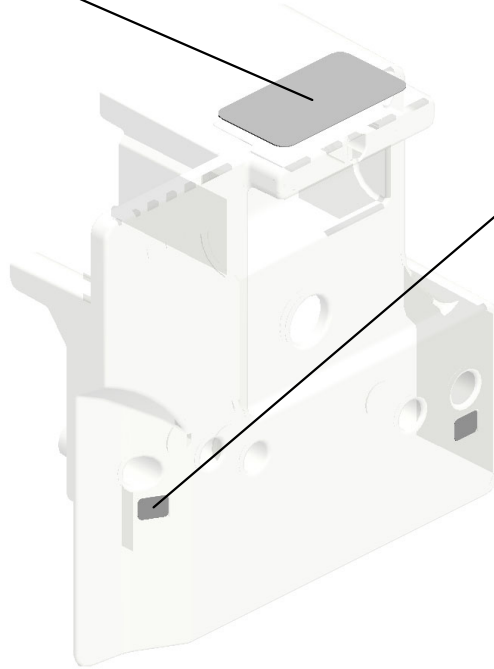

135.D1794273
COVER:FUSING UNIT:FRONT:ASS'Y

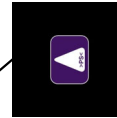

82.D0743829
(x2)
DECAL:POSITIONING DISPLAY:TCRU

U001	U002	U003	U004	U005	U006	U007	U008	U009	U010	U011	U012	U013	U014	U015	U016	U017	U018	U019	U020	U021
------	------	------	------	------	------	------	------	------	------	------	------	------	------	------	------	------	------	------	------	------

U015_S004_S003
COVER:FUSING UNIT:UPPER:ASS'Y

166.D2704277
DECAL:H-TEMP W
ARNING:FUSING
201807-11 O/O

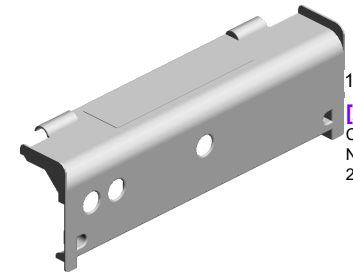
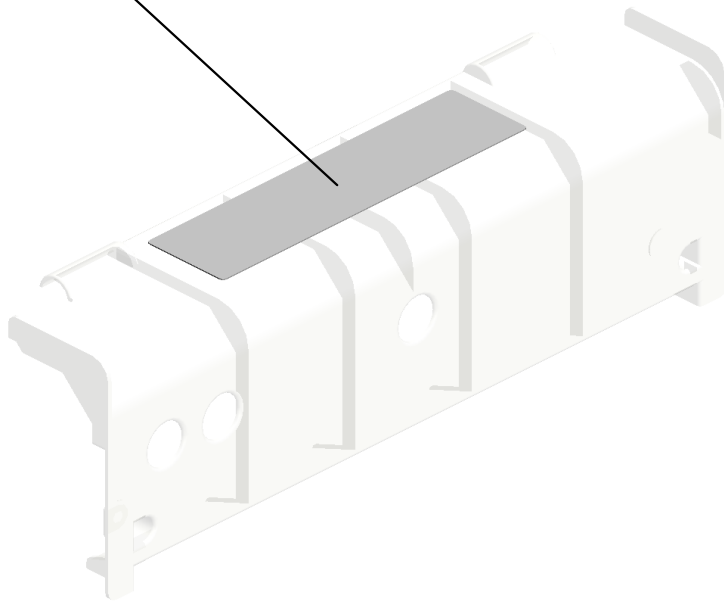

D1794285
[A]
COVER:FUSING U
NIT:UPPER:ASSY
201901-03 X/X



D1794275
[A]
COVER:FUSING U
NIT:UPPER:ASS'Y
201901-03 X/X

U001	U002	U003	U004	U005	U006	U007	U008	U009	U010	U011	U012	U013	U014	U015	U016	U017	U018	U019	U020	U021
------	------	------	------	------	------	------	------	------	------	------	------	------	------	------	------	------	------	------	------	------

U015_S004_S004
GEAR:IDLER:35Z:ASS'Y

50.AE030030
(x2)
BALL BEARING - 8
X19X6

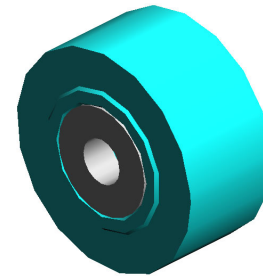
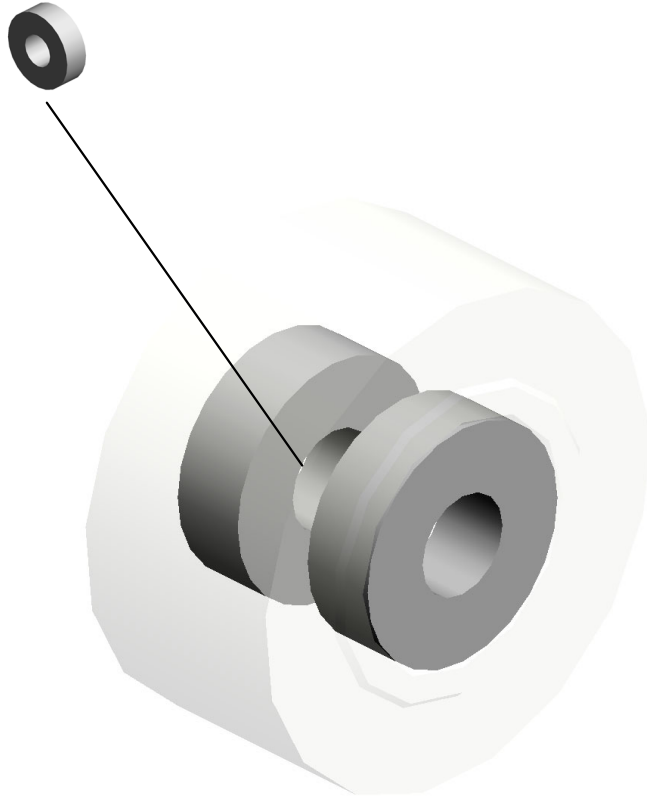

77.BB013028
GEAR:IDLER:35Z:A
SS'Y

U001	U002	U003	U004	U005	U006	U007	U008	U009	U010	U011	U012	U013	U014	U015	U016	U017	U018	U019	U020	U021
------	------	------	------	------	------	------	------	------	------	------	------	------	------	------	------	------	------	------	------	------

U015_S004_S005
GEAR:IDLER:FUSING

50.AE030030
(x2)
BALL BEARING - 8
X19X6

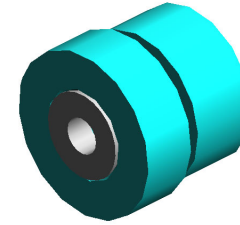
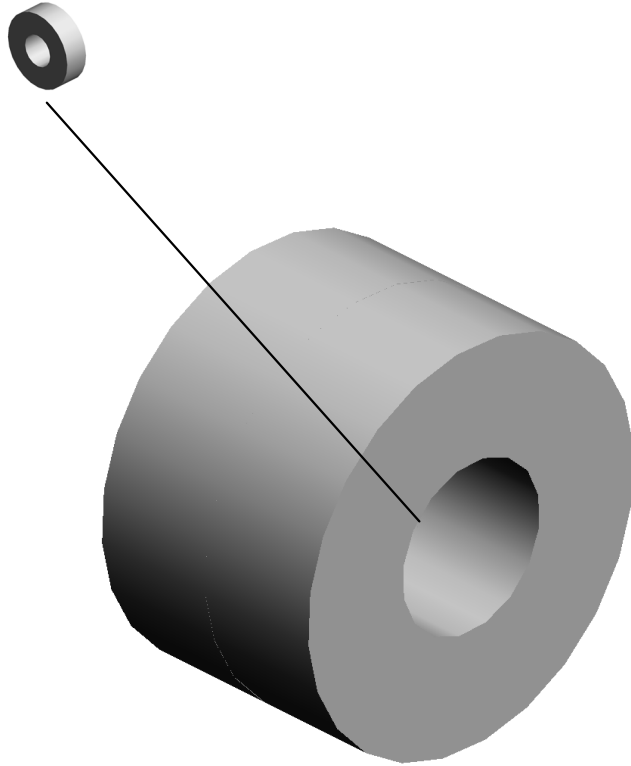

46.AB014287
GEAR:IDLER:FUSI
NG

U001	U002	U003	U004	U005	U006	U007	U008	U009	U010	U011	U012	U013	U014	U015	U016	U017	U018	U019	U020	U021
------	------	------	------	------	------	------	------	------	------	------	------	------	------	------	------	------	------	------	------	------

U015_S004_S006
GEAR:HOT ROLLER:ASS'Y

50.AE030030
BALL BEARING - 8
X19X6

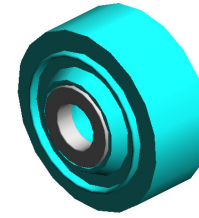

80.BB013038
GEAR:HOT ROLLE
R:ASS'Y

U001	U002	U003	U004	U005	U006	U007	U008	U009	U010	U011	U012	U013	U014	U015	U016	U017	U018	U019	U020	U021
------	------	------	------	------	------	------	------	------	------	------	------	------	------	------	------	------	------	------	------	------

U015_S004_S007
 DRIVE UNIT:WEB:CLEANING:ASS'Y

10.07200030E (x2) RETAINING RING - M3
 55.AE031037 (x4) BUSHING - M4
 64.AX040300 DC MOTOR:CLEANER:ASS'Y

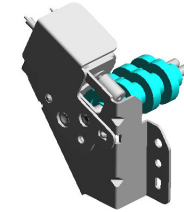

155.D2704290
 DRIVE UNIT:WEB:CLEANING:ASS'Y

45.AB014229 (x4) COUPLEDGEAR - 17Z/32Z



31.A2944171 (x4) COUPLED GEAR - 17Z/32Z



23.11050511 HARNESS CLAMP - LWS-0306ZC



25.11050551 (x2) CLAMP:LES-0505

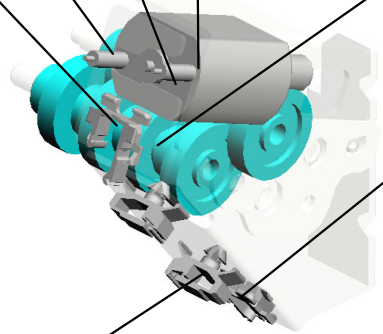

23.11050511 (x2) HARNESS CLAMP - LWS-0306ZC

U001	U002	U003	U004	U005	U006	U007	U008	U009	U010	U011	U012	U013	U014	U015	U016	U017	U018	U019	U020	U021
------	------	------	------	------	------	------	------	------	------	------	------	------	------	------	------	------	------	------	------	------

U016.PAPER EXIT

U016 S004
D1797083
SHAFT:MISFEED REMOVAL:
DUPLEX

U016 S011
D2704750
STOPPER:GUIDE PLATE:EXI
T:UPPER:SUB-ASSY

U016 S009
D1794843
TRANSPORT ROLLER:REVE
RSE:ENTRANCE

U016 S003
D2704543
SHAFT:MISFEED REMOVAL:
EXIT

U016 S007
D1794841
TRANSPORT ROLLER:EXIT:
EXIT

U016 S002
D2704535
DRIVE ROLLER:COOLING U
NIT:EXIT:PRESS FIT

U016 S010
D1794787
GUIDE PLATE:REVERSE EXI
T:ASS'Y

U016 S001
D1794531
SHAFT:COOLING UNIT:ENTR
ANCE

U016 S006
D1794840
TRANSPORT ROLLER:EXIT:
ENTRANCE

U016 S005
D1794840
TRANSPORT ROLLER:EXIT:
ENTRANCE

U016 S008
D1794842
TRANSPORT ROLLER:REVE
RSE

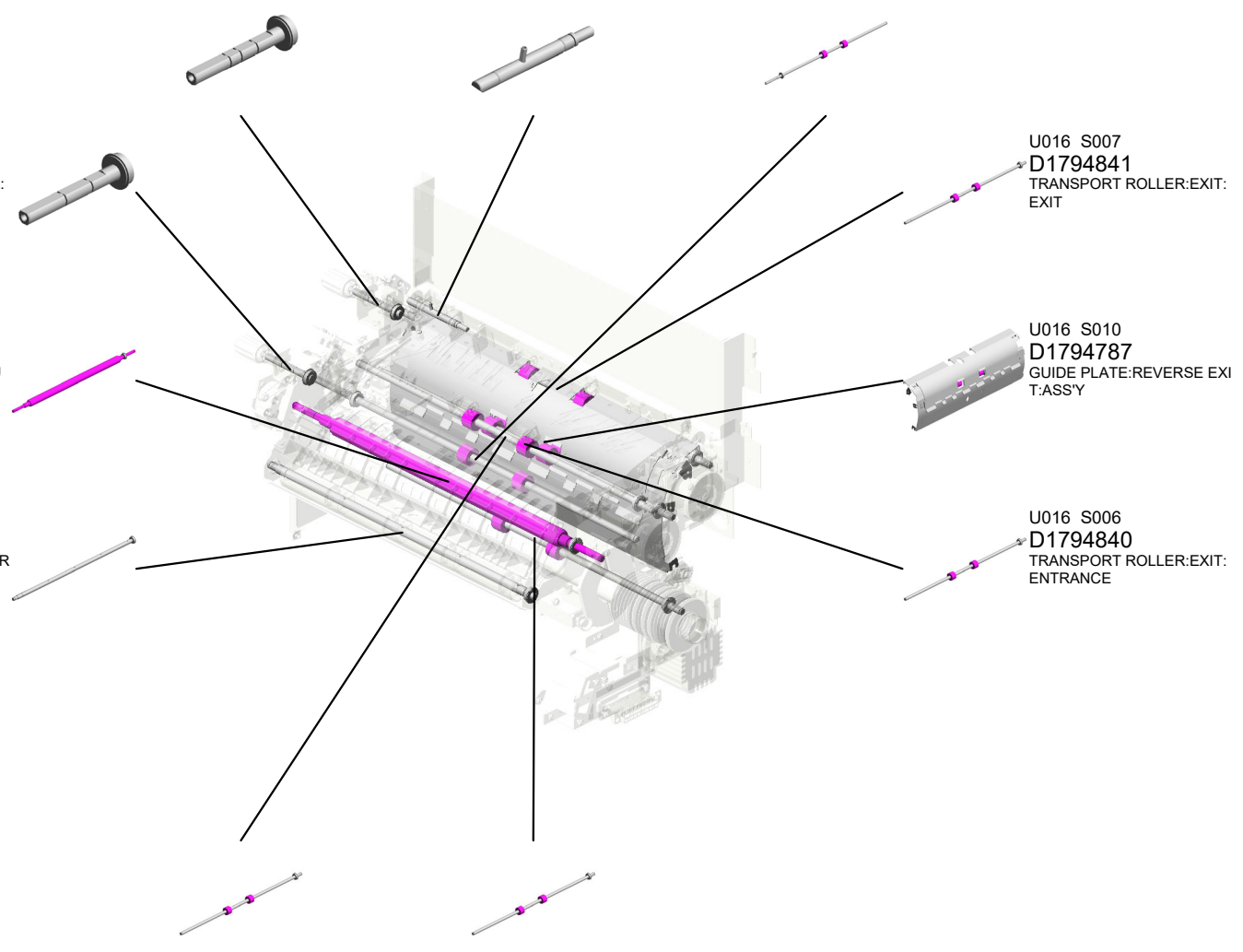

U016 PAPER EXIT

6.03604008N (x3) SCREW - M4X8
 20.07433808 (x10) RADIAL BALL BEA RING:DIA8XDIA16X 5
 4.03603008N (x2) SCREW:M3X8
 15.07200020E (x2) RETAINING RING - M2
 7.03604010N (x4) SCREW:M4X10

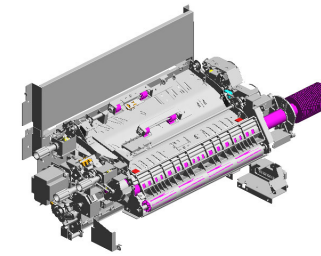

13.04544006Q (x5) TAPPING SCREW: 4X6

2.03530060N (x12) BIND SCREW - M3 X6

18.07200060E (x20) RETAINING RING - M6

9.04513006N (x44) TAPPING SCREW - 3X6

19.07200080E RETAINING RING - M8

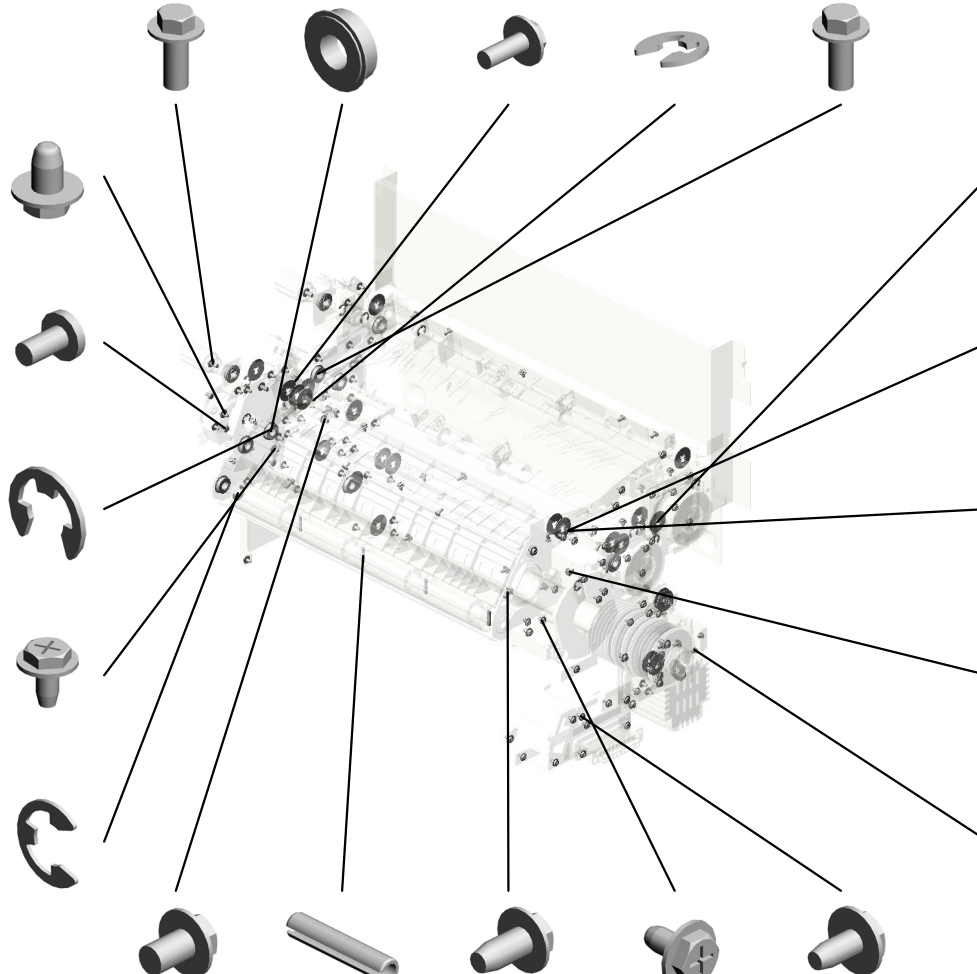

5.03604006N (x4) SCREW - M4X6
 14.06230160E (x4) SPRING PIN - 3X16 MM
 10.04514008N (x2) TAPPING SCREW: 4X8
 11.04543006Q (x43) TAPPING SCREW - M3X6
 12.04543008Q (x6) TAPPING SCREW: 3X8

17.07200040E (x23) RETAINING RING - M4

8.04503008N (x3) TAPPING SCREW - M3X8

16.07200030E (x5) RETAINING RING - M3

3.03603006N (x7) SCREW - M3X6

1.03530040N (x2) SCREW - M3X4

23.08050089 RETAINING RING - M4

24.11050511 (x6) HARNESS CLAMP - LWS-0306ZC

25.11050516 (x7) CLAMP

26.11050692 (x2) CLAMP:LES-0503

27.11050723 (x3) CLAMPS:WES-050 7

3.03603006N (x 3) SCREW - M3X6
 9.04513006N (x 1) TAPPING SCREW - 3X6

U016 PAPER EXIT

- 24.11050511 (x24) HARNESS CLAMP - LWS-0306ZC
- 28.AA043323 TIMING BELT:40S2 M120
- 23.08050089 RETAINING RING - M4
- 22.08050088 RETAINING RING - M6
- 35.AA063674 (x2) SPRING - 8N

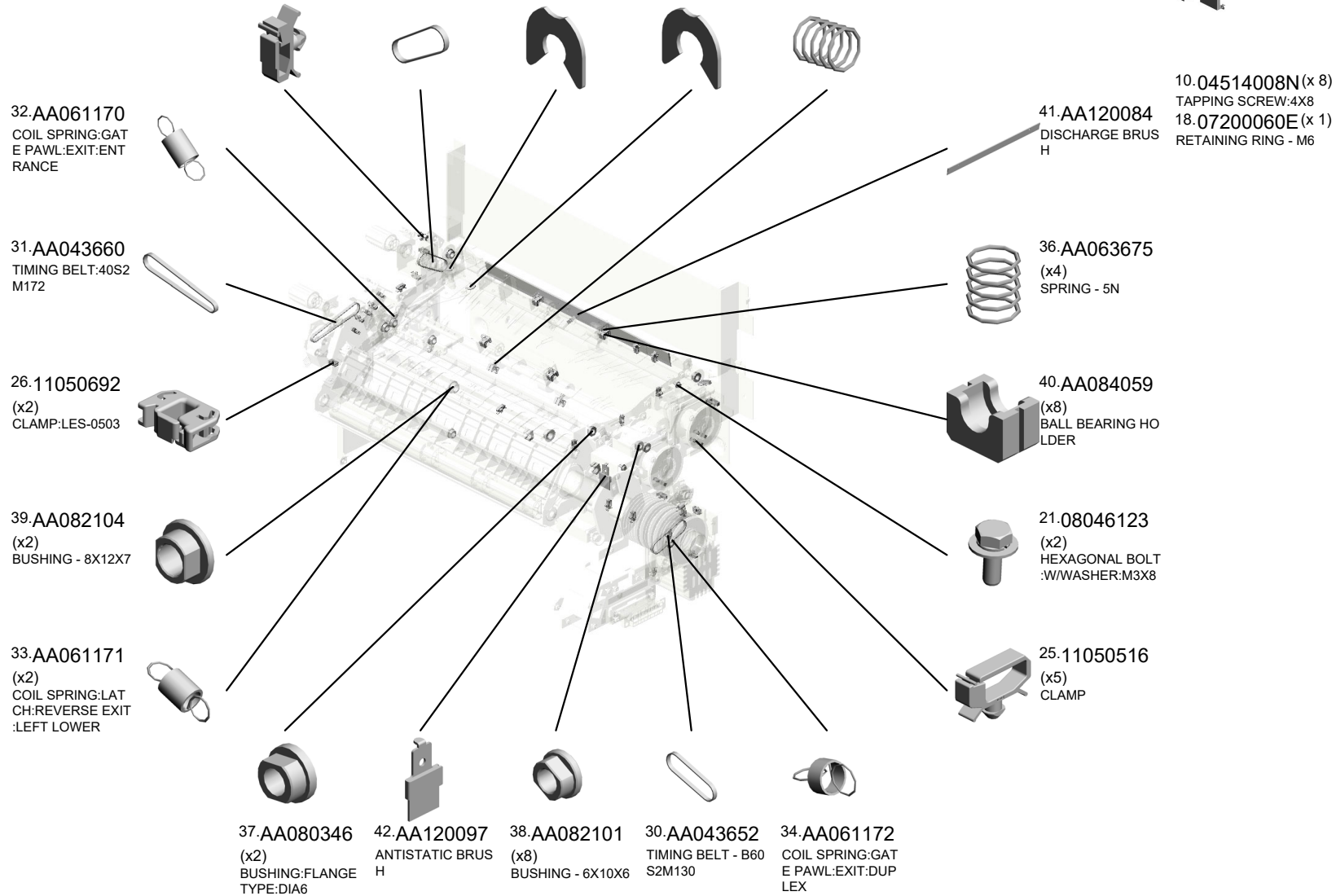
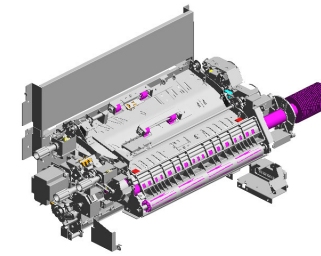

U016 PAPER EXIT

- 55.AX040276 (x2) STEPPER MOTOR: MM56:TRANSPORT
- 45.AA161180 (x2) CUSHION:DC STEPPER MOTOR
- 62.B2346424 (x2) RELEASE GRIP
- 51.AF022182 (x4) TRANSPORT ROLLER:DRIVEN:DIA17.5X2
- 53.AW010200 PAPER FEED SENSOR:FUSING EXIT

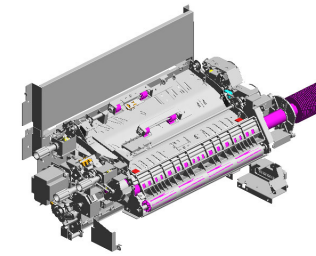

- 52.AG050100 (x3) KNOB - TRANSPORT ROLLER

- 59.B1322264 BUSHING:TERMINAL

- 56.AX040280 (x2) STEPPER MOTOR: DRIVE

- 50.AB030880 (x3) PULLEY:S2M:22T

- 58.B1253659 (x2) CUSHION:SWIVEL:STOPPER

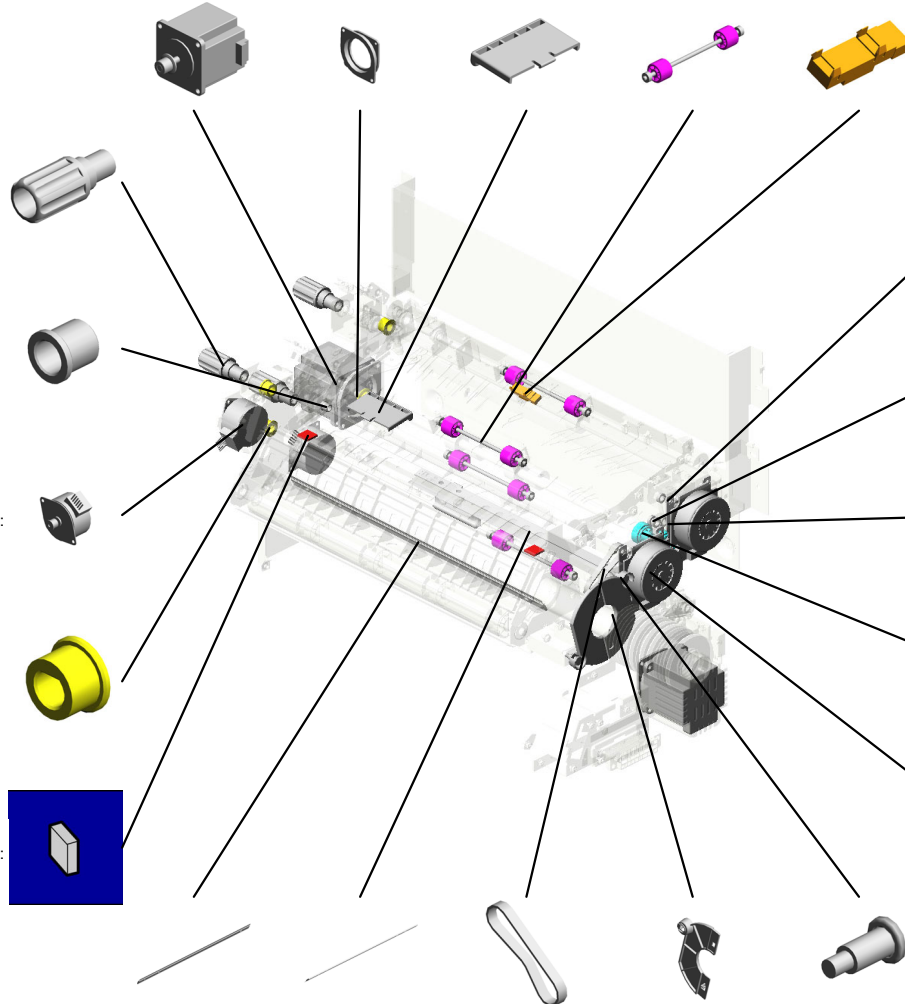

- 48.AB017961 (x2) GEAR:EXIT:70Z/T24

- 46.AB011626 GEAR:IDLER:EXIT:CONNECTING

- 49.AB017962 GEAR:IDLER:EXIT

- 47.AB011627 (x2) GEAR:EXIT:25Z

- 57.AX061102 (x2) DC BRUSHLESS MOTOR:25W:NMB:EXIT

- 61.B2344460 DISCHARGE BRUSH - L=341 SUS
- 43.AA120150 DISCHARGE BRUSH:REVERSE:17MM
- 63.B8304263 TIMING BELT - 60S 2M140
- 60.B2344258 (x2) CAP:HEAT PIPE
- 44.AA143444 (x2) STEPPED SCREW

U016 PAPER EXIT

- 64.D0464655 TIMING BELT:S2M180
- 66.D0743173 (x3) TIMING PULLEY:S2M:25T
- 65.D0742632 (x2) BRACKET:DC STEPPER MOTOR:MM56:CAM
- 77.D1794755 (x2) LEVER:LOCK:REVERSE EXIT:LEFT LOWER
- 75.D1794740 GUIDE PLATE:EXIT:UPPER:ENTRANCE

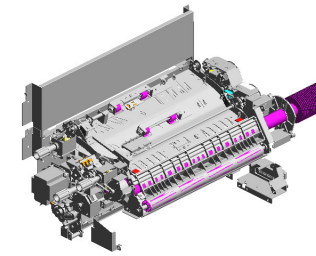

- 67.D0744698 (x2) LEVER:LOCK:GUIDE PLATE

- 79.D1794758 LINK:ON-OFF:DRIVEN ROLLER:REVERSE EXIT

- 71.D1794533 (x4) DRIVE ROLLER:COILING UNIT:ENTRANCE

- 72.D1794537 GUIDE PLATE:COILING UNIT:ENTRANCE

- 76.D1794754 STOPPER:GUIDE PLATE:REVERSE EXIT:LEFT LOWER

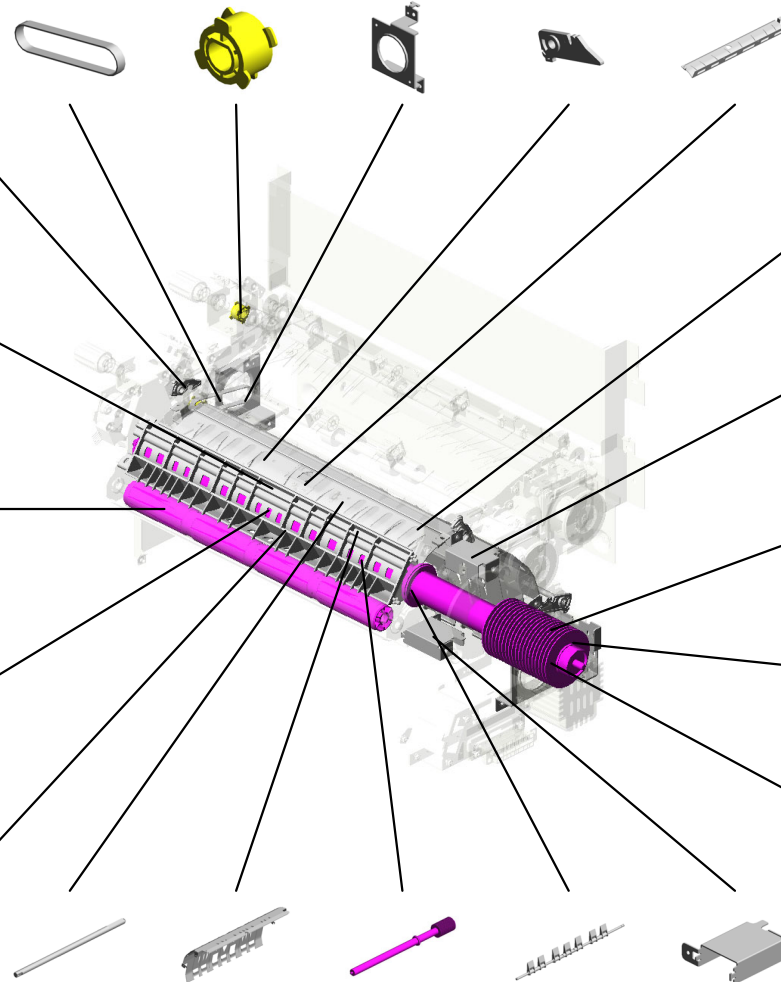

- 78.D1794757 SHAFT:LOCK:REVERSE EXIT:LEFT LOWER

- 73.D1794538 BRACKET:CAP:HEAT PIPE:UPPER

- 68.D0931266 DECAL:WARNING (HIGH TEMPERATURE):LENGTHWISE

- 81.D1794761 BRACKET:SOLENOID:GATE PAWL:SWITCHBACK

- 82.D1794766 LINK:GATE PAWL:SWITCHBACK

- 80.D1794759 SHAFT:ON-OFF:DRIVEN ROLLER:REVERSE EXIT
- 84.D1794784 GUIDE PLATE:REVERSE:LOWER
- 69.D1793960 TRANSPORT ROLLER:HEAT PIPE:DIA 30.4:ASSY
- 83.D2704768 GATE PAWL:SWITCHBACK 201705-01 X/O
- 74.D1794539 BRACKET:CAP:HEAT PIPE:LOWER

U016 PAPER EXIT

96.D1794821 LINK:GATE PAWL:
EXIT:ENTRANCE
113.D1797084 BRACKET:MISFEE
D REMOVAL:DUPL
EX
92.D1794811 SHAFT:GATE PAW
L:EXIT:REVERSE
85.D1794785 GUIDE PLATE:EXIT
:MIDDLE
109.D1794866 COVER:EXIT:EXIT

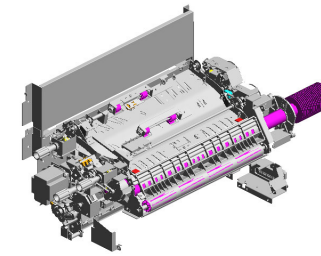

94.D1794816
BRACKET:CAM:GA
TE PAWL

95.D1794820
(x2)
CAM:ON-OFF

93.D1794813
BRACKET:DC STE
PPER MOTOR:ON-
OFF

97.D1794822
LINK:ON-OFF:REV
ERSE EXIT:CAM

100.D1794830
BRACKET:CONTA
CT POINT:REVER
SE EXIT:FRONT

98.D1794824
GUIDE PLATE:REV
ERSE EXIT:LEFT L
OWER:PEEN

99.D1794827
GUIDE PLATE:REV
ERSE EXIT:LEFT L
OWER:MIDDLE

102.D1794838
BRACKET:DRAWE
R:LEFT

110.D1794882
COVER:HARNES
S:LEFT LOWER

101.D1794835
BRACKET:CONTA
CT POINT:REVER
SE EXIT:REAR

108.D1794860
GUIDE PLATE:MAI
N:EXIT

107.D1794847
BRACKET:CONNE
CTION:MAIN:EXIT

91.D1794810
PLATE:GATE PAW
L:EXIT:REVERSE

87.D1794796
GUIDE PLATE:REV
ERSE:UPPER

89.D1794801
(x3)
GATE PAWL:REVE
RSE

U016 PAPER EXIT

116.D2416290 (x3) LED:RED
 117.D2452528 (x2) BUSHING:MM8
 126.D2704737 BRACKET:LINK:LEVER
 132.D2704748 COMPRESSION SPRING:STOPPER:20N
 125.D2704731 GUIDE PLATE:EXIT:UPPER:SUB-ASS'Y

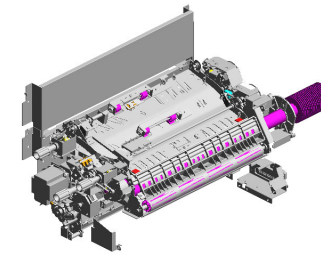

127.D2704740
BRACKET:ARM:STOPPER:RELEASE

130.D2704745
PIN:ARM:GRIP

124.D2704658
SHEET:HANDLE:LOCK:ASS'Y

131.D2704746
BRACKET:CAM:ON-OFF

128.D2704742
SHAFT:GUIDE PLATE:EXIT:UPPER:OPEN/CLOSE



134.D2704757
STOPPER:GUIDE PLATE:EXIT:INNER BACK

120.D2704551 (x2)
COIL SPRING:TENSIONER:EXIT

122.D2704555
SYNCHRONOUS BELT:B50S2M200

123.D2704557
COVER:EXIT:MOTOR

137.D2707197 (x2)
GATE PAWL:REVERSE:MIDDLE:FRONT

133.D2704753 PLATE:HANDLE:GUIDE:OPEN AND CLOSE
 115.D1797199 GATE PAWL:REVERSE:MIDDLE:FRONT
 114.D1797198 GATE PAWL:REVERSE:MIDDLE:INNER BACK
 138.D7773126 (x2) TIMING PULLEY:DRIVE:T25S2M
 135.D2704764 DC SOLENOID:GATE PAWL:SWITCH BACK

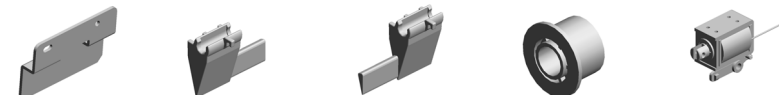

U016 PAPER EXIT

154.GW020024 (x2) PHOTOINTERRUP
TOR:LG2A24BL1:G
F
201902-08 O/O

143.G1784908 (x2) COIL SPRING:LEFT
LOWER:LOCK

150.M0B14675 GATE PAWL:EXIT:
REVERSE
201802-03 O/O

151.D2704800 SHAFT:GATE PAW
L:REVERSE
201805-05 O/O

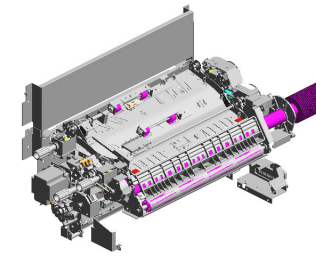

141.G1784828 (x4) STAY:LOCK:LEVER
:LEFT LOWER

147.J5033116 TIMING BELT:40S2
M128

155.AA043731 TIMING BELT:40S2
M184
202003-01 O/O

148.M0774821 TRANSPORT BELT
:COOLING

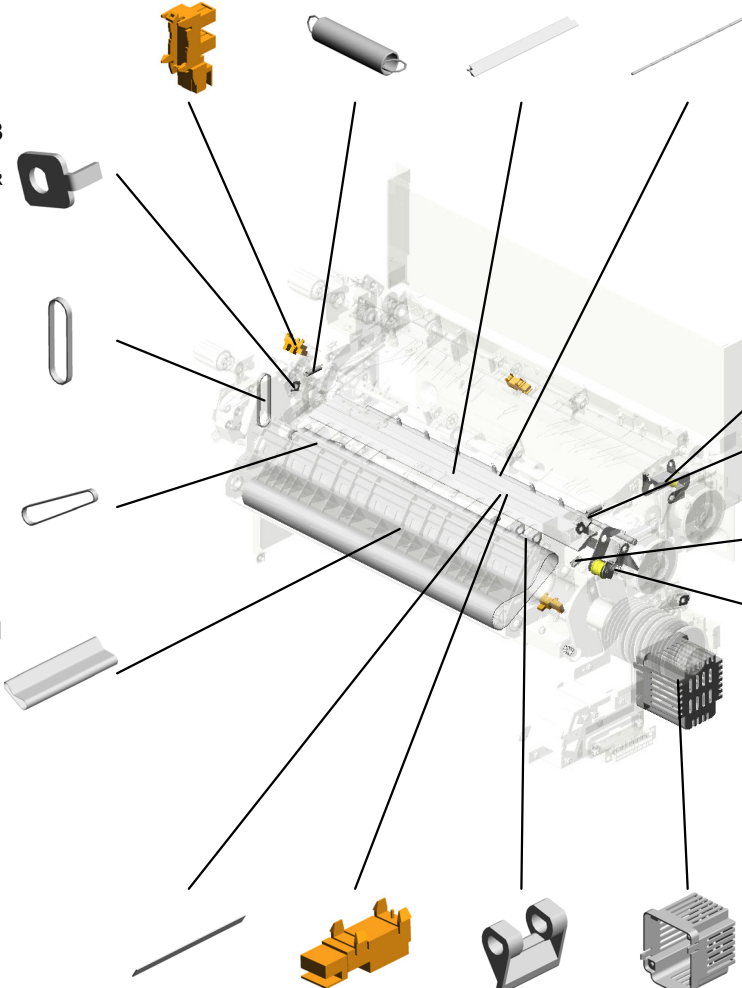

153.D2704547 (x2) BRACKET:TIGHTE
NER:EXIT:ASSY
201812-09 X/O

139.G1783593 (x7) TENSION SPRING:
STOPPER

140.G1784822 (x2) SPRING:PRESSUR
E:0.8N:DIA0.65

146.H0722216 (x2) COMPRESSION SP
RING

152.D0BX4786 CUSHION:GUIDE P
LATE:REVERSE:LO
WER
201812-03 X/O

145.GW010007 (x3) PHOTO REFLECTI
ON SENSOR:EXIT

144.G1787453 ARM:ON-OFF:TRA
NSPORT ROLLER

142.G1784900 COVER:DC STEPP
ER MOTOR:MM56

U016_S001
SHAFT:COOLING UNIT:ENTRANCE



70.D1794531
SHAFT:COOLING U
NIT:ENTRANCE

U001	U002	U003	U004	U005	U006	U007	U008	U009	U010	U011	U012	U013	U014	U015	U016	U017	U018	U019	U020	U021
------	------	------	------	------	------	------	------	------	------	------	------	------	------	------	------	------	------	------	------	------

U016_S002
DRIVE ROLLER:COOLING UNIT:EXIT:PRESS FIT

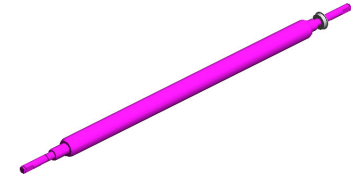

118.D2704535
DRIVE ROLLER:CO
OLING UNIT:EXIT:P
RESS FIT

U001	U002	U003	U004	U005	U006	U007	U008	U009	U010	U011	U012	U013	U014	U015	U016	U017	U018	U019	U020	U021
------	------	------	------	------	------	------	------	------	------	------	------	------	------	------	------	------	------	------	------	------

U016_S003
SHAFT:MISFEED REMOVAL:EXIT



U001	U002	U003	U004	U005	U006	U007	U008	U009	U010	U011	U012	U013	U014	U015	U016	U017	U018	U019	U020	U021
------	------	------	------	------	------	------	------	------	------	------	------	------	------	------	------	------	------	------	------	------

U016_S004
SHAFT:MISFEED REMOVAL:DUPLEX

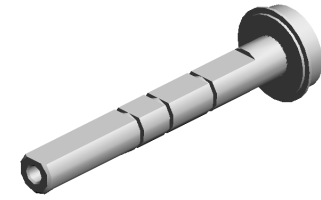

112.D1797083
SHAFT:MISFEED R
EMOVAL:DUPLEX

U001	U002	U003	U004	U005	U006	U007	U008	U009	U010	U011	U012	U013	U014	U015	U016	U017	U018	U019	U020	U021
------	------	------	------	------	------	------	------	------	------	------	------	------	------	------	------	------	------	------	------	------

U016_S005
TRANSPORT ROLLER:EXIT:ENTRANCE

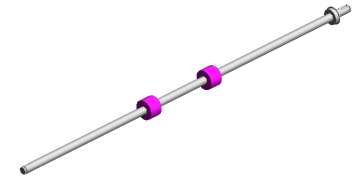

103.D1794840
TRANSPORT ROLL
ER:EXIT:ENTRANC
E

U001	U002	U003	U004	U005	U006	U007	U008	U009	U010	U011	U012	U013	U014	U015	U016	U017	U018	U019	U020	U021
------	------	------	------	------	------	------	------	------	------	------	------	------	------	------	------	------	------	------	------	------

U016_S006
TRANSPORT ROLLER:EXIT:ENTRANCE

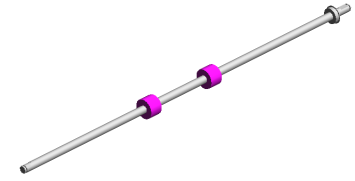

103.D1794840
TRANSPORT ROLL
ER:EXIT:ENTRANC
E

U001	U002	U003	U004	U005	U006	U007	U008	U009	U010	U011	U012	U013	U014	U015	U016	U017	U018	U019	U020	U021
------	------	------	------	------	------	------	------	------	------	------	------	------	------	------	------	------	------	------	------	------

U016_S007
TRANSPORT ROLLER:EXIT:EXIT

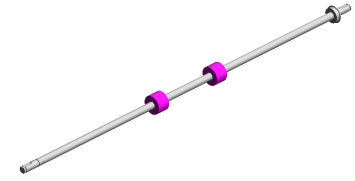

104.D1794841
TRANSPORT ROLL
ER:EXIT:EXIT

U001	U002	U003	U004	U005	U006	U007	U008	U009	U010	U011	U012	U013	U014	U015	U016	U017	U018	U019	U020	U021
------	------	------	------	------	------	------	------	------	------	------	------	------	------	------	------	------	------	------	------	------

U016_S008
TRANSPORT ROLLER:REVERSE

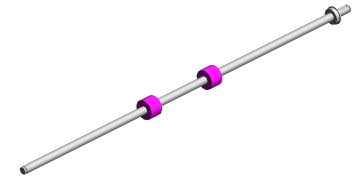

105.D1794842
TRANSPORT ROLL
ER:REVERSE

U001	U002	U003	U004	U005	U006	U007	U008	U009	U010	U011	U012	U013	U014	U015	U016	U017	U018	U019	U020	U021
------	------	------	------	------	------	------	------	------	------	------	------	------	------	------	------	------	------	------	------	------

U016_S009
TRANSPORT ROLLER:REVERSE:ENTRANCE

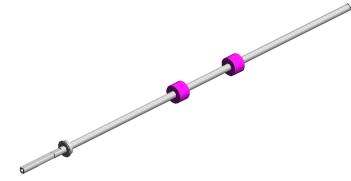

106.D1794843
TRANSPORT ROLL
ER:REVERSE:ENT
RANCE

U001	U002	U003	U004	U005	U006	U007	U008	U009	U010	U011	U012	U013	U014	U015	U016	U017	U018	U019	U020	U021
------	------	------	------	------	------	------	------	------	------	------	------	------	------	------	------	------	------	------	------	------

U016_S010
GUIDE PLATE:REVERSE EXIT:ASS'Y

9.04513006N (x4)
TAPPING SCREW - 3X6

51.AF022182
TRANSPORT ROLLER:DRIVEN:DIA17.5X2

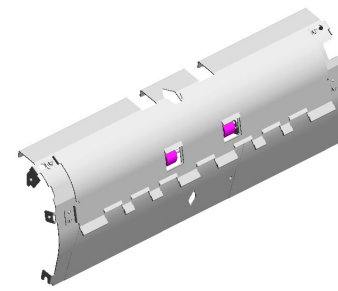

86.D1794787
GUIDE PLATE:REVERSE EXIT:ASSY

40.AA084059
(x2)
BALL BEARING HOLDER

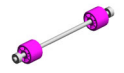

35.AA063674
(x2)
SPRING - 8N



111.D1794887
(x2)
SHEET:TRANSPORT:REVERSE EXIT:EXIT

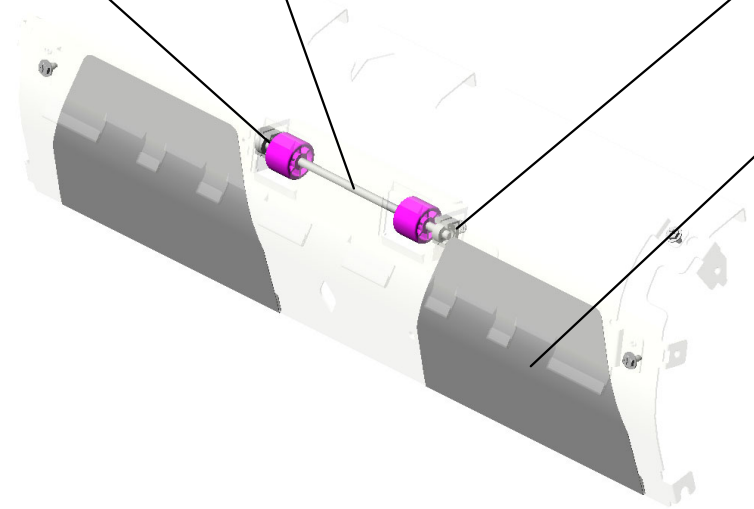

U001	U002	U003	U004	U005	U006	U007	U008	U009	U010	U011	U012	U013	U014	U015	U016	U017	U018	U019	U020	U021
------	------	------	------	------	------	------	------	------	------	------	------	------	------	------	------	------	------	------	------	------

U016_S011
STOPPER:GUIDE PLATE:EXIT:UPPER:SUB-ASS'Y

14.06230160E
SPRING PIN - 3X16
MM

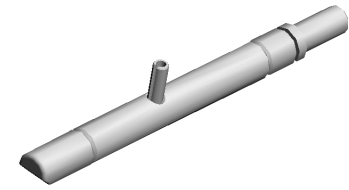
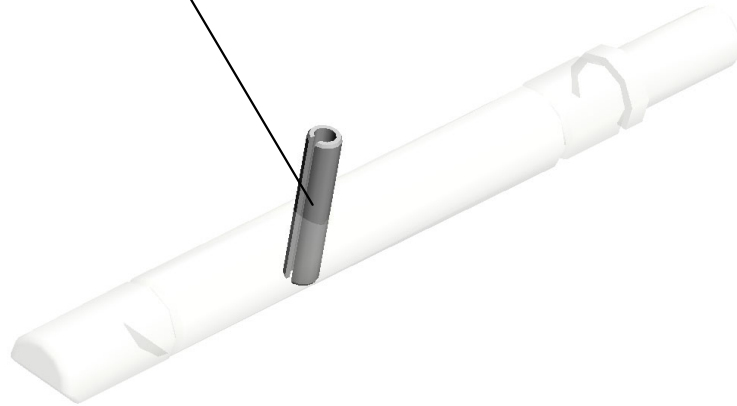
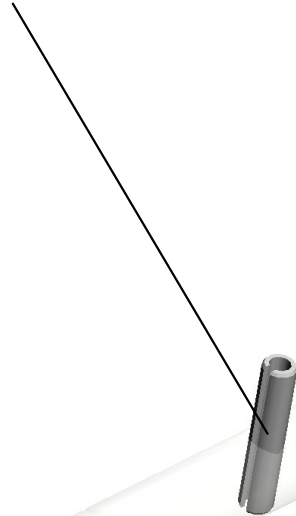
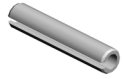

129.D2704750
[A]
STOPPER:GUIDE P
LATE:EXIT:UPPER:
SUB-ASS'Y
201704-02 X/O



D2704743
[A]
STOPPER:GUIDE P
LATE:EXIT:UPPER:
SUB-ASS'Y
201704-02 X/O

U001	U002	U003	U004	U005	U006	U007	U008	U009	U010	U011	U012	U013	U014	U015	U016	U017	U018	U019	U020	U021
------	------	------	------	------	------	------	------	------	------	------	------	------	------	------	------	------	------	------	------	------

U017.DUPLEX

U017 S006
D1797085
TRANSPORT ROLLER:DUPL
EX

U017 S005
D1797085
TRANSPORT ROLLER:DUPL
EX

U017 S004
D1797085
TRANSPORT ROLLER:DUPL
EX

U017 S003
D1797085
TRANSPORT ROLLER:DUPL
EX

U017 S001
D1797083
SHAFT:MISFEED REMOVAL:
DUPL
EX

U017 S008
D1797085
TRANSPORT ROLLER:DUPL
EX

U017 S002
D1797085
TRANSPORT ROLLER:DUPL
EX

U017 S009
D1797083
SHAFT:MISFEED REMOVAL:
DUPL
EX

U017 S007
D1797085
TRANSPORT ROLLER:DUPL
EX

U017 S010
D1797120
TRANSPORT ROLLER:REVE
RSE:DUPL
EX

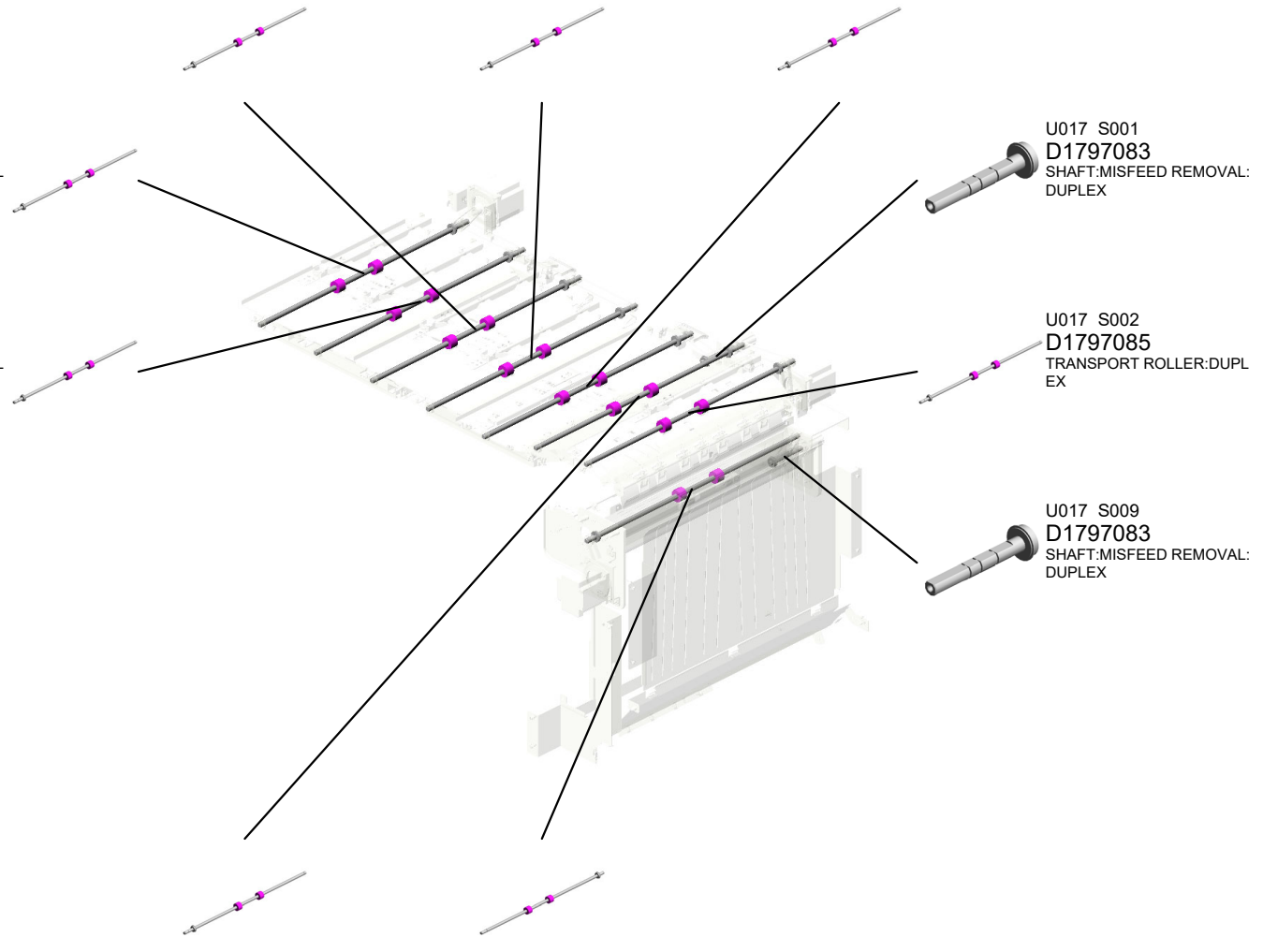

U001	U002	U003	U004	U005	U006	U007	U008	U009	U010	U011	U012	U013	U014	U015	U016	U017	U018	U019	U020	U021
------	------	------	------	------	------	------	------	------	------	------	------	------	------	------	------	------	------	------	------	------

U017 DUPLEX

8.04513006N (x54) TAPPING SCREW - 3X6
 23.A2574493 (x2) BAND
 2.03603006N (x2) SCREW - M3X6
 24.AA021034 (x2) MAGNETIC
 6.04503008N (x10) TAPPING SCREW - M3X8

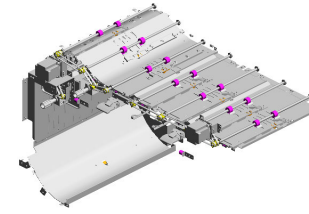

12.07200060E (x25) RETAINING RING - M6

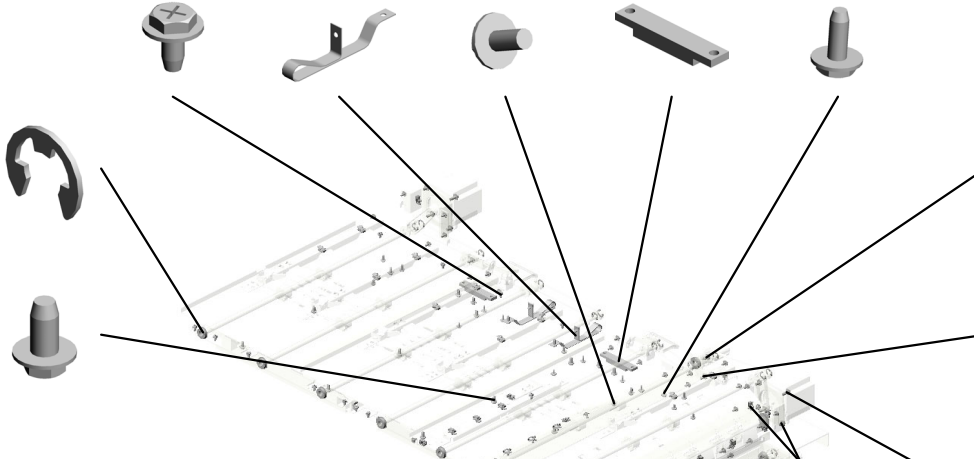

7.04504008N (x18) TAPPING SCREW - M4X8

18.11050692 (x5) CLAMP:LES-0503

22.54472681 (x2) SNAP RING

13.07433808 (x10) RADIAL BALL BEARING: DIA8XDIA16X5

19.11050723 CLAMPS:WES-0507

11.07200040E (x2) RETAINING RING - M4

1.03530100N SCREW-M3X10

10.04543008Q (x21) TAPPING SCREW: 3X8

14.08010237 HEXAGONAL BOLT :DOUBLE SCREW: M4X12

4.03604008N SCREW - M4X8

9.04514008N (x12) TAPPING SCREW: 4X8

5.03604010N (x6) SCREW:M4X10

16.11050511 (x27) HARNESS CLAMP - LWS-0306ZC

3.03604006N (x6) SCREW - M4X6

15.11050487 (x6) HARNESS CLAMP

16.11050511 (x33) HARNESS CLAMP - LWS-0306ZC

17.11050516 (x5) CLAMP

20.11050724 (x2) CLAMPS:WES-1210

21.16072250 FERRITE CORE:K3 NF-72(N)BK0

9.04514008N(x 1) TAPPING SCREW:4X8

U017 DUPLEX

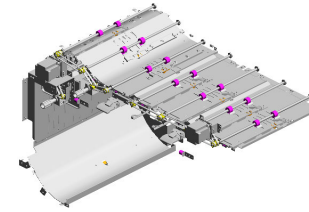

- 27.AA043650 (x3) TIMING BELT - B60 S2M290
- 33.AA143811 (x4) STEPPED SCREW - M3X4
- 41.B0654935 (x2) LEVER:GUIDE PLATE:ASSY
- 44.D0743173 (x15) TIMING PULLEY:S2M:25T
- 38.AG050100 (x2) KNOB - TRANSPORT ROLLER

26.AA043333
(x3)
TIMING BELT:60S2
M168

29.AA063674
(x8)
SPRING - 8N

37.AF022182
(x8)
TRANSPORT ROLLER:DRIVEN:DIA17.5X2

32.AA084059
(x16)
BALL BEARING HOLDER

30.AA063675
(x8)
SPRING - 5N

42.D0742632
BRACKET:DC STEPPER MOTOR:MM56:CAM

31.AA080346
(x2)
BUSHING:FLANGE TYPE:DIA6

39.AW010143
PHOTO REFLECTIVE SENSOR:PSR11 TL1R-C

36.AF022067
(x5)
GUIDE STOPPER ROLLER

28.AA061173
(x7)
COIL SPRING:GATE PAWL:DUPLEX:ENTRANCE

25.AA043293
TIMING BELT - 40S
2M268G

43.D0743047
(x2)
BRACKET:HOLDER:DUPLEX:ASSY

35.AB030842
(x2)
TIMING PULLEY:S2M:30T

40.AX040276
(x3)
STEPPER MOTOR:MM56:TRANSPORT

34.AA161180
(x3)
CUSHION:DC STEPPER MOTOR

U017 DUPLEX

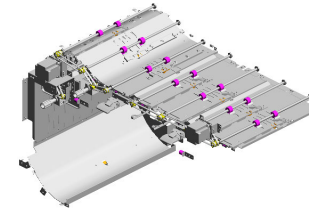

- 58.D1797082 BRACKET:DC STEPPER MOTOR:DUPLEX:RIGHT
- 47.D1797053 GUIDE PLATE:DUPLEX:UPPER:MIDDLE
- 54.D1797071 (x4) SUPPORTING PLATE:GUIDE PLATE:DUPLEX:OPEN AND CLOSE
- 53.D1797070 GUIDE PLATE:DUPLEX:OPEN AND CLOSE:LEFT
- 46.D1797050 GUIDE PLATE:DUPLEX:UPPER:LEFT

- 48.D1797056 GUIDE PLATE:DUPLEX:UPPER:RIGHT

- 55.D1797075 GUIDE PLATE:DUPLEX:OPEN AND CLOSE:RIGHT

- 56.D1797076 GUIDE PLATE:DUPLEX:LOWER

- 63.D1797098 BRACKET:DUPLEX:OPEN AND CLOSE:RIGHT:PEEN

- 62.D1797096 BRACKET:DUPLEX:OPEN AND CLOSE:LEFT:PEEN

- 49.D1797060 (x7) GATE PAWL:DUPL EX:ENTRANCE
- 52.D1797066 GUIDE PLATE:DUPLEX:ENTRANCE:LOWER
- 51.D1797062 GUIDE PLATE:DUPLEX:ENTRANCE:UPPER
- 64.D1797102 GUIDE PLATE:RECEIVING SUB-UNIT:REVERSE:LOWER
- 45.D1797023 GUIDE PLATE:RECEIVING SUB-UNIT:REVERSE:UPPER

- 71.D2704933 (x2) GUIDE PLATE LEVEL HOOK

- 60.D1797084 (x2) BRACKET:MISFEED REMOVAL:DUPL EX

- 69.D1797131 BRACKET:ROLLER:PEEN

- 57.D1797081 BRACKET:DC STEPPER MOTOR:DUPLEX:LEFT

- 70.D2416290 LED:RED

U017 DUPLX

- 79.G1784916 (x4) SCREW:ROUND POINT
- 86.D2704670 (x2) BRACKET:MAGNET CATCH:DUPLX
- 75.G1784808 (x5) BRACKET:PRESSURE:ROLLER
- 76.G1784817 (x10) SPRING:PRESSURE:ROLLER:DUPLX
- 74.D6844142 (x4) TIMING BELT:60S2 M174

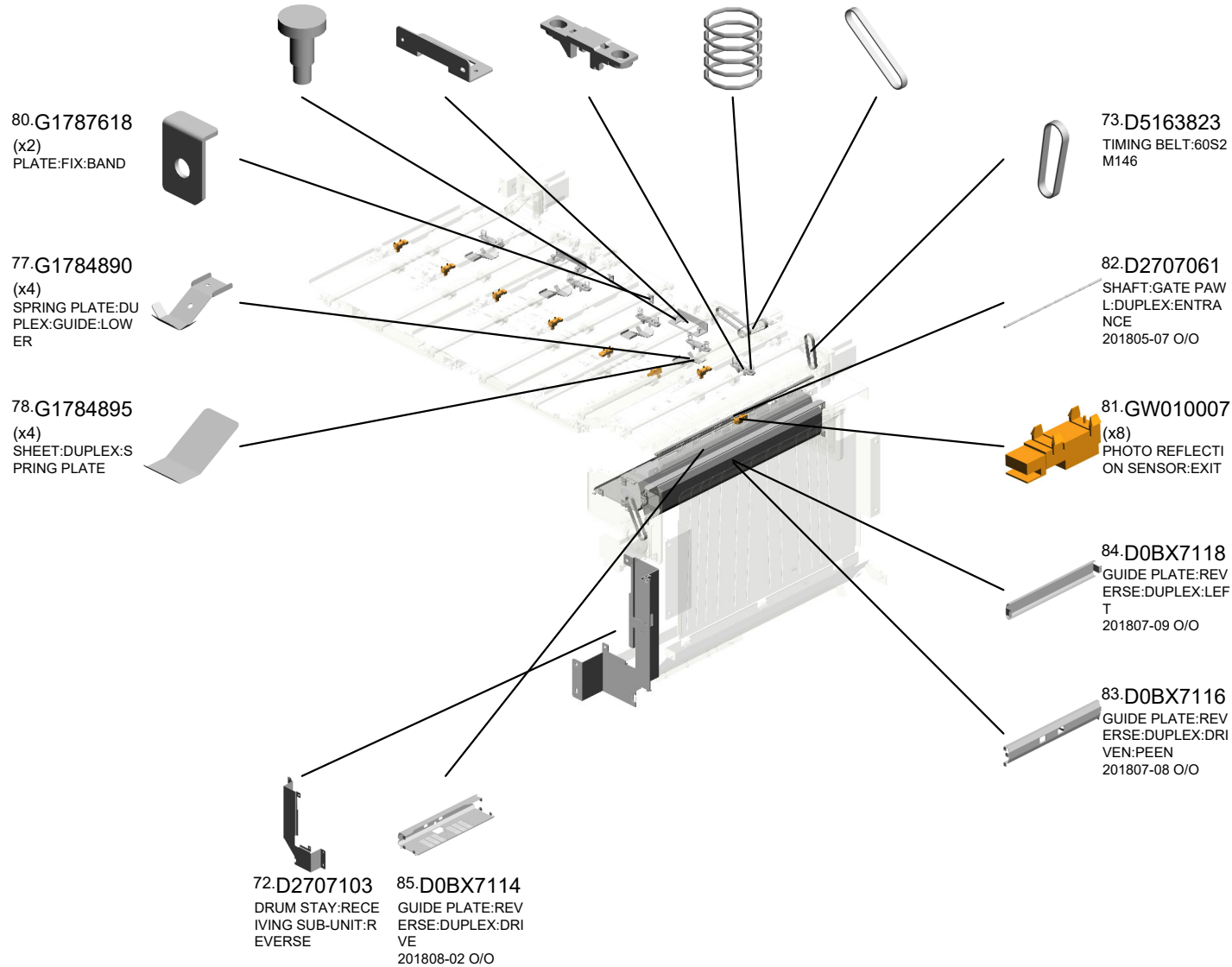
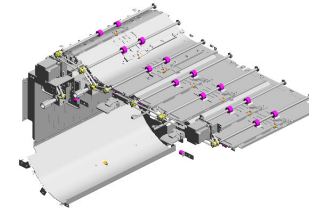

U017_S001
SHAFT:MISFEED REMOVAL:DUPLEX

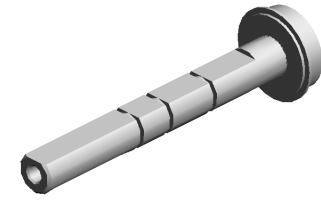

59.D1797083
SHAFT:MISFEED R
EMOVAL:DUPLEX

U001	U002	U003	U004	U005	U006	U007	U008	U009	U010	U011	U012	U013	U014	U015	U016	U017	U018	U019	U020	U021
------	------	------	------	------	------	------	------	------	------	------	------	------	------	------	------	------	------	------	------	------

U017_S002
TRANSPORT ROLLER:DUPLEX

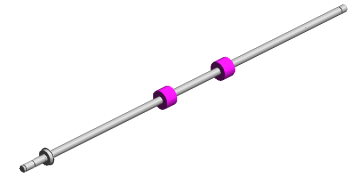

61.D1797085
TRANSPORT ROLLER:DUPLEX

U001	U002	U003	U004	U005	U006	U007	U008	U009	U010	U011	U012	U013	U014	U015	U016	U017	U018	U019	U020	U021
------	------	------	------	------	------	------	------	------	------	------	------	------	------	------	------	------	------	------	------	------

U017_S003
TRANSPORT ROLLER:DUPLEX

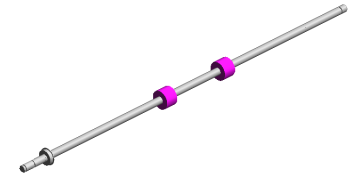

61.D1797085
TRANSPORT ROLL
ER:DUPLEX

U001	U002	U003	U004	U005	U006	U007	U008	U009	U010	U011	U012	U013	U014	U015	U016	U017	U018	U019	U020	U021
------	------	------	------	------	------	------	------	------	------	------	------	------	------	------	------	------	------	------	------	------

U017_S004
TRANSPORT ROLLER:DUPLEX

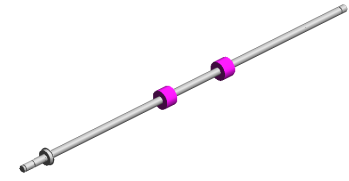

61.D1797085
TRANSPORT ROLL
ER:DUPLEX

U001	U002	U003	U004	U005	U006	U007	U008	U009	U010	U011	U012	U013	U014	U015	U016	U017	U018	U019	U020	U021
------	------	------	------	------	------	------	------	------	------	------	------	------	------	------	------	------	------	------	------	------

U017_S005
TRANSPORT ROLLER:DUPLEX

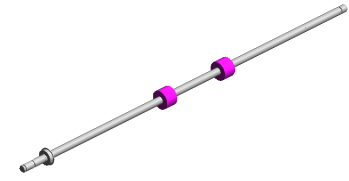

61.D1797085
TRANSPORT ROLL
ER:DUPLEX

U001	U002	U003	U004	U005	U006	U007	U008	U009	U010	U011	U012	U013	U014	U015	U016	U017	U018	U019	U020	U021
------	------	------	------	------	------	------	------	------	------	------	------	------	------	------	------	------	------	------	------	------

U017_S006
TRANSPORT ROLLER:DUPLEX

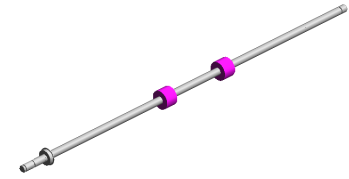

61.D1797085
TRANSPORT ROLL
ER:DUPLEX

U001	U002	U003	U004	U005	U006	U007	U008	U009	U010	U011	U012	U013	U014	U015	U016	U017	U018	U019	U020	U021
------	------	------	------	------	------	------	------	------	------	------	------	------	------	------	------	------	------	------	------	------

U017_S007
TRANSPORT ROLLER:DUPLEX

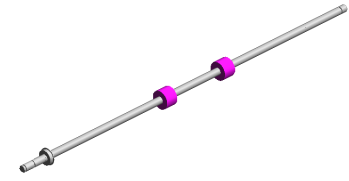

61.D1797085
TRANSPORT ROLL
ER:DUPLEX

U001	U002	U003	U004	U005	U006	U007	U008	U009	U010	U011	U012	U013	U014	U015	U016	U017	U018	U019	U020	U021
------	------	------	------	------	------	------	------	------	------	------	------	------	------	------	------	------	------	------	------	------

U017_S008
TRANSPORT ROLLER:DUPLEX

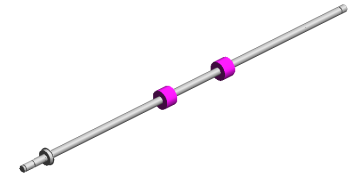

61.D1797085
TRANSPORT ROLL
ER:DUPLEX

U001	U002	U003	U004	U005	U006	U007	U008	U009	U010	U011	U012	U013	U014	U015	U016	U017	U018	U019	U020	U021
------	------	------	------	------	------	------	------	------	------	------	------	------	------	------	------	------	------	------	------	------

U017_S009
SHAFT:MISFEED REMOVAL:DUPLEX

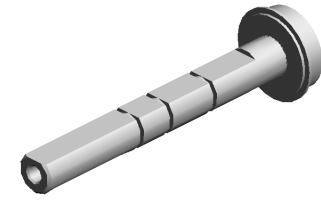

59.D1797083
SHAFT:MISFEED R
EMOVAL:DUPLEX

U001	U002	U003	U004	U005	U006	U007	U008	U009	U010	U011	U012	U013	U014	U015	U016	U017	U018	U019	U020	U021
------	------	------	------	------	------	------	------	------	------	------	------	------	------	------	------	------	------	------	------	------

U017_S010
TRANSPORT ROLLER:REVERSE:DUPLEX

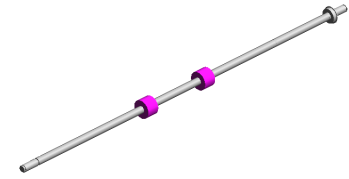

68.D1797120
TRANSPORT ROLL
ER:REVERSE:DUP
LEX

U001	U002	U003	U004	U005	U006	U007	U008	U009	U010	U011	U012	U013	U014	U015	U016	U017	U018	U019	U020	U021
------	------	------	------	------	------	------	------	------	------	------	------	------	------	------	------	------	------	------	------	------

U018.MAIN DRIVE

U018 S008
D1791300
DRIVE UNIT:FUSING:ASS'Y

U018 S001
D1791220
DRUM SHAFT:DRIVE:ASS'Y

U018 S002
D1791254
SHAFT:DRIVE:DEVELOPME
NT ROLLER:ASS'Y

U018 S009
D2701317
DRIVE SUB-UNIT:ON-OFF:PR
ESSURE ROLLER

U018 S007
D1791391
MECHANICAL DRIVE SECTIO
N:TRANSFER:SECOND:ASS'
Y

U018 S003
D1791262
SHAFT:DRIVE:CLEANER:ASS
'Y

U018 S004
D1791288
GEAR:IDLER:CLEANER:49Z/
33Z

U018 S005
D1791289
GEAR:PULLEY:DRUM:113Z/3
7T

U018 S006
D1791290
GEAR:IDLER:TRANSPORT S
CREW:65Z/53Z

U001	U002	U003	U004	U005	U006	U007	U008	U009	U010	U011	U012	U013	U014	U015	U016	U017	U018	U019	U020	U021
------	------	------	------	------	------	------	------	------	------	------	------	------	------	------	------	------	------	------	------	------

U018 MAIN DRIVE

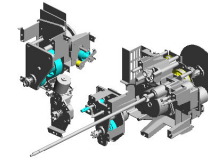

- 20.11050601 (x3) CLAMP:LWSM-051 1-2M
- 23.A0793626 (x2) STEPPED SCREW - SWING CLEANING
- 22.11050724 CLAMPS:WES-121 0
- 4.03604008N (x22) SCREW - M4X8
- 10.07403012 BALL BEARING - 1 2X28X8

19.11050511
HARNESS CLAMP - LWS-0306ZC



26.D0741454
DC MOTOR:DIA49: 9.8W:BLS



8.07200040E
RETAINING RING - M4



18.11050487 (x3) HARNESS CLAMP



17.11050410 (x2) CARD SPACER - 9.4MM

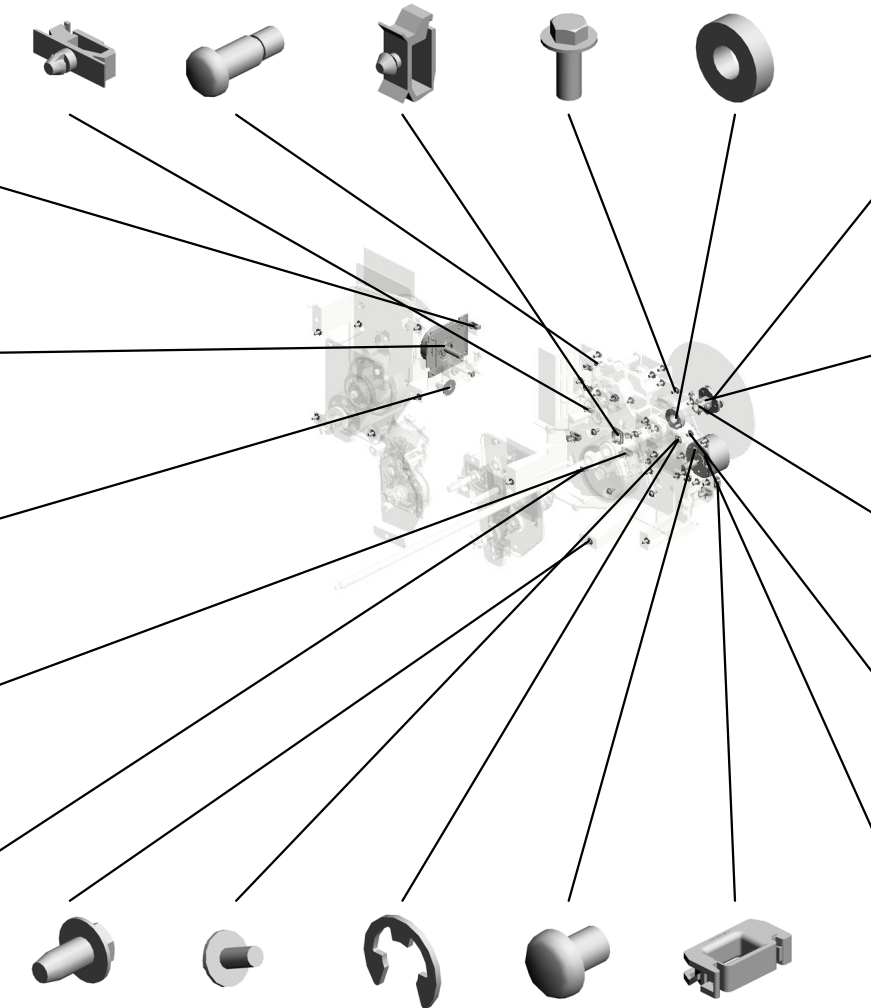

5.04514008N (x 4)
TAPPING SCREW:4X8



16.09545010N
SCREW:POLISHED ROUND/SPRING:M 5X10



24.B2341118
FLY WHEEL FLANGE



14.09514020N
SCREW - M4X20



15.09544008N (x9)
SCREW - M4X8



25.D0741329
DC MOTOR:DIA49: 24V:6.3W

5.04514008N (x11)
TAPPING SCREW: 4X8

2.03603006N (x9)
SCREW - M3X6

9.07200060E
RETAINING RING - M6

1.03130040N (x3)
SCREW:M3X4

21.11050723
CLAMPS:WES-050 7

U018 MAIN DRIVE

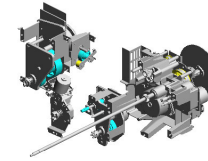

- 43.D1791275 TENSION SPRING: 3.8N
- 53.D1791297 TIGHTENER:DRIVE :DEVELOPMENT:ASSY
- 37.D1791266 PULLEY:DRIVE:DEVELOPMENT ROLLER:59T
- 35.D1791264 PLATE:HOLDER:RADIAL BALL BEARING
- 33.D1791258 PLATE:HOLDER:ANTISTATIC BRUSH:DRUM

42.D1791273
GEAR:DRIVE:TRANSPORT SCREW:54Z



32.D1791256
SHAFT:DRIVE:TRANSPORT SCREW:ASSY



39.D1791268
SYNCHRONOUS BELT:80S2M300



46.D1791278
HOLDER:BEARING:DRUM SHAFT



30.D1791252
DC MOTOR:DIA82.2:63.7W:BRUSHLESS



38.D1791267
SYNCHRONOUS BELT:120S2M316



29.D1791251
DC MOTOR:DIA63:29.7W:BRUSHLESS



44.D1791276
TENSION SPRING: 3.6N



52.D1791293
TIGHTENER:DRIVE:DRUM:ASSY



40.D1791269
BRACKET:DC MOTOR:CLEANING DRIVE SUB-UNIT



41.D1791271
SPACER:SHAFT:DRUM



36.D1791265
PULLEY:DRIVE:DRUM:107T



51.D1791291
BRACKET:DC MOTOR:DRUM:ASSY



45.D1791277
GEAR:DRIVE:CLEANER:39Z



47.D1791286
BRACKET:DRIVE:CLEANER:ASSY



U018 MAIN DRIVE

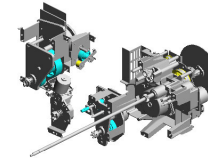

- 60.D1791328 GEAR:PULLEY:Z67 /T19:DRIVE:USED TONER
- 58.D1791326 BRACKET:BELT TENSIONER:DRIVE:USED TONER
- 57.D1791323 TENSION SPRING: BELT TENSIONER: DRIVE:USED TONER

- 56.D1791320 BRACKET:DRIVE:USED TONER

- 59.D1791327 SHAFT:BELT TENSIONER:DRIVE:USED TONER

- 61.D1791329 PULLEY:TIGHTENER:DIA18

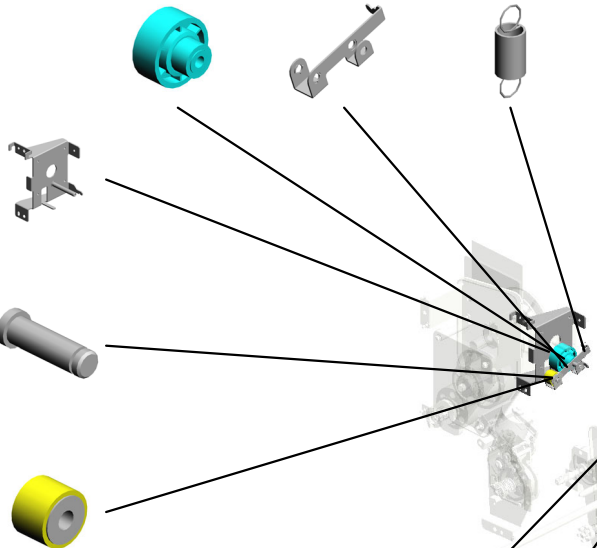

- 68.G0291980 DECAL - LD

- 70.G1781289 FLY WHEEL:DRUM

- 73.MOB11328 ANTISTATIC BRUSH:DRUM 201904-06 X/O

- 62.D1791345 BRACKET:DRAWER:DEVELOPMENT
- 72.G1781307 JOINT:DEVELOPMENT ROLLER:DRIVE
- 71.G1781291 JOINT:TRANSPORT SCREW:NO.2

U018_S001
DRUM SHAFT:DRIVE:ASS'Y

10.07403012
BALL BEARING - 1
2X28X8

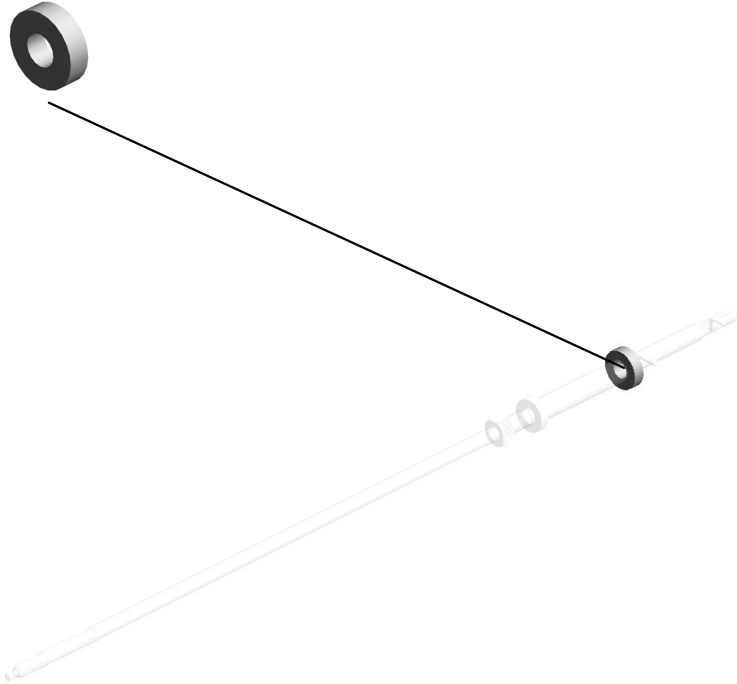

28.D1791220
DRUM SHAFT:DRIVE:ASS'Y

U001	U002	U003	U004	U005	U006	U007	U008	U009	U010	U011	U012	U013	U014	U015	U016	U017	U018	U019	U020	U021
------	------	------	------	------	------	------	------	------	------	------	------	------	------	------	------	------	-------------	------	------	------

U018_S002

SHAFT:DRIVE:DEVELOPMENT ROLLER:ASS'Y

11.07403808
BALL BEARING - 8
X16X5MM

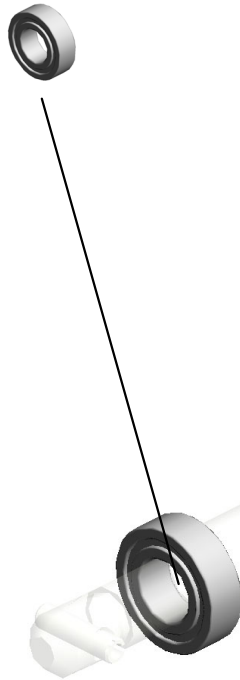

31.D1791254
SHAFT:DRIVE:DEV
ELOPMENT ROLLE
R:ASS'Y

7.06230160E
SPRING PIN - 3X16
MM

U001	U002	U003	U004	U005	U006	U007	U008	U009	U010	U011	U012	U013	U014	U015	U016	U017	U018	U019	U020	U021
------	------	------	------	------	------	------	------	------	------	------	------	------	------	------	------	------	------	------	------	------

U018_S003
SHAFT:DRIVE:CLEANER:ASS'Y

11.07403808
BALL BEARING - 8
X16X5MM

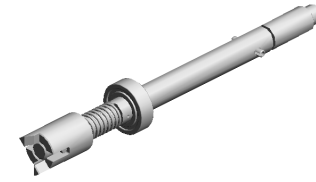

34.D1791262
SHAFT:DRIVE:CLE
ANER:ASS'Y

U001	U002	U003	U004	U005	U006	U007	U008	U009	U010	U011	U012	U013	U014	U015	U016	U017	U018	U019	U020	U021
------	------	------	------	------	------	------	------	------	------	------	------	------	------	------	------	------	-------------	------	------	------

U018_S004
GEAR:IDLER:CLEANER:49Z/33Z

11.07403808
(x2)
BALL BEARING - 8
X16X5MM

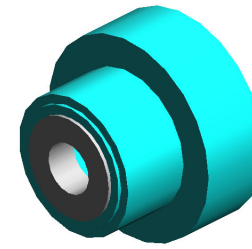
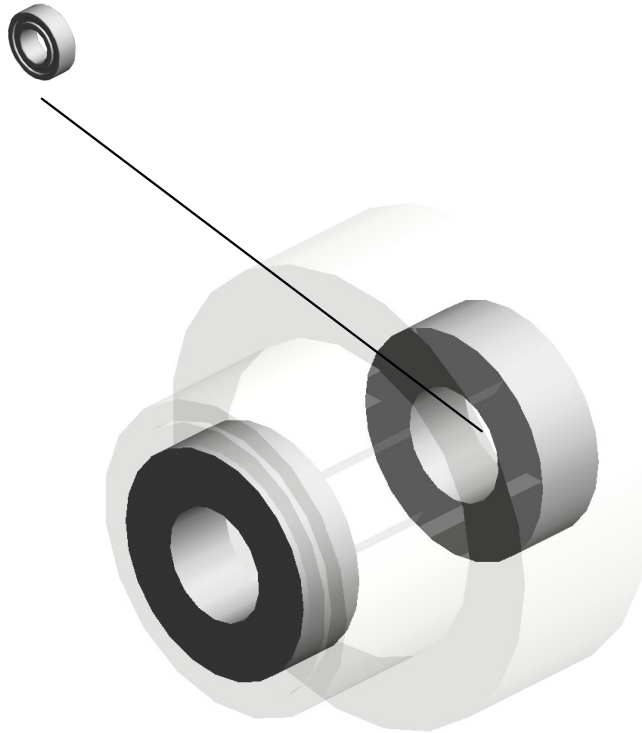

48.D1791288
GEAR:IDLER:CLEA
NER:49Z/33Z

U001	U002	U003	U004	U005	U006	U007	U008	U009	U010	U011	U012	U013	U014	U015	U016	U017	U018	U019	U020	U021
------	------	------	------	------	------	------	------	------	------	------	------	------	------	------	------	------	------	------	------	------

U018_S005
GEAR:PULLEY:DRUM:113Z/37T

11.07403808
BALL BEARING - 8
X16X5MM

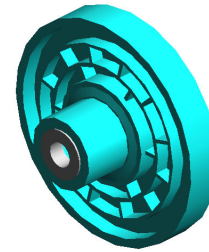

49.D1791289
GEAR:PULLEY:DR
UM:113Z/37T

U001	U002	U003	U004	U005	U006	U007	U008	U009	U010	U011	U012	U013	U014	U015	U016	U017	U018	U019	U020	U021
------	------	------	------	------	------	------	------	------	------	------	------	------	------	------	------	------	------	------	------	------

U018_S006
GEAR:IDLER:TRANSPORT SCREW:65Z/53Z

11.07403808
(x2)
BALL BEARING - 8
X16X5MM

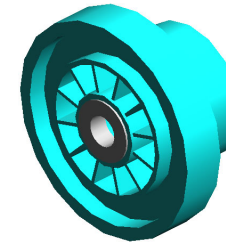

50.D1791290
GEAR:IDLER:TRANSPORT SCREW:65Z/53Z

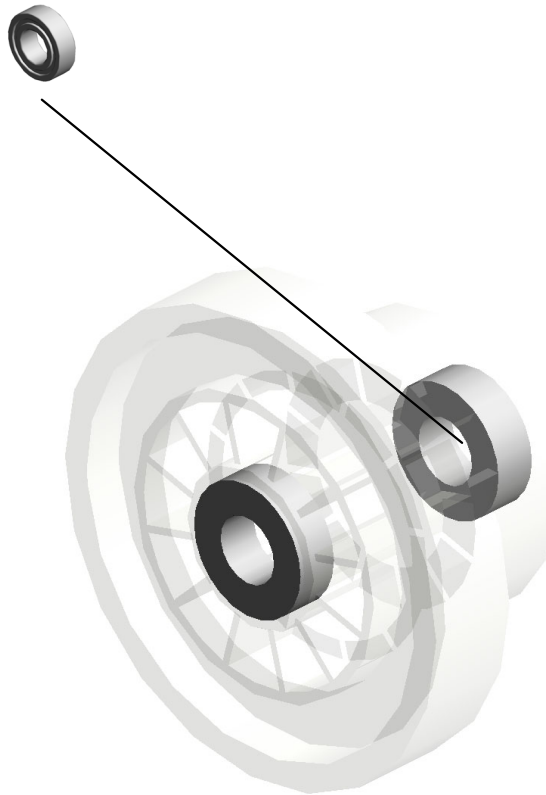

U001	U002	U003	U004	U005	U006	U007	U008	U009	U010	U011	U012	U013	U014	U015	U016	U017	U018	U019	U020	U021
------	------	------	------	------	------	------	------	------	------	------	------	------	------	------	------	------	------	------	------	------

U018_S007
 MECHANICAL DRIVE SECTION:TRANSFER:SECOND:ASS'Y

11.07403808 BALL BEARING - 8 X16X5MM
 7.06230160E SPRING PIN - 3X16 MM
 64.D1791375 GEAR.IDLER:BELT CLEANING

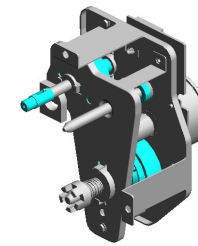

65.D1791391
 MECHANICAL DRIVE SECTION:TRANSFER:SECOND:ASS'Y

75.D0BX6411
 SEAL:TONER OUTLET SUB-UNIT
 202111-01 O/O

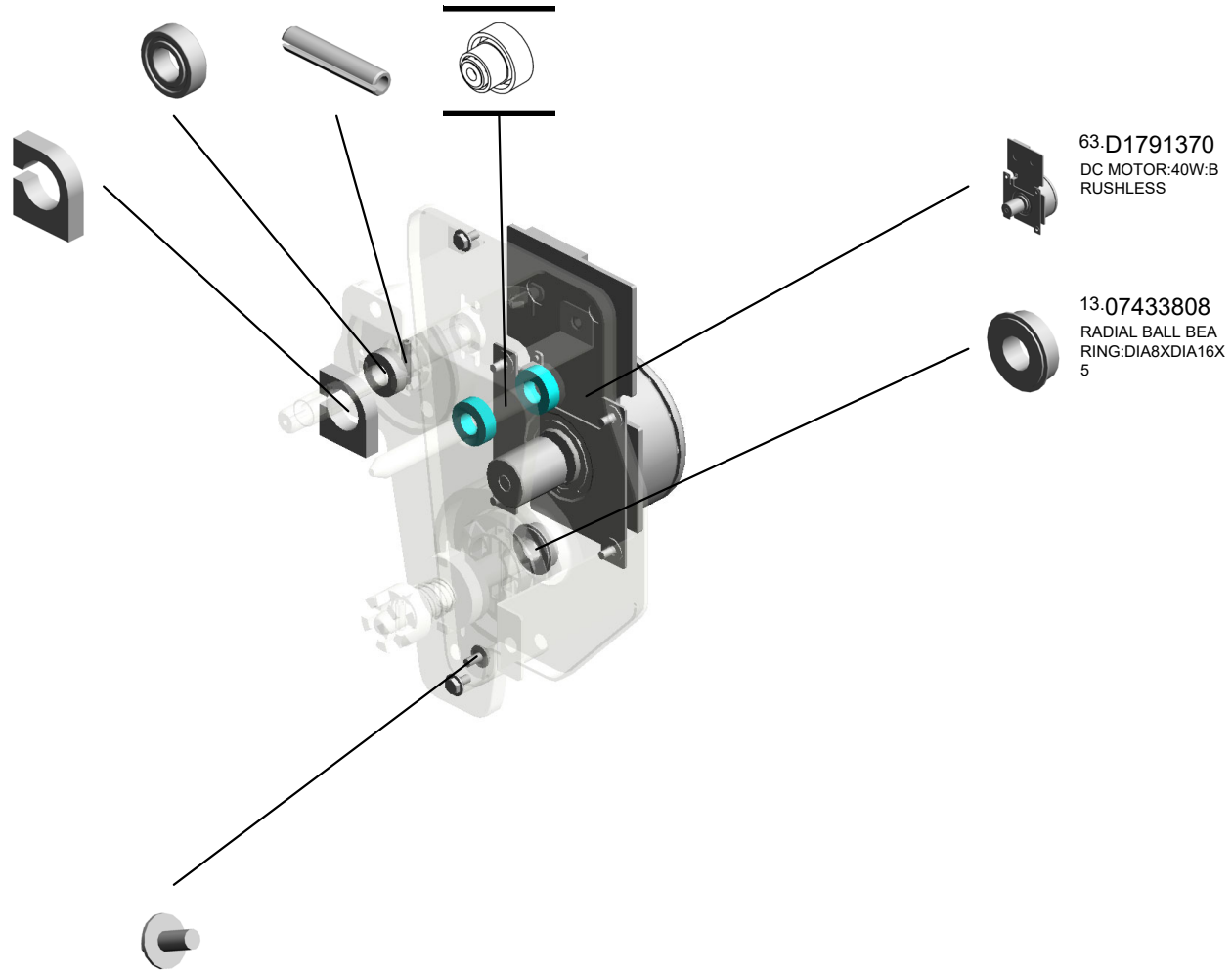

63.D1791370
 DC MOTOR:40W:BRUSHLESS

13.07433808
 RADIAL BALL BEARING: DIA8XDIA16X5

2.03603006N
 (x7)
 SCREW - M3X6

U001	U002	U003	U004	U005	U006	U007	U008	U009	U010	U011	U012	U013	U014	U015	U016	U017	U018	U019	U020	U021
------	------	------	------	------	------	------	------	------	------	------	------	------	------	------	------	------	------	------	------	------

U018_S008
DRIVE UNIT:FUSING:ASS'Y

55.D1791309
DC BRUSHLESS M
OTOR:58W:DRIVE:
FUSING UNIT

3.03604006N
(x7)
SCREW - M4X6

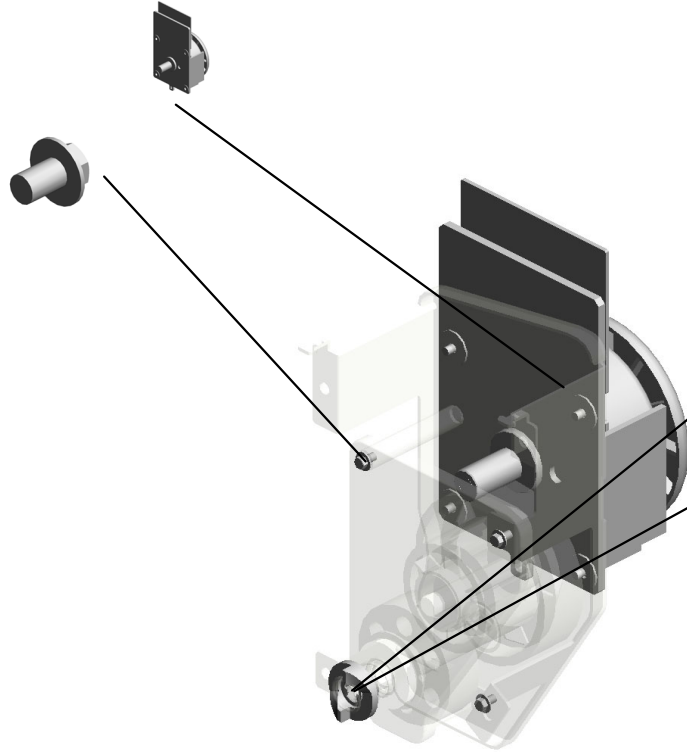

9.07200060E
RETAINING RING -
M6

74.D1791316
JOINT:DRIVE:FUSI
NG

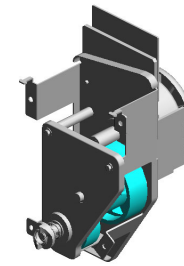

54.D1791300
DRIVE UNIT:FUSIN
G:ASS'Y

U001	U002	U003	U004	U005	U006	U007	U008	U009	U010	U011	U012	U013	U014	U015	U016	U017	U018	U019	U020	U021
------	------	------	------	------	------	------	------	------	------	------	------	------	------	------	------	------	------	------	------	------

U018_S009
DRIVE SUB-UNIT:ON-OFF:PRESSURE ROLLER

6.04523010N 12.07433806
(x4) (x2)
BINDING SELF-TAPPING SCREW:3X10
RADIAL BALL BEARING RING:DIA6XDIA13X5

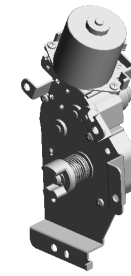

67.D2701317
DRIVE SUB-UNIT:ON-OFF:PRESSURE ROLLER

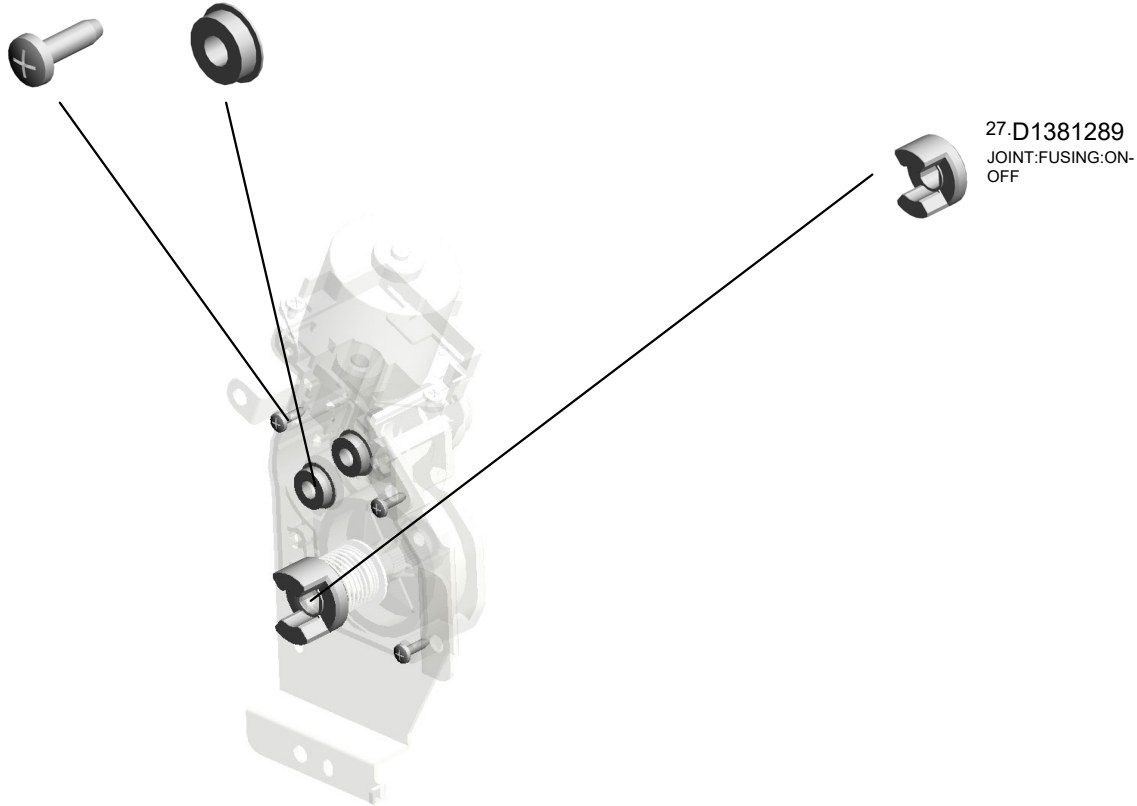

U001	U002	U003	U004	U005	U006	U007	U008	U009	U010	U011	U012	U013	U014	U015	U016	U017	U018	U019	U020	U021
------	------	------	------	------	------	------	------	------	------	------	------	------	------	------	------	------	------	------	------	------

U019 ELECTRICAL

- 2.03603006N (x23) SCREW - M3X6
- 18.11050511 (x3) HARNESS CLAMP - LWS-0306ZC
- 4.03604008N SCREW - M4X8
- 20.11050529 NYLON CLAMP-EM T-3N
- 9.04544008Q (x5) TAPPING SCREW - M4X8

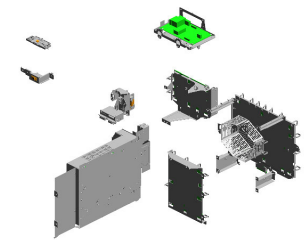

- 14.11050410 (x8) CARD SPACER - 9.4MM

- 15.11050487 (x10) HARNESS CLAMP

- 7.04514008N (x30) TAPPING SCREW: 4X8

- 6.04503008N (x3) TAPPING SCREW - M3X8

- 5.04340200N (x2) PAN SELF-TAPPING SCREW: 4X20

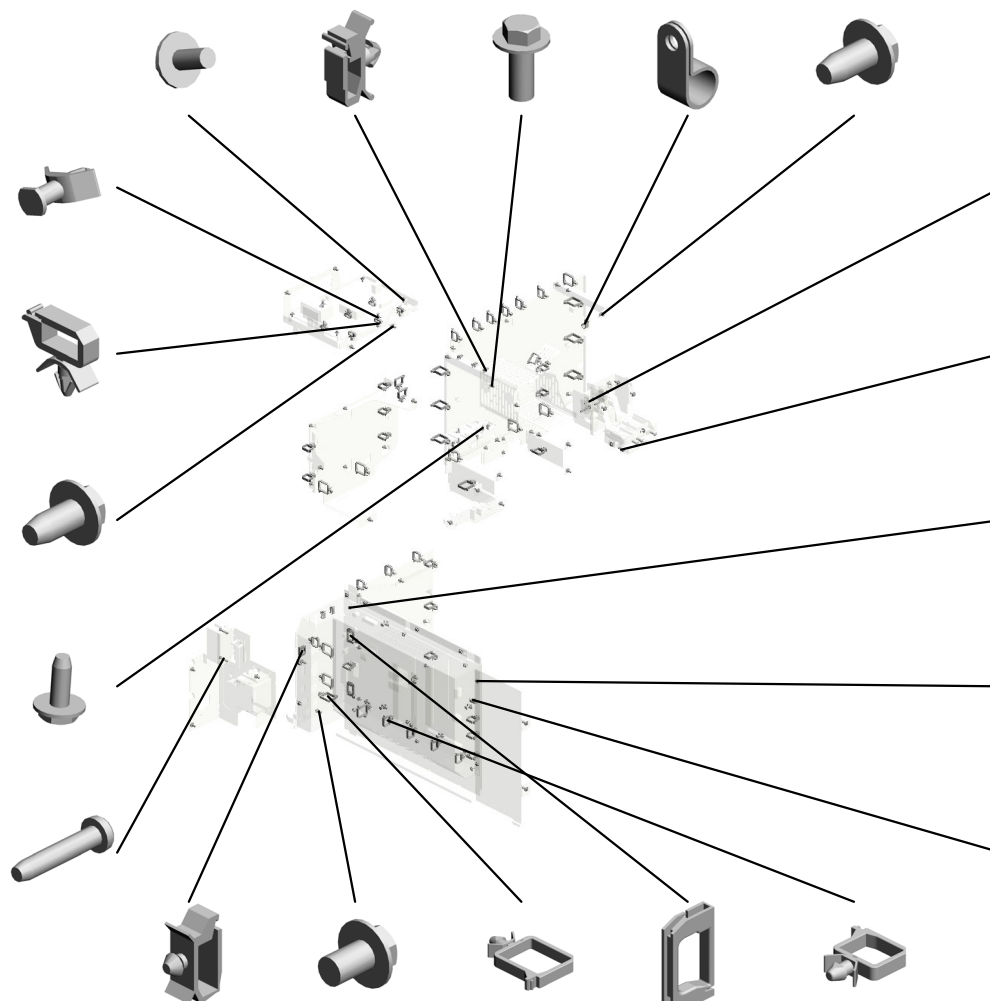

- 13.09543025N (x4) SCREW: POLISHED ROUND/SPRING: M3X25

- 1.03140120N (x4) SCREW - M4X12

- 12.09543008N (x6) SCREW - M3X8

- 8.04543006Q (x21) TAPPING SCREW - M3X6

- 19.11050516 (x3) CLAMP



- 11.08010234 SCREW WITH WASHER: SMALL ROUND WITH SPRING WASHER: M5X8



- 15.11050487 (x3) HARNESS CLAMP



- 17.11050490 HARNESS CLAMP - IWS-2218



- 19.11050516 (x6) CLAMP

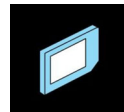

- 47.D0745101 SD-CARD:NICE:REGI2:ASS'Y 201704-04

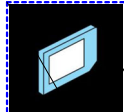

- 48.D2605100 SD-CARD:NICE:APPLICATION:ASS'Y 201808-07

- 21.11050724 CLAMPS:WES-1210

- 3.03604006N (x4) SCREW - M4X6

- 17.11050490 (x17) HARNESS CLAMP - IWS-2218

- 22.11050725 (x2) CLAMPS:WES-1117

- 16.11050489 (x28) HARNESS CLAMP - LWS 1316

- 7.04514008N (x 7) TAPPING SCREW: 4X8
- 8.04543006Q (x 2) TAPPING SCREW - M3X6

U019 ELECTRICAL

- 26.AZ320193 POWER PACK:CG B
- 29.D1495883 KEYTOP:MAIN SWITCH
- 31.D1791553 COVER:DC_SW
- 32.D1791557 BRACKET:DC_SW
- 25.AA143797 (x2) CONNECTOR GUI DE PIN

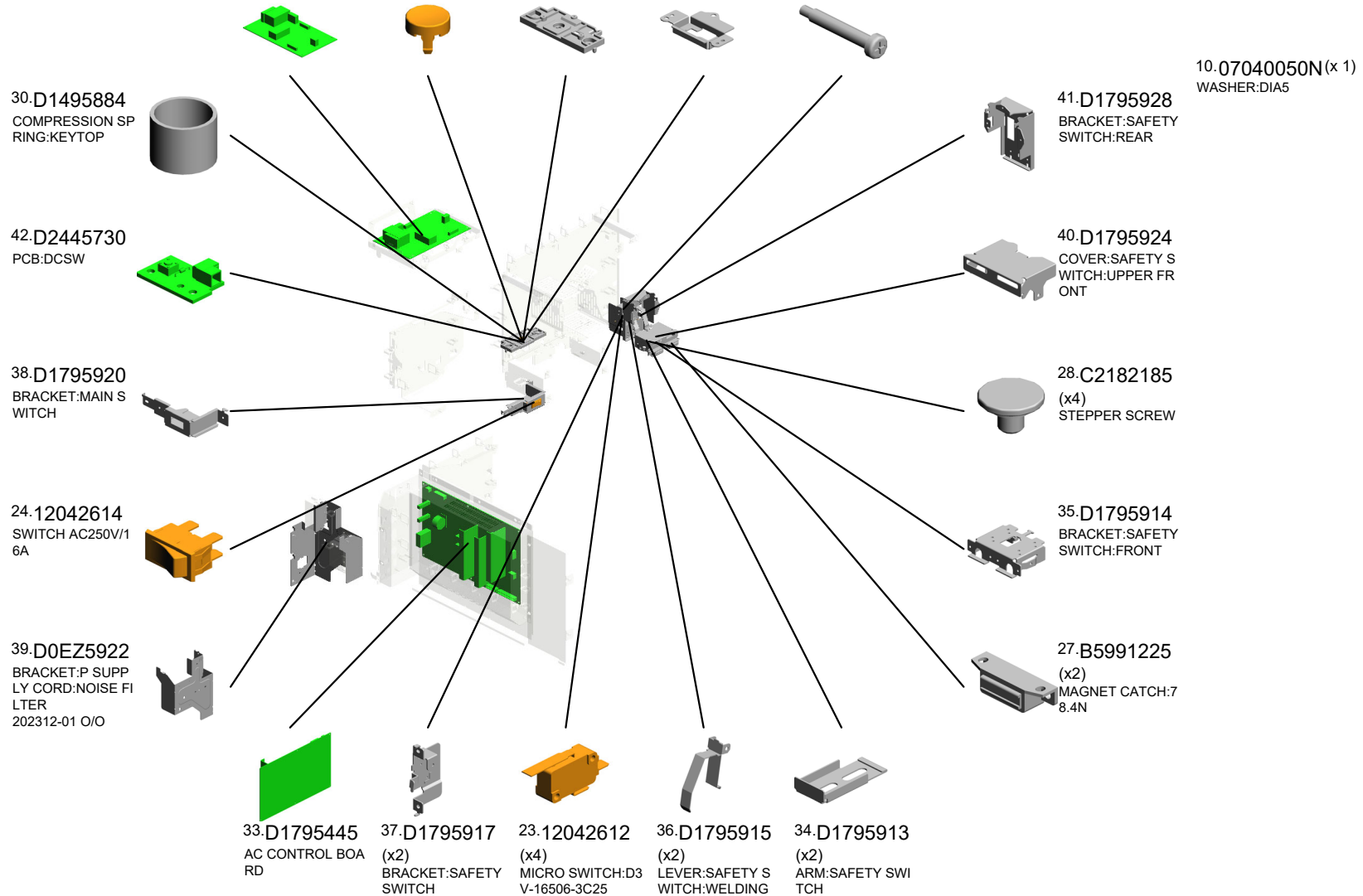
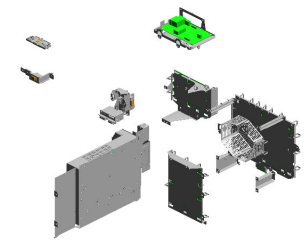

U001	U002	U003	U004	U005	U006	U007	U008	U009	U010	U011	U012	U013	U014	U015	U016	U017	U018	U019	U020	U021
------	------	------	------	------	------	------	------	------	------	------	------	------	------	------	------	------	------	------	------	------

U019 ELECTRICAL

49.11071280 44.D2705415 43.D2705406
(D270/D271):FUSE: PCB:EDRB PCB:IOB
BJS1512F2

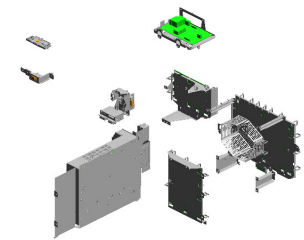

50.11071281
(D272):FUSE: BJS2
012F2

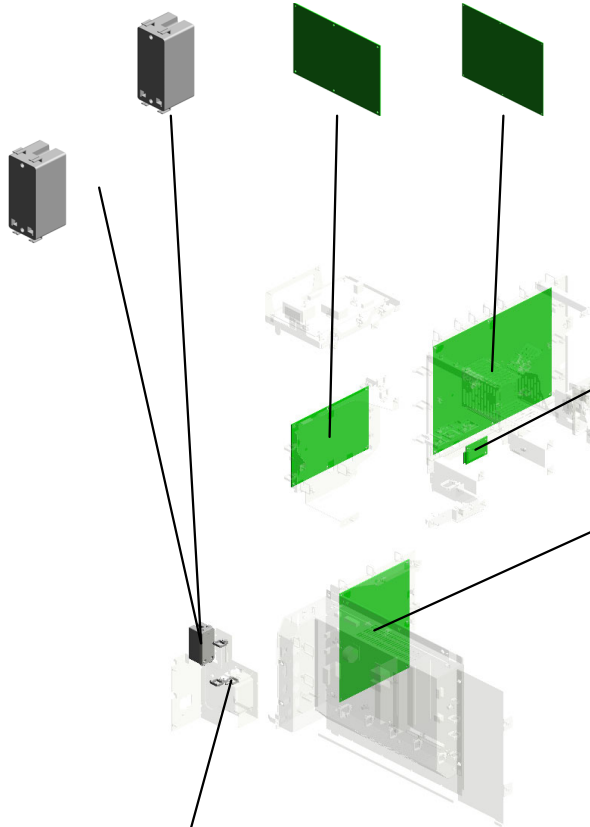

46.M2055332
PCB:SDCB

45.D2705427
PCB:RYB

51.11050488
(x3)
HARNESS CLAMP
201810-01 X/O

U001	U002	U003	U004	U005	U006	U007	U008	U009	U010	U011	U012	U013	U014	U015	U016	U017	U018	U019	U020	U021
------	------	------	------	------	------	------	------	------	------	------	------	------	------	------	------	------	------	------	------	------

U020.CONTROLLER

U020 S003
D1795059
HDD:ASS'Y

U020 S001
D1795089
COVER:C/T BOX:UPPER:ASS
Y

U020 S002
AZ240355
POWER SUPPLY UNIT:ECO

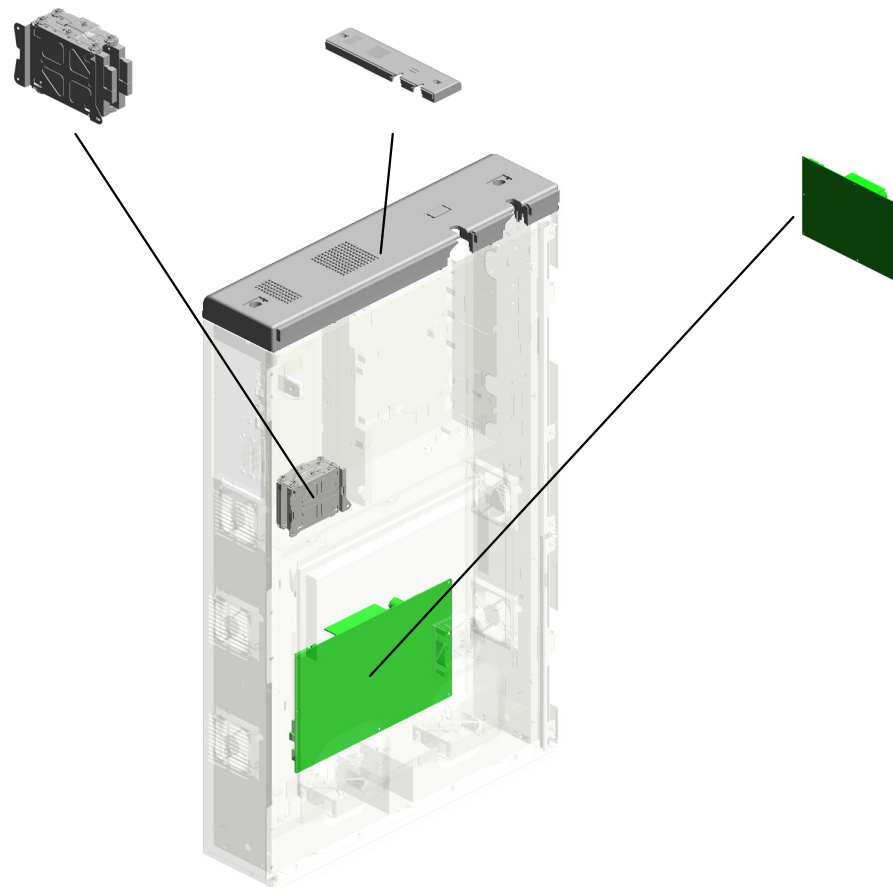

U001	U002	U003	U004	U005	U006	U007	U008	U009	U010	U011	U012	U013	U014	U015	U016	U017	U018	U019	U020	U021
------	------	------	------	------	------	------	------	------	------	------	------	------	------	------	------	------	------	------	------	------

U020 CONTROLLER

- 27.D1365709 PCB:EX3_DDR3-DI
MM:RC-A:2GB:ASS'
Y
- 18.B0706849 GUIDE:POSITIONI
NG
- 14.14077899 EEPROM:BR24T25
6-W
- 28.D1365725 PCB:IMAGE PROC
ESSING UNIT:TYP
E-S15MDA-SUB
- 8.11050489 (x18)
HARNESS CLAMP -
LWS 1316



- 26.D0895887 (x2)
PANEL:INTERFAC
E

- 20.D0145973 COVER:SD-CARD

- 17.AZ250066 POWER SUPPLY U
NIT:864W

- 1.03604006N (x4)
SCREW - M4X6

- 3.04543006Q (x101)
TAPPING SCREW -
M3X6

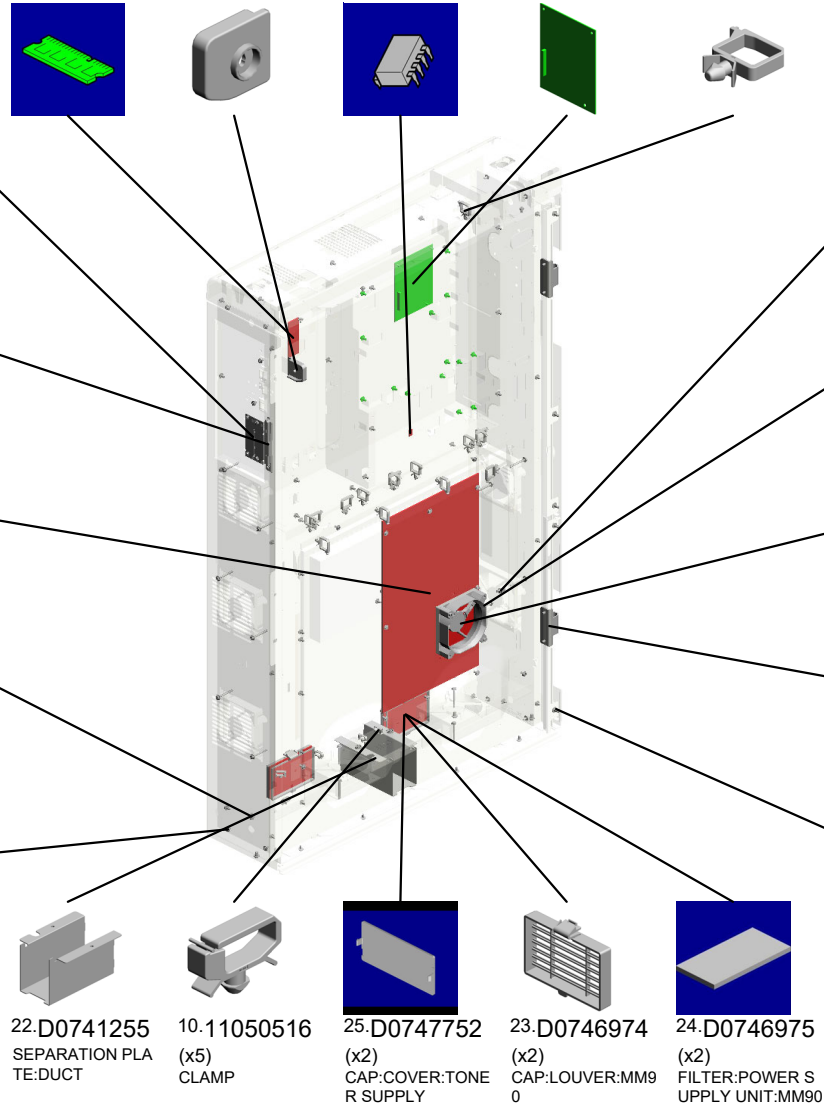

- 9.11050511 HARNESS CLAMP -
LWS-0306ZC

- 4.04543030Q (x16)
TAPPING SCREW:
ROUND POINT:3X3
0

- 19.B2591106 FAN MOTOR:MM80
:DC24V 3.6W

- 21.D0741250 (x2)
ARM:HINGE:C/T B
OX

- 5.04544008Q (x11)
TAPPING SCREW -
M4X8

- 8.11050489 (x19)
HARNESS CLAMP -
LWS 1316
- 10.11050516 (x23)
CLAMP

- 11.11050529 NYLON CLAMP-EM
T-3N
- 12.11050559 (x2)
CLAMP:EMT-5N

- 13.11050724 CLAMPS:WES-121
0

- 2.04514008N(x18)
TAPPING SCREW:4X8
- 3.04543006Q(x12)
TAPPING SCREW - M3X6

- 22.D0741255 SEPARATION PLA
TE:DUCT
- 10.11050516 (x5)
CLAMP
- 25.D0747752 (x2)
CAP:COVER:TONE
R SUPPLY
- 23.D0746974 (x2)
CAP:LOUVER:MM9
0
- 24.D0746975 (x2)
FILTER:POWER S
UPPLY UNIT:MM90

U020 CONTROLLER



- 45.D2705723 (D270-NA(57)):SERVICE PARTS:PCB:CTL:ASSY
- 53.D2705717 (D271):SERVICE PARTS:PCB:CTL:ASSY 201806-02 O/O
- 54.D2705718 (D272):SERVICE PARTS:PCB:CTL:ASSY 201806-03 O/O
- 34.D1795956 COVER:PCB:C/T BOX
- 33.D1795725 PCB:IMAGE PROCESSING UNIT

29.D1495776
COVER:USB:SMALL

55.D2705716
(D270-NA(17),CHN,EU,AA,TWN,KOR):SERVICE PARTS:PCB:CTL:ASSY 201807-10 O/O

49.G1335793
RAIL:RIGHT

48.D2709590
NVRAM

50.G1335794
RAIL:LEFT

47.D2705975
(x2)
FILTER:COVER:C/T BOX

57.AZ240356
POWER SUPPLY UNIT:FW 201910-02 X/O

36.D1795964
COVER:C/T BOX:LOWER

46.D2705960
COVER:POWER SUPPLY UNIT:C/T BOX

32.D1795440
PCB:CNB

52.D2705451
PCB:BCU:ASSY 201806-01 X/O

35.D1795961
COVER:C/T BOX

40.D2701787
DUCT:POWER SUPPLY UNIT:PAPER FEED:COOLING

51.GX640024
(x7)
FAN MOTOR - DC 3.12W

5.04544008Q(x 3)
TAPPING SCREW - M4X8
6.09503006N(x 1)
SCREW:SPRING WASHER:M3X6

U020_S001
COVER:C/T BOX:UPPER:ASS'Y

37.D1795966
SEAL:COVER:C/T
BOX:UPPER:A

38.D1795967
SEAL:COVER:C/T
BOX:UPPER:B

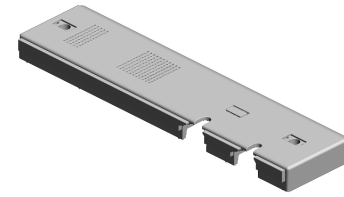

31.D1795089
COVER:C/T BOX:U
PPER:ASS'Y

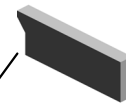

39.D1795973
SEAL:COVER:C/T
BOX:UPPER:C

U001	U002	U003	U004	U005	U006	U007	U008	U009	U010	U011	U012	U013	U014	U015	U016	U017	U018	U019	U020	U021
------	------	------	------	------	------	------	------	------	------	------	------	------	------	------	------	------	------	------	------	------

U020_S002
POWER SUPPLY UNIT:ECO

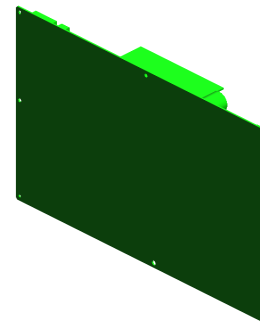

56.AZ240355
[A]
POWER SUPPLY U
NIT:ECO
201910-01 X/O

7.09543008N(x 2)
SCREW - M3X8



AZ240309
[A]
POWER SUPPLY U
NIT:ECO:456.4W
201910-01 X/O

U001	U002	U003	U004	U005	U006	U007	U008	U009	U010	U011	U012	U013	U014	U015	U016	U017	U018	U019	U020	U021
------	------	------	------	------	------	------	------	------	------	------	------	------	------	------	------	------	------	------	------	------

U020_S003
HDD:ASS'Y

3.04543006Q
(x2)
TAPPING SCREW -
M3X6

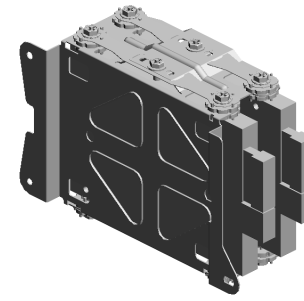
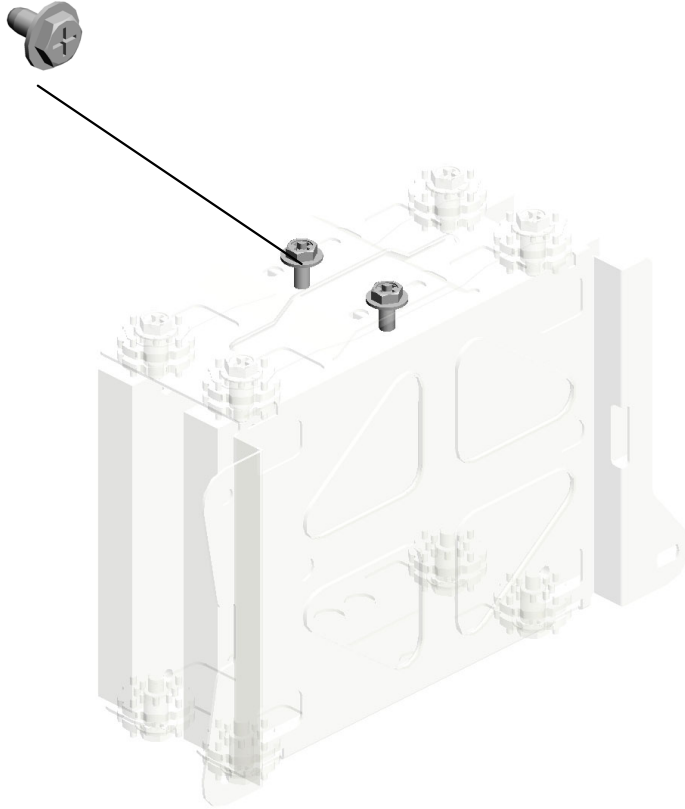

30.D1795059
HDD:ASS'Y

U001	U002	U003	U004	U005	U006	U007	U008	U009	U010	U011	U012	U013	U014	U015	U016	U017	U018	U019	U020	U021
------	------	------	------	------	------	------	------	------	------	------	------	------	------	------	------	------	------	------	------	------

U021.AIR COOLING

U021 S002
D1806811
DUCT:FLAT CONVEYER BELT:EXHAUST:CONNECTING:ASSY

U021 S001
D1796836
DUCT:CHARGE CORONA:CONNECTING:LOWER:ASSY

U021 S003
D1796987
DUCT:HEAT PIPE:ENTRANCE:ASSY

U021 S004
D2706942
BRACKET:FAN:SIDE:RIGHT:SUB-ASSY

U021 S005
D1796963
BRACKET:HEAT SHIELD:BELT CLEANING:ASSY

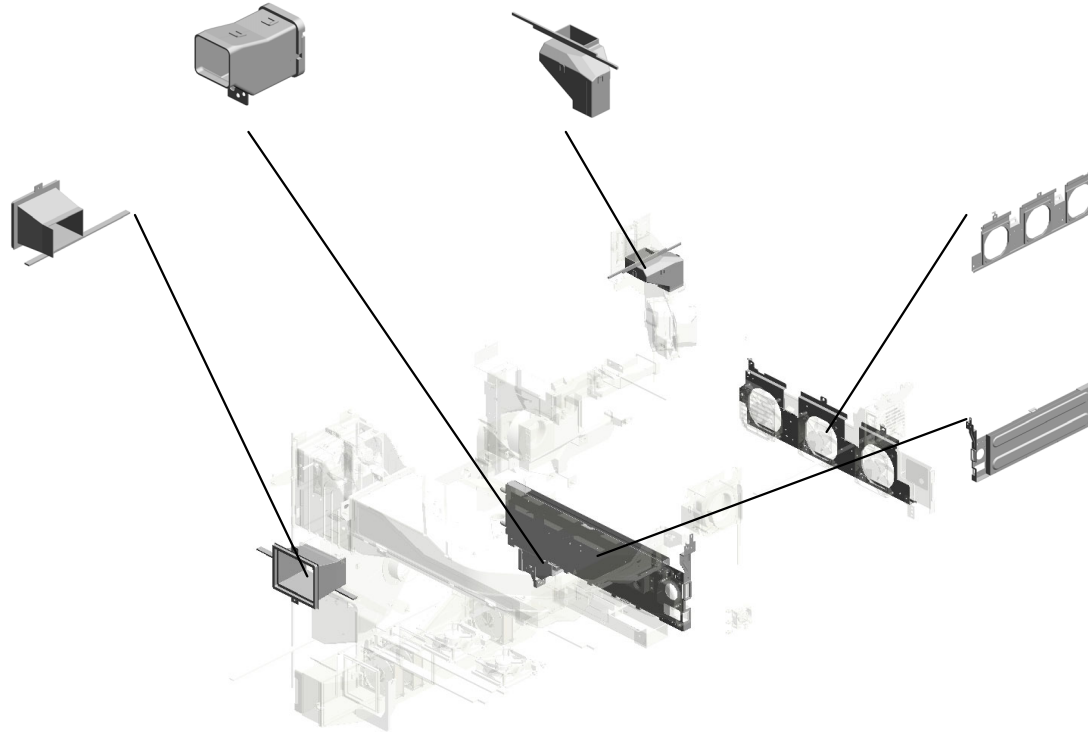

U001	U002	U003	U004	U005	U006	U007	U008	U009	U010	U011	U012	U013	U014	U015	U016	U017	U018	U019	U020	U021
------	------	------	------	------	------	------	------	------	------	------	------	------	------	------	------	------	------	------	------	------

U021 AIR COOLING

19.AW100107 THERMISTOR
 11.11050328 HARNESS CLAMP - ES-0505
 7.04513006N (x13) TAPPING SCREW - 3X6
 16.11050532 EDGE SADDLE - L ES-25L
 5.03604008N SCREW - M4X8

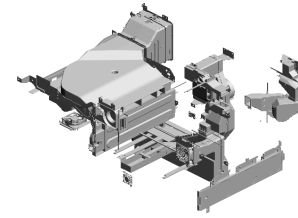

1.03530060N
 BIND SCREW - M3 X6

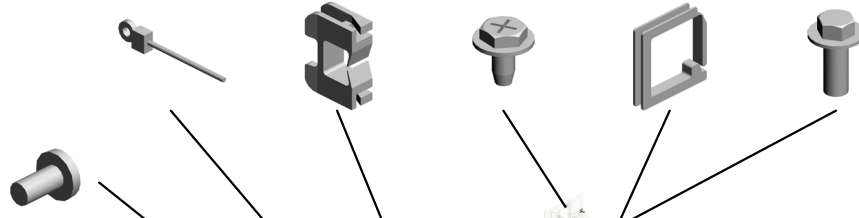

13.11050490
 (x3)
 HARNESS CLAMP - IWS-2218



6.04503008N
 (x33)
 TAPPING SCREW - M3X8



10.04514008N
 (x40)
 TAPPING SCREW: 4X8



9.04513030N
 (x4)
 TAPPING SCREW: 3X30



20.AX640224
 (x7)
 DC FAN MOTOR:A XIAL:MM80

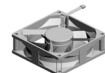

3.03603020N
 (x4)
 SCREW:M3X20



18.11050723
 CLAMPS:WES-050 7



12.11050487
 HARNESS CLAMP



8.04513020N
 (x2)
 TAPPING SCREW: 3X20



17.11050692
 (x4)
 CLAMP:LES-0503



14.11050511
 (x32)
 HARNESS CLAMP - LWS-0306ZC

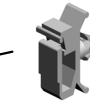

4.03603030N
 (x8)
 SCREW:M3X30



2.03540400N
 (x8)
 SCREW:M4X40



15.11050516
 (x2)
 CLAMP



12.11050487
 HARNESS CLAMP

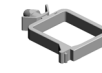

13.11050490
 (x4)
 HARNESS CLAMP - IWS-2218



14.11050511
 (x4)
 HARNESS CLAMP - LWS-0306ZC

6.04503008N(x 1)
 TAPPING SCREW - M3X8
 7.04513006N(x 6)
 TAPPING SCREW - 3X6
 10.04514008N(x21)
 TAPPING SCREW:4X8
 108.03603006N(x 5)
 SCREW - M3X6

U021 AIR COOLING

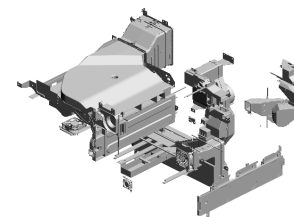

- 31.D1796835 EXTERIOR:LOUVER:CHARGE CORONA
- 35.D1796842 FILTER:CHARGE CORONA:VACUUM
- 34.D1796841 DUCT:CHARGE CORONA:VACUUM:CONNECTING:UPPER
- 33.D1796840 BRACKET:DUCT:CHARGE CORONA:VACUUM:UPPER
- 38.D1796846 DUCT:CHARGE CORONA:VACUUM:LOWER LEFT

37.D1796845
DUCT:CHARGE CORONA:VACUUM:LOWER RIGHT

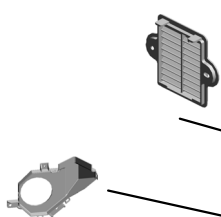

36.D1796844
BRACKET:DUCT:CHARGE CORONA:VACUUM



30.D1796834
SEAL:DUCT:DEVELOPMENT:EXHAUST:REAR RIGHT



28.D1796831
DUCT:DEVELOPMENT:EXHAUST:FRONT



29.D1796832
DUCT:DEVELOPMENT:EXHAUST:REAR



24.D1364233
(x16)
STEPPED SCREW:
DIA:5:M3X3.8



25.D1791786
(x2)
BRACKET:INNER COVER



21.AX640330
FAN:SIROCCO:DIAS 51

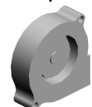

27.D1796822
BRACKET:FAN:DEVELOPMENT:COOLING:FRONT



26.D1796821
DUCT:DEVELOPMENT:VACUUM:FRONT



39.D1796847
DUCT:CHARGE CORONA:VACUUM:MAIN:RIGHT



40.D1796848
DUCT:CHARGE CORONA:VACUUM:MAIN:LEFT



41.D1796849
SEAL:DUCT:CHARGE CORONA:VACUUM:MAIN



22.AX650056
(x3)
DC FAN MOTOR:AXIAL:MM92



23.AX660015
(x4)
DC FAN MOTOR:SIROCCO:DC24V:PWM



U021 AIR COOLING

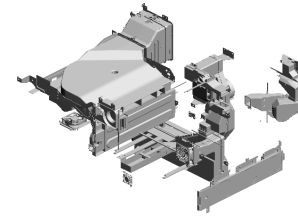

- 62.D1796947 BRACKET:DUCT:EXHAUST:PAPER EXIT SUB-UNIT:LEFT
- 57.D1796934 DUCT:HEAT SHIELD:FUSING:LOWER
- 42.D1796858 BRACKET:DUCT:CHARGE:EXHAUST:UPPER
- 44.D1796864 DUCT:DEVELOPMENT:TONER:ASSY
- 43.D1796860 DUCT:DEVELOPMENT:TONER:UPPER:ASSY

61.D1796946
DUCT:EXHAUST:PAPER EXIT SUB-UNIT:A

63.D1796948
PLATE:DUCT:EXHAUST:A:ASSY

64.D1796953
DUCT:EXHAUST:PAPER EXIT SUB-UNIT:B

54.D1796918
SEAL:EXHAUST:REAR:UPPER

55.D1796927
DUCT:HEAT PIPE:EXHAUST

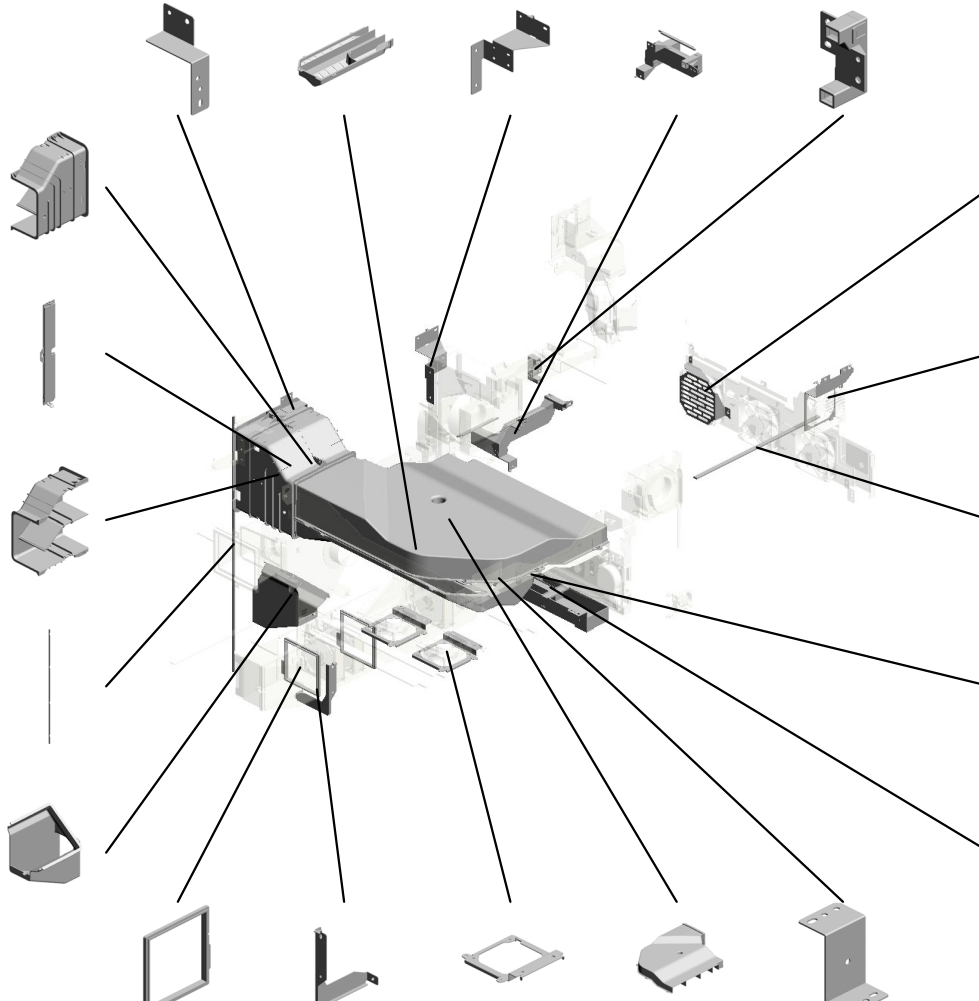

60.D1796943
GUARD:FAN:SIDE:VACUUM

50.D1796897
BRACKET:FAN:OPTICAL WRITING UNIT:COOLING

51.D1796898
SEAL:DUCT:OPTICAL WRITING UNIT:VACUUM

45.D1796873
DUCT:FLAT CONVEYER BELT:EXHAUST:UPPER

46.D1796874
DUCT:FLAT CONVEYER BELT:EXHAUST:LOWER

48.D1796889
(x2)
FILTER:MAIN:EXHAUST:RIGHT
202012-02 O/O

49.D1796893
BRACKET:DUCT:MAIN:EXHAUST:LOWER

58.D1796940
(x2)
BRACKET:FAN:EXHAUST:MIDDLE

56.D1796932
DUCT:HEAT SHIELD:FUSING:UPPER

47.D1796875
(x2)
BRACKET:DUCT:FLAT CONVEYER BELT:EXHAUST

U021 AIR COOLING

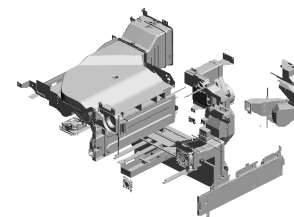

- 65.D1796954 BRACKET:DUCT:EXHAUST:PAPER EXIT SUB-UNIT:RIGHT
- 66.D1796955 PLATE:DUCT:EXHAUST:B:ASSY
- 92.D2706856 DUCT:CHARGE CORONA:EXHAUST:CONNECTING:FRONT
- 90.D2706853 DUCT:CHARGE CORONA:EXHAUST:MIDDLE:REAR
- 86.D1806831 GASKET:DUCT:CHARGE CORONA:VACUUM

73.D1796978
SEAL:EXTERIOR:REAR:SMALL

88.D2706823
OZONE FILTER:DUCKET:MAIN:REAR

76.D1796985
DUCT:HEAT PIPE:EXIT:MIDDLE

75.D1796984
DUCT:HEAT PIPE:EXIT

74.D1796981
BRACKET:DUCT:HEAT PIPE:EXIT:ASSY

83.D1806818
OZONE FILTER:MAIN:EXHAUST:RIGHT

84.D1806821
BASE:HEAT SHIELD:FUSING SUB-UNIT:SUB-ASSY

87.D2706806
SEAL:DUCT:LARGE

69.D1796970
DUCT:THERMOPILE

70.D1796971
SEAL:DUCT:THERMOPILE:ENTRANCE:LOWER

89.D2706851
DUCT:CHARGE CORONA:EXHAUST:MIDDLE:RIGHT

91.D2706854
DUCT:CHARGE CORONA:EXHAUST:MIDDLE:FRONT

72.D1796977
GUARD:FAN:OPTICAL WRITING UNIT

79.D1796995
BRACKET:FAN:TRANSFER/SEPARATION UNIT:COOLING:REAR

71.D1796972
DUCT:THERMOPILE:ENTRANCE:ASSY

U021 AIR COOLING

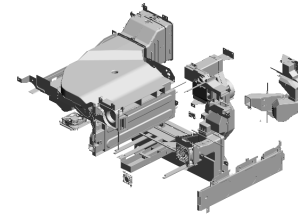

- 94.D2706869 DUCT:CHARGE CO
RONA:EXHAUST:M
ULTI-LANGUAGE:R
EAR
- 95.D2706870 DUCT:CHARGE CO
RONA:EXHAUST:M
ULTI-LANGUAGE:F
RONT
- 104.D2706921 SEAL:DUCT:MAIN:
EXHAUST:B
- 93.D2706857 DUCT:CHARGE CO
RONA:EXHAUST:C
ONNECTING:REAR
- 100.D2706910 SEAL:DUCT:CHAR
GE CORONA:EXHA
UST:MIDDLE

103.D2706920
SEAL:DUCT:MAIN:
EXHAUST:A

102.D2706917
SEAL:DUCT:MAIN:
EXHAUST

96.D2706890
DUCT:MAIN:EXHA
UST:FRONT

105.D2706929
(x3)
COVER:FAN:MAIN:
EXHAUST

98.D2706892
(x2)
COVER:FILTER:EX
HAUST

97.D2706891
DUCT:MAIN:EXHA
UST:REAR

101.D2706911
(x3)
SEAL:DUCT:MAIN:
EXHAUST:FRONT

107.GX640028
(x2)
FAN MOTOR DC24
V 1.92W

108.03603006N
(x2)
SCREW - M3X6
201704-12 X/O

109.04543030Q
(x6)
TAPPING SCREW:
ROUND POINT:3X3
0
201704-13 X/O

99.D2706896
DUCT:OPTICAL W
RITING UNIT:VACU
UM:FRONT

106.GX640024
(x5)
FAN MOTOR - DC 3
.12W

111.D2706944
BRACKET:GUIDE:B
ASE
201704-17

112.D2706945
FILTER:VACUUM:M
AIN:RIGHT
201704-18

113.D2706947
BRACKET:AUXILIA
RY:BASE
201704-19

U021 AIR COOLING

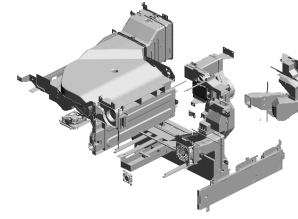

120.D0BX6909 115.D2706822
(x2) SEAL:DUCT:HEAT
FILTER:DUCT:MAI SHIELD:FUSING:A
N:REAR 201803-07 O/O
201907-11 O/O

116.D2706989
(x2)
SEAL:DUCT:HEAT
PIPE:ENTRANCE
201803-04 O/O

114.D2706948
SHEET:SCREW:FIL
TER
201704-20

118.D2706909
(x2)
SEAL:DUCT:LARG
E
201805-06 O/O

117.D2706818
SEAL:DUCT:FAN:M
M97
201805-08 O/O

U021_S001
DUCT:CHARGE CORONA:CONNECTING:LOWER:ASS'Y

118.D2706909
SEAL:DUCT:LARG
E
201805-06 O/O

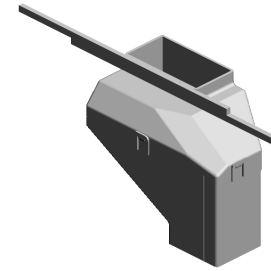

32.D1796836
DUCT:CHARGE CO
RONA:CONNECTIN
G:LOWER:ASS'Y

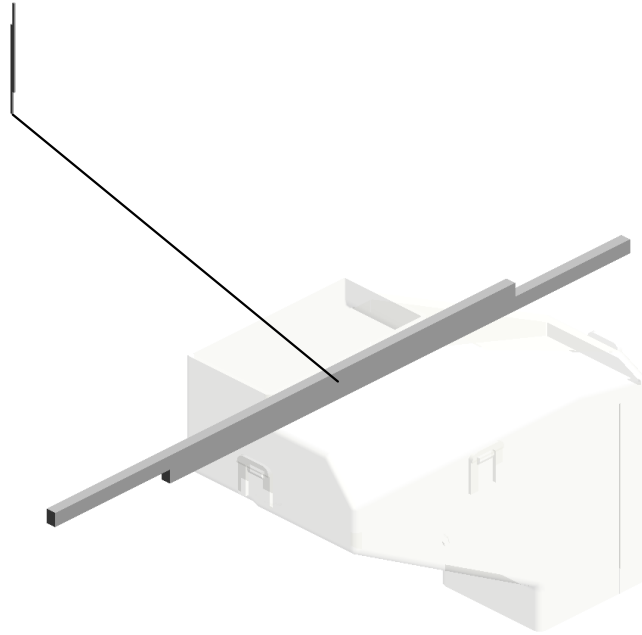

U001	U002	U003	U004	U005	U006	U007	U008	U009	U010	U011	U012	U013	U014	U015	U016	U017	U018	U019	U020	U021
------	------	------	------	------	------	------	------	------	------	------	------	------	------	------	------	------	------	------	------	------

U021_S002
DUCT:FLAT CONVEYER BELT:EXHAUST:CONNECTING:ASS'Y

117.D2706818
SEAL:DUCT:FAN:M
M97
201805-08 O/O

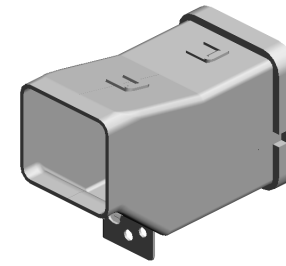

81.D1806811
DUCT:FLAT CONV
EYER BELT:EXHAU
ST:CONNECTING:
ASS'Y

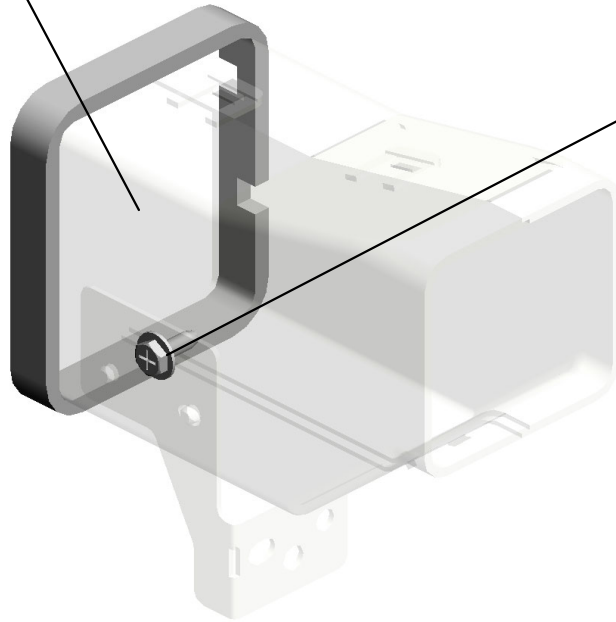

6.04503008N
TAPPING SCREW -
M3X8

U001	U002	U003	U004	U005	U006	U007	U008	U009	U010	U011	U012	U013	U014	U015	U016	U017	U018	U019	U020	U021
------	------	------	------	------	------	------	------	------	------	------	------	------	------	------	------	------	------	------	------	------

U021_S003
DUCT:HEAT PIPE:ENTRANCE:ASS'Y

116:D2706989
SEAL:DUCT:HEAT
PIPE:ENTRANCE
201807-02 O/O

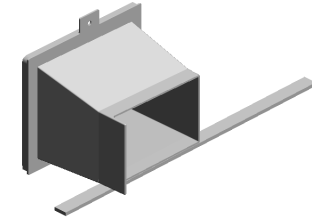

77:D1796987
DUCT:HEAT PIPE:
ENTRANCE:ASS'Y

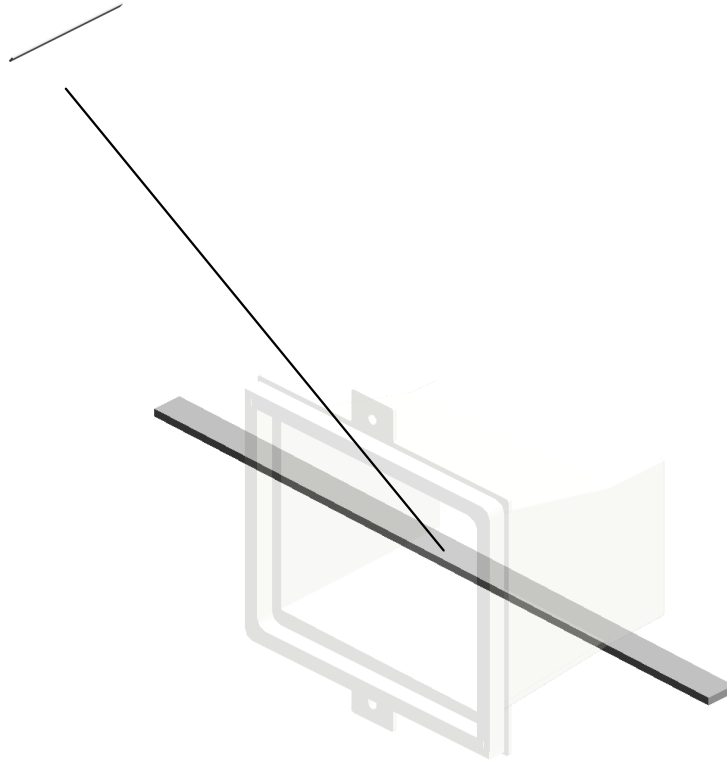

U001	U002	U003	U004	U005	U006	U007	U008	U009	U010	U011	U012	U013	U014	U015	U016	U017	U018	U019	U020	U021
------	------	------	------	------	------	------	------	------	------	------	------	------	------	------	------	------	------	------	------	------

U021_S004
BRACKET:FAN:SIDE:RIGHT:SUB-ASS'Y

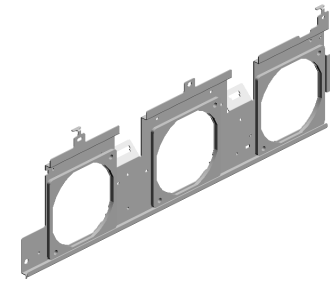
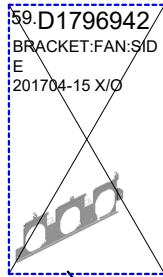

110.D2706942
BRACKET:FAN:SID
E:RIGHT:SUB-ASS'
Y
201704-15 X/O

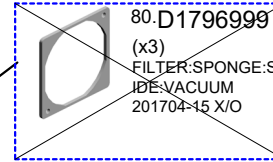

U001	U002	U003	U004	U005	U006	U007	U008	U009	U010	U011	U012	U013	U014	U015	U016	U017	U018	U019	U020	U021
------	------	------	------	------	------	------	------	------	------	------	------	------	------	------	------	------	------	------	------	------

U021_S005
BRACKET:HEAT SHIELD:BELT CLEANING:ASS'Y

68.D1796966
SEAL:DUCT:THER
MOPILE:ENTRANC
E:UPPER

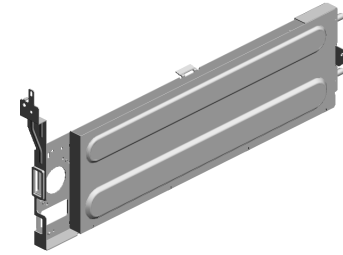
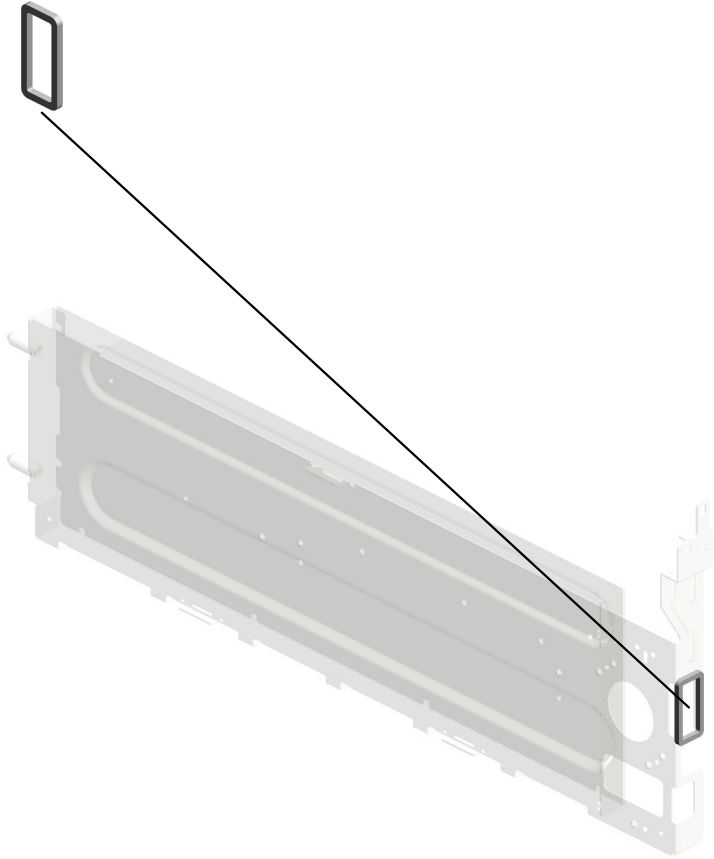

67.D1796963
BRACKET:HEAT S
HIELD:BELT CLEA
NING:ASSY

U001	U002	U003	U004	U005	U006	U007	U008	U009	U010	U011	U012	U013	U014	U015	U016	U017	U018	U019	U020	U021
------	------	------	------	------	------	------	------	------	------	------	------	------	------	------	------	------	------	------	------	------

U022 MAIN FRAME

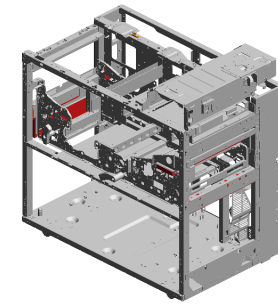

- 21.11050511 (x17) HARNESS CLAMP - LWS-0306ZC
- 1.03140120N SCREW - M4X12
- 17.11050488 HARNESS CLAMP
- 18.11050489 (x13) HARNESS CLAMP - LWS 1316
- 4.03540060N (x10) SCREW-M4X6

- 19.11050490 (x60) HARNESS CLAMP - IWS-2218

- 15.08050088 RETAINING RING - M6

- 5.03603006N (x4) SCREW - M3X6

- 14.07200060E (x8) RETAINING RING - M6

- 16.11050487 (x43) HARNESS CLAMP

- 7.03604008N (x10) SCREW - M4X8
- 3.03540050N (x10) SCREW - M4X5
- ~~8.04514008N (x2) TAPPING SCREW: 4X8 201704-03~~
- 8.04514008N (x169) TAPPING SCREW: 4X8
- 10.04543006Q (x8) TAPPING SCREW - M3X6

- 20.11050508 (x3) HARNESS CLAMP - LWS-0711

- 2.03140180N (x2) PAN HEAD SCREW :M4X18

- 9.04514012N (x8) TAPPING SCREW: 4X12

- 13.07200040E (x4) RETAINING RING - M4

- 11.04544008Q (x29) TAPPING SCREW - M4X8

- 16.11050487 (x2) HARNESS CLAMP
- 17.11050488 (x8) HARNESS CLAMP

- 18.11050489 (x2) HARNESS CLAMP - LWS 1316
- ~~19.11050490 (x2) HARNESS CLAMP - IWS-2218 201609-02~~

- 19.11050490 (x2) HARNESS CLAMP - IWS-2218
- 20.11050508 (x2) HARNESS CLAMP - LWS-0711

- 21.11050511 (x10) HARNESS CLAMP - LWS-0306ZC
- 22.11050516 (x2) CLAMP

U022 MAIN FRAME

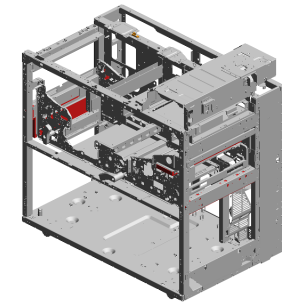
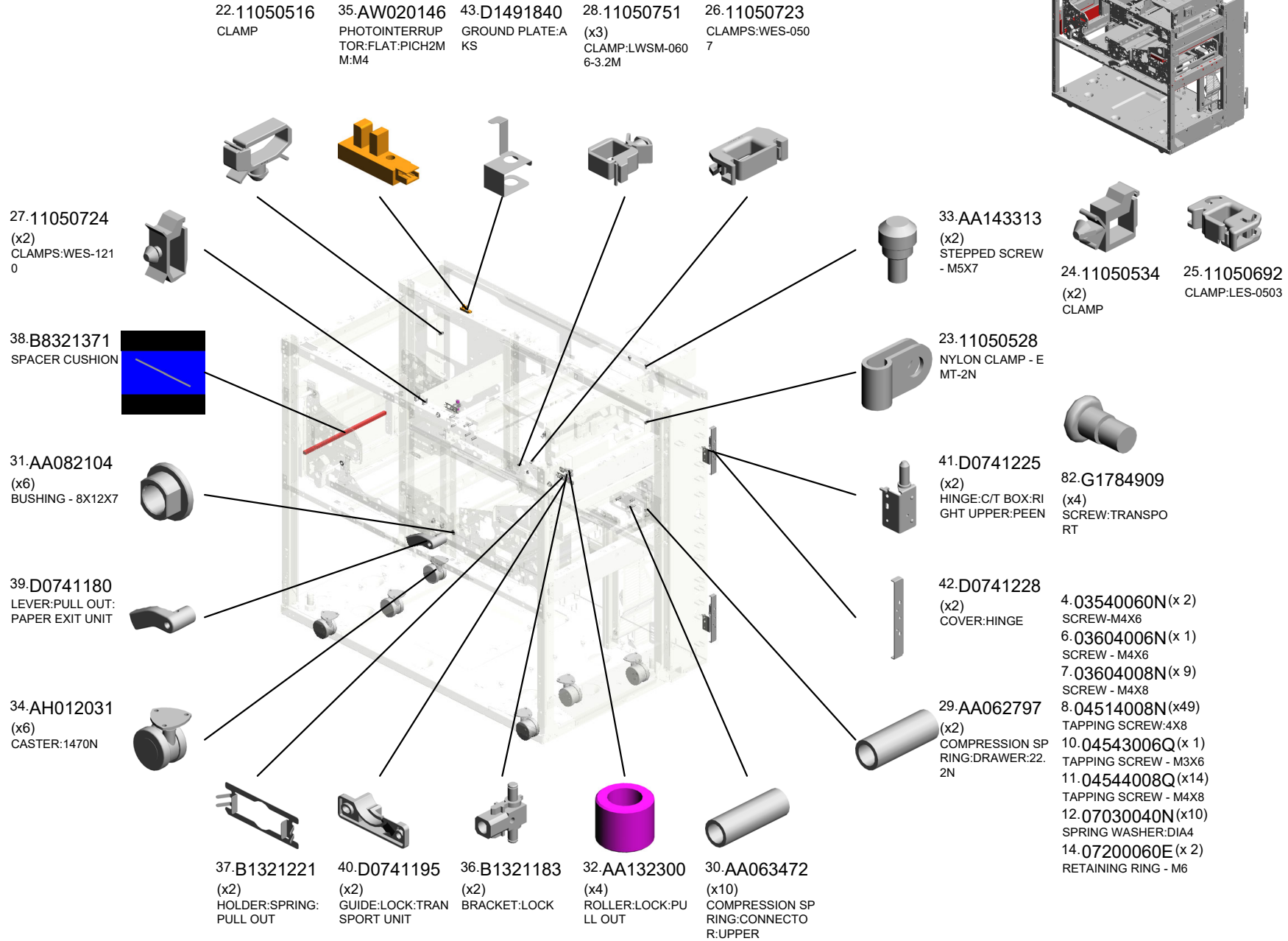

U022 MAIN FRAME

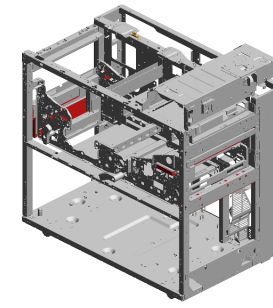

- 59.D1791784 BRACKET:ADF:LEFT
- 46.D1791127 (x2) GUIDE:LOCK:PAPER EXIT UNIT
- 45.D1791115 RAIL:INTERMEDIATE TRANSFER:LEFT
- 58.D1791782 BRACKET:ADF:RIGHT
- 62.D1796823 DUCT:DEVELOPMENT:EXHAUST:MULTI-LANGUAGE:ASSY

57.D1791769
(x2)
SPRING PLATE:EA
RTH:FRAME:SCANNER

60.D1794884
SHEET:OPPOSED:
PAPER FEED SENSOR

50.D1791185
GUIDE:INTERMEDIATE TRANSFER:LEFT

61.D1796410
SLIDE RAIL:CASE:
TENSION:ROLLER

56.D1791734
LEVER:PULL OUT:
LEFT

49.D1791130
GUIDE:PULL OUT:
MIDDLE:LOWER

53.D1791232
SHAFT:LOCK:PULL
OUT:RIGHT:ASSY

63.D1806801
DUCT:FLAT CONVEYER BELT:EXHAUST:SMALL:ASSY

52.D1791221
(x2)
HOLDER:COIL SPRING:LOCK:PULL OUT

44.D1791043
GUARD:MAIN:VERTICAL TRANSPORT

54.D1791465
BRACKET:KEY COUPLER

64.D1941234
(x2)
SUPPORTING PLATE:BRACKET:LOCK

55.D1791731
COVER:REGISTRATION:MOTOR

48.D1791129
GUIDE:PULL OUT:LOCK

47.D1791128
HOLDER:REGISTRATION:DRAWER

U022 MAIN FRAME

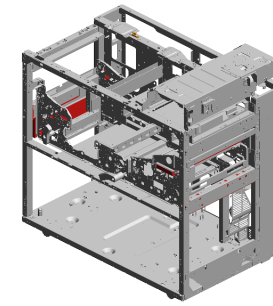

- 71.D2701165 SUPPORTING PLATE:RAIL:INTERMEDIATE TRANSFER
- 72.D2701166 SUPPORTING PLATE:AUXILIARY:RAIL:INTERMEDIATE TRANSFER
- 69.D2701155 BRACKET:RADIAL BALL BEARING
- 65.D1944759 (x2) BRACKET:LOCK:EXIT
- 81.G1784818 (x4) SPRING:PULL OUT:LOCK:EXIT

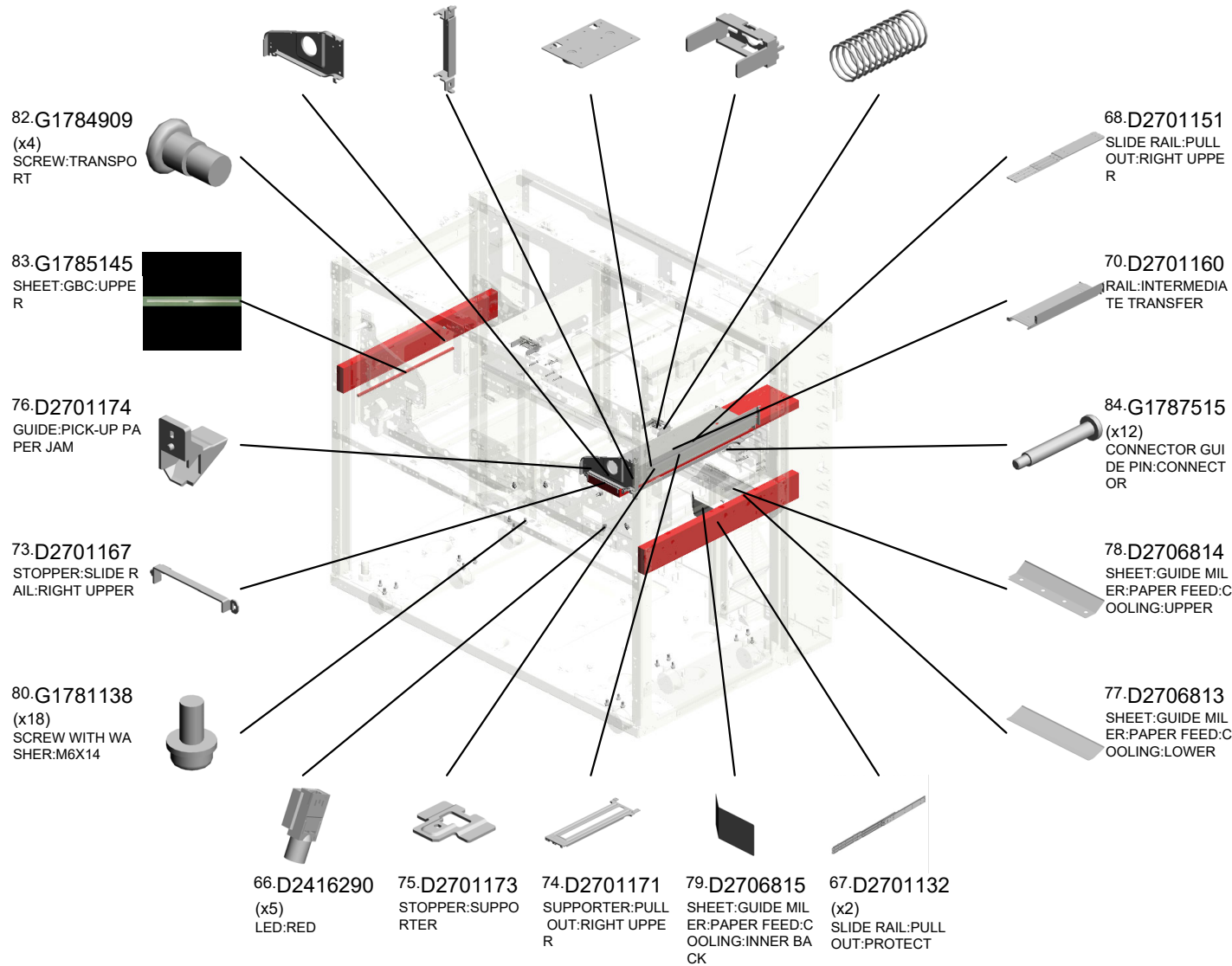

U022 MAIN FRAME

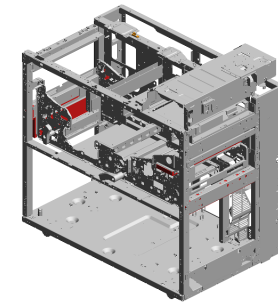

91.D2701219 88.G0342986
SHAFT:LOCK:PULL FLANGED HEXAG
OUT:LEFT ONAL HEAD BOLT
201907-12 O/O - M4X8
201704-11

85.M0774703
BRACKET:ADAPTE
R SECTION:GBC:P
EEN



86.M0774707
GUIDE PLATE:GBC
:ASS'Y



92.D1791119
STAY:MAIN:RIGHT
UPPER



89.D0BX1069
COVER:MOTOR:U
SED TONER



87.04534008N 90.D1791118
BINDING SELF TAP SEPARATION PLA
PING SCREW:4X8 TE:MAIN:REAR MI
201704-10 DDLE



U023.ACCESSORIES

U023 S001
D0744390
ACCESSORY:KNOB:FUSING:
ASSY

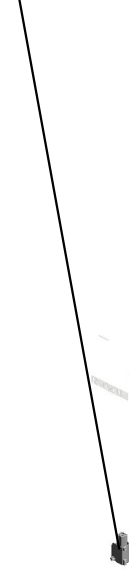

U023 S002
M0771861
TUBE TYPE LAMP:TAC:ASS'
Y

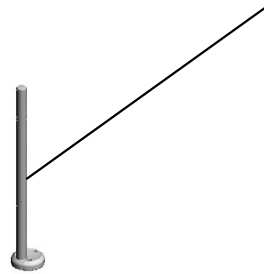

U001	U002	U003	U004	U005	U006	U007	U008	U009	U010	U011	U012	U013	U014	U015	U016	U017	U018	U019	U020	U021
------	------	------	------	------	------	------	------	------	------	------	------	------	------	------	------	------	------	------	------	------

U023 ACCESSORIES

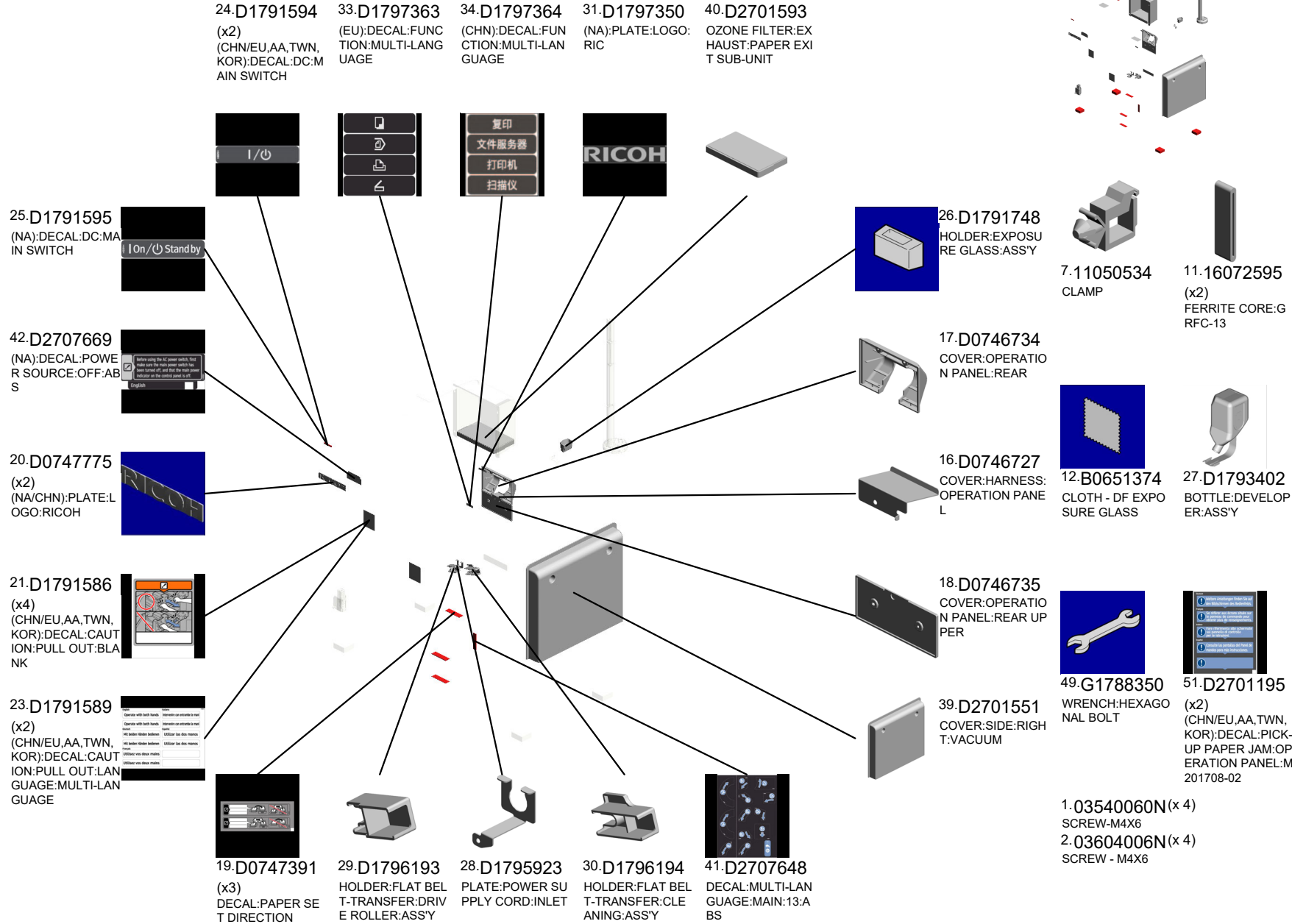

U001	U002	U003	U004	U005	U006	U007	U008	U009	U010	U011	U012	U013	U014	U015	U016	U017	U018	U019	U020	U021	U022
------	------	------	------	------	------	------	------	------	------	------	------	------	------	------	------	------	------	------	------	------	------

U023 ACCESSORIES

55.D2701761 (NA):DECAL:CAUTION CHART:INKJET :PAPER 201806-05 O/O
 54.D2706022 DECAL:CAUTION:ORIGINAL:MANY LANGUAGES 201804-02 O/O
 56.D0BX1518 COVER:EXHAUST: PAPER EXIT SUB-UNIT 201812-01 O/O

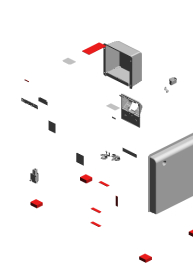

53.D2707671 (NA):DECAL:CAUTION CHART:COPY: ORIGINAL 201803-06 O/O



52.D2707362 (NA):DECAL:FUNCTION: MULTI-LANGUAGE 201803-05 O/O



58.D2701588 (x2) (NA):DECAL:CAUTION: PULL OUT: ENGLISH 202102-03 O/O

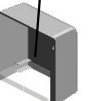
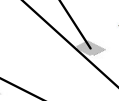
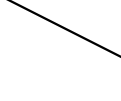

44.D2717681 (Pro 8210S):MODE L NAME PLATE

45.D2727681 (Pro 8220S):MODE L NAME PLATE

48.G1781141 (x4) HOLDER:STAND:M 20

46.D3775852 BRACKET:NIC:VC2 :ENGINE

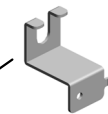

43.D2707681 (Pro 8200S):MODE L NAME PLATE



57.D2707649 DECAL: MULTI-LANGUAGE: MAIN:5 201904-08 O/O



4. 04514006N (x 1) TAPPING SCREW - 4X6
 5. 04514008N (x 2) TAPPING SCREW:4X8
 6. 04543006Q (x 1) TAPPING SCREW - M3X6
 8. 11500454 (x 1) (EU,AA,TWN,KOR):POWER SUPPLY CODE:250V:16A
 9. 11500455 (x 1) (NA):POWER SUPPLY CODE:250V:20A
 10. 11500466 (x 1) (CHN):POWER SUPPLY CODE:250V:16A

U023_S001
ACCESSORY:KNOB:FUSING:ASS'Y

13.D0744225
KNOB:FUSING

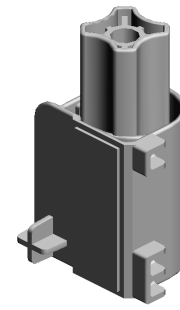

14.D0744390
ACCESSORY:KNOB:FUSING:ASS'Y

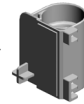

15.D0744391
HOLDER:KNOB:FUSING:DUAL FACES
TEPE

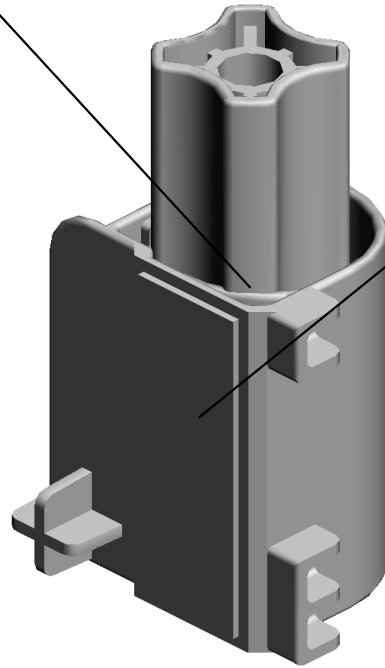

U001	U002	U003	U004	U005	U006	U007	U008	U009	U010	U011	U012	U013	U014	U015	U016	U017	U018	U019	U020	U021
------	------	------	------	------	------	------	------	------	------	------	------	------	------	------	------	------	------	------	------	------

U023_S002
TUBE TYPE LAMP:TAC:ASS'Y

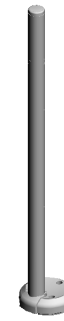

50.M0771861
TUBE TYPE LAMP:
TAC:ASS'Y

3.04503012N(x 3)
TAPPING SCREW:3X12

U001	U002	U003	U004	U005	U006	U007	U008	U009	U010	U011	U012	U013	U014	U015	U016	U017	U018	U019	U020	U021
------	------	------	------	------	------	------	------	------	------	------	------	------	------	------	------	------	------	------	------	------

SPECIAL TOOLS



1.52039502
GREASE 501



3.A0069104
ADJUSTING SCANNER PIN (4PCS/SET)

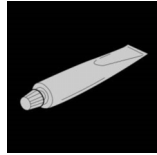

4.A2579300
GREASE - BARRIERTA S552R



5.B1329700
LUBRICANT POWDER
202401-03 O/O

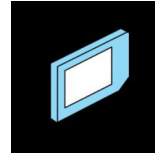

6.B6455010
SD-CARD:ASS'Y



7.C4019503
20X MAGNIFICATION SCOPE



8.D0159500
G104 YELLOW TONER



9.D0159501
ZINC STEARATE

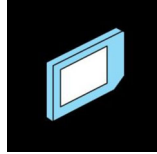

10.D0745100
SD-CARD:NICE:REGI:ASS'Y



11.D1793402
BOTTLE:DEVELOPER:ASS'Y

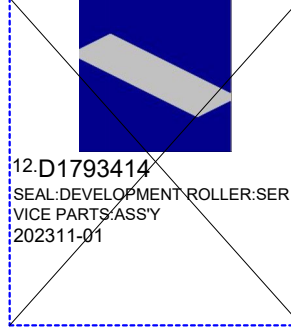

~~12.D1793414
SEAL:DEVELOPMENT ROLLER:SERVICE PARTS:ASS'Y
202311-01~~

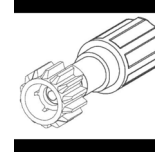

14.D1793421
KNOB:DRIVE:DEVELOPMENT UNIT:ASS'Y

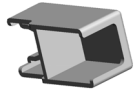

15.D1796193
HOLDER:FLAT BELT-TRANSFER:DRIVE ROLLER:ASS'Y



16.D1796194
HOLDER:FLAT BELT-TRANSFER:CLEANING:ASS'Y



17.VSSG9002
FLUOTRIBO MG GREASE : 100G



18.VSSM9000
DIGITAL MULTIMETER-FLUKE189/FVF

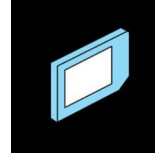

20.D0A57797
SD-CARD:SP: BATCH:TOOL:ASS'Y
202011-03



21.M0B13320
JIG:SHEET:DOCTOR BLADE
202011-04 O/O

Exclusive Parts

Number	Part Name	Group	ID
50530223	BUSHING - 8MM	U006_S017	57
		U006_S019	57
		U006_S021	57
50530447	BUSHING - 6MM	U006_S018	58
		U006_S020	58
		U006_S022	58
		SPECIAL TOOLS	1
52039502	GREASE 501	SPECIAL TOOLS	1
52062686	SNAP RING	U001	12
		U003_S001	31
		U012_S001	19
52152621	SNAP RING - M6	U003_S001	32
		U006	59
		U010_S001	24
		U012_S001	20
54472681	SNAP RING	U003_S001	33
		U003_S001_S007	33
		U006	60
		U007	36
		U011_S001	5
		U017	22
54472706	GEAR - 15T	U006_S014	61
		U006_S015	61
		U006_S016	61
54472768	STEPPED SCREW - M3	U015_S001	29
		U015_S003	29
		U015_S004	29
67542866	ROLLER - POSITIONING GUIDE	U006	62
A0069104	ADJUSTING SCANNER PIN (4PCS/SET)	SPECIAL TOOLS	3
A0793626	STEPPED SCREW - SWING CLEANING	U018	23
A1342978	SPRING PLATE	U006_S001_S003	63
		U006_S002_S003	63
A1343180	BOTTLE CHUCK	U008	24
A2324666	CUSHION - STEPPER MOTOR	U004	16
		U006	64
		U010_S001	25
A2486687	RIGHT DRIVE SHAFT	U006_S017	65

Number	Part Name	Group	ID
		U006_S019	65
		U006_S021	65
A2486694	WIRE RING	U006_S017	66
		U006_S019	66
		U006_S021	66
A2486695	GUIDE - PULLEY	U006_S017	67
		U006_S019	67
		U006_S021	67
A2486713	HOOK - TENSION SPRING	U006_S017	68
		U006_S019	68
		U006_S021	68
A2501752	EXPOSURE GLASS	U004	17
A2574493	BAND	U017	23
A2579300	GREASE - BARRIERTA S552R	SPECIAL TOOLS	4
A2672857	SPRING PLATE - SIDE FENCE	U006_S001_S002	69
		U006_S002_S002	69
A2672859	SIDE FENCE STOPPER	U006_S001_S002	70
		U006_S002_S002	70
A2941163	GEAR - 30Z	U008_S001	25
A2943246	GEAR - 108Z	U008	26
A2943319	CASE CUSHION	U008_S003	27
		U008_S005	27
A2943354	RACK - 10Z	U008	28
A2943445	STOPPER SUPPORT PLATE	U008	29
A2943446	TONER BOTTLE STOPPER	U008	30
A2943447	TONER BOTTLE SET FEELER	U008	31
A2943454	LEVER STOPPER	U008	33
A2943461	LEVER RACK JOINT	U008	34
A2944156	GEAR - 23Z	U015_S002	30
A2944171	COUPLED GEAR - 17Z/32Z	U015_S001_S007	31
		U015_S002	31
		U015_S003_S007	31
		U015_S004_S007	31
A2946643	LEFT FRONT FENCE	U006_S018	71
		U006_S020	71
		U006_S022	71
A2946690	FEELER - PAPER HEIGHT SENSOR	U006_S017	73
		U006_S019	73

Exclusive Parts

Number	Part Name	Group	ID
		U006_S021	73
A4181158	SPACER - M6.5X1	U003_S001_S007	34
A4221063	SEAL - 0.7X13X20	U003_S001	35
		U003_S001_S011	35
		U003_S001_S015	35
A5482139	PULLEY	U003_S001	36
A6281225	BUSHING - 8MM	U003_S001_S007	37
A8061163	GUIDE PLATE CUSHION	U003_S001_S007	38
		U003_S001_S007_S001	38
A8063281	TIMING PULLEY - T14 S3M	U013_S002	14
A8592112	DRIVE SHAFT - PAPER FEED BELT	U003_S001_S007	39
A8592319	BASE CUSHION	U003_S001_S007	40
A8597211	STEPPED SCREW	U003	41
AA000290	DECAL:POSITIONING DISPLAY:SCREW:PET	U006_S014	414
		U006_S015	414
		U006_S016	414
		U012	83
AA001508	DECAL:SIDE FENCE:40X30	U006_S018_S002	76
		U006_S020_S002	76
		U006_S022_S001	76
AA001509	DECAL:SIDE FENCE:16X30	U006_S017_S001	77
		U006_S019_S001	77
		U006_S021_S001	77
AA001597	DECAL:SIDE FENCE:REAR	U006_S001_S002	78
		U006_S002_S002	78
AA003056	DECAL:GRIP:SHORT:PP	U006_S014	79
		U006_S015	79
		U006_S016	79
		U012	22
AA021034	MAGNETIC	U017	24
AA021035	MAGNETIC:COVER	U008	35
AA036015	CAP:COLLECTION BOTTLE	U013_S004	15
AA043271	TIMING BELT S3M 196T	U006_S018	80
		U006_S020	80
		U006_S022	80
AA043293	TIMING BELT - 40S2M268G	U017	25

Number	Part Name	Group	ID
AA043323	TIMING BELT:40S2M120	U016	28
AA043324	TIMING BELT - B40S2M152	U006	81
AA043325	TIMING BELT - B40S2M250	U006	82
AA043333	TIMING BELT:60S2M168	U017	26
AA043342	SYNCHRONOUS BELT:40S3M666	U013_S001	16
AA043443	TIMING BELT - S2M 140	U007	37
AA043650	TIMING BELT - B60S2M290	U017	27
AA043652	TIMING BELT - B60S2M130	U016	30
AA043659	SYNCHRONOUS BELT:40S3M231	U013_S002	17
AA043660	TIMING BELT:40S2M172	U016	31
AA043682	SYNCHRONOUS BELT:60S1.5M150	U003_S001	46
AA043683	SYNCHRONOUS BELT:60S1.5M204	U003_S001	47
AA043684	SYNCHRONOUS BELT:60S1.5M390	U003_S001	48
AA043698	SYNCHRONOUS BELT:40S1.5M300	U003_S001	51
AA043725	TIMING BELT:40S2M142	U010_S001	132
AA043726	SYNCHRONOUS BELT:60S2M134	U014	23
AA043727	SYNCHRONOUS BELT:80S2M190	U007	189
AA043731	TIMING BELT:40S2M184	U016	155
AA043737	TIMING BELT:60S2M188	U006	413
AA060523	PICK-UP PRESSURE SPING	U006_S014	84
		U006_S015	84
		U006_S016	84
AA060575	RELEASE SPRING	U006_S014	85
		U006_S015	85
		U006_S016	85
AA060757	TENSION SPRING - LONG	U006_S017	86
		U006_S019	86
		U006_S021	86
AA060758	TENSION SPRING - SHORT	U006_S017	87
		U006_S019	87
		U006_S021	87
AA060811	TENSION SPRING - STOPPER	U008	36
AA060812	LEVER TENSION SPRING	U008	37
AA060842	TENSION SPRING	U003_S001	53

Exclusive Parts

Number	Part Name	Group	ID
AA060961	TENSION SPRING:SIDE FENCE:REAR	U006_S001	88
		U006_S002	88
AA060987	TENSION SPRING:TIMING BELT:10N	U006_S018	89
		U006_S020	89
		U006_S022	89
AA061067	TENSION SPRING:DRIVE WERE:DRIVE	U010_S001	27
AA061068	TENSION SPRING:BRACKET:DRIVEN ROLLER:INNER BACK	U010_S001	28
AA061114	TENSION SPRING:POSITIONING SENSOR	U010_S001	29
AA061116	TENSION SPRING:STRIPPER PLATE:2N	U015_S001	32
		U015_S003	32
		U015_S004	32
AA061134	TENSION SPRING:LEVER:PRESSURE	U015_S001	33
		U015_S003	33
		U015_S004	33
AA061169	TENSION SPRING:TONER CATCH PAN:DISCHARGE USED TONER	U013_S003	18
AA061170	COIL SPRING:GATE PAWL:EXIT:ENTRANCE	U016	32
AA061171	COIL SPRING:LATCH:REVERSE EXIT:LEFT LOWER	U016	33
AA061172	COIL SPRING:GATE PAWL:EXIT:DUPLEX	U016	34
AA061173	COIL SPRING:GATE PAWL:DUPLEX:ENTRANCE	U017	28
AA061177	TENSION SPRING:VIBRATING PLATE:VERTICAL TRANSPORT	U013_S002	19
AA061191	TENSION SPRING:REGISTRATION	U007	39
AA061192	TENSION SPRING:TIMING ROLLER	U007	40
AA062352	TENSION SPRING:HEAT ROLLER	U015_S001	34
		U015_S003	34
		U015_S004	34
AA062797	COMPRESSION SPRING:DRAWER:22.2N	U022	29
AA063268	CONNECTOR SPRING	U006	90

Number	Part Name	Group	ID
AA063392	CHUCK SPRING	U008	38
AA063435	COMPRESSION SPRING:PAPER FEED:JOINT	U003_S001_S007	54
AA063463	COMPRESSION SPRING:DRAWER	U010	30
		U015	35
AA063465	COMPRESSION SPRING:CLEANING FELT:27N	U015_S002	36
AA063472	COMPRESSION SPRING:CONNECTOR:UPPER	U022	30
AA063601	RACK SPRING	U008	39
AA063602	CHUCK SPRING	U008	40
AA063674	SPRING - 8N	U016	35
		U016_S010	35
		U017	29
AA063675	SPRING - 5N	U016	36
		U017	30
AA063678	SPRING - 3.5N	U007	41
AA063693	COMPRESSION SPRING:PRESSURE:DRIVEN ROLLER	U006	91
		U006_S013	91
		U006_S014	91
		U006_S015	91
		U006_S016	91
AA063694	COMPRESSION SPRING:HANDLE	U006	92
AA063695	COMPRESSION SPRING:GRIP	U006	93
AA063851	PRESSURE SPRING	U015_S002	37
AA064000	COMPRESSION SPRING:PRESSURE	U015_S001	38
		U015_S003	38
		U015_S004	38
AA066320	FEELER TORSION SPRING	U008	41
AA066402	TORSION SPRING:GUIDE PLATE:REAR	U007	42
AA066403	TORSION SPRING:GUIDE PLATE:FRONT	U007	43
AA066419	TORSION SPRING:GRIP	U007	44
AA066667	SPRING:STRIPPER PLATE:FRONT	U006	94
AA070090	SLIDE RAIL:FUSING UNIT	U015	39
AA080154	REAR BUSHING	U012_S001	23
AA080265	BUSHING:6X8X5	U006	95

Exclusive Parts

Number	Part Name	Group	ID
AA080346	BUSHING:FLANGE TYPE:DIA6	U003_S001	55
		U006	96
		U007	45
		U016	37
		U017	31
AA080347	BUSHING - 8MM	U003_S001	56
AA082101	BUSHING - 6X10X6	U003_S001	57
		U003_S001_S001	57
		U003_S001_S004	57
		U003_S001_S007	57
		U012_S001_S003	24
		U015_S001	40
		U015_S003	40
		U015_S004	40
AA082104	BUSHING - 8X12X7	U016	38
		U003_S001_S006	58
		U003_S001_S010	58
		U007	46
		U010_S001	31
AA082115	PLAIN SHAFT BEARING:5X10X5	U016	39
		U022	31
		U015_S001	163
		U015_S003	163
AA082137	BUSHING:6X10X6	U015_S004	163
		U011_S001	6
AA082144	BUSHING - 8X12X7	U007	47
AA082173	PLAIN SHAFT BEARING:6X10X6	U003_S001	59
AA083009	CLUTCH ROLLER - 8X18X11	U007	47
		U014	10
		U006_S014	97
AA083022	BUSHING:DIA6:DIA8	U006_S015	97
		U006_S016	97
		U010_S001	32
AA084059	BALL BEARING HOLDER	U011_S001	7
		U006	98
		U006_S013	98
		U006_S014	98
		U006_S015	98
U006_S016	98		

Number	Part Name	Group	ID
		U007	48
		U016	40
		U016_S010	40
		U017	32
		U015_S001	41
AA113037	TERMINAL:4P:187	U015_S003	41
		U015_S004	41
		U016	41
AA120084	DISCHARGE BRUSH	U016	41
AA120097	ANTISTATIC BRUSH	U016	42
AA120127	DISCHARGE BRUSH:FUSING	U007	49
AA120150	DISCHARGE BRUSH:REVERSE:17MM	U007	50
		U016	43
AA132013	SPACER	U003_S001_S007	60
AA132203	SPACER - 6MM	U006	99
		U006_S017	99
		U006_S019	99
		U006_S021	99
AA132300	ROLLER:LOCK:PULL OUT	U022	32
AA140686	SHAFT - TIMING PULLEY	U006_S018	100
		U006_S020	100
		U006_S022	100
AA140912	SCREW - 8X14X2.8	U006	101
AA143313	STEPPED SCREW - M5X7	U022	33
AA143444	STEPPED SCREW	U010_S001	33
		U016	44
AA143520	SHOULDER SCREW - M3	U015_S001	42
		U015_S002	42
		U015_S003	42
		U015_S004	42
AA143550	SCREW:DIA4:M3	U006	102
AA143562	SCREW:M4:DIA6X1.2	U008	42
AA143569	SCREW	U006	103
AA143788	PIN:GUIDE PLATE:PAPER FEED	U003_S001	61
		U003_S001_S011	61
AA143789	SHAFT:CLEANER	U003_S001	62
AA143791	SCREW:SAFETY	U003_S001	63
AA143797	CONNECTOR GUIDE PIN	U001	13
		U006	105

Exclusive Parts

Number	Part Name	Group	ID
		U019	25
AA143810	DEVELOPMENT COVER SCREW	U006	106
AA143811	STEPPED SCREW - M3X4	U017	33
AA143812	SCREW - SCALE	U007	51
AA143816	FLAT SCREW:CHUCK:BOTTLE	U008	43
AA143842	SCREW:DIA6:14.5:M4	U003_S001	64
AA143846	TAPPING SCREW:M3X6	U003_S001_S015	65
AA143847	STEPPED SCREW:DIA5:3.5:M3	U015_S001	43
		U015_S003	43
		U015_S004	43
AA148778	SHAFT:ARM:PLATE	U006	107
AA152299	BOTTLE HOLD SEAL	U008	44
AA161104	CUSHION - MOTOR	U004	18
AA161177	CUSHION:BASE:TANDEM LCT:LARGE	U006_S017	390
		U006_S019	390
		U006_S021	390
AA161178	CUSHION:BASE:TANDEM LCT:SMALL	U006_S017	391
		U006_S019	391
		U006_S021	391
AA161180	CUSHION:DC STEPPER MOTOR	U006	110
		U007	52
		U016	45
		U017	34
AB010219	GEAR:STOPPER:OIL SUPPLY ROLLER	U015_S002	44
AB011125	GEAR:20/29Z	U012_S001	26
AB011126	GEAR:20Z	U012_S001	27
AB011392	DRIVE REVERSE GEAR - 24Z	U006_S014	111
		U006_S015	111
		U006_S016	111
AB011540	GEAR:AGITATOR:DRIVE	U013_S003	20
AB011591	GEAR:REVERSE	U006_S014	112
		U006_S015	112
		U006_S016	112
AB011626	GEAR:IDLER:EXIT:CONNECTING	U016	46
AB011627	GEAR:EXIT:25Z	U016	47
AB012005	GEAR - 13Z	U008	45
AB012007	GEAR - 14Z	U008	46

Number	Part Name	Group	ID
AB012008	GEAR - 23Z	U008	47
AB012327	GEAR:16Z	U006_S001	113
		U006_S002	113
AB013781	GEAR - 30Z	U006_S017	114
		U006_S019	114
		U006_S021	114
AB013798	GEAR - Z18	U006_S018	115
		U006_S020	115
		U006_S022	115
AB014229	COUPLEDGEAR - 17Z/32Z	U015_S001_S007	45
		U015_S003_S007	45
		U015_S004_S007	45
AB014243	GEAR:IDLER:Z30	U007	53
AB014287	GEAR:IDLER:FUSING	U015_S001_S005	46
		U015_S003_S005	46
		U015_S004_S005	46
AB017514	DOUBLE GEAR - 12/27Z	U008	48
AB017515	DOUBLE GEAR - 12/23Z	U008	49
AB017725	GEAR/TIMING PULLEY - 20Z/20T	U006	116
AB017726	GEAR/TIMING PULLEY - 20Z/20T	U006	117
AB017771	GEAR:TRANSPORT ROLLER:INPUT:Z23/Z28	U006_S014	118
		U006_S015	118
		U006_S016	118
AB017961	GEAR:EXIT:70Z/T24	U016	48
AB017962	GEAR:IDLER:EXIT	U016	49
AB019475	GEAR - 48T	U006_S018	119
		U006_S020	119
		U006_S022	119
AB030842	TIMING PULLEY:S2M:30T	U007	54
		U017	35
AB030877	TIMING PULLEY:Z51	U013	21
AB030880	PULLEY:S2M:22T	U016	50
AB032058	WIRE PULLEY - M10	U006_S017	120
		U006_S019	120
		U006_S021	120
AB032072	PULLEY:DRIVEN:WIRE	U010_S001	34
AB032719	PULLEY - M10	U006_S017	121
		U006_S019	121

Exclusive Parts

Number	Part Name	Group	ID
		U006_S021	121
AB033084	TIMING PULLEY - 15T	U006_S018	122
		U006_S020	122
		U006_S022	122
		U006_S022	122
AB033085	TIMING PULLEY - 15T	U006_S018	123
		U006_S020	123
		U006_S022	123
AB033118	TORQUE LIMITER MECHANICAL CLUTCH:TONER RECYCLING SUB-UNIT	U013_S001	22
AB033119	TIMING PULLEY:Z25:Z14	U013_S002	23
AC020152	LENS:LED:3	U001	14
AC020153	LENS:LED:4	U001	15
		U006	124
AC030211	MIRROR:NO.1	U004_S002	19
AE010130	HOT ROLLER:DIA54:ASS'Y	U015_S001	47
		U015_S003	47
		U015_S004	47
AE012048	HEAT ROLLER:DIA39.2	U015_S001	170
		U015_S003	170
		U015_S004	170
AE020220	PRESSURE ROLLER:DIA65	U015_S001	49
		U015_S003	49
		U015_S004	49
AE030030	BALL BEARING - 8X19X6	U015_S001	50
		U015_S001_S004	50
		U015_S001_S005	50
		U015_S001_S006	50
		U015_S003	50
		U015_S003_S004	50
		U015_S003_S005	50
		U015_S003_S006	50
		U015_S004	50
		U015_S004_S004	50
		U015_S004_S005	50
U015_S004_S006	50		
AE030044	BALL BEARING - 10X22X6	U015_S001	51
		U015_S003	51

Number	Part Name	Group	ID
		U015_S004	51
AE030049	BALL BEARING -20X32X7	U015_S001	52
		U015_S003	52
		U015_S004	52
		U015_S004	52
AE030086	RADIAL BALL BEARING:DIA25XDIA37X7	U015_S001	53
		U015_S003	53
		U015_S004	53
AE031032	BUSHING - 6X9X6.5	U015_S002	54
AE031037	BUSHING - M4	U015_S001_S007	55
		U015_S003_S007	55
		U015_S004_S007	55
AE032034	THERMAL INSULATING BUSHING:DIA22	U015_S001	56
		U015_S003	56
		U015_S004	56
AE044075	STRIPPER PAWLS	U015_S001	57
		U015_S003	57
		U015_S004	57
AE045065	WEB:SUB-ASS'Y	U015_S002	58
AF013029	PAD:BASE	U006_S001_S001	396
		U006_S002_S001	396
AF017033	END FENCE	U006_S001	126
		U006_S002	126
AF020740	TRANSPORT ROLLER:VERTICAL TRANSPORT:DRIVE	U006	127
AF020743	TRANSPORT ROLLER:DRIVE:PAPER FEED UNIT	U006_S014	128
		U006_S015	128
		U006_S016	128
AF020744	TRANSPORT ROLLER:DRIVEN:PAPER FEED UNIT	U006_S014	129
		U006_S015	129
		U006_S016	129
AF022064	TRANSPORT ROLLER:DRIVEN	U014	11
AF022067	GUIDE STOPPER ROLLER	U017	36
AF022105	ROLLER - SLIDE RAIL	U006_S017	130
		U006_S019	130
		U006_S021	130
AF022165	TRANSPORT ROLLER - DRIVEN	U006	131
		U006_S013	131
AF022167	TRANSPORT ROLLER - DRIVEN	U007	55

Exclusive Parts

Number	Part Name	Group	ID
AF022182	TRANSPORT ROLLER:DRIVEN:DIA 17.5X2	U016	51
		U016_S010	51
		U017	37
AF030173	(EPDM):(For standard use):PAPER FEED ROLLER:PICKUP	U006_S014	419
		U006_S015	419
		U006_S016	419
AF031098	PAPER FEED ROLLER:FEED	U006_S014	399
		U006_S015	399
		U006_S016	399
AF031140	(EPDM):PAPER FEED ROLLER:FE ED	U006_S014	417
		U006_S015	417
		U006_S016	417
AF032098	PAPER FEED ROLLER:SEPARATE	U006_S014	400
		U006_S015	400
		U006_S016	400
AF032140	(EPDM):PAPER FEED ROLLER:SE PARATE	U006_S014	418
		U006_S015	418
		U006_S016	418
AG050100	KNOB - TRANSPORT ROLLER	U007	56
		U016	52
		U017	38
AG050101	KNOB - MISFEED REMOVAL	U006	135
AG051141	RELEASE LEVER	U007	57
AG070022	MAGNET CATCH:25.5N	U008	50
AG070513	MAGNET CATCH	U007	58
AG071012	MAGNET CATCH:ASS'Y	U013	24
AH012031	CASTER:1470N	U022	34
AW010113	SENSOR	U006_S017	136
		U006_S019	136
		U006_S021	136
AW010134	ORIGINAL SENSOR - 48MM	U004	20
AW010143	PHOTO REFLECTION SENSOR:PS R11TL1R-C	U017	39
AW010147	PHOTO REFLECTION SENSOR	U014	12
		U015_S001	59
		U015_S003	59
		U015_S004	59
AW010150	PHOTO REFLECTION SENSOR:ORI	U003_S001	66

Number	Part Name	Group	ID
	GINAL TRAY		
AW010151	PHOTO REFLECTION SENSOR:PS1 22TL1-A	U003_S001	67
		U006_S014	137
		U006_S015	137
		U006_S016	137
AW010200	PAPER FEED SENSOR:FUSING EX IT	U016	53
AW020146	PHOTOINTERRUPTOR:FLAT:PICH 2MM:M4	U022	35
AW020163	PAPER FEED SENSOR	U006_S018	138
		U006_S020	138
		U006_S022	138
AW020190	PHOTOINTERRUPTOR	U003_S001	68
AW020200	POSITIONING SENSOR:FLAT BELT -TRANSFER	U010_S001	36
AW020234	PHOTOINTERRUPTOR:GP1A173L CS5F	U003_S001	276
AW100107	THERMISTOR	U021	19
AW100183	THERMOPILE	U015	165
AW110052	THERMOSTAT:211C	U015_S001	62
		U015_S003	62
		U015_S004	62
		U015_S004	62
AW110122	THERMOSTAT:225C:250V/17A	U015_S001	63
		U015_S003	63
		U015_S004	63
AW140026	TEMPERATURE & HUMIDITY SEN SOR	U013	63
AW140027	TEMPERATURE & HUMIDITY SEN SOR	U009	153
AW500010	PUSH SWITCH	U006	140
AW500045	PUSH SWITCH	U006	141
		U010_S001	37
		U013	27
AX040199	DC MOTOR:RISING TRAY:ASS'Y	U006_S006	142
		U006_S007	142
AX040254	DC MOTOR:RISING TRAY:ASS'Y:1. 007W:BRUSH	U003_S001_S008	70
AX040276	STEPPER MOTOR:MM56:TRANSP	U006	143

Exclusive Parts

Number	Part Name	Group	ID
	ORT	U007	60
		U016	55
		U017	40
AX040279	STEPPER MOTOR:PAPER TRANS PORT MD:MM42	U006	144
AX040280	STEPPER MOTOR:DRIVE	U007	61
		U016	56
AX040297	STEPPER MOTOR:MM56:TRANSP ORT	U007	62
AX040300	DC MOTOR:CLEANER:ASS'Y	U015_S001_S007	64
		U015_S003_S007	64
		U015_S004_S007	64
AX060393	DC STEPPER MOTOR:MM42:1.3A: 4.42V	U010_S001	38
AX060394	DC STEPPER MOTOR:MM42:1.2A: 3.60V	U010_S001	39
AX060424	DC STEPPER MOTOR:MM56XL76	U007	63
AX061102	DC BRUSHLESS MOTOR:25W:NM B:EXIT	U016	57
AX400178	(NA):HEATER:240V:18W:UPPER	U006_S003	145
		U006_S004	145
AX400275	HEATER:230V:9W	U010_S001	133
AX440358	(NA):HEATER:PRESSURE ROLLER :208V:800W:INFRARED	U015_S001	65
AX440359	(CHN/EU,AA,TWN,KOR):HEATER:P RESSURE ROLLER:220V:800W:INF RARED	U015_S003	66
		U015_S004	66
AX450066	(NA):HEATER:HEAT ROLLER:205V: 997WX3:INFRARED	U015_S001	67
AX450067	(CHN/EU,AA,TWN,KOR):HEATER:H EAT ROLLER:227V:1070WX3:INFR ARED	U015_S003	68
		U015_S004	68
AX640224	DC FAN MOTOR:AXIAL:MM80	U021	20
AX640330	FAN:SIROCCO:DIA51	U021	21
AX650048	FAN:SIROCCO:1.44W	U010_S002	41
AX650056	DC FAN MOTOR:AXIAL:MM92	U021	22
AX660015	DC FAN MOTOR:SIROCCO:DC24V: PWM	U021	23

Number	Part Name	Group	ID
AZ240355	POWER SUPPLY UNIT:ECO	U020_S002	56
AZ240356	POWER SUPPLY UNIT:FW	U020	57
AZ250066	POWER SUPPLY UNIT:864W	U020	17
AZ310032	POWER PACK:D	U012	28
AZ320193	POWER PACK:CGB	U019	26
AZ320194	POWER PACK:T1/T2	U010_S001	42
B0434645	SPRING - 2N	U003_S001	71
B0651374	CLOTH - DF EXPOSURE GLASS	U023	12
B0654935	LEVER:GUIDE PLATE:ASS'Y	U017	41
B0656136	TRAY LOCK ARM	U006	146
B0656345	PAPER END SENSOR BRACKET	U006_S014	147
		U006_S015	147
		U006_S016	147
B0656524	BOTTOM PLATE LIFT SHAFT	U006_S001	148
		U006_S002	148
B0656526	LIFT LEVER	U006_S001	149
		U006_S002	149
B0656545	DECAL - POSITIONING	U006_S001	150
		U006_S002	150
B0656589	LEFT SUPPORT PLATE	U006	393
B0656591	PAPER TRAY HOLDER BASE	U006	151
B0656717	PAPER VOLUME SHIELD PLATE	U006_S017	152
		U006_S019	152
		U006_S021	152
B0656769	LOCK ARM	U006	153
B0656823	TIMING BELT COVER	U006_S018	154
		U006_S020	154
		U006_S022	154
B0656830	PULLEY BRACKET	U006_S018	155
		U006_S020	155
		U006_S022	155
B0656831	SENSOR BRACKET	U006_S018	156
		U006_S020	156
		U006_S022	156
B0656862	LARGE LEVER	U006_S017	157
		U006_S019	157
		U006_S021	157
B0656864	SMALL LEVER	U006_S017	158

Exclusive Parts

Number	Part Name	Group	ID
		U006_S019	158
		U006_S021	158
B0656870	STAY -RIGHTBASE	U006_S017	159
		U006_S019	159
		U006_S021	159
B0656872	OIL DAMPER BRACKET	U006_S017	160
		U006_S019	160
		U006_S021	160
B0656875	PROTECTION -INNER COVER	U006_S017	161
		U006_S019	161
		U006_S021	161
B0706667	END FENCE COVER FRONT	U006_S017	162
		U006_S019	162
		U006_S021	162
B0706683	LEVER:RELEASE:FRONT	U006_S017	163
		U006_S019	163
		U006_S021	163
B0706684	LEVER:RELEASE:REAR	U006_S017	164
		U006_S019	164
		U006_S021	164
B0706849	GUIDE:POSITIONING	U020	18
B1202063	BUSHING - 4MM	U012_S001_S001	29
B1253659	CUSHION:SWIVEL:STOPPER	U016	58
B1321183	BRACKET:LOCK	U022	36
B1321221	HOLDER:SPRING:PULL OUT	U022	37
B1322264	BUSHING:TERMINAL	U011_S001	8
		U016	59
B1323861	PTB UNIT GUIDE PLATE	U014	13
B1324167	GRIP:OIL APPLICATION UNIT:FIBER	U015_S001	69
		U015_S003	69
		U015_S004	69
B1324196	SPRING:PICK-OFF PAWL	U015_S001	70
		U015_S003	70
		U015_S004	70
B1324197	TORSION SPRING:LEVER	U015_S001	71
		U015_S003	71
		U015_S004	71
B1324265	ROLLER:PICK-OFF PAWL	U015_S001	72

Number	Part Name	Group	ID
		U015_S003	72
		U015_S004	72
B1324268	HOLDER:ROLLER:PICK-OFF PAWL	U015_S001	73
		U015_S003	73
		U015_S004	73
B1326655	STEPPER MOTOR:PAPER FEED UNIT:ASS'Y	U014	14
B1326726	BRACKET:ARM:ASS'Y	U006	165
B1326764	BRACKET:CONNECTOR:RIGHT	U006	166
B1326791	PLATE:SIDE FENCE	U006_S001_S003	167
		U006_S002_S003	167
B1326797	SIDE FENCE:REAR:AUXILIARY	U006_S001	168
		U006_S002	168
B1326798	SPRING PLATE:PAPER TRAY:EAR TH	U006_S001	169
		U006_S002	169
B1327541	TRAY BOTTOM PLATE:LEFT REAR	U006_S018	170
		U006_S020	170
		U006_S022	170
B1327550	COVER:PULLEY:DRIVE WERE	U006_S017	171
		U006_S019	171
		U006_S021	171
B1327561	BACK FENCE:LEFT	U006_S018	172
		U006_S020	172
		U006_S022	172
B1327564	SLIDER:BACK FENCE:LEFT	U006_S018	173
		U006_S020	173
		U006_S022	173
B1327575	BRACKET:CONNECTOR:TANDEM LCT	U006_S017	174
		U006_S019	174
		U006_S021	174
B1327591	RAIL:PAPER TRAY:ASS'Y	U006	175
B1329700	LUBRICANT POWDER	SPECIAL TOOLS	5
B1406221	HEAT SINK:HEATER:LOWER:SUB-ASS'Y	U006_S003	176
B1406226	(NA):HEAT SINK:HEATER:LOWER:ASS'Y	U006_S003	177
B1816780	LINK:END FENCE:PAPER SIZE SENSOR:ASS'Y	U006_S001	178
		U006_S002	178

Exclusive Parts

Number	Part Name	Group	ID
B1816789	LINK:SIDE FENCE:PAPER SIZE SENSOR	U006_S001	179
		U006_S002	179
B2341118	FLY WHEEL FLANGE	U018	24
B2341542	SPACER - TOUCH PANEL L	U002_S001	19
		U002_S002	19
		U002_S003	19
B2341543	SPACER - TOUCH PANEL S	U002_S001	20
		U002_S002	20
		U002_S003	20
B2342125	SPRING - GRID	U009_S002	31
B2342390	FLANGED HEXAGONAL HEAD BOLT:M4X8	U001	16
		U009	32
		U011	9
		U012	30
B2342624	BALL BEARING - 8X12X5	U006_S014	180
		U006_S015	180
		U006_S016	180
B2342864	PAD:CLEANER	U006_S001_S002	181
		U006_S001_S003	181
		U006_S002_S002	181
		U006_S002_S003	181
B2343356	JOINT:CHUCK:TONER BOTTLE	U008	52
B2344244	GEAR - 50Z	U015_S002	75
B2344258	CAP:HEAT PIPE	U016	60
B2344460	DISCHARGE BRUSH - L=341 SUS	U016	61
B2345280	PCB CRB	U007	64
B2346120	BRACKET:POSITIONING:PAPER TRAY	U006	182
B2346141	POSITIONING SLEEVE - INNER BRACKET	U006	183
		U006_S017	183
		U006_S019	183
		U006_S021	183
B2346181	SLIDE RAIL - RIGHT	U006	184
B2346188	SLIDE SLEEVE POSITIONING	U006	185
B2346198	COVER - SPAPER SIZE SENSOR	U006	186
B2346222	REVERSE DRIVE SHAFT	U006_S014	187
		U006_S015	187

Number	Part Name	Group	ID
		U006_S016	187
B2346223	DRIVEN REVERSE SHAFT	U006_S014	188
		U006_S015	188
		U006_S016	188
B2346242	GUIDE - ROLLER:DRIVEN PRESSURE	U006_S014	189
		U006_S015	189
		U006_S016	189
B2346275	PICKUP ARM	U006_S014	190
		U006_S015	190
		U006_S016	190
B2346288	BSENSOR BRACKET - SENSOR	U006_S014	191
		U006_S015	191
		U006_S016	191
B2346301	TORQUE LIMITER:75MN M	U006_S014	192
		U006_S015	192
		U006_S016	192
B2346424	RELEASE GRIP	U007	65
		U016	62
B2346455	BRACKET - UPPER	U006	193
B2346475	BRACKET - LOWER	U006	194
B2346495	GUIDE:FRONT:PAPER TRAY	U006	195
B2346497	GUIDE:REAR:PAPER TRAY	U006	196
B2346498	SHEET:TRAY BOTTOM PLATE	U006_S001	197
		U006_S002	197
B2346506	TIMING PULLEY - 30T	U006	198
B2346508	TENSION SPRING	U006	199
		U007	66
B2346514	TIMING BELT - S2M126	U006	200
B2346530	BRACKET	U006	201
B2346531	TIGHTENER BRACKET	U006	202
B2346532	TIGHTENER BRACKET	U006	203
B2346533	TIMING BELT - S2M152	U006	204
		U007	67
B2346542	GRIP DRIVE SHAFT	U006	206
B2346565	HARNESS CLAMP BRACKET	U006	207
B2346606	SENSOR BRACKET	U006_S017	208
		U006_S019	208
		U006_S021	208

Exclusive Parts

Number	Part Name	Group	ID
B2346612	END FENCE - FRONT	U006_S017	209
		U006_S019	209
		U006_S021	209
B2346625	END FENCE - REAR	U006_S017	210
		U006_S019	210
		U006_S021	210
B2346630	(CHN/EU,AA,TWN,KOR):GUIDE PLATE - END FENCE	U006_S019	211
		U006_S021	211
B2346686	SIDE FENCE - RIGHT FRONT	U006_S017	212
		U006_S019	212
		U006_S021	212
B2346691	SIDE FENCE:TANDEM LCT:RIGHT:ASS'Y	U006_S017_S001	213
		U006_S019_S001	213
		U006_S021_S001	213
B2347540	TRAY BOTTOM PLATE:LEFT FRONT	U006_S018	214
		U006_S020	214
		U006_S022	214
B2382675	REGISTRATION ROLLER BUSHING	U007	68
B2476672	GUIDE:INTERLOCK:TANDEM LCT	U006_S017	215
		U006_S019	215
		U006_S021	215
B2476695	GUIDE:MISFEED REMOVAL:PAPER TRAY	U006_S001	216
		U006_S002	216
		U006_S017	216
		U006_S019	216
		U006_S021	216
B2476753	LOCK SPRING - LARGE	U006	217
B2476754	LOCK SPRING - SMALL	U006	218
B2476901	OIL DAMPER:FALL	U006_S017	219
		U006_S019	219
		U006_S021	219
B2476950	SHAFT:SLIDER:BACK FENCE	U006_S018	220
		U006_S020	220
		U006_S022	220
B2476951	BRACKET:PULLEY:DRIVEN:ASS'Y	U006_S018	221
		U006_S020	221
		U006_S022	221

Number	Part Name	Group	ID
B2591106	FAN MOTOR:MM80:DC24V 3.6W	U020	19
B3033682	MISFEED REMOVAL KNOB	U006	222
B3863320	SPRING:BELT:PAPER FEED:8N	U003_S001_S007	72
B3871951	SPRING - PAPER SIZE SENSOR	U003_S001	73
B3872113	ROLLER - PAPER FEED BELT	U003_S001_S007	74
B4772227	PICKUP ROLLER:COUPLING	U003_S001_S007	75
B4772622	DISCHARGE BRUSH:L11	U003_S001	76
B4774117	SPRING	U003_S001_S015	77
B4774129	SPRING - 12N	U003_S001_S011	78
B4774131	SPRING	U003_S001	79
B5457506	SCREW:BUSHING	U011_S001	10
B5991225	MAGNET CATCH:78.4N	U019	27
B6455010	SD-CARD:ASS'Y	SPECIAL TOOLS	6
B6523174	TENSION SPRING	U003_S001	81
B7001802	TIMING BELT:B40S2M134	U011_S001	11
B7005804	STEPPER MOTOR:DIA42:Z17:ASS'Y	U009	33
B7061859	SCREW:SLIDER:LOCK	U003_S001	83
B7125605	GRIP:APPLICATION	U004	22
		U010_S002	43
B7892114	PAPER FEED BELT ROLLER	U003_S001_S007	84
B8022532	SPRING PLATE:SIDE FENCE	U003_S001	85
B8022536	SLIDER:SIDE FENCE	U003_S001	86
B8041180	DISCHARGE BRUSH:PUNCH UNIT	U003_S001	87
		U003_S001_S009	87
		U003_S001_S011	87
B8301135	SCREW	U003_S001	88
		U007	69
B8304263	TIMING BELT - 60S2M140	U016	63
B8321371	SPACER CUSHION	U022	38
B8341648	TIMING BELT - B60S2M120	U007	70
B8343312	COLLAR	U006	223
BB013007	GEAR - 20Z	U006_S014	224
		U006_S015	224
		U006_S016	224
BB013008	GEAR - 31Z	U006_S014	225
		U006_S015	225
		U006_S016	225

Exclusive Parts

Number	Part Name	Group	ID
BB013025	GEAR:PRESSURE ROLLER	U015_S001	76
		U015_S003	76
		U015_S004	76
BB013028	GEAR:IDLER:35Z:ASS'Y	U015_S001_S004	77
		U015_S003_S004	77
		U015_S004_S004	77
BB013036	GEAR:IDLER:25Z:ASS'Y	U015_S001	78
		U015_S003	78
		U015_S004	78
BB013038	GEAR:HOT ROLLER:ASS'Y	U015_S001_S006	80
		U015_S003_S006	80
		U015_S004_S006	80
BB013040	GEAR:SHIFT:ROLLER:Z30	U007	71
C1012360	SNAP RING	U001	17
C2182185	STEPPER SCREW	U019	28
C2383879	TIMING BELT	U010_S001	44
C2443522	STEPPED SCREW	U006_S014	226
		U006_S015	226
		U006_S016	226
C2672944	SCREW:ACTUATOR:SURFACE OF PAPER SENSOR	U001	18
C2693566	BUSHING:MM8:PRESSURE:DRIVE	U006	227
C4019503	20X MAGNIFICATION SCOPE	SPECIAL TOOLS	7
D0144192	CLAMP:HARNESS	U005_S001	10
D0144247	HOUSING - TEMPERATURE SENSOR	U015_S001	81
		U015_S003	81
		U015_S004	81
D0145973	COVER:SD-CARD	U020	20
D0146272	BUSHING:BRUSH:REAR	U012_S001	31
D0146627	BRACKET:ON OFF DETECTOR:REAR	U006_S017	381
		U006_S019	381
		U006_S021	381
D0146784	SPRING PLATE:END FENCE	U006_S001	229
		U006_S002	229
D0146785	SPRING PLATE:ARM:END FENCE:LOCK	U006_S001	230
		U006_S002	230
D0159500	G104 YELLOW TONER	SPECIAL TOOLS	8
D0159501	ZINC STEARATE	SPECIAL TOOLS	9

Number	Part Name	Group	ID
D0291749	PULLEY:PROTECTION	U004	23
D0396327	SPACER:SENSOR:TM	U010_S001	45
D0462862	(NA):DECAL:H-TEMP WARNING:HEATER	U006	231
D0464655	TIMING BELT:S2M180	U016	64
D0592399	FLANGED HEXAGONAL HEAD BOLT:M3*4	U006	233
		U007	72
D0592469	SCREW:ROUND POINT:M4X6	U009	34
D0592620	RETAINING RINGS-C	U006_S014	234
		U006_S015	234
		U006_S016	234
D0596121	SPRING:CONNECTOR:TANDEM LCT	U006	235
D0596169	STAY:TANDEM LCT:ASS'Y	U006	236
D0596170	BRACKET:SLIDE RAIL:PAPER TRAY:2:ASS'Y	U006	237
D0596172	PAPER TRAY STOPPER	U006	238
D0596212	LEVER:PRESSURE:REVERSE	U006_S014	239
		U006_S015	239
		U006_S016	239
D0596277	COVER:GEAR:PAPER FEED ROLLER	U006_S014	240
		U006_S015	240
		U006_S016	240
D0596278	COVER:GEAR:REVERSE	U006_S014	241
		U006_S015	241
		U006_S016	241
D0596496	GUIDE:MIDDLE:PAPER TRAY	U006	242
D0596591	SPRING:PAPER TRAY:LOCK	U006	243
D0596620	LEVER:COUPLING:LEFT	U006_S018	244
		U006_S020	244
		U006_S022	244
D0596659	SUPPORTING PLATE:SIDE FENCE:LEFT	U006_S018	246
		U006_S020	246
		U006_S022	246
D0596664	GUIDE:MIDDLE:PAPER TRAY	U006	247
D0596665	BRACKET:DC MOTOR:LEFT:ASS'Y	U006_S018	248
		U006_S020	248
		U006_S022	248

Exclusive Parts

Number	Part Name	Group	ID
D0596668	SIDE PLATE:SIDE:TANDEM LCT	U006_S017	249
		U006_S019	249
		U006_S021	249
D0596712	INNER COVER:TANDEM LCT	U006_S017	250
		U006_S019	250
		U006_S021	250
D0596721	STOPPER:PAPER TRAY	U006	251
D0596725	BRACKET:STOPPER:PAPER TRAY :RIGHT:PEEN	U006	252
D0626692	SLIDE RAIL:PAPER TRAY:LEFT:SU B-ASS'Y	U006	253
D0741180	LEVER:PULL OUT:PAPER EXIT UN IT	U022	39
D0741195	GUIDE:LOCK:TRANSPORT UNIT	U022	40
D0741225	HINGE:C/T BOX:RIGHT UPPER:PE EN	U022	41
D0741228	COVER:HINGE	U022	42
D0741250	ARM:HINGE:C/T BOX	U020	21
D0741255	SEPARATION PLATE:DUCT	U020	22
D0741329	DC MOTOR:DIA49:24V:6.3W	U018	25
D0741454	DC MOTOR:DIA49:9.8W:BLS	U018	26
D0742459	JOINT:CLEANING UNIT	U009_S001_S002	35
D0742541	DECAL:ARROW LABEL	U009_S004	36
D0742542	DECAL:GRIP	U009_S001_S002	37
D0742577	CONNECTOR:DRAWER:4POLE:RE C	U009	38
D0742632	BRACKET:DC STEPPER MOTOR:M M56:CAM	U016	65
		U017	42
D0742652	LEVER:LINK:TRANSPORT ROLLER	U007	73
D0742681	SHAFT:CAM:SHIFT	U007_S008	75
D0742739	PRESSURE ROLLER:TRANSPORT ROLLER:SHIFT:DRIVEN	U007_S009	77
		U007_S010	77
		U007_S011	77
		U007_S012	77
D0742744	HOLDER:SHIFT:BEARING:FRONT	U007	78
D0742799	GUIDE PLATE:CONNECTION:LCT: LOWER	U007	79
D0742938	GUIDE PLATE:CONNECTION:LAR	U007	80

Number	Part Name	Group	ID
	GE CAPACITY TRAY:UPPER:PEEN		
D0742942	PIN:GUIDE PLATE:CONNECTION:L ARGE CAPACITY TRAY:UPPER	U007	81
D0742952	BRACKET:CONTACT IMAGE SENS OR	U007	82
D0742970	CAM:GUIDE PLATE:OPEN AND CL OSE	U007	83
D0743047	BRACKET:HOLDER:DUPLEX:ASS'Y	U017	43
D0743168	CONTACT IMAGE SENSOR:REGIS TRATION:MAIN SCANNING:214MM	U007	84
D0743173	TIMING PULLEY:S2M:25T	U006	254
		U016	66
		U017	44
D0743824	PLATE:ROLLER:INTERMEDIATE T RANSFER	U010_S001	46
D0743829	DECAL:POSITIONING DISPLAY:TC RU	U001	19
		U009	39
		U009_S004	39
		U015_S001_S002	82
		U015_S003_S002	82
	U015_S004_S002	82	
D0743871	STOPPER:WIRE:PULLEY	U010_S001	47
D0743872	PULLEY:DRIVE WERE:ASS'Y	U010_S001	48
D0743878	HOLDER:RADIAL BALL BEARING:D RIVEN ROLLER:INNER BACK	U010_S001	49
D0743896	COVER:POSITIONING SENSOR:FL AT BELT-TRANSFER	U010_S001	50
D0744063	HOUSING:THERMOSTAT:ASS'Y	U015_S001	83
		U015_S003	83
		U015_S004	83
D0744064	COVER:THERMOSTAT:PRESSURE	U015_S001	84
		U015_S003	84
		U015_S004	84
D0744067	LEVER:CONTROL PLATE:PRESSU RE	U015_S001	85
		U015_S003	85
		U015_S004	85
D0744070	SUPPORTING PLATE:LEVER:PRE SSURE	U015_S001	86
		U015_S003	86

Exclusive Parts

Number	Part Name	Group	ID
		U015_S004	86
D0744072	STEPPED SCREW:M5	U015_S001	87
		U015_S003	87
		U015_S004	87
D0744102	COLLAR:DIA10X:DIA14X:12	U015_S001	88
		U015_S003	88
		U015_S004	88
D0744103	CAM:PRESSURE:A	U015_S001	89
		U015_S003	89
		U015_S004	89
D0744104	FEELER:CAM:PRESSURE:FRONT	U015_S001	90
		U015_S003	90
		U015_S004	90
D0744105	FEELER:CAM:PRESSURE:REAR	U015_S001	91
		U015_S003	91
		U015_S004	91
D0744107	COLLAR:DIA10XDIA14X9.4	U015_S001	92
		U015_S003	92
		U015_S004	92
D0744180	HOUSING:THERMOSTAT:HEAT ROLLER:ASS'Y	U015_S001	93
		U015_S003	93
		U015_S004	93
D0744181	ELECTRODE PLATE:THERMOSTAT:HEAT ROLLER:MIDDLE	U015_S001	94
		U015_S003	94
		U015_S004	94
D0744182	ELECTRODE PLATE:THERMOSTAT:HEAT ROLLER	U015_S001	95
		U015_S003	95
		U015_S004	95
D0744225	KNOB:FUSING	U023_S001	13
D0744227	BOLT:M5:ROUND POINT	U015_S001	97
		U015_S003	97
		U015_S004	97
D0744302	PLAIN SHAFT BEARING:ROLLER:REAR	U015_S002	98
D0744336	DECAL:WARNING (REMOVAL AND INSTALLATION):FUSING	U015_S001_S002	99
		U015_S003_S002	99
		U015_S004_S002	99
D0744351	STEPPED SCREW:DIA5.4DIA:DIA3.	U010	51

Number	Part Name	Group	ID
	5:M3	U015	100
D0744380	DECAL:H-TEMP WARNING:FUSING:WEB	U015_S002_S001	101
D0744390	ACCESSORY:KNOB:FUSING:ASS'Y	U023_S001	14
D0744391	HOLDER:KNOB:FUSING:DUAL FACES TEPE	U023_S001	15
D0744698	LEVER:LOCK:GUIDE PLATE	U016	67
D0745100	SD-CARD:NICE:REGI:ASS'Y	SPECIAL TOOLS	10
D0745101	SD-CARD:NICE:REGI2:ASS'Y	U019	47
D0746092	BRACKET:HEATER:INTERMEDIATE TRANSFER	U010_S001	52
D0746097	THERMOSTAT:INTERMEDIATE TRANSFER	U010_S001	53
D0746134	PLAIN SHAFT BEARING:INSULATE	U010_S001	54
D0746146	BRACKET:BIAS:INTERMEDIATE TRANSFER	U010_S001	57
D0746147	TERMINAL:INTERMEDIATE TRANSFER	U010_S001	58
D0746161	COVER:BIAS:INTERMEDIATE TRANSFER	U010_S001	59
D0746165	PULLEY:ON-OFF:BELT TENSIONER	U007	85
D0746180	COMPRESSION SPRING:BIAS:INTERMEDIATE TRANSFER	U010_S001	60
D0746197	TERMINAL:CONNECTING:BIAS:INTERMEDIATE TRANSFER	U010_S001	61
D0746216	SHUTTER:TONER OUTLET SUB-UNIT:SUB-ASS'Y	U012_S001	32
D0746219	COIL SPRING:SHUTTER:DISCHARGE USED TONER	U012_S001	33
D0746228	ELECTRODE PLATE:FRAME	U012_S001	34
D0746235	CASE:TONER RECYCLING SUB-UNIT:SUB-ASS'Y	U012_S001	35
D0746238	JOINT:TRANSFER:DRIVE	U012	36
D0746241	DECAL:GRIP:TRANSFER/SEPARATION UNIT	U012_S001	37
D0746257	BRUSH ROLLER:APPLY:ASS'Y	U012_S001	39
D0746265	BLADE:TRANSFER ROLLER:ASS'Y	U012_S001	40

Exclusive Parts

Number	Part Name	Group	ID
D0746270	HOLDER:BLADE:ASS'Y	U012_S001	41
D0746273	SEAL:HOLDER	U012_S001	42
D0746274	SEAL:HOLDER:UPPER	U012_S001	43
D0746276	PIN:POSITIONING PLATE:BLADE:TRANSFER ROLLER:ASS'Y	U012_S001	44
D0746279	COIL SPRING:BLADE:TRANSFER ROLLER	U012_S001	45
D0746283	(Set part number:D1796280):SHIELD:GUIDE PLATE:ENTRANCE:LOWER	U012_S001	85
D0746312	GEAR:IDLER:TRANSFER ROLLER	U012_S001	46
D0746313	GEAR:IDLER:COLLECTION COIL	U012_S001	47
D0746314	GEAR:COLLECTION COIL	U012_S001	48
D0746315	GEAR:BRUSH:APPLY	U012_S001	49
D0746410	GROUND PLATE:BELT CLEANING	U011_S001	12
D0746411	COIL SPRING:EARTH:BELT CLEANING	U011_S001	13
D0746413	SCRAPER:BRUSH:REMOVE PAPER DUST:ASS'Y	U011_S001	14
D0746424	BLADE:CLEANING:BELT CLEANING:ASS'Y	U011_S001	16
D0746428	HOLDER:CLEANING:BELT CLEANING:ASS'Y	U011_S001	17
D0746431	COIL SPRING:BLADE:CLEANING:BELT CLEANING	U011_S001	18
D0746434	TONER COLLECTION COIL:BELT CLEANING:ASS'Y	U011_S001	19
D0746439	PLAIN SHAFT BEARING:REMOVE PAPER DUST:TRANSPORT SCREW	U011_S001	20
D0746440	GUIDE:DISCHARGE USED TONER:BELT CLEANING	U011_S001	21
D0746441	SHUTTER:TRANSPORT SCREW:BELT CLEANING	U011_S001	22
D0746442	COIL SPRING:DISCHARGE USED TONER	U011_S001	23
D0746443	SEAL:DISCHARGE USED TONER	U011_S001	24
D0746454	ARM:COATING BAR:BELT CLEANING	U011_S001_S001	27

Number	Part Name	Group	ID
	NG		
D0746457	BLADE:APPLY:ASS'Y	U011_S001	29
D0746461	HOLDER:APPLY:BELT CLEANING:ASS'Y	U011_S001	30
D0746464	COIL SPRING:BLADE:APPLY:BELT CLEANING	U011_S001	31
D0746467	COIL SPRING:STOPPER:CASE:BELT CLEANING	U011_S001	32
D0746468	STOPPER:CASE:BELT CLEANING	U011_S001	33
D0746469	SLIDE RAIL:UPPER:BELT CLEANING	U011_S001	34
D0746470	RELEASE PLATE:BLADE:CLEANING	U011_S001	35
D0746471	RELEASE PLATE:BLADE:APPLY	U011_S001	36
D0746477	GEAR:BRUSH:REMOVE PAPER DUST:Z17	U011_S001	37
D0746478	GEAR:PULLEY:IDLER:BELT CLEANING	U011_S001	38
D0746479	GEAR:COLLECT:COIL:Z19	U011_S001	39
D0746480	PULLEY:BRUSH:APPLY:Z30	U011_S001	40
D0746481	JOINT:BRUSH:REMOVE PAPER DUST:BELT CLEANING	U011_S001	41
D0746485	SEAL:CASE:BRUSH:FRONT	U011_S001	42
D0746486	SEAL:CASE:BRUSH:REAR	U011_S001	43
D0746488	SEAL:HOLDER:BEHIND:BELT CLEANING	U011_S001	44
D0746489	VIBRATING PLATE:TRANSPORT SCREW:BELT CLEANING	U011_S001	45
D0746490	SEAL:BASE:CASE:BELT CLEANING	U011_S001	46
D0746491	SEAL:CASE:CLEANING BLADE:FRONT	U011_S001	47
D0746492	SEAL:CASE:CLEANING BLADE:REAR	U011_S001	48
D0746495	LEVER:RELEASE:BLADE	U011_S001	49
D0746496	GRIP:BELT CLEANING	U011_S001	50
D0746497	DECAL:POSITIONING DISPLAY:TCRU	U006_S017	255
		U006_S019	255

Exclusive Parts

Number	Part Name	Group	ID
		U006_S021	255
		U007	86
		U011_S001	51
		U015	102
		U015_S001_S001	102
		U015_S002_S001	102
		U015_S003_S001	102
		U015_S004_S001	102
D0746574	COVER:CAM:VERTICAL TRANSPORT	U013	29
D0746575	SHAFT:CAM:VERTICAL TRANSPORT	U013	30
D0746579	SEAL:COVER:CAM:VERTICAL TRANSPORT	U013	31
D0746643	GEAR:TRANSPORT SCREW:COLLECTION BOTTLE:SMALL:Z31	U013_S003	32
D0746659	SHAFT:JOINT:COLLECTION BOTTLE:ASS'Y	U013	33
D0746663	TORQUE LIMITER MECHANICAL CLUTCH:GEAR:Z63	U013	34
D0746664	GEAR:IDLER:Z49/Z27	U013	35
D0746665	GEAR:JOINT:COLLECTION BOTTLE:Z65	U013	36
D0746666	GEAR:IDLER:Z37/Z28	U013	37
D0746667	HOLDER:RADIAL BALL BEARING:JOINT	U013	38
D0746697	DECAL:COLLECTION BOTTLE:GRIP:FRONT	U013_S004	39
D0746711	FRAME:ARM:OPERATION SUB-UNIT:INNER	U002	21
D0746712	GUIDE PLATE:ARM:OPERATION SUB-UNIT	U002	22
D0746713	FRAME:ARM:OPERATION SUB-UNIT:OUTER	U002	23
D0746714	GUIDE PLATE:HINGE:OPERATION SUB-UNIT:LOWER	U002	24
D0746715	SUPPORTING PLATE:GUIDE PLATE:HINGE	U002	25

Number	Part Name	Group	ID
D0746717	BRACKET:COVER:ARM:RIGHT	U002	27
D0746718	HINGE:ARM:OPERATION SUB-UNIT:LOWER	U002	28
D0746719	FRAME:ARM:OPERATION SUB-UNIT:FRONT	U002	29
D0746721	GUIDE PLATE:HINGE:OPERATION SUB-UNIT:UPPER	U002	30
D0746722	HINGE:ARM:OPERATION SUB-UNIT:UPPER	U002	31
D0746723	GUIDE PLATE:OPERATION PANEL	U002	32
D0746724	BRACKET:COVER:ARM:FRONT	U002	33
D0746725	BRACKET:COVER:ARM:FRONT LOWER	U002	34
D0746726	SUPPORTING PLATE:COVER:ARM:INNER	U002	35
D0746727	COVER:HARNES:OPERATION PANEL	U023	16
D0746728	COVER:ARM:OPERATION SUB-UNIT:RIGHT	U002	36
D0746729	COVER:ARM:OPERATION SUB-UNIT:INNER	U002	37
D0746730	COVER:ARM:OPERATION SUB-UNIT:RIGHT LOWER	U002	38
D0746732	COVER:ARM:OPERATION SUB-UNIT:LEFT LOWER	U002	39
D0746734	COVER:OPERATION PANEL:REAR	U023	17
D0746735	COVER:OPERATION PANEL:REAR UPPER	U023	18
D0746736	COVER:ARM:OPERATION SUB-UNIT:FRONT LOWER	U002	40
D0746738	CAP:COVER:ARM:RIGHT	U002	41
D0746739	HOLDER:HINGE:OPERATION SUB-UNIT:UPPER	U002	42
D0746974	CAP:LOUVER:MM90	U020	23
D0746975	FILTER:POWER SUPPLY UNIT:MM90	U020	24
D0747087	SEAL:DC FAN MOTOR:SIROCCO	U010_S002	62
D0747118	DUCT:INNER BACK:COOLING:POS	U010_S002	63

Exclusive Parts

Number	Part Name	Group	ID
	ITIONING SENSOR		
D0747119	DUCT:FRONT:COOLING:POSITIONING SENSOR	U010_S002	64
D0747330	SLIDE RAIL:LEFT:NO.1	U006	256
D0747331	STAY:SLIDE RAIL:LEFT INNER REAR:NO.1:PEEN	U006	257
D0747333	STAY:SLIDE RAIL:LEFT FRONT:NO.1	U006	258
D0747335	STAY:SLIDE RAIL:LEFT:NO.2	U006	259
D0747349	COMPRESSION SPRING:BRACKET:SENSOR:PAPER SIZE SENSOR	U006	260
D0747381	DECAL:VERTICAL TRANSPORT:A1	U006	261
D0747385	DECAL:CAUTION CHART:TANDEM LCT	U006_S017	262
		U006_S019	262
		U006_S021	262
D0747387	(NA/EU,AA,TWN,KOR):DECAL:BASE:TANDEM LCT:LEFT	U006_S018_S001	263
		U006_S020_S001	263
D0747388	DECAL:PAPER SET DIRECTION:TANDEM LCT:RIGHT	U006_S017	264
		U006_S019	264
		U006_S021	264
D0747390	DECAL:PAPER SET DIRECTION:PAPER TRAY	U006_S001	266
		U006_S002	266
D0747391	DECAL:PAPER SET DIRECTION	U023	19
D0747392	DECAL:PAPER TRAY:NO.1	U006	267
D0747393	DECAL:PAPER TRAY:NO.2	U006	268
D0747431	STAY:HANDLE:ASS'Y	U006	269
D0747433	STUD:HANDLE:RELEASE:ASS'Y	U006	270
D0747446	BRACKET:DC STEPPER MOTOR:TRANSPORT UNIT	U006	271
D0747521	GUIDE PLATE:UPPER:PAPER FEE D UNIT	U006_S014	272
		U006_S015	272
		U006_S016	272
D0747522	GUIDE PLATE:LOWER:PAPER FEE D UNIT	U006_S014	273
		U006_S015	273
		U006_S016	273
D0747527	SHAFT:FEED:ASS'Y	U006_S014_S001	274
		U006_S015_S001	274
		U006_S016_S001	274

Number	Part Name	Group	ID
D0747561	GRIP:UPPER	U006	275
D0747562	GRIP:LOWER	U006	276
D0747563	BRACKET:SLIDER:GRIP	U006	277
D0747567	BRACKET:ARM:LINK:LEFT	U006	278
D0747573	BRACKET:ARM:PLATE	U006	279
D0747596	(NA/EU,AA,TWN,KOR):TRAY BOTTOM PLATE:LEFT MIDDLE:ASS'Y	U006_S018_S001	281
		U006_S020_S001	281
D0747603	PLATE:GRIP:PAPER TRAY:NO.2	U006	282
D0747606	GRIP:PAPER TRAY:NO.2	U006	283
D0747607	ARM:PAPER TRAY:GRIP	U006	284
D0747681	(NA):HEAT SINK:HEATER:UPPER:ASS'Y	U006_S004	285
D0747752	CAP:COVER:TONER SUPPLY	U020	25
D0747775	(NA/CHN):PLATE:LOGO:RICOH	U023	20
D0747782	GRIP:DOOR:FRONT	U001	20
D0747828	CAP:CONNECTOR	U001	21
D0747829	CAP:JOINT:LARGE CAPACITY TRAY	U001	22
D0747830	COVER:LARGE CAPACITY TRAY	U001	23
D0747831	COVER:CONNECTOR:LARGE CAPACITY TRAY	U001	24
D0747854	HINGE:LEFT LOWER:ASS'Y	U001	25
D0747861	HINGE:RIGHT LOWER:ASS'Y	U001	26
D0895887	PANEL:INTERFACE	U020	26
D0931266	DECAL:WARNING (HIGH TEMPERATURE):LENGTHWISE	U007	87
		U016	68
D0951260	CAP:COVER:SCA	U003_S001	89
D0951788	KEYTOP:TRY PRINT	U002_S001	43
		U002_S002	43
		U002_S003	43
D0951789	KEYTOP:STOP	U002_S001	44
		U002_S002	44
		U002_S003	44
D0951790	KEYTOP:INTERRUPT	U002_S001	45
		U002_S002	45
		U002_S003	45
D0A46099	SHEET:PRESSURE PLATE:SMALL	U003_S001_S014	272
D0A53995	JOINT:KNOB:FUSING	U015_S001	164

Exclusive Parts

Number	Part Name	Group	ID
		U015_S003	164
		U015_S004	164
D0A56044	BRACKET:INTERMEDIATE TRANSFER:FRONT	U010_S001	130
D0A56045	BRACKET:INTERMEDIATE TRANSFER:REAR	U010_S001	131
D0A57797	SD-CARD:SP:BATCH:TOOL:ASS'Y	SPECIAL TOOLS	20
D0BX1069	COVER:MOTOR:USED TONER	U022	89
D0BX1427	COVER:MAIN:REAR:SUB-ASS'Y	U001_S005	101
D0BX1488	SUPPORTING PLATE:DOOR:FRONT LEFT:ASS'Y	U001_S004	97
D0BX1506	SUPPORTING PLATE:DOOR:FRONT RIGHT:ASS'Y	U001_S003	96
D0BX1508	COVER:MAIN:LEFT	U001	103
D0BX1516	COVER:MAIN:REAR:PEEN	U001_S005	102
D0BX1518	COVER:EXHAUST:PAPER EXIT SUB-UNIT	U023	56
D0BX1550	INNER COVER:INTERMEDIATE TRANSFER:ASS'Y	U001_S006	98
D0BX1594	HOLDER:HINGE:OPERATION SUB-UNIT:LOWER	U002	74
D0BX2255	CHARGE CORONA	U009_S002	151
D0BX2432	SERVICE PARTS:DEVELOPMENT UNIT:C3:ASS'Y	U009_S004	154
D0BX2440	INNER COVER:PCU:ASS'Y	U009_S003	157
D0BX2485	LED ARRAY:ASS'Y	U009_S004	155
D0BX2500	GRID:CHARGE CORONA	U009_S002	152
D0BX2679	HOLDER:DC STEPPER MOTOR:SHIFT	U007	188
D0BX2856	GUIDE PLATE:CONNECTING:LARGE CAPACITY TRAY:PEEN	U007	178
D0BX2902	GUIDE PLATE:CONNECTING:UPPER:PEEN	U007	182
D0BX2906	GUIDE PLATE:CONNECTING:LOWER:PEEN	U007	180
D0BX3075	FILTER:DEVELOPMENT	U009_S004	156
D0BX3342	BRACKET:CHUCK:TONER BANK:PEEN	U008	96

Number	Part Name	Group	ID
D0BX3383	SEAL:CASE:TONER BANK:REAR	U008	98
D0BX3451	LEVER:TONER BOTTLE:PEEN	U008	93
D0BX3833	TRANSPORT BELT	U014	24
D0BX3862	SUPPORTING PLATE:VACUUM	U014	21
D0BX4786	CUSHION:GUIDE PLATE:REVERSE:LOWER	U016	152
D0BX6051	ROLLER:INTERMEDIATE TRANSFER:ASS'Y	U010_S001	128
D0BX6210	TRANSFER UNIT:ASS'Y	U012_S001	81
D0BX6225	SIDE PLATE:TRANSFER/SEPARATION UNIT:REAR:ASS'Y	U012_S001_S001	82
D0BX6250	TRANSFER ROLLER	U012_S001	80
D0BX6255	BRUSH ROLLER:TRANSFER ROLLER:ASS'Y	U012_S001	78
D0BX6282	SWING UNIT:PICKUP ROLLER:ASS'Y	U006_S014_S002	420
		U006_S015_S002	420
		U006_S016_S002	420
D0BX6310	SEPARATION CORONA:ASS'Y	U012_S001_S002	84
D0BX6401	BELT CLEANING:ASS'Y	U011_S001	64
D0BX6411	SEAL:TONER OUTLET SUB-UNIT	U018_S007	75
D0BX6420	BRUSH:REMOVE PAPER DUST:BELT CLEANING	U011_S001	62
D0BX6446	BRUSH:APPLY:BELT CLEANING	U011_S001	66
D0BX6450	COATING BAR:ASS'Y	U011_S001_S001	67
D0BX6455	COIL SPRING:COATING BAR	U011_S001_S001	65
D0BX6521	BRACKET:TONER OUTLET SUB-UNIT:VERTICAL TRANSPORT:LOWER	U013	66
D0BX6528	TONER OUTLET SUB-UNIT:VERTICAL TRANSPORT:MAIN:ASS'Y	U013_S002	67
D0BX6552	TRANSPORT SCREW:TONER OUTLET SUB-UNIT:LOWER:ASS'Y	U013_S002	68
D0BX6648	COIL SPRING:TANDEM TRAY:LOCK	U006	397
D0BX6677	ROLLER:SLIDE RAIL:FRONT	U006_S017	398
		U006_S019	398
		U006_S021	398
D0BX6771	GUIDE PLATE:OPEN AND CLOSE:	U006_S013	415

Exclusive Parts

Number	Part Name	Group	ID
	VERTICAL TRANSPORT:LOWER:ASS'Y		
D0BX6780	TRAY BOTTOM PLATE:ASS'Y	U006_S001_S001	401
		U006_S002_S001	401
D0BX6786	GUIDE PLATE:VERTICAL TRANSPORT:F2:PEEN	U006	412
D0BX6795	HOLDER:STAY:GUIDE PLATE	U006_S013	392
D0BX6909	FILTER:DUCT:MAIN:REAR	U021	120
D0BX7114	GUIDE PLATE:REVERSE:DUPLEX:DRIVE	U017	85
D0BX7116	GUIDE PLATE:REVERSE:DUPLEX:DRIVEN:PEEN	U017	83
D0BX7118	GUIDE PLATE:REVERSE:DUPLEX:LEFT	U017	84
D0BX7595	(NA/EU,AA,TWN,KOR):BASE:TANDEM LCT:RIGHT:ADHESION	U006_S017	405
		U006_S019	405
D0BX7631	PAPER TRAY:UNIVERSAL:SUB-ASS'Y	U006_S001	406
		U006_S002	406
D0EZ5922	BRACKET:P SUPPLY CORD:NOISE FILTER	U019	39
D0EZ6646	INNER COVER:TANDEM LCT:LEFT	U006_S018	421
		U006_S020	421
		U006_S022	421
D1054365	HOLDER:THERMOPILE	U015	103
D1055898	HOLDER:TEMPERATURE & HUMIDITY SENSOR	U013	62
D1202829	TENSION SPRING:REGISTRATION:DRIVEN	U013	40
D1316511	BRACKET:CONNECTOR:LEFT	U006	286
D1316775	SIDE FENCE:REAR:ASS'Y	U006_S001_S002	287
		U006_S002_S002	287
D1316777	SIDE FENCE:FRONT:ASS'Y	U006_S001_S003	288
		U006_S002_S003	288
D1361715	GUIDE:HARNESS:LED	U004	24
D1361717	COVER:SHAFT:SCANNER	U004	25
D1361727	INNER COVER:SCANNER	U004	26
D1361751	CARRIAGE:NO.1:ASS'Y	U004_S002	27
D1361758	CLAMP:WIRE	U004	28

Number	Part Name	Group	ID
D1361759	GUIDE:FFC:CARRIAGE:NO.1	U004	29
D1361760	REFLECTOR:SCANNER	U004	30
D1361776	CARRIAGE:NO.2:ASS'Y	U004_S004	31
D1361784	MIRROR:NO.2:ASS'Y	U004_S004	32
D1361785	MIRROR:NO.3:ASS'Y	U004_S004	33
D1361787	GUIDE:FFC:CARRIAGE:NO.2	U004	34
D1361788	PULLEY:IDLER:CARRIAGE	U004	35
D1361793	DC STEPPER MOTOR:MM42	U004	36
D1361794	BRACKET:DC STEPPER MOTOR:TENSION	U004	37
D1361798	TENSION SPRING:TENSION:16N	U004	38
D1361799	BRACKET:DC STEPPER MOTOR	U004	39
D1361801	SHAFT:DRIVE:SCANNER	U004	40
D1361802	TIMING PULLEY:65	U004	41
D1361803	SYNCHRONOUS BELT:157ST1.5-6.0	U004	42
D1361806	DRIVE WERE:DIA1	U004	43
D1361809	BRACKET:TENSION	U004	44
D1361810	TENSION SPRING:TENSION:11N	U004	45
D1361811	PULLEY:PEEN	U004	46
D1361817	BRACKET:EXPOSURE GLASS:DOCUMENT FEEDER:SUB-ASS'Y	U004	47
D1363692	DECAL:COLLECTION BOTTLE:GRIP:UPPER	U013_S004	41
D1364233	STEPPED SCREW:DIA5:M3X3.8	U021	24
D1365696	PCB:SIO	U004	48
D1365709	PCB:EX3_DDR3-DIMM:RC-A:2GB:ASS'Y	U020	27
D1365725	PCB:IMAGE PROCESSING UNIT:TYPE-S15MDA-SUB	U020	28
D1366099	TENSION SPRING:BRACKET:DC STEPPER MOTOR	U010_S001	65
D1366145	ROLLER:ON-OFF:INTERMEDIATE TRANSFER	U010_S001	66
D1366149	BUSHING:SLIDE RAIL:ON-OFF	U010_S001	67
D1366183	GRIP:ON-OFF:INTERMEDIATE TRANSFER:TCRU	U010_S001	68
D1381289	JOINT:FUSING:ON-OFF	U018_S009	27

Exclusive Parts

Number	Part Name	Group	ID
D1381731	LENSBLOCK SMD:SERVICE PART S:ASS'Y	U004_S001	49
D1441085	STEPPED SCREW:M3	U004	50
D1491715	PULLEY:DRIVE WERE:FRONT	U004	51
D1491717	PULLEY:DRIVE WERE:REAR	U004	52
D1491721	ILLUMINATION UNIT:LED-B:ASS'Y	U004_S003	53
D1491804	HOLDER:EXPOSURE GLASS:SCANNER	U004	54
D1491805	HOLDER:EXPOSURE GLASS	U004	55
D1491840	GROUND PLATE:AKS	U022	43
D1495776	COVER:USB:SMALL	U020	29
D1495883	KEYTOP:MAIN SWITCH	U019	29
D1495884	COMPRESSION SPRING:KEYTOP	U019	30
D1791043	GUARD:MAIN:VERTICAL TRANSPORT	U022	44
D1791115	RAIL:INTERMEDIATE TRANSFER:LEFT	U022	45
D1791118	SEPARATION PLATE:MAIN:REAR MIDDLE	U022	90
D1791119	STAY:MAIN:RIGHT UPPER	U022	92
D1791127	GUIDE:LOCK:PAPER EXIT UNIT	U022	46
D1791128	HOLDER:REGISTRATION:DRAWER	U022	47
D1791129	GUIDE:PULL OUT:LOCK	U022	48
D1791130	GUIDE:PULL OUT:MIDDLE:LOWER	U022	49
D1791185	GUIDE:INTERMEDIATE TRANSFER:LEFT	U022	50
D1791220	DRUM SHAFT:DRIVE:ASS'Y	U018_S001	28
D1791221	HOLDER:COIL SPRING:LOCK:PULL OUT	U022	52
D1791232	SHAFT:LOCK:PULL OUT:RIGHT:ASS'Y	U022	53
D1791251	DC MOTOR:DIA63:29.7W:BRUSHLESS	U018	29
D1791252	DC MOTOR:DIA82.2:63.7W:BRUSHLESS	U018	30
D1791254	SHAFT:DRIVE:DEVELOPMENT ROLLER:ASS'Y	U018_S002	31

Number	Part Name	Group	ID
D1791256	SHAFT:DRIVE:TRANSPORT SCREW:ASS'Y	U018	32
D1791258	PLATE:HOLDER:ANTISTATIC BRUSH:DRUM	U018	33
D1791262	SHAFT:DRIVE:CLEANER:ASS'Y	U018_S003	34
D1791264	PLATE:HOLDER:RADIAL BALL BEARING	U018	35
D1791265	PULLEY:DRIVE:DRUM:107T	U018	36
D1791266	PULLEY:DRIVE:DEVELOPMENT ROLLER:59T	U018	37
D1791267	SYNCHRONOUS BELT:120S2M316	U018	38
D1791268	SYNCHRONOUS BELT:80S2M300	U018	39
D1791269	BRACKET:DC MOTOR:CLEANING DRIVE SUB-UNIT	U018	40
D1791271	SPACER:SHAFT:DRUM	U018	41
D1791273	GEAR:DRIVE:TRANSPORT SCREW:54Z	U018	42
D1791275	TENSION SPRING:3.8N	U018	43
D1791276	TENSION SPRING:3.6N	U018	44
D1791277	GEAR:DRIVE:CLEANER:39Z	U018	45
D1791278	HOLDER:BEARING:DRUM SHAFT	U018	46
D1791286	BRACKET:DRIVE:CLEANER:ASS'Y	U018	47
D1791288	GEAR:IDLER:CLEANER:49Z/33Z	U018_S004	48
D1791289	GEAR:PULLEY:DRUM:113Z/37T	U018_S005	49
D1791290	GEAR:IDLER:TRANSPORT SCREW:65Z/53Z	U018_S006	50
D1791291	BRACKET:DC MOTOR:DRUM:ASS'Y	U018	51
D1791293	TIGHTENER:DRIVE:DRUM:ASS'Y	U018	52
D1791297	TIGHTENER:DRIVE:DEVELOPMENT:ASS'Y	U018	53
D1791300	DRIVE UNIT:FUSING:ASS'Y	U018_S008	54
D1791309	DC BRUSHLESS MOTOR:58W:DRIVE:FUSING UNIT	U018_S008	55
D1791316	JOINT:DRIVE:FUSING	U018_S008	74
D1791320	BRACKET:DRIVE:USED TONER	U018	56
D1791323	TENSION SPRING:BELT TENSIONER:DRIVE:USED TONER	U018	57

Exclusive Parts

Number	Part Name	Group	ID
D1791324	SYNCHRONOUS BELT:40S3M222	U013_S001	42
D1791326	BRACKET:BELT TENSIONER:DRIVE:USED TONER	U018	58
D1791327	SHAFT:BELT TENSIONER:DRIVE:USED TONER	U018	59
D1791328	GEAR:PULLEY:Z67/T19:DRIVE:USED TONER	U018	60
D1791329	PULLEY:TIGHTENER:DIA18	U018	61
D1791345	BRACKET:DRAWER:DEVELOPMENT	U018	62
D1791351	DC MOTOR:DIA63:24V:28.4W	U010_S001	69
D1791352	HOUSING:DRIVE UNIT:INTERMEDIATE TRANSFER	U010_S001	70
D1791353	GEAR:DRIVE ROLLER:INTERMEDIATE TRANSFER	U010_S001	71
D1791354	HOLDER:MOTOR:INTERMEDIATE TRANSFER	U010_S001	72
D1791370	DC MOTOR:40W:BRUSHLESS	U018_S007	63
D1791375	GEAR:IDLER:BELT CLEANING	U018_S007	64
D1791391	MECHANICAL DRIVE SECTION:TRANSFER:SECOND:ASS'Y	U018_S007	65
D1791442	COVER:DC_SW	U001	27
D1791443	COVER:UPPER RIGHT	U001	28
D1791444	COVER:UPPER FRONT	U001	29
D1791446	COVER:UPPER REAR	U001	30
D1791451	CAP:KEY COUNTER	U001	31
D1791454	DOOR:TONER SUPPLY:ASS'Y	U001_S002	32
D1791456	SUPPORTING PLATE:HINGE:DOOR:TONER SUPPLY	U001_S002	33
D1791457	MAGNET CATCH PLEET:DOOR:TONER SUPPLY	U001_S002	34
D1791460	HINGE:DOOR:TONER SUPPLY	U001	35
D1791465	BRACKET:KEY COUNTER	U022	54
D1791469	COVER:FRONT UPPER	U001	36
D1791470	BRACKET:COVER:FRONT UPPER	U001	37
D1791471	LEVER:SAFETY SWITCH	U001	38
D1791476	BRACKET:SAFETY SWITCH	U001	39
D1791477	SHIELD PLATE:SAFETY SWITCH	U001	40

Number	Part Name	Group	ID
D1791483	LEVER:SAFETY SWITCH	U001	41
D1791485	DOOR:FRONT LEFT:LOWER	U001	42
D1791487	DUCT:DOOR:FRONT LEFT:ASS'Y	U001	43
D1791490	BRACKET:SUPPORTING PLATE:DOOR:FRONT LEFT	U001_S004	44
D1791497	DOOR:FRONT RIGHT:UPPER	U001	45
D1791499	CAP:MM22	U001	46
D1791500	DOOR:FRONT RIGHT:LOWER	U001	47
D1791505	STOPPER:GUIDE PLATE:VERTICAL TRANSPORT	U001_S003	48
D1791514	COVER:MAIN:RIGHT	U001	50
D1791526	STAY:SAFETY SWITCH	U001	51
D1791531	HINGE:LEFT UPPER	U001	52
D1791533	HINGE:RIGHT UPPER	U001	53
D1791553	COVER:DC_SW	U019	31
D1791557	BRACKET:DC_SW	U019	32
D1791571	BRACKET:EARTH:DOOR:MIDDLE	U001	54
D1791572	BRACKET:EARTH:DOOR:LOWER	U001	55
D1791582	PLATE:MAGNET CATCH	U001	56
D1791583	SEAL:PLATE:MAGNET CATCH	U001	57
D1791586	(CHN/EU,AA,TWN,KOR):DECAL:CAUTION:PULL OUT:BLANK	U023	21
D1791589	(CHN/EU,AA,TWN,KOR):DECAL:CAUTION:PULL OUT:LANGUAGE:MULTI-LANGUAGE	U023	23
D1791594	(CHN/EU,AA,TWN,KOR):DECAL:DC:MAIN SWITCH	U023	24
D1791595	(NA):DECAL:DC:MAIN SWITCH	U023	25
D1791731	COVER:REGISTRATION:MOTOR	U022	55
D1791734	LEVER:PULL OUT:LEFT	U022	56
D1791748	HOLDER:EXPOSURE GLASS:ASS'Y	U023	26
D1791763	(CHN/EU,AA,TWN,KOR):SCALE:LEFT:ASS'Y	U004	56
D1791764	(NA):SCALE:LEFT:ASS'Y	U004	57
D1791768	EXPOSURE GLASS:DOCUMENT FEEDER	U004	58
D1791769	SPRING PLATE:EARTH:FRAME:SC	U022	57

Exclusive Parts

Number	Part Name	Group	ID
	ANNER		
D1791777	COVER:EXPOSURE GLASS:DOCUMENT FEEDER	U004	59
D1791782	BRACKET:ADF:RIGHT	U022	58
D1791784	BRACKET:ADF:LEFT	U022	59
D1791786	BRACKET:INNER COVER	U021	25
D1791789	SCALE:REAR:PRINTING	U004	60
D1792204	COVER:END BLOCK:REAR	U009_S002	40
D1792205	ELECTRODE PLATE:CASE:CHARGE	U009_S002	41
D1792206	STAY:GRID	U009_S002	42
D1792208	END BLOCK:CHARGE CORONA:REAR	U009_S002	43
D1792209	STAY:CORONA WIRE:LEFT	U009_S002	44
D1792210	STAY:CORONA WIRE:RIGHT	U009_S002	45
D1792224	CORONA WIRE:CHARGE CORONA	U009_S002	46
D1792237	HOLDER:MOTOR:CHARGE	U009	47
D1792238	SOCKET:CHARGE	U009	48
D1792239	SHAFT:CLEANER:CHARGE:DRIVE:ASSY	U009_S005	49
D1792246	SEAL:DUCT:SIDE PLATE:REAR	U009	50
D1792254	DECAL:CHARGE:GRIP	U009_S002_S001	51
D1792256	COVER:CHARGE CORONA:ASSY	U009_S002_S001	53
D1792370	GRIP:DRUM:ASSY	U009	54
D1792376	HOLDER:DRUM:TAKE OFF:FRONT	U009	55
D1792377	HOLDER:DRUM:TAKE OFF:REAR	U009	56
D1792411	SLIDE RAIL:PCU	U009	57
D1792412	HOLDER:SLIDE RAIL:PCU:RIGHT	U009	145
D1792416	STAY:ELECTRIC POTENTIAL SENSOR	U009	58
D1792417	HOLDER:ELECTRIC POTENTIAL SENSOR	U009	59
D1792419	STOPPER:SLIDE RAIL:PCU:PEEN	U009	60
D1792421	ELECTRIC POTENTIAL SENSOR	U009	61
D1792427	BRACKET:DRAWER:CLEANING UNIT	U009	62
D1792467	LEVER:POSITIONING:CLEANING	U009_S004	140
D1792468	GRIP:DRUM STAY:PCU	U009_S004	63

Number	Part Name	Group	ID
D1792469	KNOB SCREW:DRUM	U009	64
D1792474	DECAL:DIAL	U009_S004	65
D1792494	GROUND PLATE:STAY:PCU	U009_S004	67
D1792621	SHAFT:DRIVEN ROLLER:SHIFT	U007	88
D1792631	GUIDE PLATE:SHIFT:REGISTRATION:UPPER	U007	89
D1792642	HOLDER:SHIFT:BEARING:REAR	U007	90
D1792643	CAM:REGISTRATION:GATE:RELEASE	U007	91
D1792648	PLATE:ADJUSTING PIN	U007	93
D1792651	GUIDE PLATE:REGISTRATION:EXIT	U007	94
D1792660	BRACKET:GUIDE PLATE:FRONT:CIS	U007	95
D1792661	BRACKET:GUIDE PLATE:INNER BACK:CIS	U007	96
D1792666	GUIDE PLATE:REGISTRATION:TIMING:UPPER	U007	97
D1792670	GUIDE PLATE:REGISTRATION:TIMING:LOWER	U007	98
D1792675	COVER:REGISTRATION:DOUBLE FEED SENSOR	U007	99
D1792684	REGISTRATION GUIDE:OPEN AND CLOSE	U007	100
D1792685	CASE:REMOVE PAPER DUST:ASSY	U007	101
D1792689	COVER:REGISTRATION:EXIT	U007	102
D1792691	TENSION SPRING:PRESSURE ROLLER	U007	103
D1792698	COMPRESSION SPRING:SHIFT	U007	104
D1792702	TIMING ROLLER:REGISTRATION:DRIVE	U007_S001	105
D1792703	TRANSPORT ROLLER:CONNECTING:LARGE CAPACITY TRAY:PRESS FIT	U007_S002	106
D1792704	TRANSPORT ROLLER:CONNECTING:MAIN	U007_S003	107
D1792705	TRANSPORT ROLLER:SHIFT:TRAY	U007_S014	108

Exclusive Parts

Number	Part Name	Group	ID
	LING EDGE		
D1792711	TIMING ROLLER:TRANSFER:DRIVEN:PRESS FIT	U007	109
D1792727	SHAFT:TIMING ROLLER:REGISTRATION:DRIVEN	U007	110
D1792751	BRACKET:DC STEPPER MOTOR:PAPER FEED:TIMING	U007	111
D1792754	BRACKET:DC STEPPER MOTOR:PAPER FEED	U007	112
D1792757	TIGHTENER:BRACKET:DC STEPPER MOTOR	U007	113
D1792758	GEAR:Z41:TIMING PULLEY:T41	U007_S006	114
		U007_S007	114
D1792760	COVER:MOTOR	U007	115
D1792763	CAM:REGISTRATION:TIMING	U007	116
D1792764	SHAFT:CAM:REGISTRATION:TIMING	U007	117
D1792768	TIMING PULLEY:S2M:30T	U007	118
D1792783	COVER:BASE:MAIN PAPER SMD	U007	120
D1792791	BRACKET:DRAWER:MAIN PAPER SMD	U007	121
D1792809	GUIDE PLATE:SHIFT:LEFT LOWER	U007	122
D1792814	GUIDE:SHIFT:TRAILING EDGE	U007	123
D1792817	BRACKET:SHIFT:SYNCHRONOUS BELT	U007	125
D1792861	BRACKET:OPEN AND CLOSE:LARGE CAPACITY TRAY	U007	127
D1792872	BRACKET:DC STEPPER MOTOR:TRAILING EDGE	U007	128
D1792891	GUIDE PIN:SHIFT:TRAILING EDGE	U007	129
D1792901	GUIDE PLATE:CONNECTING:DUPLICATE:EXIT	U007	130
D1792909	JOINT:CONNECTING:DRIVEN	U007	133
D1792932	ARM:ON-OFF:TRANSPORT ROLLER	U007	134
D1792933	SHAFT:LINK:ON-OFF:CONNECTING:LARGE CAPACITY TRAY	U007	135
D1792934	SHAFT:LINK:ON-OFF:CONNECTING	U007	136

Number	Part Name	Group	ID
	G		
D1792943	BRACKET:CAM:ON-OFF	U007	137
D1792944	DISC:ON-OFF:SENSOR	U007	138
D1792946	SHAFT:CAM:ON-OFF:LARGE CAPACITY TRAY	U007	139
D1792947	SHAFT:CAM:ON-OFF:MAIN	U007	140
D1792948	CAM:TRANSPORT ROLLER:ON-OFF	U007	141
D1792952	BRACKET:DC STEPPER MOTOR:DRIVEN:ON-OFF	U007	142
D1792960	GUIDE PLATE:OPEN AND CLOSE:MAIN:CONNECTING	U007	143
D1792963	BRACKET:GRIP:OPEN AND CLOSE:GUIDE PLATE	U007	144
D1792964	GUIDE:MAIN:CONNECTING:OPEN AND CLOSE	U007	145
D1793043	DUCT:FILTER:DEVELOPMENT:ASSY	U009_S004	68
D1793070	GEAR:TRANSPORT SCREW:NO.1	U009_S004	69
D1793071	GEAR:TRANSPORT SCREW:NO.2	U009_S004	70
D1793072	GEAR:TRANSPORT SCREW:NO.3	U009_S004	71
D1793073	GEAR:IDLER:TRANSPORT SCREW:UPPER:ASSY	U009_S004	72
D1793074	GEAR:IDLER:TRANSPORT SCREW:LOWER:ASSY	U009_S004	73
D1793084	ENTRANCE SEAL:DEVELOPMENT:ASSY	U009_S004	75
D1793090	PLATE:GEAR:IDLER:ASSY	U009_S004	76
D1793131	RECEPTACLE:DEVELOPMENT VIAS:ASSY	U009	78
D1793144	COVER:INTERMEDIATE TRANSFER:LOWER	U010_S001	73
D1793201	TONER SUPPLY UNIT:TONER HOPPER:ASSY	U008_S001	53
D1793234	GEAR:TRANSPORT SCREW:LONG:TONER SUPPLY	U008_S001	54
D1793237	GEAR:TRANSPORT SCREW:SHORT:TONER SUPPLY	U008_S001	55

Exclusive Parts

Number	Part Name	Group	ID
D1793244	GEAR:AGITATOR:TONER SUPPLY	U008_S001	56
D1793252	COVER:GEAR:TONER SUPPLY	U008_S001	57
D1793253	GEAR:IDLER:FEED:TONER SUPPLY:1	U008_S001	58
D1793254	GEAR:IDLER:FEED:TONER SUPPLY:2	U008_S001	59
D1793256	BRACKET:DC STEPPER MOTOR:AGITATOR:ASS'Y	U008_S001	60
D1793259	GEAR:IDLER:AGITATOR:TONER SUPPLY	U008_S001	61
D1793263	BRACKET:DC STEPPER MOTOR:TONER SUPPLY	U008_S001	62
D1793271	CASE:SHUTTER:TONER SUPPLY	U008	63
D1793272	SHUTTER:TONER SUPPLY:ASS'Y	U008	64
D1793275	COIL SPRING:SHUTTER:TONER SUPPLY	U008	65
D1793276	TONER CATCHPAN:TONER SUPPLY	U008	66
D1793322	SLIDER:TONER BANK:ASS'Y	U008	68
D1793332	SIDE PLATE:TONER BANK	U008	69
D1793334	CASE:TONER BANK:ASS'Y	U008_S003	70
		U008_S005	70
D1793339	GROUND PLATE:BOTTLE:TONER SUPPLY UNIT	U008	73
D1793344	DC MOTOR:TONER BOTTLE:ASS'Y:BRUSH:5.85W	U008_S004	75
		U008_S006	75
D1793346	DC MOTOR:DRIVE:TONER BOTTLE:ASS'Y:5.85W:BRUSH	U008	76
		U008_S004	76
		U008_S006	76
D1793347	SEAL:BRACKET:RACK	U008_S004	77
		U008_S006	77
D1793355	GUIDE PLATE:TONER BANK:SIDE PLATE	U008	78
D1793361	BRACKET:JOINT:RACK:LEVER	U008	79
D1793366	DECAL:REPLACEMENT INDICATION:TONER BOTTLE	U001_S002	60
D1793367	DECAL:DESIGN SKETCH:TONER BOTTLE	U008_S002	80

Number	Part Name	Group	ID
D1793370	INNER COVER:TONER BANK:ASS'Y	U008_S002	81
D1793373	BRACKET:SAFETY SWITCH:TONER SUPPLY UNIT	U008	82
D1793376	LEVER:SAFETY SWITCH:TONER SUPPLY UNIT:ASS'Y	U008	83
D1793377	TORSION SPRING:SAFETY SWITCH:TONER SUPPLY UNIT	U008	84
D1793380	CASE:TONER BANK:REAR	U008	85
D1793384	SEAL:CASE:TONER BANK:LEFT	U008	87
D1793402	BOTTLE:DEVELOPER:ASS'Y	SPECIAL TOOLS	11
		U023	27
D1793421	KNOB:DRIVE:DEVELOPMENT UNIT:ASS'Y	SPECIAL TOOLS	14
D1793504	CLEANING UNIT:ASS'Y	U009_S001	79
D1793525	TONER COLLECTION COIL:CLEANING:ASS'Y	U009_S001	80
D1793531	TONER CATCHPAN:PIPE:DISCHARGE USED TONER	U009_S001	81
D1793532	COIL SPRING:TONER CATCHPAN	U009_S001	82
D1793535	GEAR SET:CLEANING UNIT:SERVICE PARTS	U009_S001_S001	83
D1793536	GEAR:IDLER:Z16	U009_S001_S001	84
D1793537	GEAR:IDLER:Z17:LOWER	U009_S001_S001	85
D1793538	GEAR:TONER COLLECTION COIL:Z18	U009_S001_S001	86
D1793561	SHAFT:CLEANING BLADE:FRONT	U009_S001	87
D1793564	GEAR:IDLER:Z17:UPPER	U009_S001_S001	88
D1793571	BRACKET:CLEANING BLADE:ASS'Y	U009_S001	89
D1793576	TENSION SPRING:CLEANING BLADE:6N	U009_S001	90
D1793581	BLADE:CLEANING:ASS'Y	U009_S001	91
D1793589	RETAINING RINGS-E:GUIDE	U009_S001	92
D1793607	CLEANING UNIT:APPLY:ASS'Y	U009_S001_S002	93
D1793621	COVER:COATING BAR	U009_S001_S002	94
D1793627	TENSION SPRING:COATING BAR:5N	U009_S001_S002	95

Exclusive Parts

Number	Part Name	Group	ID
D1793635	COATING BAR:ASS'Y	U009_S001_S002	96
D1793641	BRUSH ROLLER:APPLY:ASS'Y	U009_S001_S002	97
D1793645	GEAR:BRUSH ROLLER:Z15	U009_S001_S001	98
D1793647	PLAIN SHAFT BEARING:APPLY:REAR:ASS'Y	U009_S001_S002	99
D1793653	BLADE:APPLY:ASS'Y	U009_S001_S002	100
D1793669	GROUND PLATE:APPLY	U009_S001_S002	101
D1793681	HOLDER:COVER:COATING BAR:ASS'Y	U009_S001_S002_S001	102
		U009_S001_S002_S002	102
D1793689	GROUND PLATE:COVER:APPLY	U009_S001_S002_S001	103
		U009_S001_S002_S002	103
D1793851	TRANSPORT ROLLER:DRIVE	U014	15
D1793865	BRACKET:SENSOR:VACUUM	U014	22
D1793960	TRANSPORT ROLLER:HEAT PIPE:DIA30.4:ASS'Y	U016	69
D1794028	SUPPORTING PLATE:LEVER:PRESSURE:FRONT	U015_S001	104
		U015_S003	104
		U015_S004	104
D1794036	SUPPORTING PLATE:LEVER:PRESSURE:FRONT	U015_S001	105
		U015_S003	105
		U015_S004	105
D1794037	SUPPORTING PLATE:LEVER:PRESSURE:REAR	U015_S001	106
		U015_S003	106
		U015_S004	106
D1794042	LEVER:PRESSURE:REAR:OUTER	U015_S001	107
		U015_S003	107
		U015_S004	107
D1794047	HOLDER:HEATER:PRESSURE:REAR	U015_S001	108
		U015_S003	108
		U015_S004	108
D1794048	HOLDER:HEATER:PRESSURE:FRONT	U015_S001	109
		U015_S003	109
		U015_S004	109
D1794055	SIDE PLATE:PRESSURE:FRONT:PRESSURE	U015_S001	167

Number	Part Name	Group	ID
	EEN	U015_S003	167
		U015_S004	167
D1794071	BRACKET:FUSING ENTRANCE GUIDE PLATE:FRONT	U015_S001	110
		U015_S003	110
		U015_S004	110
D1794072	BRACKET:FUSING ENTRANCE GUIDE PLATE:REAR	U015_S001	111
		U015_S003	111
		U015_S004	111
D1794081	FUSING ENTRANCE GUIDE PLATE:LOWER	U015_S001	112
		U015_S003	112
		U015_S004	112
D1794095	CLAMP:HARNESS:PRESSURE	U015_S001	113
		U015_S003	113
		U015_S004	113
D1794107	BRACKET:STRIPPER PAWLS:PRESSURE:PEEN	U015_S001	114
		U015_S003	114
		U015_S004	114
D1794109	ADJUSTING PIN:DISCHARGE BRUSH	U015_S001	115
		U015_S003	115
		U015_S004	115
D1794113	DISCHARGE BRUSH:21MM	U015_S001	116
		U015_S003	116
		U015_S004	116
D1794114	GUIDE PLATE:FUSING EXIT:LOWER	U015_S001	117
		U015_S003	117
		U015_S004	117
D1794147	SUPPORTING PLATE:SIDE PLATE:FUSING:REAR	U015_S001	118
		U015_S003	118
		U015_S004	118
D1794148	SUPPORTING PLATE:SIDE PLATE:FUSING:FRONT	U015_S001	119
		U015_S003	119
		U015_S004	119
D1794170	TAB:TERMINAL:187:4P	U015_S001	120
		U015_S003	120
		U015_S004	120
D1794182	DISCHARGE BRUSH:HEAT ROLLER	U015_S001	121
		U015_S003	121
		U015_S004	121

Exclusive Parts

Number	Part Name	Group	ID
D1794197	FLAT BELT-FUSING:DIA80:SEAL	U015_S001	122
		U015_S003	122
		U015_S004	122
D1794213	BRACKET:DRAWER:UPPER	U015_S001	123
		U015_S003	123
		U015_S004	123
D1794216	BRACKET:DRAWER:LOWER	U015_S001	124
		U015_S003	124
		U015_S004	124
D1794217	BRACKET:DRAWER:LOWER:AUXILIARY	U015_S001	125
		U015_S003	125
		U015_S004	125
D1794223	LEVER:PAPER EXIT UNIT:FRONT	U015_S001	126
		U015_S003	126
		U015_S004	126
D1794224	LEVER:PAPER EXIT UNIT:REAR	U015_S001	127
		U015_S003	127
		U015_S004	127
D1794228	SUPPORTER:GUIDE PLATE:FUSING EXIT:UPPER	U015_S001	128
		U015_S003	128
		U015_S004	128
D1794231	STOPPER:LEVER:FUSING/PAPER EXIT UNIT	U015_S001	129
		U015_S003	129
		U015_S004	129
D1794232	SHAFT:FUSING/PAPER EXIT UNIT	U015_S001	130
		U015_S003	130
		U015_S004	130
D1794235	TENSION SPRING:FUSING/PAPER EXIT UNIT	U015_S001	131
		U015_S003	131
		U015_S004	131
D1794255	GUIDE PLATE:FUSING EXIT:UPPER:ASS'Y	U015_S001	133
		U015_S003	133
		U015_S004	133
D1794271	COVER:FUSING UNIT:REAR:ASS'Y	U015_S001_S001	134
		U015_S003_S001	134
		U015_S004_S001	134
D1794273	COVER:FUSING UNIT:FRONT:ASS'Y	U015_S001_S002	135
		U015_S003_S002	135

Number	Part Name	Group	ID
		U015_S004_S002	135
D1794278	DECAL:FUSING UNIT:TCRU	U015_S001_S001	138
		U015_S003_S001	138
		U015_S004_S001	138
D1794279	COVER:FUSING/PAPER EXIT UNIT:ASS'Y	U015_S001	139
		U015_S003	139
		U015_S004	139
D1794283	GRIP:COVER:FUSING/PAPER EXIT UNIT:ASS'Y	U015_S001	140
		U015_S003	140
		U015_S004	140
D1794285	COVER:FUSING UNIT:UPPER:ASS'Y	U015_S001_S003	172
		U015_S003_S003	172
		U015_S004_S003	172
D1794337	RING:WEB:CLEANING	U015_S002	141
D1794352	BRACKET:DRAWER:FUSING:UPPER:MAIN	U015	142
D1794353	BRACKET:DRAWER:FUSING:LOWER:MAIN	U015	143
D1794531	SHAFT:COOLING UNIT:ENTRANCE	U016_S001	70
D1794533	DRIVE ROLLER:COOLING UNIT:ENTRANCE	U016	71
D1794537	GUIDE PLATE:COOLING UNIT:ENTRANCE	U016	72
D1794538	BRACKET:CAP:HEAT PIPE:UPPER	U016	73
D1794539	BRACKET:CAP:HEAT PIPE:LOWER	U016	74
D1794740	GUIDE PLATE:EXIT:UPPER:ENTRANCE	U016	75
D1794754	STOPPER:GUIDE PLATE:REVERSE EXIT:LEFT LOWER	U016	76
D1794755	LEVER:LOCK:REVERSE EXIT:LEFT LOWER	U016	77
D1794757	SHAFT:LOCK:REVERSE EXIT:LEFT LOWER	U016	78
D1794758	LINK:ON-OFF:DRIVEN ROLLER:REVERSE EXIT	U016	79
D1794759	SHAFT:ON-OFF:DRIVEN ROLLER:REVERSE EXIT	U016	80
D1794761	BRACKET:SOLENOID:GATE PAWL:	U016	81

Exclusive Parts

Number	Part Name	Group	ID
	SWITCHBACK		
D1794766	LINK:GATE PAWL:SWITCHBACK	U016	82
D1794784	GUIDE PLATE:REVERSE:LOWER	U016	84
D1794785	GUIDE PLATE:EXIT:MIDDLE	U016	85
D1794787	GUIDE PLATE:REVERSE EXIT:ASSY	U016_S010	86
D1794796	GUIDE PLATE:REVERSE:UPPER	U016	87
D1794801	GATE PAWL:REVERSE	U016	89
D1794810	PLATE:GATE PAWL:EXIT:REVERSE	U016	91
D1794811	SHAFT:GATE PAWL:EXIT:REVERSE	U016	92
D1794813	BRACKET:DC STEPPER MOTOR:ON-OFF	U016	93
D1794816	BRACKET:CAM:GATE PAWL	U016	94
D1794820	CAM:ON-OFF	U016	95
D1794821	LINK:GATE PAWL:EXIT:ENTRANCE	U016	96
D1794822	LINK:ON-OFF:REVERSE EXIT:CAM	U016	97
D1794824	GUIDE PLATE:REVERSE EXIT:LEFT LOWER:PEEN	U016	98
D1794827	GUIDE PLATE:REVERSE EXIT:LEFT LOWER:MIDDLE	U016	99
D1794830	BRACKET:CONTACT POINT:REVERSE EXIT:FRONT	U016	100
D1794835	BRACKET:CONTACT POINT:REVERSE EXIT:REAR	U016	101
D1794838	BRACKET:DRAWER:LEFT	U016	102
D1794840	TRANSPORT ROLLER:EXIT:ENTRANCE	U016_S005 U016_S006	103 103
D1794841	TRANSPORT ROLLER:EXIT:EXIT	U016_S007	104
D1794842	TRANSPORT ROLLER:REVERSE	U016_S008	105
D1794843	TRANSPORT ROLLER:REVERSE:ENTRANCE	U016_S009	106
D1794847	BRACKET:CONNECTION:MAIN:EXIT	U016	107
D1794860	GUIDE PLATE:MAIN:EXIT	U016	108
D1794866	COVER:EXIT:EXIT	U016	109

Number	Part Name	Group	ID
D1794882	COVER:HARNESS:LEFT LOWER	U016	110
D1794884	SHEET:OPPOSED:PAPER FEED SENSOR	U022	60
D1794887	SHEET:TRANSPORT:REVERSE EXIT:EXIT	U016_S010	111
D1795059	HDD:ASSY	U020_S003	30
D1795089	COVER:C/T BOX:UPPER:ASSY	U020_S001	31
D1795381	TEMPERATURE SENSOR:FUSING UNIT:UPPER:19PIN	U015_S001 U015_S003 U015_S004	144 144 144
D1795412	PCB:TDRB	U010_S001	74
D1795435	PCB:URRB	U007	148
D1795440	PCB:CNB	U020	32
D1795445	AC CONTROL BOARD	U019	33
D1795725	PCB:IMAGE PROCESSING UNIT	U020	33
D1795824	INTERFACE CABLE:SCANNER:IMAGE PROCESSING UNIT:ASSY	U004	61
D1795913	ARM:SAFETY SWITCH	U019	34
D1795914	BRACKET:SAFETY SWITCH:FRONT	U019	35
D1795915	LEVER:SAFETY SWITCH:WELDING	U019	36
D1795917	BRACKET:SAFETY SWITCH	U019	37
D1795920	BRACKET:MAIN SWITCH	U019	38
D1795923	PLATE:POWER SUPPLY CORD:INLET	U023	28
D1795924	COVER:SAFETY SWITCH:UPPER FRONT	U019	40
D1795928	BRACKET:SAFETY SWITCH:REAR	U019	41
D1795956	COVER:PCB:C/T BOX	U020	34
D1795961	COVER:C/T BOX	U020	35
D1795964	COVER:C/T BOX:LOWER	U020	36
D1795966	SEAL:COVER:C/T BOX:UPPER:A	U020_S001	37
D1795967	SEAL:COVER:C/T BOX:UPPER:B	U020_S001	38
D1795973	SEAL:COVER:C/T BOX:UPPER:C	U020_S001	39
D1796050	FLAT BELT-TRANSFER	U010	75
D1796057	ROLLER:TRANSFER:FRONT:ASSY	U010_S001	77
D1796062	TENSION SPRING:PRESSURE:INT	U010_S001	78

Exclusive Parts

Number	Part Name	Group	ID
	ERMEDIATE TRANSFER		
D1796065	DRIVE ROLLER:INTERMEDIATE TRANSFER:ASS'Y	U010_S001	79
D1796080	ROLLER:OPPOSED:BELT CLEANING:ASS'Y	U010_S001	80
D1796085	ROLLER:DRIVEN:INTERMEDIATE TRANSFER:ASS'Y	U010_S001_S001	81
D1796091	ROLLER:TENSION:ASS'Y	U010_S001_S002	82
D1796094	CASE:TENSION:ROLLER	U010_S001	83
D1796095	SUPPORTING PLATE:CASE:TENSION:ROLLER	U010_S001	84
D1796097	PLAIN SHAFT BEARING:TENSION:ROLLER:INTERMEDIATE TRANSFER	U010_S001	85
D1796098	COIL SPRING:PRESSURE:TENSION:INTERMEDIATE TRANSFER	U010_S001	86
D1796108	ROLLER:TRANSFER:PAPER:FRONT:ASS'Y	U010_S001_S003	87
D1796112	DUCT:DENSITY SENSOR:INTERMEDIATE TRANSFER	U010_S001	88
D1796117	BRACKET:DRAWER:INTERMEDIATE TRANSFER	U010_S001	89
D1796119	PULLEY:ON-OFF:TRANSFER ROLLER	U010_S001	90
D1796122	BRACKET:ON-OFF:TRANSFER ROLLER	U010_S001	91
D1796125	CAM:ON-OFF:TRANSFER:PAPER:REAR	U010_S001	92
D1796127	FEELER:ON-OFF:TRANSFER:PAPER	U010_S001	93
D1796140	LEVER:ON-OFF:ROLLER:FRONT	U010_S001	94
D1796141	LEVER:ON-OFF:ROLLER:REAR	U010_S001	95
D1796143	ARM:LEVER:ON-OFF:ROLLER	U010_S001	96
D1796144	TENSION SPRING:SLIDE RAIL:TRANSFER	U010_S001	97
D1796146	SHAFT:ON-OFF:INTERMEDIATE TRANSFER	U010_S001	98
D1796147	CAM:ON-OFF:INTERMEDIATE TRANSFER	U010_S001	99

Number	Part Name	Group	ID
	NSFER		
D1796154	CASE:OPPOSED:TRANSFER ROLLER:FRONT	U010_S001	100
D1796155	CASE:OPPOSED:TRANSFER ROLLER:REAR	U010_S001	101
D1796156	COVER:CASE:OPPOSED:TRANSFER ROLLER:REAR	U010_S001	102
D1796157	SPRING PLATE:TRANSFER:OPPOSED:PAPER	U010_S001	103
D1796160	GUIDE:INTERMEDIATE TRANSFER:RIGHT	U010_S001	104
D1796161	GUIDE:INTERMEDIATE TRANSFER:LEFT:ASS'Y	U010_S001	105
D1796164	PLATE:BLADE:BELT CLEANING	U010_S001	106
D1796173	SEAL:DUCT:DENSITY SENSOR	U010_S002	107
D1796182	BRACKET:POSITIONING CONTROL:DRIVEN ROLLER:REAR:ASS'Y	U010_S001	108
D1796185	BRACKET:MOTOR:POSITIONING CONTROL:DRIVEN ROLLER	U010_S001	109
D1796186	DRIVE WERE:DRIVEN ROLLER	U010_S001	110
D1796187	FEELER:POSITIONING CONTROL:DRIVE WERE	U010_S001	111
D1796188	BRACKET:COIL SPRING:MOTOR:POSITIONING CONTROL	U010_S001	112
D1796193	HOLDER:FLAT BELT-TRANSFER:DRIVE ROLLER:ASS'Y	SPECIAL TOOLS U023	15 29
D1796194	HOLDER:FLAT BELT-TRANSFER:CLEANING:ASS'Y	SPECIAL TOOLS U023	16 30
D1796195	LEVER:POSITIONING SENSOR:FLAT BELT-TRANSFER	U010_S001	113
D1796196	SCALE:BRACKET:DRIVEN ROLLER:FRONT	U010_S001	114
D1796197	HOLDER:DRIVEN ROLLER:FRONT	U010_S001	115
D1796230	CASE:TERMINAL:SEPARATION:ASS'Y	U012_S002	50
D1796280	(Sets part number:D0746283 x2):GUIDE PLATE:ENTRANCE:LOWER:ASS'Y	U012_S001	52

Exclusive Parts

Number	Part Name	Group	ID
D1796291	INSULATING COVER:POWER PAC K	U012	53
D1796292	COVER:POWER PACK	U012	54
D1796298	COIL SPRING:COATING BAR:2.2N	U012_S001	55
D1796311	GEAR:TRANSFER ROLLER	U012_S001	57
D1796312	LEVER:PRESSURE:REAR:ASS'Y	U012	58
D1796314	LEVER:PRESSURE:FRONT:ASS'Y	U012	59
D1796324	GEAR:DRIVE:TRANSFER/SEPARATION UNIT	U012	60
D1796334	COIL SPRING:PRESSURE:TRANSFER UNIT	U012	62
D1796350	TRANSFER/SEPARATION UNIT:DRIVE:ASS'Y	U012_S003	63
D1796355	KNOB:STOPPER:TRANSFER/SEPARATION UNIT:REAR	U012	64
D1796356	KNOB:STOPPER:TRANSFER/SEPARATION UNIT:FRONT	U012	65
D1796410	SLIDE RAIL:CASE:TENSION:ROLLER	U022	61
D1796412	SEAL:HOLDER:CLEANING BLADE:UPPER	U011_S001	53
D1796413	SEAL:HOLDER:CLEANING BLADE:FRONT LOWER	U011_S001	54
D1796414	SEAL:HOLDER:CLEANING BLADE:REAR LOWER	U011_S001	55
D1796415	SEAL:HOLDER:CLEANING BLADE:LOWER	U011_S001	56
D1796461	TONER OUTLET SUB-UNIT:COLLECTION BOTTLE:ASS'Y	U013_S003	43
D1796472	COVER:TONER OUTLET SUB-UNIT:ASS'Y	U013	44
D1796483	BRACKET:DRIVE SUB-UNIT:COLLECTION BOTTLE	U013	45
D1796487	DC MOTOR:BRUSHLESS:9.8W	U013	46
D1796501	TONER OUTLET SUB-UNIT:PCU:ASS'Y	U013_S001	47
D1796523	BRACKET:VERTICAL TRANSPORT	U013	49
D1796525	BRACKET:IDLER	U013	50

Number	Part Name	Group	ID
D1796527	CAM:VERTICAL TRANSPORT:DIA15	U013	51
D1796619	STAY:HOLDER:PAPER TRAY:ASS'Y	U006	403
D1796626	SUPPORTING PLATE:RIGHT:HOLDER:PAPER TRAY	U006	404
D1796643	RAIL:TANDEM LCT:MIDDLE:ASS'Y	U006	289
D1796726	COVER:LED:MAIN	U006	290
D1796731	LEVER:PRESSURE:SLIDER	U006_S014	291
		U006_S015	291
		U006_S016	291
D1796734	BRACKET:SLIDER:CAM	U006_S014	292
		U006_S015	292
		U006_S016	292
D1796737	LEVER:PRESSURE RELEASE:REVERSE	U006_S014	293
		U006_S015	293
		U006_S016	293
D1796738	SLIDER:CAM:REVERSE	U006_S014	294
		U006_S015	294
		U006_S016	294
D1796739	LEVER:REVERSE:PRESSURE RELEASE:JOINT	U006_S014	295
		U006_S015	295
		U006_S016	295
D1796751	BRACKET:STM:MM56:TRANSPORT:LENGTHWISE	U006	296
D1796753	BRACKET:JOINT:PROTECT	U006	297
D1796756	BRACKET:CONNECTING:JOINT	U006	298
D1796757	SHAFT:DRIVE	U006	299
D1796758	SYNCHRONOUS BELT:80S2M216	U006	300
D1796761	SYNCHRONOUS BELT:60S2M226	U006	301
D1796762	SYNCHRONOUS BELT:60S2M166	U006	302
D1796763	SYNCHRONOUS BELT:80S2M300	U006	303
D1796764	SYNCHRONOUS BELT:80S2M242	U006	304
D1796765	TRANSPORT ROLLER:VERTICAL TRANSPORT:DRIVE:EXIT	U006	305
D1796766	TRANSPORT ROLLER:VERTICAL TRANSPORT:DRIVE:CONNECTING	U006	306
D1796768	SHAFT:JOINT:CONNECTING:ASS'Y	U006	307

Exclusive Parts

Number	Part Name	Group	ID
D1796775	GUIDE PLATE:OPEN AND CLOSE:VERTICAL TRANSPORT:UPPER	U006	309
D1796777	TORSION SPRING:GUIDE PLATE:OPEN AND CLOSE:UPPER	U006	310
D1796781	GUIDE PLATE:VERTICAL TRANSPORT:F1	U006	311
D1796783	GUIDE PLATE:VERTICAL TRANSPORT:F1:LOWER	U006	312
D1796784	GUIDE PLATE:VERTICAL TRANSPORT:F3	U006	313
D1796790	GUIDE PLATE:VERTICAL TRANSPORT:F2:LOWER	U006	315
D1796797	COMPRESSION SPRING:JOINT:TRANSPORT	U006	316
D1796821	DUCT:DEVELOPMENT:VACUUM:FRONT	U021	26
D1796822	BRACKET:FAN:DEVELOPMENT:COOLING:FRONT	U021	27
D1796823	DUCT:DEVELOPMENT:EXHAUST:MULTI-LANGUAGE:ASS'Y	U022	62
D1796831	DUCT:DEVELOPMENT:EXHAUST:FRONT	U021	28
D1796832	DUCT:DEVELOPMENT:EXHAUST:REAR	U021	29
D1796834	SEAL:DUCT:DEVELOPMENT:EXHAUST:REAR RIGHT	U021	30
D1796835	EXTERIOR:LOUVER:CHARGE CORONA	U021	31
D1796836	DUCT:CHARGE CORONA:CONNECTING:LOWER:ASS'Y	U021_S001	32
D1796840	BRACKET:DUCT:CHARGE CORONA:VACUUM:UPPER	U021	33
D1796841	DUCT:CHARGE CORONA:VACUUM:CONNECTING:UPPER	U021	34
D1796842	FILTER:CHARGE CORONA:VACUUM	U021	35
D1796844	BRACKET:DUCT:CHARGE CORONA:VACUUM	U021	36

Number	Part Name	Group	ID
D1796845	DUCT:CHARGE CORONA:VACUUM:LOWER RIGHT	U021	37
D1796846	DUCT:CHARGE CORONA:VACUUM:LOWER LEFT	U021	38
D1796847	DUCT:CHARGE CORONA:VACUUM:MAIN:RIGHT	U021	39
D1796848	DUCT:CHARGE CORONA:VACUUM:MAIN:LEFT	U021	40
D1796849	SEAL:DUCT:CHARGE CORONA:VACUUM:MAIN	U021	41
D1796858	BRACKET:DUCT:CHARGE:EXHAUST:UPPER	U021	42
D1796860	DUCT:DEVELOPMENT:TONER:UPPER:ASS'Y	U021	43
D1796864	DUCT:DEVELOPMENT:TONER:ASS'Y	U021	44
D1796873	DUCT:FLAT CONVEYER BELT:EXHAUST:UPPER	U021	45
D1796874	DUCT:FLAT CONVEYER BELT:EXHAUST:LOWER	U021	46
D1796875	BRACKET:DUCT:FLAT CONVEYER BELT:EXHAUST	U021	47
D1796889	FILTER:MAIN:EXHAUST:RIGHT	U021	48
D1796893	BRACKET:DUCT:MAIN:EXHAUST:LOWER	U021	49
D1796897	BRACKET:FAN:OPTICAL WRITING UNIT:COOLING	U021	50
D1796898	SEAL:DUCT:OPTICAL WRITING UNIT:VACUUM	U021	51
D1796913	SEAL:INNER COVER:OPTICAL WRITING MD:COOLING	U001_S003	61
D1796914	SEAL:INNER COVER:DEVELOPMENT:COOLING	U001_S003	62
D1796918	SEAL:EXTERIOR:REAR:UPPER	U021	54
D1796927	DUCT:HEAT PIPE:EXHAUST	U021	55
D1796932	DUCT:HEAT SHIELD:FUSING:UPPER	U021	56
D1796934	DUCT:HEAT SHIELD:FUSING:LOWER	U021	57

Exclusive Parts

Number	Part Name	Group	ID
	ER		
D1796940	BRACKET:FAN:EXIT:MIDDLE	U021	58
D1796943	GUARD:FAN:SIDE:VACUUM	U021	60
D1796946	DUCT:EXHAUST:PAPER EXIT SUB-UNIT:A	U021	61
D1796947	BRACKET:DUCT:EXHAUST:PAPER EXIT SUB-UNIT:LEFT	U021	62
D1796948	PLATE:DUCT:EXHAUST:A:ASS'Y	U021	63
D1796953	DUCT:EXHAUST:PAPER EXIT SUB-UNIT:B	U021	64
D1796954	BRACKET:DUCT:EXHAUST:PAPER EXIT SUB-UNIT:RIGHT	U021	65
D1796955	PLATE:DUCT:EXHAUST:B:ASS'Y	U021	66
D1796963	BRACKET:HEAT SHIELD:BELT CLEANING:ASS'Y	U021_S005	67
D1796966	SEAL:DUCT:THERMOPILE:ENTRANCE:UPPER	U021_S005	68
D1796970	DUCT:THERMOPILE	U021	69
D1796971	SEAL:DUCT:THERMOPILE:ENTRANCE:LOWER	U021	70
D1796972	DUCT:THERMOPILE:ENTRANCE:ASS'Y	U021	71
D1796977	GUARD:FAN:OPTICAL WRITING UNIT	U021	72
D1796978	SEAL:EXTERIOR:REAR:SMALL	U021	73
D1796981	BRACKET:DUCT:HEAT PIPE:EXIT:ASS'Y	U021	74
D1796984	DUCT:HEAT PIPE:EXIT	U021	75
D1796985	DUCT:HEAT PIPE:EXIT:MIDDLE	U021	76
D1796987	DUCT:HEAT PIPE:ENTRANCE:ASS'Y	U021_S003	77
D1796995	BRACKET:FAN:TRANSFER/SEPARATION UNIT:COOLING:REAR	U021	79
D1797023	GUIDE PLATE:RECEIVING SUB-UNIT:REVERSE:UPPER	U017	45
D1797050	GUIDE PLATE:DUPLEX:UPPER:LEFT	U017	46
D1797053	GUIDE PLATE:DUPLEX:UPPER:MI	U017	47

Number	Part Name	Group	ID
	DDLE		
D1797056	GUIDE PLATE:DUPLEX:UPPER:RIGHT	U017	48
D1797060	GATE PAWL:DUPLEX:ENTRANCE	U017	49
D1797062	GUIDE PLATE:DUPLEX:ENTRANCE:UPPER	U017	51
D1797066	GUIDE PLATE:DUPLEX:ENTRANCE:LOWER	U017	52
D1797070	GUIDE PLATE:DUPLEX:OPEN AND CLOSE:LEFT	U017	53
D1797071	SUPPORTING PLATE:GUIDE PLATE:DUPLEX:OPEN AND CLOSE	U017	54
D1797075	GUIDE PLATE:DUPLEX:OPEN AND CLOSE:RIGHT	U017	55
D1797076	GUIDE PLATE:DUPLEX:LOWER	U017	56
D1797081	BRACKET:DC STEPPER MOTOR:DUPLEX:LEFT	U017	57
D1797082	BRACKET:DC STEPPER MOTOR:DUPLEX:RIGHT	U017	58
D1797083	SHAFT:MISFEED REMOVAL:DUPLEX	U016_S004	112
		U017_S001	59
		U017_S009	59
D1797084	BRACKET:MISFEED REMOVAL:DUPLEX	U016	113
		U017	60
D1797085	TRANSPORT ROLLER:DUPLEX	U017_S002	61
		U017_S003	61
		U017_S004	61
		U017_S005	61
		U017_S006	61
		U017_S007	61
		U017_S008	61
D1797096	BRACKET:DUPLEX:OPEN AND CLOSE:LEFT:PEEN	U017	62
D1797098	BRACKET:DUPLEX:OPEN AND CLOSE:RIGHT:PEEN	U017	63
D1797102	GUIDE PLATE:RECEIVING SUB-UNIT:REVERSE:LOWER	U017	64
D1797120	TRANSPORT ROLLER:REVERSE:D	U017_S010	68

Exclusive Parts

Number	Part Name	Group	ID
	UPLEX		
D1797131	BRACKET:ROLLER:PEEN	U017	69
D1797198	GATE PAWL:REVERSE:MIDDLE:INNER BACK	U016	114
D1797199	GATE PAWL:REVERSE:MIDDLE:FRONT	U016	115
D1797220	COVER:ARM:OPERATION SUB-UNIT:FRONT	U002	46
D1797233	COVER:ARM:OPERATION SUB-UNIT:FRONT	U002	47
D1797254	PCB:SVGA:SDUSB:ASS'Y	U002_S001	48
		U002_S002	48
		U002_S003	48
D1797299	LCD:10.4SVGA_SH	U002_S001	49
		U002_S002	49
		U002_S003	49
D1797302	(NA):COVER:FRONT:ASS'Y	U002_S001_S001	50
D1797304	(CHN/EU,AA,TWN,KOR):COVER:FRONT:ASS'Y	U002_S002_S001	51
		U002_S003_S001	51
D1797330	COVER:REAR	U002_S001	52
		U002_S002	52
		U002_S003	52
D1797331	KEYTOP:FUNCTION	U002_S001	53
		U002_S002	53
		U002_S003	53
D1797332	KEYTOP:HOME	U002_S001	54
		U002_S002	54
		U002_S003	54
D1797333	LENS:STATUS DISPLAY	U002_S001	55
		U002_S002	55
		U002_S003	55
D1797334	LENS:POWER SOURCE	U002_S001	56
		U002_S002	56
		U002_S003	56
D1797335	KEYTOP:OPTION:C	U002_S001	57
		U002_S002	57
		U002_S003	57
D1797350	(NA):PLATE:LOGO:RIC	U023	31

Number	Part Name	Group	ID
D1797363	(EU):DECAL:FUNCTION:MULTI-LANGUAGE	U023	33
D1797364	(CHN):DECAL:FUNCTION:MULTI-LANGUAGE	U023	34
D1797387	GASKET:4X4:L7	U002_S001	58
		U002_S002	58
		U002_S003	58
D1797388	GASKET:4X4:L33	U002_S001	59
		U002_S002	59
		U002_S003	59
D1797389	GASKET:7X2:L15	U002_S001	60
		U002_S002	60
		U002_S003	60
D1797390	GASKET:10X10:L38	U002_S001	61
		U002_S002	61
		U002_S003	61
D1797512	COVER:PAPER TRAY:NO.2	U006	317
D1797513	COVER:PAPER TRAY:NO.3	U006	318
D1797518	SHAFT:STOPPER:PAPER TRAY	U006	319
D1797519	BRACKET:STOPPER:PAPER TRAY	U006	320
D1797525	STOPPER:REGISTRATION:TANDEM LCT:ASS'Y	U006_S005	321
D1797528	CAP:STOPPER:REGISTRATION	U006_S005	322
D1797533	JOINT:LINK:UN LOCK:PEEN	U006	323
D1797540	SCREW:DIA6:M4X3:ADHESIVE	U006	324
D1797550	COVER:PAPER TRAY:NO.1:UPPER	U006	326
D1797561	ARM:LINK:LEFT	U006	327
D1797562	ARM:LINK:RIGHT	U006	328
D1797564	BRACKET:SLIDER:GRIP:UPPER	U006	329
D1797566	BRACKET:ARM:LINK:RIGHT	U006	330
D1797573	BRACKET:ARM:UN LOCK	U006	331
D1797576	ARM:LINK:UN LOCK	U006	333
D1797579	COVER:GRIP:INNER BACK	U006	334
D1797581	STAY:COVER:TANDEM LCT	U006	335
D1797586	STOPPER:TANDEM LCT	U006	336
D1797591	PLATE:TRANSPARENT:LED	U006	337
D1797596	DIFFUSION PLATE:LED	U006	338
D1797597	COVER:LED	U006	339

Exclusive Parts

Number	Part Name	Group	ID
D1799510	OPC Drum	U009	104
D1799640	DEVELOPER BLACK	U009	150
D1806801	DUCT:FLAT CONVEYER BELT:EXH AUST:SMALL:ASS'Y	U022	63
D1806811	DUCT:FLAT CONVEYER BELT:EXH AUST:CONNECTING:ASS'Y	U021_S002	81
D1806818	OZONE FILTER:MAIN:EXHAUST:RI GHT	U021	83
D1806821	BASE:HEAT SHIELD:FUSING SUB- UNIT:SUB-ASS'Y	U021	84
D1806831	GASKET:DUCT:CHARGE CORONA :VACUUM	U021	86
D1941202	ADF:SINAI-B:ASS'Y	U003_S001	296
D1941234	SUPPORTING PLATE:BRACKET:L OCK	U022	64
D1942945	HOLDER:CAM:SHIFT	U007	149
D1943566	GRIP:LEVER:BASE:TONER BANK	U008	88
D1944101	SHAFT:CAM:PRESSURE	U015_S001	145
		U015_S003	145
		U015_S004	145
D1944106	JOINT:CAM:PRESSURE	U015_S001	146
		U015_S003	146
		U015_S004	146
D1944759	BRACKET:LOCK:EXIT	U022	65
D1945126	PCB:IDB	U004	67
D1946737	CAP:COVER:ARM:FRONT	U002	62
D1947346	DC MOTOR:RISE:TANDEM LCT:AS S'Y:19.2W:BRUSH	U006	340
D1947552	SIDE PLATE:TANDEM LCT:LEFT SI DEWAYS	U006_S018	341
		U006_S020	341
		U006_S022	341
D1947635	ARM:END FENCE:LOCK	U006_S001	343
		U006_S002	343
D1957238	PCB:IOKEY:ASS'Y	U002_S001	63
		U002_S002	63
		U002_S003	63
D1957245	ABSORPTION SHEET:LCD	U002_S001	64
		U002_S002	64

Number	Part Name	Group	ID
		U002_S003	64
D2236231	DC SOLENOID:LOCK:ASS'Y	U006_S011	344
D2236233	DC SOLENOID:COUPLING:ASS'Y	U006_S012	345
D2236722	DC SOLENOID:END FENCE:FRON T:ASS'Y	U006_S017_S002	346
		U006_S019_S002	346
		U006_S021_S002	346
D2236732	DC SOLENOID:END FENCE:REAR: ASS'Y	U006_S017_S003	347
		U006_S019_S003	347
		U006_S021_S003	347
D2236747	DC MOTOR:TANDEM LCT:19.2W:B RUSH	U006_S018	348
		U006_S020	348
		U006_S022	348
D2416290	LED:RED	U006	349
		U016	116
		U017	70
		U022	66
D2445730	PCB:DCSW	U019	42
D2452528	BUSHING:MM8	U016	117
D2583910	FAN:MM60X15	U014	16
D2701132	SLIDE RAIL:PULL OUT:PROTECT	U022	67
D2701151	SLIDE RAIL:PULL OUT:RIGHT UPP ER	U022	68
D2701155	BRACKET:RADIAL BALL BEARING	U022	69
D2701160	RAIL:INTERMEDIATE TRANSFER	U022	70
D2701165	SUPPORTING PLATE:RAIL:INTER MEDIATE TRANSFER	U022	71
D2701166	SUPPORTING PLATE:AUXILIARY:R AIL:INTERMEDIATE TRANSFER	U022	72
D2701167	STOPPER:SLIDE RAIL:RIGHT UPP ER	U022	73
D2701171	SUPPORTER:PULL OUT:RIGHT UP PER	U022	74
D2701173	STOPPER:SUPPORTER	U022	75
D2701174	GUIDE:PICK-UP PAPER JAM	U022	76
D2701191	DECAL:PICK-UP PAPER JAM:OPE RATION PANEL:ENGLISH	U001	93
D2701195	(CHN/EU,AA,TWN,KOR):DECAL:PI CK-UP PAPER JAM:OPERATION P	U023	51

Exclusive Parts

Number	Part Name	Group	ID
	ANEL:MANY LANGUAGES		
D2701219	SHAFT:LOCK:PULL OUT:LEFT	U022	91
D2701317	DRIVE SUB-UNIT:ON-OFF:PRESSURE ROLLER	U018_S009	67
D2701399	DECAL:LASER DIODE:ABS	U009	106
D2701449	COVER:TONER SUPPLY:UPPER:ASS'Y	U001_S001	95
D2701481	DOOR:FRONT LEFT:UPPER	U001	64
D2701509	BRACKET:SUPPORTING PLATE:DOOR:FRONT RIGHT	U001_S003	67
D2701538	INNER COVER:PULL OUT:RIGHT	U001	69
D2701540	INNER COVER:PULL OUT:LEFT	U001	70
D2701541	DECAL:H-TEMP WARNING:EXIT:FUSING:ABS	U001	71
D2701542	DECAL:H-TEMP WARNING:PAPER FEED:ABS	U001	72
D2701546	DECAL:PULL OUT:MIDDLE:ABS	U001_S006	74
D2701551	COVER:SIDE:RIGHT:VACUUM	U023	39
D2701562	INNER COVER:REVERSE SUB-UNIT:UPPER	U001	75
D2701563	INNER COVER:REVERSE SUB-UNIT:LOWER	U001	76
D2701564	DECAL:TOTAL COUNTER:ABS	U001	77
D2701566	INNER COVER:LEFT UPPER	U001	78
D2701567	DECAL:MAIN SWITCH:ABS	U001	79
D2701568	DECAL:POSITIONING DISPLAY:TCRU:ABS	U001	80
		U001_S006	80
		U009_S003	107
D2701570	DECAL:A2/A3	U006	350
D2701571	DECAL:B1	U001	81
D2701573	DECAL:B2	U001	82
D2701584	DECAL:MISFEED REMOVAL:LOCATION	U001_S003	99
D2701585	DECAL:D1	U001	83
D2701586	DECAL:E	U001	84
D2701588	(NA):DECAL:CAUTION:PULL OUT:ENGLISH	U023	58
D2701591	DECAL:MISFEED REMOVAL:ABC	U001_S003	100

Number	Part Name	Group	ID
D2701592	DECAL:MISFEED REMOVAL:DEZ:ABS	U001_S004	85
D2701593	OZONE FILTER:EXHAUST:PAPER EXIT SUB-UNIT	U023	40
D2701761	(NA):DECAL:CAUTION CHART:INK JET:PAPER	U023	55
D2701787	DUCT:POWER SUPPLY UNIT:PAPER FEED:COOLING	U020	40
D2701901	OPTICAL WRITING UNIT:ASS'Y	U005_S001	11
D2702214	DUCT:CHARGE UNIT:ASS'Y	U009_S006	108
D2702247	DUCT:SIDE PLATE	U009	109
D2702602	REGISTRATION ROLLER:GATE:ASS'Y	U007_S013	187
D2702622	TENSION SPRING:48N	U007	150
D2702624	SIDE PLATE:SHIFT:REGISTRATION:FRONT:PEEN	U007	181
D2702627	SIDE PLATE:SHIFT:REGISTRATION:REAR:PEEN	U007	184
D2702632	BRACKET:HOOK:COIL SPRING:REAR:PEEN	U007	151
D2702634	BRACKET:HOOK:COIL SPRING:FRONT:PEEN	U007	152
D2702636	GUIDE PLATE:SHIFT:REGISTRATION:LOWER	U007	153
D2702637	COLOR:4M	U007	154
D2702641	DUCT:SHIFT:CIS	U007	155
D2702644	STAY:SHIFT:REGISTRATION:ASS'Y	U007	183
D2702647	SHAFT:SHIFT	U007	177
D2702656	GUIDE PLATE:REGISTRATION:CIS	U007	156
D2702743	HOLDER:SHAFT:ARM	U007	190
D2702744	BRACKET:HOLDER:SHAFT	U007	191
D2702766	TIMING ROLLER:TRANSFER:DRIVE	U007_S005	157
D2702771	ARM:REGISTRATION:TIMING:ASS'Y	U007_S004	179
D2702786	DUCT:FAN:CONTACT IMAGE SENSOR	U007	158

Exclusive Parts

Number	Part Name	Group	ID
D2702802	STAY:SHIFT:TRAILING EDGE	U007	159
D2702810	GUIDE PLATE:SHIFT:RIGHT UPPER:PEEN	U007	160
D2702816	SHAFT:TRAILING EDGE:SHIFT	U007	186
D2702851	GUIDE PLATE:CONNECTING:OPEN/CLOSE	U007	161
D2702965	SHAFT:GUIDE PLATE:OPEN AND CLOSE	U007	192
D2702986	BRACKET:GUIDE PLATE:CONNECTION:LARGE CAPACITY TRAY	U007	147
D2703079	SERVICE PARTS:DENSITY SENSOR:DEVELOPMENT	U009_S004	146
D2703097	COVER:GEAR:DEVELOPMENT	U009_S004	143
D2703134	DECAL:WARNING:AROUND THE PHOTOCONDUCTOR:ABS	U009_S003	112
D2703136	DECAL:DEVELOPMENT UNIT:CAUTION	U009_S003	113
D2703310	SHAFT:DRIVE:TONER BOTTLE:DIA6	U008	92
D2703335	SEAL:CASE:TONER BANK:LOWER	U008_S003 U008_S005	95 95
D2703336	SEAL:CASE:TONER BANK:FRONT	U008_S003 U008_S005	97 97
D2704009	HOLDER:M5	U015_S001 U015_S003 U015_S004	147 147 147
D2704180	HOLDER:HEATER:HEAT ROLLER:REAR	U015_S001 U015_S003 U015_S004	150 150 150
D2704181	HOLDER:HEATER:HEAT ROLLER:FRONT	U015_S001 U015_S003 U015_S004	151 151 151
D2704185	RING:GUIDE:HEAT ROLLER:DIA39.2	U015_S001 U015_S003 U015_S004	152 152 152
D2704236	TORSION SPRING:FUSING/PAPER EXIT UNIT:FRONT	U015_S001 U015_S003 U015_S004	153 153 153

Number	Part Name	Group	ID
D2704237	TORSION SPRING:FUSING/PAPER EXIT UNIT:REAR	U015_S001 U015_S003 U015_S004	154 154 154
D2704239	STRIPPER PLATE:ASS'Y	U015_S001 U015_S003 U015_S004	169 169 169
D2704277	DECAL:H-TEMP WARNING:FUSING	U015_S001_S003 U015_S003_S003 U015_S004_S003	166 166 166
D2704290	DRIVE UNIT:WEB:CLEANING:ASS'Y	U015_S001_S007 U015_S003_S007 U015_S004_S007	155 155 155
D2704311	WEB:CLEANING UNIT:ASS'Y	U015_S002	156
D2704313	COVER:WEB:CLEANING FELT	U015_S002_S001	157
D2704338	FEELER:CLEANING	U015_S002	158
D2704343	ROLLER:PLATE	U015_S002	159
D2704417	(NA):FUSING UNIT:208V:ASS'Y	U015_S001	171
D2704418	(CHN/EU,AA,TWN,KOR):FUSING UNIT:220V:ASS'Y	U015_S003 U015_S004	174 174
D2704535	DRIVE ROLLER:COOLING UNIT:EXIT:PRESS FIT	U016_S002	118
D2704543	SHAFT:MISFEED REMOVAL:EXIT	U016_S003	119
D2704547	BRACKET:TIGHTENER:EXIT:ASS'Y	U016	153
D2704551	COIL SPRING:TENSIONER:EXIT	U016	120
D2704555	SYNCHRONOUS BELT:B50S2M200	U016	122
D2704557	COVER:EXIT:MOTOR	U016	123
D2704658	SHEET:HANDLE:LOCK:ASS'Y	U016	124
D2704670	BRACKET:MAGNET CATCH:DUPLICATE	U017	86
D2704731	GUIDE PLATE:EXIT:UPPER:SUB-ASS'Y	U016	125
D2704737	BRACKET:LINK:LEVER	U016	126
D2704740	BRACKET:ARM:STOPPER:RELEASE	U016	127
D2704742	SHAFT:GUIDE PLATE:EXIT:UPPER:OPEN/CLOSE	U016	128
D2704745	PIN:ARM:GRIP	U016	130
D2704746	BRACKET:CAM:ON-OFF	U016	131

Exclusive Parts

Number	Part Name	Group	ID
D2704748	COMPRESSION SPRING:STOPPER:20N	U016	132
D2704750	STOPPER:GUIDE PLATE:EXIT:UPPER:SUB-ASS'Y	U016_S011	129
D2704753	PLATE:HANDLE:GUIDE:OPEN AND CLOSE	U016	133
D2704757	STOPPER:GUIDE PLATE:EXIT:INNER BACK	U016	134
D2704764	DC SOLENOID:GATE PAWL:SWITCHBACK	U016	135
D2704768	GATE PAWL:SWITCHBACK	U016	83
D2704800	SHAFT:GATE PAWL:REVERSE	U016	151
D2704933	GUIDE PLATE LEVER HOOK	U017	71
D2705385	TEMPERATURE SENSOR:FUSING UNIT:LOWER:17PIN	U015_S001	160
		U015_S003	160
		U015_S004	160
D2705406	PCB:IOB	U019	43
D2705415	PCB:EDRB	U019	44
D2705422	PCB:DRB	U007_S015	162
D2705427	PCB:RYB	U019	45
D2705451	PCB:BCU:ASS'Y	U020	52
D2705716	(D270-NA(17),CHN,EU,AA,TWN,KOR):SERVICE PARTS:PCB:CTL:ASS'Y	U020	55
D2705717	(D271):SERVICE PARTS:PCB:CTL:ASS'Y	U020	53
D2705718	(D272):SERVICE PARTS:PCB:CTL:ASS'Y	U020	54
D2705723	(D270-NA(57)):SERVICE PARTS:PCB:CTL:ASS'Y	U020	45
D2705960	COVER:POWER SUPPLY UNIT:C/T BOX	U020	46
D2705975	FILTER:COVER:C/T BOX	U020	47
D2706002	TRANSFER UNIT:INTERMEDIATE TRANSFER:ASS'Y	U010_S001	129
D2706010	SIDE PLATE:INTERMEDIATE TRANSFER:ASS'Y	U010_S001	117
D2706022	DECAL:CAUTION:ORIGINAL:MANY	U023	54

Number	Part Name	Group	ID
	LANGUAGES		
D2706078	PAPER TRANSFER BIAS ROLLER	U010_S001	118
D2706080	STAND:RISE:EACH:SEPARATION/TRANSPORT	U014	17
D2706124	GUIDE PLATE:INTERMEDIATE TRANSFER:ASS'Y	U010_S001	119
D2706128	GUIDE:TRANSPORT:INTERMEDIATE TRANSFER:10MM:ASS'Y	U010_S001	120
D2706129	GUIDE:TRANSPORT:INTERMEDIATE TRANSFER:4MM:ASS'Y	U010_S001	121
D2706170	DRUM STAY:INTERMEDIATE TRANSFER:SUB-ASS'Y	U010_S002	125
D2706175	INNER COVER:INTERMEDIATE TRANSFER:LEVER	U010_S002	122
D2706230	SIDE PLATE:TRANSFER/SEPARATION UNIT:FRONT:ASS'Y	U012_S001_S003	67
D2706304	TRANSPORT SCREW:TRANSFER ROLLER:ASS'Y	U012_S001	68
D2706333	SHAFT:LEVER:PRESSURE:TRANSFER ROLLER	U012	77
D2706350	BRACKET:SHAFT:CONTACT POINT:TRANSFER ROLLER	U012	73
D2706360	GROUND PLATE:TRANSPORT SCREW:ASS'Y	U012_S001	69
D2706416	SEAL:HOLDER:CLEANING BLADE:BEHIND	U011_S001	60
D2706453	SHAFT:MISFEED REMOVAL	U006	385
D2706541	SHAFT:DRIVE:FEED:ASS'Y	U006_S008	386
		U006_S009	386
		U006_S010	386
D2706570	COLLECTION BOTTLE:SERVICE PARTS:ASS'Y	U013_S004	61
D2706628	PAPER FEED UNIT:PAPER BANK:ASS'Y	U006_S014	382
		U006_S015	382
		U006_S016	382
D2706646	(EU,AA,TWN,KOR):TANDEM LIGHT:RIGHT:ASS'Y	U006_S019	408
D2706647	(NA):TANDEM LIGHT:RIGHT:ASS'Y	U006_S017	407

Exclusive Parts

Number	Part Name	Group	ID
D2706658	FLANGED HEXAGONAL HEAD BOLT:M3X6	U006_S014	352
		U006_S015	352
		U006_S016	352
D2706659	ROLLER:GUIDE	U006_S014	353
		U006_S015	353
		U006_S016	353
D2706664	HOOK:COIL SPRING:SLIDER	U006_S014	354
		U006_S015	354
		U006_S016	354
D2706668	TENSION SPRING:REVERSE ROLLER	U006_S014	355
		U006_S015	355
		U006_S016	355
D2706678	COVER:CUSHION	U006_S017	356
		U006_S019	356
		U006_S021	356
D2706687	(CHN):TANDEM LCT:RIGHT:ASS'Y	U006_S021	359
D2706688	(CHN):TANDEM LCT:LEFT:ASS'Y	U006_S022	360
D2706721	COVER:GUARD:HARNESS	U006_S018	361
		U006_S020	361
		U006_S022	361
D2706725	COVER:GUARD:HARNESS	U006	362
D2706740	STAY:REVERSE:ASS'Y	U006_S014	363
		U006_S015	363
		U006_S016	363
D2706806	SEAL:DUCT:LARGE	U021	87
D2706813	SHEET:GUIDE MILER:PAPER FEE D:COOLING:LOWER	U022	77
D2706814	SHEET:GUIDE MILER:PAPER FEE D:COOLING:UPPER	U022	78
D2706815	SHEET:GUIDE MILER:PAPER FEE D:COOLING:INNER BACK	U022	79
D2706818	SEAL:DUCT:FAN:MM97	U021	117
		U021_S002	117
D2706822	SEAL:DUCT:HEAT SHIELD:FUSING:A	U021	115
D2706823	OZONE FILTER:DUCT:MAIN:REAR	U021	88
D2706851	DUCT:CHARGE CORONA:EXHAUST:MIDDLE:RIGHT	U021	89

Number	Part Name	Group	ID
D2706853	DUCT:CHARGE CORONA:EXHAUST:MIDDLE:REAR	U021	90
D2706854	DUCT:CHARGE CORONA:EXHAUST:MIDDLE:FRONT	U021	91
D2706856	DUCT:CHARGE CORONA:EXHAUST:CONNECTING:FRONT	U021	92
D2706857	DUCT:CHARGE CORONA:EXHAUST:CONNECTING:REAR	U021	93
D2706869	DUCT:CHARGE CORONA:EXHAUST:MULTI-LANGUAGE:REAR	U021	94
D2706870	DUCT:CHARGE CORONA:EXHAUST:MULTI-LANGUAGE:FRONT	U021	95
D2706890	DUCT:MAIN:EXHAUST:FRONT	U021	96
D2706891	DUCT:MAIN:EXHAUST:REAR	U021	97
D2706892	COVER:FILTER:EXHAUST	U021	98
D2706896	DUCT:OPTICAL WRITING UNIT:VACUUM:FRONT	U021	99
D2706909	SEAL:DUCT:LARGE	U021	118
		U021_S001	118
D2706910	SEAL:DUCT:CHARGE CORONA:EXHAUST:MIDDLE	U021	100
D2706911	SEAL:DUCT:MAIN:EXHAUST:FRONT	U021	101
D2706917	SEAL:DUCT:MAIN:EXHAUST	U021	102
D2706920	SEAL:DUCT:MAIN:EXHAUST:A	U021	103
D2706921	SEAL:DUCT:MAIN:EXHAUST:B	U021	104
D2706929	COVER:FAN:MAIN:EXHAUST	U021	105
D2706942	BRACKET:FAN:SIDE:RIGHT:SUB-ASS'Y	U021_S004	110
D2706944	BRACKET:GUIDE:BASE	U021	111
D2706945	FILTER:VACUUM:MAIN:RIGHT	U021	112
D2706947	BRACKET:AUXILIARY:BASE	U021	113
D2706948	SHEET:SCREW:FILTER	U001	91
		U021	114
D2706949	SHEET:COVER:MAIN:RIGHT	U001	92
D2706989	SEAL:DUCT:HEAT PIPE:ENTRANCE	U021	116
		U021_S003	116
D2707061	SHAFT:GATE PAWL:DUPLICATION:ENT	U017	82

Exclusive Parts

Number	Part Name	Group	ID
	RANCE		
D2707103	DRUM STAY:RECEIVING SUB-UNIT:REVERSE	U017	72
D2707197	GATE PAWL:REVERSE:MIDDLE:FRONT	U016	137
D2707230	(NA):OPERATION PANEL:ASS'Y	U002_S001	65
D2707231	(CHN/EU,AA,TWN,KOR):OPERATION PANEL:ASS'Y	U002_S003	66
D2707232	(CHN/EU,AA,TWN,KOR):OPERATION PANEL:ASS'Y	U002_S002	67
D2707250	PCB:LCDCAR2FT:ASS'Y	U002_S001	68
		U002_S002	68
		U002_S003	68
D2707362	(NA):DECAL:FUNCTION:MULTI-LANGUAGE	U023	52
D2707389	DECAL:PAPER SET DIRECTION:TANDEM LCT:LEFT	U006_S018	409
		U006_S020	409
		U006_S022	409
D2707531	COVER:PAPER TRAY:NO.1	U006	364
D2707544	SIDE FENCE:TANDEM LCT:LEFT REAR:ASS'Y	U006_S018_S002	389
		U006_S020_S002	389
		U006_S022_S001	389
D2707548	DECAL:CAUTION:INSERT:PAPER FEED SUB-UNIT	U006_S018_S002	384
		U006_S020_S002	384
		U006_S022_S001	384
D2707558	(EU,AA,TWN,KOR):TANDEM LCT:LEFT:ASS'Y	U006_S020	410
D2707559	(NA):TANDEM LCT:LEFT:ASS'Y	U006_S018	411
D2707574	SHAFT:ARM:UN LOCK	U006	394
D2707648	DECAL:MULTI-LANGUAGE:MAIN:13:ABS	U023	41
D2707649	DECAL:MULTI-LANGUAGE:MAIN:5	U023	57
D2707669	(NA):DECAL:POWER SOURCE:OFF:ABS	U023	42
D2707671	(NA):DECAL:CAUTION CHART:COPY:ORIGINAL	U023	53
D2707681	(Pro 8200S):MODEL NAME PLATE	U023	43
D2709590	NVRAM	U020	48

Number	Part Name	Group	ID
D2709901	GEAR:FUSING UNIT:ASS'Y	U015_S001	162
		U015_S003	162
		U015_S004	162
D2717681	(Pro 8210S):MODEL NAME PLATE	U023	44
D2727681	(Pro 8220S):MODEL NAME PLATE	U023	45
D3551196	ROLLER:DETENT	U006_S013_S001	367
		U006_S013_S002	367
D3551333	SHIELDING PLATE:SAFETY SWITCH:DOOR	U001_S002	86
D3553810	BRACKET:DETENT:RIGHT:ASS'Y	U006_S013_S001	368
D3553840	BRACKET:DETENT:ASS'Y	U006_S013_S002	370
D3553844	SHOE:HANDLE:RELEASE	U006	371
D3553858	TORSION SPRING:GUIDE PLATE:16N	U006_S013	372
D3775852	BRACKET:NIC:VC2:ENGINE	U023	46
D3AZ1762	BRACKET:MOTOR:MIDDLE	U003_S001	91
D3B01320	HINGE:LEFT:ASS'Y	U003_S001	273
D3B01350	HINGE:RIGHT:ASS'Y	U003_S001	274
D3B03810	GUIDE PLATE:EXIT:UPPER:ASS'Y	U003_S001_S009	92
D3B04711	GUIDE PLATE:PRESSURE PLATE:LEFT:ASS'Y	U003_S001_S014	93
D3B04722	CUSHION:TAPE:SMALL	U003_S001_S014	96
D3B04724	CUSHION:PRESSURE PLATE:LARGE	U003_S001_S014	97
D3B04725	CUSHION:PRESSURE PLATE:SMALL	U003_S001_S014	98
D3B04730	PRESSURE PLATE:ASS'Y	U003_S001_S014	293
D3FF1451	HOLDER:FEELER:APS	U003_S001	294
D3FF2219	GUIDE:PAPER FEED BELT:FRONT	U003_S001_S007	275
D3FF2233	BRACKET:PAPER FEED BELT	U003_S001_S007	282
D3FF2851	SENSOR COVER:PHOTO INTERRUPTOR	U003_S001	277
D3FF2852	COVER:SENSOR	U003_S001	278
D3FF6071	DECAL:CAUTION:ORIGINAL:PICK-UP PAPER JAM	U003_S001_S007	279
D4122653	BUSHING:DIA6	U003_S001_S011	99
		U003_S001_S011_S001	99

Exclusive Parts

Number	Part Name	Group	ID
D4122669	TENSION SPRING:GUIDE PLATE:PRESSURE:2N	U003_S001_S011	100
D4123145	TENSION SPRING:LEVER:MISFEED REMOVAL	U003_S001	101
D4342535	TORSION SPRING:PROOF TRAY	U007	163
D5161326	DECAL:PAPER TRAY:DESIGN SKETCH:3	U006	373
D5163823	TIMING BELT:60S2M146	U017	73
D5165200	PCB:LED:ASS'Y	U006	374
D5224906	STEPPED SCREW:M3:DIA6:1.7MM:ROUND POINT	U003_S001	102
D5412241	REVERSE ROLLER:PAPER FEED	U003_S001	103
D5431313	COMPRESSION SPRING:HINGE:LEFT	U003_S001	104
D5431625	GEAR:Z24:SEPARATION	U003_S001	105
D5431717	SHAFT:PULLEY:SCANNING:EXIT	U003_S001	106
D5431821	TIMING PULLEY:T33/Z24	U003_S001	107
D5431822	FLANGE:DIA24	U003_S001	108
D5433314	SHEET:SCANNING:ENTRANCE:MIDDLE	U003_S001_S013	109
D5433631	ROLLER:SCANNING:BEHIND:ASS'Y	U003_S001_S011	110
D5433635	GEAR:ROLLER:SCANNING:BEHIND	U003_S001_S011	111
D5434382	COMPRESSION SPRING:PULL OUT	U003_S001	112
D5434393	CUSHION:GUIDE PLATE:ENTRANCE:PAPER FEED:INNER BACK	U003_S001	113
D5435125	SPRING PLATE:CABLE:CONTACT IMAGE SENSOR	U003_S001	114
D5481243	STAND:UN LOCK	U001	87
D6421454	FEELER:APS	U003_S001	115
D6830361	GUIDE:EXIT:LOWER:ASS'Y	U003_S001_S011	283
D6831362	COMPRESSION SPRING:HINGE:RIGHT	U003_S001	119
D6831385	BRACKET:SAFETY SWITCH:PAPER FEED	U003_S001	120
D6831386	SHAFT:CONTACT POINT:ON OFF	U003_S001	121

Number	Part Name	Group	ID
	DETECTOR:PAPER FEED		
D6831387	TENSION SPRING:ON OFF DETECTOR:PAPER FEED	U003_S001	122
D6831413	BRACKET:SAFETY SWITCH	U003_S001	123
D6831414	SPRING PLATE:SAFETY SWITCH	U003_S001	124
D6831415	FEELER:SENSOR:ON OFF DETECTOR	U003_S001	125
D6831614	BRACKET:MOTOR:PAPER FEED	U003_S001	127
D6831615	STAY:MOTOR:PAPER FEED	U003_S001	128
D6831617	DC MOTOR:ASS'Y:20W:BRUSHLESS	U003_S001	129
D6831620	SHAFT:SEPARATION:DRIVE:INPUT:SUB-ASS'Y	U003_S001_S001	130
D6831632	SHAFT:REVERSE ROLLER:SUB-ASS'Y	U003_S001_S002	131
D6831635	GEAR:REVERSE ROLLER:DRIVE	U003_S001	132
D6831640	SHAFT:INPUT:PAPER FEED:SUB-ASS'Y	U003_S001_S003	133
D6831642	TIMING PULLEY:IDLER:PULL OUT	U003_S001	134
D6831643	GEAR:INPUT:PAPER FEED	U003_S001	135
D6831644	SPACER:SHAFT:INPUT:PAPER FEED	U003_S001	136
D6831671	BRACKET:MOTOR:PICK UP	U003_S001	137
D6831675	DC STEPPER MOTOR:DIA42:T15:52M:ASS'Y	U003_S001	138
D6831680	CAM:PICKUP	U003_S001_S004	139
D6831682	TIMING PULLEY:PICKUP:DRIVE	U003_S001	140
D6831691	GEAR:PAPER FEED:COUPLING	U003_S001	141
D6831711	BRACKET:MOTOR:PULL OUT	U003_S001	142
D6831718	STAY:MOTOR:PULL OUT	U003_S001	143
D6831766	DC MOTOR:10W:BRUSHLESS	U003_S001	144
D6831811	BRACKET:MOTOR:SCANNING:EXIT	U003_S001	145
D6831813	TIMING PULLEY:COUPLING:SCANNING:INNER BACK	U003_S001	146
D6831814	TIMING PULLEY:COUPLING:EXIT	U003_S001	147
D6831822	DC MOTOR:20W:SCANNING:20W:BRUSHLESS	U003_S001	148

Exclusive Parts

Number	Part Name	Group	ID
D6831841	BRACKET:TENSIONER:SCANNING :INNER BACK	U003_S001	149
D6831845	PULLEY:IDLER:DIA14	U003_S001	150
		U013	55
D6831851	BRACKET:TENSIONER:SCANNING :FRONT	U003_S001	151
D6831855	TIMING PULLEY:TENSIONER:SCA NNING:FRONT	U003_S001	152
D6831856	TENSION SPRING:TENSION:SCAN NING:FRONT	U003_S001	153
D6831912	BRACKET:HINGE:RIGHT	U003_S001	154
D6832110	ROLLER:PULL OUT:DRIVE	U003_S001_S005	155
D6832112	TIMING PULLEY:ROLLER:PULL OU T:DRIVE	U003_S001	156
D6832210	ROLLER:MIDDLE:DRIVE	U003_S001_S006	157
D6832221	GEAR:IDLER:Z18	U003_S001_S007	158
D6832222	STOPPER:SHAFT:SEPARATION:D RIVE	U003_S001	159
D6832224	GUIDE:PAPER FEED:ENTRANCE:F RONT	U003_S001_S007	160
D6832228	PICKUP ROLLER	U003_S001_S007	161
D6832229	TIMING PULLEY:GEAR:T19/Z23	U003_S001_S007	162
D6832231	BRACKET:PICKUP	U003_S001_S007	163
D6832232	TIMING PULLEY:PICKUP:T21	U003_S001_S007	164
D6832235	SHAFT:PICKUP:SUB-ASS'Y	U003_S001_S007	166
D6832236	SHEET:BRACKET:PICKUP:INNER BACK	U003_S001_S007	167
D6832240	GUIDE:PAPER FEED:ENTRANCE:I NNER BACK:ASS'Y	U003_S001_S007 S001	168
D6832242	SHEET:GUIDE:PAPER FEED:INNE R BACK	U003_S001_S007 S001	169
D6832272	LEVER:PICKUP ROLLER:RISE	U003_S001_S007	170
D6832311	TORQUE LIMITER MECHANICAL C LUTCH:SEPARATOR	U003_S001	171
D6832393	HOLDER:ORIGINAL TABLE	U003_S001	172
D6832417	SHEET:ENTRANCE:SEPARATION PAD	U003_S001	173
D6832510	GUIDE PLATE:PAPER FEED:LOWE	U003_S001	174

Number	Part Name	Group	ID
	R:ASS'Y		
D6832728	STOPPER:RELEASE:SHAFT:BASE	U003_S001	175
D6832729	JOINT:RISING TRAY:AUXILIARY	U003_S001	176
D6832733	FEELER:SENSOR:ORIGINAL SENS OR	U003_S001	177
D6832742	CUSHION:STOPPER PAWL	U003_S001	178
D6832743	SHEET:CUSHION:STOPPER PAWL	U003_S001	179
D6832747	PAD:SIDE FENCE:SMALL	U003_S001	180
D6832748	PAD:SIDE FENCE:LARGE	U003_S001	181
D6832752	LEVER:RISE:BASE	U003_S001	182
D6832755	SHAFT:RISE:BASE:SUB-ASS'Y	U003_S001	183
D6832781	ORIGINAL TABLE:BEHIND	U003_S001	184
D6832912	FEELER:PAPER SIZE SENSOR	U003_S001	185
D6832913	SHEET:SENSOR:SEPARATION	U003_S001	186
D6833111	ROLLER:SCANNING:ENTRANCE:D RIVE	U003_S001	187
D6833150	ROLLER:SCANNING:EXIT:DRIVE:A SS'Y	U003_S001_S010	188
D6833155	TIMING PULLEY:ROLLER:SCANNI NG:EXIT:DRIVE	U003_S001	189
D6833221	GUIDE:SCANNING:UPPER	U003_S001	190
D6833251	GROUND PLATE:ROLLER	U003_S001	191
D6833260	SHEET:SCANNING:EXIT:UPPER:A SS'Y	U003_S001	192
D6833311	BRACKET:GUIDE:SCANNING:UPP ER	U003_S001	193
D6833361	SPRING PLATE:GUIDE PLATE:SCA NNING	U003_S001	195
D6833411	GUIDE:SCANNING:ENTRANCE:LO WER:SUB-ASS'Y	U003_S001_S013	196
D6833421	BASE:SCANNING:ENTRANCE:LOW ER	U003_S001	197
D6833422	LEVER:PRESSURE RELEASE	U003_S001	198
D6833510	SHAFT:LEVER:MISFEED REMOVA L:ASS'Y	U003_S001	199
D6833616	BRACKET:DISCHARGE BRUSH	U003_S001_S011	200
D6833621	GUIDE:EXIT:LOWER:SUB-ASS'Y	U003_S001_S011	201
D6833643	COMPRESSION SPRING:CONTAC	U003_S001_S011	203

Exclusive Parts

Number	Part Name	Group	ID
	T IMAGE SENSOR:EXIT	S002	
D6833644	SHEET:GUIDE:CONTACT IMAGE S ENSOR:EXIT:LOWER	U003_S001_S011 S002	204
D6833645	ROLLER:MIDDLE:DRIVEN	U003_S001	205
		U003_S001_S011 S002	205
D6833646	GUIDE:CONTACT IMAGE SENSOR: EXIT:LOWER:ASS'Y	U003_S001_S011 S002	281
D6833651	COVER:SCANNING:EXIT	U003_S001_S011	206
D6833662	GUIDE PLATE:CONTACT IMAGE S ENSOR:ENTRANCE:ASS'Y	U003_S001_S011 S003	207
D6833666	LEVER:GUIDE PLATE:CONTACT I MAGE SENSOR:FRONT	U003_S001_S011 S003	208
D6833667	LEVER:GUIDE PLATE:CONTACT I MAGE SENSOR:REAR	U003_S001_S011 S003	209
D6833668	SPACER:GUIDE PLATE:CONTACT IMAGE SENSOR:ENTRANCE	U003_S001_S011 S003	210
D6833710	ROLLER:CONTACT IMAGE SENSO R:EXIT:DRIVE:PRESS FIT	U003_S001_S012	211
D6833714	TIMING PULLEY:ROLLER:CIS:EXIT :DRIVE	U003_S001	212
D6833715	TIMING PULLEY:ROLLER:CIS:EXIT :FRONT	U003_S001	213
D6833811	GUIDE PLATE:EXIT:UPPER	U003_S001_S009	214
D6833812	DISCHARGE BRUSH:EXIT	U003_S001_S009 U003_S001_S011 S003	215 215
D6833911	ROLLER:EXIT:DRIVE	U003_S001	216
D6833915	TIMING PULLEY:ROLLER:EXIT:DRI VE	U003_S001	217
D6834323	SHAFT:CONTACT POINT:GUIDE:P APER FEED	U003_S001	218
D6834325	BRACKET:GUIDE:PAPER FEED:FR ONT	U003_S001	219
D6834328	BRACKET:GUIDE:PAPER FEED:IN NER BACK	U003_S001	220
D6834341	BRACKET:PULL OUT:DRIVEN	U003_S001	221
D6834343	PRESSURE PLATE:PICKUP	U003_S001_S015	222

Number	Part Name	Group	ID
D6834344	COMPRESSION SPRING:PICKUP:2 .1N	U003_S001_S015	223
D6834345	DISCHARGE BRUSH:EXIT:L37	U003_S001	224
D6834350	DRIVEN ROLLER:PULL OUT	U003_S001	225
D6834351	LINK:STOPPER:COVER:PAPER FE ED	U003_S001_S015	226
D6834361	SHAFT:CONTACT POINT:GRIP	U003_S001_S015	227
D6834367	GROUND PLATE:HOOK:INNER BA CK	U003_S001_S015	228
D6834372	HOOK:CONTACT POINT:FRONT:G RIP	U003_S001_S015	229
D6834374	HOOK:CONTACT POINT:INNER BA CK:GRIP	U003_S001_S015	230
D6834414	SPACER:EXIT ROLLER	U003_S001	231
D6834421	SHAFT:EXIT:DRIVEN	U003_S001	232
D6834430	ROLLER:EXIT:DRIVEN	U003_S001	233
D6834441	HOLDER:CUSHION:PRESSURE PL ATE	U003_S001	234
D6834442	TAPE:PRESSURE PLATE	U003_S001 U003_S001_S011 U003_S001_S016	235 235 235
D6835111	GUIDE:HARNESS:MAIN	U003_S001	236
D6835121	GUIDE:HARNESS:SUB	U003_S001	237
D6835863	CONTACT IMAGE SENSOR:ASS'Y	U003_S001	238
D6842171	PAPER FEED BELT	U003_S001_S007	239
D6842412	PAD:STOPPER:ORIGINAL	U003_S001	240
D6844142	TIMING BELT:60S2M174	U017	74
D6902425	DISCHARGE BRUSH:SHORT:FRO NT	U003_S001_S009	241
D6952528	(CHN):DECAL:PAPER SET DIRECT ION:TANDEM TRAY:RIGHT	U006_S021	375
D6952529	(CHN):DECAL:PAPER SET DIRECT ION:TANDEM TRAY:LEFT	U006_S022	376
D7312202	SHAFT:SEPARATION:ASS'Y	U003_S001_S007	280
D7312239	COVER:PICKUP ROLLER	U003_S001_S007	243
D7312731	BASE:ORIGINAL TABLE	U003_S001	270
D7312734	COVER:LOWER:BASE	U003_S001	244
D7312746	SIDE FENCE:ORIGINAL TABLE	U003_S001	245

Exclusive Parts

Number	Part Name	Group	ID
D7312751	RAIL:SIDE FENCE	U003_S001	246
D7312771	ORIGINAL TABLE:FACE FRONT	U003_S001	247
D7313390	GUIDE PLATE:SCANNING:CONTA CT:0.6MM:PEEN	U003_S001	284
D7313511	HOOK:OPTICAL READING UNIT:FR ONT	U003_S001	248
D7314112	COVER:FRONT RIGHT	U003_S001	249
D7314113	COVER:FRONT	U003_S001	250
D7314211	COVER:REAR	U003_S001	251
D7314336	CUSHION:STOPPER:FEELER:ORI GINAL SENSOR	U003_S001_S015	252
D7314352	BRACKET:PRESSURE:PICKUP	U003_S001_S015	253
D7314370	COVER:PAPER FEED:ASS'Y	U003_S001_S015	254
D7314371	GRIP:COVER:PAPER FEED	U003_S001_S015	255
D7314412	TRAY:EXIT:AUXILIARY:LARGE	U003_S001	256
D7314413	TRAY:EXIT:AUXILIARY:SMALL	U003_S001	257
D7314418	TRAY:EXIT	U003_S001	258
D7314510	COVER:LOWER:ASS'Y	U003_S001_S016	259
D7314611	COVER:LEFT LOWER	U003_S001	260
D7315310	PCB:URTB:DOCUMENT FEEDER:A SS'Y	U007	164
D7315530	PCB:MAIN CONTROL BOARD:DOC UMENT FEEDER:ASS'Y	U003_S001	261
D7316011	DECAL:SIZE:ORIGINAL	U003_S001	262
D7316031	DECAL:SET:ORIGINAL TABLE	U003_S001	263
D7316041	DECAL:BASE:ORIGINAL	U003_S001	264
D7316051	DECAL:DESIGN SKETCH:MISFEED REMOVAL:P	U003_S001	265
D7316241	DECAL:STOPPER:SEPARATION U NIT	U003_S001	266
D7414595	DECAL:PAPER EXIT SUB-UNIT:MIS FEED REMOVAL	U001_S004	88
D7773126	TIMING PULLEY:DRIVE:T25S2M	U016	138
G0143291	SNAP RING - PICK UP	U010_S001	123
G0291980	DECAL - LD	U005_S001	12
		U018	68
G0342986	FLANGED HEXAGONAL HEAD BOL T - M4X8	U022	88

Number	Part Name	Group	ID
G0602296	BALL BEARING:8X16X5MM	U007	165
		U007_S009	165
		U007_S010	165
		U007_S011	165
		U007_S012	165
G0602652	BUSHING - M4	U003_S001	267
		U003_S001_S011 S002	267
G0703088	SPACER:DEVELOPMENT ROLLER	U007	166
G0801169	SCREW:M3	U011_S001_S001	58
G1335793	RAIL:RIGHT	U020	49
G1335794	RAIL:LEFT	U020	50
G1781138	SCREW WITH WASHER:M6X14	U022	80
G1781141	HOLDER:STAND:M20	U023	48
G1781282	GEAR:CHARGE:CLEANER:Z51	U009	114
G1781289	FLY WHEEL:DRUM	U018	70
G1781291	JOINT:TRANSPORT SCREW:NO.2	U018	71
G1781307	JOINT:DEVELOPMENT ROLLER:D RIVE	U018	72
G1781311	TERMINAL:CHARGE	U009	115
G1781313	SPRING:PLATE:RIGHT:CHARGE	U009	116
G1781316	SPRING:PLATE:LEFT:CHARGE	U009	117
G1781602	ARM:SAFETY SWITCH:UPPER:AS S'Y	U001	89
G1782502	CUSHION:CORONA WIRE	U009_S002	119
G1782507	CLEANER:GRID:ASS'Y	U009_S002	120
G1782510	CLEANER:CORONA WIRE:ASS'Y	U009_S002	121
G1782512	COVER:END BLOCK:FRONT	U009_S002	122
G1782516	END BLOCK:CHARGE CORONA:F RONT	U009_S002	123
G1782521	SLIDER:CLEANER:CHARGE CORO NA:ASS'Y	U009_S002	124
G1782522	RING:SLIDER	U009_S002	125
G1782570	SCREW SHAFT:CHARGE CORONA :ASS'Y	U009_S002_S002	126
G1782605	TENSION SPRING:CORONA WIRE	U009_S002	127
G1782971	LEVER:LOCK:TANDEM LCT	U006_S011	377
G1783330	GEAR:IDLER:DEVELOPMENT ROL	U009_S004	128

Exclusive Parts

Number	Part Name	Group	ID
	LER:ASS'Y		
G1783332	GEAR:DEVELOPMENT ROLLER	U009_S004	129
G1783356	GEAR:JOINT:DEVELOPMENT UNIT	U009_S004	130
G1783475	SPONGE:COUPLING:TONER SUPPLY:DEVELOPMENT UNIT	U009_S004	131
G1783593	TENSION SPRING:STOPPER	U016	139
G1783672	CAP:PIPE:DISCHARGE USED TONER	U009_S001	132
G1783685	HOLDER:SHAFT:CLEANING BLADE:REAR	U009_S001	133
G1783707	SHEET:COATING BAR:2	U009_S001_S002	134
G1783713	BUSHING:APPLY	U009_S001_S002	135
G1783734	GUIDE PLATE:ARM	U009_S001_S002	136
G1783781	GUIDE:COATING BAR	U009_S001_S002	137
G1783870	TIMING PULLEY:T30	U014	18
G1784018	CASE:COATING BAR:TRANSFER ROLLER	U012_S001	70
G1784808	BRACKET:PRESSURE:ROLLER	U017	75
G1784817	SPRING:PRESSURE:ROLLER:DUPLEX	U017	76
G1784818	SPRING:PULL OUT:LOCK:EXIT	U022	81
G1784822	SPRING:PRESSURE:0.8N:DIA0.65	U016	140
G1784828	STAY:LOCK:LEVER:LEFT LOWER	U016	141
G1784890	SPRING PLATE:DUPLEX:GUIDE:LOWER	U017	77
G1784895	SHEET:DUPLEX:SPRING PLATE	U017	78
G1784900	COVER:DC STEPPER MOTOR:MM56	U007 U016	167 142
G1784908	COIL SPRING:LEFT LOWER:LOCK	U016	143
G1784909	SCREW:TRANSPORT	U022	82
G1784912	PULLEY:S2M:30T	U006	378
G1784916	SCREW:ROUND POINT	U017	79
G1785145	SHEET:GBC:UPPER	U022	83
G1786621	COVER:RELEASE PLATE:BLADE	U011_S001	59
G1786767	COATING BAR:TRANSFER ROLLER	U012_S001	71
G1787453	ARM:ON-OFF:TRANSPORT ROLLER	U016	144

Number	Part Name	Group	ID
G1787515	CONNECTOR GUIDE PIN:CONNECTOR	U022	84
G1787618	PLATE:FIX:BAND	U017	80
G1787660	PRESSURE ROLLER:TRANSPORT ROLLER	U007	168
G1787664	SPACER	U007	169
G1787819	SEAL:CAP:COLLECTION BOTTLE	U013_S004	56
G1788350	WRENCH:HEXAGONAL BOLT	U023	49
G3631105	DETENT ROLLER SHAFT	U006_S013_S001 U006_S013_S002	379 379
G4042810	SPRING PLATE - 2ND MIRROR	U004_S004	63
G5701225	SENSOR SHIELDING PLATE	U004	64
GA000063	DECAL:DEVELOPMENT UNIT:DISPLAY	U009_S004	138
GA082010	BUSHING:DIA6:DIA10:9	U013	57
GW010007	PHOTO REFLECTION SENSOR:EXIT	U006 U007 U016 U017	380 170 145 81
GW010009	DENSITY SENSOR	U010_S001	124
GW020024	PHOTOINTERRUPTOR:LG2A24BL1:GF	U004 U006_S014 U006_S015 U006_S016 U006_S017 U006_S018 U006_S019 U006_S020 U006_S021 U006_S022 U007 U008 U009 U010_S001 U013 U015_S001 U015_S003 U015_S004	68 395 395 395 395 395 395 395 395 395 185 94 149 127 64 173 173 173

Exclusive Parts

Number	Part Name	Group	ID
		U016	154
GW230008	TONER END SENSOR	U008_S001	89
GX060019	STEPPER MOTOR:PM42L048RBG8	U008_S001	90
GX640024	FAN MOTOR - DC 3.12W	U020	51
		U021	106
GX640028	FAN MOTOR DC24V 1.92W	U007	171
		U021	107
H0602126	BUSHING - M6X7	U003_S001_S007	268
H0722216	COMPRESSION SPRING	U016	146
H5194238	SPACER:ROLLER:CONNECTING	U007	172
J0155505	DRAWER:CONNECTOR:USED DEV ELPER:PLUG	U009_S001_S002	139
J5033116	TIMING BELT:40S2M128	U016	147
M0261778	GUIDE:FFC	U004	65
M0261815	CLAMP:MIRROR:NO.1	U004_S002	66
M0447747	CAP:COVER:REAR	U001	90
M0771766	KNOB:VARIABLE RESISTOR	U002_S001	69
		U002_S002	69
		U002_S003	69
M0771767	KEYTOP:START	U002_S001	70
		U002_S002	70
		U002_S003	70
M0771768	KEYTOP:10KEY	U002_S001	71
		U002_S002	71
		U002_S003	71
M0771769	KEYTOP:RESET SWITCH	U002_S001	72
		U002_S002	72
		U002_S003	72
M0771800	TOUCH PANEL:10.4INCH	U002_S001	73
		U002_S002	73
		U002_S003	73
M0771861	TUBE TYPE LAMP:TAC:ASS'Y	U023_S002	50
M0774200	MECHANICAL ROLLER CLUTCH:R OLLER	U015_S002	161
M0774703	BRACKET:ADAPTER SECTION:GB C:PEEN	U022	85
M0774707	GUIDE PLATE:GBC:ASS'Y	U022	86
M0774821	TRANSPORT BELT:COOLING	U016	148

Number	Part Name	Group	ID
M0B11328	ANTISTATIC BRUSH:DRUM	U018	73
M0B13320	JIG:SHEET:DOCTOR BLADE	SPECIAL TOOLS	21
M0B14675	GATE PAWL:EXIT:REVERSE	U016	150
M0EB4670	RADIAL BALL BEARING:REGISTRA TION:DRIVEN:FRONT	U007	194
		U007	195
M0EB4671	RADIAL BALL BEARING:REGISTRA TION:DRIVEN:REAR	U007	195
M2055332	PCB:SDCB	U019	46
M2057311	DISC:GATE:REGISTRATION:HOME POSITION SENSOR	U007	176
VSSG9002	FLUOTRIBO MG GREASE : 100G	SPECIAL TOOLS	17
VSSM9000	DIGITAL MULTIMETER-FLUKE189/ FVF	SPECIAL TOOLS	18

Standard Parts



03125060N
SCREW - M2.5X6



03130040N
SCREW:M3X4



03130060N
SCREW - M3X6



03130080N
PAN HEAD SCREW:M3X8



03130120N
PAN HEAD SCREW:M3X12



03140060N
SCREW - M4X6



03140120N
SCREW - M4X12



03140180N
PAN HEAD SCREW:M4X18



03150100N
PAN HEAD SCREW:M5X10



03520040N
SCREW M2X4

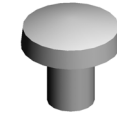

03530040N
SCREW - M3X4



03530060N
BIND SCREW - M3X6



03530080N
SCREW:M3X8



03530100N
SCREW-M3X10



03530120N
SCREW M3X12

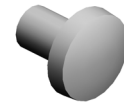

03540040N
SCREW-M4X4



03540050N
SCREW - M4X5

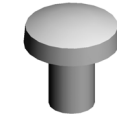

03540060N
SCREW-M4X6



03540080N
SCREW:M4X8

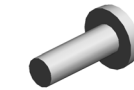

03540120N
SCREW M4X12

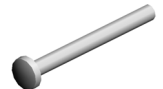

03540400N
SCREW:M4X40



03603005N
SCREW - M3X5



03603006N
SCREW - M3X6



03603008N
SCREW:M3X8



03603010N
SCREW:M3X10



03603020N
SCREW:M3X20

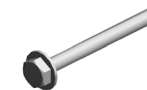

03603030N
SCREW:M3X30



03604006N
SCREW - M4X6

Standard Parts



03604008N
SCREW - M4X8



03604010N
SCREW:M4X10



03604012N
SCREW:M4X12



03604014N
SCREW - M4X14



04340060N
PAN SELF-TAPPING SCREW:
M4X6



04340200N
PAN SELF-TAPPING SCREW:
4X20

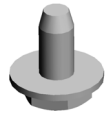

04503006N
TAPPING SCREW - M3X6



04503008N
TAPPING SCREW - M3X8



04503010N
TAPPING SCREW - M3X10



04503012N
TAPPING SCREW:3X12



04504008N
TAPPING SCREW - M4X8



04504010N
TAPPING SCREW:M4X10



04504012N
TAPPING SCREW:4X12



04504025N
TAPPING SCREW:4X25



04513006N
TAPPING SCREW - 3X6



04513008N
TAPPING SCREW - M3X8



04513010N
TAPPING SCREW:3X10

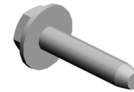

04513014N
TAPPING SCREW:3X14



04513020N
TAPPING SCREW:3X20

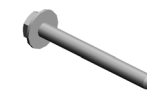

04513030N
TAPPING SCREW:3X30

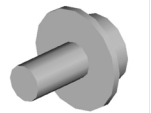

04514006N
TAPPING SCREW - 4X6



04514008N
TAPPING SCREW:4X8



04514010N
TAPPING SCREW:4X10



04514012N
TAPPING SCREW:4X12



04523006N
BINDING SELF-TAPPING SC
REW:3X6



04523008N
TAPPING SCREW - M3X8



04523010N
BINDING SELF-TAPPING SC
REW:3X10



04523010P
BINDING SELF-TAPPING SC
REW:3X10

Standard Parts



04524008N
TAPPING SCREW:M4X8



04524010N
BINDING SELF-TAPPING SCREW:4X10



04533006N
TAPPING SCREW - M3X6



04534006N
BINDING SELF TAPPING SCREW:4X6



04534008N
BINDING SELF TAPPING SCREW:4X8



04543005N
HEXAGON HEAD TAPPING SCREW:ROUND POINT:3X5

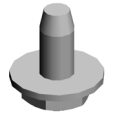

04543006N
TAPPING SCREW:ROUND POINT:3X6



04543006Q
TAPPING SCREW - M3X6



04543008Q
TAPPING SCREW:3X8



04543014Q
TAPPING SCREW:3X14



04543030Q
TAPPING SCREW:ROUND POINT:3X30

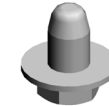

04544006Q
TAPPING SCREW:4X6



04544008Q
TAPPING SCREW - M4X8

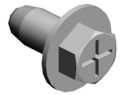

04544010N
TAPPING SCREW:ROUND POINT:4X10



04583008N
HEXAGON HEAD TAPPING SCREW:3X8

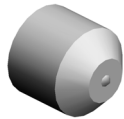

05730030E
HEXAGON HEADLESS SET SCREW - M3X3

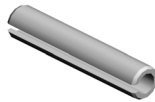

06230160E
SPRING PIN - 3X16MM

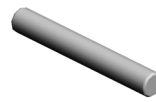

06320140G
PARALLEL PIN

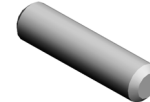

06330120G
PARALLEL PIN - 3X12

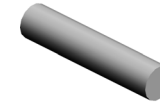

06330140G
PARALLEL PIN - 3X14

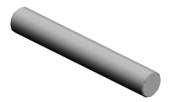

06330200G
PIN - M3X20



07010060N
WASHER DIA6



07030040N
SPRING WASHER:DIA4



07040050N
WASHER:DIA5



07050040N
WASHER:DIA4

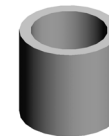

07074050N
BUSHING - 4X5



07080060N
WASHER:DIA6



07080080N
WASHER-DIA8

Standard Parts



07200020E
RETAINING RING - M2



07200025E
RETAINING RING - M2.5



07200030E
RETAINING RING - M3



07200040E
RETAINING RING - M4



07200060E
RETAINING RING - M6



07200080E
RETAINING RING - M8



07250200E
RETAINING RING C - M20



07250220E
RETAINING RING - M22



07250250E
RETAINING RING C - M25



07330608
PLAIN SHAFT BEARING: DIA6 X8



07330610
BUSHING: DIA6X10



07403012
BALL BEARING - 12X28X8

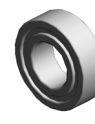

07403808
BALL BEARING - 8X16X5MM



07413506
BALL BEARING - 6X12X4 MM



07413706
BALL BEARING - 6X10X3



07413708
BALL BEARING - 8X12X3.5M M



07423808
BALL BEARING - 8X16X5



07433806
RADIAL BALL BEARING: DIA6 XDIA13X5

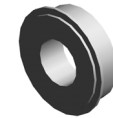

07433808
RADIAL BALL BEARING: DIA8 XDIA16X5



07922054C
SYNCHRONOUS BELT: 40S2 M108:CR



07922061C
SYNCHRONOUS BELT: 40S2 M122:CR



07922063C
SYNCHRONOUS BELT: 40S2 M126:CR



07922065C
SYNCHRONOUS BELT: 40S2 M130:CR



07922074C
SYNCHRONOUS BELT: 40S2 M148:CR



07922076C
SYNCHRONOUS BELT: 40S2 M152:CR



07922079C
SYNCHRONOUS BELT: 40S2 M158:CR



07922080C
SYNCHRONOUS BELT: 40S2 M160:CR



07922101C
SYNCHRONOUS BELT: 40S2 M202:CR

Standard Parts



07922129C
SYNCHRONOUS BELT:40S2
M258:CR



08010234
SCREW WITH WASHER:SMA
LL ROUND WITH SPRING WA
SHER:M5X8



08010237
HEXAGONAL BOLT:DOUBLE
SCREW:M4X12



08025220
TAPPING SCREW - M4X8



08025299
TAPPING SCREW - M3X8



08025312
TAPPING SCREW:WASHER:3
X10



08025330
PAN HEAD WITH COLLAR TA
PPING SCREW:PF:4X10

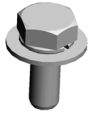

08046123
HEXAGONAL BOLT:W/WASH
ER:M3X8



08050072
CS RING



08050088
RETAINING RING - M6



08050089
RETAINING RING - M4



08050092
RETAINING RING - 3M



08050100
RETAINING RING - M2.5



08050103
RETAINING RINGS-E:SILENC
ER:DIA3



08050104
RETAINING RINGS-E:SILENC
ER:DIA4



08050106
RETAINING RINGS-E:SILENC
ER:DIA6



08053263
BEARING - 6X10X6MM



08053386
BUSHING - 8MM

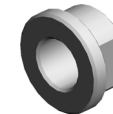

08053445
BEARING - M6X10X3



08053480
BUSHING - 6MM

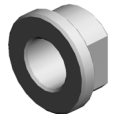

08053568
RADIAL BALL BEARING: DIA8
XDIA14X4

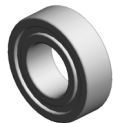

08053573
RADIAL BALL BEARING: DIA8
XDIA16X5



08053585
RADIAL BALL BEARING: DIA8
XDIA16X5

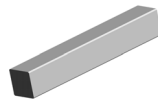

09300404A
PARALLEL KEY:4X4X25



09503006N
SCREW:SPRING WASHER:M
3X6



09513006N
SCREW - M3X6



09514006N
SCREW:POLISHED ROUND:
M4X6



09514008N
SCREW:POLISHED ROUND:
M4X8

Standard Parts



09514010N
SCREW:POLISHED ROUND:
M4X10



09514020N
SCREW - M4X20



09543006N
SCREW - M3X6



09543008N
SCREW - M3X8



09543010N
SCREW:POLISHED ROUND/
SPRING:M3X10



09543012N
SCREW - M3X12



09543025N
SCREW:POLISHED ROUND/
SPRING:M3X25



09544008N
SCREW - M4X8



09545010N
SCREW:POLISHED ROUND/
SPRING:M5X10



11050328
HARNESS CLAMP - ES-0505

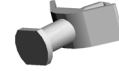

11050410
CARD SPACER - 9.4MM



11050487
HARNESS CLAMP

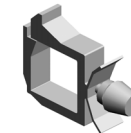

11050488
HARNESS CLAMP

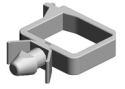

11050489
HARNESS CLAMP - LWS 131
6

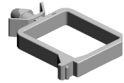

11050490
HARNESS CLAMP - IWS-2218



11050508
HARNESS CLAMP - LWS-071
1



11050511
HARNESS CLAMP - LWS-030
6ZC

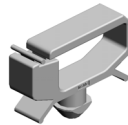

11050516
CLAMP

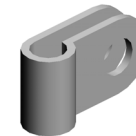

11050528
NYLON CLAMP - EMT-2N



11050529
NYLON CLAMP-EMT-3N



11050532
EDGE SADDLE - LES-25L



11050534
CLAMP



11050551
CLAMP:LES-0505



11050559
CLAMP:EMT-5N



11050568
CLAMP:LWSS-0504

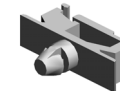

11050601
CLAMP:LWSM-0511-2M

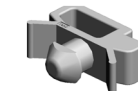

11050603
CLAMP:FFC-20



11050621
CLAMP - SB-2712

Standard Parts

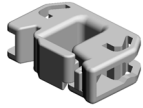

11050692
CLAMP:LES-0503



11050723
CLAMPS:WES-0507



11050724
CLAMPS:WES-1210



11050725
CLAMPS:WES-1117

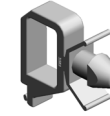

11050744
CLAMP:F-LWS-0711

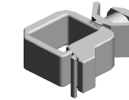

11050751
CLAMP:LWSM-0606-3.2M



11050758
CLAMP:LWSM-0306A

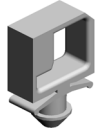

11050759
CLAMP:LWSM-0605A

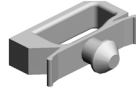

11050760
CLAMP:LWSM-0511A



11050761
CLAMP:LWS-0511A



11050764
CLAMP:LWS-1316A

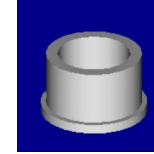

11060713
CABLE HOLDER

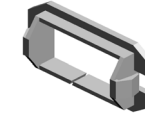

11060911
BUSHING:SB-1909



11071280
(D270/D271):FUSE:BJS1512F
2



11071281
(D272):FUSE:BJS2012F2

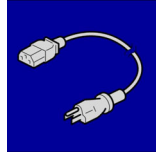

11500454
(EU,AA,TWN,KOR):POWER SUPPLY CODE:250V:16A

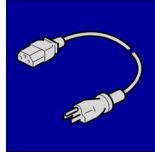

11500455
(NA):POWER SUPPLY CODE 250V:20A

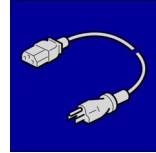

11500466
(CHN):POWER SUPPLY CODE:250V:16A

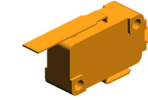

12042612
MICRO SWITCH:D3V-16506-3 C25



12042614
SWITCH AC250V/16A

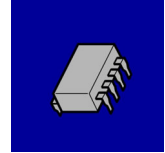

14077899
EEPROM:BR24T256-W



16072250
FERRITE CORE:K3 NF-72(N) BK0



16072256
FERRITE CORE:K3 NFR-08-A BK0



16072258
FERRITE CORE:K3 NFR-10BK0



16072586
FERRITE CORE:GRFC-3



16072595
FERRITE CORE:GRFC-13

PM Part List

Number	Part Name	Num	Group	ID
AB011125	GEAR:20/29Z	1	U012_S001	26
AB011126	GEAR:20Z	1	U012_S001	27
AE010130	HOT ROLLER:DIA54:ASS'Y	3	U015_S001	47
			U015_S003	47
			U015_S004	47
AE020220	PRESSURE ROLLER:DIA65	3	U015_S001	49
			U015_S003	49
			U015_S004	49
AE030049	BALL BEARING -20X32X7	6	U015_S001	52
			U015_S003	52
			U015_S004	52
AE045065	WEB:SUB-ASS'Y	1	U015_S002	58
AF030173	(EPDM):(For standard use):PAPER FEED ROLLER:PICKUP	3	U006_S014	419
			U006_S015	419
			U006_S016	419
AF031098	PAPER FEED ROLLER:FEED	3	U006_S014	399
			U006_S015	399
			U006_S016	399
AF032098	PAPER FEED ROLLER:SEPARATE	3	U006_S014	400
			U006_S015	400
			U006_S016	400
D0742459	JOINT:CLEANING UNIT	1	U009_S001_S002	35
D0746257	BRUSH ROLLER:APPLY:ASS'Y	1	U012_S001	39
D0746265	BLADE:TRANSFER ROLLER:ASS'Y	1	U012_S001	40
D0746312	GEAR:IDLER:TRANSFER ROLLER	1	U012_S001	46
D0746424	BLADE:CLEANING:BELT CLEANING:ASS'Y	1	U011_S001	16
D0746457	BLADE:APPLY:ASS'Y	1	U011_S001	29
D0BX2500	GRID:CHARGE CORONA	1	U009_S002	152
D0BX6051	ROLLER:INTERMEDIATE TRANSFER:ASS'Y	1	U010_S001	128
D0BX6250	TRANSFER ROLLER	1	U012_S001	80
D0BX6310	SEPARATION CORONA:ASS'Y	1	U012_S001_S002	84
D0BX6446	BRUSH:APPLY:BELT CLEANING	1	U011_S001	66

Number	Part Name	Num	Group	ID
	NG			
D0BX6450	COATING BAR:ASS'Y	1	U011_S001_S001	67
D0BX6909	FILTER:DUCT:MAIN:REAR	2	U021	120
D1792224	CORONA WIRE:CHARGE CORONA	3	U009_S002	46
D1793535	GEAR SET:CLEANING UNIT:SERVICE PARTS	1	U009_S001_S001	83
D1793536	GEAR:IDLER:Z16	1	U009_S001_S001	84
D1793537	GEAR:IDLER:Z17:LOWER	1	U009_S001_S001	85
D1793538	GEAR:TONER COLLECTION COIL:Z18	1	U009_S001_S001	86
D1793564	GEAR:IDLER:Z17:UPPER	1	U009_S001_S001	88
D1793581	BLADE:CLEANING:ASS'Y	1	U009_S001	91
D1793635	COATING BAR:ASS'Y	1	U009_S001_S002	96
D1793641	BRUSH ROLLER:APPLY:ASS'Y	1	U009_S001_S002	97
D1793645	GEAR:BRUSH ROLLER:Z15	1	U009_S001_S001	98
D1793653	BLADE:APPLY:ASS'Y	1	U009_S001_S002	100
D1794197	FLAT BELT-FUSING:DIA80:SEAL	3	U015_S001	122
			U015_S003	122
			U015_S004	122
D1796050	FLAT BELT-TRANSFER	1	U010	75
D1796311	GEAR:TRANSFER ROLLER	1	U012_S001	57
D1796889	FILTER:MAIN:EXHAUST:RIGHT	2	U021	48
D1799510	OPC Drum	1	U009	104
D1799640	DEVELOPER BLACK	1	U009	150
D2704343	ROLLER:PLATE	1	U015_S002	159
D2706078	PAPER TRANSFER BIAS ROLLER	1	U010_S001	118
D5412241	REVERSE ROLLER:PAPER FEED	1	U003_S001	103
D6832228	PICKUP ROLLER	1	U003_S001_S007	161
D6842171	PAPER FEED BELT	1	U003_S001_S007	239
G1782502	CUSHION:CORONA WIRE	6	U009_S002	119
G1782507	CLEANER:GRID:ASS'Y	1	U009_S002	120
G1782510	CLEANER:CORONA WIRE:ASS'Y	3	U009_S002	121

PM Part List

Number	Part Name	Num	Group	ID
G1786767	COATING BAR:TRANSFER R OLLER	1	U012_S001	71

Design Change List

Number	Title	Set	Old Part		New Part		Index No.		Q'ty	Interchg		Reason	Cut-in S/N
			P/N	Name	P/N	Name	Group	ID		Indiv.	Set		
202403-01	2403Modification	-	AA040033	TRANSPORT BELT	D0BX3833	TRANSPORT BELT	U014	24	2	O/O			
202402-01	2402Modification	-	D2703383	SEAL:CASE:TONE R BANK:REAR	D0BX3383	SEAL:CASE:TONE R BANK:REAR	U008	98	2	O/O			
202401-01	2401Modification	A	D2702440	INNER COVER:PCU:ASS'Y	D0BX2440	INNER COVER:PCU:ASS'Y	U009_S003	157	1	O/O			
202401-02	2401Modification	A			D2701399	DECAL:LASER MODE:ABS	U009	106	1				
202401-03	2401Modification	-	G1783799	SETTING POWDER	B1329700	LUBRICANT POWDER	SPECIAL TOOLS	5	1	O/O			
202312-01	2312 Modification	-	D1795922	BRACKET:POWER SUPPLY CORD: INLET:NOISE FILTER	D0EZ5922	BRACKET:P SUPPLY CORD: NOISE FILTER	U019	39	1	O/O			
202311-01	2311Modification	-	D1793414	SEAL:DEVELOPMENT ROLLER:SERVICE PARTS:ASS'Y			SPECIAL TOOLS	12	1				
202311-02	2311Modification	-	D0596646	INNER COVER: TANDEM LCT: LEFT	D0EZ6646	INNER COVER: TANDEM LCT: LEFT	U006_S018	421	1	O/O			
							U006_S020	421	1				
							U006_S022	421	1				
202310-01	2310Modification	-			11050760	CLAMP:LWSM-05 11A	U006	383	1				
					11050760	CLAMP:LWSM-05 11A	U006	383	1				
202310-02	2310Modification	-	11050516	CLAMP	11050760	CLAMP:LWSM-05 11A	U006	383	1	O/O			
			11050516	CLAMP	11050760	CLAMP:LWSM-05 11A	U006	383	1	O/O			
			11050516	CLAMP	11050760	CLAMP:LWSM-05	U006	383	1	O/O			

Design Change List

Number	Title	Set	Old Part		New Part		Index No.		Q'ty	Interchg		Reason	Cut-in S/N
			P/N	Name	P/N	Name	Group	ID		Indiv.	Set		
		-	11050516	CLAMP	11050760	CLAMP:LWSM-0511A	U006	383	1	O/O			
202310-03	2310Modification	-			D0746283	(Set part number: D1796280):SHIELD:GUIDE PLATE:ENTRANCE:LOWER	U012_S001	85	2			Set part number:D1796280	
202310-04	2310Modification	-	11050534	CLAMP	11050759	CLAMP:LWSM-0605A	U005_S001	13	7	O/O			
202310-05	2310Modification	-	11050489	HARNESS CLAMP - LWS 1316	11050764	CLAMP:LWS-1316A	U005_S001	14	1	O/O			
			11050489	HARNESS CLAMP - LWS 1316	11050764	CLAMP:LWS-1316A	U005_S001	14	1	O/O			
202306-01	2306Modification	-	D2704018	(CHN/EU,AA,TWN,KOR):FUSING UNIT:220V:ASS'Y	D2704418	(CHN/EU,AA,TWN,KOR):FUSING UNIT:220V:ASS'Y	U015_S003	174	1	O/O			
			D2704018	(CHN/EU,AA,TWN,KOR):FUSING UNIT:220V:ASS'Y	D2704418	(CHN/EU,AA,TWN,KOR):FUSING UNIT:220V:ASS'Y	U015_S004	174	1	O/O			
202302-01	2302Modification	-	D1941201	ADF:ASS'Y	D1941202	ADF:SINAI-B:ASS'Y	U003_S001	296	1	O/O			
202301-01	2301Mod1fication	-	AF030140	PAPER FEED ROLLER:PICKUP	AF030173	(EPDM):(For standard use):PAPER FEED ROLLER:PICKUP	U006_S014	419	1	O/O			
							U006_S015	419	1				
							U006_S016	419	1				
202301-02	2301Mod1fication	-	M0777429	BALL BEARING:REGISTRATION:DRIVEN:REAR	M0EB4671	RADIAL BALL BEARING:REGISTRATION:DRIVEN:REAR	U007	195	1	O/O			

Design Change List

Number	Title	Set	Old Part		New Part		Index No.		Q'ty	Interchg		Reason	Cut-in S/N
			P/N	Name	P/N	Name	Group	ID		Indiv.	Set		
202301-03	2301Mod1fication	-	M0777428	BALL BEARING:REGISTRATION:DRIVEN:FRONT	M0EB4670	RADIAL BALL BEARING:REGISTRATION:DRIVEN:FRONT	U007	194	1	O/O			
202301-04	2301Mod1fication	-	AA043328	TIMING BELT:40S2M130	07922065C	SYNCHRONOUS BELT:40S2M130:CR	U003_S001_S007	295	1	O/O			
202301-05	2301Mod1fication	-	D2706282	SWING UNIT:PICKUP ROLLER:ASS'Y	D0BX6282	SWING UNIT:PICKUP ROLLER:ASS'Y	U006_S016_S002	420	1	O/O			
			D2706282	SWING UNIT:PICKUP ROLLER:ASS'Y	D0BX6282	SWING UNIT:PICKUP ROLLER:ASS'Y	U006_S015_S002	420	1	O/O			
			D2706282	SWING UNIT:PICKUP ROLLER:ASS'Y	D0BX6282	SWING UNIT:PICKUP ROLLER:ASS'Y	U006_S014_S002	420	1	O/O			
202211-01	2211Mod1fication	-	AW020198	PHOTOINTERRUPTOR:LG2A14NL1	GW020024	PHOTOINTERRUPTOR:LG2A24BL1:GF	U004	68	1	O/O			
							U006_S014	395	1				
							U006_S015	395	1				
							U006_S016	395	1				
							U007	185	1				
202211-02	2211Mod1fication	-	D6831451	HOLDER:FEELE R:APS	D3FF1451	HOLDER:FEELE R:APS	U003_S001	294	1	O/O			
202211-03	2211Mod1fication	-	D3B04720	PRESSURE PLATE:ASS'Y	D3B04730	PRESSURE PLATE:ASS'Y	U003_S001_S014	293	1	O/O			
202210-01	2210Modification	-	AX400194	HEATER - 230V/9W	AX400275	HEATER:230V:9W	U010_S001	133	2	O/O			
202210-02	2210Modification	-	AA043685	SYNCHRONOUS BELT:40S2M258	07922129C	SYNCHRONOUS BELT:40S2M258:CR	U003_S001	292	1	O/O			

Design Change List

Number	Title	Set	Old Part		New Part		Index No.		Q'ty	Interchg		Reason	Cut-in S/N
			P/N	Name	P/N	Name	Group	ID		Indiv.	Set		
202206-01	2206Modification	-			D1791119	STAY:MAIN:RIGHT UPPER	U022	92	1				
202206-02	2206Modification	-	AF030072	PAPER FEED ROLLER:PICKUP	AF030140	PAPER FEED ROLLER:PICKUP	U006_S014		1	X/O			
							U006_S015		1				
							U006_S016		1				
202206-03	2206Modification	B			AF031140	(EPDM):PAPER FEED ROLLER:FEED	U006_S016	417	1			SET[B] D0592620, AF032140	
					AF031140	(EPDM):PAPER FEED ROLLER:FEED	U006_S015	417	1				
					AF031140	(EPDM):PAPER FEED ROLLER:FEED	U006_S014	417	1				
202206-04	2206Modification	B			AF032140	(EPDM):PAPER FEED ROLLER:SEPARATE	U006_S016	418	1			SET[B] D0592620, AF031140	
					AF032140	(EPDM):PAPER FEED ROLLER:SEPARATE	U006_S015	418	1				
					AF032140	(EPDM):PAPER FEED ROLLER:SEPARATE	U006_S014	418	1				
202112-01	2112 Modification	-	D1795324	HARNESS:PULL OUT:PAPER:FAN	D0BX5324	HARNESS:PULL OUT:PAPER:FAN	F9(2/4)		1	O/O			
202111-01	2111 Modification	-	D1796411	SEAL:TONER OUTLET SUB-UNIT	D0BX6411	SEAL:TONER OUTLET SUB-UNIT	U018_S007	75	1	O/O			
202111-02	2111 Modification	-	D0746450	COATING BAR:ASS'Y	D0BX6450	COATING BAR:ASS'Y	U011_S001_S001	67	1	X/O			
202110-01	2110 Modification	-	D1796310	SEPARATION CO	D0BX6310	SEPARATION CO	U012_S001	84	1	O/O			

Design Change List

Number	Title	Set	Old Part		New Part		Index No.		Q'ty	Interchg		Reason	Cut-in S/N
			P/N	Name	P/N	Name	Group	ID		Indiv.	Set		
		-		RONA:ASS'Y		RONA:ASS'Y	_S002						
202110-02	2110 Modification	-	D1796771	GUIDE PLATE:O PEN AND CLOSE :VERTICAL TRAN SPORT:LOWER: ASS'Y	D0BX6771	GUIDE PLATE:O PEN AND CLOSE :VERTICAL TRAN SPORT:LOWER: ASS'Y	U006_S013	415	1	O/O			
202110-03	2110 Modification	-	D0746446	BRUSH:APPLY:B ELT CLEANING	D0BX6446	BRUSH:APPLY:B ELT CLEANING	U011_S001	66	1	X/O			
202109-01	2109 Modification	-	D0BX6400	BELT CLEANING: ASS'Y	D0BX6401	BELT CLEANING: ASS'Y	U011_S001	64	1	X/O			
202109-02	2109 Modification	-	D0746455	COIL SPRING:CO ATING BAR	D0BX6455	COIL SPRING:CO ATING BAR	U011_S001 _S001	65	1	X/O			
202108-01	2108 Modification	-	AA043976	TIMING BELT:40 S2M142	AA043725	TIMING BELT:40 S2M142	U010_S001	132	1	O/O			
202108-02	2108 Modification	-	AA043627	TIMING BELT - B 40S2M148	07922074C	SYNCHRONOUS BELT:40S2M148: CR	U007	193	2	O/O			
202106-01	2106 Modification	-	B7003305	TIMING BELT:B4 0S2M152	07922076C	SYNCHRONOUS BELT:40S2M152: CR	U003_S001	291	1	O/O			
202105-01	2105 Modification	-	D2701508	COVER:MAIN:LE FT	D0BX1508	COVER:MAIN:LE FT	U001	103	1	O/O			
202105-02	2105 Modification	A	07200030E	RETAINING RING - M3	07200040E	RETAINING RING - M4	U013_S002	10	1	X/O			
202105-03	2105 Modification	A	B1202063	BUSHING - 4MM	07413506	BALL BEARING - 6X12X4 MM	U013	65	1	X/O			
202105-04	2105 Modification	A	D1796521	BRACKET:TONE R OUTLET SUB- UNIT:VERTICAL TRANSPORT:LO	D0BX6521	BRACKET:TONE R OUTLET SUB- UNIT:VERTICAL TRANSPORT:LO	U013	66	1	X/O			

Design Change List

Number	Title	Set	Old Part		New Part		Index No.		Q'ty	Interchg		Reason	Cut-in S/N
			P/N	Name	P/N	Name	Group	ID		Indiv.	Set		
				WER		WER							
202105-05	2105 Modification	A	D1796528	TONER OUTLET SUB-UNIT:VERTICAL TRANSPORT:MAIN:ASS'Y	D0BX6528	TONER OUTLET SUB-UNIT:VERTICAL TRANSPORT:MAIN:ASS'Y	U013_S002	67	1	X/O			
202105-06	2105 Modification	A	D1796552	TRANSPORT SCREW:TONER OUTLET SUB-UNIT:LOWER:ASS'Y	D0BX6552	TRANSPORT SCREW:TONER OUTLET SUB-UNIT:LOWER:ASS'Y	U013_S002	68	1	X/O			
202105-07	2105 Modification	-	AA043339	TIMING BELT:PA PER EXIT:40S2M122	07922061C	SYNCHRONOUS BELT:40S2M122:CR	U003_S001	286	1	O/O			
202105-08	2105 Modification	-	AA043632	TIMING BELT - 40S2M126	07922063C	SYNCHRONOUS BELT:40S2M126:CR	U003_S001	287	1	O/O			
202105-09	2105 Modification	-	AA043681	SYNCHRONOUS BELT:40S2M108	07922054C	SYNCHRONOUS BELT:40S2M108:CR	U003_S001	285	1	O/O			
202105-10	2105 Modification	-	AA043694	SYNCHRONOUS BELT:B40S2M202	07922101C	SYNCHRONOUS BELT:40S2M202:CR	U003_S001	290	1	O/O			
202105-11	2105 Modification	-	AA043710	SYNCHRONOUS BELT:40S2M158	07922079C	SYNCHRONOUS BELT:40S2M158:CR	U003_S001	288	1	O/O			
202105-12	2105 Modification	-	M3644131	TIMING BELT:B40S2M160	07922080C	SYNCHRONOUS BELT:40S2M160:CR	U003_S001	289	1	O/O			
202102-01	2102 Modification	-	D1793075	FILTER:DEVELOPMENT	D0BX3075	FILTER:DEVELOPMENT	U009_S004	156	1	O/O			
202102-02	2102 Modification	-	AA000291	DECAL:POSITIO	AA000290	DECAL:POSITIO	U006_S016	414	1	O/O			

Design Change List

Number	Title	Set	Old Part		New Part		Index No.		Q'ty	Interchg		Reason	Cut-in S/N
			P/N	Name	P/N	Name	Group	ID		Indiv.	Set		
		-		NING DISPLAY:S CREW:PP		NING DISPLAY:S CREW:PET							
			AA000291	DECAL:POSITIO NING DISPLAY:S CREW:PP	AA000290	DECAL:POSITIO NING DISPLAY:S CREW:PET	U006_S015	414	1	O/O			
			AA000291	DECAL:POSITIO NING DISPLAY:S CREW:PP	AA000290	DECAL:POSITIO NING DISPLAY:S CREW:PET	U006_S014	414	1	O/O			
			AA000291	DECAL:POSITIO NING DISPLAY:S CREW:PP	AA000290	DECAL:POSITIO NING DISPLAY:S CREW:PET	U012	83	1	O/O			
			AA000291	DECAL:POSITIO NING DISPLAY:S CREW:PP	AA000290	DECAL:POSITIO NING DISPLAY:S CREW:PET	U012	83	1	O/O			
202102-03	2102 Modification	-	D1791588	(NA):DECAL:CAU TION:PULL OUT: ENGLISH	D2701588	(NA):DECAL:CAU TION:PULL OUT: ENGLISH	U023	58	1	O/O			
			D1791588	(NA):DECAL:CAU TION:PULL OUT: ENGLISH	D2701588	(NA):DECAL:CAU TION:PULL OUT: ENGLISH	U023	58	1	O/O			
202102-04	2102 Modification	-	D1792965	SHAFT:GUIDE PL ATE:OPEN AND CLOSE	D2702965	SHAFT:GUIDE PL ATE:OPEN AND CLOSE	U007	192	1	O/O			
202102-05	2102 Modification	-	D2705389	HARNESS:FUSIN G UNIT:UPPER:1 7PIN	D0BX5389	HARNESS:FUSIN G UNIT:UPPER:1 7PIN:NA	G5(3/4)		1	X/X			
202012-01	2012 Modification	-	D1793336	SEAL:CASE:TON ER BANK:FRONT	D2703336	SEAL:CASE:TON ER BANK:FRONT	U008_S003	97	1	O/O			
							U008_S005	97	1				
202012-02	2012 Modification	-	D0BX6889	FILTER:MAIN:EX HAUST:RIGHT	D1796889	FILTER:MAIN:EX HAUST:RIGHT	U021	48	2	O/O			

Design Change List

Number	Title	Set	Old Part		New Part		Index No.		Q'ty	Interchg		Reason	Cut-in S/N
			P/N	Name	P/N	Name	Group	ID		Indiv.	Set		
202011-01	2011 Modification	-	D2701516	COVER:MAIN:REAR	D0BX1516	COVER:MAIN:REAR:PEEN	U001_S005	102	1	X/O			
202011-02	2011 Modification	-			D0BX1427	COVER:MAIN:REAR:SUB-ASS'Y	U001_S005	101	1				
202011-03	2011 Modification	-			D0A57797	SD-CARD:SP:BA TCH:TOOL:ASS'Y	SPECIAL TOOLS	20	1				
202011-04	2011 Modification	-	D1793420	JIG:SHEET:DOCTOR BLADE	M0B13320	JIG:SHEET:DOCTOR BLADE	SPECIAL TOOLS	21	1	O/O			
202010-01	2010 Modification	-	D1793342	BRACKET:CHUCK:TONER BANK	D0BX3342	BRACKET:CHUCK:TONER BANK:PEEN	U008	96	1	O/O			
			D1793342	BRACKET:CHUCK:TONER BANK	D0BX3342	BRACKET:CHUCK:TONER BANK:PEEN	U008	96	1	O/O			
202010-02	2010 Modification	-	G1784636	TIMING BELT:S2M134_67	AA043726	SYNCHRONOUS BELT:60S2M134	U014	23	1	O/O			
202009-01	2009 Modification	A	D0746144	BRACKET:INTERMEDIATE TRANSFER:FRONT	D0A56044	BRACKET:INTERMEDIATE TRANSFER:FRONT	U010_S001	130	1	X/O			
202009-02	2009 Modification	A	D0746145	BRACKET:INTERMEDIATE TRANSFER:REAR	D0A56045	BRACKET:INTERMEDIATE TRANSFER:REAR	U010_S001	131	1	X/O			
202006-01	2006 Modification	-	D6832233	BRACKET:PAPE R FEED BELT	D3FF2233	BRACKET:PAPE R FEED BELT	U003_S001_S007	282	1	X/O			
202006-02	2006 Modification	-	D6830360	GUIDE:EXIT:LOWER:ASS'Y	D6830361	GUIDE:EXIT:LOWER:ASS'Y	U003_S001_S011	283	1	X/O			
202006-03	2006 Modification	-	D6833350	GUIDE PLATE:SCANNING	D7313390	GUIDE PLATE:SCANNING:CONTACT:0.6MM:PEEN	U003_S001	284	1	X/O			

Design Change List

Number	Title	Set	Old Part		New Part		Index No.		Q'ty	Interchg		Reason	Cut-in S/N
			P/N	Name	P/N	Name	Group	ID		Indiv.	Set		
202006-04	2006 Modification	-	D0742685	SYNCHRONOUS BELT:B80S2M190	AA043727	SYNCHRONOUS BELT:80S2M190	U007	189	1	O/O			
202006-05	2006 Modification	-			D2702743	HOLDER:SHAFT:ARM	U007	190	1				
202006-06	2006 Modification	-			D2702744	BRACKET:HOLDER:SHAFT	U007	191	1				
202005-01	2005 Modification	-	D0742679	HOLDER:DC STEPPER MOTOR:SHIFT	D0BX2679	HOLDER:DC STEPPER MOTOR:SHIFT	U007	188	1	O/O			
202004-01	2004 Modification	-	M2057305	REGISTRATION ROLLER:GATE:ASS'Y	D2702602	REGISTRATION ROLLER:GATE:ASS'Y	U007_S013	187	1	X/O			
202004-02	2004 Modification	-	D6833641	GUIDE:CONTACT IMAGE SENSOR:EXIT:LOWER:ASS'Y	D6833646	GUIDE:CONTACT IMAGE SENSOR:EXIT:LOWER:ASS'Y	U003_S001_S011_S002	281	1	X/O			
202003-01	2003 Modification	-	AA043608	TIMING BELT:40S2M184	AA043731	TIMING BELT:40S2M184	U016	155	1	O/O			
202003-02	2003 Modification	-	AA043647	TIMING BELT:60S2M188	AA043737	TIMING BELT:60S2M188	U006	413	1	O/O			
202003-03	2003 Modification	-			D2704670	BRACKET:MAGNET CATCH:DUPLICATE	U017	86	2				
202003-04	2003 Modification	-	D7312200	SHAFT:SEPARATION:ASS'Y	D7312202	SHAFT:SEPARATION:ASS'Y	U003_S001_S007	280	1	O/O			
202003-05	2003 Modification	-	D1792816	SHAFT:TRAILING EDGE:SHIFT	D2702816	SHAFT:TRAILING EDGE:SHIFT	U007	186	1	O/O			
202002-01	2002 Modification	-	D1796786	GUIDE PLATE:VERTICAL TRANSP	D0BX6786	GUIDE PLATE:VERTICAL TRANSP	U006	412	1	X/O			

Design Change List

Number	Title	Set	Old Part		New Part		Index No.		Q'ty	Interchg		Reason	Cut-in S/N
			P/N	Name	P/N	Name	Group	ID		Indiv.	Set		
		-		ORT:F2		ORT:F2:PEEN							
202001-01	2001 Modification	-	D1793335	SEAL:CASE:TONE R BANK:LOWER	D2703335	SEAL:CASE:TONE R BANK:LOWER	U008_S003	95	1	O/O			
							U008_S005	95					
202001-02	2001 Modification	-	D1791585	DECAL:MISFEED REMOVAL:LOCATION	D2701584	DECAL:MISFEED REMOVAL:LOCATION	U001_S003	99	1	O/O			
202001-03	2001 Modification	-	D1791591	DECAL:MISFEED REMOVAL:ABC	D2701591	DECAL:MISFEED REMOVAL:ABC	U001_S003	100	1	O/O			
201911-01	1911 Modification	-	D2707556	(EU,AA,TWN,KOR): TANDEM LCT:LEFT:ASS'Y	D2707558	(EU,AA,TWN,KOR): TANDEM LCT:LEFT:ASS'Y	U006_S020	410	1	O/O			
201911-02	1911 Modification	-	D0BX7557	(NA):TANDEM LCT: LEFT:ASS'Y	D2707559	(NA):TANDEM LCT: LEFT:ASS'Y	U006_S018	411	1	O/O			
201911-03	1911 Modification	-			D3FF6071	DECAL:CAUTION: ORIGINAL:PICK-UP PAPER JAM	U003_S001 _S007	279	1				
201910-01	1910 Modification	-	AZ240309	POWER SUPPLY UNIT:ECO:456.4 W	AZ240355	POWER SUPPLY UNIT:ECO	U020_S002	56	1	X/O			
201910-02	1910 Modification	-	AZ240311	POWER SUPPLY UNIT:FW:446.4W	AZ240356	POWER SUPPLY UNIT:FW	U020	57	1	X/O			
201910-03	1910 Modification	-	D1945124	PCB:IDB	D1945126	PCB:IDB	U004	67	1	O/O			
201909-01	1909 Modification	-	D2706680	(EU,AA,TWN,KOR): TANDEM LCT:RIGHT:ASS'Y	D2706646	(EU,AA,TWN,KOR): TANDEM LCT:RIGHT:ASS'Y	U006_S019	408	1	X/O			
201909-02	1909 Modification	-	D0747389	DECAL:PAPER SET DIRECTION:TANDEM LCT:LEFT	D2707389	DECAL:PAPER SET DIRECTION:TANDEM LCT:LEFT	U006_S022	409	1	O/O			

Design Change List

Number	Title	Set	Old Part		New Part		Index No.		Q'ty	Interchg		Reason	Cut-in S/N
			P/N	Name	P/N	Name	Group	ID		Indiv.	Set		
		-	D0747389	DECAL:PAPER SET DIRECTION:TOP ANDEM LCT:LEFT	D2707389	DECAL:PAPER SET DIRECTION:TOP ANDEM LCT:LEFT	U006_S020	409	1	O/O			
			D0747389	DECAL:PAPER SET DIRECTION:TOP ANDEM LCT:LEFT	D2707389	DECAL:PAPER SET DIRECTION:TOP ANDEM LCT:LEFT	U006_S018	409	1	O/O			
201908-01	1908 Modification	-	D2702433	SERVICE PARTS :DEVELOPMENT UNIT:ASS'Y	D0BX2432	SERVICE PARTS :DEVELOPMENT UNIT:C3:ASS'Y	U009_S004	154	1	O/O			
201908-02	1908 Modification	A	D1792432	LED ARRAY:ASS'Y	D0BX2485	LED ARRAY:ASS'Y	U009_S004	155	1	X/X			
201908-03	1908 Modification	A	D1795328	HARNESS:DRAWER:PCU	D0BX5328	HARNESS:DRAWER:PCU	B4(1/4)		1	X/X			
201908-04	1908 Modification	-	D2705275		D2705272	HARNESS:MAIN:EDRB:FAN	C3(2/4)		1				
201907-01	1907 Modification	-			D1791316	JOINT:DRIVE:FUSING	U018_S008	74	1				
201907-02	1907 Modification	-			D0BX6225	SIDE PLATE:TRANSFER/SEPARATION UNIT:REAR:ASS'Y	U012_S001_S001	82	1				
201907-03	1907 Modification	-			D3FF2851	SENSOR COVER :PHOTOINTERRUPTOR	U003_S001	277	1				
201907-04	1907 Modification	-			D3FF2852	COVER:SENSOR	U003_S001	278	1				
201907-05	1907 Modification	-	AW140017	TEMPERATURE & HUMIDITY SENSOR	AW140027	TEMPERATURE & HUMIDITY SENSOR	U009	153	1	O/O			

Design Change List

Number	Title	Set	Old Part		New Part		Index No.		Q'ty	Interchg		Reason	Cut-in S/N
			P/N	Name	P/N	Name	Group	ID		Indiv.	Set		
201907-06	1907 Modification	-	D1796051	ROLLER:INTERMEDIATE TRANSFER:ASS'Y	D0BX6051	ROLLER:INTERMEDIATE TRANSFER:ASS'Y	U010_S001	128	1	O/O			
201907-07	1907 Modification	-	D1796400	BELT CLEANING:ASS'Y	D0BX6400	BELT CLEANING:ASS'Y	U011	63	1	O/O			
201907-08	1907 Modification	-	D2706001	TRANSFER UNIT:INTERMEDIATE TRANSFER:ASS'Y	D2706002	TRANSFER UNIT:INTERMEDIATE TRANSFER:ASS'Y	U010_S001	129	1	O/O			
201907-09	1907 Modification	-	D2706211	TRANSFER UNIT:ASS'Y	D0BX6210	TRANSFER UNIT:ASS'Y	U012_S001	81	1	O/O			
201907-10	1907 Modification	-	D1796889	FILTER:MAIN:EXHAUST:RIGHT	D0BX6889	FILTER:MAIN:EXHAUST:RIGHT	U021	119	2	O/O			
201907-11	1907 Modification	-	D1796909	FILTER:DUCT:MAIN:REAR	D0BX6909	FILTER:DUCT:MAIN:REAR	U021	120	2	O/O			
201907-12	1907 Modification	-	D1791219	SHAFT:LOCK:PULL OUT:LEFT	D2701219	SHAFT:LOCK:PULL OUT:LEFT	U022	91	1	O/O			
201907-13	1907 Modification	-	D0747595	(NA/EU,AA,TWN,KOR):BASE:TANDEM LCT:RIGHT:ADHESION	D0BX7595	(NA/EU,AA,TWN,KOR):BASE:TANDEM LCT:RIGHT:ADHESION	U006_S017	405	1	X/O			
			D0747595	(NA/EU,AA,TWN,KOR):BASE:TANDEM LCT:RIGHT:ADHESION	D0BX7595	(NA/EU,AA,TWN,KOR):BASE:TANDEM LCT:RIGHT:ADHESION	U006_S019	405	1	X/O			
201907-14	1907 Modification	-	D1947631	PAPER TRAY:UNIVERSAL:SUB-ASS'Y	D0BX7631	PAPER TRAY:UNIVERSAL:SUB-ASS'Y	U006_S001	406	1	X/O			
			D1947631	PAPER TRAY:UNIVERSAL:SUB-ASS'Y	D0BX7631	PAPER TRAY:UNIVERSAL:SUB-ASS'Y	U006_S002	406	1	X/O			

Design Change List

Number	Title	Set	Old Part		New Part		Index No.		Q'ty	Interchg		Reason	Cut-in S/N
			P/N	Name	P/N	Name	Group	ID		Indiv.	Set		
		-		S'Y		S'Y							
201907-15	1907 Modification	-	D2706685	(NA):TANDEM LC T:RIGHT:ASS'Y	D2706647	(NA):TANDEM LC T:RIGHT:ASS'Y	U006_S017	407	1	X/O			
201907-16	1907 Modification	-			G1783799	SETTING POWD ER							
201905-01	1905 Modification	-	D1796250	TRANSFER ROL LER	D0BX6250	TRANSFER ROL LER	U012_S001	80	1			EU:Int X/O AA_TWN_KOR_N A_CHN:Int O/O	
201904-01	1904 Modification	-	D0146780	TRAY BOTTOM P LATE:ASS'Y	D0BX6780	TRAY BOTTOM P LATE:ASS'Y	U006_S002 _S001	401	1	X/O			
			D0146780	TRAY BOTTOM P LATE:ASS'Y	D0BX6780	TRAY BOTTOM P LATE:ASS'Y	U006_S001 _S001	401	1	X/O			
201904-02	1904 Modification	-	D2707557	(NA):TANDEM LC T:LEFT:ASS'Y	D0BX7557	(NA):TANDEM LC T:LEFT:ASS'Y	U006	402	1	O/O			
201904-03	1904 Modification	-	D1792255	CHARGE CORO NA	D0BX2255	CHARGE CORO NA	U009_S002	151	1	O/O			
201904-04	1904 Modification	-	D0746420	BRUSH:REMOVE PAPER DUST:B ELT CLEANING	D0BX6420	BRUSH:REMOVE PAPER DUST:B ELT CLEANING	U011_S001	62	1	O/O			
201904-05	1904 Modification	-	AW020224	PHOTOINTERRU PTOR:GP1A173L CSVF	AW020234	PHOTOINTERRU PTOR:GP1A173L CS5F	U003_S001	276	9	O/O			
201904-06	1904 Modification	-	G1781268	ANTISTATIC BRU SH:DRUM	M0B11328	ANTISTATIC BRU SH:DRUM	U018	73	1	X/O			
201904-07	1904 Modification	-	11050758	CLAMP:LWSM-03 06A	11050511	HARNESS CLAM P - LWS-0306ZC	U004	11	1	X/O			
			11050758	CLAMP:LWSM-03 06A	11050511	HARNESS CLAM P - LWS-0306ZC	U004	11	1	X/O			
			11050758	CLAMP:LWSM-03 06A	11050511	HARNESS CLAM P - LWS-0306ZC	U004	11	1	X/O			

Design Change List

Number	Title	Set	Old Part		New Part		Index No.		Q'ty	Interchg		Reason	Cut-in S/N
			P/N	Name	P/N	Name	Group	ID		Indiv.	Set		
		-	11050758	CLAMP:LWSM-0306A	11050511	HARNESS CLAMP - LWS-0306ZC	U004	11	1	X/O			
			11050758	CLAMP:LWSM-0306A	11050511	HARNESS CLAMP - LWS-0306ZC	U004	11	1	X/O			
			11050758	CLAMP:LWSM-0306A	11050511	HARNESS CLAMP - LWS-0306ZC	U004	11	1	X/O			
			11050758	CLAMP:LWSM-0306A	11050511	HARNESS CLAMP - LWS-0306ZC	U004	11	1	X/O			
			11050758	CLAMP:LWSM-0306A	11050511	HARNESS CLAMP - LWS-0306ZC	U004	11	1	X/O			
			11050758	CLAMP:LWSM-0306A	11050511	HARNESS CLAMP - LWS-0306ZC	U004	11	1	X/O			
			11050758	CLAMP:LWSM-0306A	11050511	HARNESS CLAMP - LWS-0306ZC	U004	11	1	X/O			
			11050758	CLAMP:LWSM-0306A	11050511	HARNESS CLAMP - LWS-0306ZC	U004	11	1	X/O			
			11050758	CLAMP:LWSM-0306A	11050511	HARNESS CLAMP - LWS-0306ZC	U004	11	1	X/O			
			11050758	CLAMP:LWSM-0306A	11050511	HARNESS CLAMP - LWS-0306ZC	U004	11	1	X/O			
			11050758	CLAMP:LWSM-0306A	11050511	HARNESS CLAMP - LWS-0306ZC	U004	11	1	X/O			
			11050758	CLAMP:LWSM-0306A	11050511	HARNESS CLAMP - LWS-0306ZC	U004	11	1	X/O			
			11050758	CLAMP:LWSM-0306A	11050511	HARNESS CLAMP - LWS-0306ZC	U004	11	1	X/O			
			11050758	CLAMP:LWSM-0306A	11050511	HARNESS CLAMP - LWS-0306ZC	U004	11	1	X/O			

Design Change List

Number	Title	Set	Old Part		New Part		Index No.		Q'ty	Interchg		Reason	Cut-in S/N
			P/N	Name	P/N	Name	Group	ID		Indiv.	Set		
201904-08	1904 Modification	-	D1797649	DECAL:MULTI-LANGUAGE:MAIN:5	D2707649	DECAL:MULTI-LANGUAGE:MAIN:5	U023	57	1	O/O			
201904-09	1904 Modification	-			D1796619	STAY:HOLDER:PAPER TRAY:ASS'Y	U006	403	2				
201904-10	1904 Modification	-			D1796626	SUPPORTING PLATE:RIGHT:HOLDER:PAPER TRAY	U006	404	2				
201904-11	1904 Modification	-	G1782500	GRID:CHARGE CORONA	D0BX2500	GRID:CHARGE CORONA	U009_S002	152	1	O/O			
201903-01	1903 Modification	-	AF013005	BOTTOM PLATE PAD	AF013029	PAD:BASE	U006_S001_S001	396	1	X/O			
							U006_S002_S001	396	1				
201903-02	1903 Modification	-	A2946655	FRONT ROLLER - SLIDE RAIL	D0BX6677	ROLLER:SLIDE RAIL:FRONT	U006_S017	398	1	O/O			
							U006_S019	398	1				
							U006_S021	398	1				
201903-03	1903 Modification	-	D0590761	SPRING:TANDEM TRAY:LOCK	D0BX6648	COIL SPRING:TANDEM TRAY:LOCK	U006	397	1	O/O			
201903-04	1903 Modification	-			D0BX3862	SUPPORTING PLATE:VACUUM	U014	21	1				
201903-05	1903 Modification	-			D1793865	BRACKET:SENSOR:VACUUM	U014	22	1				
201903-06	1903 Modification	-	D1809640	Developer Black	D1799640	DEVELOPER BLACK	U009	150	1	O/O			
201902-01	1902 Modification	-	D0746716	HOLDER:HINGE:OPERATION SUB-UNIT:LOWER	D0BX1594	HOLDER:HINGE:OPERATION SUB-UNIT:LOWER	U002	74	1	O/O			

Design Change List

Number	Title	Set	Old Part		New Part		Index No.		Q'ty	Interchg		Reason	Cut-in S/N
			P/N	Name	P/N	Name	Group	ID		Indiv.	Set		
201902-02	1902 Modification	-	AW140016	TEMPERATURE & HUMIDITY SENSOR	AW140026	TEMPERATURE & HUMIDITY SENSOR	U013	63	1	O/O			
201902-03	1902 Modification	-	D6831350	HINGE:RIGHT:ASSY	D3B01350	HINGE:RIGHT:ASSY	U003_S001	274	1	X/O			
201902-04	1902 Modification	-	B6522215	GUIDE:PAPER FEED BELT:FRONT	D3FF2219	GUIDE:PAPER FEED BELT:FRONT	U003_S001_S007	275	1	O/O			
201902-05	1902 Modification	-	D1797574	SHAFT:ARM:UNLOCK	D2707574	SHAFT:ARM:UNLOCK	U006	394	1	O/O			
201902-06	1902 Modification	-			B0656589	LEFT SUPPORT PLATE	U006	393	2				
201902-07	1902 Modification	-	08050089	RETAINING RING - M4	08050104	RETAINING RING S-E:SILENCER:DI A4	U011_S001	61	1	O/O			
201902-08	1902 Modification	-	AW020198	PHOTOINTERRUPTOR:LG2A14NL1	GW020024	PHOTOINTERRUPTOR:LG2A24BL1:GF	U006_S017	395	9	O/O			
							U006_S018	395	2				
							U006_S019	395	9				
							U006_S020	395	2				
							U006_S021	395	9				
							U006_S022	395	2				
							U007	185	4				
							U008	94	4				
							U009	149	1				
							U010_S001	127	2				
							U013	64	3				
							U015_S001	173	3				
							U015_S003	173	3				
							U015_S004	173	3				
U016	154	2											

Design Change List

Number	Title	Set	Old Part		New Part		Index No.		Q'ty	Interchg		Reason	Cut-in S/N
			P/N	Name	P/N	Name	Group	ID		Indiv.	Set		
201901-01	1901 Modification	-	D2706210	TRANSFER UNIT :ASS'Y	D2706211	TRANSFER UNIT :ASS'Y	U012	79	1	O/O			
201901-02	1901 Modification	-	D3553828	HOLDER:STAY:GUIDE PLATE	D0BX6795	HOLDER:STAY:GUIDE PLATE	U006_S013	392	2	O/O			
201901-03	1901 Modification	-	D1794275	COVER:FUSING UNIT:UPPER:ASS'Y	D1794285	COVER:FUSING UNIT:UPPER:ASS'Y	U015_S001_S003	172	1	X/X			
			D1794275	COVER:FUSING UNIT:UPPER:ASS'Y	D1794285	COVER:FUSING UNIT:UPPER:ASS'Y	U015_S003	172	1	X/X			
			D1794275	COVER:FUSING UNIT:UPPER:ASS'Y	D1794285	COVER:FUSING UNIT:UPPER:ASS'Y	U015_S004_S003	172	1	X/X			
201812-01	1812 Modification	-	D2701518	COVER:EXHAUST:PAPER EXIT SUB-UNIT	D0BX1518	COVER:EXHAUST:PAPER EXIT SUB-UNIT	U023	56	1	O/O			
201812-02	1812 Modification	-	A2943451	LEVER HOLDER	D0BX3451	LEVER:TONER BOTTLE:PEEN	U008	93	1	O/O			
			A2943451	LEVER HOLDER	D0BX3451	LEVER:TONER BOTTLE:PEEN	U008	93	1	O/O			
201812-03	1812 Modification	-	D2704786	CUSHION:GUIDE PLATE:REVERSE:LOWER	D0BX4786	CUSHION:GUIDE PLATE:REVERSE:LOWER	U016	152	1	X/O			
201812-04	1812 Modification	-	AA161129	CUSHION - LARGE	AA161177	CUSHION:BASE:TANDEM LCT:LARGE	U006_S017	390	1	O/O			
							U006_S019	390	1				
							U006_S021	390	1				
201812-05	1812 Modification	-	AA161130	CUSHION - SMALL	AA161178	CUSHION:BASE:TANDEM LCT:SMALL	U006_S017	391	2	O/O			
							U006_S019	391	2				
							U006_S021	391	2				
201812-06	1812 Modification	-	D0746255	BRUSH ROLLER:	D0BX6255	BRUSH ROLLER:	U012_S001	78	1	X/X			

Design Change List

Number	Title	Set	Old Part		New Part		Index No.		Q'ty	Interchg		Reason	Cut-in S/N
			P/N	Name	P/N	Name	Group	ID		Indiv.	Set		
		-		TRANSFER ROLLER:ASS'Y		TRANSFER ROLLER:ASS'Y							
201812-07	1812 Modification	-	D2701550	INNER COVER:INTERMEDIATE TRANSFER:ASS'Y	D0BX1550	INNER COVER:INTERMEDIATE TRANSFER:ASS'Y	U001_S006	98	1	O/O			
201812-08	1812 Modification	-	D6831320	HINGE:LEFT:ASS'Y	D3B01320	HINGE:LEFT:ASS'Y	U003_S001	273	1	X/O			
201812-09	1812 Modification	-	D2704552	BRACKET:TIGHTENER:EXIT:ASS'Y	D2704547	BRACKET:TIGHTENER:EXIT:ASS'Y	U016	153	1	X/O			
			D2704552	BRACKET:TIGHTENER:EXIT:ASS'Y	D2704547	BRACKET:TIGHTENER:EXIT:ASS'Y	U016	153	1	X/O			
201812-10	1812 Modification	-			D2702627	SIDE PLATE:SHIFT:REGISTRATION:REAR:PEEN	U007	184	1				
201812-11	1812 Modification	-	D1795391	HARNESS:FUSING UNIT:SENSOR:CONNECTING	D0BX5391	HARNESS:FUSING UNIT:SENSOR:CONNECTING	G5(4/4)		1	X/X			
201811-01	1811 Modification	-			D2702644	STAY:SHIFT:REGISTRATION:ASS'Y	U007	183	1				
201811-02	1811 Modification	-	AE012044	HEAT ROLLER:DI A40	AE012048	HEAT ROLLER:DI A39.2	U015_S001	170	1	O/O			
			AE012044	HEAT ROLLER:DI A40	AE012048	HEAT ROLLER:DI A39.2	U015_S003	170	1	O/O			
			AE012044	HEAT ROLLER:DI A40	AE012048	HEAT ROLLER:DI A39.2	U015_S004	170	1	O/O			
201811-04	1811 Modification	-	D1792902	GUIDE PLATE:CONNECTING:UP	D0BX2902	GUIDE PLATE:CONNECTING:UP	U007	182	1	X/X			

Design Change List

Number	Title	Set	Old Part		New Part		Index No.		Q'ty	Interchg		Reason	Cut-in S/N
			P/N	Name	P/N	Name	Group	ID		Indiv.	Set		
		-		PER		PER:PEEN							
201811-05	1811 Modification	-	D2702427	SERVICE PARTS :DEVELOPMENT UNIT:ASS'Y	D2702433	SERVICE PARTS :DEVELOPMENT UNIT:ASS'Y	U009	148	1	O/O			
201811-06	1811 Modification	-	D2704017	(NA):FUSING UNI T:208V:ASS'Y	D2704417	(NA):FUSING UNI T:208V:ASS'Y	U015_S001	171	1	X/X			
201811-07	1811 Modification	A			D0BX1069	COVER:MOTOR: USED TONER	U022	89	1				
201811-08	1811 Modification	A			04544008Q	TAPPING SCRE W - M4X8	U022	11	1				
201811-09	1811 Modification	A			D1791118	SEPARATION PL ATE:MAIN:REAR MIDDLE	U022	90	1				
201810-01	1810 Modification	-	11050489	HARNESS CLAM P - LWS 1316	11050488	HARNESS CLAM P	U019	51	1	X/O			
			11050489	HARNESS CLAM P - LWS 1316	11050488	HARNESS CLAM P	U019	51	1	X/O			
			11050489	HARNESS CLAM P - LWS 1316	11050488	HARNESS CLAM P	U019	51	1	X/O			
201810-02	1810 Modification	-	D2706000	TRANSFER UNIT :INTERMEDIATE TRANSFER:ASS' Y	D2706001	TRANSFER UNIT :INTERMEDIATE TRANSFER:ASS' Y	U010	126	1	O/O			
201810-03	1810 Modification	-	D1792485	LED ARRAY:ASS' Y	D1792432	LED ARRAY:ASS' Y	U009_S004	147	1	O/O			
201810-04	1810 Modification	-			D2702624	SIDE PLATE:SHI FT:REGISTRATI ON:FRONT:PEEN	U007	181	1				
201810-05	1810 Modification	B	07330608	PLAIN SHAFT BE ARING:DIA6X8	07330610	BUSHING:DIA6X 10	U015_S001	168	1	X/X	X/O		

Design Change List

Number	Title	Set	Old Part		New Part		Index No.		Q'ty	Interchg		Reason	Cut-in S/N
			P/N	Name	P/N	Name	Group	ID		Indiv.	Set		
			07330608	PLAIN SHAFT BEARING:DIA6X8	07330610	BUSHING:DIA6X10	U015_S001	168	1	X/X			
			07330608	PLAIN SHAFT BEARING:DIA6X8	07330610	BUSHING:DIA6X10	U015_S003	168	1	X/X			
			07330608	PLAIN SHAFT BEARING:DIA6X8	07330610	BUSHING:DIA6X10	U015_S003	168	1	X/X			
			07330608	PLAIN SHAFT BEARING:DIA6X8	07330610	BUSHING:DIA6X10	U015_S004	168	1	X/X			
			07330608	PLAIN SHAFT BEARING:DIA6X8	07330610	BUSHING:DIA6X10	U015_S004	168	1	X/X			
201810-06	1810 Modification	B	D1794239	STRIPPER PLATE:ASS'Y	D2704239	STRIPPER PLATE:ASS'Y	U015_S001	169	1	X/X	X/O		
			D1794239	STRIPPER PLATE:ASS'Y	D2704239	STRIPPER PLATE:ASS'Y	U015_S003	169	1	X/X			
			D1794239	STRIPPER PLATE:ASS'Y	D2704239	STRIPPER PLATE:ASS'Y	U015_S004	169	1	X/X			
201809-01	1809 Modification	-	D2701488	SUPPORTING PLATE:DOOR:FRONT LEFT:ASS'Y	D0BX1488	SUPPORTING PLATE:DOOR:FRONT LEFT:ASS'Y	U001_S004	97	1	O/O			
201809-02	1809 Modification	-	11050490	HARNESS CLAMP - IWS-2218			U022	19	1				
			11050490	HARNESS CLAMP - IWS-2218			U022	19	1				
201809-03	1809 Modification	-	D1797544	SIDE FENCE:TANDEM LCT:LEFT REAR:ASS'Y	D2707544	SIDE FENCE:TANDEM LCT:LEFT REAR:ASS'Y	U006_S018_S002	389	1	O/O			
			D1797544	SIDE FENCE:TANDEM LCT:LEFT REAR:ASS'Y	D2707544	SIDE FENCE:TANDEM LCT:LEFT REAR:ASS'Y	U006_S020_S002	389	1	O/O			
			D1797544	SIDE FENCE:TANDEM LCT:LEFT REAR:ASS'Y	D2707544	SIDE FENCE:TANDEM LCT:LEFT REAR:ASS'Y	U006_S022	389	1	O/O			

Design Change List

Number	Title	Set	Old Part		New Part		Index No.		Q'ty	Interchg		Reason	Cut-in S/N
			P/N	Name	P/N	Name	Group	ID		Indiv.	Set		
		-		NDEM LCT:LEFT REAR:ASS'Y		NDEM LCT:LEFT REAR:ASS'Y	_S001						
201809-04	1809 Modification	-	D3B04712	SHEET:PRESSURE PLATE	D0A46099	SHEET:PRESSURE PLATE:SMALL	U003_S001_S014	272	1	O/O			
201809-05	1809 Modification	-	D1793310	SHAFT:DRIVE:T ONER BOTTLE: DIA6	D2703310	SHAFT:DRIVE:T ONER BOTTLE: DIA6	U008	92	2	O/O			
201808-01	1808 Modification	-	D1792906	GUIDE PLATE:CONNECTING:LOWER	D0BX2906	GUIDE PLATE:CONNECTING:LOWER:PEEN	U007	180	1	O/O			
201808-02	1808 Modification	-	D1797114	GUIDE PLATE:REVERSE:DUPLEX:DRIVE	D0BX7114	GUIDE PLATE:REVERSE:DUPLEX:DRIVE	U017	85	1	O/O			
201808-03	1808 Modification	-	D1791506	SUPPORTING PLATE:DOOR:FRONT RIGHT:ASS'Y	D0BX1506	SUPPORTING PLATE:DOOR:FRONT RIGHT:ASS'Y	U001_S003	96	1	O/O			
201808-04	1808 Modification	-	D2707545	(EU,AA,TWN,KOR):TANDEM LCT:LEFT:ASS'Y	D2707556	(EU,AA,TWN,KOR):TANDEM LCT:LEFT:ASS'Y	U006	387	1	O/O			
201808-05	1808 Modification	-	D2707546	(NA):TANDEM LCT:LEFT:ASS'Y	D2707557	(NA):TANDEM LCT:LEFT:ASS'Y	U006	388	1	O/O			
201808-06	1808 Modification	-			D1794055	SIDE PLATE:PRESSURE:FRONT:PEEN	U015_S001	167	1				
							U015_S003	167	1				
							U015_S004	167	1				
201808-07	1808 Modification	-	D2605100	SD-CARD:NICE:APPLICATION:ASS'Y			U019	48	1				
201807-01	1807 Modification	-			D2703079	SERVICE PARTS:DENSITY SENS	U009_S004	146	1				

Design Change List

Number	Title	Set	Old Part		New Part		Index No.		Q'ty	Interchg		Reason	Cut-in S/N
			P/N	Name	P/N	Name	Group	ID		Indiv.	Set		
		-				OR:DEVELOPME NT							
201807-02	1807 Modification	-	D1796989	SEAL:DUCT:HEA T PIPE:ENTRAN CE	D2706989	SEAL:DUCT:HEA T PIPE:ENTRAN CE	U021_S003	116	1	O/O			
201807-03	1807 Modification	-	07423808	BALL BEARING - 8X16X5	07433808	RADIAL BALL BE ARING:DIA8XDIA 16X5	U006	36	1	O/O			
			07423808	BALL BEARING - 8X16X5	07433808	RADIAL BALL BE ARING:DIA8XDIA 16X5	U006	36	1	O/O			
			07423808	BALL BEARING - 8X16X5	07433808	RADIAL BALL BE ARING:DIA8XDIA 16X5	U006	36	1	O/O			
			07423808	BALL BEARING - 8X16X5	07433808	RADIAL BALL BE ARING:DIA8XDIA 16X5	U006	36	1	O/O			
			07423808	BALL BEARING - 8X16X5	07433808	RADIAL BALL BE ARING:DIA8XDIA 16X5	U006	36	1	O/O			
			07423808	BALL BEARING - 8X16X5	07433808	RADIAL BALL BE ARING:DIA8XDIA 16X5	U006	36	1	O/O			
			07423808	BALL BEARING - 8X16X5	07433808	RADIAL BALL BE ARING:DIA8XDIA 16X5	U006_S014	36	1	O/O			
			07423808	BALL BEARING - 8X16X5	07433808	RADIAL BALL BE ARING:DIA8XDIA 16X5	U006_S014	36	1	O/O			
			07423808	BALL BEARING - 8X16X5	07433808	RADIAL BALL BE ARING:DIA8XDIA 16X5	U006_S015	36	1	O/O			

Design Change List

Number	Title	Set	Old Part		New Part		Index No.		Q'ty	Interchg		Reason	Cut-in S/N
			P/N	Name	P/N	Name	Group	ID		Indiv.	Set		
		-		8X16X5		ARING:DIA8XDIA 16X5							
			07423808	BALL BEARING - 8X16X5	07433808	RADIAL BALL BE ARING:DIA8XDIA 16X5	U006_S015	36	1	O/O			
			07423808	BALL BEARING - 8X16X5	07433808	RADIAL BALL BE ARING:DIA8XDIA 16X5	U006_S016	36	1	O/O			
			07423808	BALL BEARING - 8X16X5	07433808	RADIAL BALL BE ARING:DIA8XDIA 16X5	U006_S016	36	1	O/O			
201807-04	1807 Modification	-	08050089	RETAINING RING - M4	08050104	RETAINING RING S-E:SILENCER:DI A4	U012_S001	75	1	O/O			
			08050089	RETAINING RING - M4	08050104	RETAINING RING S-E:SILENCER:DI A4	U012_S001	75	1	O/O			
201807-05	1807 Modification	-	08050092	RETAINING RING - 3M	08050103	RETAINING RING S-E:SILENCER:DI A3	U012_S001	74	1	O/O			
201807-06	1807 Modification	-			D2701449	COVER:TONER SUPPLY:UPPER: ASS'Y	U001_S001	95	1	O/O		Old part number D2701450,Int o/o	
201807-07	1807 Modification	-	D2701450	COVER:TONER SUPPLY:UPPER			U001_S001	63	1	O/O		New part number D2701449,Int o/o	
201807-08	1807 Modification	-	D1797116	GUIDE PLATE:R EVERSE:DUPLE X:DRIVEN	D0BX7116	GUIDE PLATE:R EVERSE:DUPLE X:DRIVEN:PEEN	U017	83	1	O/O			
201807-09	1807 Modification	-	D1797118	GUIDE PLATE:R EVERSE:DUPLE	D0BX7118	GUIDE PLATE:R EVERSE:DUPLE	U017	84	1	O/O			

Design Change List

Number	Title	Set	Old Part		New Part		Index No.		Q'ty	Interchg		Reason	Cut-in S/N
			P/N	Name	P/N	Name	Group	ID		Indiv.	Set		
		-		X:LEFT		X:LEFT							
201807-10	1807 Modification	-	D2705713	(D270-NA(17),CH N,EU,AA,TWN,K OR):SERVICE PA RTS:PCB:CTL:AS S'Y	D2705716	(D270-NA(17),CH N,EU,AA,TWN,K OR):SERVICE PA RTS:PCB:CTL:AS S'Y	U020	55	1	O/O			
201807-11	1807 Modification	-	D1794277	DECAL:H-TEMP WARNING:FUSIN G	D2704277	DECAL:H-TEMP WARNING:FUSIN G	U015_S001 _S003	166	1	O/O			
			D1794277	DECAL:H-TEMP WARNING:FUSIN G	D2704277	DECAL:H-TEMP WARNING:FUSIN G	U015_S003 _S003	166	1	O/O			
			D1794277	DECAL:H-TEMP WARNING:FUSIN G	D2704277	DECAL:H-TEMP WARNING:FUSIN G	U015_S004 _S003	166	1	O/O			
201807-12	1807 Modification	-	D1796333	SHAFT:LEVER:P RESSURE:TRAN SFER ROLLER	D2706333	SHAFT:LEVER:P RESSURE:TRAN SFER ROLLER	U012	77	1	O/O			
201807-13	1807 Modification	A	AA082137	BUSHING:6X10X 6	08053445	BEARING - M6X1 0X3	U012_S001	76	1	X/O			
			AA082137	BUSHING:6X10X 6	08053445	BEARING - M6X1 0X3	U012_S001	76	1	X/O			
201807-14	1807 Modification	A			07200040E	RETAINING RING - M4	U012_S001	10	1				
					07200040E	RETAINING RING - M4	U012_S001	10	1				
					07200040E	RETAINING RING - M4	U012_S001	10	1				
201807-15	1807 Modification	A			11050568	CLAMP:LWSS-05 04	U014	20	1				

Design Change List

Number	Title	Set	Old Part		New Part		Index No.		Q'ty	Interchg		Reason	Cut-in S/N
			P/N	Name	P/N	Name	Group	ID		Indiv.	Set		
201806-01	1806 Modification	-	D2705401	PCB:BCU:ASS'Y	D2705451	PCB:BCU:ASS'Y	U020	52	1	X/O			
201806-02	1806 Modification	-	D2705714	(D271):SERVICE PARTS:PCB:CTL:ASS'Y	D2705717	(D271):SERVICE PARTS:PCB:CTL:ASS'Y	U020	53	1	O/O			
201806-03	1806 Modification	-	D2705715	(D272):SERVICE PARTS:PCB:CTL:ASS'Y	D2705718	(D272):SERVICE PARTS:PCB:CTL:ASS'Y	U020	54	1	O/O			
201806-04	1806 Modification	-	D1793383	SEAL:CASE:TONER BANK:REAR	D2703383	SEAL:CASE:TONER BANK:REAR	U008	91	2	O/O			
201806-05	1806 Modification	-	D1801761	(NA):DECAL:CAUTION CHART:INK JET:PAPER	D2701761	(NA):DECAL:CAUTION CHART:INK JET:PAPER	U023	55	1	O/O			
201805-01	1805 Modification	-	D1792856	GUIDE PLATE:CONNECTING:LARGE CAPACITY TRAY	D0BX2856	GUIDE PLATE:CONNECTING:LARGE CAPACITY TRAY:PEEN	U007	178	1	O/O			
201805-02	1805 Modification	-	AA143570	MISFEED REMOVAL SHAFT	D2706453	SHAFT:MISFEED REMOVAL	U006	385	2	O/O			
201805-03	1805 Modification	-	B2346541	FEED DRIVE SHAFT	D2706541	SHAFT:DRIVE:FEED:ASS'Y	U006_S008	386	1	O/O			
			B2346541	FEED DRIVE SHAFT	D2706541	SHAFT:DRIVE:FEED:ASS'Y	U006_S009	386	1	O/O			
			B2346541	FEED DRIVE SHAFT	D2706541	SHAFT:DRIVE:FEED:ASS'Y	U006_S010	386	1	O/O			
201805-04	1805 Modification	-	D1792771	ARM:REGISTRATION:TIMING:ASS'Y	D2702771	ARM:REGISTRATION:TIMING:ASS'Y	U007_S004	179	1	O/O			
201805-05	1805 Modification	-	D1794800	SHAFT:GATE PAWL:REVERSE	D2704800	SHAFT:GATE PAWL:REVERSE	U016	151	1	O/O			
201805-06	1805 Modification	-	D1796910	SEAL:DUCT:LAR	D2706909	SEAL:DUCT:LAR	U021	118	2	O/O			

Design Change List

Number	Title	Set	Old Part		New Part		Index No.		Q'ty	Interchg		Reason	Cut-in S/N
			P/N	Name	P/N	Name	Group	ID		Indiv.	Set		
		-		GE		GE	U021_S001	118	1				
201805-07	1805 Modification	-	D1797061	SHAFT:GATE PA WL:DUPLX:ENT RANCE	D2707061	SHAFT:GATE PA WL:DUPLX:ENT RANCE	U017	82	1	O/O			
201805-08	1805 Modification	-	D1806812	SEAL:DUCT:FAN: MM97	D2706818	SEAL:DUCT:FAN: MM97	U021	117	1	O/O			
							U021_S002	117	1				
201805-09	1805 Modification	-			D1792412	HOLDER:SLIDE RAIL:PCU:RIGHT	U009	145	1				
201804-01	1804 Modification	-	AW100138	THERMOPILE	AW100183	THERMOPILE	U015	165	3	O/O			
201804-02	1804 Modification	-	D7316022	DECAL:CAUTION :ORIGINAL:MANY LANGUAGES	D2706022	DECAL:CAUTION :ORIGINAL:MANY LANGUAGES	U023	54	1	O/O			
201804-03	1804 Modification	-	D1055899	HOLDER:TEMPE RATURE & HUMI DITY SENSOR	D1055898	HOLDER:TEMPE RATURE & HUMI DITY SENSOR	U013	62	1	X/O			
201804-04	1804 Modification	-			D1797267	CABLE:USB:LCD C	B4(4/4)		1				
201804-05	1804 Modification	-			D1797268	CABLE:USB:IF	B4(4/4)		1				
201803-01	1803 Modification	-	AA000313	DECAL:CAUTION :INSERT:PAPER FEED SUB-UNIT	D2707548	DECAL:CAUTION :INSERT:PAPER FEED SUB-UNIT	U006_S018 _S002	384	1	O/O			
			AA000313	DECAL:CAUTION :INSERT:PAPER FEED SUB-UNIT	D2707548	DECAL:CAUTION :INSERT:PAPER FEED SUB-UNIT	U006_S020 _S002	384	1	O/O			
			AA000313	DECAL:CAUTION :INSERT:PAPER FEED SUB-UNIT	D2707548	DECAL:CAUTION :INSERT:PAPER FEED SUB-UNIT	U006_S022 _S001	384	1	O/O			
201803-02	1803 Modification	-	D1792647	SHAFT:SHIFT	D2702647	SHAFT:SHIFT	U007	177	1	O/O			
201803-03	1803 Modification	-	D1796416	SEAL:HOLDER:C LEANING BLADE:	D2706416	SEAL:HOLDER:C LEANING BLADE:	U011_S001	60	2	O/O			

Design Change List

Number	Title	Set	Old Part		New Part		Index No.		Q'ty	Interchg		Reason	Cut-in S/N
			P/N	Name	P/N	Name	Group	ID		Indiv.	Set		
		-		BEHIND		BEHIND							
201803-04	1803 Modification	-	D1796989	SEAL:DUCT:HEAT PIPE:ENTRANCE	D2706989	SEAL:DUCT:HEAT PIPE:ENTRANCE	U021	116	1	O/O			
			D1796989	SEAL:DUCT:HEAT PIPE:ENTRANCE	D2706989	SEAL:DUCT:HEAT PIPE:ENTRANCE	U021	116	1	O/O			
201803-05	1803 Modification	-	D1797362	(NA):DECAL:FUNCTION:MULTI-LANGUAGE	D2707362	(NA):DECAL:FUNCTION:MULTI-LANGUAGE	U023	52	1	O/O			
201803-06	1803 Modification	-	D1797671	(NA):DECAL:CAUTION CHART:COPY:ORIGINAL	D2707671	(NA):DECAL:CAUTION CHART:COPY:ORIGINAL	U023	53	1	O/O			
201803-07	1803 Modification	-	D1806822	SEAL:DUCT:HEAT SHIELD:FUSING:A	D2706822	SEAL:DUCT:HEAT SHIELD:FUSING:A	U021	115	1	O/O			
201802-01	1802 Modification	-	D2702428	SERVICE PARTS:DEVELOPMENT UNIT:ASS'Y	D2702427	SERVICE PARTS:DEVELOPMENT UNIT:ASS'Y	U009	144	1	O/O			
201802-02	1802 Modification	-	D2706590	COLLECTION BOTTLE:ASS'Y	D2706570	COLLECTION BOTTLE:SERVICE PARTS:ASS'Y	U013_S004	61	1	O/O			
201802-03	1802 Modification	-	D0A54836	GATE PAWL:EXIT:REVERSE	M0B14675	GATE PAWL:EXIT:REVERSE	U016	150	1	O/O			
201801-01	1801 Modification	-			11071280	(D270/D271):FUSE:BJS1512F2	U019	49	1				
201801-02	1801 Modification	-			11071281	(D272):FUSE:BJS2012F2	U019	50	1				
201712-01	1712 Modification	-	D0744224	JOINT:KNOB:FUSING	D0A53995	JOINT:KNOB:FUSING	U015_S001	164	1	O/O			
							U015_S003	164	1				

Design Change List

Number	Title	Set	Old Part		New Part		Index No.		Q'ty	Interchg		Reason	Cut-in S/N
			P/N	Name	P/N	Name	Group	ID		Indiv.	Set		
		-					U015_S004	164	1				
201711-01	1711 Modification	-	D1793097	COVER:GEAR:DEVELOPMENT	D2703097	COVER:GEAR:DEVELOPMENT	U009_S004	143	1	X/O			
201709-01	1709 Modification	-	D2702429	DEVELOPMENT UNIT:ASS'Y	D2702428	SERVICE PARTS:DEVELOPMENT UNIT:ASS'Y	U009	142	1	O/O			
201709-02	1709 Modification	-	D2701543	INNER COVER:INTERMEDIATE TRANSFER:ASS'Y	D2701550	INNER COVER:INTERMEDIATE TRANSFER:ASS'Y	U001	94	1	X/O			
201708-01	1708 Modification	-			D2701191	DECAL:PICK-UP PAPER JAM:OPERATION PANEL:ENGLISH	U001	93	1				
201708-02	1708 Modification	-			D2701195	(CHN/EU,AA,TWN,KOR):DECAL:PICK-UP PAPER JAM:OPERATION PANEL:MANY LANGUAGES	U023	51	1				
					D2701195	(CHN/EU,AA,TWN,KOR):DECAL:PICK-UP PAPER JAM:OPERATION PANEL:MANY LANGUAGES	U023	51	1				
201708-03	1708 Modification	-	D2706348	BRACKET:SHAFT:CONTACT POINT:TRANSFER ROLLER	D2706350	BRACKET:SHAFT:CONTACT POINT:TRANSFER ROLLER	U012	73	1	X/O			
201708-04	1708 Modification	A			D1055899	HOLDER:TEMPE	U013	60	1				

Design Change List

Number	Title	Set	Old Part		New Part		Index No.		Q'ty	Interchg		Reason	Cut-in S/N
			P/N	Name	P/N	Name	Group	ID		Indiv.	Set		
						RATURE & HUMIDITY SENSOR							
201708-05	1708 Modification	A			04583008N	HEXAGON HEAD TAPPING SCREW:3X8	U013	58	1				
201708-06	1708 Modification	A			11050511	HARNESS CLAMP - LWS-0306ZC	U013	59	1				
201708-07	1708 Modification	-			11050760	CLAMP:LWSM-0511A	U003_S001	271	1				
							U006	383	6				
							U006_S017	383	1				
							U006_S019	383	1				
							U006_S021	383	1				
201707-01	1707 Modification	-	AW140016	TEMPERATURE & HUMIDITY SENSOR	AW140017	TEMPERATURE & HUMIDITY SENSOR	U009	141	1	X/O			
201707-02	1707 Modification	-	D2705215	HARNESS:MAIN:RIGHT SIDEWAYS	D2705216	HARNESS:MAIN:RIGHT SIDEWAYS	F8(4/4)		1	X/O			
201707-03	1707 Modification	-			D2706628	PAPER FEED UNIT:PAPER BANK:ASS'Y	U006_S014	382	1				
							U006_S015	382	1				
							U006_S016	382	1				
201706-01	1706 Modification	-			AA082115	PLAIN SHAFT BEARING:5X10X5	U015_S001	163	1				
							U015_S003	163	1				
							U015_S004	163	1				
201705-01	1705 Modification	-	D1794768	GATE PAWL:SWITCHBACK	D2704768	GATE PAWL:SWITCHBACK	U016	83	1	X/O			
201704-01	1704 Modification	-	D2701572	DECAL:B2	D2701573	DECAL:B2	U001	82	1	X/O			
201704-02	1704 Modification	-	D2704743	STOPPER:GUIDE PLATE:EXIT:UPPER:SUB-ASS'Y	D2704750	STOPPER:GUIDE PLATE:EXIT:UPPER:SUB-ASS'Y	U016_S011	129	1	X/O			

Design Change List

Number	Title	Set	Old Part		New Part		Index No.		Q'ty	Interchg		Reason	Cut-in S/N
			P/N	Name	P/N	Name	Group	ID		Indiv.	Set		
201704-03	1704 Modification	-	04514008N	TAPPING SCREW:4X8			U022	8	1				
			04514008N	TAPPING SCREW:4X8			U022	8	1				
201704-04	1704 Modification	-			D0745101	SD-CARD:NICE:REGI2:ASS'Y	U019	47	1				
201704-05	1704 Modification	-			D0146627	BRACKET:ON OFF DETECTOR:REAR	U006_S017	381	1				
							U006_S019	381	1				
							U006_S021	381	1				
201704-06	1704 Modification	-			D1792467	LEVER:POSITIONING:CLEANING	U009_S004	140	1				
201704-07	1704 Modification	-			D7312731	BASE:ORIGINAL TABLE	U003_S001	270	1				
201704-08	1704 Modification	-			D2706348	BRACKET:SHAFT:CONTACT POINT:TRANSFER ROLLER	U012	72	1				
201704-09	1704 Modification	-	D1792986	BRACKET:GUIDE PLATE:CONNECTION:LARGE CAPACITY TRAY	D2702986	BRACKET:GUIDE PLATE:CONNECTION:LARGE CAPACITY TRAY	U007	147	1	O/O			
201704-10	1704 Modification	A			04534008N	BINDING SELF TAPPING SCREW:4X8	U022	87	1				
201704-11	1704 Modification	A			G0342986	FLANGED HEXAGONAL HEAD BOLT - M4X8	U022	88	1				
201704-12	1704 Modification	A	04513006N	TAPPING SCREW - 3X6	03603006N	SCREW - M3X6	U021	108	1	X/O			
			04513006N	TAPPING SCREW	03603006N	SCREW - M3X6	U021	108	1	X/O			

Design Change List

Number	Title	Set	Old Part		New Part		Index No.		Q'ty	Interchg		Reason	Cut-in S/N
			P/N	Name	P/N	Name	Group	ID		Indiv.	Set		
				W - 3X6									
201704-13	1704 Modification	A	04513030N	TAPPING SCREW:3X30	04543030Q	TAPPING SCREW:ROUND POINT:3X30	U021	109	6	X/O			
201704-14	1704 Modification	-			D2709901	GEAR:FUSING UNIT:ASS'Y	U015_S001	162	1				
							U015_S003	162	1				
							U015_S004	162	1				
201704-15	1704 Modification	A	D1796942	BRACKET:FAN:SIDE	D2706942	BRACKET:FAN:SIDE:RIGHT:SUB-ASS'Y	U021_S004	110	1	X/O			
			D1796999	FILTER:SPONGE:SIDE:VACUUM									
201704-16	1704 Modification	A			03603006N	SCREW - M3X6	U021	108	1				
					03603006N	SCREW - M3X6	U021	108	1				
					03603006N	SCREW - M3X6	U021	108	1				
					03603006N	SCREW - M3X6	U021	108	1				
					03603006N	SCREW - M3X6	U021	108	1				
201704-17	1704 Modification	A			D2706944	BRACKET:GUIDE:BASE	U021	111	1				
201704-18	1704 Modification	A			D2706945	FILTER:VACUUM:MAIN:RIGHT	U021	112	1				
201704-19	1704 Modification	-			D2706947	BRACKET:AUXILIARY:BASE	U021	113	1				
201704-20	1704 Modification	A			D2706948	SHEET:SCREW:FILTER	U021	114	1				
					D2706948	SHEET:SCREW:FILTER	U001	91	1				
201704-21	1704 Modification	A			D2706949	SHEET:COVER:MAIN:RIGHT	U001	92	1				
201704-22	1704 Modification	-	M0771870	HARNESS:TUBE TYPE LAMP:JOIN			A3(4/4)		0				

Design Change List

Number	Title	Set	Old Part		New Part		Index No.		Q'ty	Interchg		Reason	Cut-in S/N
			P/N	Name	P/N	Name	Group	ID		Indiv.	Set		
		-		T									
201612-01	1612 Modification	-			D2706170	DRUM STAY:INTERMEDIATE TRANSFER:SUB-ASSY	U010_S002	125	1				

