

# User Manual

## High Voltage Stacked Lithium Battery Energy Storage System

Model: EITAI TG-HB-5K (10.2V 50AH)

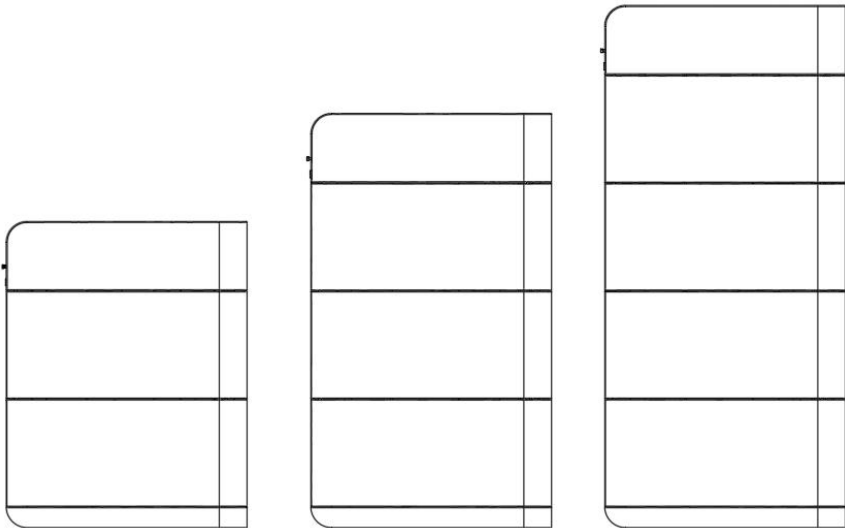

# Table of Contents

1. Introduction .....	3
2. Important Safety Warning .....	4
2.1 Before Connecting .....	4
2.2 During operation .....	6
3. Unpacking & Overview .....	6
3.1 Packing List .....	6
3.2 Product Overview .....	8
4. Installation .....	9
4.1 Selecting Mounting Location .....	11
4.2 Mounting The PACKuction .....	11-15
Appendix I: Troubleshooting.....	15
Appendix II: Emergency process.....	16-19

## 1. Introduction

The Energy storage pack is an essential component of the photovoltaic power generation system. It can provide electricity for the connected load, and it can also store photovoltaic solar modules, fuel generators, or wind energy generators by charging the remaining energy in case of emergency. When the sun goes down, energy demand is high, or there is a power outage, you can use the energy stored in the system to meet your energy needs at no additional cost. In addition, the energy storage Pack can help you achieve energy self-consumption and ultimately achieve the goal of energy independence.

According to different power conditions, the energy storage PACK can output power during peak power consumption, and can also store energy during low power consumption. Therefore, when connecting the matching photovoltaic modules or inverter arrays, external equipment is required to match the energy storage the working parameters of the pack to achieve the highest operating efficiency. For a simple diagram of a typical energy storage system.

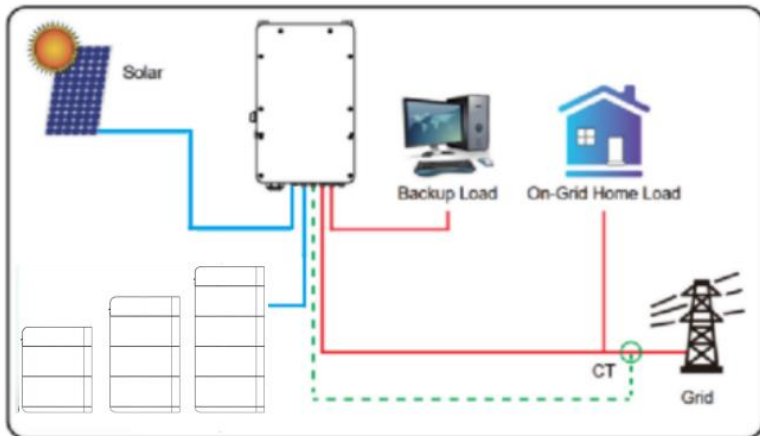

Figure 1 Energy storage System Overview

It is very important and necessary to read the user manual carefully before installing or using the battery. Failure to follow any of the instructions or warnings in this document can result in electrical shock, serious injury, death, or may damage the battery and the whole system.

- If the battery is stored for a long time, it is requirement that they are charged every three to six months, and the SOC should be no less than 80%,after fully discharging,The battery needs to be recharged within 12 hours.
- Do not expose cable outside;Do not use cleaning solvents to clean the battery.
- All battery terminals must be disconnected before maintenance.









## 2. Important Safety Warning

- Do not expose the battery to flammable or harsh chemicals or vapors.
- Do not paint any part of the battery, include any internal or external components.
- Do not connect battery with PV solar wiring directly.
- Any object is prohibited to be inserted into any part of the battery.
- Our company will not bear any warranty claims for direct or indirect damage caused by violation of the above items.

### 2.1 Before Connecting

- After unpacking, please check the battery and pack list first, if the battery is damaged or spare parts are missing, Please contact the dealer.
- Before installation, be sure to cut off the grid power and make sure the battery is in the turned-off mode;
- Wiring must be correct, do not mix-connect the positive and negative cables, and ensure no short circuit with the external device;
- It is prohibited to connect the battery with AC power directly;
- The BMS in the battery is designed for over 100VDC system, DO NOT connect battery in series;  
It is prohibited to connect the battery with different type of battery;
- Please ensure the electrical parameters of battery system are compatible to inverter;
- Keep the battery away from fire or water.

## Necessary installation Tools

 <p>Multimeter + Current clamp</p>	 <p>Screw Driver Set</p>	 <p>Allen Key Set</p>	 <p>Drill + Hammer</p>
 <p>Electrician Scissors</p>	 <p>Wrench set</p>	 <p>Lifting strap + mechanical lifter</p>	 <p>RS 232/USB+screw terminal (insulated)</p>

## Personal protective equipment.

			
<p>Insulated gloves</p>	<p>Safety goggles</p>	<p>Safety shoes</p>	<p>Helmet</p>

## 2.2 During operation

- If the battery system needs to be moved or repaired, the power must be cut off first and the battery is completely shutdown;
- It is prohibited to connect the battery with different type of battery;
- It is prohibited to put the batteries working with faulty or incompatible inverter;
- In case of fire, only dry powder fire extinguisher can be used, liquid fire extinguishers are prohibited;











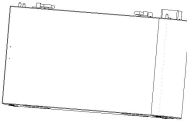

- Please do not open, repair or disassemble the battery. We do not undertake any consequences or related responsibility due to violation of safety operation or violating of design, production and equipment safety standards.

### 3 . Unpacking & Overview

#### 3-1. Packing List

You will receive the following parts(Not a full set),sample as follow picture.For customized requirements, please place an order with the manufacturer.

Battery pack	Combiner box	Power out positive cable*1
		
base*1	Manual *1	Power out Negative cable*1
		

Inverter communication line	*Communication box adapter cable (Optional)	*RS232 communication box (Optional)
		
M8 Explosion Screw		
		

### 3-2. Product Overview

battery module

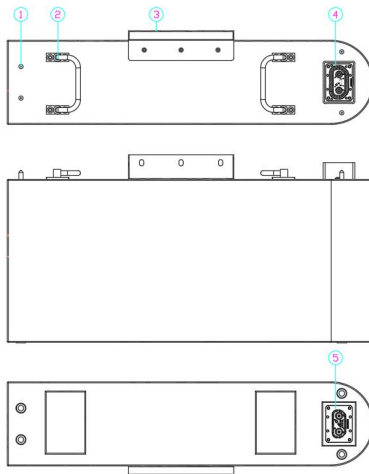

No.	Description	Silk-screen	Remark
1	dowel pin		
2	handle		
3	hanger		
4	Pack Output terminal		
5	Pack Output terminal		

main control box

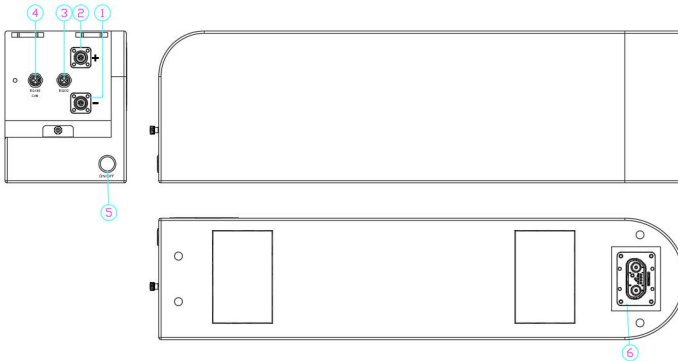

No.	Description	Silk-screen	Remark
1	Pack input terminal	P-	1
2	Pack input terminal	P+	2
3	External communication	CAN/RS485	3
4	Communication port	RS232	4
5	start switch	ON/OFF	5



There is any change in the pin position of the communication line, the customer shall be notified in writing or provided with supporting communication wire.

	脚位	RS485B并机通信	RS485A通信	CAN通信	RS232通信
	①	RS485B-B	RS485A-B		
	②	RS485B-A	RS485A-A		
	③				COM/GND
	④			CAN-H	RX
	⑤			CAN-L	TX

## 4.Installation

### 4-1. Selecting Mounting Location

Consider the following points to install the energy storage system:

- The energy storage system needs to be installed on a solid surface;
- It is recommended to place the energy storage system horizontally.
- To ensure air circulation and heat dissipation, please leave a gap about 200mm away from the side of the device.
- The ambient temperature should be between 0°C and 40°C, and the relative humidity should be between 25% and 85% to ensure optimal operation.
- Install the battery module in a dry, protected, dust-free area with sufficient air circulation. Do not operate in locations where the temperature and humidity are outside the specified range.

## 4-2. Mounting The PACK



**WARNING!!** Remember that this Pack is heavy so please be careful when removing it from the package, or install it .

When installing each pack, use appropriate screws to fix it. After that, fix the equipment with bolts.

**Step 1:** When receiving the product, first check whether all parts are complete, if not, please report to the Dealer .

**Step 2:** Remove the base and battery pack from the box. Lay the battery pack flat, and fix the base to the bottom of the battery with M12 screws. After the base is installed, insert the accessories and fix them with screws. (Note: The battery pack with the fixed base is different from other modules, there is no connector at the bottom) As shown in the figure:

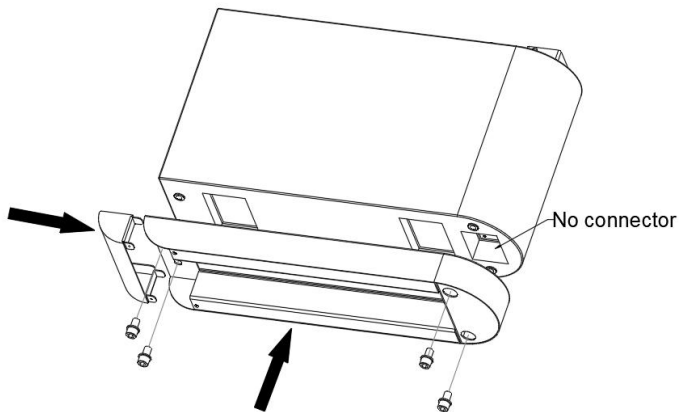

**Step 3:**Place the battery pack with the base against the wall, and the wall must be perpendicular to the ground at 90°. (Note: the wall must be a load-bearing wall, otherwise the battery pack cannot be installed on this wall) Fix the hanger on the battery holder. Once installed, secure the position to the wall through the holes in the hanger. Remove the battery pack, drill a  $\text{Ø}8\text{mm}$  depth 60mm hole in the wall with a hammer drill, then screw the M8 blasting screw into the wall. Move the battery pack to a suitable position and lock it with the nut.

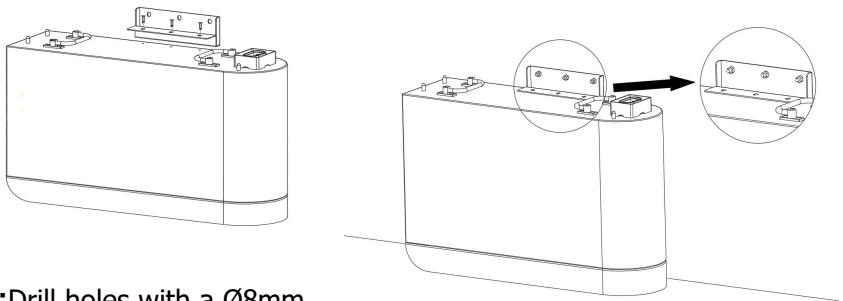

**Step 4:**Drill holes with a  $\text{Ø}8\text{mm}$  drill bit, the depth is about 60mm, and the hole spacing is as follows: (install the explosion screws after drilling)

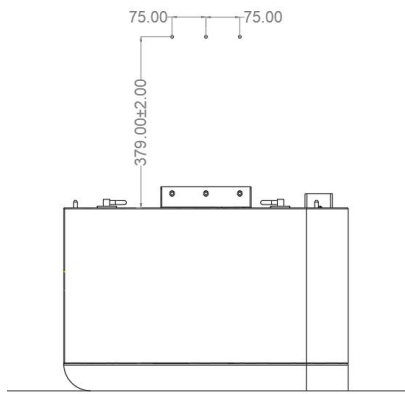

**Step5:** Align the pins, place the second battery module on top of the first battery module, and secure the hanger with the screws. After installing the second battery pack, install the third and fourth battery packs in sequence. Finally, install the main control box to complete the installation. as the picture shows:

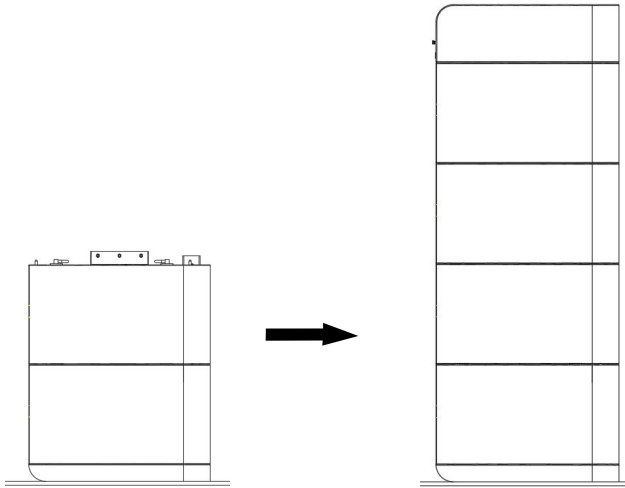

**Step 6:** Open the side cover of the main control box, install the output cable and communication cable, and connect to the inverter. Lock the side cover to complete the installation.

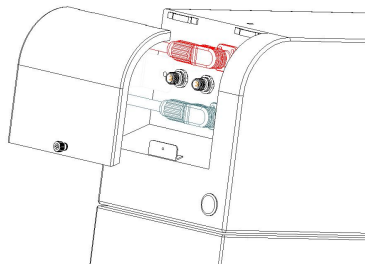

**Step 7:**Start the high pressure system. Press the power switch for 3S, when the red light of the switch lights up, release your finger to start the system.

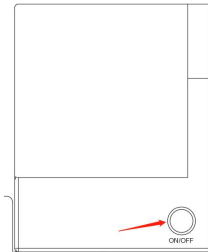

**Step 8:**Running the device, set the external charger or inverter parameters, please set according to the corresponding operation manual.Can not exceed the rated parameter requirements .

System parameters:

<b>Nominal Voltage</b>	204.8V (64series)	307.2V (96series)	409.6V (128series)
<b>Capacity</b>	50Ah		
<b>Energy</b>	10.2KWh	15.3KWh	20.4KWh
<b>Cycle Life</b>	≥5000cycles@80%DOD,25℃, 0.5C ≥4000cycles@80%DOD,40℃, 0.5C		
<b>Charge Cut-off Voltage</b>	224V	336V	448V



<b>Max. Continuous Work Current</b>	50A		
<b>Discharge Cut-off Voltage</b>	172.8V	259.2V	342.9V
<b>Charge Temperature</b>	0°C~60°C (Under 0°C extra heating mechanism)		
<b>Discharge Temperature</b>	-20°C~60°C (Under 0°C work with reduced capacity)		
<b>Storage Temperature</b>	-40°C~55°C @ 60%±25% relative humidity		
<b>Dimensions(L*W*H)</b>	630*185*954 mm	630*185*1301 mm	630*185*1648 mm
<b>Weight</b>	Approx:128kg	Approx:176kg	Approx:224kg
<b>Protocol (optional)</b>	RS232-PC,RS485-PC Can bus-Inverter		
<b>Certification</b>	UN38.3,MSDS		

**Step 9:** Stop operating the battery pack.

When it is necessary to stop the charging and discharging of the battery or troubleshoot, please stop the external equipment first, cut off the input and output circuits, and then switch the Changan power switch for 3S, when the power switch starts to flash. Release your finger and the system shuts down.

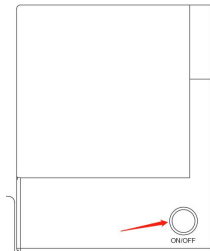

## Appendix 1

**A Host soft operation:**

When the equipment manufacturer confirms that it is necessary, it can authorize to provide the customer with the host software and operating instructions.

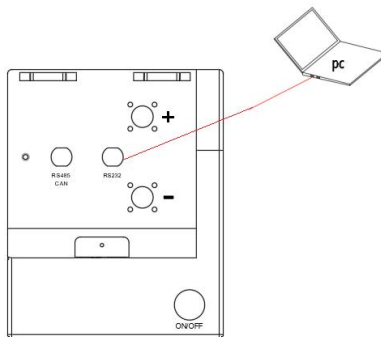

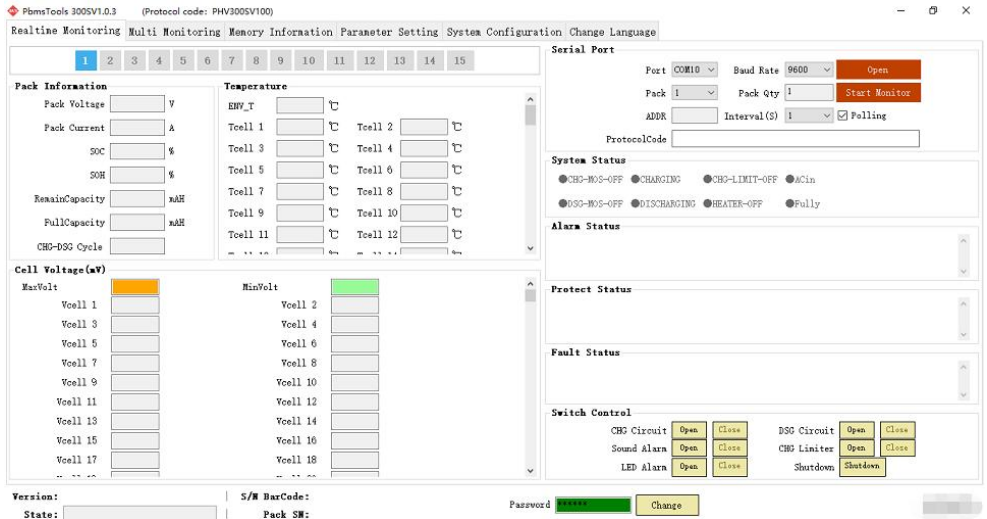

## Appendix 2

### Troubleshooting

1 battery pack stop work.

- A: turn on switch, be sure it is ON; if battery is low SOC, it needs charging in.
- B: Battery pack low volt or enter sleep mode, there you will press down power switch button, then charge in.

2 No communication, inverter can not receive any DATA from BMS.

- A: Check whether if communication cable is OK,
- B: Replace the communication line. Please give feedback to the dealer and exchange it.
- C: Check inverter or other device which connect to BMS, update its firmware.
- D: If the communication function needs to be upgraded, please consult the agent or manufacturer.
- E: confirm your inverter and battery protocol is correct, different protocol or different connection will make a mistake.



3 Battery pack report SOC is mistake.

A: inverter received Data from Master BMS ,but it is SOC <total SOC,sample as : packs has 50Ah capacity,but inverter read DATA is 30Ah.So you may check every cell Voltage unbalance.This will lead to lower SOC.

B: SOC DATA has Large tolerance.

Discharge empty the battery first, then charge it fully with a small current, and learn to discharge. Any pack is mistake ,we advice you read the BMS Data(When we authorize the terminal to use) with host software.then we reset the BMS and calibration.

4 How to turn on the Pack to discharge.

we recommend method is :

A: reset the power switch,then restart bms system.

B: turn on the power switch on the bottom/front panel;

 **WARNING:** The operating parameters of the equipment cannot exceed the rated working voltage and current of the Pack, exceed the rated volt and current,Can cause damage to the Pack or other failures.

5 Inverter or other external device can not connect the battery.

we recommend method is :

A: Check whether the working parameters of the device and battery are appropriate, and improper parameters cannot be matched.

B: it is necessary to update BMS parameters and match the device,then Reset BMS and restart your device.

6 Replace bad Pack.

There is a bad battery pack ,it is need to replace ,please connect your supplier, need professional installers to operate it .We recommend replace all or make pack has same voltage and same specification batteries pack.



NOTE:When replacing the battery, the same module needs to be replaced at the same time, and the voltage should be the same.

7 Need to replace spare parts or emergency maintenance.

Some parts can be obtained from the sales or agency, and the excess parts need to be purchased separately.Be careful, turn off the power switch before replacing parts.

8 Need to place some safety device for keep a safe environment.

You'd keep a safe case for Pack and external device,Please place safety device , as :fire-fighting sand, fire-fighting blankets, fire-fighting water pipes , Install Monitor sound, light, electricity, smoke and other equipment.

## **WARNING:**

Emergency process:

1 .The external device catches fire and explodes:

A: Under the condition of ensuring safety, non-operating personnel immediately move to a safe location;

B: Under the condition of ensuring safety, the operator immediately cut off the external power supply of the equipment and the internal power supply.

C:Use fire-fighting equipment for fire-fighting treatment (the use of fire-fighting sand, fire-fighting blankets, fire-fighting water pipes)

D:If you cannot completely extinguish the fire, please call the local fire department for help.

E:Keep the accident site data so that the source of the accident can be traced.



2 .The Pack catches fire and explodes:

A: Under the condition of ensuring safety, non-operating personnel immediately move to a safe location;

B: Under the condition of ensuring safety, the operator immediately cut off the external power supply of the equipment and the internal power supply.

C:Use fire-fighting equipment for fire-fighting treatment (first the use of fire-fighting sand, fire-fighting blankets, then fire-fighting water pipes for cool the Pack)

D:If you cannot completely extinguish the fire, please call the local fire department for help.

E:Keep the accident site data so that the source of the accident can be traced.