

**SR05 Series 5V 25A Diode Array**

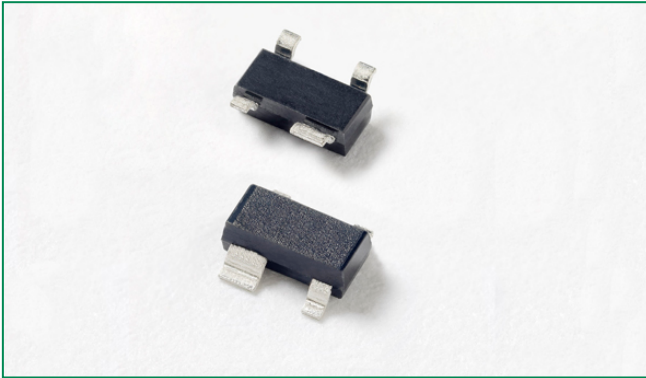

**Description**

The SR05 consists of four, low capacitance steering diodes and a low voltage TVS diode that provide protection against ESD and lightning surge events. Each channel or I/O pin can safely absorb up to 25A ( $t_p=8/20\mu s$ ) and repetitive ESD strikes above the maximum level (Level 4) specified in the IEC 61000-4-2 international standard without performance degradation.

The low loading capacitance makes it ideal for protecting high-speed telecommunication data lines.

**Pinout**

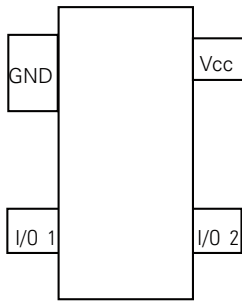

**Features**

- ESD, IEC61000-4-2,  $\pm 30kV$  contact discharge,  $\pm 30kV$  air discharge
- EFT, IEC61000-4-4, 80A ( $t_p=5/50ns$ )
- Lightning protection, IEC61000-4-5, 25A ( $t_p=8/20\mu s$ )
- Low capacitance of 6.0pF (TYP) per I/O
- Low clamp voltage
- Small SOT143 (JEDEC TO-253) packaging
- Moisture Sensitivity Level (MSL-1)

**Functional Block Diagram**

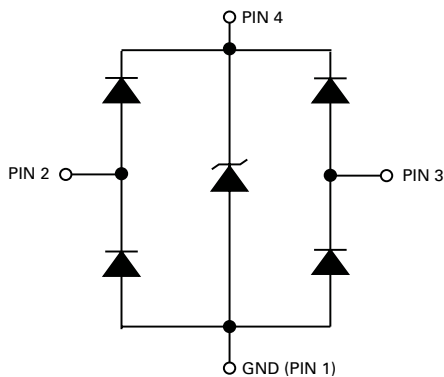

**Applications**

- T1/E1 IC/Secondary Protection
- Ethernet 10BaseT
- WAN/LAN Equipment
- ISDN S/T Interface
- Video Lines
- Microcontroller Input Protection

**Application Example**

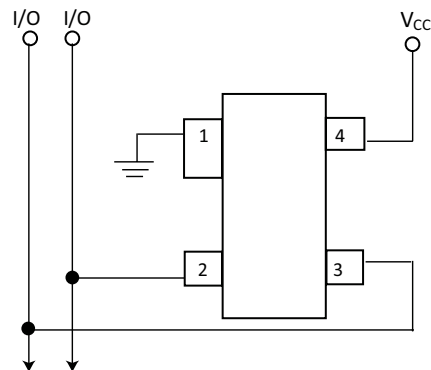

The SR05 integrates a TVS Diode between the Vcc and Gnd pins. This allows the array to protect the power supply against ESD and lightning surges when these pins are both connected in the application.

**Additional Information**



**Datasheet**



**Resources**



**Samples**

Life Support Note:

**Not Intended for Use in Life Support or Life Saving Applications**

The products shown herein are not designed for use in life sustaining or life saving applications unless otherwise expressly indicated.

| Absolute Maximum Ratings |                                      |            |       |
|--------------------------|--------------------------------------|------------|-------|
| Symbol                   | Parameter                            | Value      | Units |
| $I_{PP}$                 | Peak Current ( $t_p=8/20\mu s$ )     | 25.0       | A     |
| $P_{PK}$                 | Peak Pulse Power ( $t_p=8/20\mu s$ ) | 450        | W     |
| $T_{OP}$                 | Operating Temperature                | -40 to 125 | °C    |
| $T_{STOR}$               | Storage Temperature                  | -55 to 150 | °C    |

| Thermal Information                         |            |       |
|---|------------|-------|
| Parameter                                   | Rating     | Units |
| Storage Temperature Range                   | -55 to 150 | °C    |
| Maximum Junction Temperature                | 150        | °C    |
| Maximum Lead Temperature (Soldering 20-40s) | 260        | °C    |

CAUTION: Stresses above those listed in "Absolute Maximum Ratings" may cause permanent damage to the device. This is a stress only rating and operation of the device at these or any other conditions above those indicated in the operational sections of this specification is not implied.

| Electrical Characteristics ( $T_{OP}=25^\circ C$ ) |               |   |          |     |      |          |
|--|---------------|---|----------|-----|------|----------|
| Parameter  | Symbol        | Test Conditions                           | Min      | Typ | Max  | Units    |
| Reverse Stand-Off Voltage                          | $V_{RWM}$     |   | -        | -   | 5.0  | V        |
| Reverse Leakage Current                            | $I_R$         | $V_R = 5V$ , I/O to GND                   | -        | -   | 5.0  | $\mu A$  |
| Reverse Breakdown Voltage                          | $V_{BR}$      | $I_t = 1mA$                               | 6.0      | -   | -    | V        |
| Clamping Voltage, Line-Ground <sup>1</sup>         | $V_C$         | $I_{PP} = 1A$ , $t_p = 8/20 \mu s$        | -        | -   | 9.8  | V        |
| Clamping Voltage, Line-Ground <sup>1</sup>         | $V_C$         | $I_{PP} = 10A$ , $t_p = 8/20 \mu s$       | -        | -   | 12.0 | V        |
| Clamping Voltage, Line-Ground <sup>1</sup>         | $V_C$         | $I_{PP} = 25A$ , $t_p = 8/20 \mu s$       | -        | -   | 18.0 | V        |
| Dynamic Resistance, Line-Ground <sup>1</sup>       | $R_{DYN}$     | $(V_{C2} - V_{C1}) / (I_{PP2} - I_{PP1})$ | -        | 0.3 | -    | $\Omega$ |
| ESD Withstand Voltage <sup>1</sup>                 | $V_{ESD}$     | IEC61000-4-2 (Contact Discharge)          | $\pm 30$ | -   | -    | kV       |
|  |               | IEC61000-4-2 (Air Discharge)              | $\pm 30$ | -   | -    | kV       |
| Diode Capacitance <sup>1</sup>                     | $C_{I/O-I/O}$ | Reverse Bias=0V                           | -        | 3.0 | -    | pF       |
|  | $C_{I/O-GND}$ | Reverse Bias=0V                           | -        | 6.0 | 10.0 | pF       |

Note: 1. Parameter is guaranteed by design and/or device characterization.

### Capacitance vs. Reverse Bias

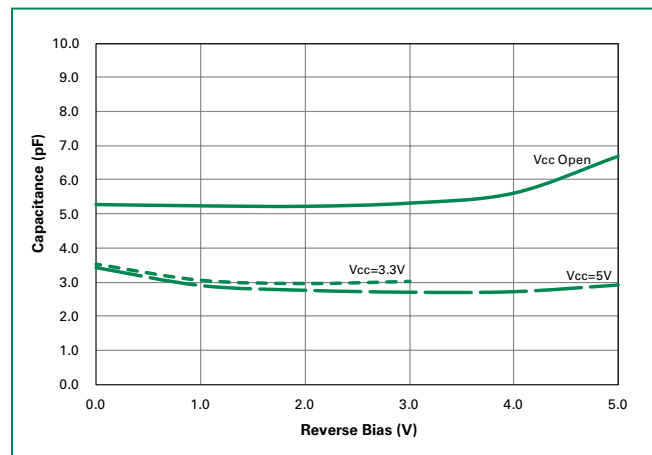

### 8/20µs Pulse Waveform

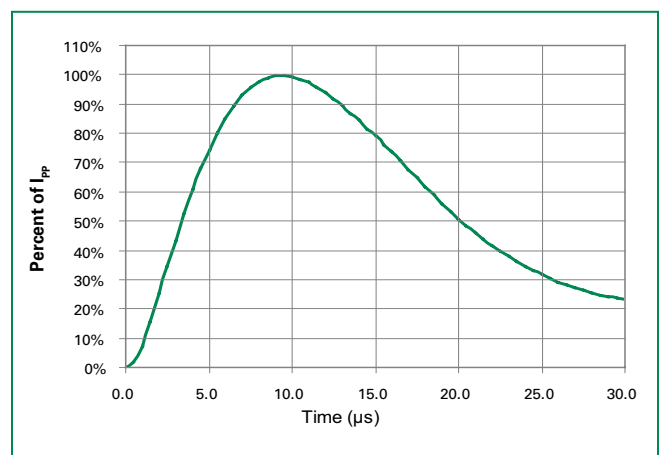

**Clamping Voltage vs.  $I_{pp}$**

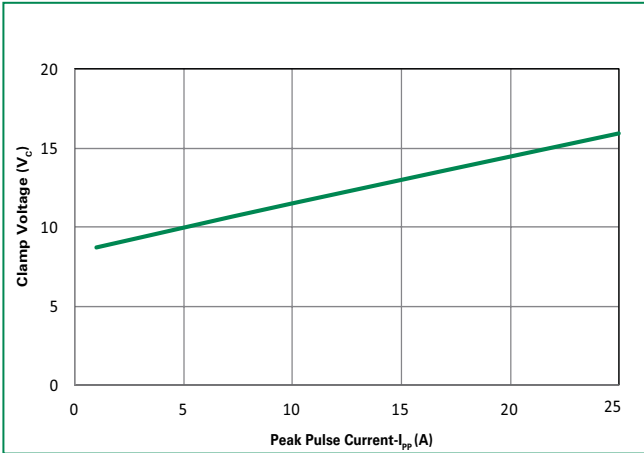

**Product Characteristics**

|                            |                         |
|----------------------------|-------------------------|
| <b>Lead Plating</b>        | Matte Tin               |
| <b>Lead Material</b>       | Copper Alloy            |
| <b>Lead Coplanarity</b>    | 0.0004 inches (0.102mm) |
| <b>Substitute Material</b> | Silicon                 |
| <b>Body Material</b>       | Molded Epoxy            |
| <b>Flammability</b>        | UL 94 V-0               |

- Notes :
1. All dimensions are in millimeters
  2. Dimensions include solder plating.
  3. Dimensions are exclusive of mold flash & metal burr.
  4. Blo is facing up for mold and facing down for trim/form, i.e. reverse trim/form.
  5. Package surface matte finish VDI 11-13.

**Soldering Parameters**

|  |                                    |                  |
|--|------------------------------------|------------------|
| Reflow Condition                                       | Pb – Free assembly                 |                  |
| Pre Heat   | - Temperature Min ( $T_{s(min)}$ ) | 150°C            |
|  | - Temperature Max ( $T_{s(max)}$ ) | 200°C            |
|  | - Time (min to max) ( $t_s$ )      | 60 – 180 secs    |
| Average ramp up rate (Liquidus) Temp ( $T_L$ ) to peak | 3°C/second max                     |                  |
| $T_{s(max)}$ to $T_L$ - Ramp-up Rate                   | 3°C/second max                     |                  |
| Reflow   | - Temperature ( $T_L$ ) (Liquidus) | 217°C            |
|  | - Temperature ( $t_l$ )            | 60 – 150 seconds |
| Peak Temperature ( $T_p$ )                             | 260 <sup>+0/-5</sup> °C            |                  |
| Time within 5°C of actual peak Temperature ( $t_p$ )   | 20 – 40 seconds                    |                  |
| Ramp-down Rate   | 6°C/second max                     |                  |
| Time 25°C to peak Temperature ( $T_p$ )                | 8 minutes Max.                     |                  |
| Do not exceed  | 260°C                              |                  |

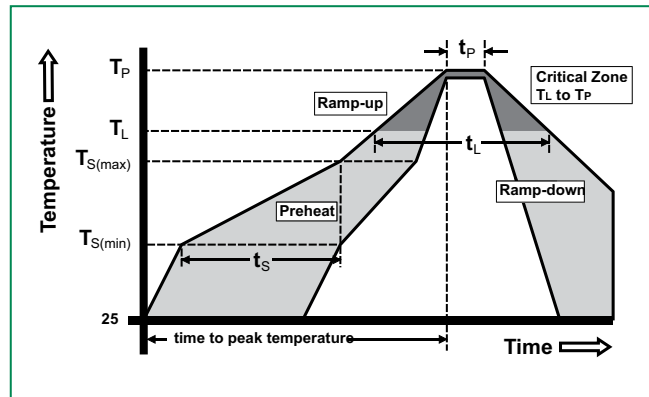

**Ordering Information**

| Part Number | Package | Marking | Min. Order Qty. |
|-------------|---------|---------|-----------------|
| SR05-02CTG  | SOT143  | SR05    | 3000            |

**Part Numbering System**

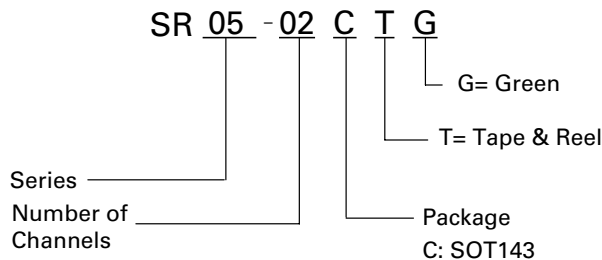

**Part Marking System**

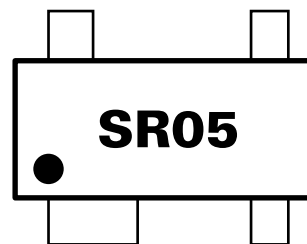

**Package Dimensions—SOT143**

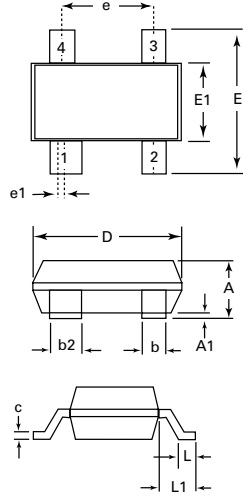

**Recommended Pad Layout**

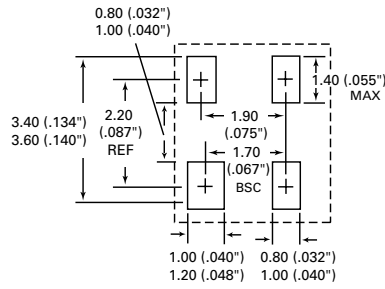

| Package   | SOT143      |      |           |       |
|-----------|-------------|------|-----------|-------|
| Pins      | 4           |      |           |       |
| JEDEC     | TO-253      |      |           |       |
|           | Millimeters |      | Inches    |       |
|           | Min         | Max  | Min       | Max   |
| <b>A</b>  | 0.8         | 1.22 | 0.03      | 0.048 |
| <b>A1</b> | 0.05        | 0.15 | 0.002     | 0.006 |
| <b>b</b>  | 0.30        | 0.50 | 0.012     | 0.020 |
| <b>b2</b> | 0.76        | 0.89 | 0.030     | 0.035 |
| <b>c</b>  | 0.08        | 0.20 | 0.003     | 0.008 |
| <b>D</b>  | 2.80        | 3.04 | 0.110     | 0.120 |
| <b>E</b>  | 2.10        | 2.64 | 0.082     | 0.104 |
| <b>E1</b> | 1.20        | 1.40 | 0.047     | 0.055 |
| <b>e</b>  | 1.92 BSC    |      | 0.076 BSC |       |
| <b>e1</b> | 0.20 BSC    |      | 0.008 BSC |       |
| <b>L</b>  | 0.4         | 0.6  | 0.016     | 0.024 |
| <b>L1</b> | 0.550 REF   |      | 0.022 REF |       |

**Embossed Carrier Tape & Reel Specification—SOT143**

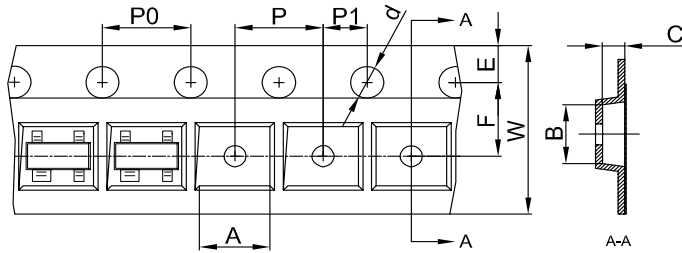

| Symbol    | Millimeters |
|-----------|-------------|
| <b>A</b>  | 3.19±0.10   |
| <b>B</b>  | 2.8±0.10    |
| <b>C</b>  | 1.31±0.10   |
| <b>d</b>  | ∅ 1.50±0.10 |
| <b>E</b>  | 1.75±0.10   |
| <b>F</b>  | 3.50±0.10   |
| <b>P0</b> | 4.00±0.10   |
| <b>P</b>  | 4.00±0.10   |
| <b>P1</b> | 2.00±0.10   |
| <b>W</b>  | 8.00±0.10   |

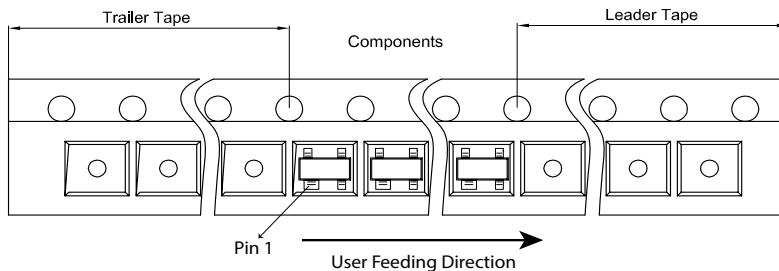

Notes :  
1. All dimensions are in millimeters

**Disclaimer Notice - Information furnished is believed to be accurate and reliable. However, users should independently evaluate the suitability of and test each product selected for their own applications. Littelfuse products are not designed for, and may not be used in, all applications. Read complete Disclaimer Notice at [www.littelfuse.com/disclaimer-electronics](http://www.littelfuse.com/disclaimer-electronics).**