

STATEMENT:

The product appearance, color, and parameters listed in this version are for reference only, and the specific product is subject to the actual product issued by our company.

The company reserves the right to change or cancel the relevant parameters of the information at any time without prior notice and it is prohibited to reproduce in whole or in the part without permission.



YUJIE SINCE 2003
COMPANY

 **DONGGUAN YUJIE ELECTRONIC TECHNOLOGY CO.,Ltd**

 Factory Add: 8F, No.2 Yuanshanzai Road, Xin' an District, Chang'an Town,
Dongguan City, Guangdong Province, China

 Tel: 86-769-8535 2269 8547 2786

 Mobile/Wechat: +86 138 0926 5829 13528627168(Lily lu)

 E-mail: yujie@dgyujie.com yujieLJ@vip.163.com

 Website: www.dgyujie.com www.yujiepower.com

www.dgyujie.en.alibaba.com



Website



Wechat

BEST CAR ACCESSORIES FOR ALL



简介 Company Profile 
 公司 Profile

东莞市宇捷电子科技有限公司
 DONGGUAN YUJIE ELECTRONIC TECHNOLOGY CO.,LTD

Dongguan Yujie Electronic Technology Co., Ltd, established in 2003, is a national high-tech enterprise. As one of the earliest manufacturers of auto parts and auto modification parts in China, our company relies on a complete and integrating business system of research, production, sales and service to offer various types of products to domestic and foreign markets including auto switches, car chargers, and cigarette lighters, panel series and various automotive wiring harnesses, connectors, electronic controllers etc.

东莞市宇捷电子科技有限公司成立于2003年，是国家级高新技术企业。作为国内最早从事汽车配件及汽车改装零部件制造企业之一，依托完善的研、产、销及服务一体化的业务体系，公司面向国内外市场提供各类汽车开关、车载车充、点烟器、面板系列及各种汽车线束、连接器、电子控制器等。

The company adheres to the orientation of technological innovation and stay heavily invested in R&D investment. In terms of talent cultivation, gathering top technical talents in the industry, we have established an excellent R&D team. We mastered a number of core industry technologies so we obtained so many technical patents such as invention patents, utility model patents, appearance patents and so on. As for hardware facilities, it has been equipped with advanced production equipment and efficient and standardized production lines which ensures its leading position in the market in terms of product technology and quality.

公司坚持以技术创新为导向，持续保持大比重的研发投入；在人才培育方面，通过汇聚行业内顶尖的技术人才，组建优秀的研发团队，拥有多项行业核心技术，获得发明专利、实用新型专利、外观专利等共 项技术专利；在硬件设施方面，已配置先进的生产设备以及高效规范的生产线，保证了产品技术和质量在市场上的领先地位。

The company has obtained ISO9001 and IATF16949 quality management system certification, and its products have obtained industry-related certifications such as CE certification, UL certification, ROHS environmental certification that are widely used in various automotive modification fields at home and abroad.

公司获得ISO9001及IATF16949质量管理体系认证，产品获得CE认证、UL认证、ROHS环保认证等行业相关认证，广泛应用于国内外各类汽车改装领域。

Professional team and auto car manufacturer

We hope to cooperate with customers from all around the world. We believe we can satisfy customers with our best products and services. We can make a better and more prosperous future for our customers.



PRODUCTION STRENGTH

YUJIEKEJ



 **3000 m²**
Plant areas

With the experience of 20 years in the R&D and manufacturing of switch and socket-related products, we have complete manufacturing capability and advanced automatic assembly capability because of automatic inspection equipment, and independent innovation of process technology, to provide customers with a fast and efficient all-around service.



Punch operation



CNC Seiko manufacturing



Seiko manufacturing



Vertical injection molding operation



Horizontal injection

Enterprise honor

We have CE Certification, UL Certification, ISO-9001 Certification, IATF 16949 Certification, Chinese CCC authentication ROHS Certification etc.

Patents we have got

10 patents for innovation,
5 patents for utility model and 10 patents for design.



Certification qualification



CORPORATE CULTURE



企业文化



What is my advantage (compared to my opponent)
我的优势是什么 (与对手比较)



[Who are my clients:]

我的客户是谁

- Global automotive parts professional supermarkets and modification markets. 全球汽车配件专业商超及改装市场

[Orientation]

企业定位

- Leading manufacturer in the modified manufacturing industry. 做改装制造行业领先的生产商

[Corporate mission]

企业使命

- Quality as the core, Service as guarantee, Unremitting efforts to promote the healthy development of the automotive parts industry. 以质量为核心, 以服务为保障, 为推动汽车配件行业健康发展不懈努力。

[Corporate Purpose]

企业宗旨

- Focusing on the research and development, manufacturing, and service of automotive parts, striving to achieve a win-win situation between customer teams and enterprises. 聚焦汽车配件的研发制造服务 努力实现客户 团队与企业共赢。

[Corporate Vision]

企业愿景

- Building Yujie into a world-class automotive accessory industry, Creating Yujie as an international automotive accessory brand. 建设宇捷成为世界一流的汽车配件 打造宇捷成为国际汽车配件名牌。



01	BATTERY BOX SERIES 电池箱系列	PA GE	11	
02	RV SURGE PROTECTOR SERIES 涌浪保护器系列	PA GE	21	
03	WRANGLER JEEP SWITCH PANEL SERIES 牧马人吉普车开关面板系列	PA GE	25	
04	RV LOCK SERIES 房车门锁系列	PA GE	31	
05	USB CAR CHARGER SERIES USB 汽车充电器系列	PA GE	43	
06	DIGITAL DISPLAY VOLTMETER SERIES 数字显示电压表系列	PA GE	55	
07	POWER SOCKET CIGARETTE LIGHTER SOCKET SERIES 电源插座 点烟器插座系列	PA GE	63	
08	ROCKER SWITCH SERIES 船型开关系列	PA GE	67	
09	SWICH PANEL EMPTY PANEL (Plastic/Alu) 面板空板(塑胶/铝)	PA GE	79	
10	SWITCH PANEL SERIES 开关面板系列	SWITCH PANEL ALUMINUM PANEL 铝质面板 PLASTIC PANEL SERIES 塑胶面板系列	PA GE	85
11	RACING SWITCH PANEL 点火开关面板	PA GE	97	
12	FUSE BOX SERIES 保险丝盒系列	PA GE	101	
13	BUS BAR TERMINALS 汇线排系列	PA GE	107	
14	FUSE HOLDER SERIES 取电器系列	PA GE	113	
15	SPECIAL CAR SWITCH USB CHARGER SERIES 专车专用开关 USB 充电器系列	PA GE	117	
16	MOTORCYCLE USB CHARGER SERIES 摩托车 USB 充电器系列	PA GE	135	
17	CIRCUIT BREAKER SERIES 断路器系列	PA GE	145	
18	ANDERSON TENT SERIES 安德森帐篷/塑胶面板系列	PA GE	151	

19	ANDERSON SERIES 安德森连接器系列	PA GE	153
20	BATTERY SWITCH SERIES 电池开关系列	PA GE	167
21	TERMINAL SERIES 接线柱系列	PA GE	173



BATTERY BOX SERIES

We design it as a battery installation box for boats, various cars, RVs, yachts, etc. It has a beautiful appearance equipped with a fixing belt and a base which is corrosion-resistant, light in weight more convenient and more economical than boxes made of wood and fiberglass.



YJ-DCX75

75 Battery Box

Material: PP
 Product size(LWH): 430*270*340mm
 Capacity size(LWH): 358*208*208mm
 Net weight: 1.38KG

Product Overview



Product Overview



YJ-DCX84 /12V Battery Box

- Size: 250*420*330mm
- Switch: 12-24V
- Voltmeter: 12-24V
- USB: 2xUSB QC3.0&2.4AMP
- Power socket: 12-24V
- Anderson interface: 100A/50A

YJ-DCX78-1 /12V Battery Box

- Size: 250*420*330mm
- Switch: 12-24V
- Voltmeter: 12-24V
- USB: 2xUSB QC3.0&2.4AMP
- Power socket: 12-24V
- Anderson interface: 100A/50A

Large capacity, outdoor portable



YJ-DCX78 12V Battery Box

Size: 254.7*452*361mm
 Switch: 12-24V
 USB: 2xUSB QC3.0&2.4AMP
 Anderson interface: 100A/50A

About Charge Manager



■ OPERATING PRINCIPLE

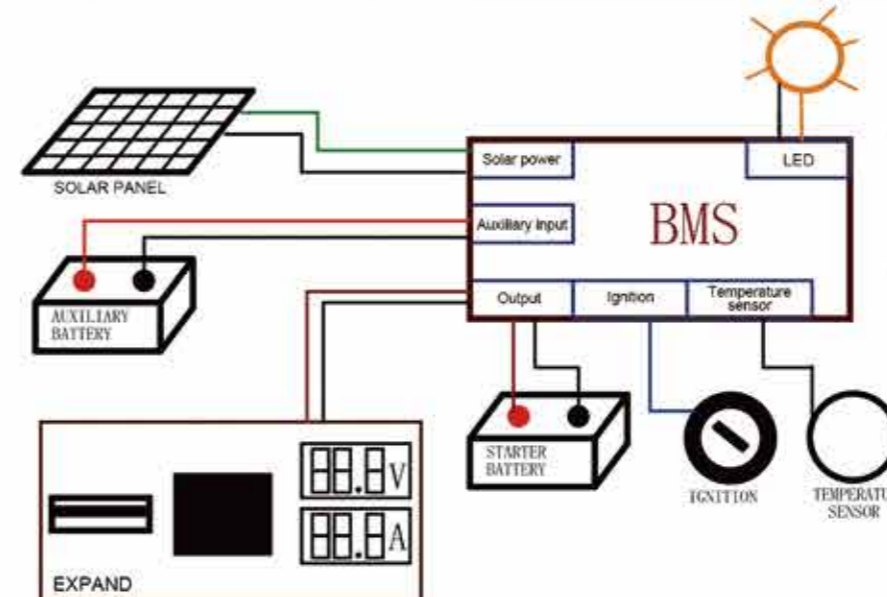

Charger model:

KADCDC25A KADCDC25A-AND KADCDC25A-BB
 Maximum Solar Input Voltage 23V DC
 Alternator Input Voltage 9-32V DC
 Maximum Input Current 40A
 Output Current 9-11V DC: 20A Input 11-32V DC: 25A

Charge Control

Charge Type	4-step fully automatic charging				
Bulk	Constant Current up to:				
	GEL	AGM	WET	CALCIUM	LITHIUM
	14.1V	14.4V	14.7V	15.4V	14.4V
Absorption	Constant voltage until current drops to 3.8A:				
	GEL	AGM	WET	CALCIUM	LITHIUM
	14.1V	14.4V	14.7V	15.4V	14.4V
Float	13.7V				
Pulse	Also with Pulse Feature				
	GEL:12.6V-14.1V 25-2A		CALCIUM:12.6V-15.4V 25-2A		
	AGM:12.6V-14.4V 25-2A		WET:12.6V-14.7V 25-2A		
Equalisation (Calcium only)	3.8A Constant Current Charge up to 16V then hold 1 hour (5 hour timerout)				



BATTERY BOX SERIES



YJ-DCX76
Smooth Battery Box

Product size(LWH): 415*235*320mm
Capacity size(LWH): 360*205*208mm



YJ-DCX79
Standard Battery Box

Material: PP
Product size(LWH): 430*270*340mm
Capacity size(LWH): 356*206*210mm
Net weight: 2.2KG



YJ-DCX80
Big Battery Box

Material: PP
Product size(LWH): 465*257*265mm
Capacity size(LWH): 370*198*201mm
Net weight: 1.86KG



YJ-DCX81
Small Battery Box

Material: PP
Product size(LWH): 337*249*265mm
Capacity size(LWH): 281*193*201mm
Net weight: 0.98kg



YJ-DCX82
Big Size Battery Box

Material: PP
Product size(LWH): 443*253*305mm
Capacity size(LWH): 380*197*242mm
Net weight: 1.28kg



YJ-DCX83
Standard Battery Box

Material: PP
Product size(LWH): 430*245*270mm
Capacity size(LWH): 369*198*209mm
Net weight: 1.14kg

12V CONTROL BOX >>>



YJ-JEEP20

6-Way Switch Control Box

- 12V/24V Plastic control box
- box Size: 350x175x90mm
- Blue led 3P ON-OFF Switch x6(12V 20A /24V10A DC)
- Power Socket x3(12V 20A /24V10A DC)
- Dual Port USB Socketx1 (5V 3.1A DC)
- blue led Voltmeter Socket x1(6V~~30V DC)
- Anderson Connector x2 (50A)
- 6way waterproof Fuse Box x1 (100A 32V DC.max)
- 4way Bus Bar x2 (150A 32V DC.max) (red/black)
- Fuse: 5Ax1,15Ax3,20Ax1,30Ax2
- Wire : 1015 / 10AWG & 1015 / 14AWG
- Dimensions (L x W x H) : 355x180x138 mm (including fuse block height)
- Shell Material : Nylon



YJ-JEEP66

**Power Control Box
(battery switch/Anderson/PD
/voltage)**



YJ-JEEP66-1

**Power Control Box
with DS+Anderson
PD+Voltage display**

- 12v/24v mini power box
- Anderson Connector x1 (50A-Input)
- Anderson Connector x2 (50A-Output)
- USB Type-ax4(5V 2.4A DC)
- USB Type-c x1(PD 5.0V~20V,Max :60W)
- Voltmeter x1 Rating : 6V~30V
- Fuse Box x1(100A 32V DC.max)
- Fuse:10Ax3 30Ax2
- Wire: 10269 / 8AWG &10269 / 10AWG & 1015 1 16AWG
- Dimensions (L x W x H): 140x160x85 mm
- Shell Material : Nylon

YJ CODE	Details	Battery Switch
YJ-JEEP66	Power Socket x2	100Ax1
YJ-JEEP66-1	Power Socket x3	/



YJ-JEEP76

12V Control Box



YJ-JEEP32

3 Hole Power USB Socket with Power Switch (12V to 12V)



YJ-JEEP77

Solar-Power Control Box



YJ-JEEP78

Control Box with 6 Gang Panel



YJ-JEEP79

Mini Control Box



YJ-JEEP80

12V Fuse Box
With Andson Control Box



RV SURGE PROTECTOR SERIES



YJ-BHQ002

surge protector

Plug type	30A
Material	PVC



YJ-BHQ013

50Amp Surge Protection

Plug type	50A
Input Voltage	125V



YJ-BHQ006

RV Camper Cord Adapter 30A Male to 50A Female Power Connector

Plug type	L14-30P 30A 125/250V 14-50R 50A 125/250V
Material	PVC
Wire gauge	10/3 AWG



YJ-BHQ007

New Surge Protector

Plug type	
Material	PVC
Colour:	Green



YJ-BHQW10

Surge Protector

Plug type	RV 50A 01-1F
Material	PCV



YJ-BHQ008

RV Camper Cord Adapter 30A Male to 50A Female Power Connector

Plug type	L14-30P 30A 125/250V 14-50R 50A 125/250V
Material	PVC
Wire gauge	10/3 AWG



YJ-BHQ008-1

30A conversion socket (round)

Plug type	L14-30P 30A 125/250V 14-50R 50A 125/250V
Material	PVC
Wire gauge	10/3 AWG



YJ-BHQ008-2

RV Camper Cord Adapter 30A Male to 50A Female Power Connector

Plug type	L14-30P 30A 125/250V 14-50R 50A 125/250V
Material	PVC
Wire gauge	10/3 AWG



YJ-BHQ008-3

RV Camper Cord Adapter 30A Male to 50A Female Power Connector

Plug type	L14-30P 30A 125/250V 14-50R 50A 125/250V
Material	PVC
Wire gauge	10/3 AWG



YJ-BHQ010

New Surge Protector

Plug type	50A
Material	PVC



YJ-BHQ012

Surge Protector

Plug type	30A 6500J
Material	PVC



YJ-BHQW01

Surge Protection Plug

Plug type	TT-30P TT-30R
Material	PVC



YJ-BHQW02

New Surge Protector

Plug type	30A
Material	PVC



YJ-BHQW03

Surge Protector 30A

Plug type	5000J Black
Material	PVC



YJ-BHQW11

RV Camper Cord Adapter 30A
Male to 50A Female Power Connector

Plug type	L14-30P 30A 125/250V 14-50R 50A 125/250V
Material	PVC
Wire gauge	10/3 AWG



YJ-BHQW12

Digital Display Surge Protector 120V

Plug type	2450J, 30A
Material	PCV
Colour:	Orange



YJ-BHQW05

Central Surge Protector 30A

Plug type	TT-30P to TT-30R
Material	PCV yellow



YJ-BHQW07-1

30A Conventional Surge Protector

Plug type	30A
Material	PCV
Colour:	yellow



YJ-BHQW08

RV Surge Protector 30A
(Cigarette Lighter With Cover)

Plug type	30A
Material	PCV
Colour:	(Orange) YJ-03-8000J



YJ-BHQW09

Digital Display Surge Protector 120V

Plug type	120A
Material	PCV
Colour:	Black



YJ-BHQW04

Surge protector 50A
Lightning Protection for RV with line test function
ETL certification

Plug type	50A
Material	PCV



YJ-BHQW06

Tail Surge Protector 30A

Plug type	TT-30P to TT-30R
Material	PCV

WRANGLER JEEP SWITCH PANEL SERIES



YJ-JEEP19B

6 Gang Switch Panel
with Digital

Input: DC 12-24V
Voltage range: DC 9-30V
Material: Metal+ABS
Light color: BU/RD/GN/WH/OG



YJ-JEEP25

Long-Control Box

PD: 18W
QC3.0: 18W
Anderson: 50A
Size: 240*112*60mm

YJ-JEEP03B

6 Gang Switch Panel with Relay Box

Input: DC 12V
Material: Metal+ABS
Light color: BU



YJ-JEEP35

8 Gang Switch Box System

Input: DC 12-24V
Material: PVC
Function selection:
Physical button
Shell color: BU/BL



YJ-JEEP44

3-Way Relay Fuse Box

Input: DC 12-24V
Current: 40A-80A
Fusing speed: F



YJ-JEEP45

4-Way Relay Fuse Box

Input: DC 12-24V
Current: 40A-80A
Fusing speed: F



YJ-JEEP24

8 Gang Switch Box System with App

Input: DC 12V
Material: Aluminum+PVC
Function selection:
Bluetooth APP/physical button
Shell color: BL



YJ-JEEP09

8 Gang Control Box

Input: DC 12-24V
Material: Plastic
Light color: BU/RD

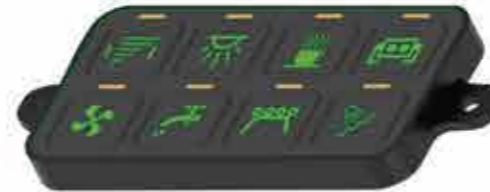

YJ-JEEP18

6-Way Relay Fuse Box

Input: DC 12-24V
Current: 40A-80A
Fusing speed: F



YJ-JEEP55

2-Way Relay Fuse Box
(WULING)

Input: DC 12-24V
Current: 40A-80A
Fusing speed: F



YJ-YJ-JEEP74/JEEP74-1

8 Gang RGB Control Box
8 Gang RGB +APP Control Box

Input: DC 12V
Material: Aluminum+PVC
Function selection:
Bluetooth APP/physical button



YJ-JEEP57

7-Way Relay Fuse Box

Input: DC 12-24V
Current: 40A-80A
Fusing speed: F



YJ-JEEP73/JEEP73-1

12 Gang RGB Control Box
12 Gang RGB +APP Control Box

Input: DC 12-24V
Material: PVC
Function selection:
Physical button



YJ-JEEP02

4100B 4 gang control box



YJ-JEEP59

10-Way Relay Fuse Box

Input: DC 12-24V
Current: 40A-80A
Fusing speed: F

YJ-JEEP05

6 Gang Touch Screen Panel



Input: DC 12-24V
Material: Metal+ABS
Light color: BU

YJ-JEEP23

8 Gang Touch Screen Panel



Input: DC 12-24V
Material: Metal+ABS
Light color: BU
Size: 198*162*80mm

YJ-JEEP53

4 Gang Smart Touch Screen Panel



Input: DC 12V
Material: Aluminum+PVC
Function selection:
Bluetooth APP/physical button
Shell color: BL

YJ-JEEP10B

4 Gang Switch Box (Blue/Red Light)



Input: DC 12-24V
Material: Metal+ABS
Light color: BU/RD

YJ-JEEP11B

6 Gang Switch Box (Blue/Red Light)



Input: DC 12-24V
Material: Metal+ABS
Light color: BU/RD

YJ-JEEP31

6 Gang Control Box With Switch

Input: DC 12-24V
Material: Metal+ABS
Light color: BU/RD



YJ-JEEP04

SR5U6 6 Gang Switch Panel With Relay Box

Input: DC 12-24V
Material: Metal+ABS
Light color: BU/RD



YJ-JEEP16

6 Gang Control Box With Switch

Input: DC 12-24V
Material: Metal+ABS
Light color: BU/RD

YJ-JEEP24-1

8 Gang Control Box With Dual Panel

Input: DC 12-24V
Material: Metal+ABS
Light color: BU/RD



YJ-JEEP17

Wrangler A-Pillar

Input: DC 12-24V
Material: Aluminum+PVC
Function selection:
Physical button
Shell color: BU/BL





Fit Most
Oem RV Door



YourOnly Key



Waterproof



UV-Resistant



Protective

RV LOCK SERIES

YJ-KD009

RV Door Lock with Fingerprint Unlock

Material: ZINC alloy + Plastic



Special Feature: Fingerprint, Waterproof

Lock Type: Keypad

Material: Zinc

YJ-KD010

RV Lock (Fingerprint + Password)

Material: ZINC Alloy + Plastic



Fingerprint Recognition
Fingerprint recognition with 100 groups fingerprint sensor, No need to worry about forgetting the password or revealing the password



REMOTE CONTROL
2 Pcs Remote Fob
2Pcs remote fob, could be remotely unlocked in 20m/65FT.



2 Pcs Unique Keys
2Pcs unique keys could effectively solve the problem that the emergency backup function under any circumstances.



Metal Shell
RV door lock body is made of solid zinc alloy metal material, which effectively bring more safety and lifespan.



Inner Red Unlock (customizable)
RV entry lock comes with a clear product instruction manual and follow-up steps, simple to operate.



Product Size
RV keyless entry door lock widely fit for RV, Trailer, Camper, Truck etc.

IC Card Unlock



Simply place the IC card in the card swipe area
make you easier and faster access to your RV



Remote Control Range up to 20M/65FT

Upgrade Your RV's Security with the
Convenience of Keyless Entry



YJ-KD008

RV DOOR LOCK

YJ-KD011

lock/unlocklatch

lock/unlockdeadbolt



unlock knob

insidedoor handle



deadbolt

externaldoor handle



SUITABLE FOR MOST RV BUT NOT ALL

Please measure the size before purchase

YJ-FCS001



RV lock outside size
3.5"wide/4.2" tall



Door thickness
1.25"to 1.5"



Hole cutout
2.67"wide /3.6"tall





YJ-KD001
RV Door Lock

Material:
Zine alloy + plastic
Size: 151*118*88mm



YJ-KD002
RV Door Lock V4.0
-Full Metal Lock

Material: Zine alloy
Color: Black+White
keypad membrane



YJ-KD003
RV Door Lock V4.0
-Upgraded

Material: Zine alloy
+plastic



YJ-KD004B
RV Door Lock
-Full Metal Lock

Material: Zine alloy
Color: Blue+colorful
keypad membrane



YJ-KD004GJ
RV Door Lock
-Full Metal Lock

Material: Zine alloy
Color: Golden+colorful
keypad membrane



YJ-KD005P
C02 RV Door Lock
-Full Metal Lock

Material: Zine alloy
Color: Pink+colorful
keypad membrane



YJ-KD005S
C02 RV Door Lock
-Full Metal Lock

Material: Zine alloy
Color: Grey+colorful
keypad membrane



YJ-KD005W
C02 RV Door Lock
-Full Metal Lock

Material: Zine alloy
Color: White+colorful
keypad membrane



YJ-KD006
Keyless Entry
RV Door Lock

Material: Zine alloy



YJ-KD008
RV Door Lock (IC card
wireless remote control)

Material: Zine alloy
+ plastic

The Features of Our Door Locks

Why choose us?
There are ten features of our locks.



The color of lock/keypad membrane can be customized.



The electronic board can be customized to serve different purposes.



Ergonomic grip design.



Weatherproof backlit keypad.



Authentic RV Lock handle.



Unique key code.



Silent feature.



Rust proof.



10 minute install.



Key alike system.

Wide Application



Easy Installation



USB CAR CHARGER SERIES

YJ-DS2101B

Dual PD car charger
18W+45W (blue light)

Input: DC12-24V
USB Output: 5V 1A
Material: PA+hardware
Product Size: 37*29*53mm
USB Output selection: 1A/QC3.0
Light Color: RD/BU/WH/GN/OG



YJ-DS2101B-1
60W Dual PD Charger

Input: DC12-24V
USB Output: 5V 1A
Material: PA+hardware
Product Size: 37*29*53mm
USB Output selection: 1A/QC3.0
Light Color: RD/BU/WH/GN/OG



YJ-DS2100B-1
60W Dual PD Charger with Switch

Input: DC12-24V
USB output: 5V 2.1A
Material: ABS+hardware
Product Size: 37*29*53mm
USB Output Selection: 3.1A/QC3.0
Light Color: RD/BU/WH/GN/OG



YJ-DS2082B
Dual QC3.0 with Switch +PD+Volt

Product Size: 50*37*29mm
Light color: BU



YJ-DS2083B
PD+QC3.0 usb socket with voltmeter

Product Size: 50*37*29mm
Light color: BU



YJ-DS2085B
3 port QC3.0 +switch (cabochon-Plastic)

Product Size: 50.2*36.6*36.6mm
Light Color: BU



YJ-DS2034B
QC3.0+PD Single USB+Volt+Switch
 Input: DC12-24V
 Product Size: 50*36.8*28.5mm
 Light color: BU

Application

USB car charger, suitable for all DC12V-24V motor vehicles and related equipment, for your mobile phone, Ipod, iPad, laptop, navigator, MP3, MP4, mobile power, game console, music player, etc. with USB interface digital Electronic product charging.

YJ-DS2011B



1A Single USB

Input: DC12-24V
 USB output: 5V 1A
 Material: PA+hardware
 Product Size: 37*29*53mm
 USB output selection: 1A/QC3.0
 Light color: RD/BU/WH/GN/OG

YJ-DS2015B



Laser 2.1A Single USB

Input: DC12-24V
 USB output: 5V 2.1A
 Material: ABS+hardware
 Product Size: 37*29*53mm
 USB output selection: 3.1A/QC3.0
 Light color: RD/BU/WH/GN/OG

YJ-DS2021B-1



2.1A Single USB

Input: DC12-24V
 USB output: 5V 2.1A
 Material: ABS/PA+hardware
 Product Size: 37*29*53mm
 Light color: RD/BU
 Shell color: BK/WH

YJ-DS2063



Round type-C 24Pin
 Single USB Socket

Product Size: 45*36*29mm
 Light color: BU

YJ-DS2059



New PD65W Super
 Quick-Charger

Product Size: 50.2*36.6*36.6mm
 Light color: BU

YJ-DS2057B



QC3.0 Quick Charge
 Single USB

Product Size: 37*43*29mm
 Light color: BU

YJ-DS2013B



3.1A Dual USB

Input: DC12-24V
 USB output: 5V 3.1A
 Material: PA+hardware
 Product Size: 37*29*53mm
 USB output selection: 3.1A/4.2A
 Light color: RD/BU/WH/GN/OG

YJ-DS2014B



4.2A Dual USB

Input: DC12-24V
 USB output: 5V 4.2A
 Material: PA+hardware
 Product Size: 37*29*53mm
 USB output selection: 3.1A/4.2A
 Light color: RD/BU/WH/GN/OG

YJ-DS2016B



Laser 3.1A Dual
 USB

Input: DC12-24V
 USB output: 5V 3.1A
 Material: ABS+hardware
 Product Size: 37*29*53mm
 USB output selection: 3.1A/4.2A/QC3.0
 Light color: RD/BU/WH/GN/OG

YJ-DS2018BK



Laser 4.8A Dual
 USB

Input: DC12-24V
 USB output: 5V 4.8A
 Material: ABS+hardware
 Product Size: 37*29*53mm
 USB output selection: 3.1A/QC3.0
 Light color: RD/BU/WH/GN/OG

YJ-DS2020B

Laser 2.4A+QC3.0

Input: DC12-24V
USB output: 5V 2.4A
Material: ABS+hardware
Product Size: 37*29*53mm
Light color: RD/BU/WH/GN/OG



YJ-DS2018B

Laser 4.8A

Input: DC12-24V
USB output: 5V 4.8A
Material: ABS+hardware
Product Size: 37*29*53mm
USB output selection: 3.1A/QC3.0
Light color: RD/BU/WH/GN/OG

YJ-DS2048B-1

3.1A Dual USB

Input: DC12-24V
USB output: 5V 3.1A
Material: plastic+hardware
Product Size: 37*29*53mm
Light color: GY/BK

YJ-DS2050

Elastic cover Dual USB(long)

Input: DC12-24V
USB output: 5V 4.2A
Material: plastic+hardware
Product Size: 37*29*53mm
USB output selection: 3.1A/4.2A
Light color: BU

YJ-DS2017B

Laser 4.2A Dual USB

Input: DC12-24V
USB output: 5V 4.2A
Material: ABS+hardware
Product Size: 37*29*53mm
USB output selection: 3.1A/QC3.0
Light color: RD/BU/WH/GN/OG

YJ-DS2023B

4.2A round white usb charger with blue led

Input: DC12-24V
USB output: 5V 4.2A
Material: ABS/PA+hardware
Product Size: 37*29*53mm
USB output selection: 3.1A/4.2A
Light color: RD/BU
Shell color: BK/WH

YJ-DS2072B

3A Dual USB

Product Size: 50*37*29mm
Light color: BU

YJ-DS2043B

QC3.0+QC4.0(Round)

Product Size: 55*36mm

YJ-DS2025B

3.1A Square White

Input: DC12-24V
USB output: 5V 3.1A
Material: PA+hardware
Product Size: 37*29*53mm
USB output selection: 3.1A/4.2A
Light color: BK/WH

YJ-DS2027B

Round Flat 4.2A Dual USB

Input: DC12-24V
USB output: DC5V 4.2A
Voltage test range: 5V-30V
Material: ABS+hardware
Product Size: 37*29*53mm
Light color: RD/BU/GN

YJ-DS2058B-3

QC3.0+PD(plastic)

Product Size: 50*36.8*28.5mm
Light color: BU

YJ-DS2056B

Dual USB (Cabochon Blue)

Product Size: 60*50*50mm
Light color: BU

YJ-DS2032B

Cabochon Single QC3.0

Input: DC12-24V
USB QC3.0 output: 5V 3A/DC9V 2A/
DC12V 1.5A
Voltage test range: 5V-30V
Material: ABS/Aluminum alloy
Product Size: 37*29*53mm
Light color: RD/BU/GN

YJ-DS20330B

QC3.0+TYPE-C+PD

Input: DC12-24V
USB QC3.0 output: 5V 3A/DC9V 2A/
DC12V 1.5A
Voltage test range: 5V-30V
Material: ABS/Aluminum alloy
Product Size: 37*29*53mm
Light color: RD/BU/GN

YJ-DS2071

4.8A Dual USB

Product Size: 53*29*37mm

YJ-DS2061B

2.1A Single USB

Product Size: 37x48x29mm

YJ-DS2070

3.1A Dual USB

Input: DC12-24V
USB output: DC5V 3.1A
Material: ABS+hardware
Product Size: 37*29*53mm
USB output selection: 3.1A/4.2A/QC3.0
Shell color: BK/WH
Light color: RD/BU

YJ-DS2070-1

3.1A Dual USB(white)

Input: DC12-24V
USB output: DC5V 3.1A
Material: ABS+hardware
Product Size: 37*29*53mm
USB output selection: 3.1A/4.2A/QC3.0
Shell color: BK/WH
Light color: RD/BU

YJ-DS2062B

2.4A+PD Single USB

Product Size: 37*28*41mm
Light color: BU

YJ-DS2068

Audio Car Charger

Product Size: 37*43mm
Wire length: 60CM



YJ-DS2066

USB+AUX
(Round Single)

Product Size: 37*43mm
Light color: BU



YJ-DS2036GB

QC3.0 Dual USB
(green core)

Product Size: 50*37*29mm
Light color: BU



YJ-DS2035B

PD QC3.0+Single USB
+Type-C

Product Size: 54.5*36.8*28.8mm



YJ-DS2045B

QC3.0 Dual PD
+USB

Product Size: 50*37*29mm
Light color: BU



YJ-DS2030B-1

3.1A Dual USB+Volt

Product Size: 46*25*45mm
Light color: BU



YJ-DS2031B-1

4.2A Dual USB+Volt

Product Size: 50*37*29mm
Light color: BU



YJ-DS2040B

QC3.0 USB+Volt
+Switch

Product Size: 41.7*28.7mm
Light color: BU



YJ-DS2123

Al alloy QC3.0
+3.1A USB(3 Holes)

Input: DC12-24V
USB QC3.0 output: 5V 3A/DC9V 2A/
12V 1.5A
USB output: DC5V 3.1A
Material: aluminum alloy+hardware
Product Size: 37*29*53mm



YJ-DS2030B

4.2A Dual USB+Volt

Product Size: 45*36*29mm
Light color: BU



YJ-DS2031B

4.2A Dual USB+Volt

Product Size: 37x43x29mm
Light color: BU



YJ-DS2045B-1

Dual QC3.0+PD USB
Switch

Product Size: 50*37*29mm
Light color: BU



YJ-DS2058B-1

QC3.0+PD+Volt
+Switch

Product Size: 51*37*28mm



YJ-DS2029B

4.2A Dual USB+Volt
(Round flat)

Product Size: 50*37*29mm
Light color: BU



YJ-DS2077B

PD 65W USB(Plastic)

Product Size: 50*37*29mm
Light color: BU



YJ-DS2040B-1

QC3.0 USB+Volt
+Switch(plastic)

Product Size: 50*32mm
Light color: BU



YJ-DS4020B

QC3.0 USB Charger
Digital Voltmeter
Ammeter

Product Size: 37*29*53mm
Light color: RD/BU/WH/GN/OG



YJ-DS2047B

4.8A Dual USB+Volt
+Smart touch

Product Size: 50*37*29mm
Light color: BU



YJ-DS2058B-2

QC3.0+PD Switch
(half-thread)

Product Size: 50*36.8*28.5mm
Light color: BU



YJ-DS2044B

Dual QC4.0

Light color: RD



YJ-DS2044B-1

Dual QC5.0 USB charger(long)

Light color: BU



YJ-DS2076

QC4.0+PD QC4.0 (Oval)

Product Size: 37x43x29mm
Light color: BU



YJ-QT037-2

QC3.0+PD(Oval)

Product Size: 80*60*20mm
Light color: BU



YJ-DS2043B

QC3.0+QC4.0

Light color: BU



YJ-DS2043-5

QC3.0+QC5.0

Light color: BU



YJ-MCA035B

4.8A Dual USB
+Fuse Box(Oval short)

Product Size: 64*46*15mm
Light color: BU



YJ-QT037-3

QC3.0+PD (Square)

Product Size: 64*46*15mm
Light color: BU



YJ-DS2304B

3.1A Mini Dual USB
(Switch type)

Input: DC12-24V
USB output: DC5V 3.1A
Material: plastic+hardware
Product Size: 47*30mm
USB output selection: 3.1A/4.2A
Light color: RD/BU/GN



YJ-DS2305B

3.1A Mini Dual USB
+Volt(Switch type)

Input: DC12-24V
USB output: DC5V 3.1A
Voltage test range: 5V-30V
Material: plastic+hardware
Product Size: 47*30mm
USB output selection: 3.1A/4.2A
Light color: RD/BU/GN



YJ-QT084

QC3.0+PD
+Automatic with LED

Light color: BU



YJ-QT302

LED Dual USB Plug

Light color: BU

METAL USB >>>



YJ-DS2302B

4.2A Dual USB
(Switch type)

Input: DC12-24V
USB output: DC5V 4.2A
Material: ABS+hardware
Product Size: 25.4*53.4*50.8mm
USB output selection: 3.1A/4.2A/
4.8A/QC3.0
Light color: RD/BU/GN/WH/OG



YJ-DS2313R

2.1A Single USB
+AUX(Square)

Input: DC12-24V
USB output: DC5V 2.1A
Material: ABS+hardware
Audio: 3.5mm/4 pole audio plug
Hole size: 21.2 x 37.2mm



YJ-DS2111

4.8A+Metal USB+Volt

Product Size: 50*32mm
Light color: RD



YJ-DS2112B

Dual QC3.0+PD
(Al alloy)

Product Size: 37*43*29mm
Light color: BU



YJ-DS2311B

Dual QC3.0+Volt
(Switch type)

Input: DC12-24V
USB QC3.0 output: 5V 3A/DC9V 2A/
DC12V 1.5A
Voltage test range: 5V-30V
Material: ABS+hardware
Product Size: 35.8*21*37mm
USB output selection: 3.1A/4.2A/4.8A/QC3.0
Light color: RD/BU/GN/WH/OG



YJ-DS2312B

switch style PD +QC3.0
with voltmeter



YJ-DS2102BB

Dual QC3.0+Dual USB

Product Size: 37x43x29mm
Light color: BU



YJ-DS2114B

2.4A USB+QC3.0+Volt

Product Size: 51*37*29mm
Light color: BU

YJ-DS2102HB

Dual QC3.0 USB



Input: DC12-24V
USB QC3.0 output: 5V 3A/DC9V 2A/
DC12V 1.5A
Material: aluminum alloy+hardware
Product Size: 37*29*53mm
Light color: RD/BU/GN
Shell color: RD/BU/GD/BK

YJ-DS2104BR

QC3.0 Dual USB+Volt



Input: DC12-24V
USB QC3.0 output: 5V 3A/DC9V 2A/
DC12V 1.5A
Voltage test range: 5V-30V
Material: aluminum alloy+hardware
Product Size: 37*29*53mm
Shell color: RD/BU/BK
Light color: RD/BU/GN

YJ-DS2118BB

QC3.0+Type-C+Volt



Product Size: 30*30*50mm
Light color: BU

YJ-DS2055

QC3.0+2PD+USB
(metal)



Product Size: 36.5*43mm

YJ-DS2108RR

4.2A Dual USB+Volt



Input: DC12-24V
USB output: 5V 4.2A
Voltage test range: 5V-30V
Material: aluminum alloy+hardware
Product Size: 37*29*53mm
USB output selection: 3.1A/4.2A/QC3.0
Shell color: RD/BU/GD/BK
Light color: RD/BU/GN

YJ-DS2119JB

4.2A Dual USB



Input: DC12-24V
USB output: 5V 4.2A
Material: aluminum alloy+hardware
Product Size: 37*29*53mm
USB output selection: 3.1A/4.2A/QC3.0
Shell color: RD/BU/GD/BK
Light color: RD/BU/WH/GN/OG

YJ-DS2054

Dual QC3.0 3 Holes
USB(metal)



Product Size: 37*68mm
USB output: 5V/3A 9V/2A 12V/1.5A

YJ-DS2110

Al alloy QC3.0
(3 Holes)



Product Size: 37*37*68mm

YJ-DS2112BB

Dual QC3.0+PD



Product Size: 37*43*29mm
Light color: RD

YJ-DS2105RB

QC3.0 Dual USB
+Volt



Product Size: 54.5*36.8mm
Light color: BU

YJ-DS2115

QC3.0+3.1A(3 Holes)



Product Size: 37*51mm

YJ-DS2121

90W Dual PD+Voltmeter
Charger with Switch(Alu)



Input: DC12-24V
USB output: 5V 2.1A
Material: aluminum+hardware
Product Size: 37*29*53mm
Light color: RD/BU/GD
Shell color: BK

YJ-DS2106R

2.4A USB+QC3.0
+Volt



Product Size: 51*37*29mm
Light color: RD

YJ-DS2103HB

QC3.0 Dual USB
+Volt



Product Size: 49*37*29mm
Light color: BU

YJ-DS2121-1

45W PD+QC18W+Voltmeter
Button Switch(Alu)



Input: DC12-24V
USB output: 5V 2.1A
Material: aluminum+hardware
Product Size: 37*29*53mm
Light color: RD/BU/GD
Shell color: BK

YJ-DS2116HB

New PD QC3.0 USB
+Volt



Input: DC12-24V
Hole Size: 29mm
Light color: BU

YJ-DS2120B

Al alloy QC3.0 +Volt+Switch



Input: 12-24V
Material: Al alloy+Copper
Weight: 30g
Output: 5V-6.5V/3A,9V/2A,12V/1.5A

DIGITAL DISPLAY VOLTMETER SERIES



YJ-DS4012B Glossy Voltmeter

Voltage test range: 5V-30V
Material: ABS+hardware
Product Size: 37*29*31mm
Light color: RD/BU/WH/GN/OG
Shell color: BK/WH

Intelligent digital display, real-time monitoring
High-quality onboard voltmeter

This is a high-quality voltmeter for checking the state of your battery and battery charger.

The voltmeter and USB fast-charge function is your best choice.



YJ-DS4010B
DC Voltmeter

Input: DC12-24V
Output: 5V
Voltage test range: 5V-30V
Material: PA+hardware
Product Size: 37*29*26mm
Light color: RD/BU/WH/GN/OG
Shell color: BK/WH



YJ-DS4011B
New Smart Touch
Voltmeter

Input: DC12-24V
Output: 5V
Voltage test range: 5V-30V
Material: ABS+hardware
Product Size: 37*29*31mm
Light color: RD/BU/WH/GN/OG



YJ-DS4038B
°F Thermometer

Input: DC12-24V
Temperature measurement range:
-50°C~70°C accuracy ±1°C,
resolution 0.1°C(0.2°F), resolution 1%
Humidity measurement range: 10%~99%,
accuracy ±5%
Operating temperature: -10 ~ +60°C
Material: ABS+hardware
Product Size: 37*29*31mm
Line length: 1 meter



YJ-DS4039G
°C Thermometer

Size: 37*37*17mm
Light color: GN



YJ-DS4015
12V Color Screen
Voltmeter

Input: DC12V
Output: 5V-15V
Voltage test range: 5V-30V
Material: ABS/Aluminum alloy
Product Size: 37*29*40mm
Shell color: GN/SR/BK
(Aluminum alloy)



YJ-DS4016
24V Color Screen
Voltmeter

Input: DC24V
Output: 5V-30V
Voltage test range: 5V-30V
Material: ABS/Aluminum alloy
Product Size: 37*29*40mm
Shell color: GN/SR/BK
(Aluminum alloy)



YJ-DS4043R
Thermometer
+Voltage(°F)

Light color: RD



YJ-DS4019B
Voltmeter+Ammeter

Size: 37*29*15mm
Light color: BU



YJ-DS4017
36V Color Screen
Voltmeter

Input: DC36V
Output: 5V-30V
Voltage test range: 5V-30V
Material: ABS/Aluminum alloy
Product Size: 37*29*40mm
Shell color: GN/SR/BK
(Aluminum alloy)



YJ-DS4041
Voltmeter

Size: 52*56*84mm



YJ-DS4052
Thermometer
+Voltmeter(Short)

Size: 36*24*27mm
Light color: RD



YJ-DS4054
12-24V Tri-Color
Voltmeter

Size: 41*37*29mm



YJ-DS4061
12-24V Color Screen
Voltmeter

Material: ABS
Size: 37*42*29mm



YJ-DS4013B
Round Transparent
Voltmeter

Input: 12-24V
Output: 30V
Light color: BU
Size: 36.5*27mm



YJ-DS4016-2
QC3.0 Color screen voltmeter

Input: DC12-24V
Operating voltage: DC5~15V
USB QC3.0 output: 5V 3A/9V 2A/
2V 1.5A
Material: plastic+hardware
Power switch: ON-OFF
Product Size: 37*29*51mm



YJ-DS4021B
Dual Voltmeter-Round

Input: DC12-24V
Voltage test range: 5V-30V
Material: ABS+hardware
Product Size: 37*29*52mm
Light color: RD/BU/GN



YJ-DS4020B
Digital Ammeter/
Voltmeter QC3.0
USB Socket

Size: 50*35mm
Light color: BU



YJ-DS4015-3
24V Metal Color Screen
Voltmeter(Gold case)

Size: 40.5*37*30mm



YJ-DS4023RB
2-in-1 TEM°C
Voltmeter

Input: DC12-24V
USB output: 5V 2.1A
Voltage test range: 5V-30V
Temperature measurement range:
-10+80°C
Material: plastic+hardware
Product Size: Approx.67*47mm(H*D)
Light color: RD+BU/RD+GN/RD+RD



YJ-DS4024RB
3-in-1 TEM°C
Voltmeter

Input: DC12-24V
USB output: 5V 2.1A
Voltage test range: 5V-30V
Temperature measurement range:-10+80°C
Material: plastic+hardware
Product Size: Approx.67*47mm(H*D)
Light color: RD+BU/RD+GN/RD+RD



YJ-DS4010B-1
DC 12-24V Voltmeter
-Short

Input: DC12-24V
Output: 5V
Voltage test range: 5V-30V
Material: PA/ABS+hardware
Product Size: 37*29*51mm
Light color: RD/BU/WH/GN/OG



YJ-DS4018B
Round Voltmeter
+Ammeter

Input: DC12-24V
Voltage test range: 5V-30V
Ammeter measuring range: 0-10A
Material: ABS+hardware
Product Size: 37*29*51mm
Light color: RD/BU/WH/GN/OG



YJ-DS4025B
4-in-1 Car Charger
(TEM°F)

Size: 78*40*30mm
Light color: BU



YJ-DS4042B
5-in-1 Car Charger

Size: 76*44*37mm
Light color: BU



YJ-DS4046B
Celsins TEM°C
Voltmeter

Light color: BU



YJ-DS4050
Waterproof Square
Voltmeter

Size: 49*26*18mm
Hole size: 46*22mm
Light color: GN



YJ-DS4030
2-in-1 TEM°C
Voltmeter(Motorcycle)

Input: DC12V
Voltage test range: 8V-30V
Temperature measurement range:
0~99°C
USB output: 5V 3A
Operating temperature:-10 ~ +60°C
Material: ABS+hardware
Product Size: 50*42*21mm



YJ-DS4053B
Car Voltmeter

Size: 70*40*30mm
Light color: BU



YJ-DS4027
Square Volt.V
Ammeter with Shunt

Operating voltage: DC 0~100V/0-50A
(require external shunt)
Measuring accuracy: 1%(±1 digit)
Operating temperature:-10 to 65°C
Material: plastic+hardware
Product Size: 48*29*22mm
Light color: RD+BU/RD+GN/RD+RD



YJ-DS4051
IMP Liquid Crystal
Tube Volt.V(Ultra-thin)

Size: 56*28*10mm
Light color: BU



YJ-DS4028B
Dual Voltmeter Switch
Style

Input: DC12-24V
Voltage test range: 5V-30V
Material: ABS+hardware
Product Size: 40*20*38mm
Light color: RD/BU/GN



YJ-DS4045
Indicator-Light
Voltmeter

Size: 52x52mm



YJ-DS4031-1
RL-BI002 Meter

Size: 60*49mm
Light color: RD/YE/GN



YJ-DS4031-2
YJ-BI004 Meter

Size: 60*49mm
Light color: RD/YE/GN



YJ-DS4047B
0.56 LED Digital
Voltmeter(Blue)

Size: 37*29*15mm
Light color: BU



YJ-DS4048R
Square Voltmeter
(Red)

Size: 48*29*21mm
Light color: RD



YJ-DS4029-1
12V-24V Square Meter

Size: 53*34*24mm



YJ-DS4031
BI001-Battery Meter

Size: 53*34*24mm



YJ-DS4026BR
Square Volt.V
+Ammeter(A)

Operating voltage: DC 5~30V
Measuring range: DC 0-100V 0-10A,
accuracy: 1%(±1 digit)
Operating temperature:-15 to 65°C
Material: plastic+hardware
Product Size: 48*29*22mm
Light color: RD+BU/RD+GN/RD+RD



YJ-DS4037RB
Square Volt.V
+Ammeter(mA)

Size: 45.2*25.8*15mm
Light color: RD+BU



YJ-DS4029
LED Square Ammeter

Size: 53*34*24mm



YJ-DS4032
Battery Meter

Size: 42*33.5*11mm
Light color: GN



YJ-DS4049
Voltmeter+Battery
Indicator

Size: 61*33*15mm



YJ-DS4036
Voltmeter+Battery
Indicator

Size: 61.5*33.5*13.5mm



YJ-DS4034
24V Voltmeter
+Battery Meter

Size: 48*29*22mm
Light color: RD



YJ-DS4034-1
12V Voltmeter
+Battery Meter

Size: 40*25*23mm
Light color: RD



POWER SOCKET CIGARETTE LIGHTER SOCKET SERIES



Supports charging of in-vehicle devices such as navigation devices, electronic dogs, event data recorder USB devices, etc.

YJ-WC05B-1



YJ-DS1011

12V Copper Power Socket

Input: DC 12-24V

Output: 120W

Material: ABS+Copper

Hole size: 29mm(Dia)

Size: 37*37*56mm



YJ-DS1021

12V 120W Charger
(Square black)



Input: DC 12V
Output power: 120W
MAX Amps: 10A
Material: ABS+Copper
Size: 52*52mm

YJ-DS1015

EU Power Socket



Input: DC 12-24V
Output: 5V/5A/120W
Material: ABS+Copper
Hole size: 29mm(Dia)
Size: 37*40mm

YJ-DS1012

12V Power Socket
(Iron)



Input: DC 12-24V
Output: 5V/3.1A/120W
Material: ABS+Copper
Hole size: 29mm(Dia)
Size: 37*37*56mm

YJ-DS1011B

12V Power Socket
with LED



Input: DC 12-24V
Output: 5V
MAX Amps: 12V15A/24V10A
Maximum power: 240W
Material: ABS+Copper
Hole size: 29mm(Dia)
Size: 37*37*56mm
Light color: B G R

YJ-DS1014

Fridge Socket



Input: DC 12-24V
Output: 12V/10A/180W
Material: ABS+Copper
Size: 21*40mm

YJ-DS1013

12V Copper Power
Socket



Input: DC 12-24V
MAX Amps: 12V20A/24V10A
Output: 5V
Material: ABS+Copper
Hole size: 29mm(Dia)
Size: 37*56mm

YJ-DS1017

Smooth Power
Socket



Input: DC 12-24V
Output: 5V/3.1A
Material: ABS+Copper
Size: 35*53mm

YJ-DS1016

Threaded Power
Socket



Input: DC 12-24V
Output: 12-24V/20A/240W
Material: ABS+Copper

YJ-DS1018

Clamshell Power
Socket



Input: DC 12V
MAX Amps: 10A
Maximum power: 120W
Material: ABS+Copper
Hole size: 25mm(Dia)

YJ-DS1020

Din-Socket



Input: DC 12-24V
Output: 5V
MAX Amps: 12V20A/24V10A
Maximum power: 300W
Material: ABS+Copper
Hole size: 16mm(Dia)
Size: 24*24*41mm

ROCKER SWITCH SERIES

Product Introduction

Kinds of Cover



Lens Colors



Electrical Functions

A. ON-OFF	B. (ON)-OFF	C. ON-ON	D. (ON)-ON	E. ON-OFF-ON	F. (ON)-OFF-ON	G. (ON)-OFF-(ON)	H. ON-ON-ON	I. ON-ON-OFF
-----------	-------------	----------	------------	--------------	----------------	------------------	-------------	--------------

Product Size

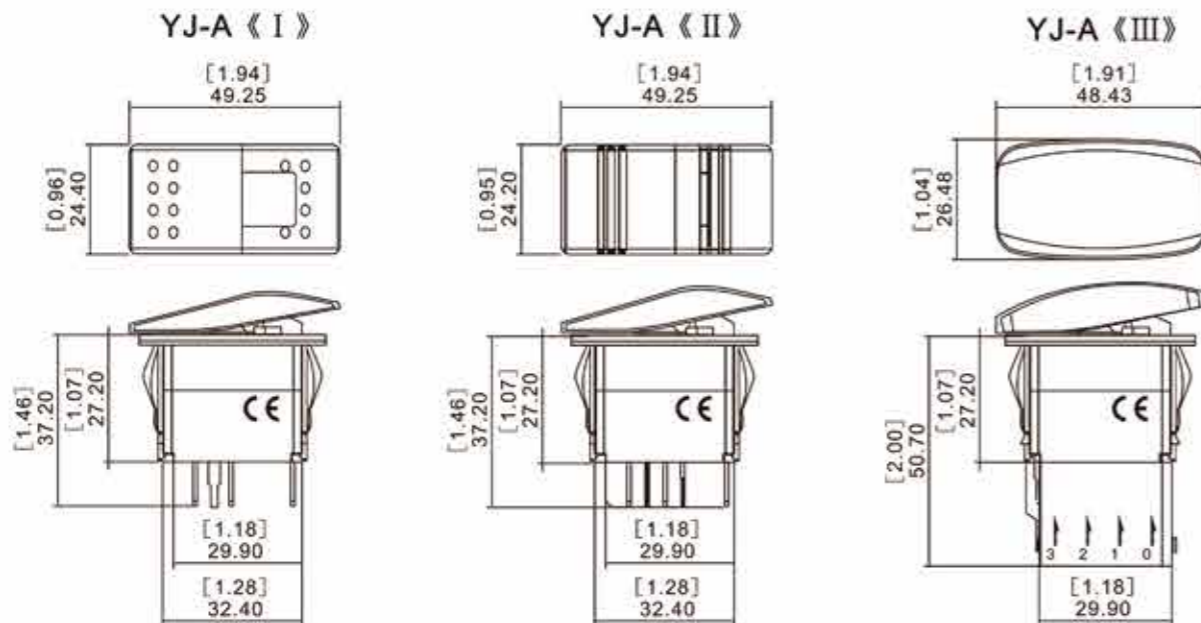

Performance Parameter



YJ-SLaser15
JEEP Light Switch
(Black)

Product Size:
47*25*37mm



YJ-SLaser15-1
JEEP Light Switch
(Red)

Product Size:
47*25*37mm



YJ-WG22
Metal Waterproof
Switch

Product Size:
48.5*24.5mm



YJ-SLaser5-41
5P ON-OFF Switch
with Yellow Button
(Blue LED)

Product Size:
49.57*24.4*49mm



YJ-SLaser5-41A
5P ON-OFF Switch
with Red Button
(Blue LED)

Product Size:
49.57*24.4*49mm



YJ-SLaser16
12PIN Switch+
Cable Socket

Product Size:
48.5*24.5mm

Product name	Switch for automobile refitting		
Product Overview			
LED Light	Red	DC maximum voltage	30V
Product Polarity	SPST	DC minimum voltage	3V
Switching Function	ON-OFF	Maximum contact load	AC125V/10A, 12V/20A, 24V/10A
Number of Terminals	Five	Break load maximum contact	DC 1500V 1 minute
Condition with lights	Double Lights	Working Cycle	5 minute 1 time
Size	49.57*24.4*49mm	Life cycle no load	20000 times
Mounting Dimensions	37.2*21.2mm	Life cycle with load	10000 times
Weight	30g	Contact Material	Copper
Maximum Continuous Load	AC 125V/10A, 12V/20V, 24V/10A	Operating temperature	+30K
Maximum load and time	DC 12V/23A, 24V/11.5A	Protection level	IP66
Minimum current load	0	Material	Environmentally friendly materials
Application	1.Cars, motorcycles, buses, ships, RV, yachts and so can be used. 2.Control all kinds of electrical equipment in the car to open or close. 3.CE certified.		
Advantages	1.Ultra-luxury high-end automotive refitting switch, with LED working indicator. 2.CE certified quality, environmental protection and flame retardant material. 3.12-24V volt car for general use, suitable for refitting all the equipment in the control car. 4.Output short circuit protection, overload protection, polarity reverse protection, multiple protection.		



EXCELLENT QUALITY OF
YUJIE ROCKER SWITCH

LASER SYMBOLS OPTION A



LASER SYMBOLS OPTION B



PRINTING SYMBOLS

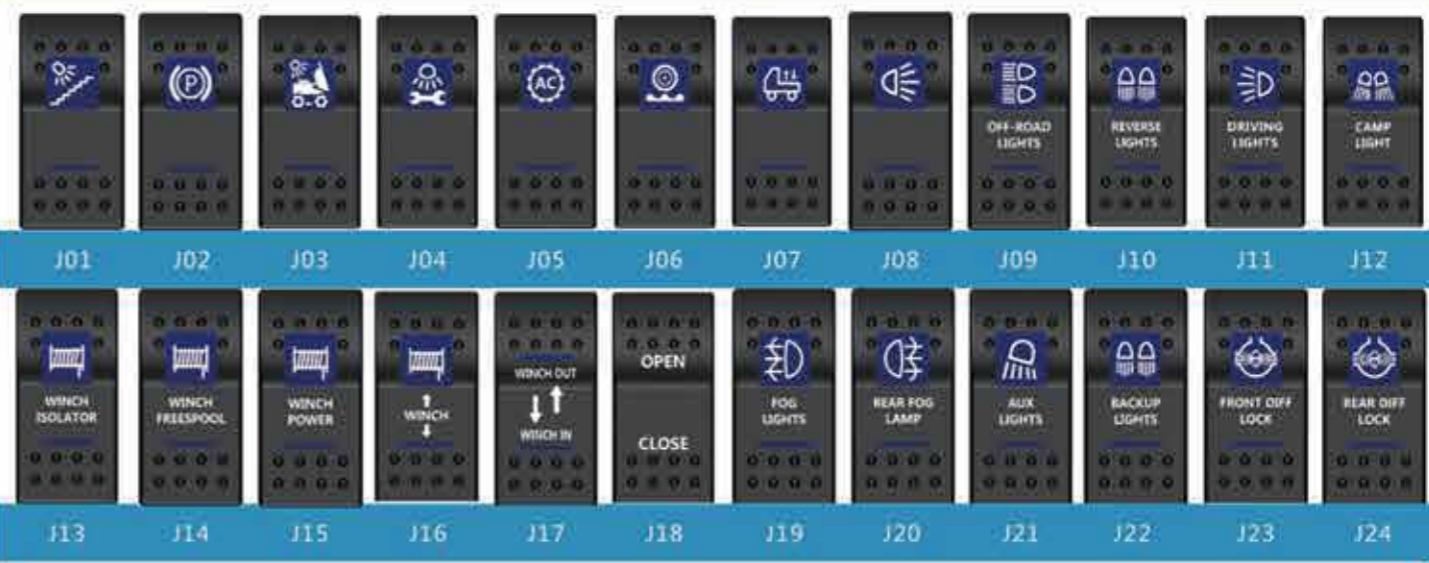

Rocker Switch >>>

YJ-WF01B / 3Pin+Light+Silk Screen

BU/OG/RD/GN



Specifications: 203K1

YJ-WF02B / 12V 3Pin+2Gears

BU/OG/RD/GN



Specifications: KCD1-602N-L

YJ-WF03B / 12V 3Pin 2Gears+Waterproof(Round)

BU/RD/GN/OG/YE



Specifications: 12V KCD-1234

YJ-WF04B / 3Pin+2Gears+Waterproof(Round+Square)

BU/OG/RD/GN



Specifications: KCD2-101NDF

YJ-WF05G / 3Pin+Light

YJ-WF06R / 12V 3Pin 2Gears+Waterproof

YJ-WF04B-1 / 3Pin 2Gears+Waterproof



OG/RD/GN
Specifications: KCD 3PIN 203K1



OG/RD/GN/BU
Specifications: 3PIN 12V KCD-1234



OG/RD/GN/BU
Specifications: 3PIN 12V

YJ-WH07 / 3Pin 3Gears+Waterproof

YJ-WH10 / 3Gears with On-Off-On

YJ-WH08 / 2Pin Switch



BK
Specifications: KCD1



BK
Specifications: 3Pin ON-OFF-ON



BK
Specifications: 2P YJ-WC01

YJ-WH13 / 2Pin Black Switch

YJ-WH14 / 2Pin+Waterproof

YJ-WH18W / 16A125V/10A 250V



BK
Specifications: YJ-011 2Pin



BK
Specifications: WCD3-5



OG/WH
Specifications: WR1-5-101D 16A 125VAC 10A 250VAC

YJ-WC01 / Round Switch

YJ-WC01R / Switch with Light

YJ-WC02R / Round Switch with Light



BK
Specifications: NO LED LIGHT



BU/RD/GN/YE



BU/RD/GN/OG/WH
Specifications: KCD1

YJ-WH16B / Oval Switch

YJ-WH24 / Grey Oval Switch

YJ-WH17B / 12V Oval+Light



OG/RD/GN/BU
Specifications: ASW-20D



GY



OG/RD/GN/BU
Specifications: ASW-20, with 12V LED

YJ-WC05B / Short Shell+Blue Light

YJ-WC05R-1 / Long Shell+Red Light

YJ-WC03 / Dual Card Switch



BU/RD/GN
Specifications: DC12-24V



BU/RD/GN



BU
Specifications: WC04

Metal Switch >>>

YJ-WH05R / 3Pin Round+Waterproof



BK
Specifications: KCD1

YJ-WH23 / 3Pin+Switch



BK
Specifications: 3Pin
ON-OFF-ON

YJ-WH47B / Switch without Light



BK
Specifications: 2P YJ-WC01
On-Off 15*10mm

YJ-WH40R / 50A Switch



Voltage: 12V-24V

Contact resistance: 50mΩ

Current: 50A

BU/RD

YJ-WH02 / ASW-20 Switch with LED



OG/RD/GN/BU
Specifications: ASW-20, with 12V LED

YJ-WH03 / Overload Protection Switch



RD

YJ-WH28B / 4Pin Boat Shape Style



OG/RD/GN/BU/WH

YJ-WG01R / 16mm Metal Switch



RD/BU/GN/WH/OG
Specifications: 16mm

YJ-WG03 / Metal Switch



NO LED LIGHT
Specifications: 16mm

YJ-WG05B / Self-Locking+Button



RD/GN/BU
Specifications: Black body+LED

YJ-WH49 / 6Pin Rocker Style



BK

YJ-WH01WB / Fog Light Switch



Specifications: ASW-17D

YE/RD/GN/BU



YJ-WG07 / 16mm Metal Switch



BU
Specifications: 16mm
output: 3A-5A

YJ-WG08-2 / DC 12V On-Off Metal



BU
Specifications: DC12V 16mm ON-OFF
output: 3A-5A

YJ-WG09-2 / 22mm+Metal+Blue Led



Red body+Blue LED
Specifications: 22mm
output: 10A-15A

YJ-WH46 / 2Pin 2Gears Rocker Switch



Specifications: KCD117-2P-H
250V 10A

YJ-WH46-1 / 3Pin 2Gears Rocker Switch



Specifications: KCD117-3P-H
24V 3A

YJ-WH46-2 / 4Pin 2Gears Rocker Switch



Specifications: KCD117-4P-H
24V 3A

YJ-WG14R / Metal Switch



Black Case
Size: 28.5*22.3mm



Silver Case



Golden Case

LED Color: OG/RD/GN/BU/YE

YJ-SLaser18 / Small 5Pin Rocker Switch



Product Size: 32*16*30.5mm

YJ-WH45 / 6Pin 3Gears Rocker Switch



Specifications: KCD4

YJ-WG17R / 5Pin+Pull Silk+Metal



Black Case
Specifications: 5PIN ON-OFF
Size: 43.55*43*24.8mm



Silver Case



Golden Case

LED Color: YE/RD/GN/BU

Flip Switch >>>

YJ-WD006B / 12V 20A Rocker Style Switch BU/GN/RD/OG/VT/WH/GY



Specifications: 12V 20A

YJ-WD012R / 12V 20A Rocker Style Switch RD/BU/BK/YE/GN



Specifications: 12V/20A/NO LED LIGHT

YJ-WD015 / Single Pole Switch



Specifications:
T701AT ON-OFF

Specifications:
T701FT (ON)-OFF

Specifications:
T701CT ON-OFF-ON

Specifications:
T701MT (ON)-OFF-(ON)

YJ-WD013R / Rocker with On-Off



RD/BU
Specifications: ASW-13D

YJ-WD019 / 9Pin+2Gears+M6 Thread



Specifications: 9Pin 2Gears M6

YJ-WD002 / ASW-07D-2/R Switch



Specifications: ASW-07D-2/R

YJ-WD003 / ASW-15D/BL+3Pin Switch



Specifications: ASW-15D/BL

YJ-WD005B / Rocker Switch Base



BU/GN/RD/WH/VT/OG

YJ-WD004 / Metal Handle+On-Off



BK

YJ-WD008 / 20A 250V Rocker



Specifications: 20A 250VAC

YJ-WD010 / 19mm+Blue LED



Red body+Blue LED
Specifications: 19mm

YJ-WD007 / Rocker without LED



NO LED LIGHT

YJ-WD014 / Rocker with On-Off-Off



NO LED LIGHT

YJ-WD020 / Rocker with On-Off



NO LED LIGHT

YJ-WD017 / Two Gears



NO LED LIGHT

Other Switch >>>

YJ-WH60 / Alu Switch



BK
Specifications: ASW-30

YJ-WH65R / 2Pin+Waterproof



BK
Specifications: 12V/20A

YJ-WH15 / 16A 125V+10A 250V Switch



OG/WH
Specifications: WR1-5-101D 16A
125VAC 10A 250VAC

SWITCH PANEL EMPTY PANEL



YJ-MB036

Three-Hole Rear Panel

Material: ABS
Size: 150*43*5mm
Hole size: 29mm



YJ-MB036-1

Three-Hole Front Panel

Material: ABS
Size: 105*87*5mm
Hole size: 29mm



YJ-MB041

Four-Hole Rear Panel

Material: ABS
Size: 196*43*5mm
Hole size: 29mm



YJ-MB014-1

One-Hole Rear Panel

Material: ABS
Size: 61*43*5mm
Hole size: 29mm



YJ-MB013

2 hole convex panel (black)

Front
Material: ABS
Size: 104*45*5mm
Hole size: 34mm



YJ-MB038-2

4-Gang with Overload Plastic Plate

Material: Plastic
Size: 131*90*15mm
Optional: 4Gang/6Gang/8Gang



YJ-MB049

6-Gang Plastic Plate with Light

Material: Plastic
Optional: 4Gang/6Gang



YJ-MB015

Four-Hole Rear Panel

Material: ABS
Size: 105*87*5mm
Hole size: 29mm



YJ-MB012

Two-Hole Panel

Rear
Material: ABS
Size: 104*45*5mm
Hole size: 34mm



YJ-MB038-4

6-Gang with Overload Plastic Plate

Material: Plastic
Size: 183*120*15mm
Optional: 4Gang/6Gang/8Gang



YJ-MB037-4

4-Gang Plastic Protector

Material: Plastic
Size: 130*100mm
Optional: 4Gang/6Gang



YJ-BS014-3

3 Gang Panel Housing Holder

Material: Plastic
Inner size: 21*37*40mm
Optional: 2Gang/3Gang/
4Gang/5Gang/6Gang



YJ-BS014-5

5 Gang Panel Housing Holder

Material: Plastic
Inner size: 85*60mm
Optional: 2Gang/3Gang/
4Gang/5Gang/6Gang



YJ-LB025

2-Gang 3-Hole Alu Plate

Material: Aluminium
Size: 98*110*3mm



YJ-LB026

6-Gang 1-Hole Alu Plate

Material: Aluminium
Size: 223*68*3mm
Optional: 2Gang/4Gang/6Gang

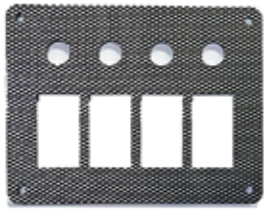

YJ-LB011

Contura Switch and Breaker Panel Blanks (4Positions, 1 Row)

Material: Aluminium
Size: 130*100*3mm



YJ-LB016A

Aluminum 3 Gang Rocker Switch Frame Mount Bracket

Material: Aluminium
Size: 98*68*3mm
Optional: 2Gang/3Gang/
4Gang/5Gang/6Gang/8Gang

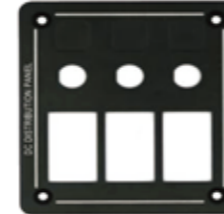

YJ-LB031

3-Gang Relay Alu Plate

Material: Aluminium
Size: 97*114*3mm
Optional: 3Gang/4Gang/
6Gang/8Gang

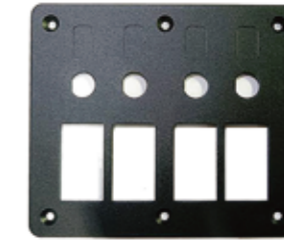

YJ-LB033

4-Gang Alu Plate +Protector

Material: Aluminium
Size: 134*114*3mm
Optional: 3Gang/4Gang/
6Gang/8Gang



YJ-LB017A

Aluminum 4 Gang Rocker Switch Frame Mount Bracket

Material: Aluminium
Size: 127*68*3mm
Optional: 2Gang/3Gang/
4Gang/5Gang/6Gang/8Gang



YJ-LB022

Flip Dash 4 Gang Switch Panel with USB Ports

Material: Aluminium
Size: 198*92*3mm

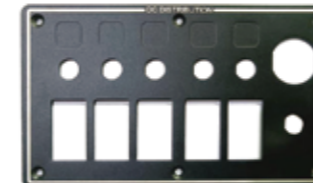

YJ-LB034

5-Gang Switch with Protector +DS

Material: Aluminium
Size: 190*114*3mm
Optional: 6Gang/8Gang

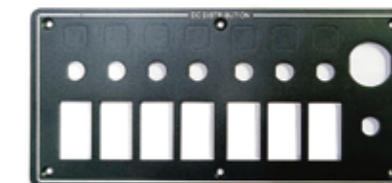

YJ-LB039

7-Gang Switch with Protector

Material: Aluminium
Size: 240*114*3mm
Optional: 5Gang/8Gang

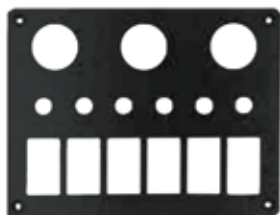

YJ-LB023A

6 Gang Aluminum Blank Dash Board (6 Positions, 2 Rows)

Material: Aluminium
Size: 180*140*3mm



YJ-LB024A

6 Gang Aluminum Blank Dash Board (6 Positions, 1 Row)

Material: Aluminium
Size: 180*110*3mm



YJ-LB043

5-Gang Switch with Protector+Digital

Material: Aluminium
Size: 240*114*3mm
Optional: 5Gang/8Gang

YJ-LB018A

5-Gang Alu Plate

Material: Aluminium
Size: 68*154mm



YJ-LB019A

6-Gang Alu Plate

Material: Plastic
Size: 68*180mm



YJ-LB061

5 Way 3 Hole Alu
Switch Panel

Material: Aluminium
Size: 110*154mm



YJ-LB046

4 Way 2 Hole Alu
Switch Panel

Material: Aluminium
Size: 120*129mm



YJ-LB095

7 hole single Alu
panel

Material: Aluminium
Size: 68*202mm



YJ-LB063A

8 hole Alu panel

Material: Aluminium
Size: 68*232mm



YJ-LB049

7 Way 3 Hole Alu
Switch Panel

Material: Aluminium
Size: 110*206mm



YJ-LB056B

6 way 3 hole Alu
switch panel

Material: Aluminium
Size: 107*175mm

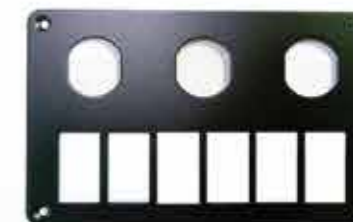

YJ-LB047

10-Gang+DS+Digital

Material: Aluminium
Size: 219*180*3mm



SWITCH PANEL SERIES

SWITCH PANEL ALUMINUM PANEL



We can customize a variety of combination panels to meet your needs.

YJ-SPA023

Aluminum Rocker Switch Panel

- Input: DC12-24V
- MAX Amps: 12V20A/24V10A
- Output: 5V 3.1A/9V 2A/12V 1.5A
- Material: ABS+Aluminium
- Light color: BU RD GN WH OG



YJ-SPA046

Alu Panel with Protector



Input: DC12-24V
MAX Amps: 12V20A/24V10A
Material: ABS+Aluminium
Light color: BU RD GN WH OG

YJ-SPA045

1 Gang Switch with Fuse



Input: DC12-24V
MAX Amps: 12V20A/24V10A
Material: ABS+Aluminium

YJ-SPA001

Alu Switch Panel



Input: DC12-24V
MAX Amps: 12V20A/24V10A
Material: ABS+Aluminium
Light color: BU RD GN WH OG

YJ-SPA002

2 Gang Alu Panel



Input: DC12-24V
MAX Amps: 12V20A/24V10A
Material: ABS+Aluminium
Light color: BU RD GN WH OG

Follow your heart with a variety of choices.

YJ-SPA003

3 Gang Alu Panel



Input: DC12-24V
MAX Amps: 12V20A/24V10A
Material: ABS+Aluminium
Light color: BU RD GN WH OG

YJ-SPA004

4 Gang Alu Panel



Input: DC12-24V
MAX Amps: 12V20A/24V10A
Material: ABS+Aluminium
Light color: BU RD GN WH OG

YJ-SPA016

3 Gang+2 Hole Alu Panel



Input: DC12-24V
MAX Amps: 12V20A/24V10A
Material: ABS+Aluminium
Light color: BU RD GN WH OG

YJ-SPA017

4 Gang+2 Hole Alu Panel



Input: DC12-24V
MAX Amps: 12V20A/24V10A
Material: ABS+Aluminium
Light color: BU RD GN WH OG

YJ-SPA005

5 Gang Alu Panel



Input: DC12-24V
MAX Amps: 12V20A/24V10A
Material: ABS+Aluminium
Light color: BU RD GN WH OG

YJ-SPA006

6 Gang Alu Panel



Input: DC12-24V
MAX Amps: 12V20A/24V10A
Material: ABS+Aluminium
Light color: BU RD GN WH OG

YJ-SPA019

4 Gang 3 Hole Alu Panel



Input: DC12-24V
MAX Amps: 12V20A/24V10A
Output: 5V/3.1A
Material: ABS+Aluminium
Light color: BU RD GN WH OG

YJ-SPA019-1

6 Gang 3 Hole +Relay



Input: DC12-24V
MAX Amps: 12V20A/24V10A
Output: 5V/3.1A
Material: ABS+Aluminium
Light color: BU RD GN WH OG

YJ-SPA008

8 Gang Alu Panel



Input: DC12-24V
MAX Amps: 12V20A/24V10A
Material: ABS+Aluminium
Light color: BU RD GN WH OG

YJ-SPA010

3 Gang Alu Panel



Input: DC12-24V
MAX Amps: 12V20A/24V10A
Output: 5V/4.8A
Material: ABS+Aluminium
Light color: BU RD GN

YJ-SPA020

5 Gang 3 Hole Panel



Input: DC12-24V
MAX Amps: 12V20A/24V10A
Output: 5V/3.1A
Material: ABS+Aluminium
Light color: BU RD GN WH OG

YJ-SPA091

6 Gang 3 Hole Alu Panel



Input: DC12-24V
MAX Amps: 12V20A/24V10A
Output: 5V/3.1A
Material: ABS+Aluminium
Light color: BU RD GN WH OG

YJ-SPA011

4 Gang Panel



Input: DC12-24V
MAX Amps: 12V20A/24V10A
Output: 5V/4.8A
Material: ABS+Aluminium
Light color: BU RD GN

YJ-SPA012

5 Gang Alu Panel



Input: DC12-24V
MAX Amps: 12V20A/24V10A
Output: 5V/4.8A
Material: ABS+Aluminium
Light color: BU RD GN

YJ-SPA024

6 Gang 1 Hole Alu Panel



Input: DC12-24V
MAX Amps: 12V20A/24V10A
Material: ABS+Aluminium
Light color: BU RD GN WH OG

YJ-SPA025

5 Gang 3 Hole Brushed Panel



Input: DC12-24V
MAX Amps: 12V20A/24V10A
Output: 5V3.1A/9V2A/12V1.5A
Material: ABS+Aluminium
Light color: BU RD GN WH OG

YJ-SPA013

6 Gang Alu Panel



Input: DC12-24V
MAX Amps: 12V20A/24V10A
Output: 5V/4.8A
Material: ABS+Aluminium
Light color: BU RD GN

YJ-SPA014

8 Gang Alu Panel



Input: DC12-24V
MAX Amps: 12V20A/24V10A
Output: 5V/4.8A
Material: ABS+Aluminium
Light color: BU RD GN

YJ-SPA028

6 Gang 3 Hole Gold Brushed Panel

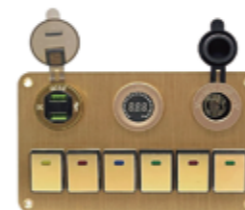

Input: DC12-24V
MAX Amps: 12V20A/24V10A
Output: 5V3.1A/9V2A/12V1.5A
Material: ABS+Aluminium
Light color: BU RD GN WH OG

YJ-SPA033

5 Hole Switch Panel



Input: DC12V
MAX Amps: 12V20A
Material: ABS+Aluminium
Light color: BU RD GN WH OG

YJ-SPA037



5 Gang 3 Hole Switch Panel

Input: DC12V
MAX Amps: 12V20A
Material: ABS+Aluminium
Light color: BU RD GN

YJ-SPA038



8 Gang 3 Hole Switch Panel

Input: DC12V
MAX Amps: 12V20A
Output: 5V/4.2A
Material: ABS+Aluminium
Light color: BU RD GN

YJ-SPA061



4 Gang+4 DS Switch Panel

Input: DC12V
MAX Amps: 12V20A
Output: 5V/3.2A
Material: ABS+Aluminium
Light color: BU

YJ-SPA062



Multi-Functions Panel

Input: DC12-24V
MAX Amps: 12V20A
Output: 5V/3.1A
Material: ABS+Aluminium
Light color: BU RD GN

YJ-SPA041



4 Hole DS Panel

Input: DC12V
MAX Amps: 12V20A
Output: 5V/4.2A
Material: ABS+Aluminium
Light color: BU RD GN WH OG

YJ-SPA042



6 Hole DS Panel

Input: DC12-24V
MAX Amps: 12V20A/24V10A
Output: 5V4.2A
Material: ABS+Aluminium
Light color: BU RD GN WH OG

YJ-SPA063



8 Gang Multiple Switch Panel+Protector

Input: DC12-24V
MAX Amps: 12V20A/24V10A
Material: ABS+Aluminium
Light color: BU RD GN WH OG

YJ-SPA064



4 Gang Water Transfer Printing Alu Panel

Input: DC12-24V
MAX Amps: 12V20A/24V10A
Material: ABS+Aluminium
Light color: BU RD GN WH OG

YJ-SPA048



10 Gang Switch with Digital

Input: DC12-24V
MAX Amps: 12V20A/24V10A
Material: ABS+Aluminium
Light color: BU RD GN WH OG

YJ-SPA050



AC Alu Switch Panel

Input: DC12-24V
MAX Amps: 12V20A/24V10A
Material: ABS+Aluminium
Light color: BU RD GN WH OG

YJ-SPA067



5 Gang Switch Panel

Input: DC12V
MAX Amps: 12V20A
Material: ABS+Aluminium
Light color: BU RD GN OG

YJ-SPA092



5 Gang 2 Hole 2 Socket +Digital

Input: DC12-24V
MAX Amps: 12V20A/24V10A
Material: ABS+Aluminium
Light color: BU RD GN

YJ-SPA044

4 Gang Butterfly Panel



Input: DC12-24V
MAX Amps: 12V20A/24V10A
Output: 5V3.1A
Material: ABS+Aluminium
Light color: BU RD GN WH OG

YJ-SPA051

5 Gang 1 Hole Alu Panel with Digital voltmeter



Input: DC12-24V
MAX Amps: 12V20A/24V10A
Material: ABS+Aluminium
Light color: BU RD GN WH OG

YJ-SPA069

3+1 Control Box



Input: DC12-24V
Current: 10A/20A
Material: ABS+Aluminium
Light color: BU RD GN WH OG

YJ-SPA071

4+1 Control Box



Input: DC12-24V
Material: ABS+Aluminium
Light color: BU RD GN WH OG

YJ-SPA057

3 Gang+Protector



Input: DC12-24V
MAX Amps: 12V20A/24V10A
Material: ABS+Aluminium
Light color: BU RD GN WH OG

YJ-SPA060

8 Gang Alu Panel +Protector



Input: DC12-24V
MAX Amps: 12V20A/24V10A
Material: ABS+Aluminium
Light color: BU RD GN WH OG

YJ-SPA072

6+1 Control Box



Input: DC12-24V
MAX Amps: 12V20A/24V10A
Material: ABS+Aluminium
Light color: BU RD GN WH OG

YJ-SPA070

6 Gang Control Box



Input: DC12-24V
MAX Amps: 12V20A/24V10A
Material: ABS+Aluminium
Light color: BU RD GN WH OG

PLASTIC&DS PANEL SERIES

The plastic panel can be combined at will, and we support all kinds of customization.

Can customize a variety of combination panels to meet the needs.

YJ-SPP001

One-Hole Rear Plastic Panel

- Input: DC12-24V
- Output: 5V/3.1A
- Material: ABS+metal
- Light color: BU RD GN WH OG



YJ-SPP002

Dual Hole Plastic DS Panel with Light

- Input: DC12-24V
- Output: 5V/4.2A
- Material: ABS+metal
- Light color: BU RD GN WH OG

YJ-SPP006

Three Hole Front Plastic Panel

- Input: DC12-24V
- Output: 5V/3.1A
- Material: ABS+metal
- Light color: BU RD GN WH OG



YJ-SPP009

Four Hole Panel

- Input: DC12-24V
- MAX Amps: 5V/3.1A
- Output: 5V/4.2A
- Light color: BU RD GN WH OG



YJ-SPP001-1

Anderson Front Plug Panel

Input: DC12-24V
Output: 5V/3.1A
Material: ABS+metal
Light color: BU RD GN WH OG



YJ-SPP003

White 2-Hole Concave Panel

Input: DC12-24V
Output: 5V/3.1A
Material: ABS+metal
Light color: BU RD GN WH OG



YJ-SPP004

3 in 1 Panel USB Socket +Cigarette Lighter Outlet +Switch with Cover

Input: DC12-24V
Output: 5V/3.1A
Material: ABS+metal
Light color: BU RD GN WH OG



YJ-SPP007

3 Hole Concave Plastic Panel with Switch

Input: DC12-24V
Output: 5V/3.1A
Material: ABS+metal
Light color: BU RD GN WH OG



YJ-SPP024

Toggle Switch Panel

Input: DC12-24V
MAX Amps: 20A
Light color: BU



YJ-SPP002

Dual Hole DS Panel with Digital

Input: DC12-24V
MAX Amps: 15A
Output: 5V/120W
Material: ABS+metal
Light color: BU RD GN WH OG



YJ-SPP002-1

2-Hole Front Panel

Input: DC12-24V
MAX Amps: 15A
Output: 5V/120W
Material: ABS+metal
Light color: BU RD GN WH OG



YJ-SPP005

3 in 1 Panel

Input: DC12-24V
USB QC3.0 output: DC5V 3A/
DC9V 2A/DC12V 1.5A
Material: ABS+metal
Light color: BU RD GN WH OG



YJ-SPP008

4 in 1 Panel

Input: DC12-24V
Output: 5V/4.2A
Material: ABS+metal
Light color: BU RD GN WH OG



YJ-SPP023

5 Position Overload Panel

Input: DC12-24V
MAX Amps: 20A





YJ-SPP032

One Hole Panel

Input: DC12-24V
MAX Amps: 12V20A/24V10A
Output: 5V/120W
Material: ABS+metal
Light color: BU RD GN WH OG



YJ-SPP034

Single Position
Battery Test Panel

Input: DC12-24V
MAX Amps: 12V20A/24V10A
Material: ABS+metal
Light color: BU RD GN WH OG



YJ-MB052-1

4-Gang Panel with
Protector

Input: DC12-24V
MAX Amps: 12V20A/24V10A
Light color: RD



YJ-MB052

6-Gang Panel with
Protector

Input: DC12-24V
MAX Amps: 12V20A/24V10A
Light color: RD



YJ-SPA100

2-Gang +One Hole
DS Panel

Input: DC12-24V
MAX Amps: 12V20A/24V10A
Light color: BU RD GN WH OG



YJ-SPP040

4-Gang +One Hole
DS Panel

Input: DC12-24V
MAX Amps: 12V20A/24V10A
Light color: BU RD GN WH OG



YJ-SPP035

4-Gang Combination
Panel

Input: DC12-24V
MAX Amps: 15A
Light color: RD BU



YJ-SPP036

Breaker Switch Panel

Input: DC12-24V
MAX Amps: 15A
Light color: RD BU



YJ-SPA024

6-Gang +One Hole
DS Panel

Input: DC12-24V
MAX Amps: 12V20A/24V10A
Light color: BU RD GN WH OG



YJ-SPP015

4 Switch Power
Socket

Input: DC12-24V
MAX Amps: 12V20A/24V10A
Output: 5V/3.1A
Light color: BU RD GN WH OG



YJ-SPP038

6-Gang Wide Panel

Input: DC12-24V
MAX Amps: 12V20A/24V10A
Output: 5V/4.2A
Light color: BU RD GN WH OG



YJ-SPP039

8-Gang Wide Panel

Input: DC12-24V
MAX Amps: 12V20A/24V10A
Output: 5V/4.2A
Light color: BU RD GN WH OG



YJ-SPP029

White 4-Gang Circuit
Breaker Panel

Input: DC12-24V
MAX Amps: 12V20A/24V10A
Material: ABS+metal
Light color: BU RD GN WH OG



YJ-SPP020

4 Gang Panel with
Productor and
Light Bar

Input: DC12-24V
MAX Amps: 12V20A/24V10A
Light color: BU RD GN WH OG



YJ-SPP016

6 Gang 3 Hole
Panel

Input: DC12-24V
MAX Amps: 12V20A/24V10A
Output: 5V/3.1A
Light color: BU RD GN WH OG



YJ-SPP017

8-Gang+4-Hole
Panel

Input: DC12-24V
MAX Amps: 12V20A/24V10A
Output: 5V/3.1A
Light color: BU RD GN WH OG



YJ-SPP021

6 Gang Panel with
Productor and
Light Bar

Input: DC12-24V
MAX Amps: 12V20A/24V10A
Light color: BU RD GN WH OG



YJ-SPP022

8 Gang Panel with
Productor and
Light Bar

Input: DC12-24V
MAX Amps: 12V20A/24V10A
Light color: BU RD GN WH OG

RACING SWITCH PANEL

- Subverting the traditional ignition switch era intelligent life is on the verge of breaking out -



YJ-ISP01
One Position Alu Ignition Panel

Input: DC12V
MAX Amps: 20A
Material: Metal+plastic
Size: 95*36mm



YJ-ISP02
Two Position Alu Ignition

Product size:
64.5*67.5mm



YJ-ISP01-1
1-Gang+Light

Input: DC12V
MAX Amps: 20A
Material: Metal+plastic
Size: 95*36mm



YJ-ISP03
3-Gang Alu Ignition Switch

Product size:
80*98mm



YJ-ISP02-1
Start Button+Turn Switch Light

Input: DC12V
MAX Amps: 20A
Material: Metal+plastic
Size: 95*65mm



YJ-ISP02-5
1-Gang Ignition Switch with Light

Input: DC12V
MAX Amps: 20A
Material: Metal+plastic
Size: 95*65mm



YJ-ISP05
3-Gang Ignition Switch Light

Input: DC12V
MAX Amps: 20A
Material: Metal+plastic



YJ-ISP03-3
3-Gang+Start Button Turn Switch Light

Input: DC12V
MAX Amps: 20A
Material: Metal+plastic
Size: 195*67mm



YJ-ISPS06
6-Gang for Racing Car

Product size:
176*65mm



YJ-ISPS07
6-Gang for Racing Car

Product size:
122*65mm



YJ-ISP01-2
Alu Panel

Product size:
36*95mm



YJ-ISP02-2
Start Button

Input: DC12V
MAX Amps: 20A
Material: Metal+plastic
Size: 95*65mm



YJ-ISPS04
4-Gang US Style Aul Panel
with Start Button

Input: DC12V
MAX Amps: 20A
Material: Metal+plastic
Size: 175*66mm



YJ-ISPS04-1
5-Gang EN Style Aul Panel
with Start Button

Input: DC12V
MAX Amps: 20A
Material: Metal+plastic
Size: 175*66mm



YJ-ISPS02
2-Gang Panel for Racing
Car

Input: DC12V
MAX Amps: 20A
Material: Metal+plastic



YJ-ISP02-4
1-Hole Switch+Start
Button+Indicator Light

Input: DC12V
MAX Amps: 20A
Material: Metal+plastic
Size: 95*65mm



YJ-ISPS04-2
5-Gang ITA Style Aul Panel
with Start Button

Input: DC12V
MAX Amps: 20A
Material: Metal+plastic
Size: 175*66mm



YJ-ISPS04-3
5-Gang PRI Style Aul Panel
with Start Button

Input: DC12V
MAX Amps: 20A
Material: Metal+plastic
Size: 175*66mm



YJ-ISP04-2
3-Gang Panel+Start Button
(water transfer printing)

Input: DC12V
MAX Amps: 20A
Material: Metal+plastic
Size: 95*66mm



YJ-ISP05-1
4-Gang Panel+Start Button
(water transfer printing)

Input: DC12V
MAX Amps: 20A
Material: Metal+plastic
Size: 150*65mm



YJ-ISPW02-1
3-Gang Colorful Ignition
Panel+Start Button Light

Input: DC12V
MAX Amps: 20A
Material: Metal+plastic
Size: 150*65mm



YJ-ISPW02
1-Gang Colorful Panel
+Start Button Light

Input: DC12V
MAX Amps: 20A
Material: Metal+plastic
Size: 195*67mm



YJ-ISP03-2
3-Gang Alu Ignition
Switch Panel

Product size:
99*66mm



YJ-ISP08
8-Gang Alu Ignition
Switch Panel

Input: DC12V
MAX Amps: 20A
Material: Metal+plastic
Size: 210*65mm



YJ-ISPW02-2
4-Gang Colorful Ignition
Panel+Start Button Light

Input: DC12V
MAX Amps: 20A
Material: Metal+plastic
Size: 210*65mm



YJ-ISPS05
5-Gang Panel with
Start Button

Input: DC12V
MAX Amps: 20A
Material: Metal+plastic
Size: 95*66mm



YJ-ISPS05-2
5-Gang Alu Ignition
Panel with Start Button

Product size:
180*65mm



FUSE BOX SERIES

Can be directly connected to the car / onboard any electrical appliances on the line (such as: roof lights, car headlights, as wide lights, fog lights, warning lights, car refrigerator, car chargers, car fans, car TV, etc.)



YJ-FB501

10 Way Fuse Box (High Current)

YJ-FB606

6-Way Fuse Block with Negative LED Indicator

Product Size:
87.75*85*36.5mm



YJ-FB1206

12-Way Negative Fuse Block with Light

Product Size:
138.25*85*36.5mm

YJ-FB613

6 way in/out fuse box



YJ-FB614

1 in-6 out fuse box with light

Product Size:
92*87*42mm



YJ-FB401

Single 4-Way Fuse Block

Product Size:
86*53*42mm



YJ-FB601

6-Way Fuse Block

Product Size:
116*53*42mm



YJ-FB803

8-Way Fuse Block

Product Size:
154*53*42mm



YJ-FB1001-1

10-Way Fuse Block

Product Size:
183*53*42mm



YJ-FB1204-1

2-Way Fuse Block

Product Size:
212*53*42mm



YJ-FB402

4-Way Fuse Block with Bolt-Style Screw

Product Size:
86.2*52.8*26.8mm



YJ-FB602

6-Way Fuse Block with Bolt-Style Screw

Product Size:
115.3*52.7*26.8mm



YJ-FB1204

12-Way Fuse Block with Bolt-Style Screw

Product Size:
211.5*52.7*26.8mm



YJ-FB1213

12 Circuit Fuse (Yellow)

Product Size:
164.4*84.2*38.5mm



YJ-FB612

6-Way Fuse Block

Product Size:
85*63*36mm





YJ-FB618

6-way high cover fuse box with light and nuts (2 pos + 1 neg)

Product Size:
125*94.8*58mm



YJ-FB618-1

6-way fuse box with light and nuts (1 pos + 1 neg)

Product Size:
110*88*60mm



YJ-FB804

8-Way Fuse Block (Screw)

Product Size:
83*92*41mm



YJ-FB1202

12-Way Fuse Block (Screw)

Product Size:
115*92*41mm



YJ-FB1006

10-Way Fuse Block with Waterproof Belt

Product Size:
125*90*53.5mm



YJ-FB1211

1 in-12 out fuse box with light

Product Size:
127*88.9*42mm



YJ-FB1210

12 Circuit Fuse (Blue)

Product Size:
164.4*84.2*38.5mm



YJ-FB405

4-Way Screw Style Fuse Block with Light

Product Size:
100*47mm



YJ-FB1212

12-Way Fuse Block with Bolt-Style

Product Size:
151*86*51mm



YJ-FB1212-1

12-Way Fuse Block with High Cover

Product Size:
190*98*60mm



YJ-FB605

6-Way Screw-Style Fuse Block with Light

Product Size:
70*85*35mm



YJ-FB802

8-Way Screw-Style Fuse Block with Light

Product Size:
85*85*35mm



YJ-FB1217

12 Way Fuse Box +Rotating Cover



YJ-FB1214

204-12KW Fuse Block

Product Size:
183*105*64.3mm



YJ-FB1004

10-Way Screw-Style Fuse Block with Light

Product Size:
100*85*35mm



YJ-FB1203

12-Way Screw-Style Fuse Block with Light

Product Size:
115*85*35mm



YJ-FB604

6-Way Fuse Block with Screw

Product Size:
68*92*41mm



YJ-FB1003

10-Way Fuse Block with Screw

Product Size:
99*92*41mm



YJ-FB616

6-Way Negative Screw Style Fuse Block (without light)

Package Size:
11*8.8*6CM



YJ-FB609

New 6-Way Fuse Block (without light)

Product Size:
130*55*40mm



YJ-FB403

4-Way PIN Style Fuse Block with Light

Maximum Voltage:32V DC
Maximum Current:100A(max)
Material:PC+PBT+POM



YJ-FB603

6-Way PIN Style Fuse Block with Light

Product Size:
63*85*35mm



YJ-FB404

4-Way Fuse Block without Light

Product Size:
92.5*43.8*32.1mm



YJ-FB805

8-Way Fuse Block without Light

Product Size:
145*44*33mm



YJ-FB801

8-Way PIN Style Fuse Block with Light

Product Size:
85*85*35mm



YJ-FB1002

10-Way PIN Style Fuse Block with Light

Product Size:
100*85*35mm



YJ-FB1205

12 in-12 out without neg fuse box (long style)

Product Size:
195*50*52mm



YJ-FB1205-1

1 in-12 out with pos/neg fuse box (long style)

Product Size:
195*50*52mm

NEW PRODUCTS



YJ-FH002-4

4-Way Fuse Block with Cable

Product Size:
73*56mm



YJ-FH002-8

8-Way Fuse Block with Cable

Product Size:
113*56mm



YJ-FH002-6

6-Way Fuse Block with Cable

Product Size:
93*56mm



YJ-FH002-12

12-Way Fuse Block with Cable

Product Size:
153*56mm



YJ-FH002-10

10-Way Fuse Block with Cable

Product Size:
133*56mm

6-Way Fuse Block with negative



Weight:180g

Size: 11*8.8*6cm

Input: 100A/32V

Output: 30A

Material: PBT+PC

Terminal: M5

How it works: each fuse has a rating on the specification, when the current exceeds the rating will fuse. If a fuse is properly placed in the circuit, then the fuse will self-fuse and cut off the current when the current abnormally rises to a certain height and temperature, thus playing the role of protecting the safe operation of the circuit.

Application



High temperature resistance



Corrosion resistance



Environmentally friendly materials

Widely used on the car,suv,motor,homes,bus,yacht,ship,etc.



BUS BAR TERMINALS



YJ-HP08R-M6

RV Yacht USP Busbar

Specifications:
Red M6 copper bolts
Rated: 48V 250A
Colour: Red



YJ-HP08H-M6

RV Yacht USP Busbar

Specifications:
Black M6 copper bolts
Rated: 48V 250A
Colour: Black



YJ-HP06-10R/H

10 position arch busbar

Product Size: 122*37*38mm
Colour: Red / Black



YJ-HP07R/H-M8

4-bolt busbar

Specifications:
Red / Black M8 copper bolts
Rated: 48V 250A
Colour: Red/Black



YJ-HP07R-M10

4-bolt busbar

Specifications:
Red M10 Copper Studs
Rated: 48V 250A
Colour: Red



YJ-HP06-12R/H

12 position arch busbar

Colour: Red / Black



YJ-HP11-6R/H

Small square 6-way busbar

Rated power: 150A DC
Colour: Red/Black



YJ-HP14-10R/H

10 way w/cover busbar

Red copper PC stainless steel
Maximum voltage: 48V DC
Rated current: 250A
Colour: Red/Black



YJ-HP15-6R/6H

6 way w/cover busbar

Rated power: 48V 250A
Colour: Red/Black



YJ-HP01-6H

Dual-row refit busbar 6-way Terminal Block

Product Size:
120*40*42mm
Colour: Black



YJ-HP13-8R/H

8 way w/cover busbar Terminal Block

Colour: Red/Black



YJ-HP07-12R/H

12way w/ cover busbar

Specifications:
Red M6 copper bolt
Rated: power48V 150A
Colour: Red/Black



YJ-HP19-5H

5 way busbar

Colour: Black



YJ-HP03-6R/H

6-way busbar

Rated power: 150A 48VCD
Material: Copper/Nylon
Colour: Red/Black



YJ-HP20-6R/H

6 way busbar

Rated current: 300A
Colour: Red/Black



YJ-HP05-8R/H

8 way busbar w/cover
Zinc alloy PC stainless steel
Maximum voltage: 48V DC
Rated current: 250A
Colour: Red/Black



YJ-HP09-4R

Small square 4-way busbar

Colour: Red 150A



YJ-HP09-4H

Small square 4-way busbar

Colour: Black 150A



YJ-HP16-20H

20 way busbars

Colour: Black



YJ-HP17-4H

4 way busbar

Colour: Black



YJ-HP18-8H

8 way busbar

Colour: Black



YJ-HP04-10R/H

10-way busbar

Rated power: 150A 48VCD
Material: Copper/Nylon
Colour: Red/Black



YJ-HP04-12R/H

12-way busbar

Rated power: 150A 48VCD
Material: Copper/Nylon
Colour: Red/Black



YJ-HP12-10R/H

Large 10-Position Busbar

Colour: Red/Black



YJ-HP10-12H

12 way busbar

Rated power: 12/24V 100A
Colour: Black



YJ-FBQT02
Fork Bolt Style Fuse
Tube Base

Product Size:
155*37.8*30.5mm



YJ-FB201
2-Way Fuse Block

Product Size:
80*39*22.5mm



YJ-FBQT09



YJ-FBQT03-1
Midi Fuse Block
+40A
Product Size:
70*20mm



YJ-FBQT05
Fuse Block
-Transparent

Product Size:
122*37*38mm



YJ-FBQT06
ANL Fuse Holder
+100A Fuse

Product Size:
122*37*38mm



YJ-FBQT03
Mega Standard
Fuse Block

Product Size:
119.4*38.9*38.1mm



YJ-FBQT11
ANS Fuse Holder

Product Size:
52*29.5*25mm



YJ-FBQT07
ANL Fuse Block

Product Size:
155*37*8*37.3mm



YJ-FBQT15
AGU Fuse Holder

Product Size:
110*56mm



FUSE HOLDER SERIES



YJ-FH-B1-2

Mini Fuse Block
(Ring)



Material: PVC
Fuse holder size(L/H):
33.8*24.5mm

YJ-FH-B2

Mid Tap Blade
Fuse



Material: PVC
Fuse holder size(L/H):
37.3*36mm

YJ-FH003

SAE Fuse Holder



Material: Fireproof plastic

YJ-FH003-1

Power Port with
SAE Connector



Material: Fireproof plastic

YJ-FH-B2-5

Matchbox Style
Inline Fuse Holder



Material: PVC
Fuse holder size(L/H):
24.7*36mm

YJ-FH-B2-8

ATC/ATO Inline
Fuse Holder(Mid)



Material: PVC
Fuse holder size(L/H):
41*35mm

YJ-FH006

Alligator Crocodile
Clip SAE with Fuse
Holder



Material: Fireproof plastic

YJ-FH-B3-2

Tap Blade Fuse
Holder



Material: PVC

YJ-FH-B3-1

Big Fuse Holder
with Line



Material: PVC
Fuse holder size(L/H):
48.6*61.8mm

YJ-FH-MICR03-A

Dual Line 3ATM
Blade Fuse



Material: fireproof PC+ABS

YJ-FH-ACU-A

Fuse Holder 3CKT



Material: fireproof PC+ABS

YJ-FH-MICR02-A

Dual Line Long
ATM Blade Fuse



Material: fireproof PC+ABS

YJ-FH-B5

SAE Tap Blade
Fuse



Material: PVC+ABS
Fuse holder size(L/H):
41*35mm

YJ-FH001

SAE Cable Inline
Fuse Holder



YJ-FH001-1: 1m
YJ-FH001-2: 2m
YJ-FH001-3 :3m
Material: fireproof ABS

YJ-FH-ACN-A

Dual Line Shot
ATM Blade Fuse



Material: fireproof PC+ABS



SPECIAL CAR SWITCH USB CHARGER SERIES



YJ-STUB038B
Small Toyota PD+QC3.0 (square)

Input: DC 12V-24V
Output: A: 5V/3A 9V/2A
12V/1.5AC: 5V/3A 9V/2.2A
12V/1.67A
Material: PC
Hole size: 22.6*22.6*65.7mm



YJ-STUB039B
Small Toyota QC3.0 (square)

Input: DC 12V-24V
Output: A: 5V/3A 9V/2A
12V/1.5AC: 5V/3A 9V/2.2A
12V/1.67A
Material: PC
Hole size: 22.6*22.6*65.7mm



YJ-STUB017B-1
Small Toyota Audio USB Charger (square)

Input: DC 12V-24V
Output: A: 5V/3A 9V/2A
12V/1.5AC: 5V/3A 9V/2.2A
12V/1.67A
Material: PC
Hole size: 22.6*22.6*65.7mm

USB SERIES



YJ-STUB022B
Small Toyota PD+QC3.0 (with aperture)

Input: USB: QC3.0
Output: 5V/4.2A
Material: ABS+Copper
Hole size: 32*20mm



YJ-STUB017B-2
Small Toyota QC3.0 (Square)

Input: QC12-24V
Output: 5V/4.2A
Material: ABS+Copper
Hole size: 32*20*70mm



YJ-STUB026B
Small Toyota PD+QC3.0 (Square)

Input: 12-24V USB: QC3.0
Output: 5V3.0A/9V2.0A/12V1.5A
Material: ABS+Copper
Size: 22*22*58mm



YJ-STUB006B
Dual Small Toyota USB

Input: DC12-24V
Output: 5V/4.2A
Material: ABS+Copper
Hole size: 32*20mm



YJ-STUB006B-1
Dual Small Toyota USB

Input: DC12-24V
Output: 5V/4.2A
Material: ABS+Copper
Hole size: 32*20*70mm



YJ-STUB017
T45 Small Toyota QC3.0

Input: 12-24V USB: QC3.0
Output: 5V3.0A/9V2.0A/12V1.5A
Material: ABS+Copper
Size: 22*22*58mm



YJ-STUA009
Big Toyota QC3.0

Input: DC12-24V
Output: 5V3.0A/9V2.0A/12V1.5A
Material: ABS+Copper
Size: 40*20*38mm



YJ-STUB003B
Dual Small Toyota QC3.0

Input: DC12-24V
Output: 5V3.0A/9V2.0A/12V1.5A
Material: ABS+Copper
Size: 32*20*38mm



YJ-STUB018B
T45 2.1A Small Toyota USB

Input: 12-24V USB: 5V/2.4A
Output: 5V3.0A/9V2.0A/12V1.5A
Material: ABS+Copper
Size: 22*22*58mm



YJ-STUA001

Dual Big Toyota USB

Input: DC12-24V
Output: 5V/4.2A
Material: ABS+Copper
Size: 40*20mm



YJ-STUA012OB-2

Big Toyota QC3.0+2.4A

Input: DC12-24V
Output: QC3.0+5V/2.4A
Material: ABS+Copper
Size: 40*20mm



YJ-STUD001B-1

Dual Honda USB

Input: DC12-24V
Output: 5V/4.2A
Material: ABS+Copper
Size: 40*20mm



YJ-STUD002B

New Style Dual Honda USB

Input: DC12-24V
Output: 5V/4.2A
Material: ABS+Copper
Hole size: 35*18mm



YJ-STUD008OB

Honda QC3.0+2.4A

Input: DC12-24V
Output: QC3.0+5V/2.4A
Material: ABS+Copper
Size: 35*18mm



YJ-STUB012OB-2

Small Toyota QC3.0+2.4A

Input: DC12-24V
Output: QC3.0+5V/2.4A
Material: ABS+Copper
Size: 32*20mm



YJ-STUB015B

Dual Small Toyota USB

Input: DC12-24V
Output: 5V/3.1A
Material: ABS+Copper
Hole size: 35*23*50mm



YJ-STUC001B

Dual Nissan USB

Input: DC12-24V
Output: 5V/4.2A
Material: ABS+Copper
Hole size: 45*21*59mm



YJ-STUE001

Dual Isuzu USB

Input: DC12-24V
Output: 5V/4.2A
Material: ABS+Copper
Size: 30*22mm



YJ-STUF001

Dual Mitsubishi USB

Input: DC12-24V
Output: 5V/4.2A
Material: ABS+Copper
Size: 37*20*69mm



YJ-STUG001B

Dual Suzuki USB

Input: DC12-24V
Output: 5V/4.2A
Material: ABS+Copper
Hole size: 44*22mm



YJ-STUC002B

Dual Nissan USB

Input: DC12-24V
Output: 5V/4.2A
Material: ABS+Copper
Hole size: 45*21*59mm



YJ-STUC006

Nissan QC3.0+2.4A

Input: DC12-24V
Output: QC3.0+5V/2.4A
Material: ABS+Copper
Size: 44*21mm



YJ-STUC007B

Dual Nissan QC3.0

Input: DC12-24V
Output: 5V3.0A/9V2.0A/
12V1.5A
Material: ABS+Copper
Hole size: 28*20mm



YJ-STUG004

Suzuki QC3.0+2.4A

Input: DC12-24V
Output: QC3.0+5V/2.4A
Material: ABS+Copper
Hole size: 42*22mm



YJ-STUI001B

Dual Ford USB

Input: DC12-24V
Output: 5V/4.2A
Material: ABS+Copper
Size: 38*23mm



YJ-STUJ001B

Dual Mazda USB

Input: DC12-24V
Output: 5V/4.2A
Material: ABS+Copper
Size: 35*23mm



YJ-STA01

Big Toyota Switch

Input: DC12-24V
Material: ABS+Copper
Size: 40*20*61mm



YJ-STA02B

Dual Big Toyota Switch

Input: DC12-24V
Material: ABS+Copper
Size: 40*20*61mm



YJ-STB01

Small Toyota Switch

Input: DC12-24V
Material: ABS+Copper
Size: 32*20*52mm



YJ-STE01B

T30 Ford Switch

Input: DC12-24V
Material: ABS+Copper
Size: 32*20*52mm



YJ-STE02B

T30 Dual Ford Switch

Input: DC12-24V
Material: ABS+Copper
Size: 39*24*58mm



YJ-STG01B

T10 Mitsubishi Switch

Input: DC12-24V
Material: ABS+Copper
Size: 40*21mm



YJ-STB02B

Dual Small Toyota Switch

Input: DC12-24V
Material: ABS+Copper
Size: 32*20*52mm



YJ-STB05B

T45 Small Toyota Switch

Input: DC12-24V
Material: ABS+Copper
Size: 33*23mm



YJ-STC01B

T3 Corolla Switch

Input: DC12-24V
Material: ABS+Copper
Size: 43*25mm



YJ-STH01B

T15A Nissan Switch

Input: DC12-24V
Material: ABS+Copper
Size: 35*20mm



YJ-STI01B

T6 Big Isuzu Switch

Input: DC12-24V
Material: ABS+Copper
Size: 33*22mm



YJ-STI02B

T6 Small Isuzu Switch

Input: DC12-24V
Material: ABS+Copper
Size: 39*21mm



YJ-STD01B

T5 Big Volkswagen Switch

Input: DC12-24V
Material: ABS+Copper
Size: 43*27mm



YJ-STD01B-1

T5 Small Volkswagen Switch

Input: DC12-24V
Material: ABS+Copper
Size: 40*20*61mm



YJ-STF01B

T43 Tiida Switch

Input: DC12-24V
Material: ABS+Copper
Size: 30*23mm



YJ-WMKG001B

Toyota Tailgate Switch

Input: DC12-24V
Material: ABS+Copper
Hole size: 100*45mm



YJ-STI03BB-2

T6B Isuzu Switch

Input: DC12-24V
Material: ABS+Copper
Size: 53.2*32.6mm



YJ-STUA019B

Big Toyota QC3.0+PD

Input: DC12-24V
Material: ABS+Copper



YJ-STUA020B

Big Toyota Dual PD

Input: DC12-24V
Material: ABS+Copper



YJ-STUB033B

Small Toyota QC3.0+PD

Input: DC12-24V
Material: ABS+Copper



YJ-STUL031

Volkswagen Type-C+PD

Input: DC12-24V
Material: ABS+Copper



YJ-STUH003R

Volkswagen T5 Dual USB

Input: DC12-24V
Output: 5V
Material: ABS+Copper
Size: 32*32mm



YJ-STUH004B

Volkswagen T5 Dual USB (Concave)

Input: DC12-24V
Output: 5V
Material: ABS+Copper
Size: 32*32mm



YJ-STUB034B

Small Toyota Dual PD

Input: DC12V
Material: ABS+Copper



YJ-STUD011B

Honda QC3.0+PD

Input: DC12-24V
Material: ABS+Copper



YJ-STUD012B

Honda Dual PD

Input: DC12-24V
Material: ABS+Copper



YJ-STUH007B

Volkswagen T5 Dual USB (Convex)

Input: DC12-24V
Output: 5V/2.1A
Material: ABS+Copper
Size: 32*32mm



YJ-STUH006R

Volkswagen T4 Dual USB (Convex)

Input: DC12-24V
Output: 5V/2.1A
Material: ABS+Copper
Size: 44*26mm



YJ-STUK009

Willanda QC3.0

Nissan PD+QC3.0
Input: DC12-24V
Output: 5V/2.1A
Material: ABS+Copper
Size: 44*26mm



YJ-STUL029

Nissan QC3.0+PD

Input: DC12-24V
Material: ABS+Copper



YJ-STUL030

Mitsubishi Type-C+QC3.0

Input: DC12V
Material: ABS+Copper



YJ-STUL032

Volkswagen QC3.0

Input: DC12-24V
Material: ABS+Copper



YJ-STUK002B

Wildlander QC3.0

Input: DC12-24V
Output: 5V/2.1A
Material: ABS+Copper
Size: 44*26mm



YJ-STUL038

Input: DC12-24V
Output: 5V/2.1A
Material: ABS+Copper
Size: 44*26mm



USB + AUDIO SERIES >>>



YJ-STUA003BB

Big Toyota USB+Audio

Input: DC12-24V
Output: 5V/2.1A
Material: ABS+Copper
Size: 40*20mm



YJ-STUB007-1

Small Toyota USB+Audio

Input: DC12-24V
Output: 5V/2.1A
Material: ABS+Copper
Hole size: 32*20mm



YJ-STUC004

Nissan USB+Audio

Input: DC12-24V
Output: 5V/2.1A
Material: ABS+Copper
Size: 44*21mm



YJ-STUD004B-1

Honda USB+Audio

Input: DC12-24V
Output: 5V/2.1A
Material: ABS+Copper
Hole size: 43*25mm



YJ-STUE002

Isuzu USB+Audio

Input: DC12-24V
Output: 5V/2.1A
Material: ABS+Copper
Hole size: 30*22mm



YJ-STUL024

Dual TYPE-C+AUX

Input: DC12-24V
Output: 5V/2.1A
Material: ABS+Copper
Size: 44*26mm



YJ-STUB027

Small Toyota USB+HDMI

Input: DC12-24V
Output: 5V/2.1A
Material: ABS+Copper
Hole size: 38*23mm



YJ-STUD009

Honda USB+HDMI

Input: DC12-24V
Output: 5V/2.1A
Material: ABS+Copper
Size: 32*20mm



YJ-STUL036

Honda AUDIO+HDMI

Input: DC12-24V
Material: ABS+Copper
Size: 37*20*69mm



YJ-STUL037

Honda AUDIO+HDMI

Input: DC12V
Material: ABS+Copper
Hole size: 44*26mm



YJ-STUL002

Little Toyota USB+HDMI

Input: DC12-24V
Material: ABS+Copper
Size: 37*20*69mm



YJ-STUL035

Nissan AUDIO+HDMI

Input: DC12V
Material: ABS+Copper
Hole size: 41*22mm



YJ-STUA013RB

Big Toyota Voltage+TEM

Input: DC12-24V
Output: 5V/2.1A
Material: ABS+Copper
Hole size: 40*20mm



YJ-STUL033RB

Mitsubishi Voltage+TEM

Input: DC12-24V
Output: 5V/2.1A
Material: ABS+Copper
Size: 35*23mm



YJ-STUB019BR

Small Toyota Voltage+TEM

Input: DC12-24V
Output: 5V/2.1A
Material: ABS+Copper
Hole size: 32*22mm



YJ-STUL020B

Nissan Voltage+TEM

Input: DC12-24V
Output: 5V/2.1A
Material: ABS+Copper
Hole size: 32*22mm



- Radium
- Customizable
- Serviceable
- Various Styles

RESERVE HOLE POSITION SWITCH

New Toyota	32*20*52mm	Ford	33*22mm
Old Toyota	40*20*61mm	Tiida	30*23mm
Nissan	55*44*20mm	Isuzu	38*23mm
Mitsubishi	60*37*22mm	Suzuki	40*22mm
Honda	57*40*20mm	Mazda	35*23mm
Volkswagen	53*43*28mm		



YJ-STUA014B

Large Toyota Dual voltmeter



YJ-STUA025B

Large Toyota PD+QC+Digital





YJ-STUA002B

Big Toyota USB+Digital

Input: DC12-24V
Output: 5V/2.1A
Material: ABS+Copper
Size: 40*20mm



YJ-STUA004B

Dual Big Toyota USB+Digital

Input: DC12-24V
Output: 5V/3.1A
Material: ABS+Copper
Size: 40*20mm



YJ-STUA005B

Dual Big Toyota QC3.0+Digital

Input: DC12-24V
Output: 5V3.0A/9V2.0A/12V1.5A
Material: ABS+Copper
Size: 32*20mm



YJ-STUC008B

New Style Nissan USB+Digital

Input: DC12-24V
Output: 5V/4.8A
Material: ABS+Copper
Size: 30*21mm



YJ-STUD003B

Honda USB+Digital

Input: DC12-24V
Output: 5V/2.1A
Material: ABS+Copper
Size: 43*25mm



YJ-STUD005B

Honda PD+USB+Digital

Input: DC12-24V
Output: 5V3.4A/9V2.5A/12V2A
Material: ABS+Copper
Hole size: 38*18mm



YJ-STUB008R

Small Toyota USB+Digital

Input: DC12-24V
Output: 5V/2.1A
Material: ABS+Copper
Hole size: 32*20mm



YJ-STUB009R

Dual Small Toyota USB+Digital

Input: DC12-24V
Output: 5V/3.1A
Material: ABS+Copper
Hole size: 32*20mm



YJ-STUB010B

Small Toyota PD+QC3.0+Digital

Input: DC12-24V
Output: 5V3.4A/9V2.5A/12V2A
Material: ABS+Copper
Size: 32*20mm



YJ-STUD007B

Dual Honda USB+Digital

Input: DC12-24V
Output: 5V/4.8A
Material: ABS+Copper
Hole size: 38*20mm



YJ-STUJ002

Mazda USB+Digital

Input: DC12-24V
Output: 5V/2.1A
Material: ABS+Copper
Hole size: 35*24*58mm



YJ-STUE001R

Isuzu USB+Digital

Input: DC12-24V
Output: 5V/2.1A
Material: ABS+Copper
Size: 35*24*58mm



YJ-STUA006B

Big Toyota PD+QC3.0+Digital

Input: DC12-24V
Output: 5V3.4A/9V2.5A/12V2A
Material: ABS+Copper
Size: 40*20mm



YJ-STUB001B

Dual Small Toyota QC3.0+Digital

Input: DC12-24V
Output: 5V3.0A/9V2.0A/12V1.5A
Material: ABS+Copper
Size: 32*20mm



YJ-STUC003B

Nissan USB+Digital

Input: DC12-24V
Output: 5V/2.1A
Material: ABS+Copper
Hole size: 45*21*59mm



YJ-STUF005R

Mitsubishi USB+Digital

Input: DC12-24V
Output: 5V/2.1A
Material: ABS+Copper
Hole size: 37*20*69mm



YJ-STUG002B

Suzuki USB+Digital

Input: DC12-24V
Output: 5V/2.1A
Material: ABS+Copper
Size: 42*22mm



YJ-STUI002B

Ford USB+Digital

Input: DC12-24V
Output: 5V/2.1A
Material: ABS+Copper
Size: 38*22mm

RJ45 SERIES >>>



YJ-STA03

Big Toyota RJ45

Material: ABS+Copper
Size: 40*20mm



YJ-STA03B

T30 Dual Ford Switch

Material: ABS+Copper
Size: 40*20*38mm



YJ-STB03

Small Toyota RJ45

Material: ABS+Copper
Size: 32*20mm



YJ-STJ03

Mazda RJ45

Material: ABS+Copper
Size: 32*28mm



YJ-STB03B

T6 Big Isuzu Switch

Material: ABS+Copper
Size: 32*20mm



YJ-STF02

Tiida RJ45

Input: DC12-24V
Material: ABS+Copper
Size: 39*21mm



YJ-STH04

Nissan RJ45

Material: ABS+Copper
Size: 44*21mm



YJ-STM06

Camry RJ45

Material: ABS+Copper
Size: 22*22mm

MOTORCYCLE USB CHARGER SERIES



YJ-DS2204B
3.3A BMW USB
Charger

Input: DC12-24V
Output: 5V/3.3A
Material: ABS+Copper
Size: 35*35*53mm
Net Weight: 60g
LED color: B



YJ-DS2205B
3.3A New Foldable Dual
USB Charger

Input: DC12-24V
Output: 5V/3.3A
Material: ABS+Copper



YJ-DS2206B
4.2A USB Charger+Volt
(Blue)

Input: DC12-24V
Output: 5V/4.2A
Material: ABS+Copper
Size: 44*44*71mm
Net Weight: 40g



YJ-DS2206R
4.2A USB Charger
+Volt(Red)

Input: DC12-24V
Output: 5V/4.2A
Material: ABS+Copper
Size: 44*44*71mm
Net Weight: 40g



YJ-DS2209
BMW Dual USB
Charger

Input: DC12-24V
Output: 5V/3.3A
Material: ABS+Copper
Net Weight: 60g



YJ-DS2212JB
BMW PD+QC3.0 USB
Charger

Input: DC12-24V
Output: 5V/3.6A,9V/2A,12V/15A
Material: ABS+Aluminium
alloy+Copper
Product color: black/silvery/
golden/red/green/blue
LED color: B G R



YJ-DS2207
4.8A Charger with Volt

Input: DC12-24V
Output: 5V/4.8A
Material: ABS+Copper
Net Weight: 55g
LED color: B R G



YJ-DS2210
120W/3.3A BMWU-2
Charger

Input: DC12-24V
Output: 5V/3.3A
Maximum power of cigarette
lighter: 120W
Net Weight: 67g



YJ-DS4035
4.2A SAE+Digital
Display

Input: DC12-24V
Output: 5V/4.2A
Material: ABS+Copper
Size: 35*35*50mm
Net Weight: 150g



YJ-DS4035-1
4.2A SAE without LED

Input: DC12-24V
Output: 5V/4.2A
Material: ABS+Copper
Size: 35*35*50mm
Net Weight: 150g

YJ-MCA004

2.0 USB+HDMI
+Cable



Input: DC 5V
Material: ABS+Copper
Cable length: 1M
Remarks: USB2.0+HDMI

YJ-MCA006

2.0 USB+AUX
Connection



Input: DC 5V
Output: 5V/1A
Material: ABS+Copper
Net weight: 100g
Remarks: USB2.0+AUX

YJ-MCA041

Car Charger with Trestle and Switch



Input: DC 12-24V
Output: 5V/3.1A
Material: ABS+Copper
Net weight: 95g

YJ-MCA043

2.1A Motorcycle USB
Charger



Input: DC 12V
Output: 5V/2.1A
Cigarette lighter output:12V/10A
Material: ABS+Copper
Size: 46*59*35mm
Net weight: 120g

YJ-MCA007

2.0 Dual USB
+Cable



Input: DC12-24V
Material: ABS+Copper
Cable length: 1M

YJ-MCA010

3.0 USB+Cable



Input: DC12-24V
Material: ABS+Copper
Cable length: 1M

YJ-MCA033

2.1A USB Power Socket



Input: DC 12-24V
Output: 5V/2.1A
Material: ABS+Copper
Size: 30*60*50mm
Net weight: 150g

YJ-MCA017

4.2A Motorcycle USB
Charger



Input: DC 5V
Output: 5V/4.2A
Material: ABS+Copper
Size: 30*60*50mm
Net weight: 150g

YJ-MCA015

Dual USB 3.1A BMW
Charger



Input: DC12-24V
Output: 5V/3.1A
Material: ABS+Copper

YJ-MCA021-1

2.1A USB Charger+SAE
Connector



Input: DC 12-24V
Output: 5V/2.1A
Material: ABS+Copper
Size: 35*35*50mm
Net weight: 100g

YJ-MCA051B

3.1A Dual USB with
Voltmeter



Input: DC 12-24V
Output: 5V/3.1A
Material: ABS+Copper
Net weight: 110g

YJ-MCC003

Electric Vehicle Motorcycle Seat Switch



Product Size:
23*20*44mm

YJ-MCA025

3.1A Dual USB with
SAE Connector



Input: DC 12-24V
Output: 5V/3.1A
Material: ABS+Copper
Size: 35*35*50mm
Net weight: 150g

YJ-MCA039

3.1A Motorcycle with
Switch



Input: DC12-24V
Output: 5V/3.1A
Material: ABS+Copper
Net weight: 200g

YJ-MCA040

DS Car Charger with
Bracket



Input: DC12-24V
Output: 5V/3.1A
Material: ABS+Copper
Size: 40*70*80mm
Net Weight: 110g

YJ-MCA040

DS 2013 Car Charger
with Bracket



Material: ABS+TPU+metal
Input: 12-24V
USB: DC 5V
Output: 1A/2.1A
Size: 77*43*85mm

YJ-MCA022

2.1A Motorcycle USB
Charger



Input: DC 12-24V
Output: 5V/2.1A
Material: ABS+Copper
Size: 30*30*56mm
Net weight: 90g

YJ-MCA024

2.1A USB with Switch



Input: DC 12-24V
Output: 5V/2.1A
Material: ABS+Copper
Net weight: 55g

YJ-MCA040

3.1A Car Charger with
Bracket



Material: PC+metal
Input: 12-24V
USB: DC 5V
Output: 1A/2.1A
Size: 45*85*36mm

YJ-MCA040

DS1011 Car Charger
with Bracket



Material: PC+metal
Input: 12-24V
Weight: 87g
Size: 48*40*74mm



YJ-MCA040

4.2A Dual USB+Volt
+Bracket

Material: PC+metal
Input: 12-24V
USB: DC 5V
Output: 2.1A/2.1A
Size: 45*85*36mm



YJ-MCA058

3.1A Dual USB+Volt
+Switch

Material: PC+metal
Input: 12-24V
USB: DC 5V
Output: 1A/2.1A
Weight: 115g



YJ-MCB026-2

BMW Cigarette Lighter
Plug to 3 Socket with Cover

Input: DC 12-24V
Output: 12V/20A
Material: ABS+Copper
Net weight: 160g



YJ-QT045-1
On-Board Inverter

Material: PC+metal
Input: 12-24V
Color: RD



YJ-MCB020

12V Cigarette Lighter

Input: DC 12V
Output power: 120W
Material: ABS+Copper



YJ-MCB023

Eu Style Cigarette Lighter
with Threaded

Input: DC 12-24V
Output power: 240W
Material: ABS+Copper



YJ-MCB041-1

Bakelite Cigarette
Light with Cover(Red)

Input: DC 12-24V
Output power: 120W
Material: ABS+Copper



YJ-MCB061

Threaded Plug to 2
Female Socket

Input: DC 12-24V
Output power: 300W
Material: ABS+Copper



YJ-MCB023-1

Threaded Cigarette
Lighter Plug to 2 Socket

Input: DC 12-24V
Output power: 300W
Material: ABS+Copper
Net weight: 80g



YJ-MCB023-2

BMW Cigarette Lighter
Plug to 3 Jacks

Input: DC 12-24V
Output power: 300W
Material: ABS+Copper



YJ-MCC004

20A/12V Motorcycle
Spotlight Switch

Input: DC 12-24V
MAX Amps: 20A
Net weight: 80g
Material: ABS+Copper
alloy+Copper



YJ-MCC011

Motorcycle Alu Handle
Switch

Product Size:
58*33mm



YJ-MCB024

12V Fish Clip Cigarette
Lighter with Cover

Input: DC 12-24V
Output power: 120W
Material: ABS+Copper



YJ-MCB025

Cigarette Lighter Plug to
2 Female Seat

Input: DC 12-24V
Output power: 120W
Material: ABS+Copper



YJ-WG12

Motorcycle Alu Handle
Dual Switch

Product Size:
36*20*18mm



YJ-MCC001

Motorcycle Alu Handle
with Three Switch

Product Size:
60*52*50mm



YJ-MCB026

Cigarette Lighter with
Cover

Input: DC 12V20A/24V10A
Output: 12V/20A
Material: ABS+Copper
Net weight: 60g



YJ-MCB026-1

BMW Cigarette Lighter
Plug to 2 Seat with Cover

Input: DC 12-24V
Output: 12V/20A
Material: ABS+Copper
Net weight: 100g



YJ-QT024

Gun Type Bike
Light Clip

Material: ABS
Net weight: 42g



YJ-MCB052

Full Circle
Motorcycle
Mount

Material: ABS
Size: 75mm



YJ-MCB011

12V Cigarette Lighter Socket(3004)

Input: DC 12V
Output: 12V
Material: ABS+Copper



YJ-MCB013

Cigarette

Input: DC 12-24V
MAX Amps: 12V20A/24V10A
Maximum power: 120W
Material: ABS+Copper
Hole size: 31mm(Dia)
Size: 37*37*65mm



YJ-MCB006

Car Cigarette lighter

Input: DC 12-24V
Material: ABS+Copper



YJ-MCB007

Cigarette Plugs -Red End Cap

Input: DC 12-24V
Material: ABS+Copper



YJ-MCB012

3004 Points Cigarette Butt in the Shell of a Large Coat

Input: DC 12-24V
Output: 5V/3.1A
Material: ABS+Copper
Size: 40*70*80mm
Net weight: 110g



YJ-MCB014B

12V Colorful Cigarette Lighter

Input: DC 12-24V
Output: DC 12V
Maximum power of cigarette lighter: 150W
Color: BU/YE/GN/RD



YJ-MCB008

FY832 Cigarette Lighter

Input: DC 12-24V
Material: ABS+Copper



YJ-MCB009

Cigarette Plugs -Red Bar Cap

Input: DC 12-24V
Material: ABS+Copper



YJ-MCB035

Waterproof Dual Hole DC12V+Cable

Input: DC 12-24V
MAX Amps: 12V20A/24V10A
Output power: 120W
Material: ABS+Copper
Size: 85*46*56mm
Net weight: 100g



YJ-MCB001

Car Cigarette Lighter

Input: DC 12V
MAX Amps: 12V/10A/120W
Material: ABS+Copper



YJ-MCB053

DE On-Off Cigarette Lighter

Input: DC 12-24V
Material: ABS+Copper



YJ-MCB056

15A Bakelite Cigarette Plugs

Input: DC 12-24V
Material: ABS+Copper
Light Color: RD



YJ-MCB002

BMW Socket

Input: DC 12V
MAX Amps: 10A
Output power: 120W
Material: ABS+Copper



YJ-MCB003

BMW Cigarette Lighter

Input: DC 12-24V
MAX Amps: 12V15A/24V10A
Material: ABS+Copper
Net weight: 19g

CIGARETTE WITH WIRE

>>>



YJ-MCB038
RJ45 Microphone Outlet

Input: DC 12-24V
Wire length: 1.5m



YJ-MCB004

Threaded BMW Socket

Input: DC 12-24V
MAX Amps: 12V15A/24V10A
Material: ABS+Copper
Size: 28*85mm
Net weight: 30g



YJ-MCB005

6 Corners BMW Socket

Input: DC 12-24V
MAX Amps: 12V20A/24V10A
Output: 120W
Material: ABS+Copper
Net weight: 15g



YJ-MCB028

LW-06 DC Cigarette Plugs

Input: DC 12-24V
Material: ABS+Copper
OD: 4.2mm



YJ-MCB043

Cigarette Socket with ACU

Input: DC 12-24V
Material: ABS+Copper
Wire length: 1m



YJ-MCB049

2-Core Aviation

Plug+Wire

Input: DC 12-24V
Material: ABS+Copper
OD: 0.3mm



YJ-MCB057

Clip-On Car
Cigarette Lighter

Input: DC 12-24V
Material: ABS+Copper
Wire length: 3m



YJ-MCB030

15A Bakelite
Cigarette Lighter
with Thread(red light)

Input: DC 12-24V
Material: ABS+Copper
Wire length: 0.48m



YJ-MCB058

12V 15A Bakelite
Cigarette Plug

Input: DC 12-24V
Material: ABS+Copper
Wire length: 3m



YJ-MCB062

15CM Cigarette
Plug

Input: DC 12-24V
Material: ABS+Copper



YJ-MCB010

Power Adapter

Input: DC 12-24V
Material: ABS+Copper



YJ-MCB031

Cigarette Plug
with Switch

Input: DC 12-24V
Material: ABS+Copper



YJ-MCB048

Bakelite Cigarette
Plug with Cover
(red light)

Input: DC 12-24V
Material: ABS+Copper
Wire length: 1m



YJ-MCB032

Bakelite Cigarette
Plugs with SAE
(red light)

Input: DC 12-24V
Material: ABS+Copper
Wire length: 1.3m



YJ-MCB042

Socket with Fuse
Box

Input: DC 12-24V
Material: ABS+Copper
Wire length: 1.2m



CIRCUIT BREAKER SERIES



YJ-DLQ01-1

E99 Circuit Breaker-Red Button

Input: DC12-36V
Material: PC+PBT+ABS+Copper
Optional Specifications: 30/40/50/60/70/80/90/100/120/150/200/250/300A

Performance Parameter

Product Name: Circuit Breaker	Size: 74*49*45mm
Material: Alloy/Fireproof/Fireproof ABS Plastic	Weight: 90g
Voltage: DC12V/24V/48V	Reset Type: Manual reset
Ampere Selection: 80A/100A/120A/200A/250A/300A	Applications: Car, Bus, Ship, RV



YJ-DLQ02
E99 Circuit Breaker
(Yellow)

Optional Specifications:
20A-200A



YJ-DLQ14
HQ Car Circuit Breaker

Optional Specifications:
50A/80A/100A/150A/
200A/250A/300A



YJ-DLQ15
150Amp Circuit
Breaker

Optional Specifications:
60A/100A/150A/250A



YJ-DLQ16
250Amp Circuit
Breaker

Optional Specifications:
50A/70A/100A/120A/
140A/180A/200A



YJ-DLQ05
E96 Manual Reset
Circuit Breaker (Yellow)

Optional Specifications:
200A-300A



YJ-DLQ04
E96 Manual Reset
Circuit Breaker (Red)

Optional Specifications:
300A



YJ-DLQ17
Car Audio Amplifier
Circuit Breaker

Optional Specifications:
30A/40A/60A/80A/100A



YJ-DLQ09
Manual Reset Circuit
Breaker (Red)

Optional Specifications:
20A/30A/40A/50A/60A/
70A/80A/90A/100A/150A



YJ-DLQ12
25A Circuit Breaker

Optional Specifications:
10A/15A/20A/25A/30A/
35A/40A/50A/60A/70A



YJ-DLQ13
High-Amp Circuit
Breaker

Optional Specifications:
10A/15A/20A/25A/30A/
35A/40A/50A/60A/70A



YJ-DLQ10
100Amp Circuit Breaker

Optional Specifications:
80A/100A/120A/150A/
200A/250A/300A



YJ-DLQ11
Manual Reset Circuit
Breaker with Cover

Optional Specifications:
40A/50A/60A/80A/100A/
140A/150A/200A/250A/300A

WATERPROOF CIRCUIT BREAKER



FUNCTION: Suitable for overload protection of the car audio / video system, avoiding excessive current, protect the electrical device, apply by connecting the audio power line, used in place of an in-line fuse holder. Manual open circuit push button, self-test and manual replacement, no fuse change problem.

OPEN CIRCUIT PROTECTION: When the current reaches the cut-off value, the long handle will automatically open to cut off the power supply. Generally, the short-circuit condition will jump out. After the fault is eliminated, press the long handle back to the original position to form a path.

MANUAL POWER OFF: We need to disconnect the circuit when refitting, directly press the elliptical red button on the fuse, then the long handle will automatically pop up to cut off the power supply. Connect the same as above, then press the long handle back to the original position.

YJ-DLQ01

E99 Manual Reset circuit breaker
(red btn.Import series)



Optional Specifications:
20A-200A

YJ-DLQ03

E99 Manual Reset circuit breaker
(yellow btn.local series)



Optional Specifications:
20A-200A

YJ-DLQ08

Green button circuit breaker
(gold handle)



Optional Specifications:
10A/15A/20A/25A/30A/
35A/40A/50A/60A/70A

YJ-DLQ20

Circuit breaker



Optional Specifications:
80A,100A,150A,200A,250A 300A

YJ-DLQ04-1

E96 Manual Reset circuit breaker
(red btn.Import series)



Optional Specifications:
200A-300A

YJ-DLQ06

E96 Manual Reset circuit breaker
(yellow btn.local series)



Optional Specifications:
300A

YJ-DLQ23

Manual recovery of circuit breakers



Optional Specifications:
CB9 4/8GA IM-4/8GA OUT
(10-150A)

YJ-DLQ24

Green button circuit breaker
(silver handle)



Optional Specifications:
CB1-1 4/8GA IM-4/8GA OUT
(10-150A)

YJ-DLQ07

circuit breake



Optional Specifications:
10A/15A/20A/25A/30A/
35A/40A/50A/60A/70A

YJ-DLQ21

High temperature resistant self
recovery (black) button



Optional Specifications:
CB4-1 0/4GA IM-0/4GA OUT (50-300A)

YJ-DLQ25

Automatic circuit breaker



Optional Specifications:
CB8 0/4GA IM-0/4GA OUT
(50A-300A)

YJ-DLQ27

3ANL3 car audio power fuse holder1/3



Optional Specifications:
Equipped with a 150A fuse

YJ-DLQ19

E99 circuit breaker manual reset
(yellow) button



Optional Specifications:
150A/200A

YJ-DLQ22

High current circuit breaker



Optional Specifications:
CB3 50-300A



YJ-DLQ26

CB6 car audio circuit breaker
(yellow button)

Optional Specifications:
30A/40A/50A/60A/
80A/100A/150A/200A/250A/300A

ANDERSON TENT SERIES

- | | | |
|---|--|---|
|  <p>YJ-ZP001
One Hole Tent
Material: ABS
Size: 55*50*80mm
Hole size: 29mm
Color: BK/WH/Beige</p> |  <p>YJ-ZP002
Two Hole Tent
Material: ABS
Size: 98*50*80mm
Hole size: 29mm
Color: BK/WH/Beige</p> |  <p>YJ-ZP002-1
Three Hole Tent
Material: ABS
Size: 150*50*80mm
Hole size: 29mm
Color: BK/WH</p> |
|  <p>YJ-ZP017
Aderson One Hole Tent
Material: ABS
Color: BK/WH
Regular: 2 Screw Holes</p> |  <p>YJ-ZP017-2
Aderson Two Hole Tent
Material: ABS</p> |  <p>YJ-ZP017-1
Aderson Three Hole Tent
Material: ABS
Color: BK/WH</p> |
|  <p>YJ-ZP018
50A Aderson One Hole Tent
Material: ABS
Type: One Hole/Two Hole
Regular: 4 Screw Holes</p> |  <p>YJ-ZP017-3
Aderson Square and Round Hole Tent
Material: ABS</p> |  <p>YJ-ZP015
New Two Hole Tent
Material: ABS
Color: BK/WH</p> |
|  <p>YJ-ZP004-1
Special Three Hole Tent
Material: ABS
Color: BK/WH</p> |  <p>YJ-ZP005-1
Special Two Hole Tent
Material: ABS
Color: BK/WH</p> |  <p>YJ-ZP006-1
New One Hole Tent
Material: ABS
Color: BK/WH</p> |
|  <p>YJ-ZP021-1
One Hole Tent
Material: ABS
Color: BK/GY/BU</p> |  <p>YJ-ZP021-2
Two Hole Tent
Material: ABS
Color: BK/GY/BU</p> |  <p>YJ-ZP021-3
Three Hole Tent
Material: ABS
Color: BK/GY/BU</p> |
|  <p>YJ-QT018
One Gang Bar Mount
Material: ABS
Size: 98*55*82mm
Hole size: 29mm
Color: YE</p> |  <p>YJ-BS010
One-Hole Bracket
Material: ABS
Size: 150*105mm
Hole size: 29mm</p> |  <p>YJ-QT020
Quick Nut
Material: ABS</p> |

ANDERSON SERIES

Anderson Accessories Series



YJ-ADS09 175A/4AWG Battery Connectors

Wire specifications	4AWG
Length	500mm
Product specifications	SC35-8*2
Current	175A
Weight	476g



YJ-ADS09 175A/8AWG Battery Connectors

Wire specifications	8AWG
Length	500mm
Product specifications	SC10-8*2
Current	175A
Weight	153g



YJ-ADS38 50A/8AWG Battery Connectors

Wire specifications	8AWG
Length	300mm
Product specifications	+Bellows
Current	50A
Weight	237g



YJ-ADS37 50A/8AWG Unipolar Battery Connectors

Wire specifications	8AWG
Length	500mm
Product specifications	+DS75 Black Red
Current	50A
Weight	307g

**YJ-ADS15**

Product specifications	175A/8AWG Connector to Alligator
Current	175A

**YJ-ADS39**

Product specifications	50A Anderson Connector
Current	50A

**YJ-ADS12**

Product specifications	Dual SG50A Battery Connector with Foldable
Length	300mm
Current	50A

**YJ-ADS16**

Product specifications	50A Ring Terminal Connector
Product specifications	SC10-8*3
Current	50A
Length	500mm

**YJ-ADS19**

Product specifications	50A Battery Connector for Cigarette Lighter
Product specifications	16AWG
Current	50A
Length	300mm

**YJ-ADS25**

Product specifications	50A Battery Connector for Cigarette Lighter
Current	50A

**YJ-ADS18**

Product specifications	350A One to Six Battery Connector with Fixed Plug
Length	500mm
Current	350A

**YJ-ADS14-1**

Product specifications	50A Dual Connector
Current	50A

**YJ-ADS20**

Product specifications	Battery Connector for Cigarette Lighter Socket
Current	50A

**YJ-ADS21**

Product specifications	Battery Connector Dual Cigarette Lighter Socket
Current	50A

**YJ-ADS14**

Product specifications	50A Dual Battery Connector
Current	50A

**YJ-ADS24**

Product specifications	50A Fuse Holder+ Ring Terminal Connector
Length	500mm
Current	50A
Product specifications	SC25-8

**YJ-ADS23**

Product specifications	Dual MC4 Plug Battery Connector
Current	50A

**YJ-ADS08**

Product specifications	8AWG Anderson Terminal
Current	50A

**YJ-ADS40**

Product specifications	50A Battery Connector for DS Refrigerator Socket
Current	50A

**YJ-ADS40**

Product specifications	50A Connector with DS USB Charger
Current	50A

**YJ-ADS13**

Product specifications	50A One to Two Battery Connector
Current	50A

**YJ-ADS10**

Product specifications	SG50A One to Two Battery Connector
Length	300mm
Current	50A

**YJ-ADS17**

Product specifications	One to Two 50A Battery Connector with Cover
Length	900mm
Current	50A



Anderson 120A

Anderson 175A

YJ-SJ50Hs/H/R 50A/120A/175A/350A/Triple Pole Anderson GY/RD/BK



Anderson Cover RD/BK

50A/ 120A/ 175A/ 350A



50A/ 120A/ 175A/ 350A



Unipolar Anderson



Anderson Plug with Bezel 50A

YJ-ADS50HS-A



YJ-ADS50H-A



50A/120A/350A Anderson Holder



YJ-ADS32-1/27-1/27



Anderson Hardware Terminals





Anderson Empty Plastic Plate



YJ-MB028

Anderson Single Plate



YJ-MB022

2-Hole Anderson Plate



YJ-MB022-1

3-Hole Anderson Plate



YJ-MB029

Anderson 1 to 1 Plate



YJ-MB029-1

Anderson 1 to 2 Plate

Anderson Empty Aluminum Plate



YJ-LB080

2-Gang 50A Anderson Plate with 8PCS Screw

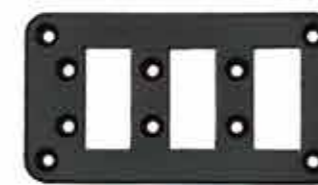

YJ-LB081

3-Gang 50A Anderson Plate with 10PCS Screw

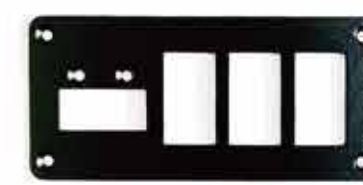

YJ-LB189

3-Gang Switch+Anderson Plate with 6PCS Screw



YJ-LB219

2-Gang DS+Anderson Plate with 8PCS Screw



YJ-LB188B

2-Gang DS+Anderson Plate with 8PCS Screw



YJ-LB188A

2-Gang DS+Anderson Plate with 8PCS Screw



YJ-LB119

3-Gang DS+3-Gang Anderson Plate with 10PCS Screw

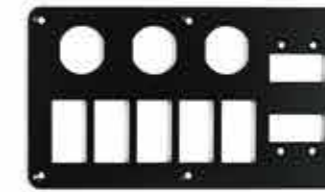

YJ-LB191

3-Gang Switch+3-Gang DS +2-Gang Anderson Plate with 10PCS Screw

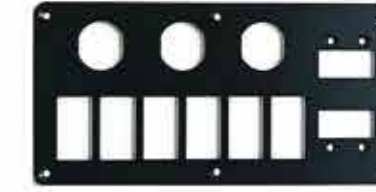

YJ-LB192

6-Gang Switch+3-Gang DS +2-Gang Anderson Plate with 10PCS Screw



YJ-LB087

4-Gang DS+2-Gang Anderson Plate with 8PCS Screw



YJ-LB129

4-Gang DS+3-Gang Switch Anderson Plate with 6PCS Screw

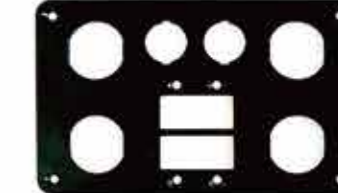

YJ-LB130

4-Gang DS+2-Gang Switch +2-Gang Anderson Plate with 8PCS Screw



YJ-LB128

2-Gang DS+Anderson Plate +Switch with 6PCS Screw

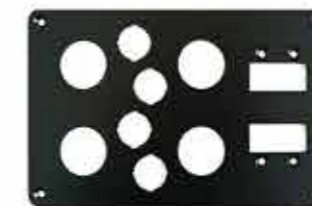

YJ-LB190

4-Gang DS+4-Gang Switch +2-Gang Anderson Plate with 8PCS Screw

Anderson Panel Series



YJ-ADSP001
Anderson Single Plate
Material: ABS+plastic



YJ-ADSP016
2-Hole Anderson Plate
Material: ABS+plastic



YJ-ADSP009
2-Hole Anderson Plate
(Black)
Material: ABS+plastic



YJ-ADSP010-1
3-Hole Anderson Plate
(Grey)
Material: ABS+plastic



YJ-ADSP010
3-Hole Anderson Plate
(Black)
Material: ABS+plastic



YJ-ADSP002
1-Hole 1-Gang
Anderson Plate
Material: ABS+plastic



YJ-ADSP003
2-Hole 1-Gang
Anderson Plate
Material: ABS+plastic



YJ-ADSP032
2-Hole 1-Gang
Anderson Alu Plate
Material: ABS+plastic



YJ-ADSP013
2-Hole 2-Gang
Anderson Plate
Material: ABS+plastic



YJ-ADSP015
4-Hole 2-Gang
Anderson Alu Plate
Material: ABS+plastic

Anderson Panel Series



YJ-ADSP004
6-Hole 2-Gang
Anderson Plate
Material: ABS+plastic



YJ-ADSP005
3-Hole 3-Gang
Anderson Plate
Material: ABS+plastic



YJ-ADSP027
3-Gang 1-Anderson
Alu Plate
Material: ABS+plastic



YJ-ADSP030
5-Gang 3-Hole
2 Anderson Alu Plate
Material: ABS+plastic



YJ-ADSP031
6-Gang 3-Hole
2 Anderson Alu Plate
Material: ABS+plastic



YJ-ADSP025
4-Gang 2-Hole
2 Anderson Alu Plate
Material: ABS+plastic



YJ-ADSP021
One Hole 50A
Anderson Tent
Material: ABS+plastic



YJ-ADSP022
Two Hole 50A
Anderson Tent
Material: ABS+plastic



YJ-ADSP023
Three Hole 50A
Anderson Tent
Material: ABS+plastic



YJ-ADSP024
Anderson+DS Tent
Material: ABS+plastic



YJ-ADSP025-1

6 Way 3 Hole+2
Anderson panel(Plc)

Material: ABS+Plastic

YJ-ADSP025-4

8 Way 2 Hole+2
Anderson Panel

Material: ABS+Plastic



BATTERY SWITCH SERIES

YJ-WBS005



Product name	275A Battery Switch
Material	Plastic+Copper
Terminal specifications	M10
Terminal position	2-Gang
Continuous current	275A
Function	Protect the power supply

YJ-WBS008-50



Product name	50A Battery Switch
Material	Plastic+Copper
Screw diameter	4mm
Operating current	50A
Voltage	DC12-24V
Function	Protect the power supply

YJ-WBS008-100



Product name	100A Battery Switch
Material	Plastic+Copper
Screw diameter	6mm
Operating current	100A
Voltage	DC12-24V
Function	Protect the power supply

YJ-WBS008-200



Product name	200A Battery Switch
Material	Plastic+Copper
Screw diameter	8mm
Operating current	200A
Voltage	DC12-24V
Function	Protect the power supply

YJ-WBS006



Product name	200A Battery Switch
Material	Plastic+Copper
Screw diameter	10mm
Operating current	200A
Voltage	DC12-24V
Function	Protect the power supply

YJ-WBS028



Product name	275A Battery Switch
Material	Plastic+Copper
Terminal specifications	M10
Terminal position	2-Gang
Continuous current	275A
Function	Protect the power supply

YJ-WBS013



50A/ON-OFF

Product name	50A Battery Switch
Material	Plastic+Copper
Screw diameter	4mm
Operating current	50A
Voltage	DC 12-24V
Function	Protect the power supply

YJ-WBS014



100A/ON-OFF

Product name	100A Battery Switch
Material	Plastic+Copper
Screw diameter	6mm
Operating current	100A
Voltage	DC 12-24V
Function	Protect the power supply

YJ-WBS015



200A/ON-OFF

Product name	200A Battery Switch
Material	Plastic+Copper
Screw diameter	8mm
Operating current	200A
Voltage	DC 12-24V
Function	Protect the power supply

YJ-WBS016



300A/ON-OFF

Product name	300A Battery Switch
Material	Plastic+Copper
Screw diameter	10mm
Operating current	300A
Voltage	DC 12-24V
Function	Protect the power supply

This product is suitable for racing cars, various motorhomes, modified fast racing cars, yachts, etc., and can be used as a switch key for various electrical equipment added inside and outside the car.

YJ-WBS007/-600



Product name	500A Battery Switch
Material	Plastic+Copper
Screw diameter	10mm
Rated current	500A / 600A
MAX Voltage	DC 48V
Function	Protect the power supply



YJ-WBS019

Product name	DC 48V Battery Switch
Material	Plastic+Copper
Screw size	2*12mm
Rated current	350A
MAX Voltage	DC 48V
Function	Protect the power supply

YJ-WBS026-4



Product name	350A Battery Switch
Material	Copper+Plastic
Screw diameter	10mm
Operating current	350A /ON-OFF
Voltage	DC 32V
Function	Protect the power supply

YJ-WBS002



Product name	4-Speed Battery Switch
Material	Plastic
Size	140*140*85mm
Weight	600g
Continuous current	175A
Function	Protect the power supply

YJ-WBS001



Product name	250A Battery Switch
Temperature	-40° C~+60° C
Continuous current	250A
Function	Protect the power supply



YJ-WBS017

Product name	300A Battery Switch
Material	ABS+metal
Size	60*45mm
Operating current	300A
Voltage	DC 12-24V
Function	Protect the power supply

YJ-WBS021



Product name	300A Battery Switch
Material	Copper+Plastic
Screw diameter	10mm
Operating current	300A
Voltage	DC 32V
Function	Protect the power supply

YJ-WBS024 /-300



Product name	250A Battery Switch
Size	93.2*66.8mm
Screw diameter	10mm
Operating current	250A /300A
Voltage	DC 12-24V
Function	Protect the power supply



YJ-WBS020

Product name	250A Battery Switch
Material	Copper+metal
Screw diameter	10mm
Operating current	250A
Voltage	DC 12V
Function	Protect the power supply

YJ-WBS009-100/-200



Product name	100A Battery Switch
Material	Plastic+Copper
Screw diameter	8mm /10mm
Operating current	100A/200A
Voltage	DC 12-24V
Function	Protect the power supply



YJ-WBS009-100A/-200A

Product name	200A Battery Switch
Material	Plastic+Copper
Screw diameter	8mm/10mm
Operating current	100A/200A
Voltage	DC 12-24V
Function	Protect the power supply

YJ-WBS010



Product name	100A Battery Switch
Material	Plastic+Copper
Screw diameter	8mm /10mm
Operating current	100A
Voltage	DC 12-24V
Function	Protect the power supply

YJ-WBS027-275 Battery Switch

Wide Range of Use



OFF



ON



Description of goods

Size: 68*68*30mm	Rated current: 600A	Continuous current: 275Amps DC
Max voltage: 48V-60Volts DC	Dielectric strength: 1500VAC/1min	Screw diameter: 10mm

Application: this series of products are mainly used in automobile battery rotating switch power off. Battery-operated switches for automobiles. High-current full-car power-off rotary switch. A power-off switch for farm vehicles. This modified speed car combination switch. It can be used as the on/off key of all kinds of electrical equipment added inside and outside the car. Quick and easy to disconnect the battery, good quality, easy to install, easy to operate



YJ-WBS018

Battery Separator with Voltage (corrugated model)

Product name	140A Battery Switch with Volt
Size	66.5*66.5*52.2mm
Screw diameter	6mm
Operating current	140A
Voltage	DC12-24V
Function	Protect the power supply
Waterproof grade	IP67



YJ-WBS011

12V/140A Battery Isolator

Product name	140A Battery Switch
Size	68*68*52mm
Screw diameter	6mm
Operating current	140A
Voltage	DC12-24V
Function	Protect the power supply
Waterproof grade	IP67



YJ-WBS026-1

Product name	300A Battery Switch
Material	Copper+Plastic
Screw diameter	10mm
Operating current	300A
Voltage	DC 32V
Function	Protect the power supply



YJ-WBS035

Dual Battery Isolation Intelligent Controller

Product name	140A Battery Switch
Size	68*68*52mm
Screw diameter	6mm
Operating current	140A
Voltage	DC12-24V
Function	Protect the power supply
Waterproof grade	IP67



TERMINAL SERIES



YJ-TP02R



YJ-TP02 H

**M8
M10** -Double Stud Strip Connector

Colour: Red / Black



YJ-TP01R

M6 dual terminal post connector

Product Size: 120*40*42mm
Rated power: 150A 48VCD
Material: Copper/Nylon
Colour: Red



YJ-TP01H

Product Size: 120*40*42mm
Rated power: 150A 48VCD
Material: Copper/Nylon
Colour: Black

Terminal Block series



YJ-TP03H/R

M10 single stud stud stud
Colour: Red/Black



YJ-TP07H/R

High Current Power Supply Terminal
Colour: Black /Red
IF-FM8M5-5225-35-150A



YJ-TP04H/R

3/8 single stud bolt
Colour: Red/Black



YJ-TP08H/R

M 8 terminal
Colour: Black /Red



YJ-TP06H/R

8 Busbar Stud 300A High Current
Colour: Red/Black