

W100 Model Wireless Vacuum Cleaner Specification



Product Display



Product Features:

- Simple and practical appearance, lightweight
- Rechargeable wireless vacuum cleaner, pushrod, handheld dual-use
- Strong suction power, two-speed speed adjustment
- Transparent large-capacity dust cup, One-click dust dumping
- Cyclone filtration system, high efficiency HEPA filtration
- Light circle indication
- Detachable battery pack
- Retractable metal tube
- Electric floor brush with soft fur roller brush
- The floor brush is equipped with lighting to clearly illuminate the cleaning scene
- Equipped with a variety of suction head, suitable for different scenes
- Storage wall bracket, convenient and practical to store

Product Specifications:

Rated Voltage	DC 22.2V
Rated power	180W (150W for main motor)
Vacuum level(KPa)	≥8 (standard gear)/≥11.5 (high gear)
Efficiency(%)	≥20%
Air volume(m ³ /min)	≥0.8
Noise(dB)	75
Dust bucket volume (L)	0.8
Dust pouring method	One-click dust dumping
Control method	Electronic control
Indicator light	Two-color light circle indication
Filter layer material	Cyclone filtration + high efficiency HEPA filtration
Metal telescopic tube	Telescopic length 435-655mm
Motor speed (RPM)	41000
Battery capacity (mAh)	6 sections of 18650 lithium 2600mAh
Endurance time (min)	High gear ≥18min/standard gear ≥40min
Charging time (hour)	About 5 hours (standard with adapter)
Charger specification	Output 27VDC 0.5A
Product Size	240mm*110mm*1010mm
Product Weight	Net weight 2.15KG/gross weight 3.75KG
Accessories	Two-in-one brush, long flat suction, wall bracket
Product main material	ABS;PC

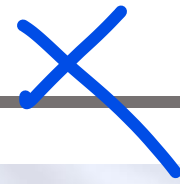

2600mAh High-Quality Lithium Battery

+ Two Speed Adjustment

- Standard mode**
35min
dust, hair, scraps
- Strong mode**
20min
gravel, dog food, coffee beans

4-5h Fast Charge



Multiple Accessories for Multifunctional Use





ELECTRIC BRUSH WITH LED

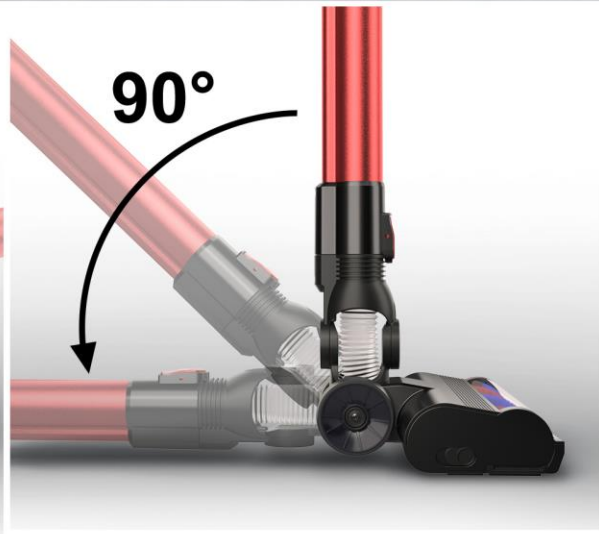

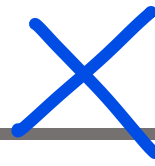

W200 Model Wireless Vacuum Cleaner Specification

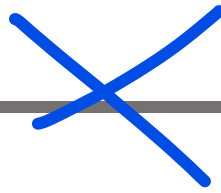

Product Display



Product Features:

- Simple and practical appearance, lightweight
- Rechargeable wireless vacuum cleaner, pushrod, handheld dual-use
- Strong suction power, two-speed speed adjustment
- Transparent large-capacity dust cup, One-click dust dumping
- Double cyclone filtration system
- Stainless steel filter + high efficiency filter cotton
- Real-time power display
- Built-in battery pack
- Retractable metal tube
- Low noise, more secure to use
- Detachable electric floor brush with soft fur roller brush
- Quiet floor brush, 360 degree adapters, flexible use
- The floor brush is equipped with lighting to clearly illuminate the cleaning scene
- Equipped with a variety of suction head, suitable for different scenes
- Storage wall bracket, convenient and practical to store

Product Specifications:

Rated Voltage	DC 22.2V
Rated power	180W (150W for main motor)
Vacuum level(KPa)	≥6 (standard gear)/≥11 (high gear)
Suction power(W)	25W
Efficiency(%)	≥18%
Air volume(m3/min)	≥0.5
Noise(dB)	75
Dust bucket volume (L)	0.8
Dust pouring method	One-click dust dumping
Control method	Electronic control
Display screen	Yes, real-time power display
Filter layer material	Double cyclone + electrostatic cotton
Metal telescopic tube	Telescopic length 435-655mm
Motor speed (RPM)	40000
Battery capacity (mAh)	6 sections of 18650 lithium battery 2000mAh
Endurance time (min)	High gear ≥15min/standard gear ≥30min
Charging time (hour)	About 4.5 hours (standard with adapter)
Charger specification	Output 27VDC 0.5A
Product Size	203mm*110mm*1120mm
Product Weight	Net weight 2.4KG/gross weight 3.35KG
Accessories	Two-in-one brush, long flat suction, wall bracket
Product main material	ABS; PC

LED residual power display





EASY STORAGE & UNIQUE EXTENSION



Wall Mount

Safe semi-hung design, stable on the wall



P1 Model Cordless Vacuum Cleaner Specification



product appearance



product special features :

- 1、 Look simple, practical, and lightweight
- 2、 Rechargeable wireless vacuum cleaner, push rod, hand held dual purpose
- 3、 brushless motor (digital motor) , speed up to 65,000 rpm
- 4、 strong suction, two speed regulation
- 5、 transparent large-capacity dust cup, a key to pour dust
- 6、 Dual cyclone filtration system
- 7、 Stainless steel filter + high efficiency filter cotton
- 8、 Real time power consumption display
- 9、 removable battery pack
- 10、 adjustable metal tube
- 11、 Low Noise, safer to use
- 12、 Removable electric floor brush with soft bristles
- 13、 Silent Brush, 360 degree adapter, flexible
- 14、 Floor brushes are equipped with lighting that clearly illuminates and cleans the scene
- 15、 Configure a variety of suction head, suitable for different scenarios
- 16、 storage wall bracket, storage convenient and practical

product specification :

voltage	DC 22.2V
power	BLDC 180W
vacuum(KPa)	≥8 (low speed) / ≥16.5(high speed)
suction power	45W
efficiency	≥25%
air volume	≥0.55(m3/min)
noise(dB)	75
dust cup capacity	0.8L
cleaning method	a key to pour
control	electronic control
display	real time power consumption display
filter material	dual cyclone+filter cotton
adjustable metal tube	440-620mmadjustable height440-620mm
motor speed (RPM)	65000
(mAh) battery capacity	six pcs 18650 lithium battery、 2200mAh
durable time	high speed≥18min/low speed≥40min
charging time	about 4.5h
adaptor	output 27VDC 0.5A
product size	233mm*100mm*1150mm
product weight	N.W.2.3KG/G.W.3.3KG
accessories	2in1 bristle tool, crevice tool, wall bracket
main material	ABS; PC

LED Display

Everything Under Your Control

Suction Control Button

Remaining Battery Display

4 Stage Filtration Reduction Fresh Air

Twice Times Better Than
Traditional One

High Performance Screening

Stainless Steel Mesh Filter

Sponge Filtration

Cyclone Technology

brushless motor

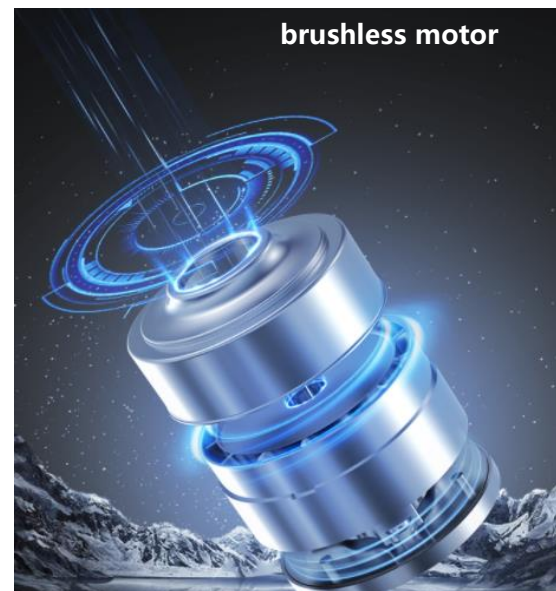

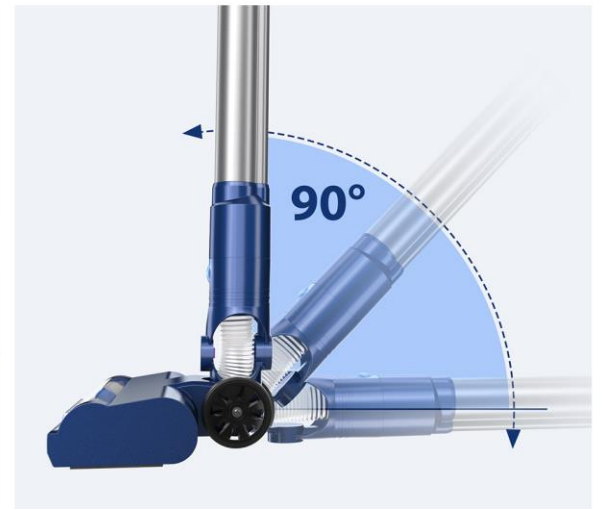
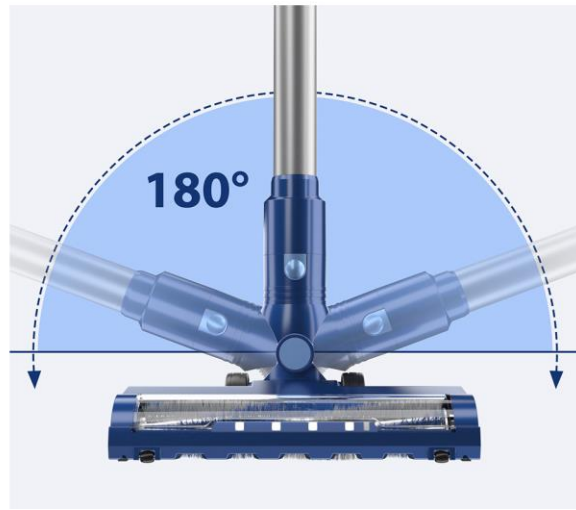

What's Included?

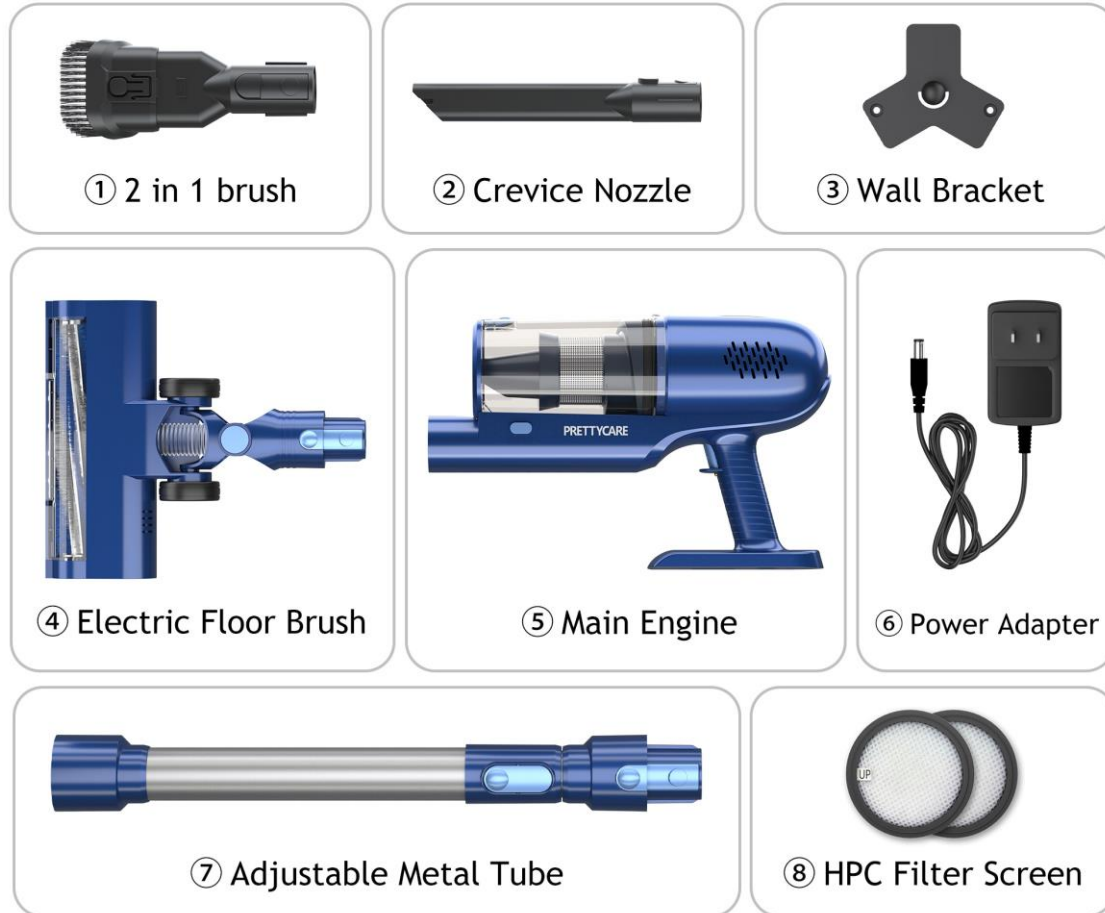

P2 Model Cordless Vacuum Cleaner Specification

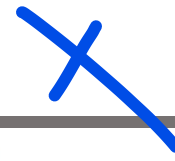

product appearance

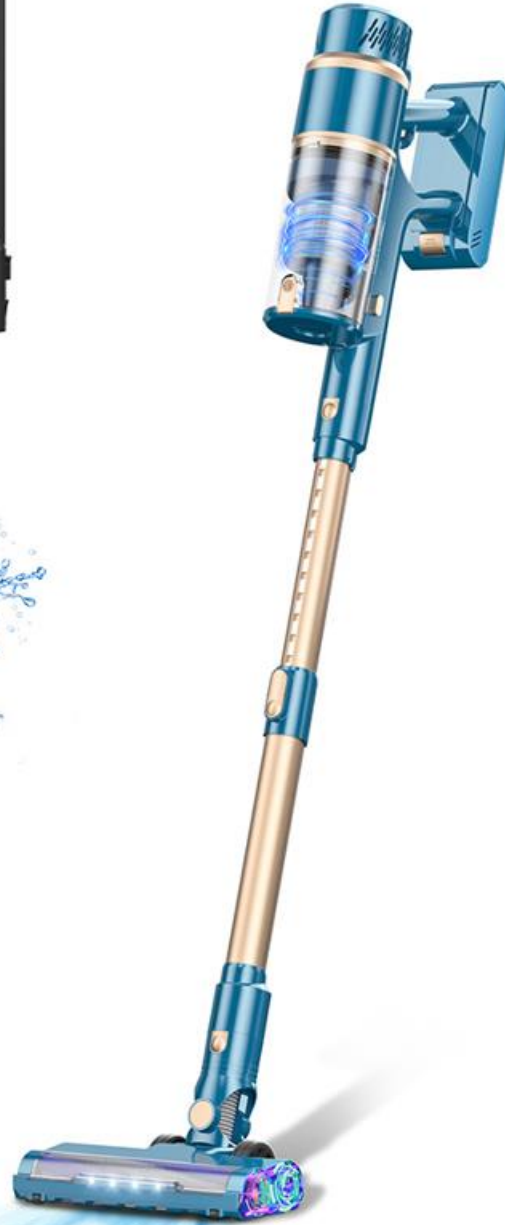

Product features :

1. Look simple, practical, and lightweight
2. Rechargeable wireless vacuum cleaner, push rod, hand held dual purpose
3. brushless motor (digital motor) , speed up to 70,000 rpm 4, strong suction, two speed regulation
- 4, transparent large-capacity dust cup, a key to pour dust
5. Dual cyclone filtration system
6. Stainless steel filter + high efficiency filter cotton
7. Real time power consumption display
8. large capacity removable battery pack, 7 cells, can be charged to the battery pack alone
9. Retractable metal tube
10. Low Noise, safer to use
11. Removable electric floor brush with soft bristles
12. Silent Brush, 360 degree adapter, flexible
13. Floor brushes are equipped with lighting that clearly illuminates and cleans the scene
14. Configure a variety of suction head, suitable for different scenarios
- 15, storage wall bracket, storage convenient and practical

Specification :

●Color:	Customizes
●Product Dimension	115*25*10cm
●Safety Standard:	CE/CB/ETL/PSE
●Rating Voltage	DC25.9V
●Motor Vacuum	11Kpa/20Kpa
●Motor Speed	70000 (Rpm)
●Batteries Type	DC25.9V 18650 /2200mA 7 cells Lithium batteries
●Charging hours	4-5h
●Working time:	Fast: 18min Middle ● Slow: 40min
●Noise:	≤75d(B)
●Dust capacity:	0.8L
●Nominal power :	210W(Brushless Motor)
●Battery Life:	500Cycle
●Charging/Discharging Indicator	Yes
●Tools on-board	Yes
●Air Inlet	HEPA (H10)
Giftbox size	445*255*193mm
Giftbox N. W/G. W	2.8kg/3.5kg
20"GP	1140
40"GP	2350
40"HGP	2768

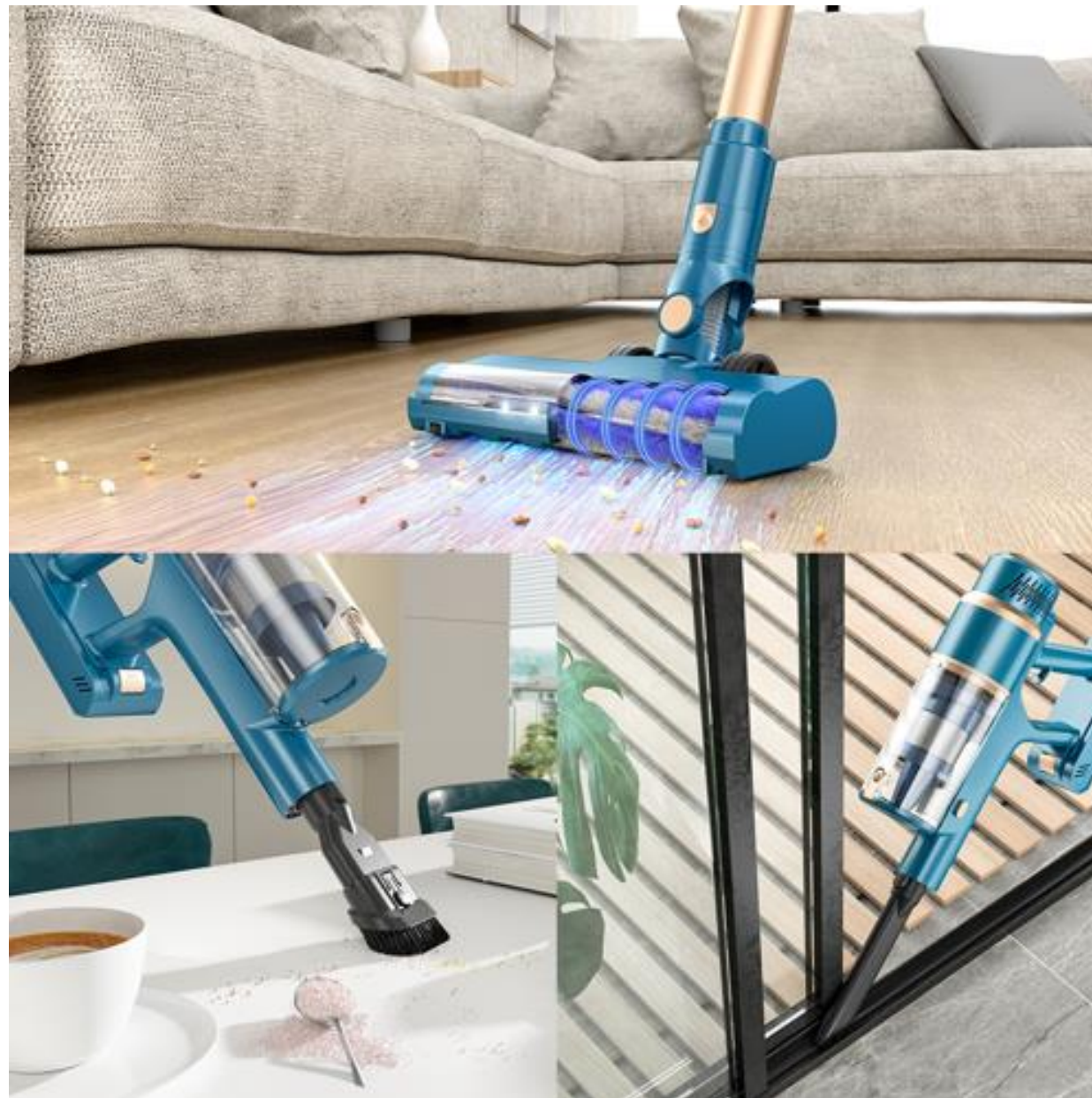





brushless motor





P3 Model Wireless Vacuum Cleaner Specification



Product Display



Product Features:

- Simple and practical appearance, lightweight
- Rechargeable wireless vacuum cleaner, pusher, handheld dual-use
- brushless motor (digital motor),Strong suction power, two-speed speed adjustment
- Transparent large-capacity dust cup,One-click dust dumping
- Double cyclone system, high efficiency filter cotton
- Real-time power display
- Detachable battery pack, double charging port
- Retractable metal tube
- Electric floor brush with soft fur roller brush
- The brush is equipped with lighting, clearly illuminate the cleaning scene
- Equipped with a variety of suction head, suitable for different scenes
- Storage wall bracket, convenient and practical to store

Product Specifications:

Rated Voltage	DC 22.2V
Rated power	210W
Vacuum level(KPa)	≥10 (standard gear)/≥20 (high gear)
Suction power(W)	60W
Efficiency(%)	≥30%
Air volume(m ³ /min)	≥0.8
Noise(dB)	75
Dust bucket volume (L)	0.8
Dust pouring method	One-click dust dumping
Control method	Electronic control
Display screen	Yes, real-time power display
Filter layer material	Double cyclone + electrostatic cotton
Metal telescopic tube	Telescopic length 435-655mm
Motor speed (RPM)	brushless motor ,65000
Battery capacity (mAh)	6 sections of 18650 lithium battery 2500mAh
Endurance time (min)	High gear ≥18min/standard gear ≥40min
Charging time (hour)	About 5 hours (standard with adapter)
Charger specification	Output 27VDC 0.5A
Product Size	233mm*100mm*1120mm
Product Weight	Net weight 2.4KG/gross weight 3.35kG
Accessories	Two-in-one brush, long flat suction, wall bracket
Product main material	ABS; PC

LED Panel Display



LED Touch Display



35min
dust, hair, scraps



20min
gravel, dog food, coffee beans



Four Stage Filter



Notices:
The washed filter cotton and stainless steel filter must be completely dry before they can be put into the dust cup for use

brushless motor



2600mAh Detachable Battery



P4 Model Wireless Vacuum Cleaner Specification

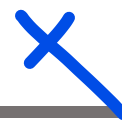

Product Display



Product Features:

- Simple and practical appearance, lightweight
- Rechargeable wireless vacuum cleaner, pusher, handheld dual-use
- brushless motor (digital motor),Strong suction power, two-speed speed adjustment
- Transparent large-capacity dust cup, One-click dust dumping
- Double cyclone system, high efficiency filter cotton
- Real-time power display
- Retractable metal tube
- Electric floor brush with soft fur roller brush
- The brush is equipped with lighting, clearly illuminate the cleaning scene
- Equipped with a variety of suction head, suitable for different scenes
- Storage wall bracket, convenient and practical to store

Product Specifications:

Rated Voltage	DC 22.2V
Rated power	BLDC 210W
Vacuum level(KPa)	≥10 (standard gear)/≥20 (high gear)
Suction power(W)	60W
Efficiency(%)	≥30%
Air volume(m3/min)	≥0.8
Noise(dB)	75
Dust bucket volume (L)	0.8
Dust pouring method	One-click dust dumping
Control method	Electronic control
Display screen	Yes, real-time power display
Filter layer material	Double cyclone + electrostatic cotton
Metal telescopic tube	Telescopic length 435-655mm
Motor speed (RPM)	brushless motor ,65000
Battery capacity (mAh)	6 sections of 18650 lithium battery 2500mAh
Endurance time (min)	High gear ≥18min/standard gear ≥40min
Charging time (hour)	About 5 hours (standard with adapter)
Charger specification	Output 27VDC 0.5A
Product Size	233mm*100mm*1120mm
Product Weight	Net weight 2.3KG/gross weight 3.3kG
Accessories	Two-in-one brush, long flat suction, wall bracket
Product main material	ABS; PC

QUADRUPLE FILTRATION SYSTEM

CAN CAPTURES 99.99% OF FINE PARTICLES AS SMALL AS 0.1UM

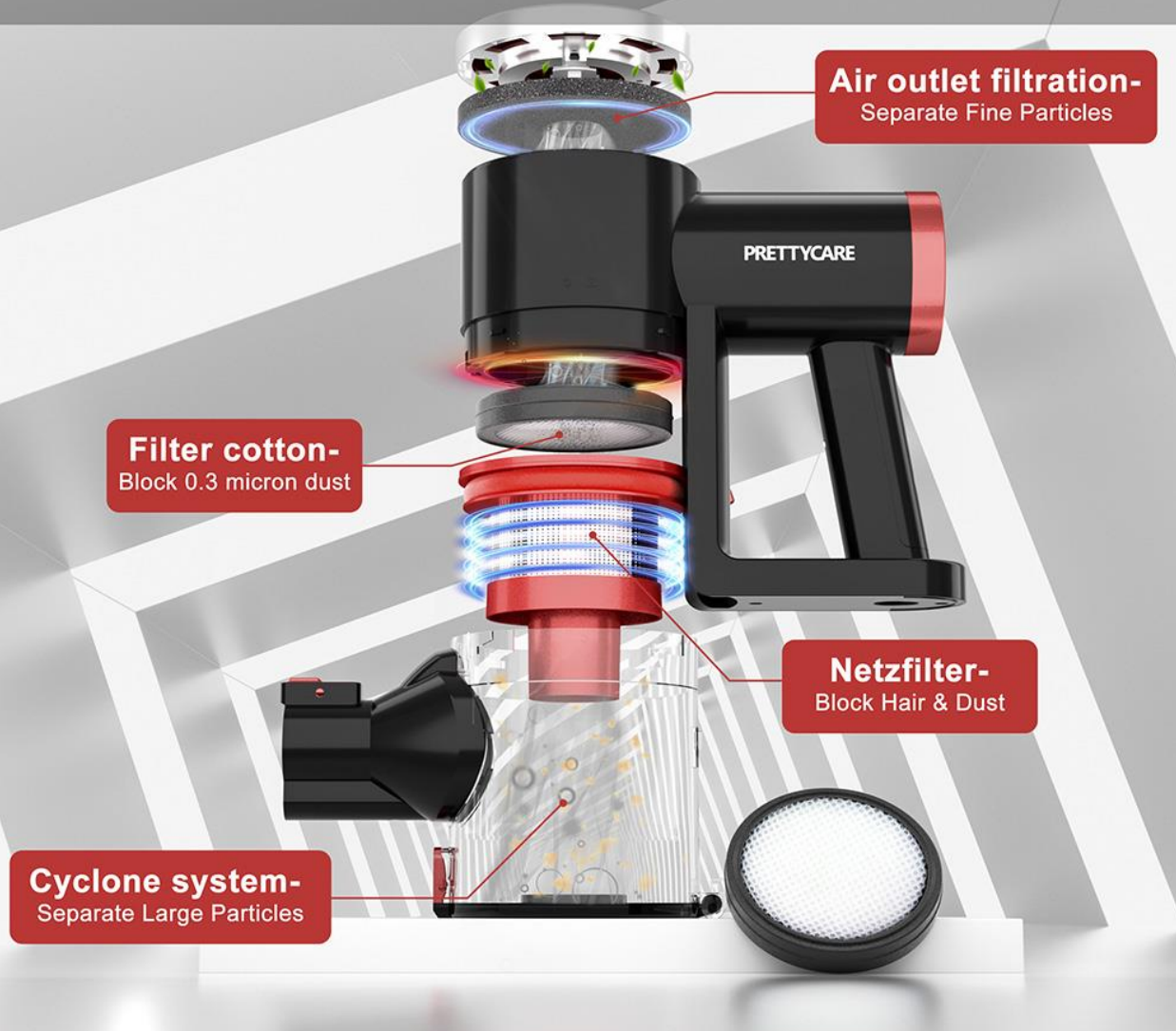

UNDETACHABLE & LED RESIDUAL POWER DISPLAY

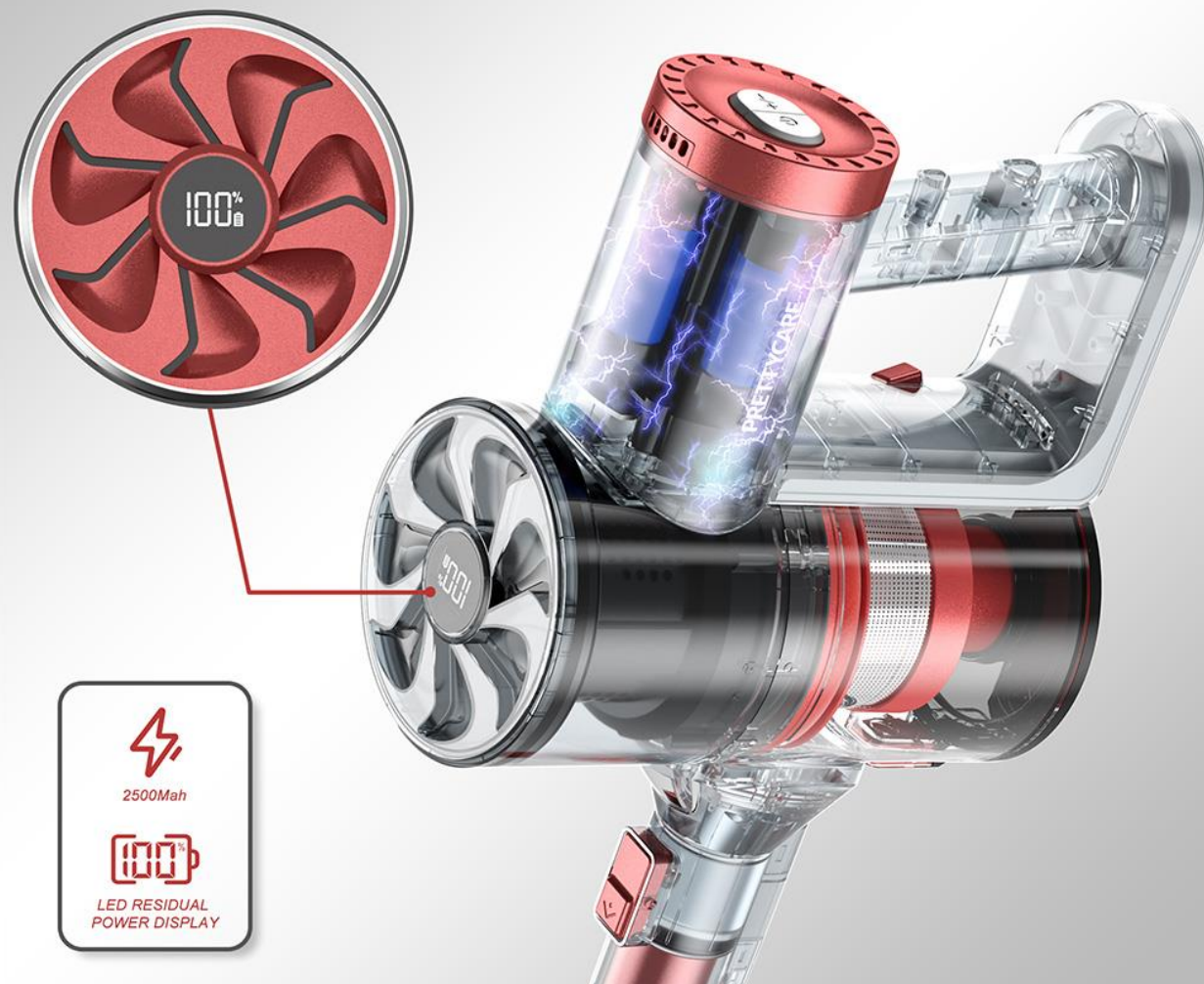



EASY STORAGE & UNIQUE EXTENSION



Different ground

Adapt to a variety of different ground



brushless motor



Wall Mount

*Safe semi-hung design,
Stable on the wall*



New Models are coming soon...

Thank you

Shenzhen LANJI Tech Co., Ltd

Add: 412, 4F, Block D, No.1067 Xuegang Rd, Xiangjiaotang, Bantian, Longgang Dist., Shenzhen, China
Tel: +86-755-28796865 Mob/ WhatsApp/ WeChat: +86 134 8025 5980 Email: sh@lanji-tech.com