

CONTENTS

Head-mounted digital night vision device

User Manual Model: LSJ-DM50

【Contents】

Product Introduction.....3
 Instructions for use.....5
 Component description.....6
 Operating Instructions.....8
 Install battery.....8
 Turn on.....9
 Shutdown.....9
 Scenery observation.....10
 Menu operation.....11
 Screen brightness adjustment.....12
 Infrared light adjustment.....13
 Digital zoom.....14
 Display color change.....15
 WiFi on and off.....16

CONTENTS

Date and time setting.....17
 Auto power off.....18
 Language setting.....19
 Restore default settings.....20
 Basic parameters.....21
 Configuration standard.....22
 Use environment requirements and matters needing attention.....23

PRODUCT DESCRIPTION

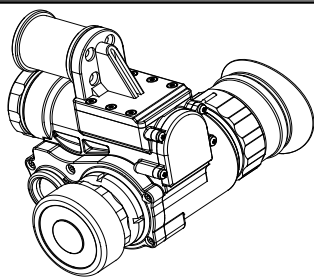

[Name] Head-mounted digital night vision device

【Model】 LSJ-DM50

[Performance characteristics]

- This device can be used day and night, the optical magnification is 1X, and the digital magnification is 3 X.
- To achieve a better night vision effect, the device is set to black and white mode.
- In the darkness, using LED lighting, you can observe a 200m target.
- Power supply: This device uses a 18650 large capacity rechargeable lithium battery.
- Working hours: It can be used for 3 hours when WiFi and infrared lights on, 5 hours when only WiFi is turned on.

PRODUCT DESCRIPTION

- This device comes with WiFi, which can with the APP installed on the mobile device, and realize the functions of recording and taking pictures in the APP.
- This device comes with a rack interface, which can be matched with different bucket racks through different interface conversions. Suitable for various helmets of different specifications.
- This device adopts 1080P ultra-low illumination detector.
- This device is the best auxiliary tool for human vision extension.

USAGE NOTICE

【Usage notice】

- Night vision device is a precision optoelectronic device used to observe targets at night. Can work in very low light environment.
- The night vision device is equipped with infrared lighting, suitable for use in pure dark environment.
- When the auxiliary lighting is turned on in a dark environment, the brightness of the auxiliary lighting source can be adjusted appropriately according to the distance of the observed object. The night vision device uses a low-illuminance detector. When the environment has a certain light source (such as street light, moonlight), it is not necessary to turn on the auxiliary light source, and only need to adjust the focal length of the objective lens to make the observation clear.

DIAGRAM

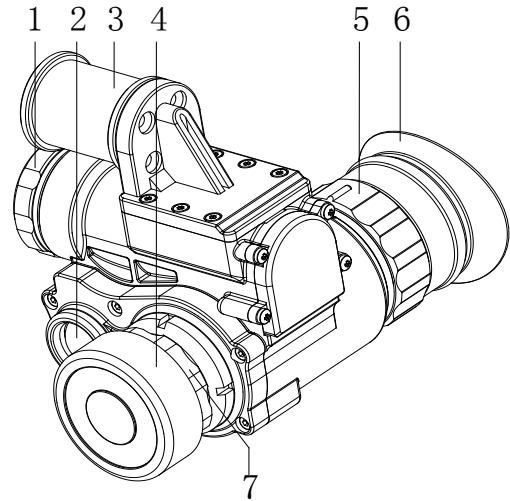

- 1-Battery cover
- 2-Infrared light
- 3-Hanger
- 4-Objective lens cover
- 5-Diopter wheel
- 6-Eyepieces
- 7-Focusing wheel

DIAGRAM

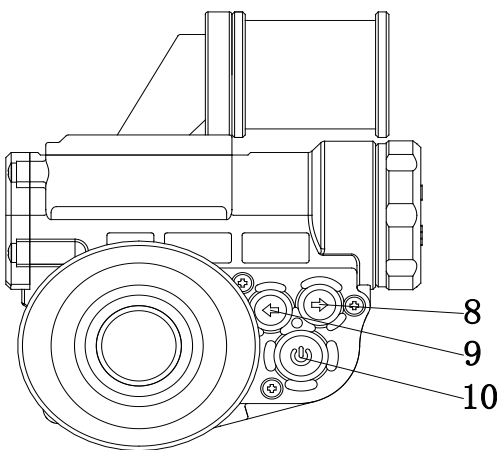

- 8-Down button
- 9-Up button
- 10-Switch button

OPERATING INSTRUCTIONS

【Install the battery】

Unscrew the battery cover 1, take a usable battery (18650 battery with sufficient power), insert the negative electrode of the battery into the battery compartment, screw the battery cover in place, press the power button 9 , the internal display screen lights up, indicating the battery installation Correct; if there is no display on the display, please confirm whether the battery cover is screwed in place and whether the battery has sufficient power, and then start the test until the device works normally.

【Precautions】

The battery specifications must meet the requirements.

The battery needs to have sufficient power.

When installing, pay attention to the positive and negative directions of the battery.

Failure to screw the battery cover in place will cause the device to work abnormally.

OPERATING INSTRUCTIONS

【Turn on】

- Remove the objective lens cover 4.
- Click the power button , View from 6 eyepieces, see the display inside the device .The screen lights up, Display as shown on the right

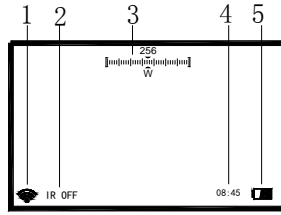

Icon description:

- 1 WiFi status
- 2 Infrared light status
- 3 Compass
- 4 System time
- 5 Battery level

【Shutdown】

- No matter what state the device is in, press and hold the power button  (3 seconds) to shut down the device.

OPERATING INSTRUCTIONS

【Scenery observation】





- Remove the protective cover of the objective lens, in the observation state, aim the objective lens at the scene to be observed, and watch the display screen from the eyecup 6.
- a) Adjust the diopter handwheel 5 to make the text icons on the screen clearest;
- b) Adjust the objective lens focusing handwheel 7 to make the observed scene the clearest.
- The device will automatically fine-tune the brightness of the display according to the average brightness of the scene in the center of the screen.
- Up button 8# , digital zoom can be realized, and the digital image magnification range is 1~3 times.
- When the ambient light is bright, it is recommended to turn off the infrared light to save battery power.
- When the ambient light is very dark and the scenery is unclear, you can turn on the infrared light to have a better observation experience.

【Precautions】

Do not block anything in front of the infrared light.

OPERATING INSTRUCTIONS





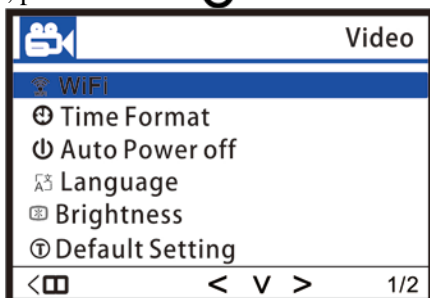



【 Menu operation】

- Most function settings are performed in the menu.
- Long press the up button  for 2~3 seconds, release the button, and the menu appears.
- On the interface where the menu appears, long press the up button  for 2~3 seconds, release the button, the menu will disappear
- In the menu operation, the up  and down button  are used to control the selection cursor bar to move between the menu items. When the selection cursor bar is located in a menu item, press the button  to confirm the selection.



OPERATING INSTRUCTIONS



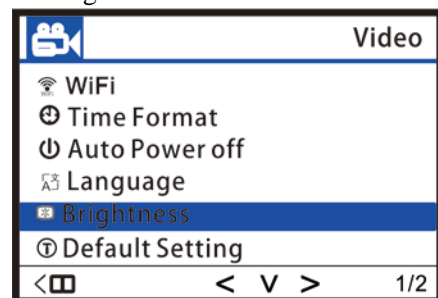

【Screen brightness adjustment】

- In the observation state, press the up button  and hold for 3 seconds to enter the menu interface. The up  and down  button can control the cursor to move up and down.
- Choose the "Brightness" menu item, press the Button  to confirm, in the pop-up submenu, move the cursor with the up  and down button , and use the button  to select the desired value. Long press the up button  to exit the menu.
- The screen brightness is between 1~9, the value 9 is the brightest.



OPERATING INSTRUCTIONS

【Infrared light adjustment】

- When observing the scene, if the light is very dark and the scene cannot be clearly observed, you can turn on the infrared light for auxiliary lighting.
- Press 9#  for a long time, the logo "IR OFF" at the lower left corner of the screen changes to "IR ON", indicating that the infrared light has been turned on. At this time, press the down button  once, the logo will change to "IR 1", and the number 1 means the current infrared. The brightness level of the light is level 1, keep pressing the button , the number will cycle between 0~3, level 3 is the brightest
- Long press the button  and the logo in the lower left corner changes to "IR OFF", it means that the infrared light has been turned off.
- **【Precautions】**

Do not block any objects in front of the infrared light. Infrared light consumes a lot of power, please keep it off when not in use.

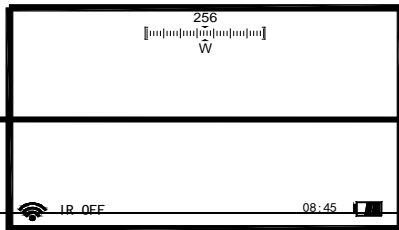

13

OPERATING INSTRUCTIONS

【Display color switching】

- When the device is turned on and the infrared light is off, the display color can be changed.
- Press the down button , the display color will switch between black and white and green.

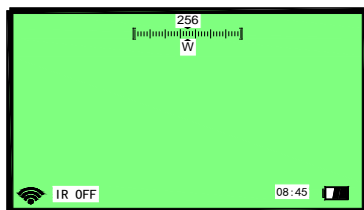
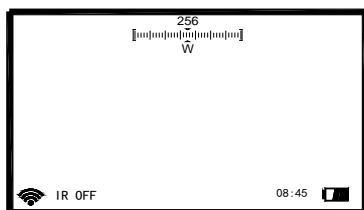

15

OPERATING INSTRUCTIONS

【Digital zoom】

- When the device is turned on, digital zoom operation can be performed.
- Press the up button  once, and the screen will zoom in to 2X. Each time you press it, the digital zoom will cycle between 1 and 3, and the maximum value is 3.
- The digital magnification is displayed in the lower left corner of the screen.

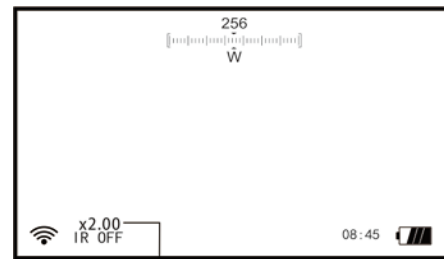



Digital Zoom

14

OPERATING INSTRUCTIONS

【WiFi on and off】



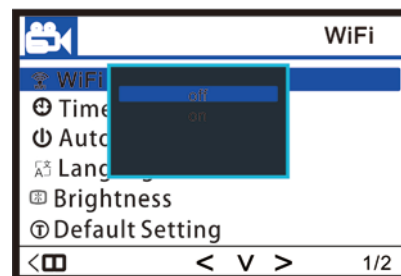



- The status of WiFi on and off is displayed in the status bar in the lower left corner, as shown in the figure below, the status with a red slash is the WiFi off state.
- In the menu, move the selection cursor bar to the "WiFi" menu item, press the button  to confirm the selection, and enter the WiFi setting sub-menu, as shown in the figure below, move the selection cursor bar to the desired menu item, and press the button  Confirm, the setting is complete.



16

OPERATING INSTRUCTIONS

【Date and time setting】

- Select "Date/Time" in the menu interface and press the button  to enter the date/time setting submenu
- button  Control the selection cursor bar to move among the setting items.
- Up  and down button  Change the parameter value of the cursor bar position.
- Press the button  to place the selection cursor at the last position, and press the button  again to exit the date/time setting submenu.

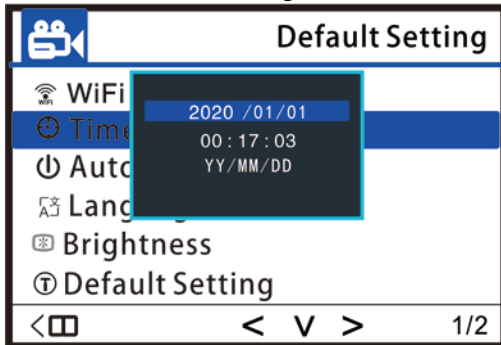

17

OPERATING INSTRUCTIONS

【Automatic shut-down】

- Select "Auto power off" in the menu interface, and press the button  to enter the submenu of automatic power off settings.
- The option "Off" means that the device will not shut down automatically.
- The options "3 minutes", "5 minutes" and "10 minutes" mean that the device will automatically shut down if there is no operation within the set time.

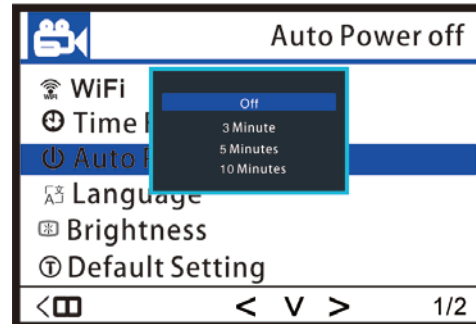

18

OPERATING INSTRUCTIONS

【language settings】

- Select "Language Setting" in the menu interface, and press the button  to enter the language setting submenu.
- The supported languages of this device are as follows:
- Simplified Chinese, Traditional Chinese, Italian, Japanese, Russian, English, French, Spanish, Portuguese, German.

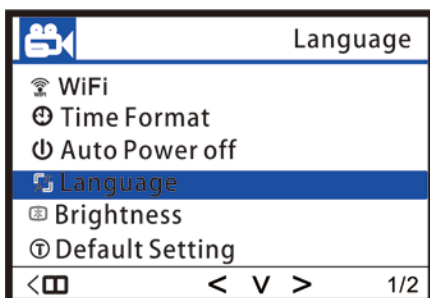

19

OPERATING INSTRUCTIONS

【Restore default settings】

- Select "Default Settings" in the menu interface and press the button  to enter the default setting submenu.
- If you select the "OK" option, the device will restore the default settings.

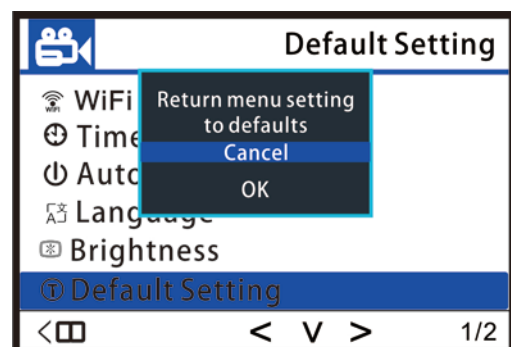

20

BASIC PARAMETERS

【Basic parameters】

Type	Item	Parameter value
Optical performance	Magnification	1X
	Objective lens aperture	17.5mm
	Field of view	25.5° × 14.5°
	Eyepiece adjustment range	+2- -5SD
	Low light observation distance	200m
	No light and black observation distance	100m

power supply	Operating Voltage	3.7V DC
	Replaceable battery	Rechargeable lithium battery 18650
	Charger	110-220V
Others	Dimensions (length × width × height)	110×80×57mm
	Weight	245g

THE STANDARD CONFIGURATION

【The standard configuration】

Name	Amount
Portable soft case	1
External power adapter	1
Separate battery charger	
user's manual	1
Hand strap	1
Battery	1
Lens cloth	1
Color box	1

PRECAUTIONS

【Use environment requirements and precautions】

- The night vision device should be stored in a soft bag, and the operating environment should be between -40°C and $+55^{\circ}\text{C}$, and the relative humidity should not exceed 80%.
- The night vision device should be stored in a clean and dry place to avoid moisture, mold, heavy pressure, mechanical damage, humidity and solar radiation.
- Try to avoid rain or fog to prevent falling, bumping, and bumping.
- When the image on the display screen is bounced, the green grid lines or the screen does not light up, it indicates that the voltage is too low and it needs to be charged in time.
- If you need to clean the optical surface of the objective lens, eyepiece, and laser illuminator, blow off small grit and dust, and then wipe the surface with a soft cloth.
- If the night vision device is not used for a long time, please keep the battery charged frequently to prevent the rechargeable battery from failing.