

Input voltage	Output voltage	Output current	Output power	Efficiency	Size
30-60V DC	13.8V DC	10 Amps	138 Watts	93.7%	64*57*22mm

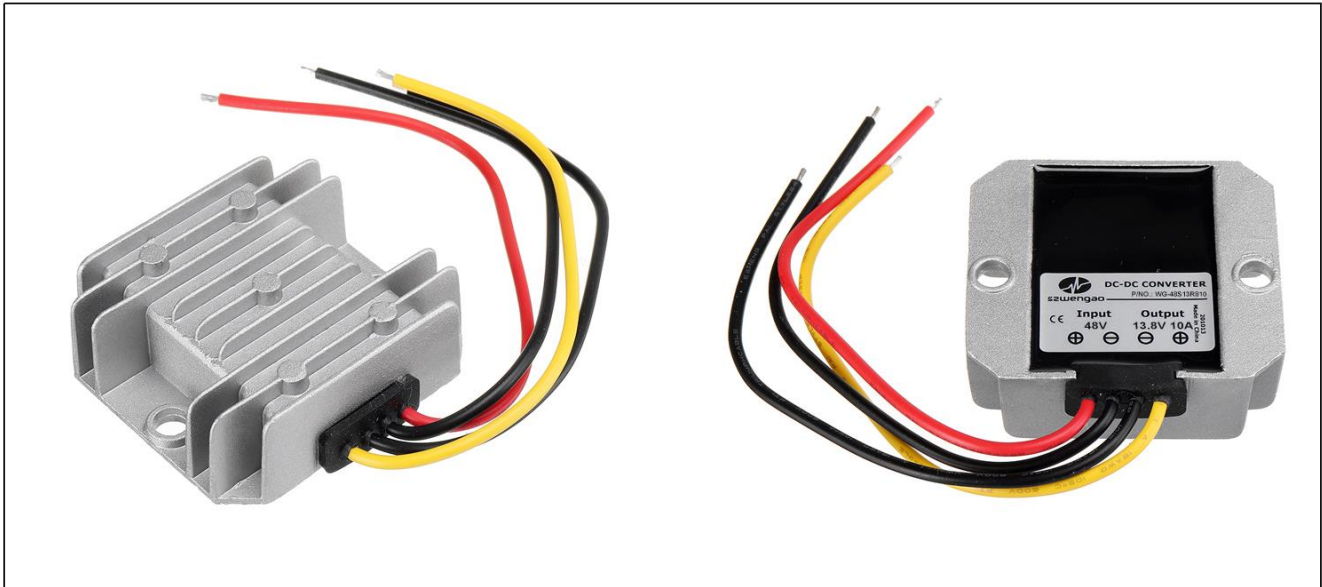

The WG-48S13R810 is a Non-isolated DC-DC converter that uses a synchronous rectification technology, and features high efficiency and power density. It has the dimensions of 64mm x 57mm x 22mm (2.52 in. x 2.24 in. x 0.87 in) and provides the rated output voltage of 13.8V and the maximum output current of 10A.

Features

- Design meeting RoHS / CE
- High efficiency: 93.7% (@ 48Vin, 25°C)
- Non-isolated between input and output
- Small size, high reliability
- Support -40 °C environment
- 100% full load burn-in test
- Short circuit, Over load, Low-voltage protections
- Waterproof level IP68
- 1 Year warranty

Applications

- Industrial
- Alternative Energy
- Golf Cart
- Cars & Forklift
- Electromotor
- Telecommunications
- Boat & Yacht
- Medical
- LED Marketplaces and so on.

Model naming method

WG-48S13R810

WG: "szwengao" company name

48: Input rated voltage

S: Single output type

13R8: Output voltage(13.8V)

10: Output current

**Electrical Specifications**

Conditions: TA = 25 °C (77°F), Airflow = 1 m/s (200LFM), Vin =48V, Vout =13.8V, unless otherwise specified.

Parameter	Min.	Typ.	Max.	Units	Remarks
Absolute maximum ratings					
Operating ambient temperature	-40	-	+55	°C	
Shell ambient temperature	-40	-	80	°C	
Storage temperature	-55	-	100	°C	
Operating humidity	5	-	95	%	Non-condensing
Atmospheric pressure	62	-	106	Kpa	
Altitude	-	-	4000	m	
Cooling way	-	-	-		Natural cooling
Input characteristics					
Input voltage	30	48	60	V	-
Max. input voltage	-	-	60	V	Continuous
Undervoltage shutdown	25.0	25.2	25.7	V	Automatic recovery
Undervoltage recovery	28.0	28.3	28.6	V	Automatic recovery
Max. input current	-	-	5.5	A	Vin =30V; Iout =10A
No load current	-	24	50	mA	Vin =48V
Positive electrode cable	18	-	-	AWG	If the wire length is greater than 50cm, it is recommended to use a thicker wire diameter.
Negative electrode cable	18	-	-	AWG	
Enable PIN cable	-	NA	-	AWG	If the unit with this function
Fuse	-	20	-	A	Input positive has built-in fuse
Output characteristics					
Efficiency	-	93.7	-	%	Vin =48V; Iout =10A
Output voltage	13.5	13.8	13.9	V	Vin =48V; Iout =10A
Regulator accuracy	-	±2	-	%	
Voltage regulation	-	±1	-	%	
Load Regulation	-	±2	-	%	
Overvoltage protection	-	14.5	16	V	TVS clamp protection
Output current	0	-	10	A	
Overcurrent protection	15	18	19	A	Vin=30-60V
External capacitance	-	NA	-	µF	Don't need
Output ripple and noise	-	60	150	mVp-p	Vin =30-60V; Iout=10A Oscilloscope bandwidth: 20 MHz;
Output voltage rise time	-	74	100	mS	
Boot delay time	-	110	150	mS	
Out voltage overshoot	-	2	3	%	Vin =48V
Over temperature protection	-	NA	-	°C	
Short circuit protection	-	YES	-		Long-term (4 hours) short circuit is not damaged, Hiccup mode
Positive electrode cable	16	-	-	AWG	If the wire length is greater than 50cm, it is recommended to use a thicker wire diameter.
Negative electrode cable	16	-	-	AWG	



Safety and EMC features				
Anti-electric Strength	Input to Output	-	V	Leakage current ≤ 3.5mA, 1min, no breakdown, no arcing
	Input to Shell	≥500	V	
	Output to Shell	≥500	V	
Insulation resistance	Input to Output	≥10	MΩ	Test voltage = 500V
	Input to Shell			
	Output to Shell			
Other characteristics				
Weight	≤ 120		g	
Package	white box			
MTBF	≥200,000		H	Vin= 48V; Iout= 10A
Switching frequency	150±10		KHz	

Characteristic Curves

Conditions: TA = 25°C (77°F), Vin = 48V, Vout = 13.8V, unless otherwise specified.

Figure 1, Efficiency

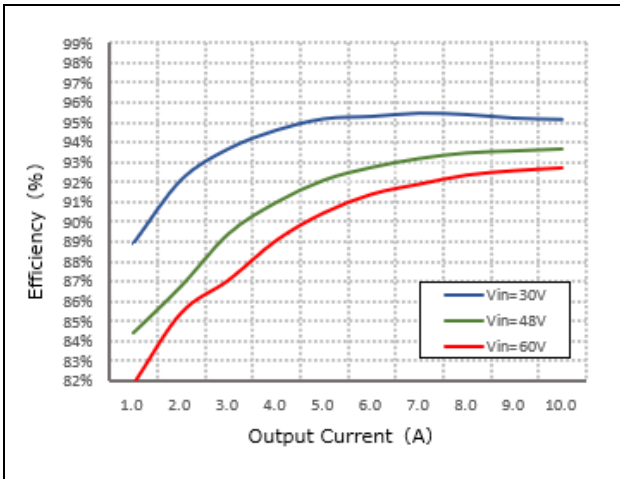

Figure 2, Power dissipation

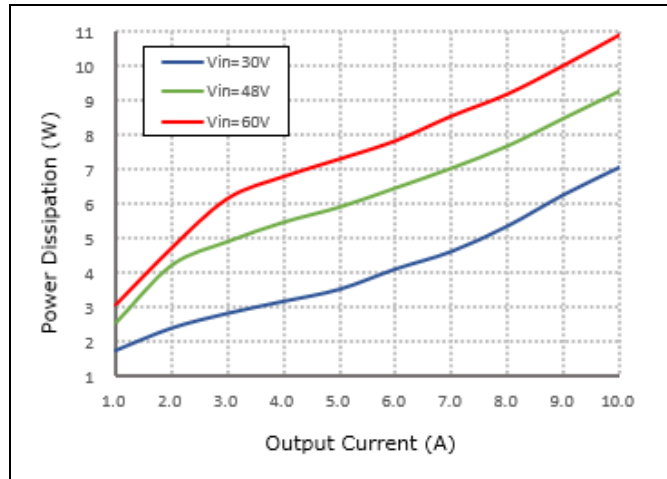
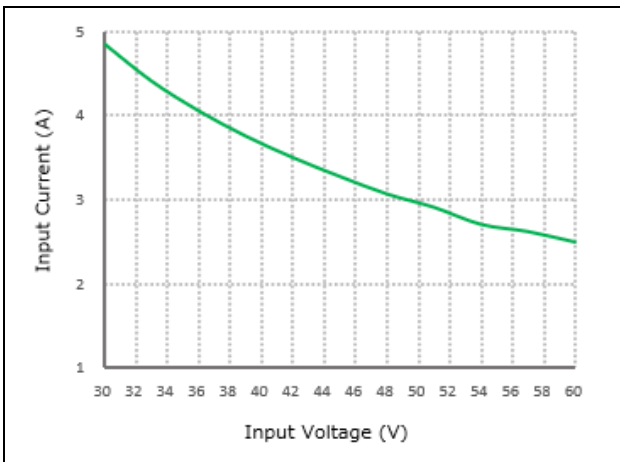

Figure 3, Input V-I, Iout=10A



Typical Waveforms

Conditions: TA = 25° C (77° F), Vin = 48V, unless otherwise specified.

Figure 4, 25% - 50% load dynamic

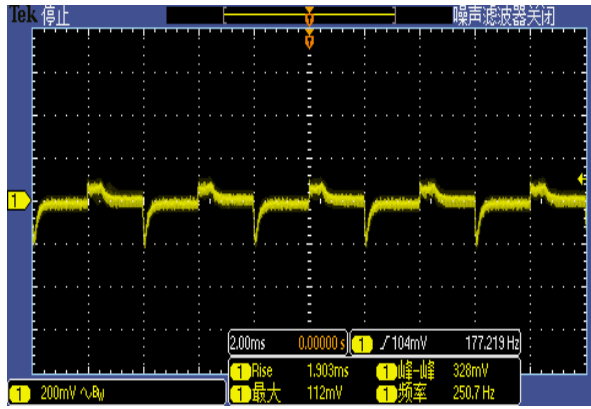

Figure 5, 50% - 75% load dynamic

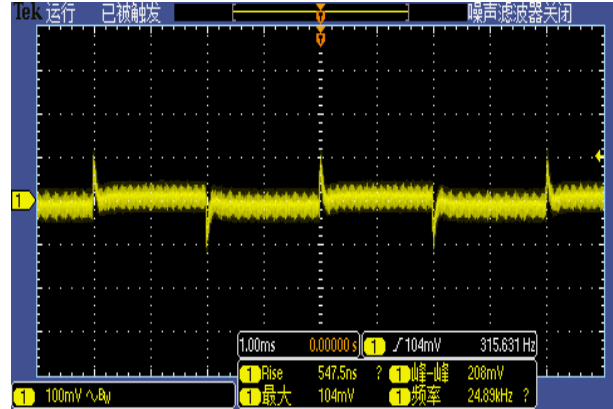

Figure 6, Output voltage established (Iout = 10A)

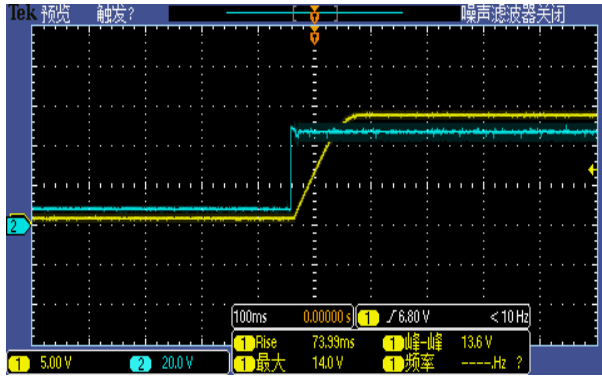
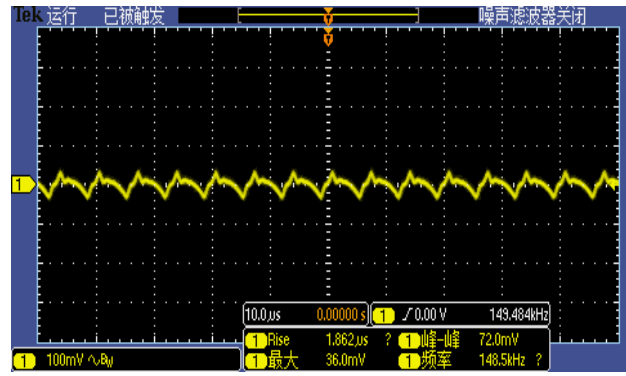

Figure 7, Output ripple & noise (Iout = 10A)





Feature Description

Remote On/Off (EN) (Optional)

Logic Enable	Low level (0 - 30Vdc)	High level (30-60Vdc)	Left open
Positive logic	Off	On	Off

Input Undervoltage Protection

The converter will shut down after the input voltage drops below the under-voltage protection threshold for shutdown. The converter will start to work again after the input voltage reaches the input under voltage protection threshold for startup. For the Hysteresis, see the Protection characteristics.

Various circuits for driving the EN

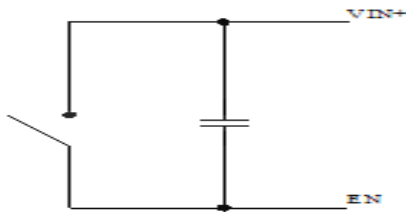

Simple control

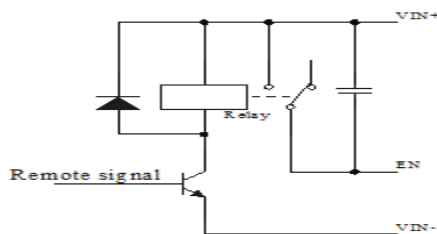

Transistor control

Output Overcurrent Protection

The converter equipped with current limiting circuitry can provide protection from an output overload or short circuit condition. If the output current exceeds the output overcurrent protection set point, the converter enters hiccup mode. When the fault condition is removed, the converter will automatically restart.

Wiring Instructions

The input and output of this product is terminals. The user should ensure that the input and output wires and terminals are connected reliably, and pay attention to the wire diameter to meet the requirements of the power supply current. If the cable to be used is long, it needs Considering the voltage drop of the wire, if the voltage drop is too large, the voltage output at the load end may not meet the load demand. In this case, consider using a thicker wire diameter or reducing the length of the wire. Generally, if long wiring is required. Long line should be used on the side where the current is relatively small. For example, this product is a step-down product, so long lines should be used on the input side.



Thermal Consideration

Sufficient airflow should be provided to help ensure reliable operating of the WG-48S13R810.

Therefore, thermal components are mounted on the top surface of the WG-48S13R810 to dissipate heat to the surrounding environment by conduction, convection, and radiation. Proper airflow can be verified by measuring the temperature at the middle of the base plate.

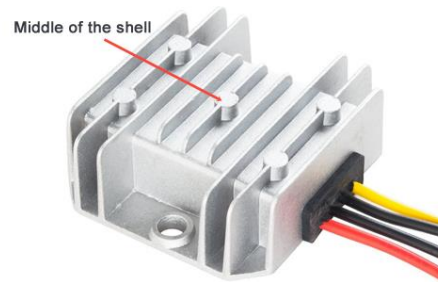

Dimension

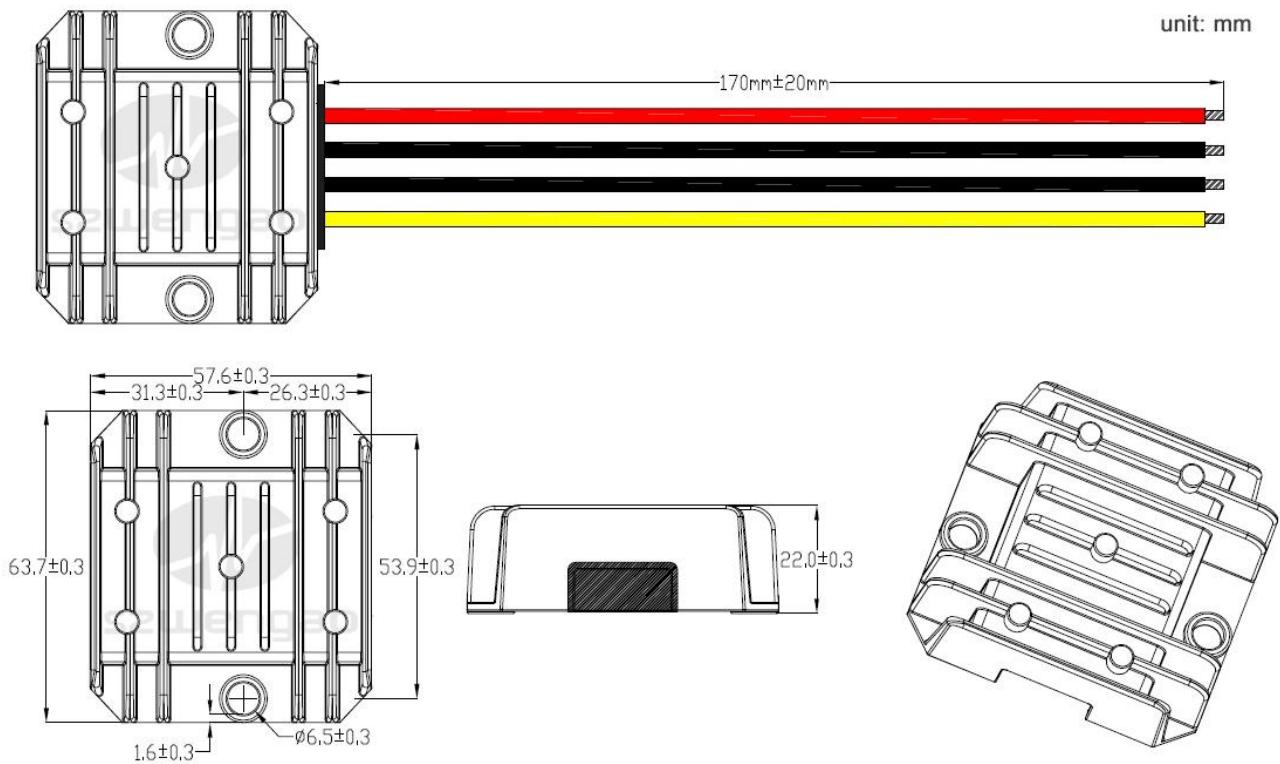

Shenzhen Wengao Electronic Co., Ltd

A: 2/F A, Bldg.A2, Anle Ind. Hangcheng RD., Xixiang Street, Baoan Dist., Shenzhen, China 518102

T: +86 755 29418061

F: +86 755 29418061

E: info@wengaoelec.com

W: www.wengaoelec.com