

Input voltage	Output voltage	Output current	Output power	Efficiency	Size
10-20V DC	28V DC	50 Amps	1400 Watts	96.4%	140*120*42.5mm



The WG-12S2850M is a Non-isolated DC-DC converter that uses a synchronous rectification technology, and features high efficiency and power density. It has the dimensions of 140mm x 120mm x 42.5mm (5.51 in. x 4.72 in. x 1.67 in) and provides the rated output voltage of 28V and the maximum output current of 50A.

Features

- Design meeting RoHS / CE
- High efficiency: 96.4% (@ 12Vin, 25°C)
- Non-isolated between input and output
- 100% full stable current output
- Support -30 °C environment
- 100% full load burn-in test
- OT, OL, LV protections
- Waterproof level IP67
- 2 Years warranty

Applications

- Industrial
- Alternative Energy
- Golf Cart
- Forklift & Cars
- Electromotor
- Telecommunications
- Boat & Yacht
- Medical
- LED Marketplaces and so on.

Model naming method

WG-12S2850M

- WG** : "szwengao" company name
12 : Input rated voltage
S : Single output type
28 : Output voltage
50 : Output current
M : Type of shell

**Electrical Specifications**

Conditions: TA = 25 °C (77°F), Airflow = 1 m/s (200LFM), Vin =12V, Vout =28V, unless otherwise specified.

Parameter	Min.	Typ.	Max.	Units	Remarks
Absolute maximum ratings					
Operating ambient temperature	-30	-	+55	°C	
Shell ambient temperature	-30	-	80	°C	
Storage temperature	-55	-	100	°C	
Operating humidity	5	-	95	%	Non-condensing
Atmospheric pressure	62	-	106	Kpa	
Altitude	-	-	4000	m	
Cooling way	-	-	-		Natural cooling
Input characteristics					
Input voltage	10	12	20	V	-
Max. input voltage	-	-	23	V	Continuous
Undervoltage shutdown	9	9.6	10	V	Automatic recovery
Undervoltage recovery	10	10.3	11	V	Automatic recovery
Max. input current	-	-	150	A	Vin =10V; Iout =50A
No load current	-	58	200	mA	Vin =12V
Positive electrode cable	4	-	-	AWG	If the wire length is greater than 50cm, it is recommended to use a thicker wire diameter.
Negative electrode cable	4	-	-	AWG	
Enable PIN cable	-	NA	-	AWG	If the product has this feature
Fuse	120	-	-	A	Input positive has built-in fuse
Output characteristics					
Efficiency	-	96.4	-	%	Vin =12V; Iout =50A
Output voltage	27.6	28	28.6	V	Vin =12V; Iout =50A
Regulator accuracy	-	±3	-	%	
Voltage regulation	-	±2	-	%	
Load Regulation	-	±2	-	%	
Overvoltage protection	-	NA	-	V	
Output current	0	-	50	A	Vin =10-20V
Overcurrent protection	55	57	60	A	Vin=12V
External capacitance	-	NA	-	μF	Don't need
Output ripple and noise	-	150	800	mVp-p	Vin =10-20V; Iout=50A, Oscilloscope bandwidth: 20 MHz
Output voltage rise time	-	200	300	mS	
Boot delay time	-	208	300	mS	
Out voltage overshoot	-	-	5	%	Vin =12V, 50%-75% Load step
Over temperature protection	-	-	108	°C	Shell temperature
Short circuit protection	-	NO	-		Boost converter can't short circuit for output
Positive electrode cable	8	-	-	AWG	If the wire length is greater than 50cm, it is recommended to use a thicker wire diameter.
Negative electrode cable	8	-	-	AWG	



Safety and EMC features				
Anti-electric Strength	Input to Output	-	V	Leakage current $\leq 3.5\text{mA}$, 1min, no breakdown, no arcing
	Input to Shell	≥ 500	V	
	Output to Shell	≥ 500	V	
Insulation resistance	Input to Output	≥ 10	M Ω	Test voltage = 500V
	Input to Shell			
	Output to Shell			
Other characteristics				
Weight	≤ 1.2		kg	
Package	White box			
MTBF	$\geq 200,000$		H	Vin= 12V; Iout= 50A
Switching frequency	80 \pm 10		KHz	

Characteristic Curves

Conditions: TA = 25°C (77°F), Vin = 12V, Vout = 28V, unless otherwise specified.

Figure 1, Efficiency

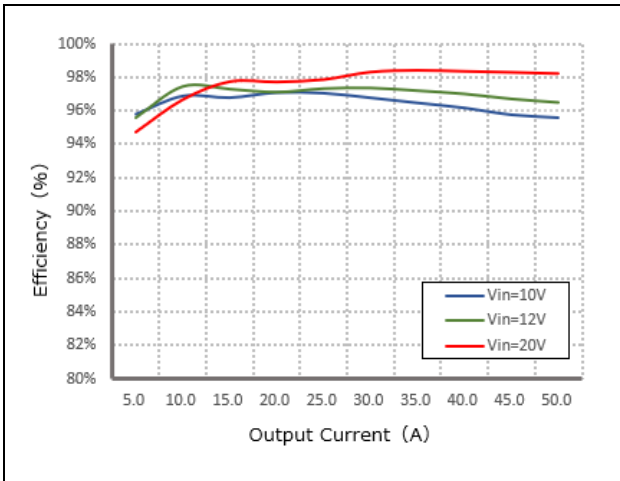

Figure 2, Power dissipation

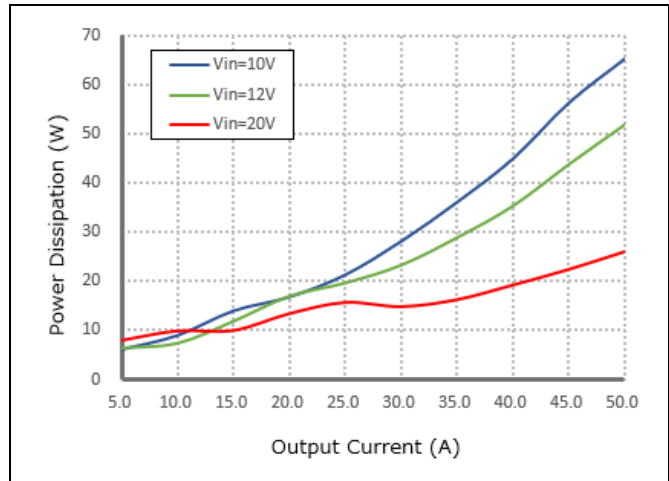
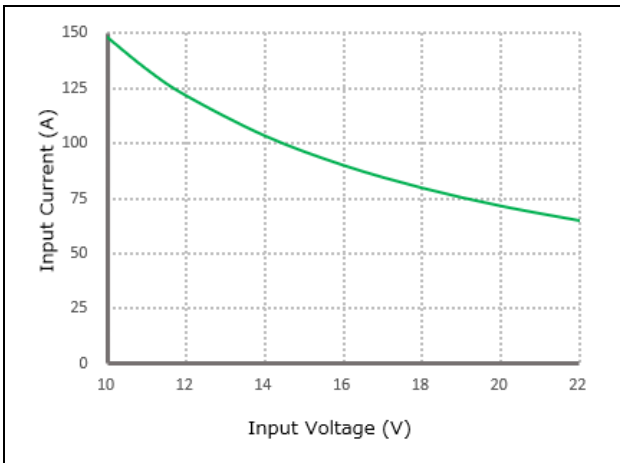

Figure 3, Input V-I, Iout=50A



Typical Waveforms

Conditions: TA = 25° C (77° F), Vin = 12V, unless otherwise specified.

Figure 4, 25% - 50% load dynamic



Figure 5, 50% - 75% load dynamic



Figure 6, Output voltage established (Iout = 50A)



Figure 7, Output ripple & noise (Iout = 50A)

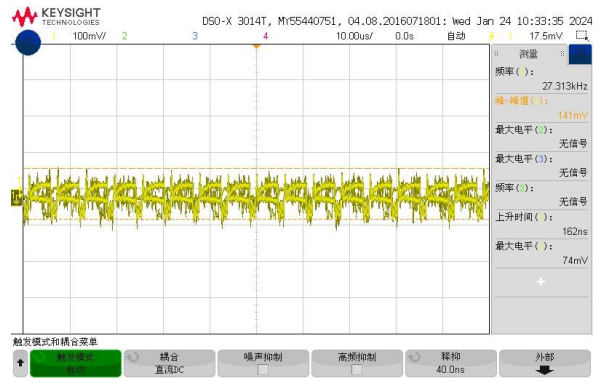



Feature Description

Remote On/Off (EN) (Optional)

Logic Enable	Low level (0 - 10Vdc)	High level (10-20Vdc)	Left open
Positive logic	Off	On	Off

Various circuits for driving the EN

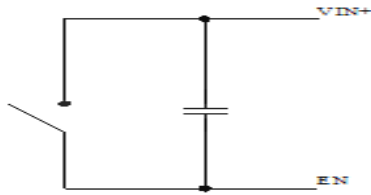

Simple control

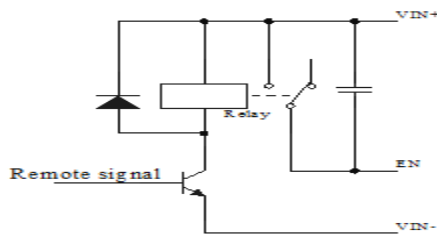

Transistor control

Input Undervoltage Protection

The converter will shut down after the input voltage drops below the under-voltage protection threshold for shutdown. The converter will start to work again after the input voltage reaches the input under voltage protection threshold for startup. For the Hysteresis, see the Protection characteristics.

Output Overcurrent Protection

The converter equipped with current limiting circuitry can provide protection from an output overload or short circuit condition. If the output current exceeds the output overcurrent protection set point, the converter enters hiccup mode. When the fault condition is removed, the converter will automatically restart.

Overtemperature Protection

A temperature sensor on the converter senses the average temperature of the module. It protects the converter from being damaged at high temperatures. When the temperature exceeds the over temperature protection threshold, the output will shut down. It will allow the converter to turn on again when the temperature of the sensed location falls by the value of Over temperature Protection Hysteresis

Wiring Instructions

The input and output of this product is terminals. The user should ensure that the input and output wires and terminals are connected reliably, and pay attention to the wire diameter to meet the requirements of the power supply current. If the cable to be used is long, it needs Considering the voltage drop of the wire, if the voltage drop is too large, the voltage output at the load end may not meet the load demand. In this case, consider using a thicker wire diameter or reducing the length of the wire. Generally, if long wiring is required. Long line should be used on the side where the current is relatively small. For example, this product is a step-down product, so long lines should be used on the input side.

Thermal Consideration

Sufficient airflow should be provided to help ensure reliable operating of the WG-12S2850M

Therefore, thermal components are mounted on the top surface of the WG-12S2850M to dissipate heat to the surrounding environment by conduction, convection, and radiation. Proper airflow can be verified by measuring the temperature at the middle of the base plate.



Dimension (unit: mm)

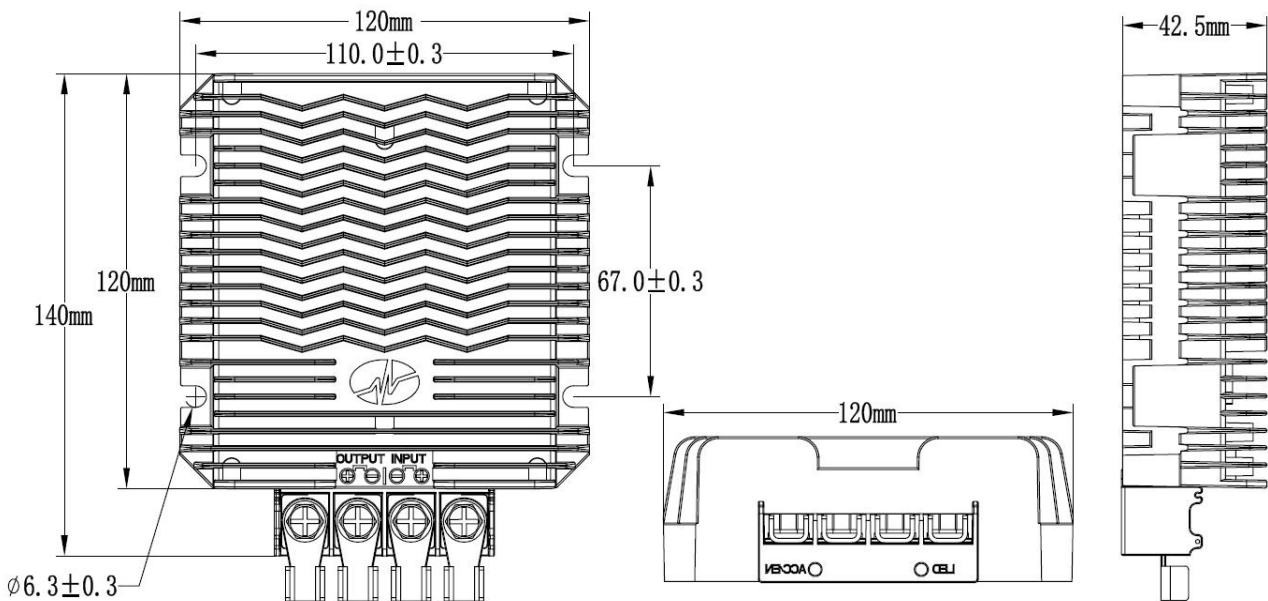

Shenzhen Wengao Electronic Co., Ltd

A: 2/F A, Bldg.A2, Anle Ind. Hangcheng RD., Xixiang Street, Baoan Dist., Shenzhen, China 518102

T: +86 755 29418061

F: +86 755 29418061

E: info@wengaoelec.com

W: www.wengaoelec.com