



szwengao

Non-Isolated DC/DC Converter Specification

Model No.: WG-12S3601

Input voltage	Output voltage	Output current	Output power	Efficiency	Size
10-30V DC	36V DC	1 Amps	36 Watts	96.8%	64*57*22mm

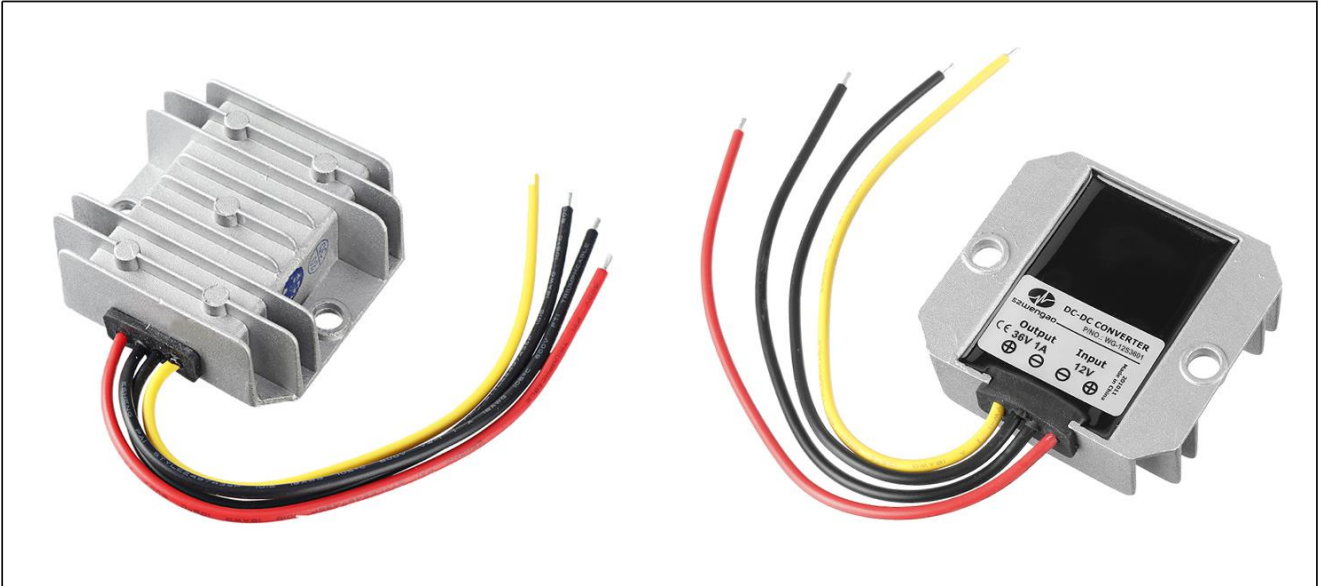

The WG-12S3601 is a Non-isolated DC/DC boost converter that uses a synchronous rectification technology, and features high efficiency and power density. It has the dimensions of 64mm x 57mm x 22mm (2.52 in. x 2.24 in. x 0.86 in) and provides the rated output voltage of 36V and the maximum output current of 1A.

Features

- Design meeting RoHS / CE
- High efficiency: 96.8% (@ 12Vin, 25°C)
- Mount in almost any location, high reliability
- Non-isolated between input and output
- Support -40 °C environment
- 100% full load burn-in test
- Over load, Low voltage protections
- Die-cast aluminum shell, epoxy potting
- Waterproof level IP68
- 1 Year warranty

Applications

- Industrial
- Alternative Energy
- Golf Cart
- Forklift
- Electromotor
- Telecommunications
- Boat & Yacht
- Medical
- LED Marketplaces and so on.

Model naming method

WG-12S3601

WG: "szwengao" company name

12: Input voltage

S: Single output type

36: Output voltage

01: Output current

**Electrical Specifications**

Conditions: TA = 25 °C (77°F), Airflow = 1 m/s (200LFM), Vin =12V, Vout =36V, unless otherwise specified.

Parameter	Min.	Typ.	Max.	Units	Remarks
Absolute maximum ratings					
Operating ambient temperature	-40	-	+55	°C	
Shell ambient temperature	-40	-	80	°C	
Storage temperature	-55	-	100	°C	
Operating humidity	5	-	95	%	Non-condensing
Atmospheric pressure	62	-	106	Kpa	
Altitude	-	-	4000	m	
Cooling way	-	-	-		Natural cooling
Input characteristics					
Input voltage	10	12	30	V	-
Max. input voltage	-	-	32	V	Continuous
Undervoltage shutdown	8.0	8.2	8.5	V	Automatic recovery
Undervoltage recovery	9.2	9.5	10.0	V	Automatic recovery
Max. input current	-	-	4.6	A	Vin =8.5V; Iout =1A
No load current	-	25	40	mA	Vin =12V
Positive electrode cable	20	-	-	AWG	If the wire length is greater than 50cm, it is recommended to use a thicker wire diameter.
Negative electrode cable	20	-	-	AWG	
Enable PIN cable	-	NA	-	AWG	If the product has this feature
Fuse	-	20	-	A	Input positive has built-in fuse
Output characteristics					
Efficiency	-	96.8	-	%	Vin =12V; Iout =1A
Output voltage	36.8	36.0	36.5	V	Vin =12V; Iout =1A
Regulator accuracy	-	±3	-	%	
Voltage regulation	-	±2	-	%	
Load Regulation	-	±2	-	%	
Overvoltage protection	-	NA	-	V	
Output current	0	-	1	A	
Overcurrent protection	3.8	4.5	4.6	A	Vin=12V
External capacitance	-	NA	-	µF	Don't need
Output ripple and noise	-	192	300	mVp-p	Vin =10-30V; Iout=1A, Oscilloscope bandwidth: 20 MHz
Output voltage rise time	-	12	20	mS	
Boot delay time	-	14	30	mS	
Out voltage overshoot	-	-	3	%	Vin =12V, 50%-75% Load step
Over temperature protection	-	NA	-	°C	Shell test
Short circuit protection	-	NA	-		Output can't shorted for boost converters
Positive electrode cable	20	-	-	AWG	If the wire length is greater than 50cm, it is recommended to use a thicker wire diameter.
Negative electrode cable	20	-	-	AWG	



Safety and EMC features				
Anti-electric Strength	Input to Output	-	V	Leakage current $\leq 3.5\text{mA}$, 1min, no breakdown, no arcing
	Input to Shell	≥ 500	V	
	Output to Shell	≥ 500	V	
Insulation resistance	Input to Output	≥ 10	$\text{M}\Omega$	Test voltage = 500V
	Input to Shell			
	Output to Shell			
Other characteristics				
Weight	≤ 120		g	
Package	White box			
MTBF	$\geq 200,000$		H	$V_{in} = 12\text{V}; I_{out} = 1\text{A}$
Switching frequency	130 ± 10		KHz	

Characteristic Curves

Conditions: $T_A = 25^\circ\text{C}$ (77°F), $V_{in} = 12\text{V}$, $V_{out} = 36\text{V}$, unless otherwise specified.

Figure 1, Efficiency

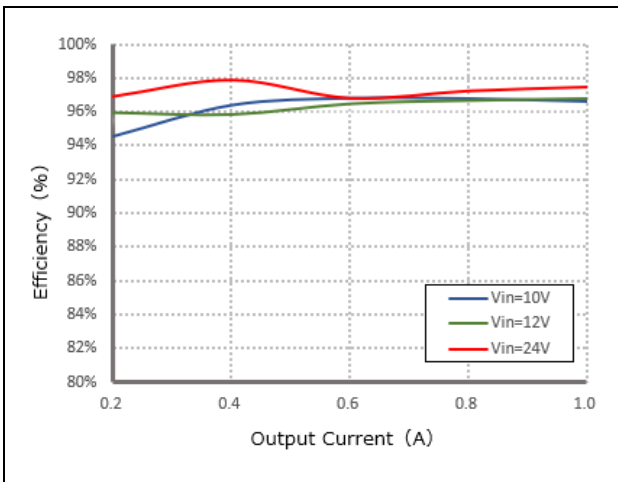

Figure 2, Power dissipation

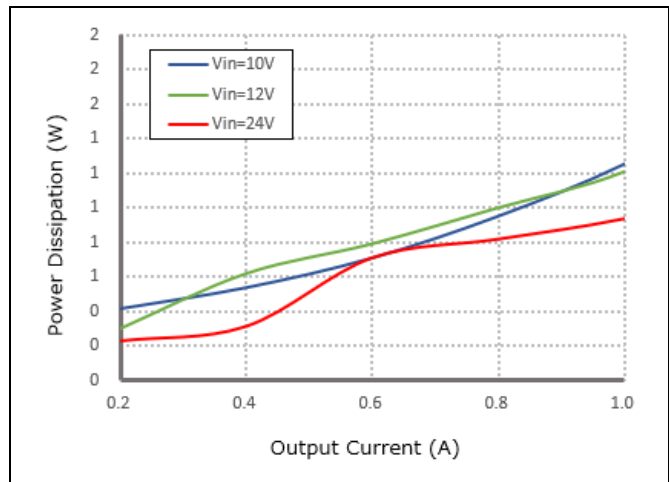
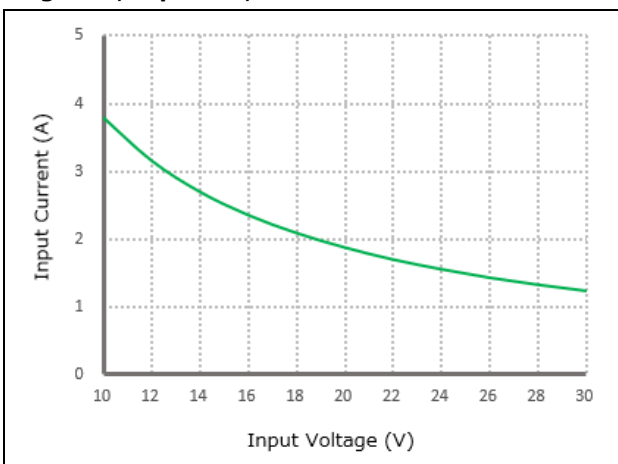

Figure 3, Input V-I, Iout=1A



Typical Waveforms

Conditions: TA = 25° C (77° F), Vin = 12V, unless otherwise specified.

Figure 4, 25% - 50% load dynamic

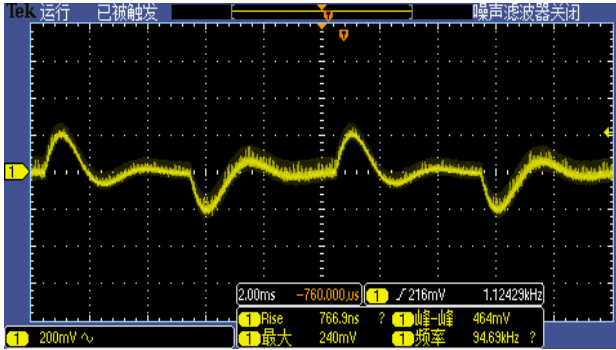

Figure 5, 50% - 75% load dynamic

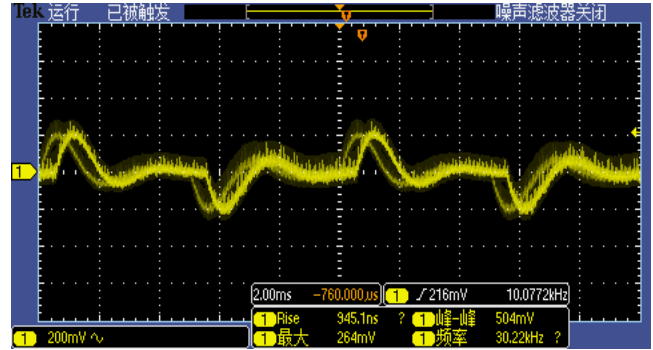

Figure 6, Output voltage established (Iout = 1A)

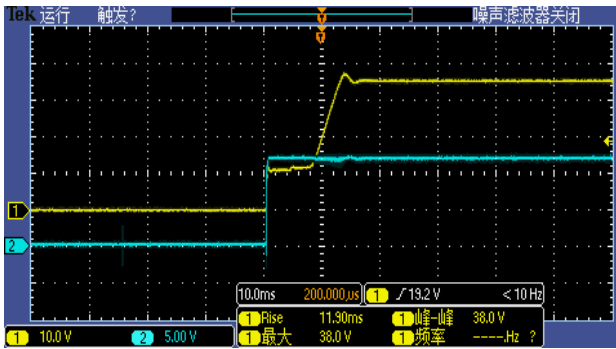
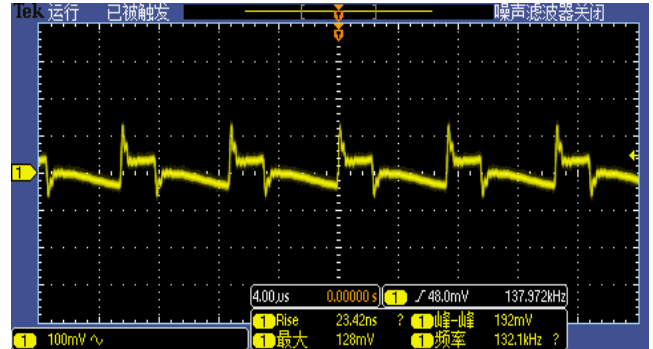

Figure 7, Output ripple & noise (Iout = 1A)





Feature Description

Remote On/Off (EN) (Optional)

Logic Enable	Low level (0 - 10Vdc)	High level (10-30Vdc)	Left open
Positive logic	Off	On	Off

Various circuits for driving the EN

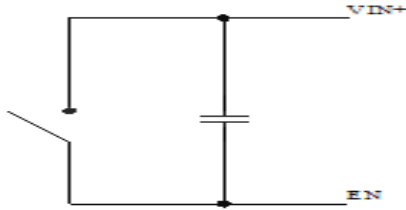

Simple control

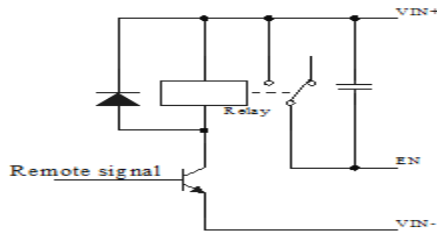

Transistor control

Wiring Instructions

The input and output of this product is terminals. The user should ensure that the input and output wires and terminals are connected reliably, and pay attention to the wire diameter to meet the requirements of the power supply current. If the cable to be used is long, it needs Considering the voltage drop of the wire, if the voltage drop is too large, the voltage output at the load end may not meet the load demand. In this case, consider using a thicker wire diameter or reducing the length of the wire. Generally, if long wiring is required. Long line should be used on the side where the current is relatively small. For example, this product is a step-down product, so long lines should be used on the input side.

Input Undervoltage Protection

The converter will shut down after the input voltage drops below the under-voltage protection threshold for shutdown. The converter will start to work again after the input voltage reaches the input under voltage protection threshold for startup. For the Hysteresis, see the Protection characteristics.

Output Overcurrent Protection

The converter equipped with current limiting circuitry can provide protection from an output overload or short circuit condition. If the output current exceeds the output overcurrent protection set point, the converter enters hiccup mode. When the fault condition is removed, the converter will automatically restart.



Thermal Consideration

Sufficient airflow should be provided to help ensure reliable operating of the WG-12S3601

Therefore, thermal components are mounted on the top surface of the WG-12S3601 to dissipate heat to the surrounding environment by conduction, convection, and radiation. Proper airflow can be verified by measuring the temperature at the middle of the base plate.

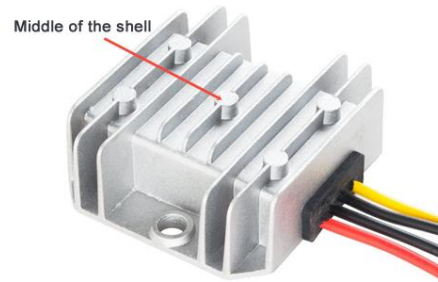

Dimension

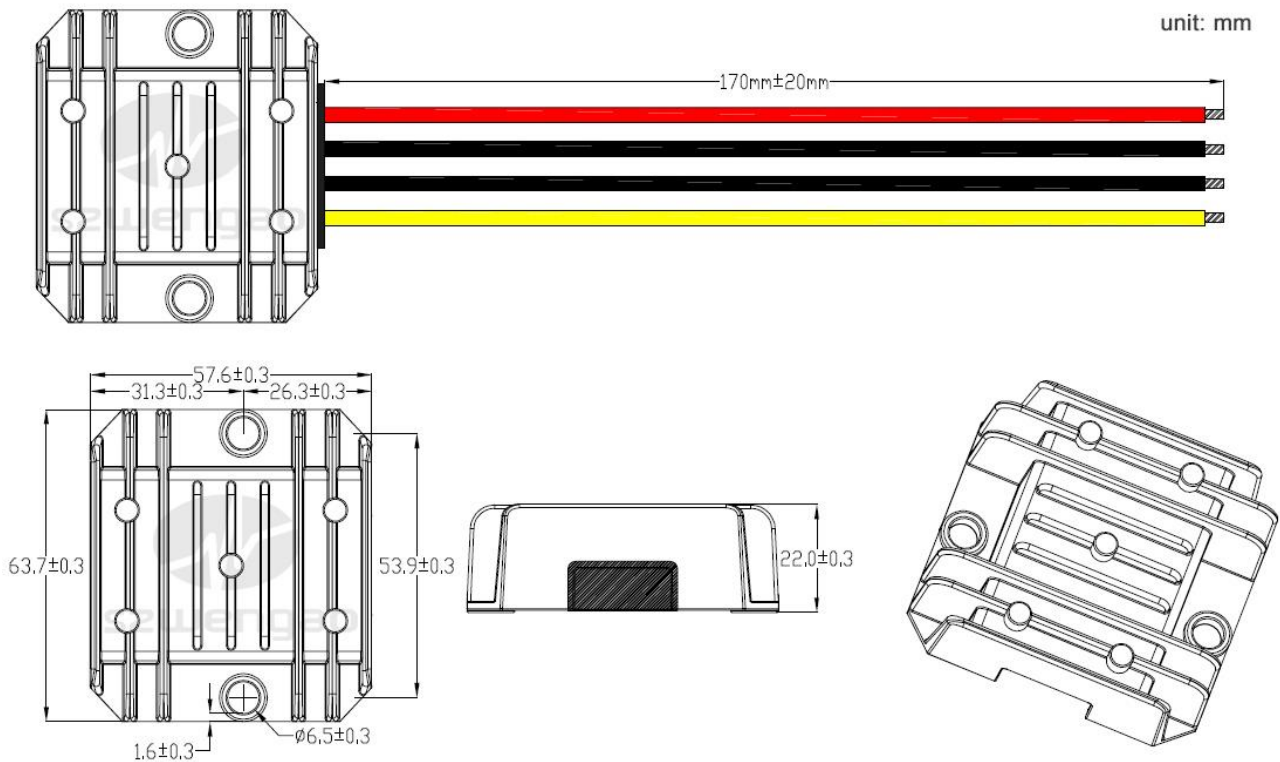

Shenzhen Wengao Electronic Co., Ltd

A: 2/F A, Bldg.A2, Anle Ind. Hangcheng RD., Xixiang Street, Baoan Dist., Shenzhen, China 518102

T: +86 755 29418061

F: +86 755 29418061

E: info@wengaoelec.com

W: www.wengaoelec.com